

นำ양ธรรมเนียมชาติดัดแปรโดยกราฟต์โคพอลิเมอไรเซชันด้วยสไตรีนและไฮโดรจีเนชันแบบไดอิมิด

นายอนวัช พิสุทธิทรัพย์

วิทยานิพนธ์นี้เป็นส่วนหนึ่งของการศึกษาตามหลักสูตรปริญญาวิทยาศาสตรมหาบัณฑิต

สาขาวิชาปิโตรเคมีและวิทยาศาสตร์พอลิเมอร์

คณะวิทยาศาสตร์ จุฬาลงกรณ์มหาวิทยาลัย

ปีการศึกษา 2554

ลิขสิทธิ์ของจุฬาลงกรณ์มหาวิทยาลัย

บทคัดย่อและแฟ้มข้อมูลฉบับเต็มของวิทยานิพนธ์ตั้งแต่ปีการศึกษา 2554 ที่ให้บริการในคลังปัญญาจุฬาฯ (CUIR)

เป็นแฟ้มข้อมูลของนิสิตเจ้าของวิทยานิพนธ์ที่ส่งผ่านทางบัณฑิตวิทยาลัย

The abstract and full text of theses from the academic year 2011 in Chulalongkorn University Intellectual Repository (CUIR)

are the thesis authors' files submitted through the Graduate School.

MODIFIED NATURAL RUBBER LATEX BY GRAFT
COPOLYMERIZATION WITH STYRENE AND DIIMIDE
HYDROGENATION

Mr. Anawat Pisuttisap

A Thesis Submitted in Partial Fulfillment of the Requirements
for the Degree of Master of Science Program in Petrochemistry and Polymer Science

Faculty of Science

Chulalongkorn University

Academic Year 2011

Copyright of Chulalongkorn University

Thesis Title MODIFIED NATURAL RUBBER LATEX BY
GRAFT COPOLYMERIZATION WITH STYRENE
AND DIIMIDE HYDROGENATION

By Mr. Anawat Pisuttisap

Field of Study Petrochemistry and Polymer Science

Thesis Advisor Professor Pattarapan Prasassarakich, Ph.D.

Thesis Co-advisor Assistant Professor Napida Hinchiranan, Ph.D.

Accepted by the Faculty of Science, Chulalongkorn University in Partial
Fulfillment of the Requirements for the Master's Degree

..... .Dean of the Faculty of Science
(Professor Supot Hannongbua, Dr.rer.nat.)

THESIS COMMITTEE

.....Chairman
(Associate Professor Supawan Tantayanon, Ph.D.)

.....Thesis Advisor
(Professor Pattarapan Prasassarakich, Ph.D.)

.....Thesis Co-advisor
(Assistant Professor Napida Hinchiranan, Ph.D.)

.....Examiner
(Associate Professor Wimonrat Trakarnpruk, Ph.D.)

.....External Examiner
(Assistant Professor Kitikorn Charmondusit, Ph.D.)

อนวัช พิสุทธิทรัพย์: น้ำยางธรรมชาติดัดแปรโดยกราฟต์โคพอลิเมอร์ไซเซชันด้วยสไตรีนและไฮโดรจิเนชันแบบไดอิมิด. (MODIFIED NATURAL RUBBER LATEX BY GRAFT COPOLYMERIZATION WITH STYRENE AND DIIMIDE HYDROGENATION) อ. ที่ปรึกษาวิทยานิพนธ์หลัก: ศ.ดร.ภัทรพรรณ ประศาสน์สารกิจ, อ. ที่ปรึกษาวิทยานิพนธ์ร่วม: ผศ.ดร.นพิตา หิญชีระนันท์, 93 หน้า.

การดัดแปรยางธรรมชาติลาเท็กซ์ด้วยวิธีกราฟต์โคพอลิเมอร์ไซเซชันและไฮโดรจิเนชันเป็นกระบวนการที่สำคัญอย่างหนึ่งโดยสามารถปรับปรุงสมบัติทางกายภาพ, สมบัติทางเคมี และสมบัติทางความร้อนของยางที่ไม่อิมิตัว ยางธรรมชาติลาเท็กซ์ถูกกราฟต์ด้วยสไตรีนผ่านวิธีอิมัลชันพอลิเมอร์ไซเซชันโดยใช้ตัวริเริ่มปฏิกิริยารีดอกซ์จากควิโนไฮโดรเปอร์ออกไซด์/เททราเอทิลีนเพนทามีน จากนั้นยางธรรมชาติกราฟต์สไตรีนถูกไฮโดรจิเนตด้วยวิธีไดอิมิดรีดักชัน โดยการใช้ไฮดราซีนและไฮโดรเจนเปอร์ออกไซด์โดยมีกรดบอริกเป็นตัวเร่งปฏิกิริยา ระดับไฮโดรจิเนชันของยางธรรมชาติลาเท็กซ์กราฟต์สไตรีนไฮโดรจิเนตคำนวณได้จากนิวเคลียร์แมกเนติกเรโซแนนซ์สเปกโทรสโกปี ภาวะที่ดีที่สุดของกราฟต์โคพอลิเมอร์ไซเซชันได้ประสิทธิภาพการกราฟต์ถึง 81.5% อีกทั้งยังได้ระดับไฮโดรจิเนชันสูงสุด 47.2% เมื่อใช้อัตราส่วนของไฮดราซีนต่อไฮโดรเจนเปอร์ออกไซด์ที่อัตรา 1:1.1 การวิเคราะห์สมบัติทางความร้อนแสดงให้เห็นเสถียรภาพทางความร้อนของยางธรรมชาติกราฟต์สไตรีนไฮโดรจิเนตเพิ่มสูงขึ้นกว่ายางธรรมชาติดั้งเดิม จากทรานส์มิสชันอิเล็กตรอนไมโครกราฟของยางธรรมชาติกราฟต์สไตรีนไฮโดรจิเนต แสดงโมเดลแบบเป็นชั้นของส่วนแกนที่ไม่ถูกไฮโดรจิเนตและชั้นของยางที่ถูกไฮโดรจิเนต จากการศึกษาสมบัติเชิงกลของเบลนด์ของเอบีเอส/ยางธรรมชาติกราฟต์สไตรีนไฮโดรจิเนต พบว่าการเพิ่มปริมาณยางธรรมชาติกราฟต์สไตรีนไฮโดรจิเนตที่ร้อยละ 10 โดยน้ำหนักทำให้เอบีเอสเบลนด์มีค่าความทนแรงดึง ระยะยืด และความทนแรงกระแทกเพิ่มขึ้น จากการบ่มเชิงความร้อนพบว่าการเติมยางธรรมชาติกราฟต์สไตรีนไฮโดรจิเนตส่งผลให้เอบีเอสเบลนด์มีความต้านทานต่อความร้อนมากกว่าการเติมยางธรรมชาติและยางธรรมชาติกราฟต์สไตรีน เบลนด์ของเอบีเอส/ยางธรรมชาติกราฟต์สไตรีนไฮโดรจิเนตนี้เรียกว่า “กรีนเอบีเอส” ซึ่งมีศักยภาพสูงเป็นเทอร์โมพลาสติกชนิดใหม่ในอุตสาหกรรมพลาสติก

สาขาวิชา.....ปิโตรเคมีและวิทยาศาสตร์พอลิเมอร์.....ลายมือชื่อนิสิต.....

ปีการศึกษา.....2554.....ลายมือชื่อ อ.ที่ปรึกษาวิทยานิพนธ์หลัก.....

ลายมือชื่อ อ.ที่ปรึกษาวิทยานิพนธ์ร่วม.....

5272615423: MAJOR PETROCHEMISTRY AND POLYMER SCIENCE
 KEYWORDS: GRAFT COPOLYMERIZATION/ DIMIDE HYDROGENATION/
 HYDRAZINE/ HYDROGEN PEROXIDE/ NATURAL RUBBER LATEX

ANAWAT PISUTTISAP : MODIFIED NATURAL RUBBER LATEX BY
 GRAFT COPOLYMERIZATION WITH STYRENE AND DIIMIDE
 HYDROGENATION. ADVISOR : PROF. PATTARAPAN
 PRASASSARAKICH, Ph.D., CO-ADVISOR : ASST. PROF. NAPIDA
 HINCHIRANAN, Ph.D., 93 pp.

Modification of natural rubber by graft copolymerization and hydrogenation is the significant method for improving the physical, chemical and thermal properties of diene-based elastomers. Natural rubber latex (NRL) was grafted by emulsion graft copolymerization with styrene monomer, using CHPO/TEPA as redox initiator system. The styrene grafted natural rubber (PS-*g*-NR) was hydrogenated by diimide reduction system in latex form, using hydrazine and hydrogen peroxide with boric acid as catalyst. The hydrogenation level of hydrogenated styrene graft NR H(PS-*g*-NR) were determined by nuclear magnetic resonance spectroscopy (¹H-NMR). At optimum condition of graft copolymerization, the maximum grafting efficiency was 81.5%. In addition, the highest hydrogenation level of 47.2% was achieved at the ratio of hydrazine to hydrogen peroxide at 1:1.1. The thermogravimetric analysis indicated that the thermal stability of H(PS-*g*-NR) was higher than their parent polymer. From TEM micrograph of hydrogenated PS-*g*-NR particles, non-hydrogenated rubber core and hydrogenated rubber layer were observed according to the layer model. From mechanical properties of ABS/H(PS-*g*-NR) blends, the addition H(PS-*g*-NR) content at 10 %wt in the ABS blends could increased the tensile strength and impact strength of ABS blends. From thermal aging, the addition of H(PS-*g*-NR) resulted in the more heat resistance of ABS blends than the addition of NR and PS-*g*-NR. The ABS/hydrogenated graft NR blend named “Green ABS” would have high potential as a new thermoplastic product in plastic industry.

Field of Study: Petrochemistry and Polymer Science Student's Signature.....

Academic Year: 2011.....Advisor's Signature.....

Co-advisor's Signature.....

ACKNOWLEDGEMENTS

The author would like to express sincere appreciation and deep thankfulness to his advisor, Prof. Dr. Pattarapan Prasassarakich and co-advisor, Asst. Prof. Dr. Napida Hinchiranan for the helpful suggestion, encouraging guidance, supervision and support throughout his research. The author also would like to acknowledge Assoc. Prof. Dr. Supawan Tantayanon, Assoc. Prof. Dr. Wimonrat Trakarnpruk and Asst. Prof. Dr. Kitikorn Charmondusit for serving as members of the thesis committee and for their worthy comments and suggestions.

The author gratefully acknowledge the support of the Thai Government Stimulus Package 2 (TKK2555) under the Project for Establishment of Comprehensive Center for Innovative Food, Health Products and Agriculture, the National Research University Project of CHE and the Ratchadaphiseksomphot Endowment Fund (AM1024I). Many thanks are going to the Program of Petrochemistry and Polymer Science and the Department of Chemical Technology, Faculty of Science, Chulalongkorn University.

Finally, the author wishes to express his deep gratitude to his family for their love, support and encouragement throughout graduate study. Also, special thanks are extended to his friends for friendship, encouragements and cheerful moral support.

CONTENTS

	PAGE
ABSTRACT IN THAI.....	iv
ABSTRACT IN ENGLISH.....	v
ACKNOWLEDGEMENTS.....	vi
CONTENTS.....	vii
LIST OF TABLES.....	x
LIST OF FIGURES.....	xii
LIST OF ABBREVIATIONS.....	xvi
CHAPTER I INTRODUCTION.....	1
1.1 The Purpose of The Investigation.....	1
1.2 Objectives.....	2
1.3 Scope of the Investigation.....	2
CHAPTER II THEORY AND LITERATURE REVIEWS.....	3
2.1 Acrylonitrile-Butadiene-Styrene (ABS).....	3
2.1.1 Production of ABS.....	4
2.1.2 Applications of ABS.....	6
2.2 Natural Rubber.....	6
2.2.1 Physical Properties of NR.....	7
2.2.2 Natural Rubber Latex.....	8
2.3 Graft Copolymerization	11
2.4 Emulsion Polymerization.....	14
2.5 Hydrogenation of Diene-based Polymers.....	18
2.5.1 Diimide Hydrogenation.....	19
2.5.2 Hydrogenation of Natural Rubber.....	20
2.6 Polymer Blends.....	21
2.7 Literature Reviews.....	23

	PAGE
CHAPTER III EXPERIMENTAL.....	28
3.1 Chemicals.....	28
3.2 Graft Copolymerization of Styrene onto Natural Rubber Latex.....	29
3.3 Hydrogenation.....	33
3.4 Blending of ABS/Modified Rubbers.....	36
3.5 Characterization.....	37
3.6 Thermal Properties.....	37
3.7 Morphological Study.....	38
3.8 Mechanical Properties of ABS/Modified Rubber Blends.....	38
3.9 Morphological Study of ABS/Modified Rubber Blends	40
CHAPTER IV RESULTS AND DISCUSSION.....	41
4.1 Graft Copolymerization of Styrene onto Natural Rubber Latex.....	41
4.1.1 Characterization of Graft Natural Rubber Latex.....	41
4.1.2 Effect of DRC (%) and Temperature.....	43
4.1.3 Properties of Grafted Natural Rubber Latex.....	45
4.2 Hydrogenation of Natural Rubber Latex.....	46
4.2.1 Characterization of Hydrogenated Natural Rubber Latex.....	46
4.2.2 Initial Study of Diimide Hydrogenation of NRL.....	48
4.3 Hydrogenation of PS-g-NR.....	49
4.3.1 Characterization of Hydrogenated PS-g-NR.....	50
4.3.2 Effect of Boric Acid.....	52
4.3.3 Effect of Hydrazine and Hydrogen Peroxide.....	53
4.4 Thermal Properties of Modified Rubbers.....	56
4.5 Morphological Study.....	58
4.6 Mechanical Properties of Blends of ABS and Modified NR.....	60
4.6.1 Effect of Rubber Content on Tensile Properties.....	61
4.6.2 Effect of Rubber Content on Impact Strength.....	63
4.6.3 Effect of Rubber Content on Hardness.....	63
4.6.4 Thermal Stability of ABS/Modified NR.....	64

	PAGE
4.7 Thermal Properties of ABS/Modified NR Blends.....	66
4.8 Morphology of ABS/modified rubber blends.....	68
CHAPTER V CONCLUSION AND SUGGESTION.....	71
5.1 Conclusions.....	71
5.2 Suggestions for The Future Work.....	72
REFERENCES.....	73
APPENDICES.....	77
Appendix A	78
Appendix B.....	79
Appendix C.....	81
Appendix D.....	85
Appendix E.....	87
Appendix F.....	88
VITA.....	93

LIST OF TABLES

Table	PAGE
2.1 Relative consumption of ABS in the different applications.....	6
2.2 Physical properties of NR.....	7
2.3 Composition of NRL.....	8
2.4 Types of monomer.....	16
3.1 Standard recipe used for graft copolymerization.....	30
3.2 Standard recipe used for hydrogenation of NR.....	34
3.3 Standard recipe used for hydrogenation of PS-g-NR.....	34
3.4 Blend conditions of ABS/modified rubber blends.....	36
4.1 Effect of DRC (%) and temperature on graft copolymerization of NRL....	43
4.2 Properties of grafted natural rubber.....	45
4.3 Effect of various parameters on hydrogenation of NRL.....	48
4.4 Effect of catalyst type on degree of hydrogenation (%)......	49
4.5 Effect of process parameters on hydrogenation of PS-g-NR.....	49
4.6 Glass transition and decomposition temperature of rubber samples.....	56
4.7 Effect of modified natural rubber content on tensile strength (TS), elongation at break (EB), Young's Modulus, impact strength, and hardness of ABS blends.....	60
4.8 Effect of modified natural rubber content on the thermal stability.....	64
4.9 Glass transition and decomposition temperature of blends samples.....	66
A-1 Typical properties of high ammonium natural rubber latex.....	78
B-1 Data for graft copolymerization of ST onto NR.....	79
D-1 Results of diimide hydrogenation of NRL in presence of copper sulfate as catalyst.....	83
D-2 Results of diimide hydrogenation of NRL in presence of boric acid as catalyst.....	83
D-3 Effect of KOH on diimide hydrogenation of PS-g-NR.....	84

Table	PAGE
D-4 Results of diimide hydrogenation of PS- <i>g</i> -NR in presence of boric acid as catalyst.....	84
E.1 Tensile strength of ABS/modified rubber blends.....	85
E.2 Elongation at break of ABS/modified rubber blends.....	85
E.3 Young's modulus of ABS/modified rubber blends.....	85
E.4 Impact strength of ABS/modified rubber blends.....	86
E.5 Hardness of ABS/modified rubber blends.....	86
E.6 Tensile strength (after aging) of ABS/modified rubber blends.....	86
E.7 Elongation at break (after aging) of ABS/modified rubber blends.....	87

LIST OF FIGURES

Figure	PAGE
2.1 Acrylonitrile-butadiene-styrene copolymers.....	3
2.2 Overview of ABS process A) emulsion polymerization and B) bulk polymerization.....	4
2.3 <i>cis</i> -1,4-polyisoprene.....	7
2.4 The structure of rubber particles.....	8
2.5 Schematic representation of gel phase in natural rubber.....	10
2.6 Presumed structure of branching and crosslinking of natural rubber.....	10
2.7 Graft Copolymers.....	12
2.8 Schematic of emulsion polymerization.....	15
2.9 General structure of natural rubber before and after hydrogenation process.....	21
3.1 Graft copolymerization apparatus of styrene onto natural rubber latex	30
3.2 Schematic of graft copolymerization of ST onto NR latex.....	31
3.3 Schematic of diimide hydrogenation apparatus.....	34
3.4 Schematic of Hydrogenation of PS- <i>g</i> -NR.....	35
3.5 Schematic diagram of tensile test specimen (type I).....	39
3.6 Dimensions of simple beam, charpy type, impact test specimen.....	40
4.1 ¹ H-NMR spectra of a) NRL and b) PS- <i>g</i> -NR.....	42
4.2 Effect of DRC (%) on conversion (●), grafted NR (◆), free NR (■), free ST (▲) and grafting efficiency (x). Condition : Initiator = 2 phr, monomer-to-rubber ratio = 1:1, <i>T</i> = 50 °C.....	44
4.3 Effect of DRC (%) on conversion (●), grafted NR (◆), free NR (■), free ST (▲) and grafting efficiency (x). Condition : Initiator = 2 phr, monomer-to-rubber ratio = 1:1, <i>T</i> = 60 °C.....	44
4.4 ¹ H-NMR spectra of a) NRL and b) HNR (HD=56.4%).....	47
4.5 ¹ H-NMR spectra of a) PS- <i>g</i> -NR and b) H(PS- <i>g</i> -NR) (47.2% HD, 56.4% GE).....	51

Figure	PAGE
4.6 Effect of amount of boric acid on PS- <i>g</i> -NR hydrogenation. Condition : [C=C] = 0.55 M, [N ₂ H ₄] = 2.33 M, [H ₂ O ₂] = 5.27 M, total volume = 150 mL, temperature = 70 °C, time = 6 h.....	52
4.7 Effect of amount of hydrazine on PS- <i>g</i> -NR hydrogenation. Condition : [C=C] = 0.55 M, [boric acid] = 74.7 mM, [H ₂ O ₂] = 5.27 M, total volume = 150 mL, temperature = 70 °C, time = 6 h.....	55
4.8 Effect of amount of hydrogen peroxide on PS- <i>g</i> -NR hydrogenation. Condition : [C=C] = 0.55 M, [N ₂ H ₄] = 2.33 M, [boric acid] = 74.7 mM, total volume = 150 ml, temperature = 70 °C, time = 6 h.....	55
4.9 TGA thermograms of (a) NR, (b) PS- <i>g</i> -NR, (c) H(PS- <i>g</i> -NR) 35.6% HD, (d) H(PS- <i>g</i> -NR) 47.2% HD.....	57
4.10 DSC thermograms of (a) NR, (b) H(PS- <i>g</i> -NR) 35.6% HD, (c) H(PS- <i>g</i> -NR) 37.8% HD, (d) H(PS- <i>g</i> -NR) 41.3% HD, (e) H(PS- <i>g</i> -NR) 47.2% HD.....	57
4.11 TEM micrographs of (a) NRL, (b) HNRL 52.6%HD, (c) PS- <i>g</i> -NR, (d) H(PS- <i>g</i> -NR) 51% HD and (e) H(PS- <i>g</i> -NR) 76% HD.....	59
4.12 Effect of rubber content on a) tensile strength, b) elongation at break, c) Young's modulus, d) impact strength and e) hardness (■) ABS, (◆) ABS/NR, (●) ABS/PS- <i>g</i> -NR, (▲) ABS/H(PS- <i>g</i> -NR).....	62
4.13 Effect of modified natural rubber content on thermal aging: the tensile strength of a) ABS/NR, b) ABS/PS- <i>g</i> -NR, c) ABS/H(PS- <i>g</i> -NR) and elongation at break of d) ABS/NR, e) ABS/PS- <i>g</i> -NR, f) ABS/H(PS- <i>g</i> - NR).....	65
4.14 TGA thermograms of ABS/H(PS- <i>g</i> -NR) blends at a) 100/0, b) 95/5, c) 90/10 and d) 80/20.....	67
4.15 DSC thermograms of ABS/H(PS- <i>g</i> -NR) blends at a) 100/0, b) 95/5, c) 90/10 and d) 80/20.....	67

Figure	PAGE
4.16 SEM micrographs of ABS/modified rubber blends at 95/5 wt ratio of a) ABS, b) ABS/NR, c) ABS/PS- <i>g</i> -NR and d) ABS/H(PS- <i>g</i> -NR) (magnification: 5,000 ×).....	69
4.17 SEM micrographs of ABS/modified rubber blends at 90/10 wt ratio of a) ABS/NR, b) ABS/PS- <i>g</i> -NR, c) ABS/H(PS- <i>g</i> -NR) and at 80/20 wt ratio of d) ABS/NR, e) ABS/PS- <i>g</i> -NR, f) ABS/H(PS- <i>g</i> -NR) (magnification: 5,000 ×).....	70
F-1 DTG curves of NR, PS- <i>g</i> -NR and H(PS- <i>g</i> -NR).....	90
F-2 DTG curves of H(PS- <i>g</i> -NR) at various degree of hydrogenation.....	90
F-3 DTG curves of ABS and ABS/NR blends at various rubber content.....	91
F-4 DTG curves of ABS and ABS/PS- <i>g</i> -NR blends at various rubber content.....	91
F-5 DTG curves of ABS and ABS/H(PS- <i>g</i> -NR) blends at various rubber content.....	92

LIST OF ABBREVIATIONS

ASTM	: American Society for Testing and Materials
CHCl_3	: Chloroform
CHPO	: Cumene Hydroperoxide
DRC	: Dry rubber content
DSC	: Differential Scanning Calorimetry
EPDM	: Ethylene-Propylene Diene Monomer
GE	: Grafting Efficiency
HD	: Hydrogenation Degree
H(PS- <i>g</i> -NR)	: Hydrogenated graft natural rubber
ISO	: International Standardization for Organization
NBR	: Acrylonitrile-Butadiene Rubber
MWD	: Molecular Weight Distribution
NMR	: Nuclear Magnetic Resonance Spectrometer
NRL	: Natural Rubber Latex
OsO_4	: Osmium Tetraoxide
phr	: Parts per Hundred of Rubber
PS- <i>g</i> -NR	: The graft copolymer of styrene onto natural rubber
SBR	: Styrene-Butadiene Rubber
SDS	: Sodium Dodecylsulfate
SEM	: Scanning Electron Microscope
TEM	: Transmission Electron Microscope
TEPA	: Tetraethylene Pentamine
T_g	: Glass Transition Temperature
TGA	: Thermal Gravimetric Analysis
T_{id}	: Initial Decomposition Temperature
T_{max}	: Maximum Decomposition Temperature

CHAPTER I

INTRODUCTION

1.1 The Purpose of the Investigation

Acrylonitrile-butadiene-styrene copolymer (ABS) is synthesized via graft copolymerization of styrene and acrylonitrile monomer onto polybutadiene chain, which has advantage mechanical properties such as toughness, high impact resistance and chemical resistance. ABS is thermoplastics which its monomers are from petroleum. Graft natural rubber synthesized by graft copolymerization of styrene onto natural rubber could be the modifier in ABS [1]. Graft natural rubber has good mechanical and dynamic properties such as high elasticity, high tear strength and low heat storage. However, the modified NR as a possible substitute of synthetic rubber can be used at small amount with limitation, especially used in the products with high weather resistance because NR can be deteriorated by sunlight, ozone, and oxygen from its high unsaturation level. Thus, chemical modification of NR is the method for overcoming these disadvantages.

Hydrogenation is the useful method for polymer modification, which reduces the amount of unsaturation and changes the properties of the diene polymer toward greater stability against thermal and oxidative degradation. Hydrogenation of natural rubber can be achieved by both catalytic [2] and non-catalytic methods [3]. Non-catalytic hydrogenation of unsaturated backbone of natural rubber is usually carried out using diimide reduction technique in latex form [3]. The active hydrogen species in the form of diimide (NH=NH) is derived from the oxidation of hydrazine, which is capable of reducing C=C double bonds [4], the overall reaction for diimide reduction is presented as Eqs. (1.1), (1.2) and (1.3).

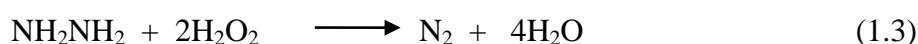
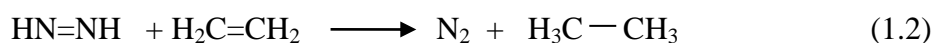

This research work focused on graft copolymerization and hydrogenation to improve the properties of NR, and the hydrogenated graft NR as “Green Polymer” could be used as ABS modifier. The ABS/hydrogenated graft NR blend named “Green ABS” would high potential as a new thermoplastic product in plastic industry.

The aim of this research was to study the hydrogenation of styrene-*g*-natural rubber (PS-*g*-NR) by diimide reduction. The effect of reaction parameters on the hydrogenation degree of PS-*g*-NR were investigated.

1.1 Objectives of the Research Work

1. To study the graft copolymerization of styrene onto natural rubber latex.
2. To study the hydrogenation of natural rubber latex and grafted natural rubber using diimide reduction.
3. To study the thermal and physical properties of hydrogenated PS-*g*-NR.
4. To study mechanical properties of ABS/H(PS-*g*-NR) blends.

1.3. Scope of the Research Work

1. Literature survey and in-depth study of this research work.
2. Preparation of graft copolymer of styrene onto natural rubber latex (PS-*g*-NR) via emulsion polymerization using CHPO/TEPA as redox initiator.
3. Characterization of the graft natural rubber structure and determination of the grafting properties.
4. Investigation of the influence of variables on hydrogenation of NR latex and PS-*g*-NR using diimide reduction.
5. Characterization of the hydrogenated product structure and determination of the hydrogenation degree.
6. Preparation of blends based on ABS and modified natural rubber such as grafted NR and hydrogenated PS-*g*-NR using the internal mixer.
7. Investigation of the thermal and mechanical properties of ABS/H(PS-*g*-NR) blends and study the morphology of modified NR dispersed in matrix.
8. Summarizing and conclusion the results.

CHAPTER II

THEORY AND LITERATURE REVIEWS

2.1 Acrylonitrile-Butadiene-Styrene (ABS) [5],[6]

Acrylonitrile-Butadiene-Styrene (ABS) is an industrial thermoplastics that derived from three monomers: acrylonitrile (A), butadiene (B) and styrene (S). The copolymer components have different chemical composition and exist together as two separate phase which its compatible is restrained by their chemical structure and microstructure. ABS is made by polymerizing of poly(styrene-*g*-acrylonitrile) (SAN) onto the polybutadiene backbone. The structure of ABS is shown in Figure 2.1.

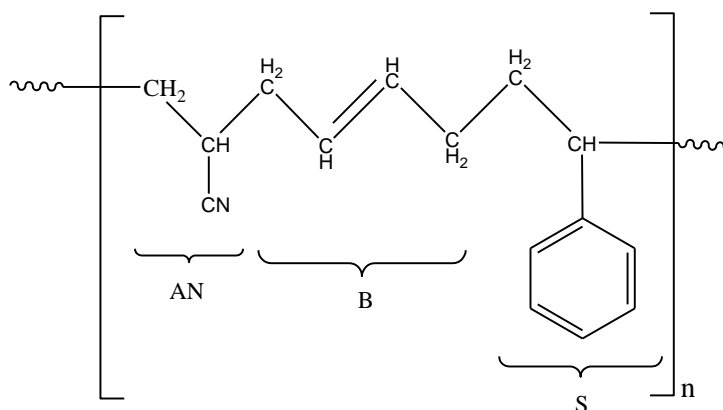

Figure 2.1 Acrylonitrile-butadiene-styrene copolymers [5]

The physical and mechanical properties of ABS reflect its composition as an isotropic mixture with widely differing properties. The advantage of ABS is the combination of strength and rigidity of acrylonitrile and styrene polymers with the toughness of polybutadiene. The most important physical properties of ABS are good thermoplastic flow, satisfactory rigidity, heat resistance and high surface gloss. Furthermore, the most important mechanical properties are high impact resistance and toughness.

The production of ABS is carried out by emulsion, suspension, or bulk polymerization of SAN in the presence of the rubber phase (matrix). The rubber phase is either poly(1,3-butadiene) or nitrile rubber (NBR). The product from the polymerization is azeotropic mixture of SAN and graft copolymer of SAN onto the rubber. Furthermore, SAN is often blended into that mixture. The final product of ABS contains a glassy phase (SAN) dispersed in a rubber matrix (grafted rubber). ABS can be divided into ABS blend type and graft type.

In ABS blend type, a rubber copolymer is blended with a SAN copolymer. The rubber copolymer contains a matrix monomer (e.g. acrylonitrile in NBR rubber) or a monomer whose solubility parameters resemble those of the matrix. These ABS systems have very little importance today.

Graft ABS polymers contain a polybutadiene graft copolymer as the elastomer components. The graft shell is constructed from the same monomer units as the resin matrix to give optimal phase interaction between the cross-linked rubber particles and the thermoplastic matrix.

2.1.1 Production of ABS [5]

The production of ABS can take place by emulsion, bulk, or combined processes. The overview of the ABS process is shown in Figure 2.2.

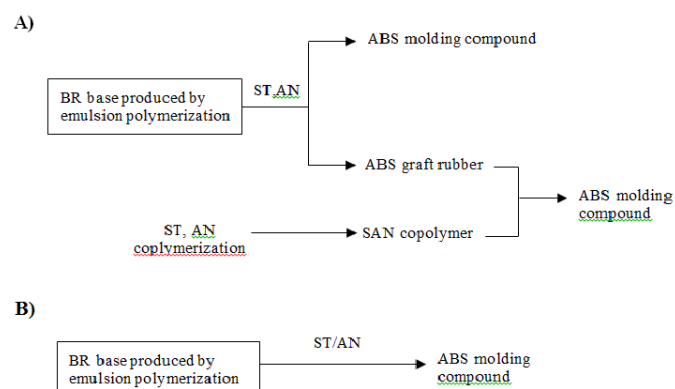

Figure 2.2 Overview of ABS process A) emulsion polymerization and B) bulk polymerization [6].

There are two main types of emulsion polymerization which yield ABS graft rubbers with a rubber content of 5-85% wt and $\leq 20\%$ wt, respectively.

- 1) Separate production of the ABS graft rubber and SAN matrix with a subsequent mixing and compounding step.
- 2) Total emulsion process, i.e, production of the molding compound containing both the grafted rubber and the SAN matrix by emulsion polymerization (the synthesis of a polybutadiene base proceeds the ABS grafted polymer production)

Bulk polymerization starts from a separately produced rubber base (butadiene (BR) or styrene butadiene (SB) rubbers). The molding compound is produced in a bulk process run continuously over several stage. Rubber content is limited to $\leq 20\%$ wt for viscosity reasons.

a) Emulsion Polymerization

The emulsion process is the standard ABS production process but the principle of this method has also been applied to other rubber-modified, two phase styrene copolymer system. The production of grafted rubber with high rubber contents and their mixing with a separately produced SAN matrix is widely used. The total emulsion process is of minor importance and is not described here.

The production of ABS grafted rubber consists of three stage . The first step is production of the graft base , i.e., a polybutadiene or butadiene copolymer latex with defined particle size, particle size distribution and gel content, second step is the process of graft copolymerization the styrene (ST) and acrylonitrile (AN) monomer mixtures onto the rubber base, The final step is the workup of the grafted rubber latex.

b) Bulk Polymerization

ABS production by bulk polymerization is based on the polymerization of ST-AN mixtures in the presence of a rubber substrate dissolved in this monomer phase. The process can be divided into three steps. Initial step, the rubber substrate is dissolved in the monomer mixture. For the second step, the rubber monomer mixture is prepolymerized with continuous mixing (conversion 15-30% wt). Finally, the

polymer-monomer mixture is polymerized further by bulk polymerization or by continuous bulk polymerization in a high-viscosity reactor cascade.

2.1.2 Applications of ABS [6]

ABS is the material of choice for many applications and the largest volume engineering thermoplastics sold. Also, it has many different grade and a wide range of properties suit for customer required. The application of ABS are listed in Table 2.1, including the approximate relative consumption. The one of the largest ABS materials the automotive application (grilles, head light housing, panels, wheel cover, knobs and trims). In addition, the most office major appliance application is the refrigerator linings and comparments. Electrical/electronic markets can be divided into those of business machines, such as computers, calculator, disc and telephone. The pipe markets is consist of housing and construction (pipe, fitting, shower stalls, bath tubs and conduit). Miscellaneous include tattoo ink, tool boxes, toys, luggage, medical applications and furniture.

Table 2.1 Relative consumpcion of ABS in the different applications [5]

Application	ABS sold (%)
Appliance	29.4
Automotive	22.3
Business machine	13.6
Packaging	0.2
Pipes and fittings	7.4
Recreational uses	3.9
Other	23.2

2.2 Natural Rubber [7],[8]

Natural rubber (NR) is a renewable elastic polymer derived from *Hevea brasiliensis* (Pará rubber tree), which is one of the most important industrial crop of Thailand. Natural rubber latex (NRL) is a stable dispersion of a rubber particles in an aqueous medium, a milk-like liquid. The dispersed component of the two-member system thus consist of essentially spherical particles of varying size suspended in a continuous phase containing suitable emulsifier, or stabilizers. The chemical name of

natural rubber is *cis*-1,4-polyisoprene which its structure are from the propagation of isoprene units be a long straight chain. Natural rubber has several mechanical properties superior to synthetic polymer such as high elasticity, toughness, shear resistance and low heat build up, which can be applied and replaced synthetic polymer in the industry. However, each unit of isoprene has carbon-carbon double bond and α -methylene group which are susceptible to reaction and easily reacts with ozone, oxygen and sunlight. The illustration of NR structure is shown in Figure 2.3.

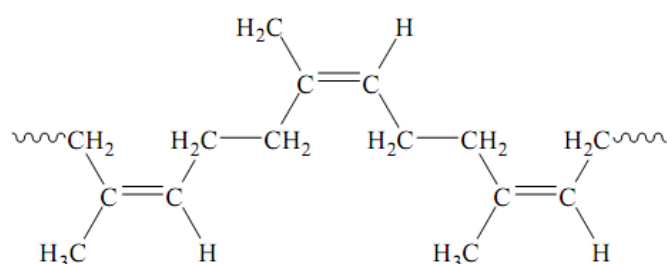

Figure 2.3 *cis*-1,4-polyisoprene [9]

2.2.1 Physical Properties of NR [10]

The physical properties of NR may vary slightly due to the presence of non-rubber substances and the crystallinity degree. The crystallization occurs when NR is held below 10 °C, so the density of NR is changed from 0.92 to 0.95. The average physical properties of NR are listed in Table 2.2.

Table 2.2 Physical properties of NR [10]

Properties	Value
Density	0.92 g/cm ³
Refractive index (20 °C)	1.52
Coefficient of cubical expansion	0.00062/°C
Cohesive energy density	63.7 cal/cm ³
Heat of combustion	10,700 cal/g
Thermal conductivity	0.00032 cal/sec·cm ³ ·°C
Dielectric constant	2.37
Power factor (1,000 cycles)	0.5-0.2
Volume resistivity	10 ¹⁵ ohms/cm ³
Dielectric strength	1,000 V/mm

2.2.2 Natural Rubber Latex [11]

Natural rubber latex (NRL) comes from a tree is known as field latex. The rubber latex are comprised only about 36% rubber and 4% non-rubber substances. The non-rubber components include proteins, carbohydrates, liquid and inorganic material (salts). Its composition is proportionate to the age of rubber, clones of rubber and tapping method. The composition of typical NRL is presented in Table 2.3.

Table 2.3 Composition of NRL [11].

Composition	% by weight
Water	55
Rubber hydrocarbon	35
Protein	4.5
Acetone extraction	3.9
Amino acid,etc	0.2
Quebrachitol	1.0
Inorganic salts	0.4

The rubber particles in natural rubber latex are spherical droplets of hydrocarbon, which the surface of the rubber particles is covered with phospholipid and protein layers [12] as shown in Figure 2.4. The outer layer proteins act to stabilize the particles. The particle size distribution is very broad. The average particle size is between 0.1-1.0 μm . The weight average molecular weight of NR is in the region of one million with a high polydispersity index. The polydispersity index in weight, M_w , M_n , is in the range of 2.5-10 [13].

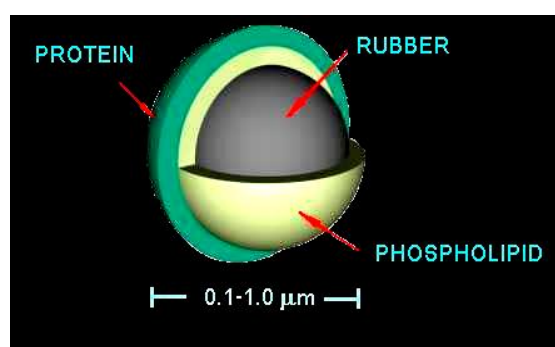

Figure 2.4 The structure of rubber particles [12].

Hevea rubber is a very high molecular weight polymer with broad molecular weight distribution (MWD). The broad MWD of *hevea* rubber is presumed to be derived from the branching and crosslinking reaction by certain special functional groups in rubber molecules [14].

The natural rubber in dry solid form consists of the two components which called “sol” and “gel” [15]. The sol phase is a rubber part that dissolves easily in good solvents such as cyclohexane, toluene, tetrahydrofuran (THF), etc., while the gel phase is insoluble but swells in the same solvent. Commercially dry *Hevea* rubber contains 5-50% gel component, depending on the clonal origin of the rubber, processing conditions, time and the storage temperature. The true gel phase in NR was presumed to consist of small crosslink latex particles or “microgels” [16] as shown in Figure 2.5. The microgels are combined into a matrix with the sol fractions and form an apparent gel phase. Since the gel phase in NR comprises nitrogenous and mineral components higher than the sol phase, this can be postulated that the gel phase is linked up with the network of proteins via hydrogen bonding. The decreasing of gel content in rubber can be performed by deproteinization and transesterification [17]. These treatments can decompose the branching and crosslink that included protein and fatty acid ester group, respectively. This can be attributed to the fact that the branching and crosslink are composed of two type branch-points. One is presumed to be formed by the intermolecular interaction of proteins and another by phosphoric ester group and long chain fatty acid ester group as shown in Figure 2.6. Moreover, the gel phase in *Hevea* rubber is sometimes classified to “loose gel” or “soft gel” and “tight gel” or “hard gel”. The soft is derived from various non-rubber components, which can be decomposed by chemical reaction such as enzymatic deproteinization, transesterification and saponification [17]. On the other hand, the hard is formed by crosslinking of unsaturated rubber chain, which can not be decomposed by chemical reaction.

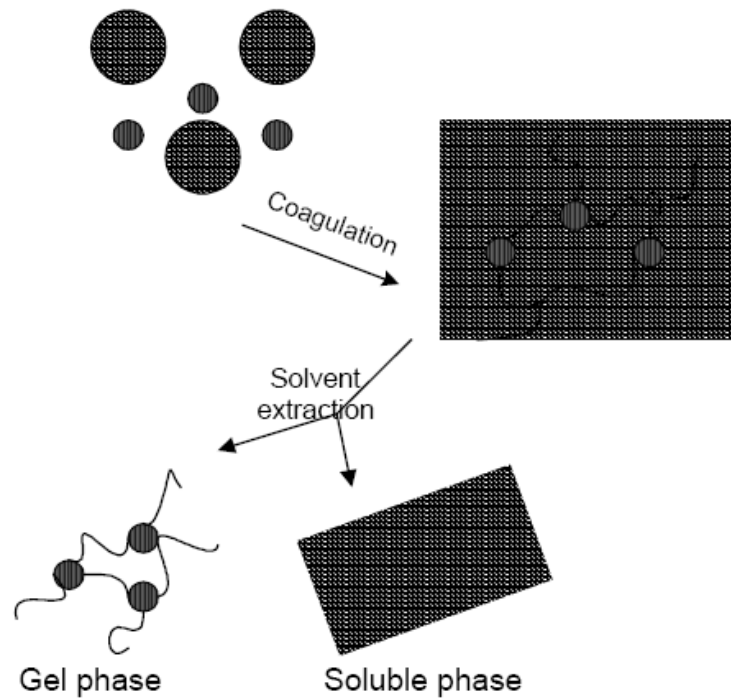

Figure 2.5 Schematic representation of gel phase in natural rubber [16].

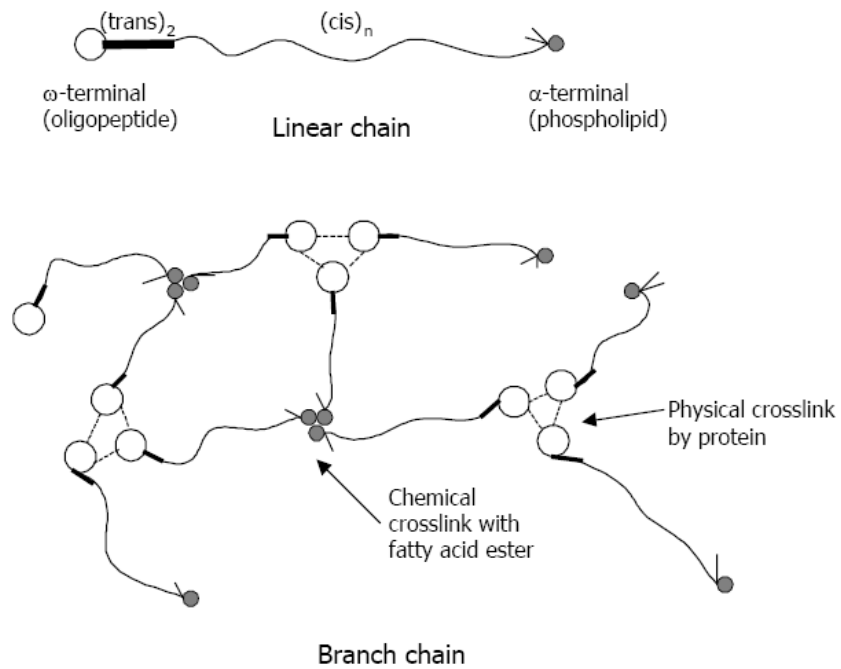

Figure 2.6 Presumed structure of branching and crosslinking of natural rubber [17].

2.3 Graft Copolymerization [18]

Since the presence of carbon-carbon double bonds in NR repeating unit which can be deteriorated by oxygen, ozone, sunlight and long term heating, this drawback properties can be improved via chemical modification of its molecular structure. The chemical modification of NR can be achieved in several ways by the following methods:

- Modification by bond rearrangement without introducing new molecule such as carbon-carbon cross-linking, cyclization, *cis-trans* isomerization and depolymerization.
- Modification by attachment of new chemical groups at olefinic carbon-carbon double bonds such as hydrogenation, halogenation, hydrohalogenation, epoxidization and end reaction.
- Grafting short or long chains of different polymer types onto the NR backbone [17].

Graft copolymerization refers to method used to chemically preparation of a copolymer which is produced by polymerization of one monomer species (side-chain species) onto another polymer chain (backbone species), which the monomers of the second type is connected as branch with the main chain of the first monomers as shown in Figure 2.7. Resulting graft copolymer has properties common to both type of polymer. The synthesis of graft copolymer must be made the active site on the molecule of preformed polymer, then the polymerization can be occurred. Commercial synthesis of graft copolymer is carried out with the use of radical polymerization by homogeneous or heterogeneous system depending on the solubility of grafted polymer.

The graft copolymer consists of a single main chain with one or more polymer side chains in which side chain are structurally distinct from the main chain. The suitable monomer for production of graft copolymer is vinyl monomer such as methyl methacrylate (MMA), styrene (ST), or vinyl acetate either a mixtures of monomers in the above mentioned.

Graft copolymer can be synthesized by several method but the most popular method for natural rubber is core-shell emulsion method due to low viscosity of all period reaction and easily temperature control. Moreover, the natural rubber latex, which can be used directly in the emulsion form and the particle size of graft copolymer is in the range of 0.05-5.0 micron, which disperse in aqueous phase.

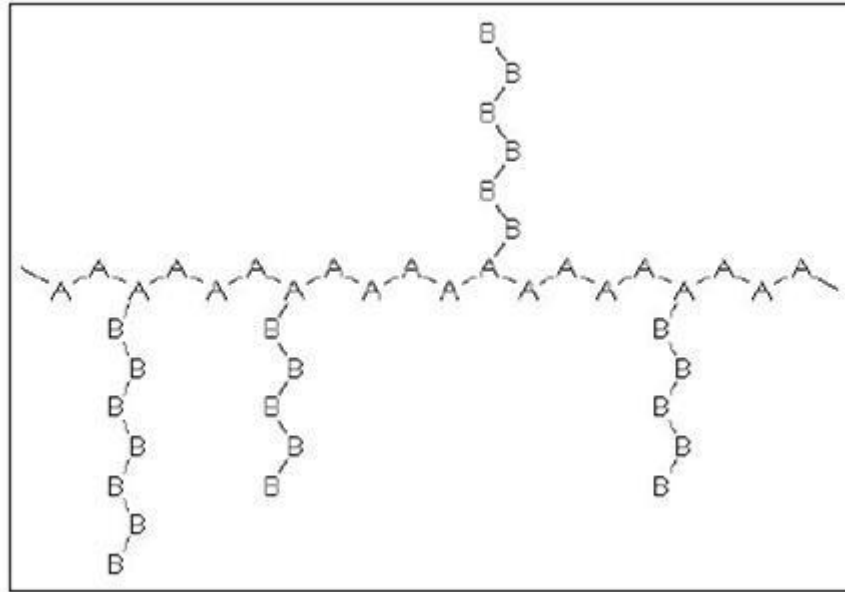

Figure 2.7 Graft copolymers [18]

The mechanism of graft copolymerization onto NR backbone consists of 3 steps : 1) initiation step, 2) propagation step and 3) termination step.

The initiation step usually includes the addition of the first monomer molecule. In this reaction, the initiator (cumene hydroperoxide: CHPO) will decompose to alkoxy radicals ($RO\cdot$), which these radicals might attack either monomer (M) or the rubber molecules to produce the monomer radicals ($M_n\cdot$) and polyisoprene radicals ($NR\cdot$) as grafting sites follow Eq. 2.1 and 2.2, respectively. During the formation of graft copolymer, the latex particles surface become the loci polymerization. The α -methylene hydrogen atoms (H) of natural rubber NR (NR-H) can also become the site of graft copolymerization due to the more active site. The alkoxy radical can attack the α -methylene hydrogen atoms (H) to form polyisoprene radicals ($NR\cdot$) to initiate monomers for producing graft copolymers radicals ($NR-M_n\cdot$), Eq. 2.3 [19].

Initiation :

Attacking monomer:

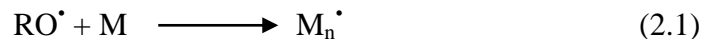

Attacking rubber:



Reinitiation:



In propagation reaction, many of monomer molecules are added rapidly. NR-M_n^\bullet attacks M to form graft copolymers (NR-M_{n+1}), Eq. 2.4 or M_n^\bullet attacks M to form free copolymer radicals (M_{n+1}^\bullet), Eq. 2.5. Then, M and NR-M_n^\bullet will either combine with NR^\bullet to terminate the process or transfer to NR via chain transfer agent (A) to form NR-M_n^\bullet , Eq. 2.6-2.10.

Propagation:

Propagation of graft polymerization:

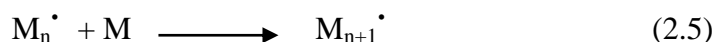

Propagation of free polymerization:

**Chain transfer to macromolecules:**

Transfer to monomer:



Transfer to rubber:

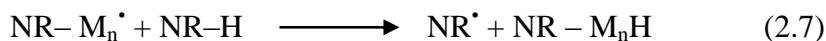

Transfer to chain-transfer agent:

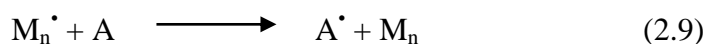

The termination step, the NR-M_n^\bullet can also terminate the process by reacting with free copolymers (Eq 2.11-2.13) on the surface of latex particles. Termination is occurred by combination, where now represents a long chain portion or disproportionation, where the hydrogen atom is transferred to the other atom.

Termination by combination:

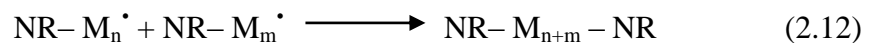
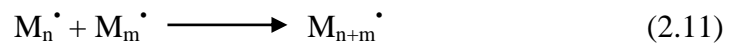

Synthesis of graft copolymers are divided into two methods.

1) The polymer side chain can be directly connected by a suitable reaction to the backbone polymer.

2) The polymer backbone can be initiated to occur active sites such as free radicals or ions to be used for polymerization of suitable monomers resulting the side chain polymer.

2.4 Emulsion Polymerization [20]

Emulsion polymerization method which is the initiation takes place in a heterogeneous system (water phase or monomer swollen-micelles). The conversion of monomer to polymer obtains from the addition of a free radical initiator and the application of heat. The advantages of this method are the various possibilities to prepare particles with controlled morphologies and surface properties. Furthermore, the emulsion product referred to as a latex which can be used directly without further separation. Emulsion polymerization technique provides the core-shell arrangements. This technique is interested for producing two phase latex with defined morphology. A two step procedure has appeared in which an outer layer of polymers is polymerized onto an inner core of a different polymers. From the morphology of the polymer particles, there are two models of core-shell copolymer: soft core-hard shell and hard core-soft shell. The core shell latex with a glassy core and rubbery shell can be used in coating and adhesive formulation; while, the latex particles with rubbery

core and glassy shells are used as impact modifier in plastic. Emulsion polymerization could be synthesized core-shell particle for rubbery particle structure. The first stage of this process is the formation of rubbery core latex particles, then these particles are used as a seed in second stage emulsion polymerization, for coating with a glassy shell by grafting. The process of emulsion polymerization is shown in Figure 2.8.

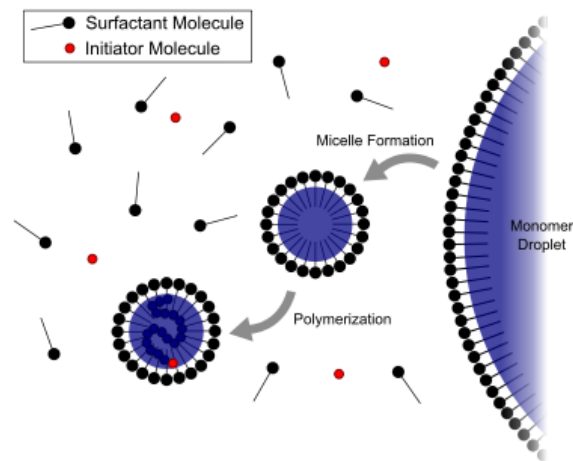

Figure 2.8 Schematic of emulsion polymerization

[http://en.wikipedia.org/wiki/Emulsion_polymerization]

- The mechanism of emulsion polymerization is summarized by the follow steps
- Monomer droplets are formed by the dispersion of a monomer in a solution of surfactant.
 - The excess surfactant molecules aggregate together to form micelles, when the concentration of surfactant exceeds its critical micelle concentration (CMC).
 - A water-soluble initiator migrates into a micelle and reacts with a monomer molecules.
 - Monomer in micelles quickly polymerizes and growing chain terminates.
 - Monomer from the large droplet migrates to the micelles to support polymerization.
 - Finally, the free monomer droplet disappear and all remaining monomer is located in the particles.
 - The final product is a dispersion of polymer particles in water (emulsion).

Ingredients of emulsion polymerization.

a) Monomer

Monomer is a major polymerizable component of an emulsion polymerization and determine the properties of polymer obtained. Moreover, it can be partially soluble in aqueous phase and swells in its polymer. Monomers that are commonly used in emulsion polymerization are the vinyl type, $\text{CH}_2=\text{CHX}$. X may be H, CH_3 , C_6H_5 , CN, Cl, O_2CCH_3 and CO_2R . There are some monomers that usually used in commercial emulsion polymerization process which presented in Table 2.4.

Table 2.4 Types of monomer [21]

Monomer	Example of common usage
Styrene	Ingredients in artificial rubber (SBR also used in paper coating)
Butadiene	1) Ingredients in artificial rubber (SBR also used in paper coating) 2) Impact modifier (toughen of plastic), e.g. HIPS, ABS
Tetrafluoroethylene	1) polytetrafluoroethylene, e.g. Teflon 2) ingredient in fluoropolymers, e.g. Viton
Vinyl ester	1) polyvinyl acetate (PVA) adhesive 2) ingredient in paint
Methyl methacrylate	ingredient in surface coatings
Acrylic acid	minor ingredient in paint formulation
Itaconic acid	minor ingredient in paint formulation
2-chloro-1,3-butadiene (chloroprene)	neoprene rubber (which has sulfur as co-monomer)
Butyl acrylate	rubber ingredient in surface coating
Butyl methacrylate	rubber ingredient in surface coating
Methyl acrylate	co-monomer in surface coating, adhesives
Vinyl chloride	PVC (usually produced by suspension method, sometimes by emulsion)

b) Dispersing medium

Dispersing medium is a substance in which another is colloiddally dispersed and it also reduces the heat of reaction. Most of the medium is water with the absence of various ions, for the water in which ions dispersed can be retarded or inhibited emulsifier efficiency.

c) Emulsifier

Emulsifier (also known as emulgent) is a substance that stabilizes an emulsion by increasing its solubility. Moreover, it consists both hydrophilic groups which like water and hydrophobic groups which dislike water. In emulsion system, emulsifier molecule will disperse in water and adsorb at the interface between oil phase and aqueous phase which cause the formation of micelle. At the core of micelle is where the position of polymerization occurring in it.

d) Initiators

The second important ingredient for emulsion polymerization is the initiators, because it can be produced free radical species to react with vinyl monomer. Most of free radical species was produced by thermal decomposition of peroxy compound like persulfate or by redox reactions like cumene hydroperoxide/tetraethylene pentamene, or by γ -radiation. These substances generally possess weak bond and can be either oil or water-soluble. For redox initiators system, free radicals were produced by the combination of certain reducing and oxidizing agents at mild condition.

e) Stabilizers

The dispersion stabilizers are used directly or combinations to increase the particle stability against coagulation. The stabilizers are a water-soluble which is a protective colloid, such as isopropylalcohol, hydroxylethyl cellulose and resin derivatives.

f) Other Ingredients

There are many ingredients that often used in emulsion polymerization such as buffering agents to control pH of solution system, chain transfer agents to control molecular weight, electrolytes and inert salts.

2.5 Hydrogenation of Dienes-based Polymers [22]

The chemical modification by hydrogenation is a useful method to reduce the unsaturated of hydrocarbon bonds in diene polymers and also improved the physical, chemical and thermal properties of diene polymers. This method has been studied for long time and has been interested from many researchers. Moreover, hydrogenation can be applied in many industries and in laboratories. The major hydrogenated polymers in synthetic rubber industries are hydrogenated styrene-butadiene rubber (HSBR) produced by Shell and hydrogenated acrylonitrile-butadiene rubber (HNBR) manufactured by Zeon Chemicals and Bayer Inc. Both of these hydrogenated rubbers have better resistance to thermal and oxidative degradation, which are far superior to those of the parent rubbers [22].

Hydrogenation can be carried out by both catalytic (heterogeneous, homogeneous) and non-catalytic (diimide) reactions [23]. There are a lot of research in the field of catalytic hydrogenation. The advantage of catalytic hydrogenation are high degree of hydrogenation, high selectivity and low reaction time, although this method requires the specific equipment because the reaction performed at high temperature and high pressure. Furthermore, catalytic hydrogenation is necessary to use transition metal catalysts in the presence of solvent and the final product is not in emulsion form. The hydrogenated polydienes, such as *nitrile butadiene rubber (NBR)*, styrene-butadiene rubber (SBR) and natural rubber (NR) can be produced by catalytic hydrogenation in the presence of transition metal catalysts such as $\text{OsHCl}(\text{CO})(\text{O}_2)(\text{PCy}_3)_2$, $\text{RuCl}_2(\text{PPh}_3)_3$ and $\text{RhCl}(\text{PPh}_3)_3$. The hydrogenation of these polydienes can also be accomplished by using noncatalytic methods, using an inorganic reagent such as diimide (N_2H_4). Non-catalytic hydrogenation or diimide hydrogenation have been explored and are proposed; besides, this method using mild reducing agents performs under milder conditions. Moreover, diimide hydrogenation of the polydienes is the most effective for reducing the unsaturated organic compounds and can be prepared at atmospheric pressure with relatively simple apparatus and procedures. Diimide hydrogenation is a new choice of efficient hydrogenation technology and has an interest in the area of hydrogenation of polydienes rubber in latex form which more economically feasible approach.

2.5.1 Diimide Hydrogenation [24], [25]

The hydrogenation process by using diimide as a reducing agent, which is generated from the redox reaction between hydrogen peroxide (H_2O_2) and hydrazine hydrate (N_2H_4), is energetically favorable. The diimide reduction is a chemical reactions that directly convert unsaturated elastomers in latex form to its saturated latex form. This technique is not used re-dissolving and solvent-removing steps because this technique does not use organic solvent. Moreover, this method can be operated without high pressure vessel or hydrogen gas. The active hydrogen species in the form of diimide ($\text{NH}=\text{NH}$) is derived from the oxidation of hydrazine, which is capable of reducing $\text{C}=\text{C}$ double bonds, the overall reaction for diimide reduction is presented as Eqs. (2.12), (2.13), (2.14) and (2.15) [24].

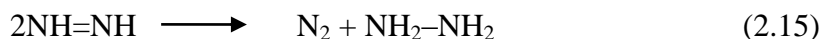
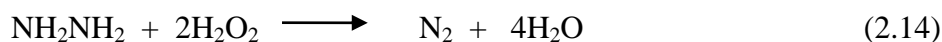
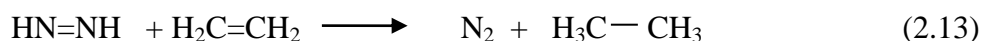

Diimide hydrogenation is achieved by two steps: (1) the reaction between hydrazine and hydrogen peroxide to produce the diimide and (2) the reaction between diimide and $\text{C}=\text{C}$ to form hydrogenated polymer.

However, the activity of diimide may be reduced due to possible two side reactions occurred simultaneously with hydrogenation reaction. One is the further reaction of diimide with hydrogen peroxide to generate nitrogen gas, which most likely occurs on the interface as the hydrogen peroxide resides in the water phase. The other side reaction is the reaction between two diimide molecules to produce one molecule of hydrazine and to release one nitrogen gas molecule, which most likely occurs in the rubber phase.

The four reactions represented by Eqs. (2.12), (2.13), (2.14) and (2.15) comprise the framework of the diimide hydrogenation of latex. Eq. (2.12) may occur at the interface of the rubber particles and also the bulk aqueous phase. Diimide may get consumed by way of Eq. (2.14) either at the interface or in the aqueous phase

before it actually diffuses into the rubber particles. Equation (2.15) is the radical source for crosslinking. There are three competing parallel processes in the reaction mechanism.

1. The reaction of Eq. (2.12) may occur at the interface and also in the bulk aqueous phase. Diimide generated in the aqueous phase would not be available for the hydrogenation reaction in the organic phase. Thus, this competition influences the efficiency of the diimide utilization in the aqueous phase.
2. The reaction of Eq. (2.14) is competed with the diimide diffusion process for diimide before it diffuse into the rubber particles. This competition influences the efficiency of diimide utilization at the interface.
3. The reaction Eq. (2.15) is competed with Eq. (2.12) for diimide. This competition influences the diimide utilization efficiency in the rubber phase, and also set up the platform for radical generation and crosslinking.

2.5.2 Hydrogenation of Natural Rubber [22]

Any polymer with unsaturated hydrocarbon groups, present either in the backbone or within the side chain, can be hydrogenated. The most recent work for polymer hydrogenation has produced excellent products, such as hydrogenated NBR and hydrogenated SBR that have better thermal and oxidative stabilities. In addition, hydrogenation is an alternative way to produce some polymer structures which are difficult to access via conventional polymerization, such as alternating ethylene-propylene copolymer from the hydrogenation of polyisoprene or natural rubber, and hydrogenation of block copolymers. Hydrogenation of these block copolymers forms thermoplastic elastomers with crystalline and amorphous segments different from those of their unsaturated counterparts [26].

The main polymer structure within natural rubber is *cis*-1,4-polyisoprene, which is an unsaturation along the chain and has primary drawback in thermal and oxidative stabilities. For this reason, reducing the unsaturated units of NR should overcome some of these drawback. Hydrogenation of isoprene structure presents a

rather difficult case for diene polymers because the isoprenyl groups, which constitute the rubber macromolecules, are analogous to derivatives of a tri-substituted olefin; consequently, the hydrogenation rate is expected to be slower than for di- or mono-substituted olefinic units due to steric constraints. The hydrogenation process effectively changes the natural rubber structure to an alternating ethylene-propylene copolymer as shown in Figure 2.9.

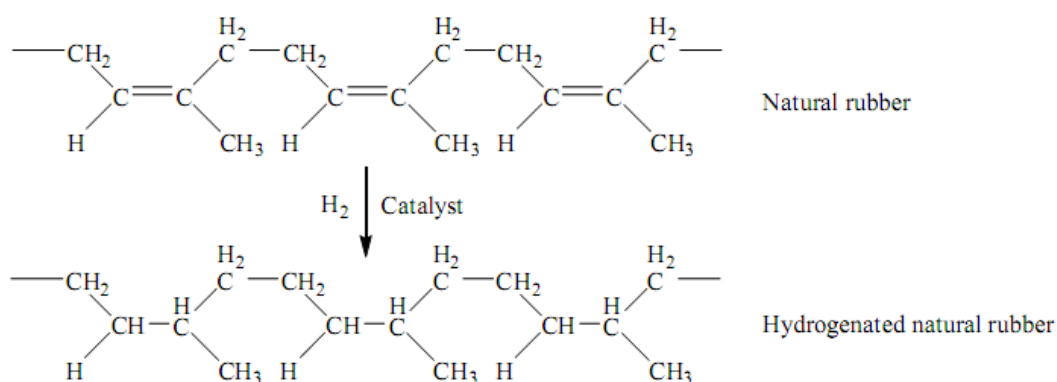

Figure 2.9 General structure of natural rubber before and after hydrogenation process [22]

2.6 Polymer Blends [27]

From the definition of polymer blend, polymer blend is any physical mixture of two or more different polymers that are not connected by covalent bonds. The development of a novel polymeric materials to meet a specific need is a lengthy and costly enterprise. If the desired properties can be realized simply by mixing two or more existing polymers, there is an apparent economic advantage. The characterization of polymer blends can be achieved by their phase behavior as being either miscible or immiscible. Miscible blends have the properties of mixtures in only one homogeneous phase; nevertheless, immiscible blends show multiple amorphous phases. Therefore, miscibility of polymer blends influences the mechanical, thermal, rheological and other properties of a polymer blends.

From thermodynamic theory, the miscibility of the polymer mixture is associated with the negative value of the free energy of mixing (ΔG_m). For polymeric

system, ΔG_m is approximately equal to the enthalpy of mixing (ΔH_m) as the change in entropy (ΔS_m) is relatively small. Miscible blend has a single phase. However, the immiscible polymer blend is a polymer mixture in which constituents from separate phases; therefore, immiscible blend is associated with the positive value of the Gibb's free energy of mixing ($\Delta G_m = \Delta H_m > 0$).

$$\Delta G_m < 0$$

The compatibilizers can be principley interacted in the complex ways to influence final blend properties. The first effect of compatibilizers is reducing the interfacial tension in the melt, causing an emulsifying effect and inducing to extremly fine dispersion of one phase in another. The second effect is the increasing the adhesion at phase boundaries for improvement stress transfer. The third effect is stabilization the dispersed phase against crystal growth during annealing, against by modifying the phase-boundary interface.

The modification of blend properties to produce a desirable properties can be used, such as (a) addition of block or graft copolymer, (b) addition of functional/reactive polymer and (c) in situ grafting/polymerization (reactive blending).

a) Addition of block or graft copolymer

The most extensively method approach to compatibilization of polymer blend is addition of block or graft copolymer. The investigation of block copolymer is frequently more than the graft copolymer and especially its contain blocks chemically same as the blend polymers component. It is possibly not surprising that block and graft copolymer are composed of chemically segments same as the blend component which are evident choices of compatibilizers, so the miscibility between the copolymers segments and the corresponding blend components is assured.

b) Addition of functional polymers

Several researcher have described the compatibilizer by addition of functional polymers that a chemically polymer identical to the one component of blends is modified to contain functional group, which have some affinity for the second blend

component. This feature allows the modified blend component react easily with the second blend component. This method can be achieved in a reactor or by an extrusion modification process. For example, the grafting of maleic anhydride similar component onto polyolefins backbone results the carboxylic group having the ability to form a chemical bonding with the terminal amino group of polyamides [28].

c) Reactive blending

Reactive blending is the new method for producing the compatible thermoplastic blends, which relies on the formation of in situ copolymers or interacted polymers. This technique is different from other compatibilization technique in that its blend components are either chosen or modified, and the reaction occurs during the melt blending with not required the addition of compatibilizer. This technique is usually founded in chemical application. For example, the blend of polyamides and grafted polyolefin elastomer with functional group. The graft-functionalized elastomer was produced by melt modification that are commercially available for toughening nylons.

There are several methods for blending the different polymers to obtain the desirable properties such as, mechanical blending, solution blending, mechano-chemical blending, latex blending and chemical blending [29]. Each method generates different shear forces resulting the dissimilarity of morphology of the blends. Usually, the size of dispersed polymer is reduced with increasing mixing time and severity of mixing. In addition, types of mixing instrument must be considered because it provides the different shear stress and polymer flow rate during mixing process [30].

2.7 Literature Reviews

Graft Copolymerization of Natural Rubber

Arayaprane et al. [1] studied the graft copolymerization of 50/50 (w/w) styrene/methyl methacrylate mixtures onto natural rubber seed latex by using cumene hydroperoxide/sodium formaldehyde sulfoxylate dihydrate/EDTA-chelated Fe^{2+} as a redox initiator. The effects of the process parameters such as the amount of initiator,

emulsifier, and chain-transfer agent, monomer-to-rubber ratio, and temperature on the grafting efficiency (GE) and grafting level (GL) were reported. It was found that both the grafting efficiency and grafting level increased with an increase in the concentration of initiator up to 2 phr. The grafting yield increased with increasing temperature up to 70 °C and then decreased, suggesting that the self-combination of a large amount of free radicals which produced at higher temperature. The emulsifier amount had a small effect on grafting styrene and methyl methacrylate onto NR. The grafting efficiency decreased as monomer-to-rubber ratio increased, indicating that the graft copolymerization occurred on the surface of the latex particles. The grafting decreased as the amount of chain-transfer agent increased because of the decrease of macroradical formation.

Suriyachai et al. [31] studied the graft copolymerization of glycidyl methacrylate and styrene onto natural rubber using cumene hydroperoxide and tetraethylene pentamine as a redox initiator. The effects of initiator and monomer concentration, reaction temperature and reaction time on grafting efficiency and monomer conversion were investigated. The optimum condition for the preparation of grafted natural rubber was found to be at the monomer concentration of 100 phr, the initiator concentration of 2.5 phr and temperature of 60 °C for 10 hours. The grafted natural rubber product could be used as a compatibilizer for STR5L/PMMA blends. The mechanical properties such as tensile strength, elongation at break, tear strength, hardness and impact energy were evaluated as a function of grafted natural rubber content. The good mechanical properties of unvulcanized and vulcanized STR5L/PMMA blends were obtained at 5-10 phr of grafted natural rubber content. The mechanical properties of grafted natural rubber/PMMA blends were also studied. The tensile strength, tear strength and hardness increased with increasing of PMMA content. The tensile fracture surface examined by scanning electron microscopy showed that the grafted natural rubber acted as an interfacial agent and gave a good adhesion between the two phases of blend.

Kochthongrasamee et al. [32] also studied the effects of redox initiator on graft copolymerization of MMA onto NR. The graft copolymerization of MMA onto NR using CHPO/TEPA, *t*-BHPO/TEPA and potassium persulfate/sodium thiosulfate ($K_2S_2O_8/Na_2S_2O_3$) as redox initiator, it was found that CHPO dissolved very well in

the oil phase and TBHPO dissolved moderately in the oil-phase, while $K_2S_2O_8/Na_2S_2O_3$ initiation performed in the water-phase. The grafted poly(methyl methacrylate) stayed on the surface of rubber particles. Moreover, CHPO/TEPA was found to enhance grafting efficiency. Percentages of grafting of MMA on NR latex initiated by CHPO/TEPA was 84.4%. CHPO/TEPA was thus a better redox system for grafting of MMA monomer on natural rubber latex.

Kongparakul et al [33] studied the preparation of modified natural rubber latex by graft copolymerization with methyl methacrylate and hydrogenation using $OsHCl(CO)(O_2)(PCy_3)_2$ as a catalyst. The graft copolymerization of methyl methacrylate onto natural rubber (NR) was carried out by using cumene hydroperoxide as redox initiator. The monomer conversion, grafting efficiency, and graft copolymer composition were examined. The purified graft copolymer was then hydrogenated by using a homogeneous osmium catalyst, $OsHCl(CO)(O_2)(PCy_3)_2$. Hydrogenation of grafted NR exhibited a first-order dependence on catalyst concentration, implying that the active complex is mononuclear.

Kongparakul et al [2] studied the catalytic hydrogenation of styrene-g-natural rubber (ST-g-NR) in the presence of $OsHCl(CO)(O_2)(PCy_3)_2$. ST-g-NR was synthesized via emulsion polymerization using CHPO/TEPA as initiator. $OsHCl(CO)(O_2)(PCy_3)_2$ was found to be an effective catalyst for hydrogenation of ST-g-NR in monochlorobenzene. From kinetic results, the hydrogenation of ST-g-NR exhibited a first-order dependence on $[C=C]$. The addition of acid could promote the hydrogenation rate of the ST-g-NR. The apparent activation energy over the range of 120–160 °C was found to be 83.3 kJ/mol. The hydrogenation could improve the thermal stability of grafted natural rubber without affecting its glass transition temperature.

Diimide Hydrogenation

Wideman [34] discovered diimide hydrogenation of acrylonitrile-butadiene rubber (NBR) in latex form. This technique could be produced the diimide species by the oxidation of hydrazine hydrate/hydrogen peroxide, and copper ion was used as a catalyst without using any pressure vessel, organic solvent or hydrogen gas. The result

showed that 80% degree of hydrogenation was achieved for NBR latex. However, it was also found that for natural rubber latex, only 25% hydrogenation degree was achieved at 100 °C in 3 h.

Parker et al. [35] studied the process for the preparation of hydrogenated rubber. The mechanism of diimide hydrogenation of nitrile-butadiene rubber (NBR) latex was proposed. The diimide hydrogenation occurred at the surface of the polymer particles. Carboxylated surfactants adsorbed at the latex particle surface played an important role by forming hydrazinium carboxylates with hydrazine and copper ions. Then, the generated diimide intermediates were stabilized by Cu and effectively reduced the C=C bond.

Mahittikul et al [3] studied diimide hydrogenation of natural rubber latex (NRL) and found that natural rubber latex could be hydrogenated to a strictly alternating ethylene-propylene copolymer using diimide reduction system. The diimide reduction technique of NRL was accomplished by using hydrazine hydrate/hydrogen peroxide and Cu^{2+} as catalyst, it was found that 67.8% hydrogenation was achieved within 6 h at 55 °C and a low rubber concentration and a high hydrazine concentration provided the optimum condition. Moreover, it was found that cupric acetate was a highly active catalyst for the reaction and the addition of a controlled amount of gelatin demonstrated a beneficial effect on the degree of hydrogenation; whereas, sodium dodecyl sulfate (SDS) acted as a stabilizer of the latex particle in the reaction system and reduced the degree of hydrogenation. In the presence of SDS, a longer reaction time and a higher amount of hydrazine hydrate was required for hydrogenation of NRL. Gel formation during hydrogenation did not significantly affect the degree of hydrogenation. Gel inhibitors such as hydroquinone also decreased the degree of hydrogenation.

Simma et al [25] studied the preparation of the hydrogenated skim natural rubber latex (SNRL) by using the diimide reduction technique. The optimum hydrogenation condition was achieved at a hydrazine: hydrogen peroxide of 1.6:1 and a low copper sulfate concentration of 49.5 mM. The hydrogenation rate was found to exhibit a first order behavior with respect to C=C concentration and the apparent activation energy of the catalytic and non-catalytic hydrogenation of SNRL over the range of 60–80 °C was found to be 9.5 and 21.1 kJ/mol, respectively. The

hydrogenation level increased with successive treatments of hydrogenation. From TEM micrographs, the nonhydrogenated core and hydrogenated outer layer of latex particle were fit to the layer model. The increase in the decomposition temperature of hydrogenated SNR indicated that diimide hydrogenation increased the thermal stability of SNR. The HSNR/NR vulcanizates at all blend ratios exhibited the highest retention of mechanical properties after aging due to the high saturation level and the formation of zinc-dimethyldithiocarbamate as efficient antioxidant. The HSNR/NR vulcanizates at various blend ratios had high resistance to surface cracking caused by ozone.

CHAPTER III

EXPERIMENTAL

3.1 Chemicals

i) Graft Copolymerization of Styrene Monomer onto Natural Rubber Latex

Natural rubber latex (NRL) with 60% dry rubber content (DRC), commercial high-ammonia natural rubber latex was purchased from Thai Rubber Biotechnology Ltd. (Bangkok, Thailand). Reagent-grade styrene monomer (purity 99%; Aldrich), the emulsifier, sodium dodecylsulfate (SDS, purity 98%; Aldrich), the stabilizer, isopropanol, the buffer, potassium hydroxide (KOH; Aldrich), the redox initiator system, cumene hydroperoxide (CHPO, purity 80%; Aldrich) and tetraethylene pentamene (TEPA, purity 90%; Aldrich), anhydrous sodium sulfate (Na_2SO_4 ; Fisher Scientific), formic acid (CH_2O_2 ; MERCK), petroleum ether (PE; Mallinckrodt Chemicals) and methyl ethyl ketone (MEK; QReCTM) were purchased from Earth Chem. (Bangkok, Thailand).

ii) Hydrogenation of Natural Rubber Latex and Styrene Grafted Natural Rubber Latex (H(PS-g-NR))

Styrene grafted natural rubber latex (PS-g-NR) and de-ionized water were used in all diimide hydrogenation experiments. Cupric sulfate ($\text{CuSO}_4 \cdot 5\text{H}_2\text{O}$; MERCK) and boric acid (H_3BO_3 ; QReCTM) as catalyst, hydrazine hydrate (N_2H_4 ; Merck), hydrogen peroxide (30% aqueous solution; Merck), d-chloroform for NMR analysis (CDCl_3 ; Merck), anti foaming agent silicone oil was purchased from Ajax Finechem (Auckland, New Zealand). Ethanol 95% used as coagulation agent was purchased from Earth Chem (Bangkok, Thailand).

iii) Preparation of Blends of acrylonitrile-butadiene-styrene (ABS) and hydrogenated products.

Acrylonitrile-butadiene-styrene (ABS; SR 101, extrusion grade) pellets was supplied by Integrate Refinery Petrochemical Complex (IRPC) public company limited.

3.2. Graft Copolymerization of Natural Rubber Latex (NRL).

i) Purification of Styrene Monomer

For removal of the inhibitor, styrene monomer (b.p. 145.2 °C/760 mmHg) was extracted with 10% sodium hydroxide solution and washed with de-ionized water until neutral, and then dried with anhydrous Na₂SO₄, the obtained pure styrene was stored in a refrigerator before used.

ii) Graft Copolymerization of Styrene onto NRL

The PS-*g*-NR latex was prepared by emulsion graft copolymerization. The apparatus setup is shown in Figure 3.1. NRL (50 g, 60% DRC) was charged into a 500-mL-four-necked glass reactor containing 100 mL of de-ionized water. The glass reactor was equipped with stirrer, condenser and nitrogen gas inlet. About 0.5 phr of potassium hydroxide (0.5 parts per 100 parts of dry rubber content, by weight) and 1 phr of sodium dodecylsulfate were then added. The mixture was deoxygenated by purging with nitrogen gas. Isopropanol (1.5 phr) as stabilizer was added. The mixture was heated up to desired temperature, the mixture of styrene monomer and CHPO initiator (1 phr) was then added continuously for 1 h to attain swelling in the mixture, and TEPA (1 phr) was added (CHPO:TEPA = 1:1). The reaction was stirred for 8 h under nitrogen atmosphere to complete the polymerization.

The latex product was cast on glass plate at room temperature in open tray and then dried in vacuum at 40 °C until constant weight. Final graft NR was extracted in a soxhlet apparatus using petroleum ether and ethyl methyl ketone as solvent. After

each extraction, the percentage of grafted NR, free NR, grafting efficiency and total conversion were calculated. The standard recipe of used graft copolymerization is shown in Table 3.1. The schematic of graft copolymerization of styrene onto NR latex is shown in Figure 3.2.

Table 3.1 Standard recipe used for graft copolymerization

Ingredients	Quantities
NR latex (60% DRC)	50 g
% DRC	10, 15, 20, 30
Buffer (potassium hydroxide)	0.15 g
Surfactant (sodium dodecyl sulfate)	0.3 g
Stabilizer (isopropanol)	3 g
Monomer (styrene)	30 g
Redox initiator (CHPO : TEPA = 1:1)	3 g
Reaction temperature	50, 60 °C

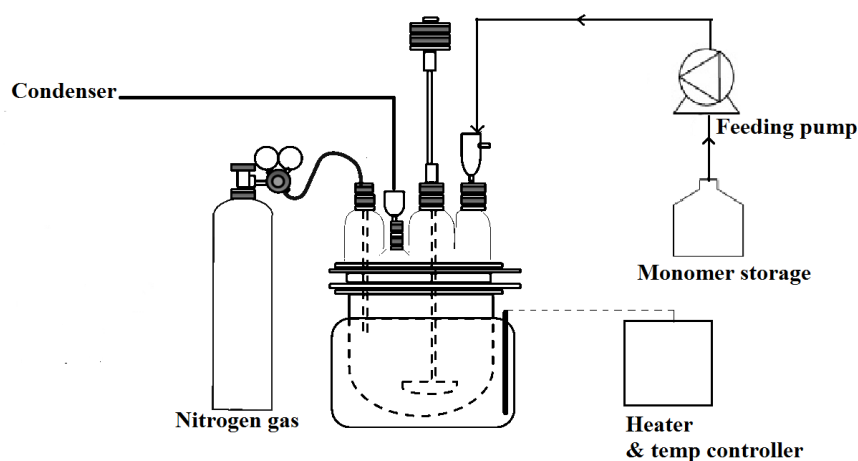

Figure 3.1 Graft copolymerization apparatus of styrene onto natural rubber latex

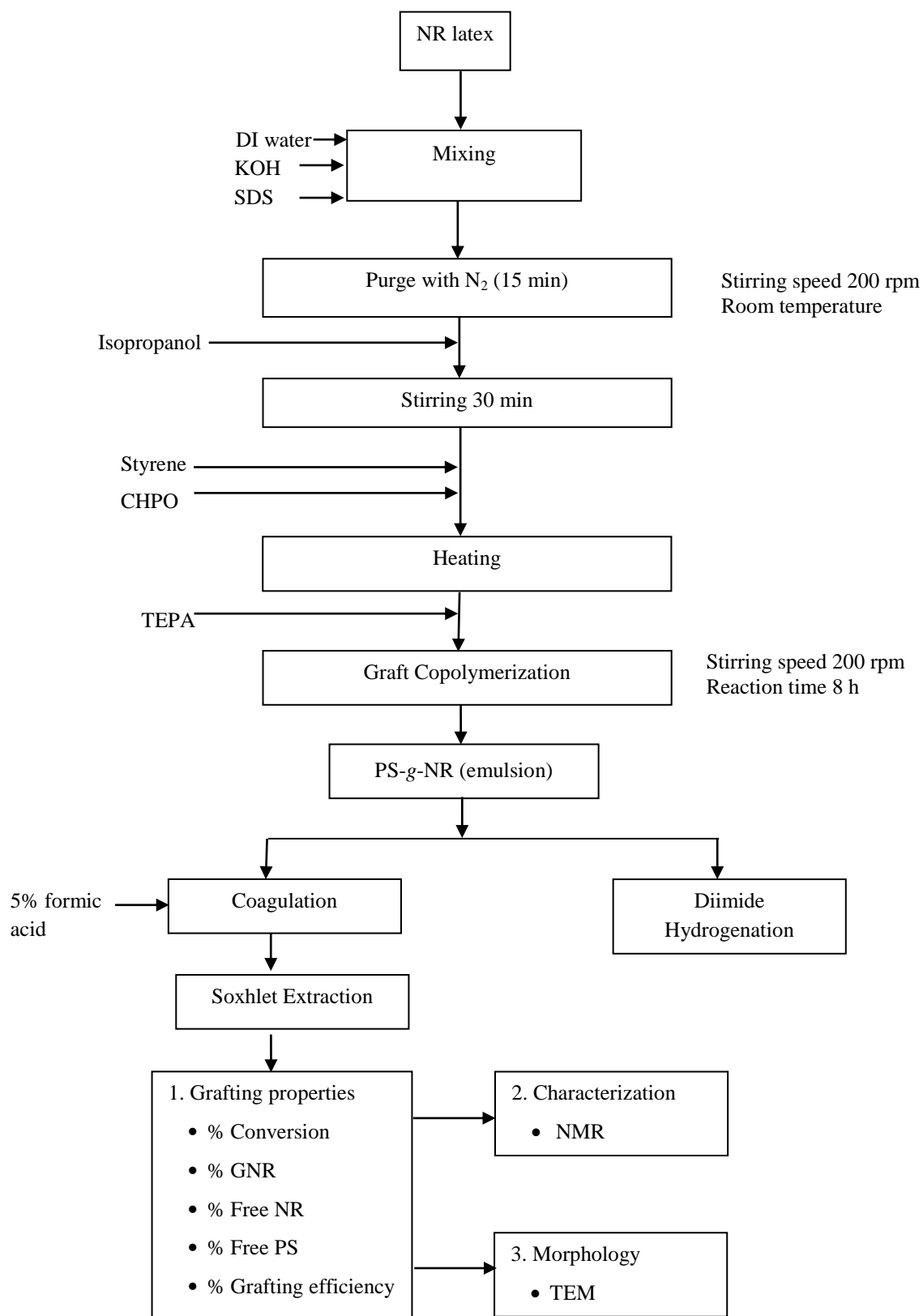

Figure 3.2 Schematic of graft copolymerization of ST onto NR latex

ii) Determination of Conversion and Grafting properties

The obtained graft natural rubber latex was cast on glass plate at room temperature in open tray and then dried in vacuum at 40 °C until constant weight. Graft product consists of three parts: grafted natural rubber (GNR), free NR (ungraft NR) and free polystyrene (PS). The grafting properties of the graft product could be determined using soxhlet extraction.

The ungrafted natural rubber was extracted using light petroleum ether (60-80 °C) for 24 h, while free polystyrene was extracted by methyl ethyl ketone (MEK) for 24 h. The dried final residue was the graft copolymer of ST onto NR backbone. The different weight between initial and extracted samples obtained from soxhlet extraction was used to determine the contents of graft copolymer, free NR and free copolymer. All grafting properties were calculated by the following Eq.

$$\text{Conversion (\%)} = \frac{\text{weight of PS in grafted copolymer}}{\text{weight of styrene monomer charged}} \times 100 \quad (3.1)$$

$$\text{Free NR (\%)} = \frac{\text{weight of free NR}}{\text{weight of gross polymer products}} \times 100 \quad (3.2)$$

$$\text{Free PS (\%)} = \frac{\text{weight of free PS}}{\text{weight of gross polymer products}} \times 100 \quad (3.3)$$

$$\text{Grafted NR (\%)} = \frac{\text{weight of grafted NR}}{\text{weight of gross polymer products}} \times 100 \quad (3.4)$$

$$\text{Grafting efficiency (\%)} = \frac{\text{weight of grafted copolymer}}{\text{total weight of polymer formed}} \times 100 \quad (3.5)$$

iv) Characterization of Grafted Natural Rubber Product

The structure of grafted products were characterized by nuclear magnetic resonance spectroscopy (¹H-NMR). ¹H-NMR spectra were obtained on the Bruker ACF 200 MHz. The samples after each extraction were dissolved in CDCl₃ at 0.01 g of rubber.

3.3. Hydrogenation

The effect of parameters on hydrogenation of NRL and PS-*g*-NR latex were investigated. In this research, three process variables, which are expected to have an effect on hydrogenation, are considered. These variables include the concentration of catalyst, hydrazine and hydrogen peroxide.

i) Hydrogenation of Natural Rubber

The natural rubber latex was charged into a 500-mL glass reactor. KOH (1 phr), catalyst and hydrazine were added, respectively and heated to the reaction temperature. Hydrogen peroxide was added drop-wise over a specific period of time. If many bubbles were formed during addition of hydrogen peroxide, small amount of silicone oil was added to minimize foaming agent. After period of reaction time, the latex mixture was post-reacted for 30 min while cooling to room temperature. The degree of hydrogenation (%) was determined by $^1\text{H-NMR}$ spectroscopy.

ii) Hydrogenation of PS-*g*-NR

The obtained grafted natural rubber latex was charged into a 500-mL glass reactor. Schematic of diimide hydrogenation apparatus is shown in Figure 3.3. KOH (1 phr), catalyst and hydrazine were added and heated to the reaction temperature. Hydrogen peroxide was added drop-wise over a specific period of time. If many bubbles were formed during addition of hydrogen peroxide, small amount of silicone oil was added to minimize foaming agent. After period of reaction time, the latex mixture was post-reacted for 30 min while cooling to room temperature. The degree of hydrogenation (%) was determined by $^1\text{H-NMR}$ spectroscopy. The standard recipe used for hydrogenation of NR and PS-*g*-NR are shown in Table 3.2 and 3.3, respectively. The schematic of diimide hydrogenation of PS-*g*-NR is shown in Figure 3.4.

Table 3.2 Standard recipe used for hydrogenation of NR

Ingredients	Quantities
NR latex (60% DRC)	10 g
Deionized water	93.2 mL
Catalysts (Cupric sulfate, Boric acid)	0.79 μ mol, 11.2 mmol
Hydrazine	0.35 mol
Hydrogen peroxide	0.79 mol
Reaction temperature	70°C

Table 3.3 Standard recipe used for hydrogenation of PS-*g*-NR

Ingredients	Quantities
PS- <i>g</i> -NR (30% DRC)	18.7 g
Deionized water	69.6 mL
Buffer (potassium hydroxide)	1 phr
Catalysts (Boric acid)	11.2 mmol
Hydrazine	0.71 mol
Hydrogen peroxide	0.79 mol
Reaction temperature	70°C

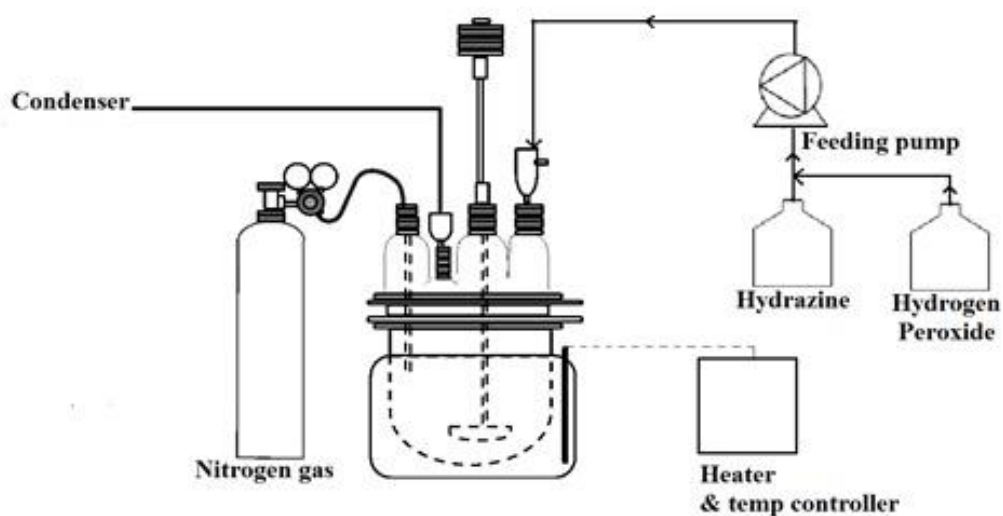
**Figure 3.3** Schematic of diimide hydrogenation apparatus

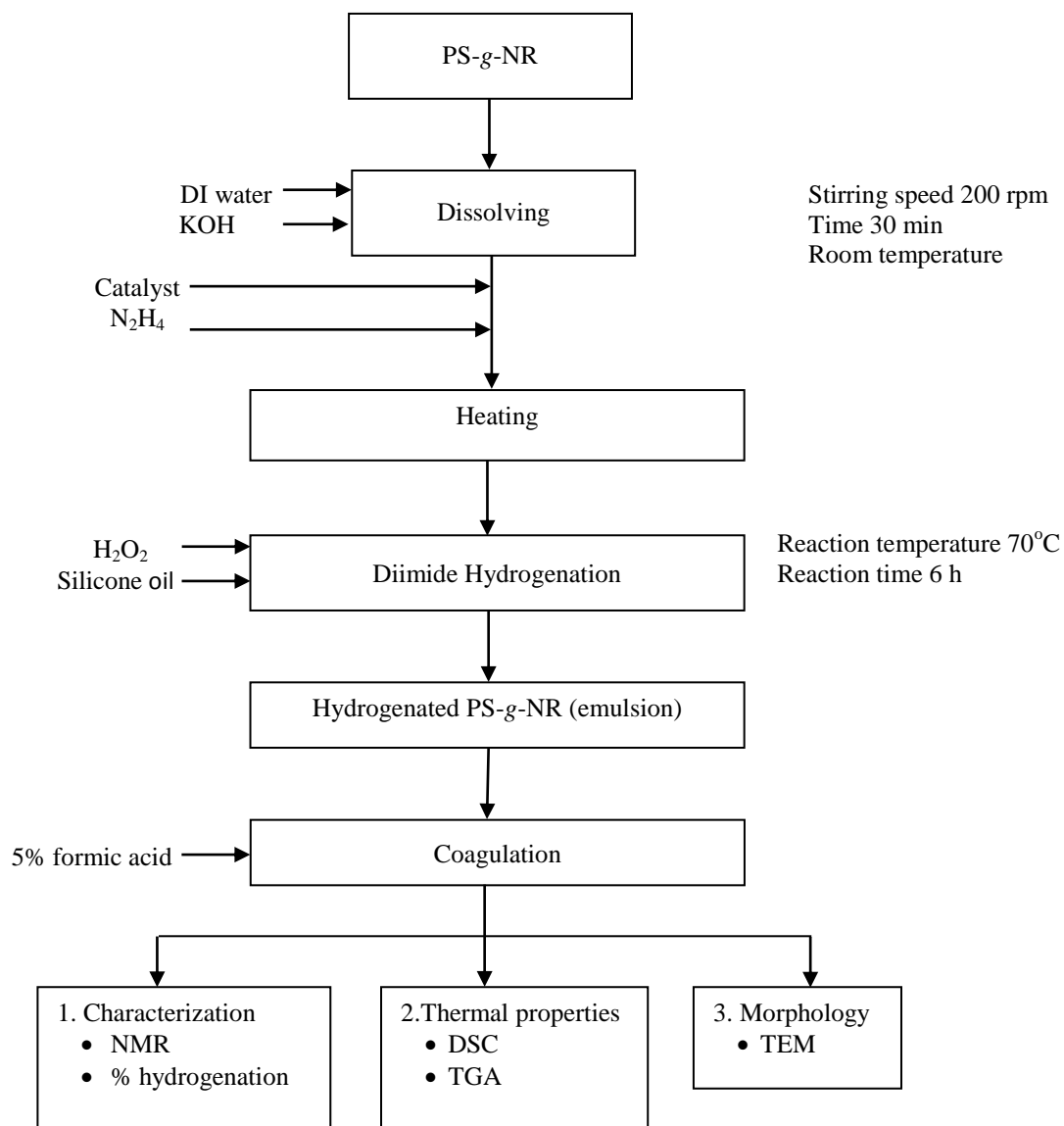

Figure 3.4 Schematic of Hydrogenation of PS-g-NR

3.4 Blending of ABS/Modified Rubbers

To study the mechanical properties of ABS/NR, ABS/PS-*g*-NR and ABS/H(PS-*g*-NR) blends, the thermoplastic blends were prepared at various ratios of ABS and all modified rubbers by a melt-mixing system. The ABS pellets were fed into the chamber for 3 min and then blended with the modified NR for 12 min. All samples (200 g/batch) were blended at 80 rpm of rotor speed and The mixing-roll temperature was kept constant at 190 °C. The conditions of blending are given in Table 3.4. The mixed compounds were kept at room temperature for 24 h. Then, these compounds were cut to pellets by crusher machine and were pressed by a compression-molding machine at 190 °C and a pressure of 120 kg/cm² for 13 min.

Table 3.4 Blend conditions of ABS/modified NR blends.

Blends	Blends ratio (w/w)			
	ABS	NR	PS- <i>g</i> -NR	H(PS- <i>g</i> -NR)
ABS	100	-	-	-
ABS/NR	95	5	-	-
	90	10	-	-
	80	20	-	-
ABS/PS- <i>g</i> -NR	95	-	5	-
	90	-	10	-
	80	-	20	-
ABS/H(PS- <i>g</i> -NR)	95	-	-	5
	90	-	-	10
	80	-	-	20
	70	-	-	30

3.5 Characterization

¹H-NMR Analysis

The structure of the rubbers and degree of hydrogenation (%) of hydrogenated samples was determined by Nuclear Magnetic Resonance Spectroscopy (¹H-NMR). The ¹H-NMR spectra were recorded by ¹H-NMR Bruker 300 MHz spectrometer using CDCl₃ as a solvent.

The degree of hydrogenation (%) of hydrogenated samples was calculated from ¹H-NMR spectra by the change in the integral of the peaks representing protons for the hydrogenated rubber latex. The integral of the peak area for the saturated protons (-CH₂- and -CH₃) in the range of 0.8-2.3 ppm and the unsaturated protons peak area around 4.5-5.2 ppm were measured to calculate % hydrogenation using Eq. (3.6).

$$\text{Degree of hydrogenation (\%)} = \frac{A}{A + B + C} \times 100 \quad (3.6)$$

Where A is the peak area of saturated protons and B and C are the peak area of unsaturated protons.

3.6 Thermal Properties

i) Thermogravimetric Analysis (TGA)

Thermogravimetric analysis (TGA) of the sample was performed on Perkin-Elmer Pyris Diamond TG/DTA and TGA thermograms were recorded at the heating rate of 10 °C per minute in the nitrogen environment from room temperature to 900 °C. The initial decomposition temperature (T_{id}) and the temperature at the maximum mass loss rate (T_{max}) were evaluated. The T_{id} was evaluated from the the intersection of the tangent at the onset of the decomposition process. The T_{max} of each sample was obtained from the peak maxima of the derivative of TG curves.

ii) Differential Scanning Calorimetry (DSC)

The glass transition temperature (T_g) of grafted and hydrogenated samples were obtained from a Mettler Toledo DSC 822 differential scanning calorimeter (DSC). The sample in aluminium pan was cooled down to $-100\text{ }^\circ\text{C}$ with a liquid nitrogen and then heated up to $40\text{ }^\circ\text{C}$ with a constant heating rate of $10\text{ }^\circ\text{C}/\text{min}$ under nitrogen atmosphere. The glass transition temperature (T_g) was obtained from the midpoint of the baseline shift of DSC thermogram.

3.7 Morphological Study

Observation of the morphology of the modified rubbers was made with a JEOL JEM 2010 transmission electron microscope (TEM). A small amount of latex sample was dispersed in water and dropped on the grid. The thin sections of samples were stained with OsO_4 vapor for 24 h before observation.

3.8 Mechanical Properties of ABS/Modified Rubber Blends

The mechanical properties of ABS, ABS/NR, ABS/PS-*g*-NR and ABS/H(PS-*g*-NR) blends were measured by following the ASTM test methods.

i) Tensile Properties (ASTM D 638) [36]

The tensile properties of ABS/rubbers before and after thermal aging at $165\text{ }^\circ\text{C}$ for 25 min were measured in terms of tensile strength and elongation at break. The test is made by gripping ends of dumbbell-shaped test pieces (Type I) with 12 mm of original gauge length. The specimens are illustrated in Figure 3.5. The specimens were cut from a 3.0 mm thick sheet and the average of five specimens was considered as the representative value. The tensile test of all blends samples was carried out on a Universal testing machine (LLOYD Instrument LR 10K Plus) at $10\text{ mm}/\text{min}$ of a crosshead speed.

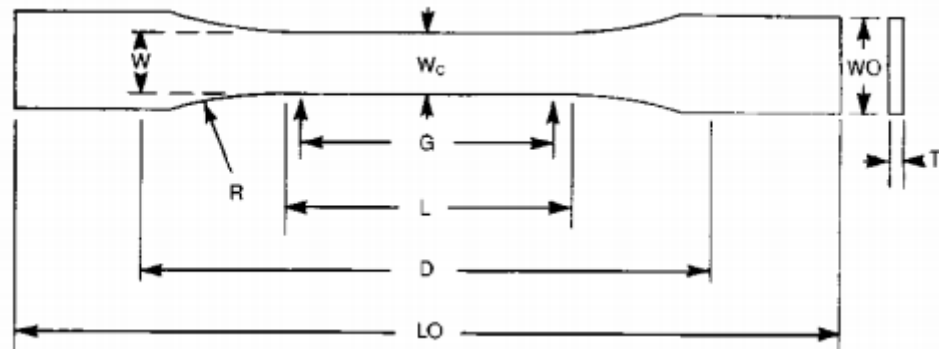

W : 13 mm	WO : 19 mm	G : 50 mm	R : 76 mm
L : 57mm	LO : 165 mm	D : 115 mm	T : 4 mm or under

Figure 3.5 Schematic diagram of tensile test specimen (type I) [36]

ii) Impact Strength (ASTM D 256) [37]

The test specimen is conformed to the dimensions and geometry of Figure 3.6. The machine used in the present investigation was Izod-Charpy Impact Tester (Impact tester GOTECH GT 7045). The width of each specimen was measured in the region of the notch with a micrometer caliper and recorded its average width along with its identifying marking. The test specimen was put in a horizontal position so that it would be impacted edgewise at its center on the face opposite the notch for notched specimens. The breaking energy of the specimen was estimated and a pendulum of suitable energy was selected. The pendulum was released and the excess energy remaining in the pendulum was recorded after breaking the specimen, together with a description of the appearance of a broken specimen. The average impact energy was calculated in the group of specimens.

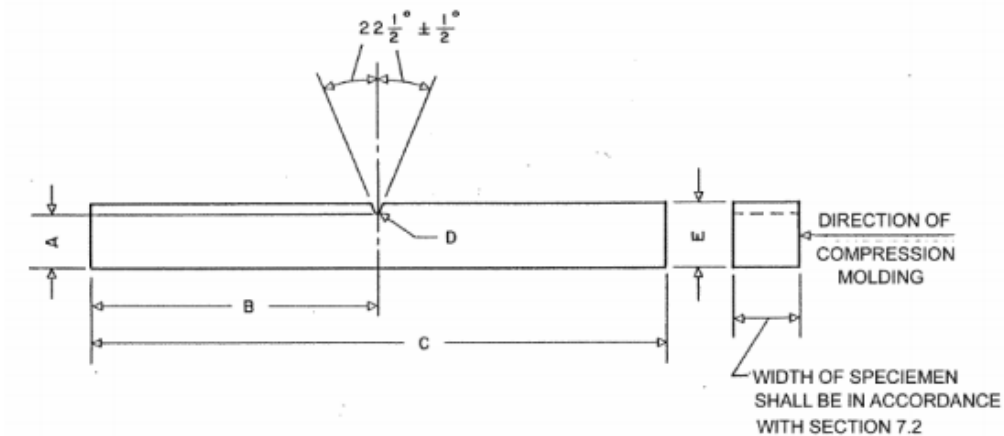

Unit : mm

A : 10.16 ± 0.05

D : 0.25 ± 0.05

B : 31.8 ± 1.0

E : 12.70 ± 0.20

C : 63.50 ± 2.0

Figure 3.6 Dimensions of simple beam, Charpy type, impact test specimen [37].

iii) Hardness (ASTM D 785) [38]

The hardness was measured by Durometer Shore-type-D at room temperature. The test specimen had a minimum thickness of 6 mm. The specimen was a piece cut from a molding sheet. Care was taken that the test specimen had parallel flat surface to ensure good seating on the anvil and thus avoid the deflection that would be caused by poor contact. The specimen was at least 25 mm square if cut from sheet. The minimum width was 13 mm plus the width of the indentation resulting from the conduct of a test using the chosen indenter.

3.9 Morphological Study of ABS/Modified Rubber Blends

The morphology of the ABS/modified rubber blends from the tensile properties test was observed by a scanning electron microscope (Jeol JSM-6400 SEM) at an accelerating voltage of 15 kV and a magnification of 500. All the samples were fractured after immersion in liquid nitrogen for about 10 min. The fracture surface was then coated with a thin layer of gold.

CHAPTER IV

RESULTS AND DISCUSSION

The modified natural rubbers were prepared by the graft copolymerization of styrene (ST) onto natural rubber latex and the diimide hydrogenation. The graft natural rubber (PS-*g*-NR) was prepared by emulsion copolymerization using redox system of cumene hydroperoxide (CHPO)/tetraethylene pentamine (TEPA) as initiator. The grafting efficiency and percentage graft copolymer of the graft NR were determined. The graft NR was also characterized by ¹H-NMR. For hydrogenation of graft NR in latex form using diimide reduction, the diimide species in this system was produced via redox reaction between hydrogen peroxide and hydrazine. The degree of hydrogenation (HD) of hydrogenated graft NR (H(PS-*g*-NR)) was determined by Nuclear Magnetic Resonance Spectrometer (NMR). The hydrogenated graft NR was blended with ABS using internal mixer. The influential factors of the modified rubber content were investigated. The mechanical properties, thermal properties and morphology of ABS/H(PS-*g*-NR) blends were investigated.

4.1 Graft Copolymerization of Styrene onto Natural Rubber Latex

The graft copolymer of styrene onto natural rubber was prepared by emulsion polymerization using redox system of cumene hydroperoxide (CHPO)/tetraethylene pentamine (TEPA) as initiator at 50-60 °C for 8 h.

4.1.1 Characterization of Graft Natural Rubber Latex

To determine the presence of the graft NR, the products were extracted by petroleum ether and MEK, respectively. After the solvent extraction, the graft copolymer was analyzed by ¹H-NMR. Figure 4.1a and 4.1b illustrate the ¹H-NMR spectrum of natural rubber and graft natural rubber, respectively. The two major peaks at 1.64 and 2.01 ppm are assigned corresponding to the natural rubber structure. The

peak at 5.15 ppm is assigned to the *cis*-olefinic proton ($-\text{HC}=\text{CH}-$) in the natural rubber. The signals at 6.5–7.5 ppm are attributed to the peaks of aryl protons within the PS graft chains. Thus, the ^1H -NMR indicated that styrene was grafted onto natural rubber in this emulsion polymerization.

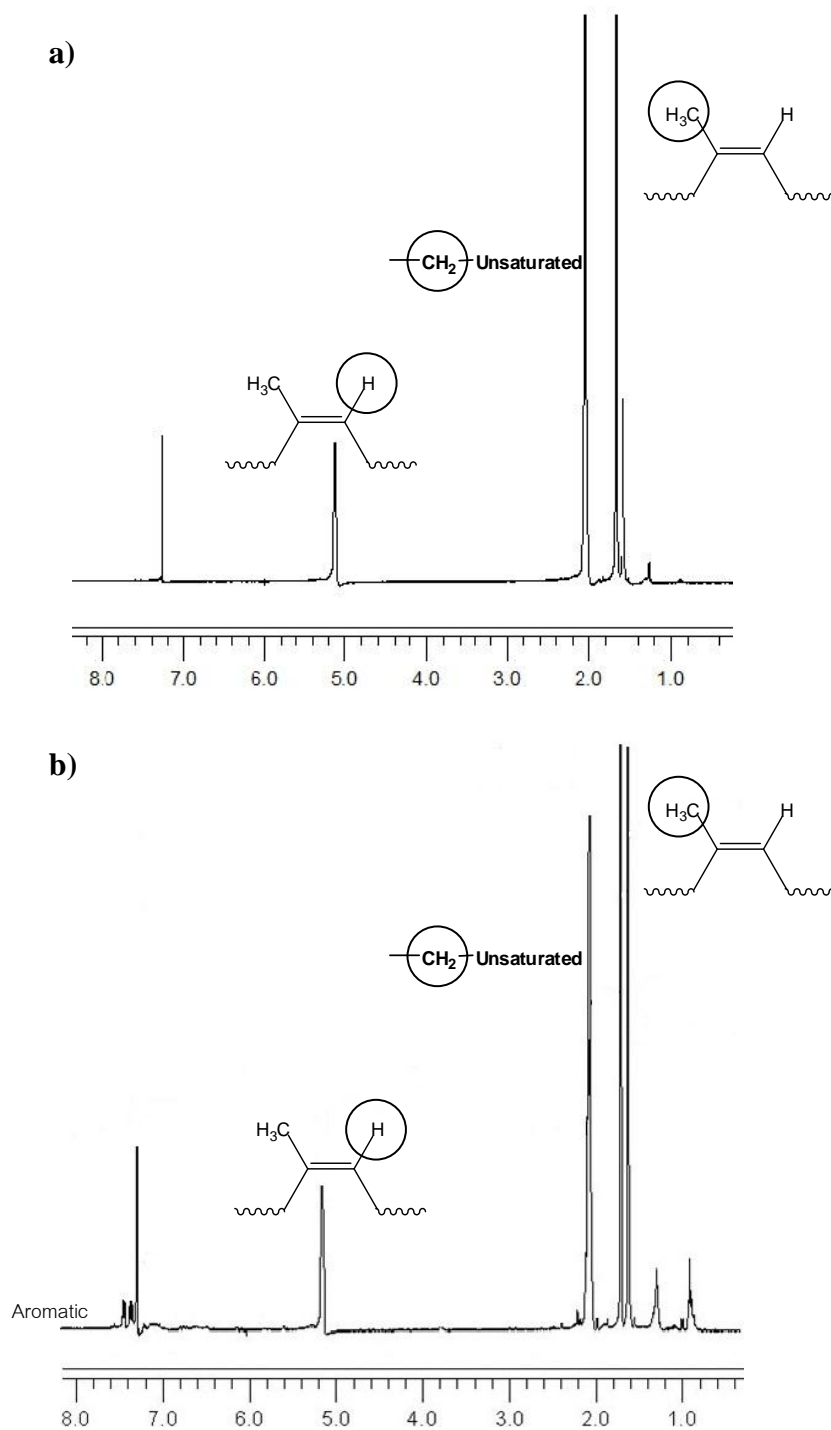

Figure 4.1 ^1H -NMR spectra of a) NR and b) PS-g-NR

4.1.2 Effect of DRC and Temperature on Graft Copolymerization of NRL

The results of graft copolymerization of styrene onto NR using emulsion polymerization technique are presented in the Table 4.1. The PS-*g*-NR product consisted of 69.0-82.3% graft NR, 8.8-24.3% free NR and 6.6-16.6% free PST depending on temperature and DRC. The styrene conversion and grafting efficiency (GE) were 36.5-61.7% and 56.4-81.5%, respectively.

The effect of DRC on the monomer conversion and grafting properties was studied in the range of 10 to 30% DRC at reaction temperature of 50 and 60 °C. The experiments were performed when the initiator concentration of 1 phr, the SDS concentration of 1 phr and a reaction time of 8 h were kept constant. From Figure 4.2 and 4.3, the conversion decreased with decreasing dry rubber content (or increasing water content). This result may be explained by the decrease in the latex viscosity by addition of water. At higher DRC, the viscosity of NRL was appropriate for transfer of styrene to graft onto the rubber particles.

Table 4.1 Effect of DRC and temperature on graft copolymerization of NRL

Exp.	Wt of NRL (g)	Temp (°C)	DRC (%)	Conv (%)	Grafting properties			GE (%)
					Graft NR (%)	Free NR (%)	Free PST (%)	
PS- <i>g</i> -NR_1	50	50	10	37.9	81.5	11.4	7.2	73.9
PS- <i>g</i> -NR_2	50	50	15	42.1	81.7	11.4	6.8	76.9
PS- <i>g</i> -NR_3	50	50	20	54.7	74.0	19.5	6.6	81.5
PS- <i>g</i> -NR_4	50	50	30	53.0	69.0	24.3	6.8	80.5
PS- <i>g</i> -NR_5	50	60	10	40.0	79.1	13.2	7.7	72.9
PS- <i>g</i> -NR_6	50	60	15	43.9	79.1	13.6	7.4	75.8
PS- <i>g</i> -NR_7	50	60	20	36.5	82.3	11.1	6.6	75.5
PS- <i>g</i> -NR_8	50	60	30	50.7	74.2	14.1	11.7	65.3
PS- <i>g</i> -NR_9	100	50	30	50.4	76.9	8.8	14.4	57.1
PS- <i>g</i> -NR_10	100	60	30	61.7	73.0	10.4	16.6	56.4

Condition: Initiator = 2 phr, monomer-to-rubber ratio = 1:1, time = 8 h.

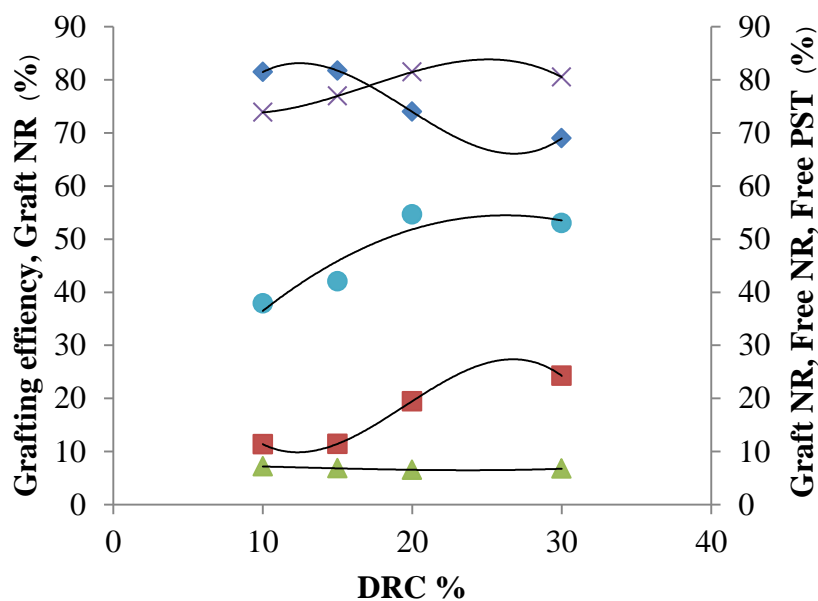

Figure 4.2 Effect of DRC (%) on conversion (●), graft NR (◆), free NR (■), free ST (▲) and grafting efficiency (×).

Condition : Initiator = 2 phr, monomer-to-rubber ratio = 1:1, $T = 50\text{ }^{\circ}\text{C}$

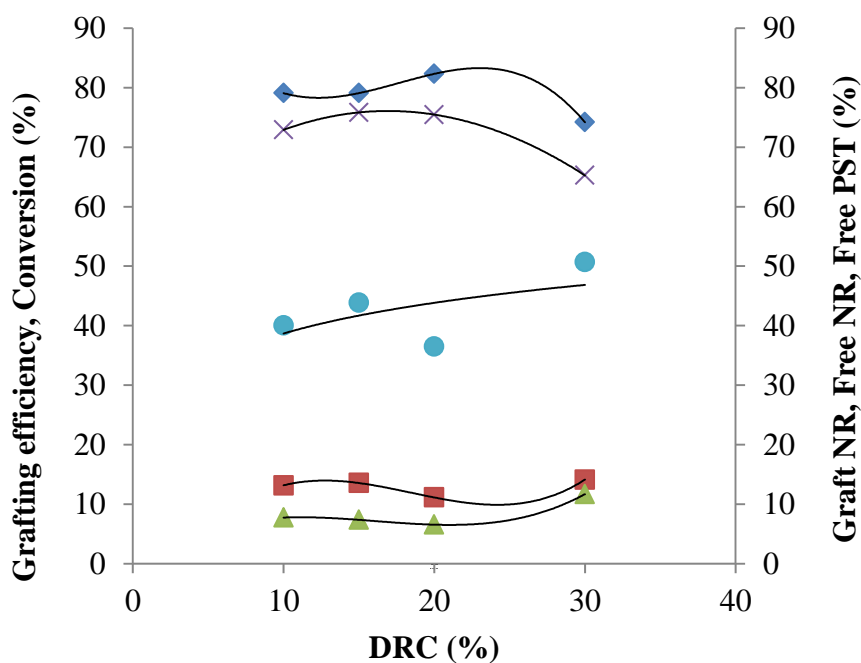

Figure 4.3 Effect of DRC (%) on conversion (●), graft NR (◆), free NR (■), free ST (▲) and grafting efficiency (×).

Condition : Initiator = 2 phr, monomer-to-rubber ratio = 1:1, $T = 60\text{ }^{\circ}\text{C}$

The effect of reaction temperature on the monomer conversion and grafting properties was studied at 50 min and 60 °C. The experiments were performed when the initiator concentration of 1 phr, the SDS concentration of 1 phr and reaction time of 8 h were kept constant. From Figure 4.2 and 4.3, the increase in the reaction temperature in the range of 50-60 °C did not significantly affect conversion and the grafting properties of PS-g-NR. Arayaprane [1] also suggested that for graft copolymerization of MMA and ST onto NR, the grafting properties of graft NR increased with increasing temperature up to 70 °C and then decreased, because a large amount of free radicals produced at higher temperature may combine by themselves.

4.1.3 Properties of Graft Natural Rubber Latex

The graft natural rubber (PS-g-NR) was prepared by emulsion graft copolymerization. From Table 4.1, the highest conversion (61.7%) was achieved at 30% DRC, 1 phr of sodium dodecyl sulfate (SDS) as an emulsifier, 10 phr of isopropanol as a stabilizer, 1 phr of potassium hydroxide as a buffer, and 1 phr of redox initiator (CHPO: TEPA ratio 1: 1) and temperature of 60 °C for reaction time of 8 h. The properties of PS-g-NR are presented in Table 4.2. This PS-g-NR prepared at this appropriate condition was used as substrate material for subsequent diimide hydrogenation.

Table 4.2 Properties of graft natural rubber

Properties	%
Total conversion (%)	61.7
Grafting efficiency (%)	56.4
Grafting properties	
Graft natural rubber (%)	73.0
Free natural rubber (%)	10.4
Free copolymers (%)	16.6

4.2 Hydrogenation of Natural Rubber Latex

4.2.1 Characterization of Hydrogenated Natural Rubber Latex

$^1\text{H-NMR}$ spectra for the non-hydrogenated natural rubber (NRL) and hydrogenated natural rubber latex (HNR) are provided in Figure 4.4. The two major peaks are attributed to the aliphatic group ($-\text{CH}_3$; 1.64 ppm and $-\text{CH}_2-$; 2.01 ppm). The signal of *cis*-olefinic proton ($-\text{HC}=\text{CH}-$) are centered at 5.15 ppm. When the degree of hydrogenation increased, *cis*-olefinic proton peaks intensity decreased and new peaks appeared at 0.8–1.8 ppm are attributed to $-\text{CH}_3$ and saturated $-\text{CH}_2-$ units. These results confirm that unsaturated carbon-carbon in NR are hydrogenated. The degree of hydrogenation (%) was calculated from the change in the integral of peaks representing protons for HNR (Appendix C).

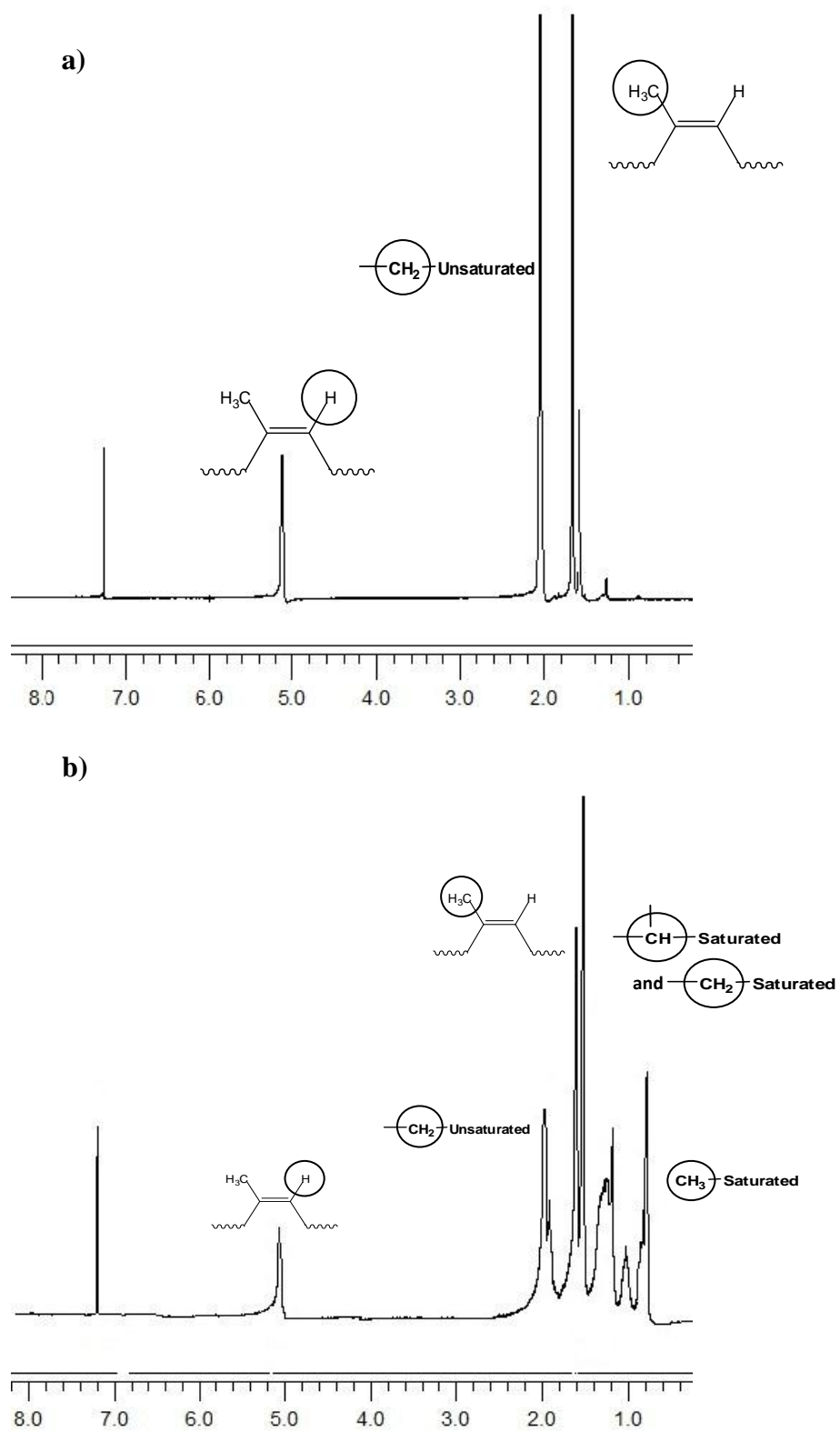

Figure 4.4 ^1H -NMR spectra of a) NR and b) HNR (HD= 51.4%)

4.2.2 Initial Study of Diimide Hydrogenation of NRL

The initial study of diimide hydrogenation of NRL using CuSO_4 as catalyst were performed, the diimide species in this system was produced by a redox mechanism between hydrazine and hydrogen peroxide. The effect of various process parameters on NRL hydrogenation was studied by varying the catalyst concentration, hydrazine concentration and hydrogen peroxide concentration. The results are summarized in Table 4.3.

Table 4.3 Effect of various parameters on hydrogenation of NRL

Rubber	CuSO_4 (μM)	N_2H_4 (M)	H_2O_2 (M)	$[\text{N}_2\text{H}_4]: [\text{H}_2\text{O}_2]$	Degree of Hydrogenation (%)
HNR_1	49.4	1.67	5.27	1: 3.2	32.8
HNR_2	49.4	2.33	5.27	1: 1.3	43.6
HNR_3	49.4	3.53	5.27	1: 1.5	42.4
HNR_4	49.4	2.33	2.80	1: 1.2	31.9
HNR_5	49.4	2.33	5.60	1: 2.4	38.3
HNR_6	82.7	2.33	5.27	1: 2.3	32.8

Condition: Total volume = 150 mL, $[\text{C}=\text{C}] = 0.55 \text{ M}$, temp = 70°C , time = 6 h.

The effect of hydrazine and hydrogen peroxide concentration on diimide hydrogenation was studied over the range of 1.67-3.53 M and 2.80-5.27 M, respectively. The hydrogenation reaction was carried out at 70°C for 6 h. The CuSO_4 concentration was $49.4 \mu\text{M}$ and $\text{C}=\text{C}$ concentration was 0.55 M. From Table 4.3, the degree of hydrogenation increased with increasing concentration of N_2H_4 and H_2O_2 . The similar result was also observed by Mahittikul et al. [3] for NR and Simma et al. [25] for skim NR.

The effect of catalyst type on the degree of hydrogenation was also investigated. The $\text{C}=\text{C}$ concentration of 0.55 M, N_2H_4 concentration of 2.33 M, H_2O_2 concentration of 5.27 M were kept constant. The reaction temperature was 70°C and reaction time was 6 h. Table 4.4 shows the effect of catalyst type on the degree of hydrogenation of NRL. Boric acid (H_3BO_3) was found to be an efficient catalyst for diimide hydrogenation of NRL. This result can be explained that the formation of H-

bond of boric acid with H_2O_2 can retard the side reaction of H_2O_2 and accelerate H_2O_2 dissociation to generate the diimide radical species resulting in the increasing diimide species and higher degree of hydrogenation could be achieved [3].

Table 4.4 Effect of Catalyst type on degree of hydrogenation (%)

Rubber	Cat.	Conc. (μ M)	Degree of Hydrogenation(%)
HNR_2	CuSO ₄	49.4	43.6
HNR_7	H ₃ BO ₃	74.7 \times 10 ³	51.4

Condition : Total volume = 150 mL, [C=C] = 0.55 M, [N₂H₄] = 2.33 M, [H₂O₂] = 5.27 M, temp = 70 °C, time = 6 h.

4.3 Hydrogenation of PS-g-NR

From Table 4.2, the graft natural rubber latex (PS-g-NR₁₀) with 73.0% graft NR, 10.4% free NR, 16.6% free PST and 56.4% GE was selected to use as substrate material for subsequent diimide hydrogenation. To study the effects of process parameters on hydrogenation level of PS-g-NR. Three parameters considered to affect the hydrogenation degree are the concentration of hydrazine (N₂H₄), hydrogen peroxide (H₂O₂) and boric acid (H₃BO₃). The results are summarized in Table 4.5

Table 4.5 Effect of process parameters on hydrogenation of PS-g-NR

Exp.	H ₃ BO ₃ (mM)	N ₂ H ₄ (M)	H ₂ O ₂ (M)	[N ₂ H ₄]: [H ₂ O ₂]	Degree of Hydrogenation (%)
1	74.7	1.27	5.27	1: 4.2	31.8
2	74.7	2.33	5.27	1: 2.3	44.1
3	74.7	4.73	5.27	1: 1.1	47.2
4	74.7	6.60	5.27	1: 0.8	41.3
5	38.8	2.33	5.27	1: 2.3	40.5
6	116.7	2.33	5.27	1: 2.3	37.0
7	155.3	2.33	5.27	1: 2.3	34.5
8	74.7	2.33	2.60	1: 1.1	36.2
9	74.7	2.33	6.60	1: 2.8	43.6
10	74.7	2.33	7.93	1: 3.4	38.9

Condition: Total volume = 150 mL, [C=C] = 0.55 M, temp = 70 °C, time = 6

4.3.1 Characterization of Hydrogenated PS-*g*-NR

The $^1\text{H-NMR}$ spectra of PS-*g*-NR and hydrogenated PS-*g*-NR (47.2% hydrogenation) are shown in Figure 4.5a and 4.5b, respectively. The two major peaks are attributed to the aliphatic group ($-\text{CH}_3$; 1.64 ppm and $-\text{CH}_2-$; 2.01 ppm). In the range of 6.5-8.0 ppm, the peaks of aryl protons within the PS graft chains appeared. The signal of *cis*-olefinic proton ($-\text{HC}=\text{CH}-$) are centered at 5.15 ppm. When the degree of hydrogenation increased, *cis*-olefinic proton peaks intensity decreased and new peaks appeared at 0.8-1.8 ppm are attributed to $-\text{CH}_3$ and saturated $-\text{CH}_2-$ units. The graft NR characterization confirms the structure of H(PS-*g*-NR) as shown in scheme 1.

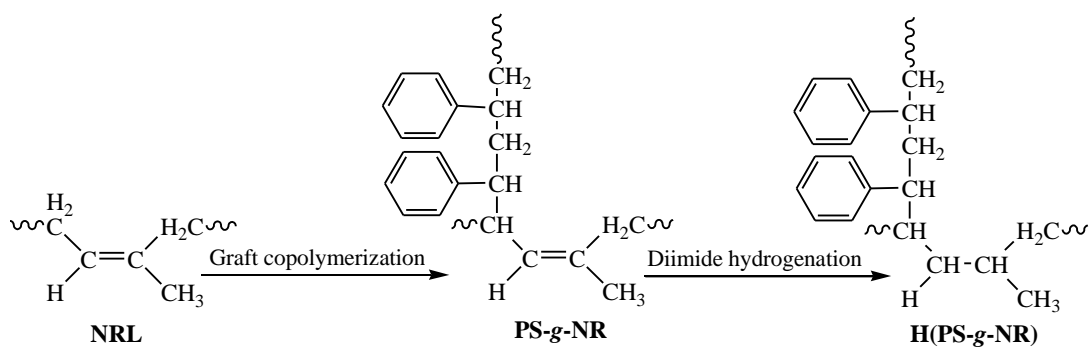

Scheme 1 Structure of PS-*g*-NR and H(PS-*g*-NR)

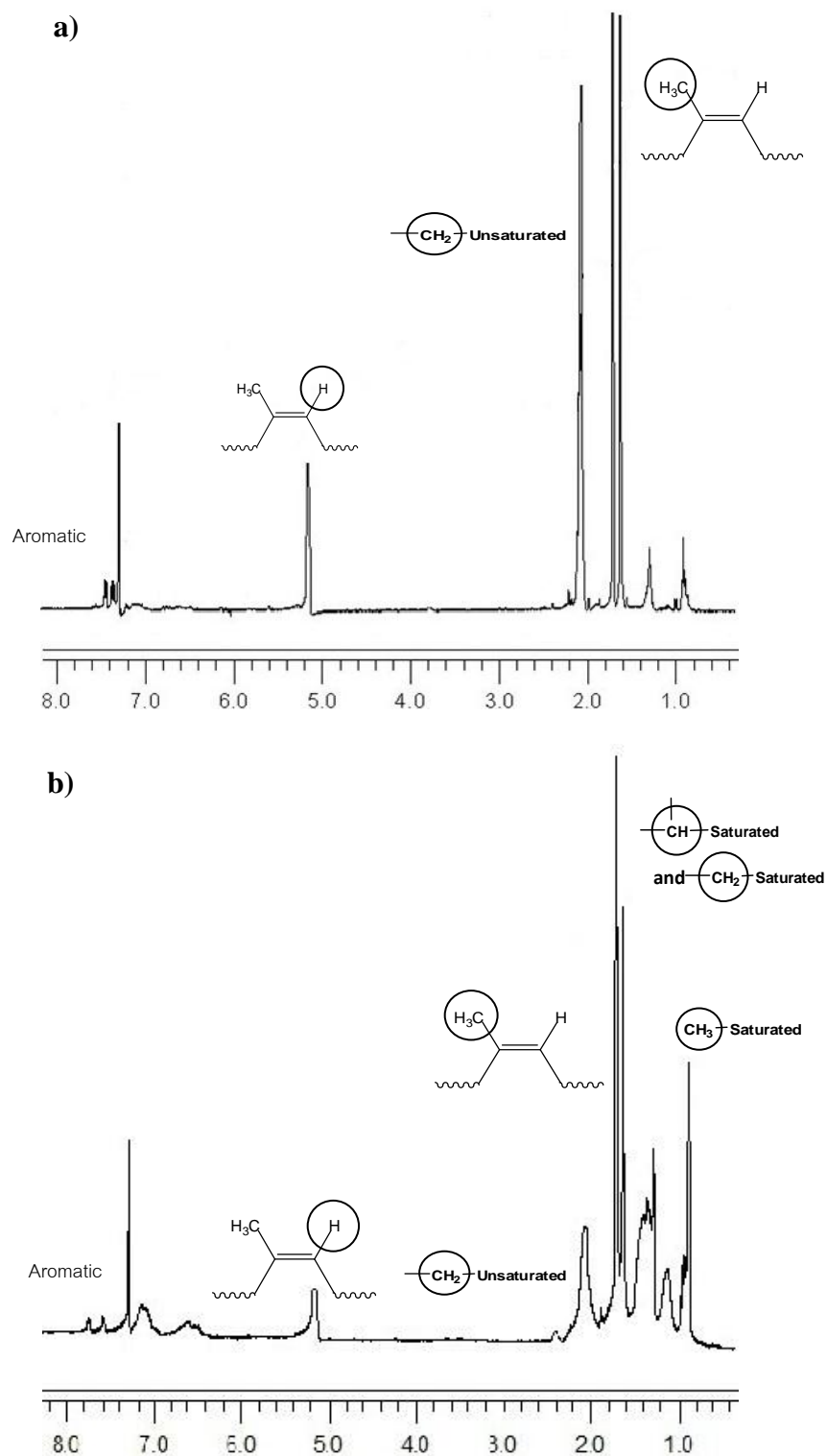

Figure 4.5 ^1H -NMR spectra of a) PS-*g*-NR and b) H(PS-*g*-NR) (47.2% HD, 56.4% GE)

4.3.2 Effect of Boric Acid

The effect of the catalyst concentration was studied over the range of 38.8–155.3 mM. The hydrogenation reaction was carried out at 70 °C for 6 h. The C=C concentration of 0.55 M, N₂H₄ concentration of 2.33 M and H₂O₂ concentration of 5.27 M were kept constant. From Figure 4.6, the degree of hydrogenation increased with increasing concentration of boric acid up to 74.7 mM and thereafter the degree of hydrogenation decreased. The increase in hydrogenation level can be explained that the formation of H-bond of boric acid with H₂O₂ can retard the side reaction of H₂O₂ and accelerate H₂O₂ dissociation to generate the diimide radical species resulting in the increasing of diimide species. On the other hand, at higher concentration of boric acid (above 74.7 mM), some free boric acid may be present in the water medium. The N₂H₄/H₂O₂ reaction (decomposition) mostly occurred in the aqueous phase resulting in a reduction of the diimide molecules, according to Eq (4.1) and (4.2) and then the degree of hydrogenation was decreased [39]. The disproportionation/decomposition reactions can be represented as:

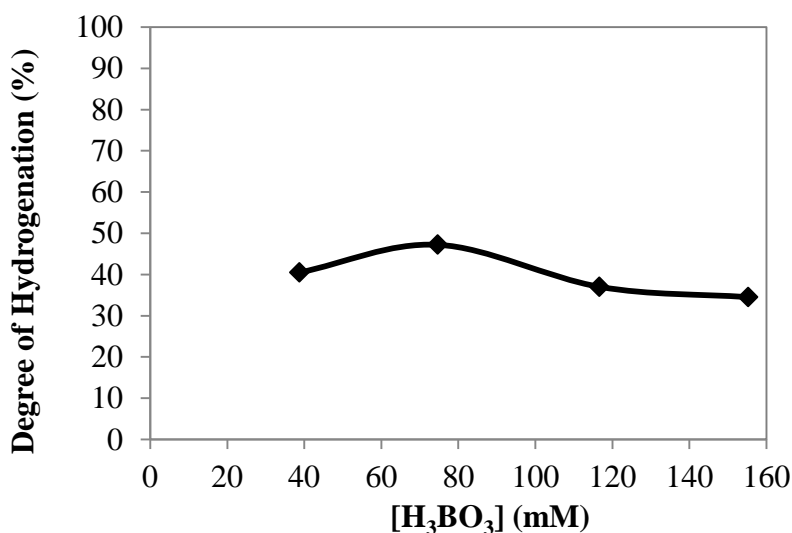
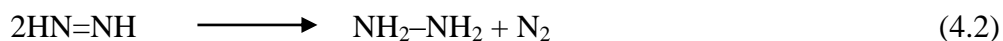
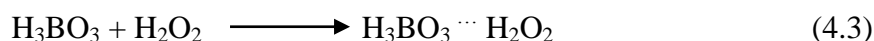

Figure 4.6 Effect of boric acid concentration on PS-*g*-NR hydrogenation.

Condition: [C=C] = 0.55 M, [N₂H₄] = 2.33 M, [H₂O₂] = 5.27 M, total volume = 150 mL, temperature = 70 °C, time = 6 h

Boric acid is an alternative material to help in promoting diimide hydrogenation [40]. Lin *et al.* [41] also reported that the promoting ability of boric acid is unique and is not shared with other weak acids. Boric acid provides a higher and more stable rate for the diimide reaction, which makes boric acid the most suitable choice in the latex system for promoting diimide formation. It was suggested that boric acid served to lower and mediate the concentration of hydrogen peroxide. The mechanism was proposed in Eq. (4.3).



Boric acid was capable to form hydrogen-bonds with hydrogen peroxide. This formation of hydrogen-bonds stabilized hydrogen peroxide and reduced the activity of hydrogen peroxide. As a result, the side reaction of diimide with hydrogen peroxide to produce nitrogen and water was suppressed as shown in Eq. (4.3).

4.3.3 Effect of Hydrazine and Hydrogen Peroxide

The effect of hydrazine concentration on diimide hydrogenation was studied over the range of 1.27 to 6.60 M. The hydrogenation reaction was carried out at 70 °C for 6 h, the C=C concentration of 0.55 M, boric acid concentration of 74.7 mM and H₂O₂ concentration of 5.27 M were kept constant. From Figure 4.7, the degree of hydrogenation increased with increasing concentration of N₂H₄ up to 4.73 M, [N₂H₄]:[H₂O₂]= 1:1.1. This results can be explained that more diimide was produced and enhanced the N₂H₂/C=C reduction. To confirm this explanation, four possible reactions between hydrazine and hydrogen peroxide are shown as follows:

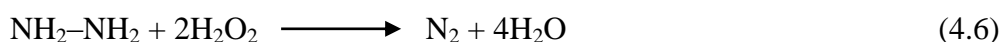
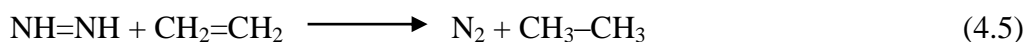

The diimide molecules were produced by the reaction between hydrazine and hydrogen peroxide as shown in Eq. (4.4). In the NRL medium that includes C=C

unsaturated unit and boric acid as a catalyst, the diimide species reacted with C=C to increase the degree of hydrogenation as shown in Eq. (4.5). When the amount of carbon-carbon double bonds of unsaturated unit was decreased and the amount of hydrogen peroxide was increased or in excess then N₂ was produced due to the predomination of Eq. (4.6). For higher hydrazine concentration, the more diimide was produced and enhanced the N₂H₂/C=C reduction resulting an increase in the degree of hydrogenation. However, the degree of hydrogenation decreased when the concentration of hydrazine was higher than 4.73 M. This phenomenon could be explained by Eqs. (4.6)-(4.7) in that the diimide species could self-react at high concentration of diimide to cause a decrease in hydrogenation efficiency. Another possible reason to explain the lower hydrogenation efficiency is that the excess content of diimide in this system may disperse into the aqueous phase [39]. This similar result was also reported by Mahittikul *et al.* [3].

One important parameter was the amount of hydrogen peroxide varied over the range of 2.60-7.93 M. The hydrogenation reaction was carried out at 70 °C for 6 h. The C=C concentration of 0.55 M, N₂H₄ concentration of 2.33 M, boric acid concentration of 0.55 M and total volume of 150 mL were kept constant. From Figure 4.8, the degree of hydrogenation increased with an increase in the concentration of hydrogen peroxide up until 5.27 M after which degree of hydrogenation decreased. This phenomenon may be explained from the two competitive reactions between N₂H₄ and H₂O₂ (Eqs. 4.5 and 4.6). At high concentration of hydrogen peroxide, the degree of hydrogenation decreased due to a possible crosslink reaction, which caused a reduction in the number of free C=C available for diimide reduction. At low H₂O₂ concentration, the diimide had more chance to diffuse into the rubber phase and a higher degree of hydrogenation was achieved [42]. Based on the reaction stoichiometry to produce diimide molecule as presented in Eq. (4.4), the suitable ratio for generation of the diimide species was 1:1 of [N₂H₄]:[H₂O₂]. From this experiment, the optimum ratio of [N₂H₄]:[H₂O₂] was 1:1.1. It was possible that the hydrogen peroxide was easily decomposed, so it was necessary to have an excess of hydrogen peroxide for effective production of diimide under the present reaction conditions used.

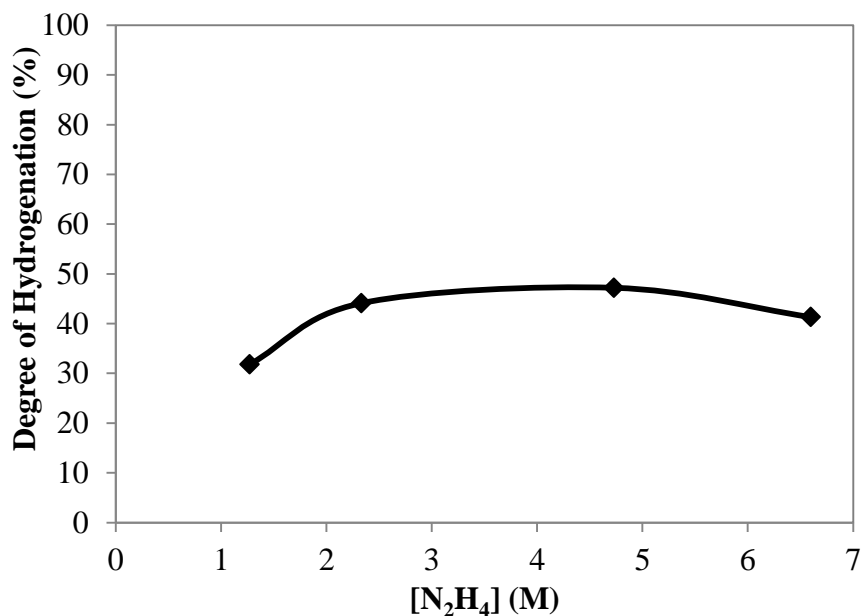

Figure 4.7 Effect of amount of hydrazine on PS-g-NR hydrogenation.

Condition: [C=C] = 0.55 M, [boric acid] = 74.4 mM, [H₂O₂] = 5.27 M, total volume = 150 mL, temperature = 70 °C, time = 6 h

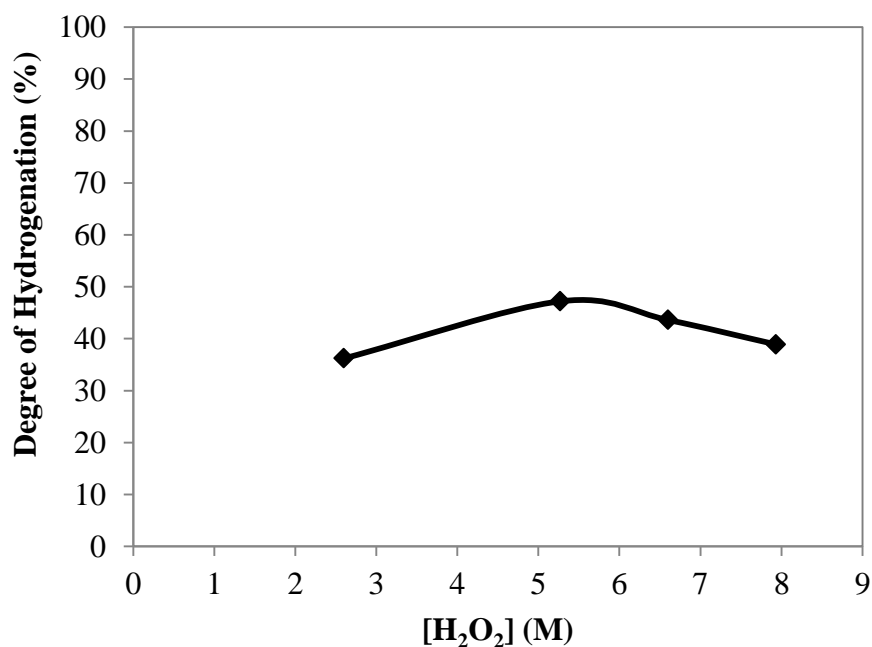

Figure 4.8 Effect of amount of hydrogen peroxide on PS-g-NR hydrogenation.

Condition: [C=C] = 0.55 M, [N₂H₄] = 2.33 M, [boric acid] = 74.7 mM, total volume = 150 mL, temperature = 70 °C, time = 6 h

4.4 Thermal Properties of Modified Rubbers

Thermal properties of rubber samples were investigated using Differential scanning calorimetry (DSC) and thermogravimetric analysis (TGA). The Glass transition temperature (T_g), the initial decomposition temperature (T_{id}) and maximum decomposition temperature (T_{max}) of rubber are summarized in Table 4.6. From Table 4.6. and Figure 4.9, the TGA thermograms for NR, PS-*g*-NR and H(PS-*g*-NR) indicate that polymer decomposition is an overall one-step reaction because the decomposition curve of the sample occurs in one-step and provides a smooth weight loss curve. T_{id} and T_{max} of H(PS-*g*-NR) sample increased with an increase in the reduction of the amount of carbon-carbon double bond in PS-*g*-NR. The T_{id} and T_{max} of H(PS-*g*-NR) at various hydrogenation degree (HD) were higher than that of NR and PS-*g*-NR ($\Delta T_{id} = 15.9\text{-}36.2$ °C and $\Delta T_{max} = 29.2\text{-}36.7$ °C). Therefore, the hydrogenation can improve the thermal stability of PS-*g*-NR.

The glass transition temperature (T_g) of NR, PS-*g*-NR and H(PS-*g*-NR) at various hydrogenation levels are summarized in Table 4.6. The DSC thermograms of H(PS-*g*-NR) indicated two step base-line shift as shown in Figure 4.10. The lower T_g is the T_g of NR and the upper T_g is the T_g of PS. In addition, T_g of H(PS-*g*-NR) samples were slightly increased with increasing hydrogenation level.

Table 4.6 Glass transition and decomposition temperature of rubber samples

Rubber	Degree of hydrogenation (%)	T_g (°C)	T_{id} (°C)	T_{max} (°C)
NR	-	-66.6	358.0	386.2
PS- <i>g</i> -NR	-	-65.1	360.4	389.3
H(PS- <i>g</i> -NR)	35.6	-65.3	373.9	415.4
	37.8	-64.5	382.9	421.2
	41.3	-64.9	385.4	422.0
	47.2	-64.7	394.2	422.9

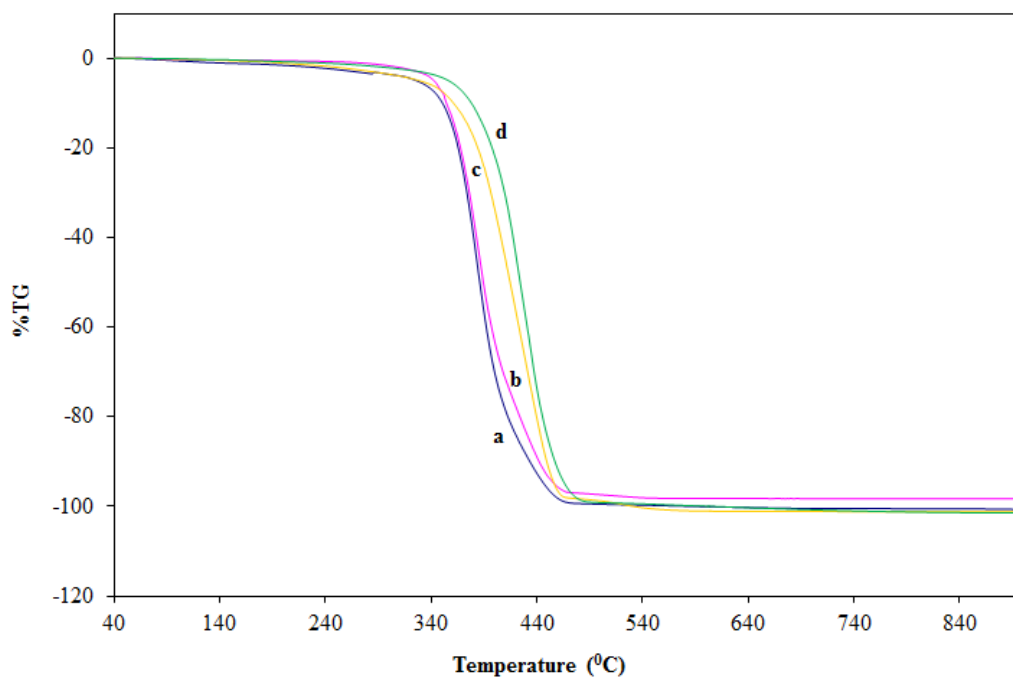

Fig.4.9 TGA thermograms of (a) NR, (b) PS-*g*-NR, (c) H(PS-*g*-NR) 35.6% HD, (d) H(PS-*g*-NR) 47.2% HD

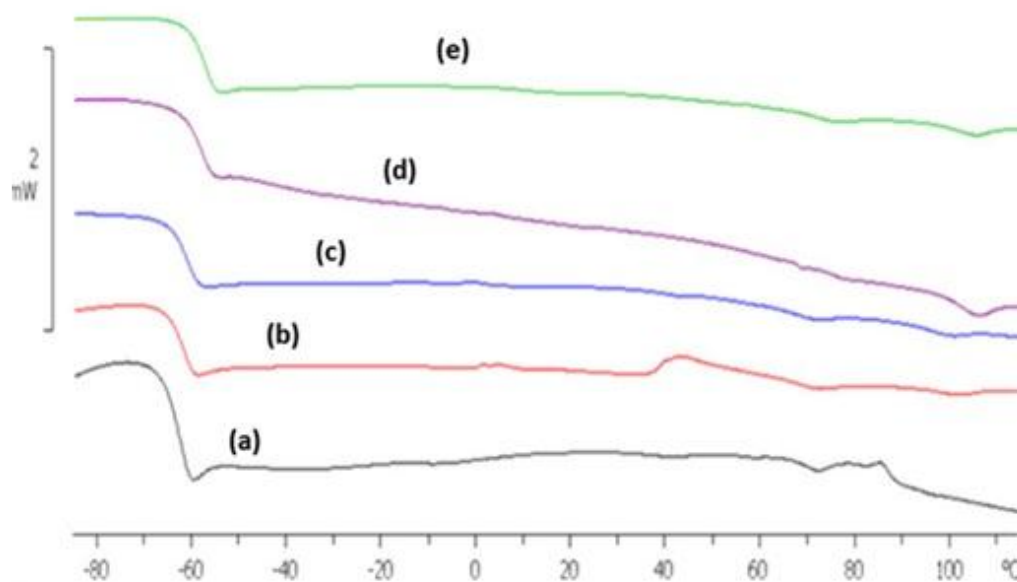

Figure 4.10 DSC thermograms of (a) NR, (b) H(PS-*g*-NR) 35.6% HD, (c) H(PS-*g*-NR) 37.8 % HD, (d) H(PS-*g*-NR) 41.3% HD and (e) H(PS-*g*-NR) 47.2% HD

4.5 Morphological Study

TEM micrograph was used to explain the morphology of the NRL particles before and after modification. The morphology of NR and PS-*g*-NR particles is shown in Figure 4.11a and 4.11b, respectively. The morphology of natural rubber latex particle is a spherical shape with smooth surface. For PS-*g*-NR, the surface morphology was observed by OsO₄ staining C=C of NR to increase contrast and gradation of the particles. The darker area represented the NR core region, whereas the lighter area represented PS grafted on NR as shell. Thus, PS-*g*-NR particle showed the core-shell morphology with NR as core and graft PS as shell.

The morphology of HNR at hydrogenation degree of 51.4% is shown in Figure 4.11c. As mentioned above, OsO₄ staining agent can only stain at the C=C, so the exterior area of the particle with light color indicates the region of lower C=C concentration. NR particle (Fig. 4.11a.) showed relatively sharp particle edge because the concentration of OsO₄ inside the particle was high. For 51.4% hydrogenated rubber (Fig. 4.11c), the shell with lighter color than the center was due to the low C=C in shell for OsO₄ staining. The hydrogenation of NRL particle seemed to occur from the outer surface layer to the center of rubber particle according to the layer model [3].

For comparison, morphology of PS-*g*-NR and H(PS-*g*-NR) at hydrogenation degree of 34.5% HD and 47.2% HD are shown in Figure 4.11d and e. PS-*g*-NR showed the core regions of NR and the PS grafted shell. For 34.5% H(PS-*g*-NR), there is no contrast between the core and the shell of H(PS-*g*-NR) particle. For 47.2% H(PS-*g*-NR), the contrast of core and shell with much lighter color was observed due to the low C=C. The PS-*g*-NR particle seemed to be hydrogenated from the outer surface layer to the center of rubber particle according to the layer model [3].

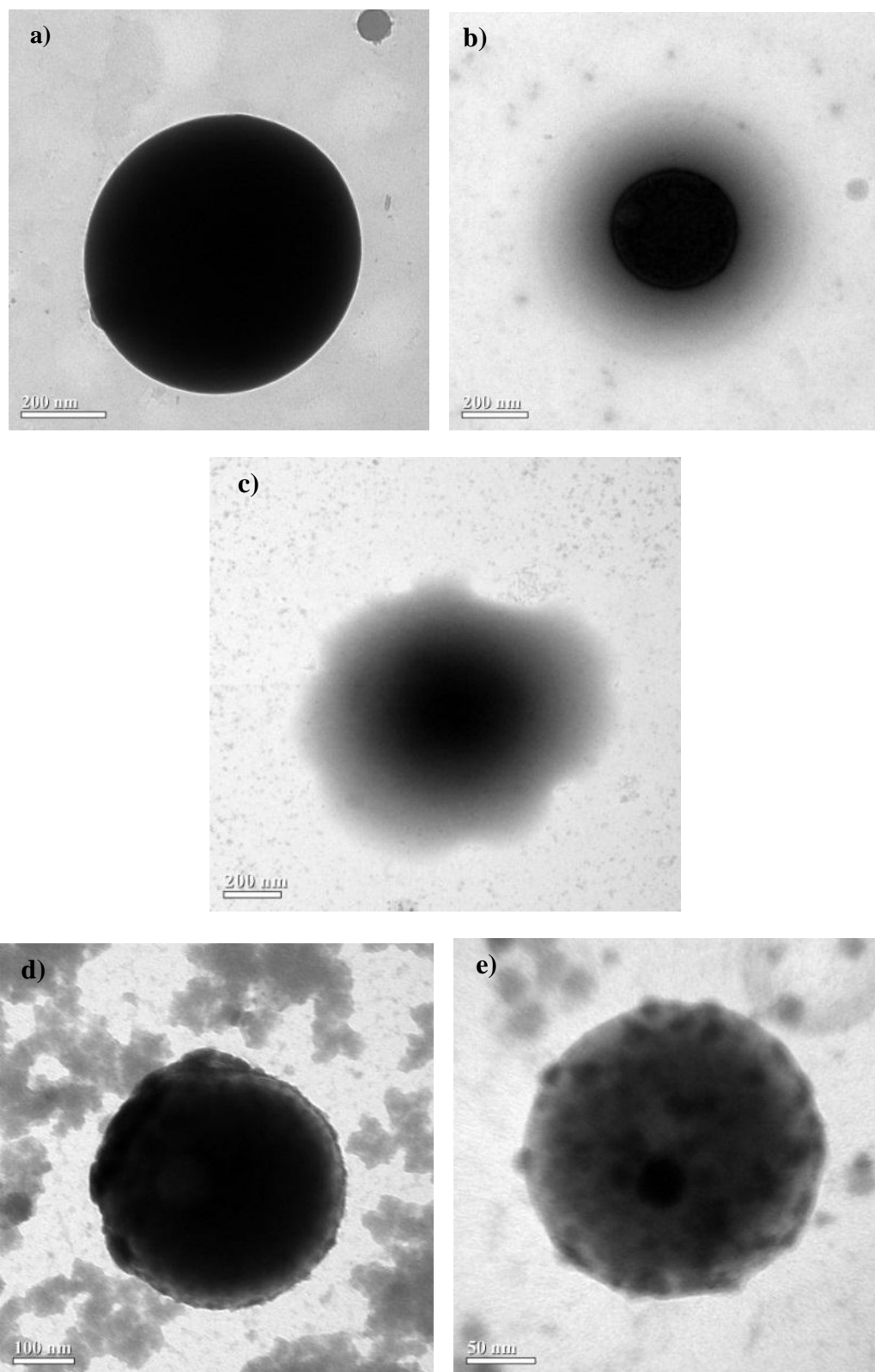

Figure 4.11 TEM micrographs of a) NR, b) PS-g-NR, c) HNRL 51.4% HD, d) H(PS-g-NR) 34.5% HD and e) H(PS-g-NR) 47.2% HD

4.6 Mechanical Properties of Blends of ABS and modified NR

The chemical modification via graft copolymerization and diimide hydrogenation could change the physical properties and thermal properties of NR. The modified rubber as H(PS-*g*-NR) could be used as substitute material for the use of butadiene rubber in ABS. To study the mechanical properties of ABS/H(PS-*g*-NR) blends, the thermoplastic blends were prepared at various ratios of ABS and H(PS-*g*-NR) by a melt-mixing system. The H(PS-*g*-NR) (EXP 3: Table 4.5) with 47.2% HD was selected to blend with ABS. The PS-*g*-NR₁₀ with grafting conversion of 61.7% (Table 4.1) was also selected to blend with ABS for comparative study. The effects of ABS/modified NR ratio on tensile properties, impact strength and hardness of blends were investigated. The mechanical properties of ABS/NR, ABS/PS-*g*-NR and ABS/H(PS-*g*-NR) blends are summarized in Table 4.7.

Table 4.7 Effect of modified natural rubber content on tensile strength (TS), elongation at break (EB), Young's Modulus, impact strength, and hardness of ABS blends.

Compounds	Blends Ratio (ABS/rubber)	TS (MPa)	EB (%)	Young's Modulus (MPa)	Impact Strength (kJ/m ²)	Hardness
ABS	100/0	34.9 (0.62)*	8.79 (0.19)	538.2 (25.43)	188.2 (8.06)	71.0 (1.00)
ABS/NR	95/5	28.7 (0.36)	9.19 (0.07)	464.4 (18.16)	194.3 (1.78)	68.7 (0.58)
	90/10	24.3 (0.49)	9.53 (0.92)	415.0 (36.21)	188.4 (3.44)	67.7 (0.58)
	80/20	13.5 (0.70)	7.36 (0.35)	300.7 (27.99)	148.0 (10.15)	60.7 (0.58)
ABS/PS- <i>g</i> -NR	95/5	30.0 (0.19)	9.28 (0.40)	492.6 (8.71)	212.4 (6.68)	69.7 (0.58)
	90/10	32.0 (0.49)	9.28 (0.55)	507.2 (12.21)	261.0 (7.63)	68.0 (0.00)
	80/20	15.6 (0.18)	7.70 (0.40)	327.2 (14.50)	170.6 (7.33)	61.3 (0.58)
ABS/H(PS- <i>g</i> -NR)	95/5	34.8 (0.36)	9.44 (0.50)	553.4 (22.11)	260.7 (8.18)	70.0 (0.00)
	90/10	37.9 (0.86)	9.61 (0.26)	629.0 (18.13)	277.9 (3.93)	70.7 (0.58)
	80/20	17.5 (0.49)	8.66 (0.40)	338.4 (14.42)	178.9 (11.79)	63.7 (0.58)

*The number in the parathesis is the standard deviation

4.6.1 Effect of Rubber Content on Tensile Properties

The effect of modified natural rubber content on tensile properties of the ABS blends was investigated by varying the rubber content of 5, 10 and 20%. The tensile properties of ABS/modified NR blends are shown in Table 4.8 and Figure 4.12.

From Figure 4.12a, the ABS/NR blends exhibited low tensile strength (13.5-28.7 MPa) than ABS (34.9 MPa). The tensile strength of ABS/NR blend decreased with increasing rubber content. This results can be explained by the incompatibility of NR with ABS due to the high C=C of NR. For ABS/PS-*g*-NR blends, the tensile strength slightly increased and leveled off at 10% wt of PS-*g*-NR content. However, the tensile strength of the ABS/PS-*g*-NR blends at 5-20% wt rubber content (15.6-30.0 MPa) was lower than that ABS due to the presence of the PS component as a brittle thermoplastic in PS-*g*-NR resulting low tensile strength. For ABS blends at various amount of H(PS-*g*-NR) with 47.2% HD, the tensile strength increased with an increase in the hydrogenated rubber content to level of 10% wt after which the tensile strength decreased. The tensile strength of the ABS/H(PS-*g*-NR) blends at 10% wt rubber content (37.9 MPa) was higher than that of ABS, ABS/NR and ABS/PS-*g*-NR because of the low amount of H(PS-*g*-NR) with low C=C resulting the more compatibilization with ABS.

From Figure 4.12 b, the elongation at break of ABS/modified rubber blends increased with increasing rubber content and slightly decreased at rubber content above 10% wt. The ABS/H(PS-*g*-NR) and ABS/PS-*g*-NR blends had higher elongation at break than ABS due to the more soft segments of NR with C=C units.

From Figure 4.12c, the Young's modulus of ABS/NR blends dramatically decreased with increasing in NR content. The decrease in the modulus may be due to the incompatibility of NR with high C=C. For ABS/PS-*g*-NR and ABS/H(PS-*g*-NR) blends, the Young's modulus increased and leveled off at modified rubber content above 10% wt. Furthermore, the Young's modulus of H(PS-*g*-NR) blends at 5 and 10% wt (553.4 and 629.0 MPa) were higher than that of ABS (538.2 MPa), ABS/NR (415.0-464.4 MPa) and ABS/PS-*g*-NR (492.6-507.2 MPa). The increase in the modulus may be due to the rigidity of the spherical clusters of graft PS that restrict the NR main chain movement.

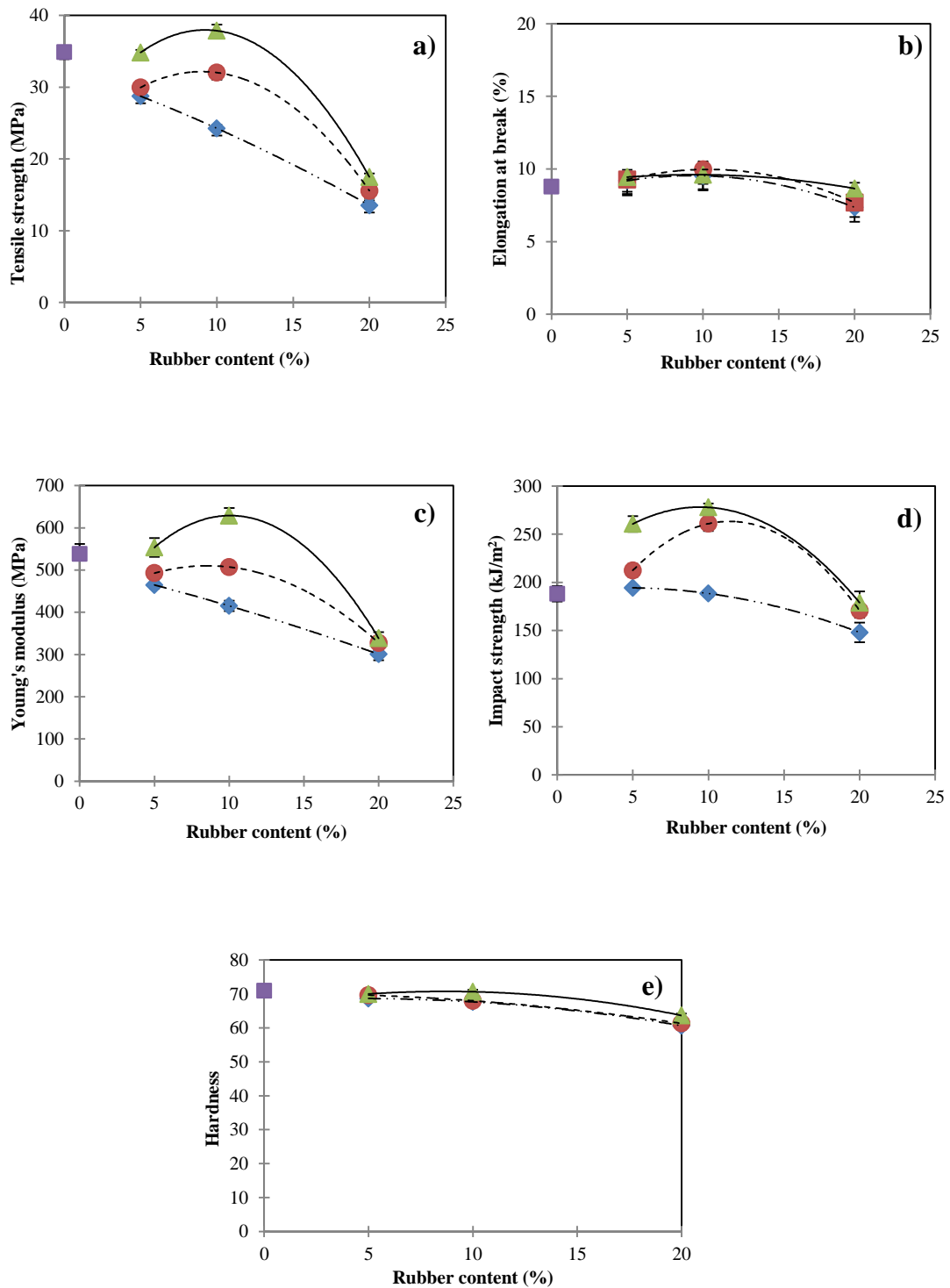

Figure 4.12 Effect of rubber content on a) tensile strength, b) elongation at break , c) Young's modulus, d) impact strength and e) hardness
 (■) ABS, (◆) ABS/NR, (●) ABS/PS-g-NR, (▲) ABS/H(PS-g-NR)

4.6.2 Effect of Rubber Content on Impact Strength

The effect of modified natural rubber content on the Charpy impact strength of ABS/modified NR blends was investigated. The impact strength of ABS/NR, ABS/PS-*g*-NR and ABS/H(PS-*g*-NR) blends are shown in Table 4.8 and Figure 4.12.

From Figure 4.12d, the impact strength of ABS is about 188.2 kJ/m², while the impact strength of ABS/PS-*g*-NR and ABS/H(PS-*g*-NR) blends at blend ratio of 95/5 and 90/10 was higher than that of ABS. The ABS sheet with 10% wt H(PS-*g*-NR) addition had the highest impact strength (277.9 kJ/m²). It indicates that the H(PS-*g*-NR) provided the better compatibility with ABS than NR and PS-*g*-NR because of the good miscibility of H(PS-*g*-NR) in the ABS matrix when blending. For ABS/NR blends (95/5, 90/10 and 80/20), the impact strength decreased with increasing the rubber content due to the the higher C=C in the NR main chain. For ABS/PS-*g*-NR and ABS/H(PS-*g*-NR) blends, the impact strength increased with increasing the rubber content and leveled off at rubber content above 10% wt. However, the high loading of modified rubber above 20% wt in the ABS might cause the poor impact strength due to the immiscibility and incompatibility of rubber and thermoplastics.

4.6.3 Effect of Rubber Content on Hardness

The effect of modified natural rubber content on hardness of the ABS/modified NR blends was investigated by varying the rubber content of 5, 10 and 20%. The hardness of ABS/NR, ABS/PS-*g*-NR and ABS/H(PS-*g*-NR) blends are shown in Table 4.8 and Figure 4.12e.

From Figure 4.12e, the hardness of ABS/NR blends decreased with increasing rubber content due to the softness of NR. For ABS/PS-*g*-NR and ABS/H(PS-*g*-NR), the hardness leveled off at rubber content above 10%. The hardness of ABS/H(PS-*g*-NR) blends was higher than that of ABS/NR and ABS/PS-*g*-NR blends because of the lower rubber portion and the lower C=C content in the NR main chain.

4.6.4 Thermal Stability of ABS/modified NR

The thermal stability of ABS/modified rubber was measured in term of mechanical properties and the retention (%) after aging as summarized in Table 4.8 and Figure 4.13. The ABS/NR blends after aging showed a lowest retention of tensile strength (71.4-82.6%) and elongation at break (89.6-98.4%). For ABS/PS-*g*-NR blends after aging, the retention of tensile strength and elongation at break was also retained in the range of 71.9-92.0% and 90.7-98.5%. For ABS/H(PS-*g*-NR) blends after aging, the tensile strength and elongation at break was highest in the range of 88.4-96.2% and 92.3-102.9%, respectively. This result implies that the addition of H(PS-*g*-NR) in the ABS blend has more heat resistance than the addition of NR and PS-*g*-NR due to the lower C=C level in the rubber main chain.

Table 4.8 Effect of modified natural rubber content on the thermal stability.

Compounds	Blends Ratio (ABS/rubber)	Tensile strength (MPa)		Elongation at break (%)	
		Before aging	% Retention ¹	Before aging	% Retention ¹
ABS	100/0	34.9 (0.62)	98.5	8.79 (0.19)	94.7
ABS/NR	95/5	28.7 (0.36)	82.6	9.19 (0.07)	98.4
	90/10	24.3 (0.49)	80.3	9.53 (0.92)	93.4
	80/20	13.5 (0.70)	71.4	7.36 (0.35)	89.6
ABS/PS- <i>g</i> -NR	95/5	30.0 (0.19)	88.5	9.28 (0.40)	93.4
	90/10	32.0 (0.49)	92.0	9.28 (0.55)	98.5
	80/20	15.6 (0.18)	71.9	7.70 (0.40)	90.7
ABS/H(PS- <i>g</i> -NR)	95/5	34.8 (0.36)	92.4	9.44 (0.50)	98.4
	90/10	37.9 (0.86)	96.2	9.61 (0.26)	102.9
	80/20	17.5 (0.49)	88.4	8.66 (0.40)	92.3

¹% Retention = (Properties after aging/Properties before aging) × 100

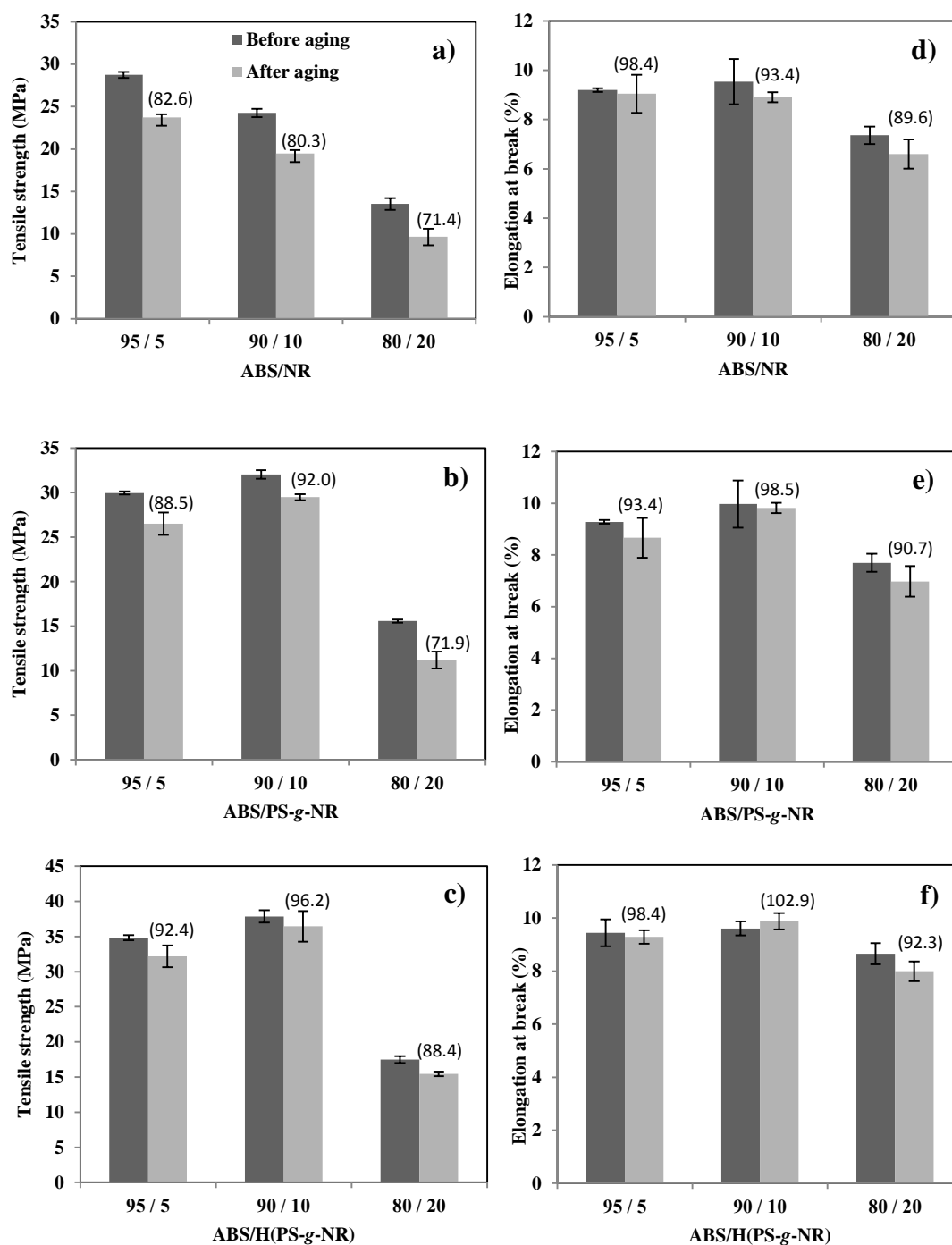

Figure 4.13. Effect of modified natural rubber content on thermal aging: the tensile strength of a) ABS/NR, b) ABS/PS-g-NR, c) ABS/H(PS-g-NR) and elongation at break of d) ABS/NR, e) ABS/PS-g-NR, f) ABS/H(PS-g-NR) () = % retention

4.7 Thermal Properties of ABS/Modified NR Blends

Thermal properties of the ABS/modified rubber blends were investigated using Differential scanning calorimetry (DSC) and thermogravimetric analysis (TGA). The glass transition temperature (T_g), the initial decomposition temperature (T_{id}) and maximum decomposition temperature (T_{max}) of thermoplastic blends are summarized in Table 4.9. From TGA thermograms of ABS/NR, ABS/PS-*g*-NR and ABS/H(PS-*g*-NR), the thermoplastic degradation is an overall one-step reaction because the thermal decomposition of the sample occurs in one-step and provides a smooth weight loss curve. From Figure 4.14, T_{id} and T_{max} of ABS/H(PS-*g*-NR) blends sample slightly increased with an increase in the the rubber content. The T_{id} and T_{max} of ABS/H(PS-*g*-NR) blends (402.4-405.1 °C) with various rubber content were higher than that of ABS (395 °C), ABS/NR and ABS/PS-*g*-NR blends. Therefore, the addition of H(PS-*g*-NR) can improve the thermal stability of ABS .

From DSC analysis, the glass transition temperature (T_g) of ABS/NR, ABS/PS-*g*-NR and ABS/H(PS-*g*-NR) blends at various rubber content are summarized in Table 4.9 and Figure 4.15. The T_g of ABS/NR, ABS/PS-*g*-NR and ABS/H(PS-*g*-NR) blends at various rubber content was in the range of 99.8-101.9 °C. The addition of modified rubber in ABS did not affect the T_g of ABS blends.

Table 4.9 Glass transition and decomposition temperature of blends samples

Compounds	Blends Ratio (ABS/rubber)	T_g (°C)	T_{id} (°C)	T_{max} (°C)
ABS	100/0	100.5	395.0	422.0
ABS/NR	95/5	100.8	395.4	424.1
	90/10	101.7	394.6	424.6
	80/20	101.9	385.9	421.3
ABS/PS- <i>g</i> -NR	95/5	101.1	400.6	427.5
	90/10	100.7	398.3	426.7
	80/20	101.7	394.1	424.9
ABS/H(PS- <i>g</i> -NR)	95/5	100.4	402.4	427.3
	90/10	99.8	403.0	428.9
	80/20	101.4	404.1	429.0o

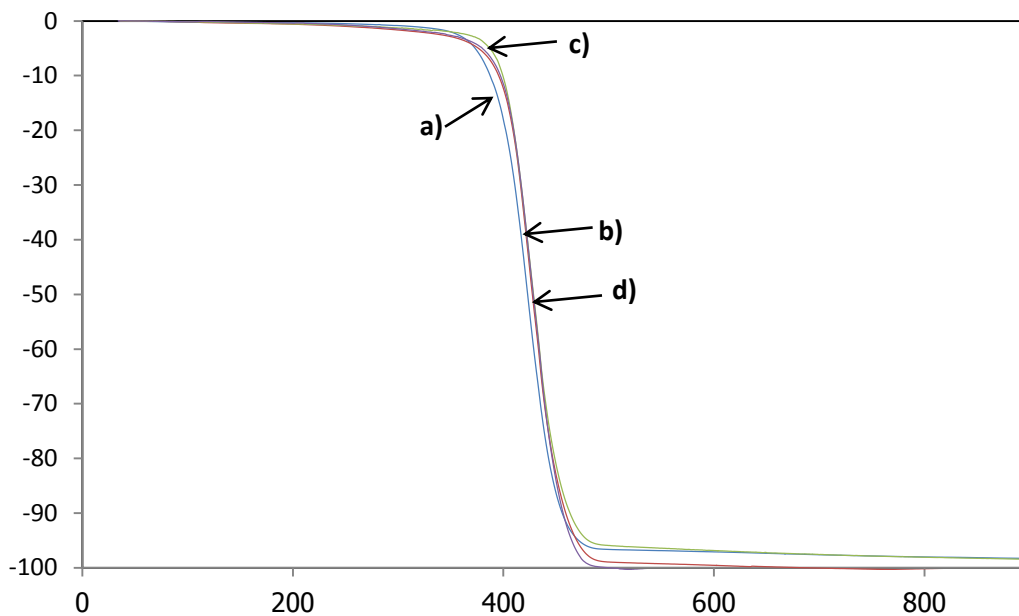

Figure 4.14 TGA thermograms of ABS/H(PS-*g*-NR) blends at a) 100/0, b) 95/5, c) 90/10 and d) 80/20

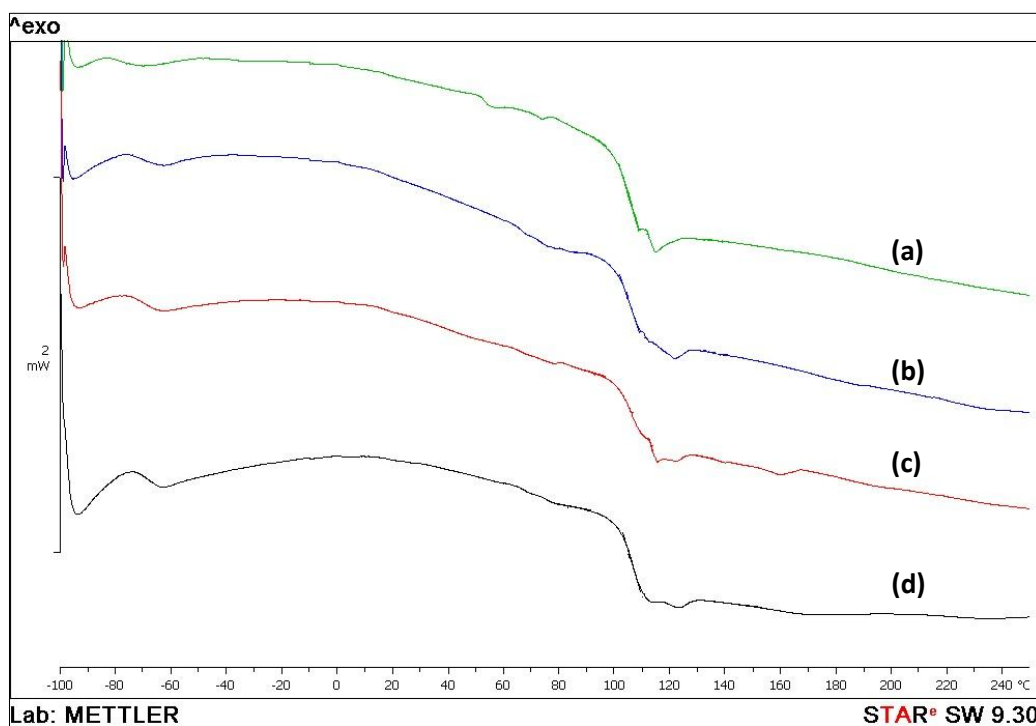

Figure 4.15 DSC thermograms of ABS/H(PS-*g*-NR) blends at a) 100/0, b) 95/5, c) 90/10 and d) 80/20

4.8 Morphology of ABS/modified rubber blends

The SEM fracture surface of selected ABS/modified rubber blends specimens was examined by using SEM technique. Figure 4.15 and 4.16 show the fracture surface of ABS compared with ABS/modified NR blends at various wt ratio.

For ABS (Figure 4.16a), the ABS fracture surface is very smooth. For addition of NR at 5 and 10% wt (Figure 4.16b, 4.17a), NR particles forms small domain dispersed in the ABS matrix. The NR domain size ranges from 1 to 10 μm . It can be seen that the interface between the two phases is very weak and the blend has many cavitation inside the ABS-whitening zone, indicating a totally incompatible polymer blend and resulting in the reduction of tensile strength. For the ABS/PS-*g*-NR blends at 5 and 10% wt (Figure 4.16c, 4.17 b), PS-*g*-NR domains tend to connect each other and shape of the phase becomes regular. The detail observation shows that all the rubber particles inside the ABS-whitening zone still have cavitated but the amount of these caves is much lower than that of ABS/NR blends. The ABS/H(PS-*g*-NR) blends at 5% and 10% (Figure 4.16d, 4.17c), show the morphology of the continuous phase with homogeneity and the cavitation of rubber particles inside the ABS whitening zone does not happen at all. This observation suggests a good interfacial bonding between ABS and hydrogenated NR dispersed phase through the formation of PS-*g*-NR graft copolymer.

Moreover, the ABS/H(PS-*g*-NR) blends with homogeneity fracture surface exhibited the highest tensile strength compared with the other samples at the 90/10 wt ratio (Figure 4.17c). It indicates that the H(PS-*g*-NR) acted as the interfacial agent to give the good compatibility with ABS matrix and to improve the mechanical properties of the ABS sheet. Figure 4.17d, 4.17e and 4.17f shows the fracture surface of ABS/modified rubber blends at 80/20 wt ratio, which has the lowest tensile strength compared with the other wt ratio. The morphology of blends indicating the large cave appeared on the fracture surface of the incompatible specimen confirm the low mechanical properties of blends.

95/5

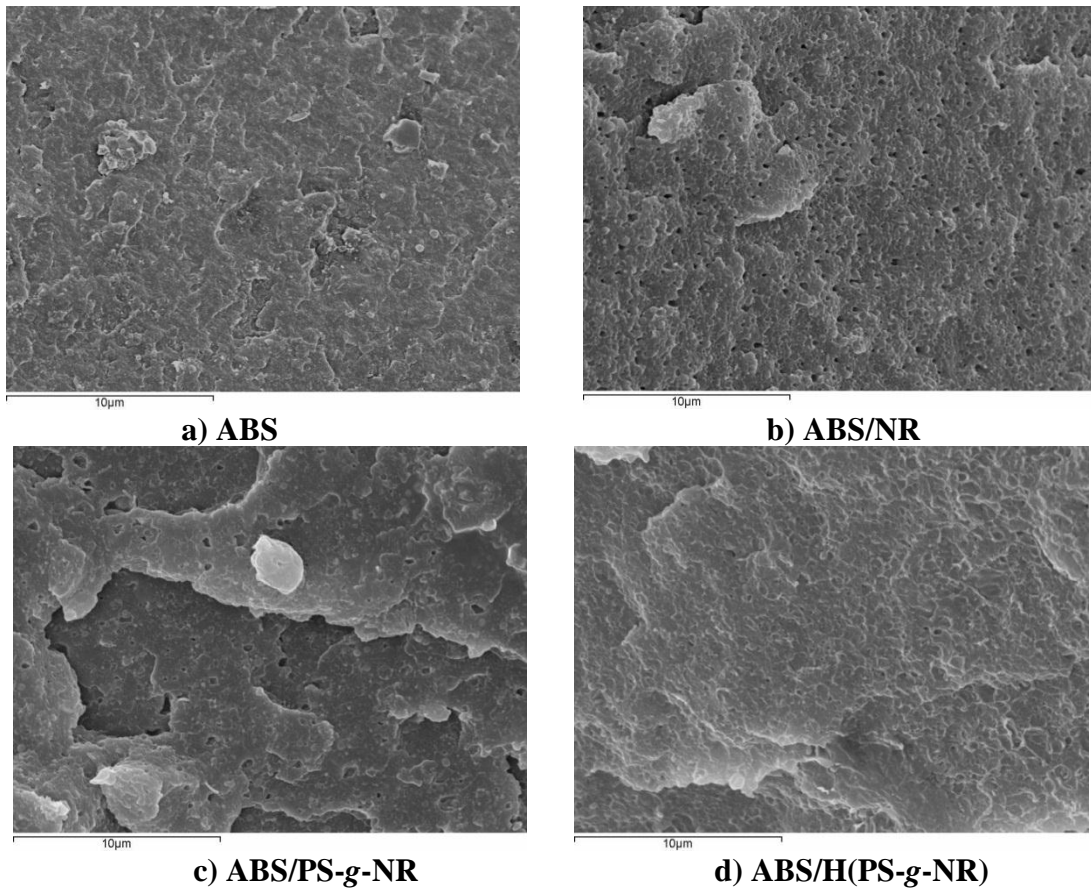

Figure 4.15 SEM micrographs of ABS/modified rubber blends at 95/5 wt ratio of
a) ABS, b) ABS/NR, c) ABS/PS-*g*-NR, d) ABS/H(PS-*g*-NR)
(magnification: 5,000 ×)

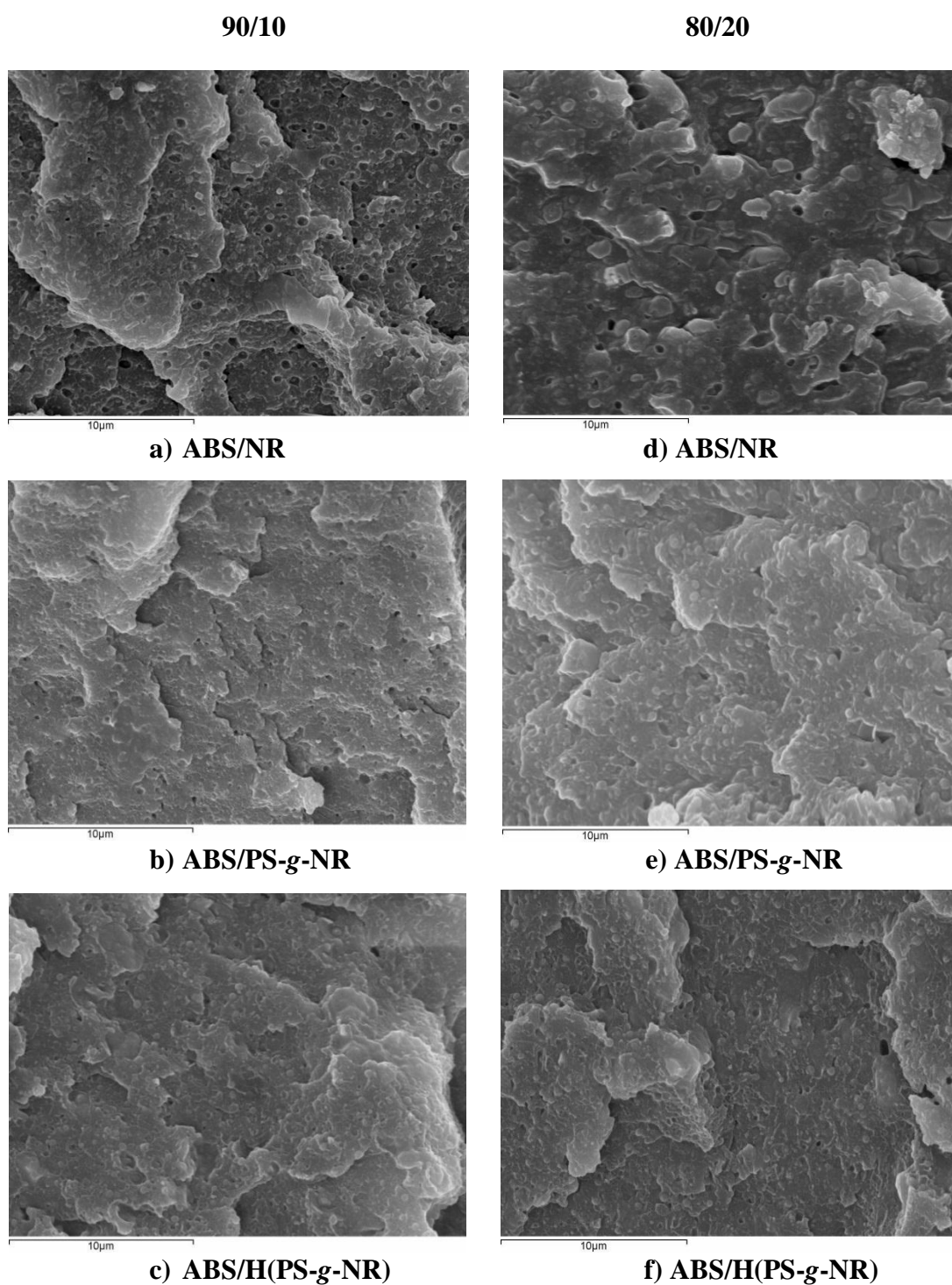

Figure 4.16 SEM micrographs of ABS/modified rubber blends at 90/10 wt ratio of a) ABS/NR, b) ABS/PS-g-NR, c) ABS/H(PS-g-NR) and at 80/20 wt ratio of d) ABS/NR, e) ABS/PS-g-NR, f) ABS/H(PS-g-NR) (magnification: 5,000 ×)

CHAPTER V

CONCLUSION AND SUGGESTION

5.1 Conclusions

The modification of natural rubber latex can be achieved by graft copolymerization and diimide hydrogenation. The graft natural rubber was prepared by an emulsion polymerization using CHPO/TEPA as redox initiator. At optimum condition of graft copolymerization of styrene onto NR, the maximum grafting efficiency was 81.5%. The conversion decreased with decreasing dry rubber content (or increasing water content). The PS-*g*-NR product consisted of 69.0-82.3% graft NR, 8.8-24.3% free NR and 6.6-16.6% free PST depending on conditions. The styrene conversion and grafting efficiency (GE) were 36.5-61.7% and 56.4-81.5%, respectively.

The hydrogenated NR was prepared by diimide hydrogenation technique. The degree of hydrogenation increased with increasing concentration of N_2H_4 and H_2O_2 . Boric acid (H_3BO_3) was found to be an efficient catalyst for diimide hydrogenation of NRL. The degree of hydrogenation increased with increasing the concentration of boric acid as catalyst. For the hydrogenated PS-*g*-NR prepared by diimide hydrogenation using boric acid, the highest hydrogenation degree of 47.2% was achieved under the ratio of hydrazine to hydrogen peroxide at 1: 1.1 and boric acid concentration of 74.7 mM at temperature of 70 °C for 6 h. The degree of hydrogenation increased with increasing the concentration of boric acid as catalyst.

The morphology of PS-*g*-NR particles exhibited the core-shell structure. For H(PS-*g*-NR) particles, the non-hydrogenated core and hydrogenated outer layer of H(PS-*g*-NR) particle were observed according to the layer model.

The DSC thermogram of NR samples exhibited one step of base-line shift. In contrast, the H(PS-*g*-NR) indicated two step base-line shift. The lower T_g is the T_g of NR and the upper T_g is the T_g of PS. From thermogravimetric analysis, the degradation temperature of H(PS-*g*-NR) increased with increasing hydrogenation

degree, indicates that hydrogenation resulted in an improvement of the thermal stability of grafted natural rubber.

The H(PS-*g*-NR) was used as modifier in acrylonitrile-butadiene-styrene and the mechanical properties ABS/H(PS-*g*-NR) blends were also investigated. The addition H(PS-*g*-NR) content at 10% wt in the blends could increased the tensile strength, elongation at break and impact strength of ABS blends. The mechanical properties of ABS/H(PS-*g*-NR) blends at 90/10 wt ratio did not change after heat aging at 165 °C for 25 min. This result implied that the addition of H(PS-*g*-NR) resulted in the more heat resistance of ABS blends than the addition of NR and PS-*g*-NR.

From the SEM micrograph, ABS/H(PS-*g*-NR) blend at 90/10 wt ratio showed the homogeneity fracture surface supported the highest of tensile strength. It indicates that the H(PS-*g*-NR) acted as the interfacial agent to give the compatibility with ABS to improve the mechanical properties of the ABS sheet.

From thermogravimetric analysis of ABS/H(PS-*g*-NR) blend, the thermal stability of ABS/H(PS-*g*-NR) blend at 90/10 was improved. Therefore, the ABS/hydrogenated graft NR blend named “Green ABS” would have high potential as new thermoplastic product in plastic industry

5.2 Suggestions for The Future Work

A future investigation of natural rubber latex modification should be further studied with the following aspects:

1. The diimide hydrogenation of methyl methacrylate-*g*-natural rubber latex should be investigated.
2. The blends of hydrogenated graft natural rubber and other rigid polymers such as PMMA should be further studied.

REFERENCES

- [1] Arayaprane, W., Prasassakich, P., and Rempel, G. L. Synthesis of graft copolymers from natural rubber using cumene hydroperoxide redox initiator. *J. Appl. Polym. Sci.* 83 (2002): 2993-3001.
- [2] Kongparakul, S., Prasassakich, P., and Rempel, G. L. Catalytic hydrogenation of styrene-g-natural rubber (ST-g-NR) in the presence of OsHCl(CO)(O₂)(PCy₃)₂. *Euro. Polym. J.* 45 (2009): 2358-2373.
- [3] Mahittikul, A., and Rempel, G. L. Diimide reduction of natural rubber latex. *J. Appl. Polym. Sci.* 105 (2007): 1188 – 1199.
- [4] Parker, DK., Roberts, RF., and Schiessl, HW. A new process for the preparation of highly saturated nitrile rubber in latex form. *Rubber Chem Technol.* 65 (1992): 245–57.
- [5] Edward S. Wilks. *Industrial polymers handbook*. Volume. 2. Wiley-VCH, 2001.
- [6] Adams, M.E., Buckley, D.J. and Collborn, R.E. *Acrylonitrile-Butadiene-Styrene*. W.P. England and D.N Schissel, 1993.
- [7] Brydson, J. A. *Rubbery materials and their compounds*. London: Elsevier Science Ed, 1994.
- [8] Holfmann, W. *Rubber technology handbook*. ed. New York: Hanser Publishers, 1989.
- [9] Morton, M. *Rubber technology*. 2nd ed. New York : Van Nostrand Reinhold, 1973.
- [10] Brydson, J.A. *Rubber chemistry*. Essex : Applied Science Publishers, 1978.
- [11] Fisher, H.L. *Chemistry of natural and synthetic rubber*. New York : Reinhold Publishing Corporation, 1975.

- [12] Verhaar, G. *Natural latex as a colloid system*. Rubber Chem. Technol. 32 (1959): 1627-1659.
- [13] Robert, A. D. ed. *Natural rubber science and technology*. Oxford: Oxford University Press, 1988.
- [14] Subranium, A. Molecular weight and other properties of natural rubber: a study of clonal variations. *Proc. Int. Rubb. Conf. Kula Lumpur 4*, 1975.
- [15] Tangpakdee, J. and Tanaka, Y. Characterization of sol and gel in *Hevea* natural rubber. *Rubber Chem Tech.* 70 (1997): 707-713
- [16] Allen, P. W. and Bristow, G. M. The gel phase in natural rubber. *J. Appl. Polym. Sci.*, 7 (1963): 603-615.
- [17] Tangpakdee, J. and Tanaka, Y. Purification of natural rubber. *J. Natl. Rubb. Res.* 12 (1997): 112-119.
- [18] Bemiller, N. *Encyclopedia of Polymer Science and Technology*. Vol. 7, New York : John Wiley & Sons, 1976.
- [19] Arayapranee, W., Prasassarakich, P., and Rempel, G. L. Factorial experimental design for graft copolymerization of styrene and methyl methacrylate onto styrene-butadiene rubber. *J. Appl. Polym. Sci.*, 100 (2006): 2867-2874.
- [20] Lovell, P.A., and EL-Aasser, M.S. *Emulsion polymerization and emulsion Polymers*. England : John Wiley & Sons, 1997.
- [21] Gilbert, R.G. *Emulsion polymerization*. London : Academic Press. 1995.
- [22] Hinchiranan, N. *Hydrogenation of natural rubber catalyzed by $OsHCl(CO)(O_2)(PCy_3)_2$ and $[Ir(cod)(PCy_3)(py)]PF_6$* . Doctoral dissertation, Department of Chemical Technology, Faculty of Science, Chulalongkorn University, 2002.

- [23] Schultz, D. N., Turner, S. R. and Golub, M. A. Recent advances in the chemical modification of unsaturated polymers. *Rubber Chem. Tech.* 55 (1982): 809-859.
- [24] Parker, D. K., Roberts, R. F., and Schiessl, H. W. A new process for the preparation of highly saturated nitrile rubber in latex form. *Rubber Chem. Tech.* 65 (1992): 245-257.
- [25] Simma, K., Rempel, G. L., and Prasassakich, P. Improving thermal and ozone stability of skim natural rubber by diimide reduction. *Polym. Degrad. Stab.* 94(2009): 1914-1923.
- [26] Mark, J. E., Erman, B., and Eirich, F. R. *The science and technology of rubber*. 3rd ed., USA: Elsevier Academic Press, 2005.
- [27] Barlow, J.W. and Paul, D.R. Polymer Alloys. *Ann. Rev. Mater. Sci.* 11(1981): 299-319.
- [28] AKKapeddi, M.K., et al. *Reactive polymer blending*. Henser: Munich, 1999.
- [29] Malcolm, B. *Polymer chemistry : an introduction*. Ed. New York : oxford University press, 1999.
- [30] Hess, W.M., Scott, C.E. and Callan J.E. Carbon black distribution in Elastomer blends. *Rubber Chem. Tech.* 40 (1967): 371-384.
- [31] Suriyachai, P., Kiatkamjornwong, S., and Prasassarakich, P. Natural rubber-g-glycidyl methacrylate/styrene as a compatibilizer in natural rubber/PMMA blends. *Rubber Chem. Tech.* 77 (2004): 914-930.
- [32] Kochthongrasamee, T., Prasassarakich, P., and Kiatkamjornwong, S. Effects of redox initiator on graft copolymerization of methyl methacrylate onto natural rubber. *J. Appl. Polym. Sci.* 101 (2006): 2587-2601.
- [33] Kongparakul, S., Prasassakich, P., and Rempel, G. L. *Modified natural rubber latex by graft copolymerization with methyl methacrylate and hydrogenation using OsHCl(CO)(O₂)(PCy₃)₂ as a catalyst*. Doctoral

dissertation, Department of Chemical Technology, Faculty of Science, Chulalongkorn University, 2007.

- [34] Wideman, L. G. and Lawson, G. *Process for hydrogenation of carbon-carbon double bonds in an unsaturated polymer in latex form*. U.S. Patent 4, 1984.
- [35] Parker, D. K. and Ruthenburg, D. M. *Process for the preparation of hydrogenated rubber*. U.S. Patent 5, 1995.
- [36] ASTM International : Designation: D 638 – 03 Standard Test Method for Tensile Properties of Plastics : 50-64.
- [37] ASTM International : Designation: D 256 – 06a Standard Test Method for Determining the Izod Pendulum Impact Resistance of Notched Specimens of Plastics : 1-20.
- [38] ASTM International : Designation: D 785 – 03 Standard Test Method for Rockwell Hardness of Plastics and Electrical Insulating Materials : 129-134.
- [39] Xie, H. Q., Li, X. D. and Guo, J. S. Hydrogenation and neutralization of carboxylic styrene-butadiene latex to form thermoplastic elastomer with excellent thermooxidation resistance. *J. Appl. Polym. Sci.* 83 (2002): 1375-1384.
- [40] Lin, X. L., Pan, Q. and Rempel, G. L. Gel formation in diimide-hydrogenation polymers. *J. Appl. Polym. Sci.* 96 (2005): 1122-1125.
- [41] Lin, X. L., Pan, Q. and Rempel, G. L. Hydrogenation of nitrile-butadiene rubber latex with diimide. *Appl. Cat. A: General.* 276 (2004): 123-128.
- [42] Lin, X. *Hydrogenation of unsaturated polymer in latex form*. Doctoral dissertation, Department of Chemical Engineering, Faculty of Engineering, University of Waterloo, 2005.

APPENDICES

Appendix A

Table A-1 Typical properties of high ammonium natural rubber latex

Properties	Value
Total Solids Content, %	61.7
Dry Rubber Content, %	61.4
Non Rubber Solids, %	1.59
Ammonia Content (on Total Weight), %	0.70
Ammonia Content (on Total Phase), %	1.83
pH Value	10.4
KOH Number	0.566
Volatile Fatty Acid Number (V.F.A.)	0.0165
Mechanical Stability Time @ 55% TS (secs.)	710
Specific Gravity at 25 °C	0.942
Magnesium Content (on Solids), ppm	33
Viscosity on 60% TS (Spindle #1 Speed 60 rpm)	87.4

*From Rubber Technology Division, Rubber Research Institute of Thailand, Department of Agriculture.

APPENDIX B

Data of graft copolymerization

Table B-1 Data for graft copolymerization of ST onto NR

Batch No.	Temp	% DRC	Wt. of latex (g)	Wt. of DRC (g)	Wt. of monomer (g)	Graft product (g)	% conv.	Sample (g)	After PE (g)	After MEK (g)	% graft NR	% free NR	% free ST	total ST	free ST	grafted ST	% GE
1	50	30	50	30	30	33.83	12.8	2.4530	0.9861	0.7746	31.6	59.8	8.6	3.83	2.92	0.92	23.9
2	50	30	50	30	30	36.34	21.1	3.0011	1.2825	0.9965	33.2	57.3	9.5	6.34	3.46	2.88	45.4
3	50	30	50	30	30	40.26	34.2	3.0001	1.4524	1.1028	36.8	51.6	11.7	10.26	4.69	5.57	54.3
4	60	30	50	30	30	35.13	17.1	3.0053	0.815	0.5690	18.9	72.9	8.2	5.13	2.88	2.26	44.0
5	60	30	50	30	30	40.14	33.8	3.0093	1.459	1.2926	43.0	51.5	5.5	10.14	2.22	7.92	78.1
6	60	30	50	30	30	37.81	26.0	3.0101	2.5003	2.2621	75.2	16.9	7.9	7.81	2.99	4.82	61.7
7	60	30	50	30	30	39.20	30.7	3.018	2.1181	1.8996	62.9	29.8	7.2	9.20	2.84	6.36	69.1
8	60	30	50	30	30	41.98	39.9	3.0162	1.5403	1.1909	39.5	48.9	11.6	11.98	4.86	7.12	59.4
9	50	30	50	30	30	36.84	22.8	3.0766	2.1643	1.7732	57.6	29.7	12.7	6.84	4.68	2.15	31.5
10	50	30	50	30	30	37.02	23.4	3.0075	2.2674	2.1129	70.3	24.6	5.1	7.02	1.90	5.12	72.9
11	50	30	50	30	30	37.63	25.4	2.9977	2.2499	1.7639	58.8	24.9	16.2	7.63	6.10	1.53	20.1
12	50	30	50	30	30	36.47	21.6	3.0521	2.6892	2.1646	70.9	11.9	17.2	6.47	6.27	0.20	30.1
13	50	30	50	30	30	36.66	22.2	3.0225	2.7025	2.5814	85.4	10.6	4.0	6.66	1.47	5.20	78.0
14	50	30	50	30	30	33.85	12.8	3.0691	2.7472	2.6291	85.7	10.5	3.8	3.85	1.30	2.54	66.1
15	50	30	50	30	30	39.88	32.9	3.0061	2.6977	2.2218	73.9	10.3	15.8	9.88	6.31	3.57	36.1
16	55	30	50	30	30	39.38	31.3	3.0009	2.6582	2.0812	69.4	11.4	19.2	9.38	7.57	1.81	19.3
17	55	30	50	30	30	42.60	42.0	3.0102	2.5741	2.0762	69.0	14.5	16.5	12.60	7.05	5.55	44.1
18	55	30	50	30	30	44.02	46.7	3.0879	2.4522	2.0076	65.0	20.6	14.4	14.02	6.34	7.68	54.8

Table B-1 (Continue)

Batch No	Temp	% DRC	Wt. of latex (g)	Wt. of DRC (g)	Wt. of monomer (g)	Graft product (g)	% conv.	Sample (g)	After PE (g)	After MEK (g)	% graft NR	% free NR	% free ST	total ST	free ST	grafted ST	% GE
19	60	30	50	30	30	42.76	42.5	3.0925	2.6288	2.2133	71.6	15.0	13.4	12.76	5.75	7.01	55.0
20	50	30	50	30	30	43.13	43.8	3.0144	2.3453	2.0426	67.8	22.2	10.0	13.13	4.33	8.80	67.0
23	55	30	50	30	30	40.26	34.2	3.0445	2.5588	2.2997	75.5	16.0	8.5	10.26	3.43	6.83	66.6
24	55	30	50	30	30	44.87	49.6	3.0365	2.3960	2.2108	72.8	21.1	6.1	14.87	2.74	12.13	81.6
25	50	30	50	30	30	43.69	45.6	3.0395	2.5045	2.3603	77.7	17.6	4.7	13.69	2.07	11.62	84.9
26	60	30	50	30	30	42.91	43.0	3.0210	2.5429	2.3101	76.5	15.8	7.7	12.91	3.31	9.60	74.4
27	50	15	50	30	30	43.02	43.4	3.0215	2.4087	2.0486	67.8	20.3	11.9	13.02	5.13	7.89	60.6
28	50	20	50	30	30	46.40	54.7	3.0036	2.4188	2.2220	74.0	19.5	6.6	16.40	3.04	13.36	81.5
29	60	15	50	30	30	41.66	38.9	3.0050	2.5287	2.3158	77.1	15.9	7.1	11.66	2.95	8.71	74.7
30	60	20	50	30	30	40.94	36.5	3.0892	2.7454	2.5429	82.3	11.1	6.6	10.94	2.68	8.26	75.5
31	50	10	50	30	30	41.37	37.9	3.0390	2.6936	2.4754	81.5	11.4	7.2	11.37	2.97	8.40	73.9
32	60	10	50	30	30	42.01	40.0	3.0182	2.6208	2.3870	79.1	13.2	7.8	12.01	3.25	8.76	72.9
33	50	15	50	30	30	40.79	36.0	3.0010	2.5518	2.2565	75.2	15.0	9.8	10.79	4.01	6.78	62.8
34	50	15	50	30	30	42.62	42.1	3.0485	2.6997	2.4916	81.7	11.4	6.8	12.62	2.91	9.71	77.0
35	50	30	50	30	30	43.65	45.5	3.0407	2.5891	2.2241	73.1	14.9	12.0	13.65	5.24	8.41	61.6
36	60	30	50	30	30	45.21	50.7	3.0517	2.6207	2.2641	74.2	14.1	11.7	15.21	5.28	9.93	65.3
37	60	15	50	30	30	43.16	43.9	3.0346	2.6233	2.3069	76.02	13.6	10.4	13.2	4.50	8.66	65.8
38	50	30	50	30	30	45.92	53.1	3.0232	2.7114	2.2285	73.7	10.3	16.0	15.92	7.33	8.59	53.9
39	50	30	100	60	60	86.56	44.3	3.0168	2.7541	2.5127	83.3	8.7	8.0	26.56	6.93	19.63	73.9
40	50	30	100	60	60	90.23	50.4	3.0238	2.7587	2.3244	76.9	8.8	14.4	30.23	12.96	17.27	57.1

Appendix C

Calculation of Degree of Hydrogenation [48]

1. Percentage of Hydrogenation of NRL

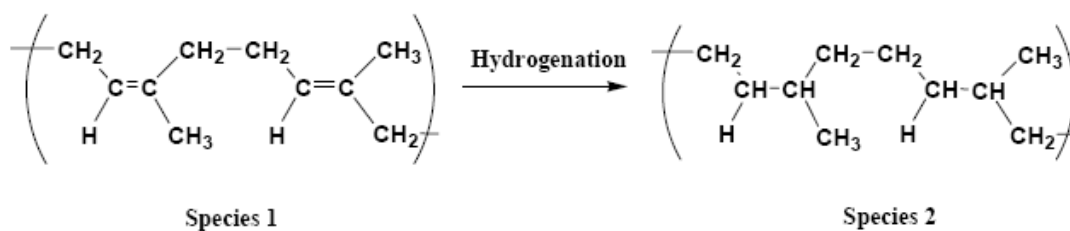

Proton of repeating unit except =CH in species 1 = 7 protons

Proton of repeating unit in species 2 = 10 protons

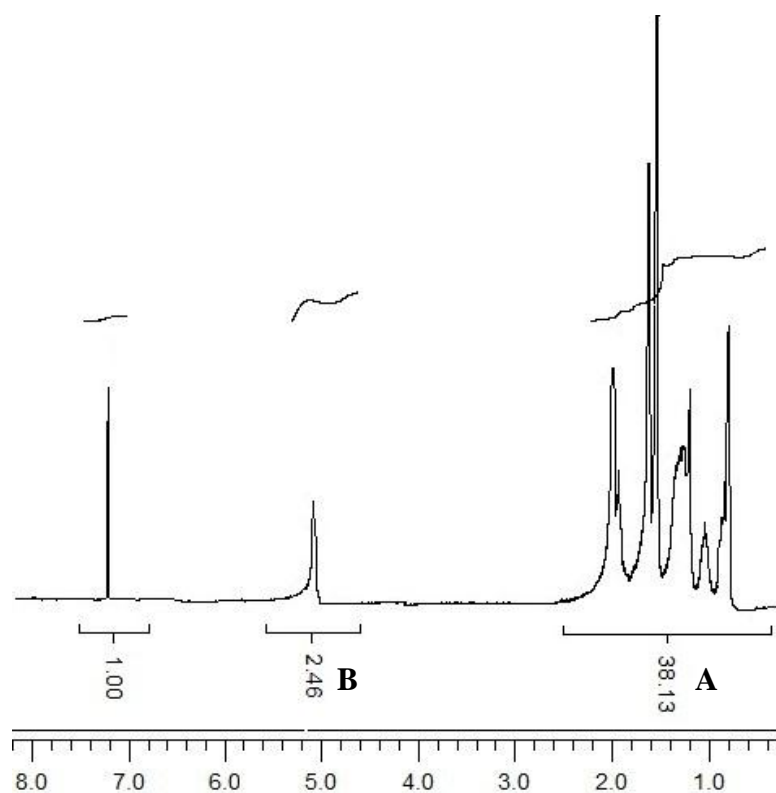

Where:

A = Peak area except at 5.2 ppm

B = Peak area at 5.2 ppm

C = Peak area of saturated $-\text{CH}_2-$ and $-\text{CH}_3$

$$A = 10C - 7B$$

$$C = \frac{A - 7B}{10}$$

Total peak area = Peak area of saturated $-\text{CH}_2-$ and $-\text{CH}_3$ + Peak area at 5.2 ppm

$$\begin{aligned} &= \frac{A - 7B}{10} + B \\ &= \frac{A - 3B}{10} \end{aligned}$$

%Hydrogenation = [(Peak area of saturated $-\text{CH}_2$ and $-\text{CH}_3$)/(Total peak area)] $\times 100$

$$\% \text{Hydrogenation} = \frac{(A - 7B)/10}{(A + 3B)/10} \times 100$$

$$\% \text{Hydrogenation} = \frac{A - 7B}{A + 3B} \times 100$$

For example: A = 31.83 and B = 2.46

$$\begin{aligned} \% \text{Hydrogenation} &= \frac{31.83 - 7(2.46)}{31.83 + 3(2.46)} \times 100 \\ &= 51.40\% \end{aligned}$$

2. Percentage of Hydrogenation of PS-g-NR

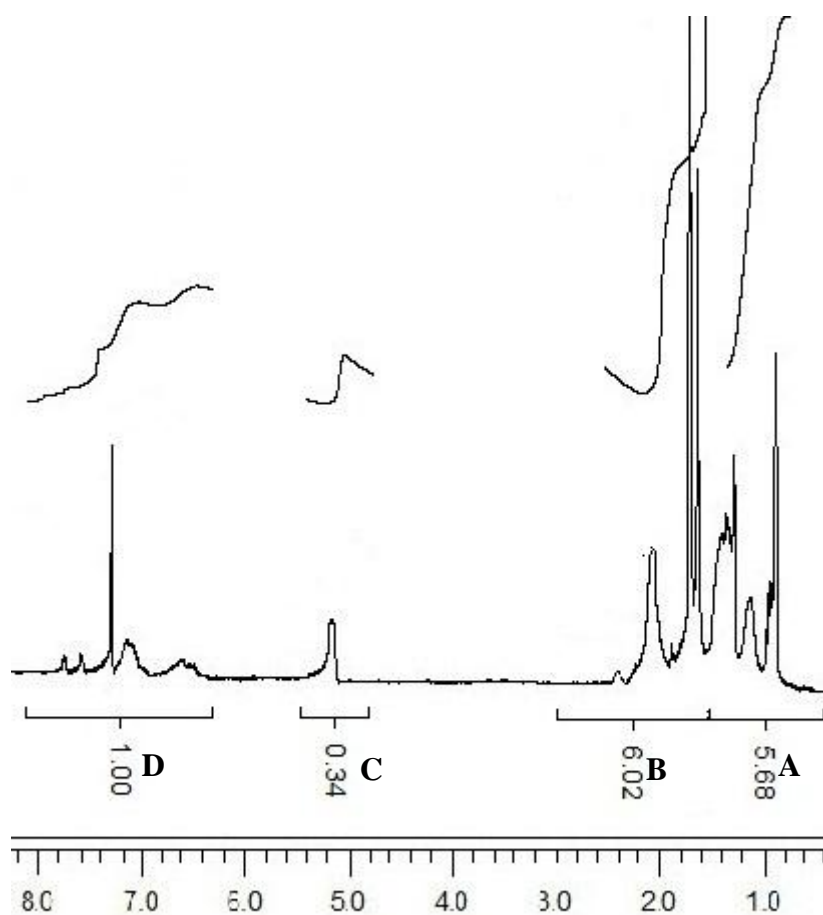
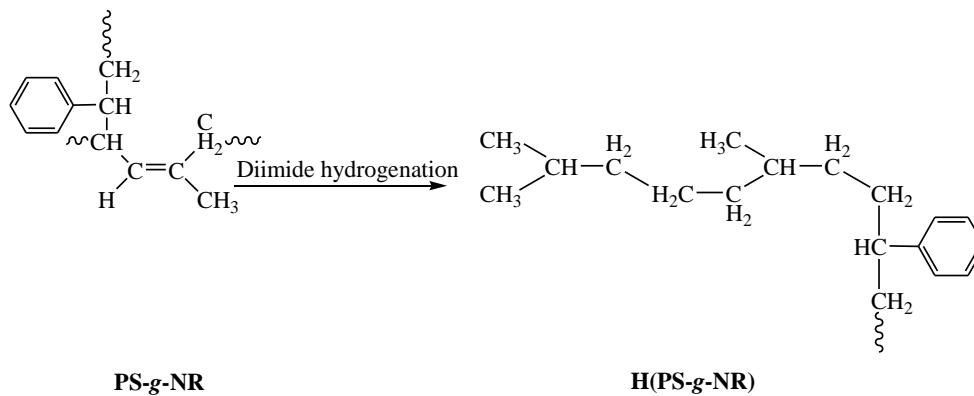

A = Peak area at 0.80 to 1.65 ppm (saturated $-\text{CH}_2-$, $-\text{CH}-$ and $-\text{CH}_3$)

B = Peak area at 1.80 to 2.20 ppm (unsaturated $-\text{CH}_2$ and $-\text{CH}_3$)

C = Peak area at 5.15 ppm

D = Peak area at 6.5 to 8.5 ppm

$$\begin{aligned} \text{Total peak area} &= \text{Peak area of saturated } -\text{CH}_2-, -\text{CH}- \text{ and } -\text{CH}_3 + \text{Peak area at} \\ &\quad 5.15 \text{ ppm} \\ &= A + B + C \end{aligned}$$

$$\begin{aligned} \% \text{ Hydrogenation} &= \frac{\text{Peak area of saturated } -\text{CH}_2-, -\text{CH}- \text{ and } -\text{CH}_3}{\text{Total peak area}} \times 100 \\ &= \left(\frac{A}{A + B + C} \right) \times 100 \end{aligned}$$

For example: A = 5.68, B = 6.02 and C = 0.34

$$\begin{aligned} \% \text{ Hydrogenation} &= \left(\frac{5.68}{5.68 + 6.02 + 0.34} \right) \times 100 \\ &= 47.18 \% \end{aligned}$$

Appendix D

Data of Hydrogenation Degree

Table D-1 Results of diimide hydrogenation of NRL in presence of copper sulfate as catalyst

EXP	CuSO ₄ [μ M]	Temp (°c)	N ₂ H ₄ [M]	H ₂ O ₂ [M]	Degree of Hydrogenation (%)
1	49.4	60	1.67	3.53	31.6
2	49.4	60	2.33	3.53	32.2
3	49.4	60	2.67	3.53	29.9
4	49.4	60	2.67	3.53	32.8
5	49.4	60	2.67	3.53	31.5
6	49.4	60	3.53	3.53	30.2
7	49.4	60	2.33	5.27	40.2
8	49.4	60	2.67	5.27	39.2
9	49.4	60	3.53	5.27	38.2
10	49.4	70	1.67	5.27	32.8
11	49.4	70	2.33	5.60	38.3
12	49.4	70	3.53	5.27	42.4
13	49.4	70	2.33	2.80	31.9
14	49.4	70	2.33	5.27	43.6
15	82.6	70	2.33	5.27	36.8
16	24.7	70	2.33	5.27	31.2

Table D-2 Results of diimide hydrogenation of NRL in presence of boric acid as catalyst

EXP	Cat. [mM]	Temp (°c)	N ₂ H ₄ [M]	H ₂ O ₂ [M]	Degree of Hydrogenation (%)
17	74.7	70	2.33	5.27	47.6
18	74.7	70	2.33	5.27	51.4
19	74.7	70	3.53	5.27	50.2
20	74.7	70	2.33	2.80	46.7
21	74.7	70	2.33	5.60	39.8
22	116.7	70	2.33	5.27	44.2
23	38.8	70	2.33	5.27	40.1

Table D-3 Effect of KOH on diimide hydrogenation of PS-*g*-NR

Exp	KOH (mM)	Degree of Hydrogenation (%)
1	0.80	44.1
2	1.20	40.3
3	1.61	37.1
4	0.80	41.8
5	2.40	31.9
6	4.01	31.7
7	4.01	30.5

Condition : temperature = 70 °C, time = 6 hr, [C=C] = 0.55 M, [Boric acid] = 74.7 mM , [N₂H₄] = 2.33 M, [H₂O₂] = 5.27 M. (Exp 1-3 used PS-*g*-NR from condition temperature = 60°C. Exp 4-7 used PS-*g*-NR from condition temperature = 50°C).

Table D-4 Results of diimide hydrogenation of PS-*g*-NR in presence of boric acid as catalyst

Experiment	H ₃ BO ₃ (mM)	N ₂ H ₄ (M)	H ₂ O ₂ (M)	Degree of Hydrogenation (%)
1	74.7	1.27	5.27	31.8
2	74.7	2.33	5.27	44.1
3	74.7	4.73	5.27	47.2
4	74.7	6.60	5.27	41.3
5	38.8	2.33	5.27	40.5
6	116.7	2.33	5.27	37.0
7	155.3	2.33	5.27	34.5
8	74.7	2.33	2.60	36.2
9	74.7	2.33	6.60	43.6
10	74.7	2.33	7.93	38.9
11	116.7	4.73	5.27	39.0
12	74.7	4.73	6.60	39.8
13	74.7	4.73	5.27	47.1
14	74.7	4.73	5.27	45.6
15	74.7	4.73	5.27	46.9
16	74.7	4.73	5.27	46.6
17	74.7	4.73	5.27	47.0
18	74.7	4.73	5.27	46.8
19	74.7	4.73	5.27	47.1
20	74.7	4.73	5.27	46.5
21	74.7	4.73	5.27	47.1
22	74.7	4.73	5.27	46.4

Appendix E

Data of Mechanical Properties

Table E.1 Tensile strength of ABS/modified rubber blends

	ABS		ABS/NR		ABS/PS-g-NR			ABS/H(PS-g-NR)			
	ratio	100/0	95/5	90/10	80/20	95/5	90/10	80/20	95/5	90/10	80/20
TS (Mpa)		34.26	28.65	24.44	14.31	29.90	32.14	15.78	35.14	37.93	17.05
		35.49	28.45	24.64	13.33	29.80	32.45	15.48	34.44	36.97	17.38
		34.92	29.14	23.71	13.00	30.17	31.49	15.45	34.90	38.69	18.02
Mean		34.9	28.7	24.3	13.5	30.0	32.0	15.6	34.8	37.9	17.5
SD		0.62	0.36	0.49	0.70	0.19	0.49	0.18	0.36	0.86	0.49

Table E.2 Elongation at break of ABS/modified rubber blends

	ABS		ABS/NR		ABS/PS-g-NR			ABS/H(PS-g-NR)			
	ratio	100/0	95/5	90/10	80/20	95/5	90/10	80/20	95/5	90/10	80/20
EB (%)		8.76	9.28	10.15	6.99	9.06	9.33	7.64	9.16	9.64	8.66
		8.99	9.16	9.97	7.68	9.73	10.28	7.33	9.14	9.33	8.26
		8.62	9.15	8.48	7.41	9.03	10.30	8.12	10.02	9.86	9.05
Mean		8.79	9.19	9.53	7.36	9.28	9.97	7.70	9.44	9.61	8.66
SD		0.19	0.07	0.92	0.35	0.40	0.55	0.40	0.50	0.26	0.40

Table E.3 Young's modulus of ABS/modified rubber blends

	ABS		ABS/NR		ABS/PS-g-NR			ABS/H(PS-g-NR)			
	ratio	100/0	95/5	90/10	80/20	95/5	90/10	80/20	95/5	90/10	80/20
Young's Modulus (Mpa)		512.01	454.14	452.64	332.46	482.84	516.02	310.89	568.28	629.97	340.76
		545.28	453.78	412.02	289.97	499.56	512.23	338.67	564.01	646.59	322.88
		557.22	485.41	380.40	279.65	495.44	493.24	331.99	528.04	610.36	351.41
Mean		538.2	464.4	415.0	300.7	492.6	507.2	327.2	553.4	629.0	338.4
SD		23.43	18.16	36.21	27.99	8.71	12.21	14.50	22.11	18.13	14.42

Table E.4 Impact strength of ABS/modified rubber blends

	ABS		ABS/NR		ABS/PS-g-NR			ABS/H(PS-g-NR)			
	ratio	100/0	95/5	90/10	80/20	95/5	90/10	80/20	95/5	90/10	80/20
Impact Strength (J/cm ³)		182.97	193.96	186.59	153.41	208.12	253.40	175.29	266.69	271.60	186.59
		180.12	196.33	184.58	154.06	203.60	261.74	163.98	260.99	280.32	173.56
		187.77	193.29	193.83	129.95	218.76	269.24	167.12	263.80	277.81	195.48
		189.06	192.12	188.59	151.20	218.88	252.95	165.37	265.52	281.93	166.70
		201.09	195.93	188.63	151.20	212.75	267.49	181.06	246.59	277.94	172.23
Mean	188.2	194.3	188.4	148.0	212.4	261.0	170.6	260.7	277.9	178.9	
SD	8.06	1.78	3.44	10.15	6.68	7.63	7.33	8.18	3.93	11.79	

Table E.5 Hardness of ABS/modified rubber blends

	ABS		ABS/NR		ABS/PS-g-NR			ABS/H(PS-g-NR)			
	ratio	100/0	95/5	90/10	80/20	95/5	90/10	80/20	95/5	90/10	80/20
Hardness (HDR)		70	69	68	61	69	68	62	70	71	63
		71	69	68	61	70	68	61	70	71	64
		72	68	67	60	70	68	61	70	70	64
Mean	71.0	68.7	67.7	60.7	69.7	68.0	61.3	70.0	70.7	63.7	
SD	1.00	0.58	0.58	0.58	0.58	0.00	0.58	0.00	0.58	0.58	

Table E.6 Tensile strength (after aging) of ABS/modified rubber blends

	ABS		ABS/NR		ABS/PS-g-NR			ABS/H(PS-g-NR)			
	ratio	100/0	95/5	90/10	80/20	95/5	90/10	80/20	95/5	90/10	80/20
Impact strength (MPa)		33.54	24.03	19.83	10.11	25.06	29.74	10.91	31.67	36.82	15.09
		35.43	23.34	19.61	10.31	26.99	29.08	12.25	30.94	34.07	15.76
		34.15	23.87	19.02	8.58	27.46	29.61	10.43	33.90	38.42	15.51
Mean	34.4	23.7	19.5	9.7	26.5	29.5	11.2	32.2	36.4	15.5	
SD	0.96	0.36	0.42	0.95	1.27	0.35	0.95	1.54	2.20	0.34	

Table E.7 Elongation at break (after aging) of ABS/modified rubber blends

ratio	ABS		ABS/NR		ABS/PS-g-NR			ABS/H(PS-g-NR)		
	100/0	95/5	90/10	80/20	95/5	90/10	80/20	95/5	90/10	80/20
EB (%)	7.52	9.90	8.67	7.06	8.75	9.26	7.34	9.35	9.54	8.42
	8.34	8.40	9.02	5.94	8.26	10.24	6.44	9.50	10.13	7.82
	9.10	8.83	9.02	6.79	8.99	9.96	7.16	9.00	9.99	7.74
Mean	8.32	9.04	8.90	6.60	8.67	9.82	6.98	9.29	9.88	7.99
SD	0.79	0.77	0.20	0.59	0.37	0.51	0.48	0.26	0.31	0.37

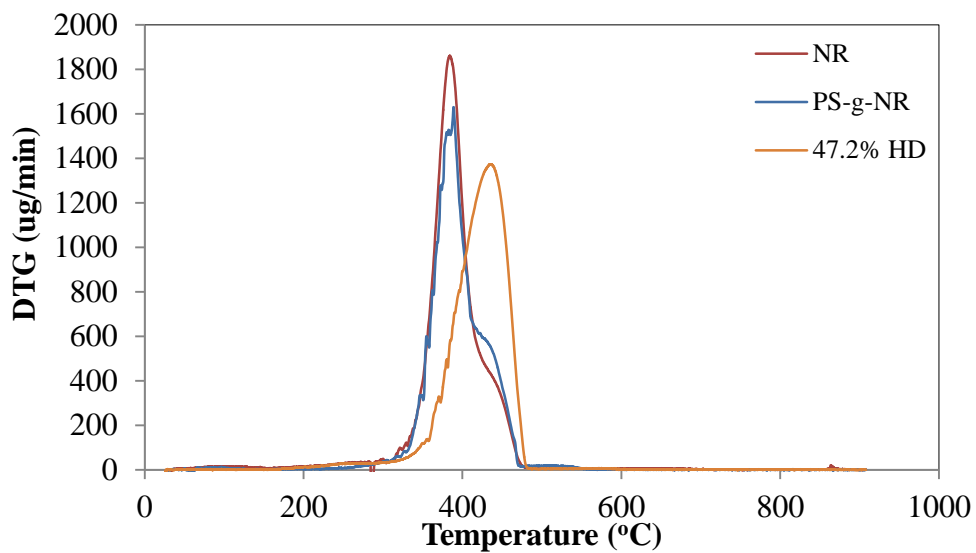
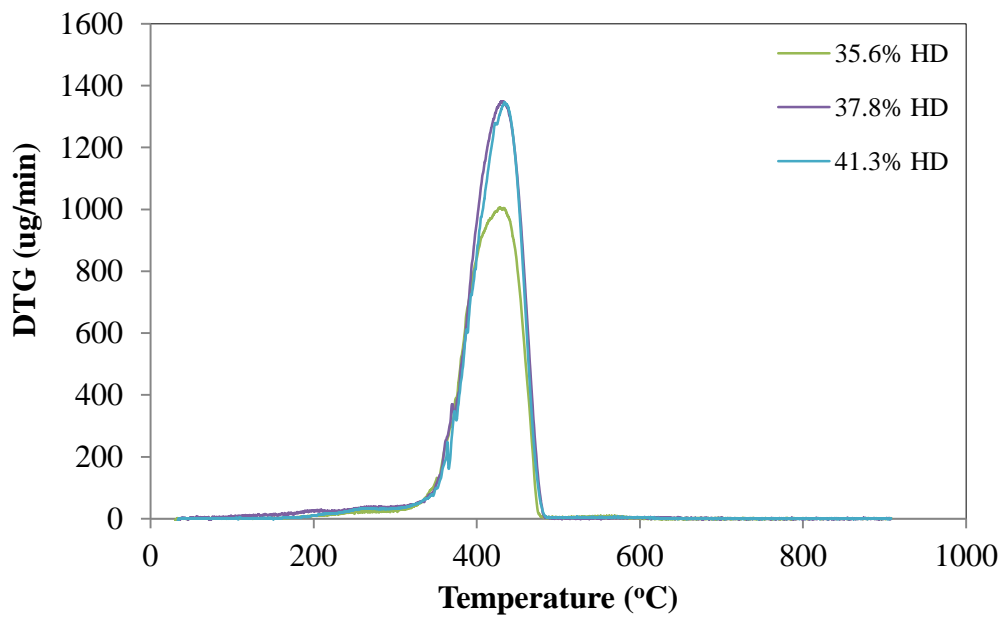
APPENDIX F**Data of Thermogravimetric Analysis****Figure F-1** DTG curves of NR, PS-g-NR and H(PS-g-NR)**Figure F-2** DTG curves of H(PS-g-NR) at various degree of hydrogenation

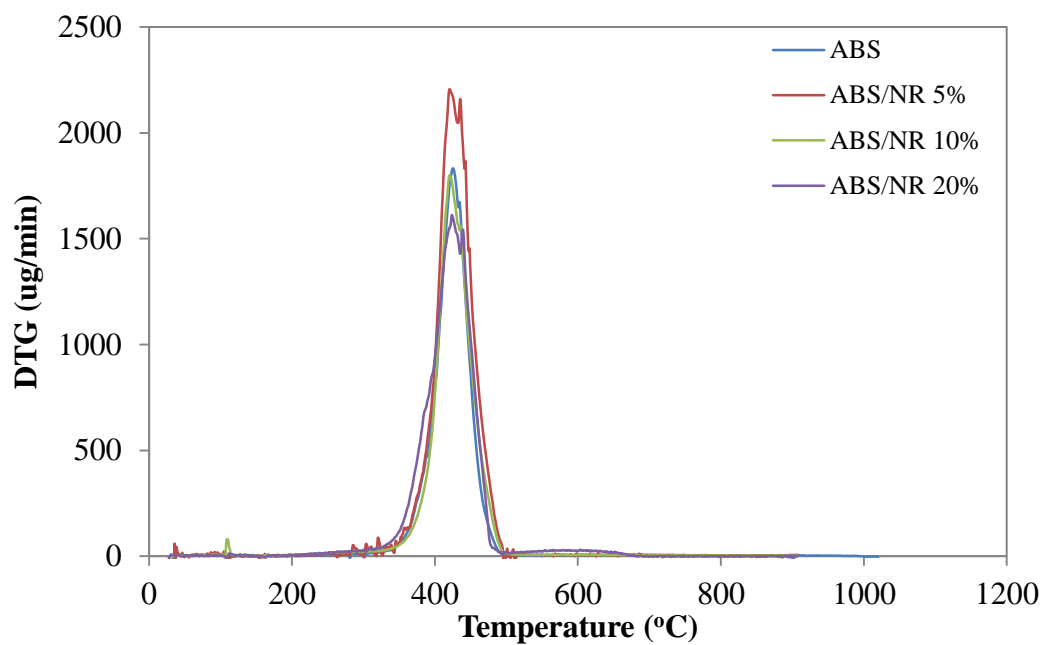

Figure F-3 DTG curves of ABS and ABS/NR blends at various rubber content

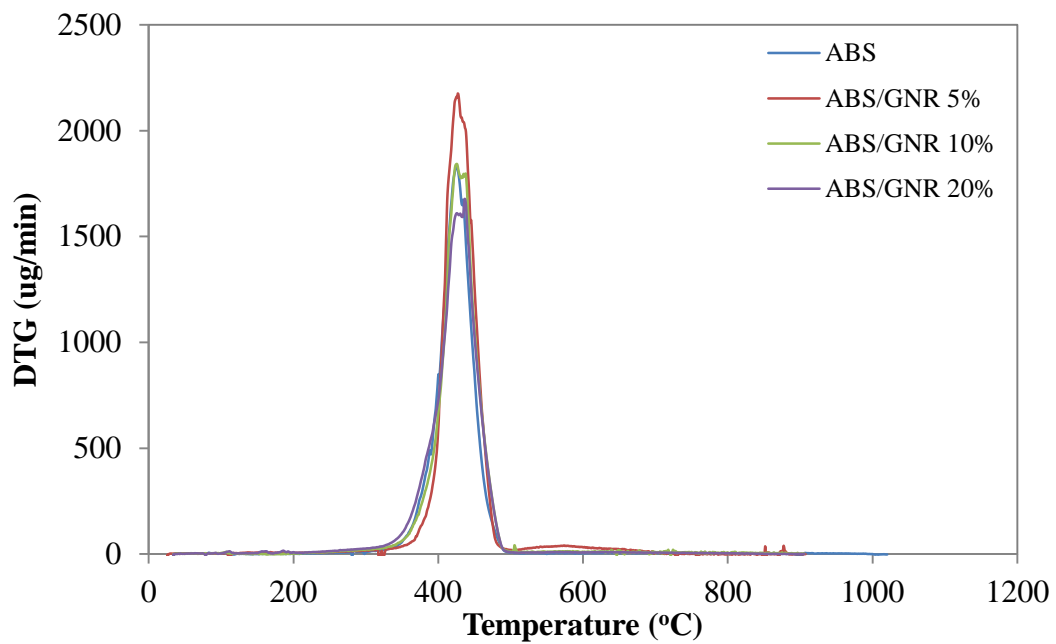

Figure F-4 DTG curves of ABS and ABS/PS-g-NR blends at various rubber content

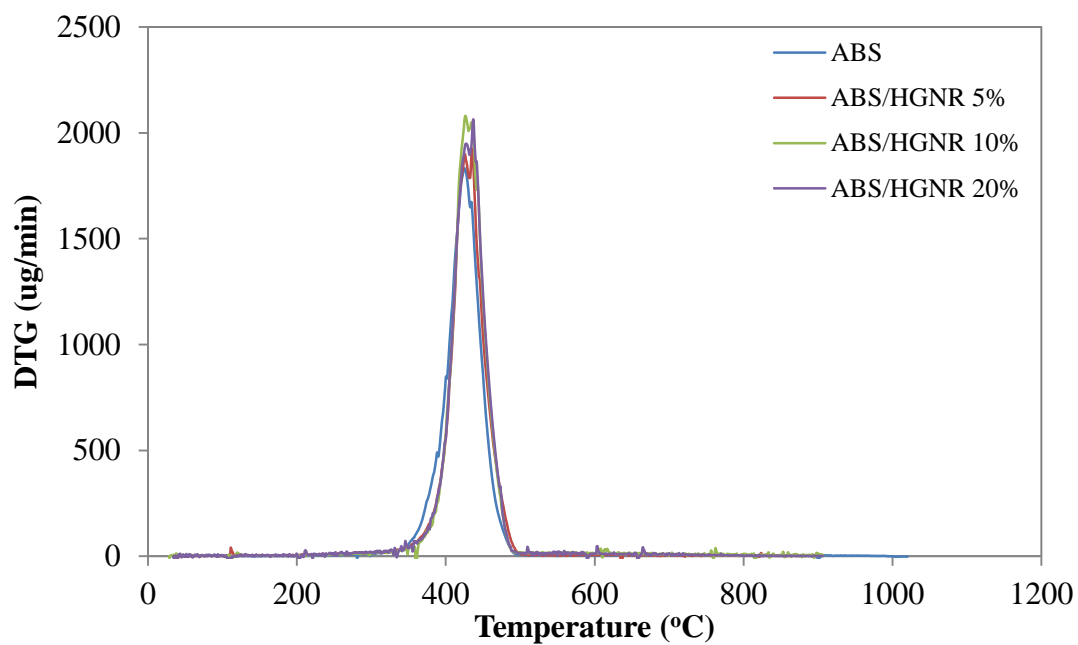

Figure F-4 DTG curves of ABS and ABS/H(PS-*g*-NR) blends at various rubber content

VITA

Mr. Anawat Pisuttisap was born on August 5, 1984 in Rayong, Thailand. He graduated with a Bachelor's Degree of Science in Industrial Chemistry from Department of Chemistry, Faculty of Science, King Mongkut's Institute of Technology North Bangkok in 2006. He has continued his study in Master Degree in the Program of Petrochemistry and Polymer Science, Faculty of Science, Chulalongkorn University since 2008 and finished his study in 2011.

Presentations at the national conference

2011 "Modified Natural Rubber Latex by Graft Copolymerization with Styrene and Diimide Hydrogenation, October 20-21, 2011, 2nd Polymer Conference of Thailand, Bangkok, Thailand.