

การตรวจวัดคลอรีนในเทคโนโลยีคาร์บอนที่ดูดซับบนฟิล์มพอลิเอทิลีนด้วย
เอทีอาร์-เอฟทีไออาร์สเปกโทรสโกปี



นางสาวทศสิมน์ วิริยะจันทร์

สถาบันวิทยบริการ

วิทยานิพนธ์นี้เป็นส่วนหนึ่งของการศึกษาตามหลักสูตรปริญญาวิทยาศาสตรมหาบัณฑิต

สาขาวิชาปิโตรเคมีและวิทยาศาสตร์พอลิเมอร์

หลักสูตรปิโตรเคมีและวิทยาศาสตร์พอลิเมอร์

คณะวิทยาศาสตร์ จุฬาลงกรณ์มหาวิทยาลัย

ปีการศึกษา 2545

ISBN 974-17-1491-2

ลิขสิทธิ์ของจุฬาลงกรณ์มหาวิทยาลัย

**MEASUREMENT OF CHLORINATED HYDROCARBONS ADSORBED ON
POLYETHYLENE FILM BY ATR-FTIR SPECTROSCOPY**

Miss Tassimon WiriyaChan

สถาบันวิทยบริการ

จุฬาลงกรณ์มหาวิทยาลัย

A Thesis Submitted in Partial Fulfillment of the Requirements
for the Degree of Master of Science in Petrochemistry and Polymer Science

Program of Petrochemistry and Polymer Science

Faculty of Science

Chulalongkorn University

Academic Year 2002

ISBN 974-17-1491-2

Thesis Title Measurement of Chlorinated Hydrocarbons Adsorbed on Polyethylene Film
by ATR-FTIR Spectroscopy
By Miss Tassimon Wiriyachan
Field of Study Petrochemistry and Polymer Science
Thesis Advisor Assistant Professor Sanong Ekgasit, Ph.D.

Accepted by Faculty of Science, Chulalongkorn University in Partial Fulfillment of the
Requirements for the Master's Degree

.....Dean of Faculty of Science
(Associate Professor Wanchai Phothiphichitr, Ph.D.)

Thesis Committee

.....Chairman
(Associate Professor Supawan Tantayanon, Ph.D.)

.....Thesis Advisor
(Assistant Professor Sanong Ekgasit, Ph.D.)

.....Member
(Assistant Professor Warinthorn Chavasiri, Ph.D.)

.....Member
(Polkit Sangvanich, Ph.D.)

ทัตติมนต์ วิริยะจันทร์: การตรวจวัดคลอรีเนเทดไฮโดรคาร์บอนที่ดูดซับบนฟิล์มพอลิเอทิลีนด้วยเอทีอาร์-เอฟทีไออาร์สเปกโทรสโกปี (MEASUREMENT OF CHLORINATED HYDROCARBONS ADSORBED ON POLYETHYLENE FILM BY ATR-FTIR SPECTROSCOPY) อาจารย์ที่ปรึกษา: ผศ. ดร. สนอง เอกสิทธิ์, 87 หน้า. ISBN 974-17-1491-2

เทคนิคแอกเทนนูเอทเททโททอลรีเฟรกชันฟูเรียร์ทรานสฟอร์ม อินฟราเรด หรือ เอทีอาร์-เอฟทีไออาร์สเปกโทรสโกปี เป็นเทคนิคที่นำมาใช้ประโยชน์เพื่อวิเคราะห์คุณลักษณะทางพื้นผิวสำหรับศึกษาการแพร่ของสารในพอลิเมอร์ เทคนิคเอทีอาร์เป็นเทคนิคที่เหมาะสมในการใช้อธิบายอันตรกิริยาที่เกิดขึ้นระหว่างพอลิเมอร์กับสารที่แพร่ เพื่อหาค่าคงที่ของการแพร่ของสารโมเลกุลขนาดเล็ก โดยฟิล์มพอลิเมอร์จะทำให้สารไฮโดรคาร์บอนที่มีคลอรีนเป็นองค์ประกอบชนิดละลายน้ำได้มีปริมาณมากในฟิล์ม และช่วยเพิ่มความเข้มข้นของสารดังกล่าวในช่วง Penetration Depth ของเอทีอาร์ปริซึม วัตถุประสงค์ของงานวิจัยนี้ เพื่อศึกษาพฤติกรรมการแพร่ และหาค่าคงที่ของการแพร่ของสารไฮโดรคาร์บอนที่มีคลอรีน เป็นองค์ประกอบในพอลิเมอร์ โดยความสำคัญของการศึกษานี้ คือเพื่อให้เข้าใจถึงกระบวนการแพร่ของสารเข้าไปในพอลิเมอร์ โดยมีการเปลี่ยนแปลงตัวแปรของทั้งพอลิเมอร์ (เปอร์เซ็นต์ความเป็นผลึก และสารเติมแต่ง) รวมทั้งสมบัติของสารที่แพร่ (ชนิดของสาร และความเข้มข้น) ข้อมูลที่ได้จะเป็นพื้นฐานในการประดิษฐ์เอทีอาร์เซนเซอร์ชนิดใหม่เพื่อใช้วิเคราะห์สารไฮโดรคาร์บอนที่มีคลอรีนเป็นองค์ประกอบ ทั้งชนิดละลายน้ำได้และชนิดที่ละลายน้ำได้น้อยที่เจือปนในน้ำ

สถาบันวิทยบริการ
จุฬาลงกรณ์มหาวิทยาลัย

ภาควิชา..... -ลายมือชื่อนิติ.....
สาขาวิชาปิโตรเคมีและวิทยาศาสตร์พอลิเมอร์.....ลายมือชื่ออาจารย์ที่ปรึกษา.....
ปีการศึกษา..... 2545ลายมือชื่ออาจารย์ที่ปรึกษาร่วม.....

4372272623: MAJOR PETROCHEMISTRY AND POLYMER SCIENCE

KEYWORD: ATR FT-IR SPECTROSCOPY, DIFFUSION, ADSORPTION,
CHLORINATED HYDROCARBONS

TASSIMON WIRIYACHAN: MEASUREMENT OF CHLORINATED
HYDROCARBONS ADSORBED ON POLYETHYLENE FILM BY ATR- FTIR
SPECTROSCOPY. THESIS ADVISOR: ASST. PROF. SANONG EKGASIT, Ph.D.
87 pp. ISBN 974-17-1491-2

Attenuated total reflection Fourier transform infrared (ATR FT-IR) spectroscopy is a powerful technique for surface characterization of penetrant diffusion through polymer. The ATR technique has been successfully employed for characterization of polymer-penetrant interaction and also for *in-situ* determination of the diffusion coefficient to small molecules. Polymer film enriches the chlorinated hydrocarbons and concentrates them within the penetration depth of the evanescent region of the ATR prism. The aim of this study was to investigate the diffusion behavior and to determine the diffusion coefficient of chlorinated hydrocarbon compounds in polymer matrix. This work gain an insight understanding of the diffusion of small molecules into LDPE film as a function of time by varies parameters of both polymer (Percentage of crystallinity and Additive) and diffusant properties (Species and Concentration). The information obtained from this study will be employed for designing new ATR sensor for measurement both dissolved and slightly dissolved chlorinated hydrocarbons in water.

Department..... Student's signature.....
Field of study.....Petrochemistry and Polymer Science..... Advisor's signature.....
Academic year.....2002..... Co-advisor's signature.....

ACKNOWLEDGEMENTS

This research would never been finished in a timely manner if not endless efforts of my thesis advisor, Assistant Professor Dr. Sanong Ekgasit who always provides me the suggestion and encouragement during the whole research.

Special thanks are extended to all members of Spectroscopy Research Group. Especially, Miss Jitraporn Vongsvivut who recommends the wording of the whole thesis book.

I would like to thank you for chemical support, 4-chlorobenzaldehyde from Organic Synthesis Research Unit and standard solution of pesticides (i.e., Endrin, Endosulfan-sulfate and DDT) from Agricultural Toxic Substance Division, Ministry of Agriculture and Cooperatives and Bruker Vector33 FT-IR spectrometer supported from Bruker Optics Thailand.

Finally, I would like to affectionately give all gratitude to the members of my family for their love, understanding and patient support throughout my entire study.

สถาบันวิทยบริการ
จุฬาลงกรณ์มหาวิทยาลัย

CONTENTS

	Page
ABSTRACT IN THAI.....	iv
ABSTRACT IN ENGLISH.....	v
ACKNOWLEDGEMENTS.....	vi
LIST OF FIGURES.....	xii
LIST OF TABLE.....	xvi
LIST OF ABBREVIATIONS.....	xvii
LIST OF SYMBOLS.....	xviii
CHAPTER I INTRODUCTION.....	1
1.1. Diffusion behavior of chlorinated hydrocarbon into polymer film by ATR FT-IR spectroscopy.....	1
1.2 The objective of this research	3
1.3 The scope of this research.....	3
CHAPTER II THEORETICAL BACKGROUND.....	4
2.1. Low-density polyethylene (LDPE).....	4
2.1.1 Processing and physical properties of LDPE film.....	5
2.1.2 Determination of LDPE crystallinity.....	6
2.2 ATR FT-IR spectroscopy.....	7
2.2.1 Internal reflection element (IRE).....	8
2.2.2 ATR attachment.....	9
2.2.3 Theory of total internal reflection spectroscopy.....	10
2.2.3.1 Theoretical background.....	10
2.2.3.2 Contact problem in ATR measurement.....	16
2.3 Diffusion of small molecules into polymer film.....	17

CONTENTS (Continued)

	Page
2.3.1 Type of the diffusion phenomena.....	17
2.3.1.1 Case I Diffusion or Fickian Diffusion.....	17
2.3.1.2 Case II Diffusion.....	18
2.3.1.3 Case III Diffusion or non-Fickian or anomalous diffusion.....	18
2.3.2 The mathematics of diffusion.....	19
2.3.3 ATR FT-IR spectroscopy applied to diffusion in polymer.....	20
2.4 ATR FT-IR spectroscopy for observation of contaminates in waste water.....	23
 CHAPTER III EXPERIMENT.....	 25
 3.1. Dissolved chlorinated hydrocarbons in water.....	 25
3.1.1. Preparation of low-density polyethylene (LDPE) film...	25
3.1.1.1 Materials and equipment.....	25
3.1.1.2 Methodology.....	25
3.1.1.2.1 Preparation of LDPE solution....	25
3.1.1.2.2 Preparation of spin-coated LDPE film on Ge IRE.....	26
3.1.1.2.3 Preparation of dip-coated LDPE film on PTFE plate.....	26
3.1.1.2.4 Preparation of hot-pressed LDPE film.....	27
3.1.1.2.5 Preparation of solvent-cast LDPE film.....	27
3.1.2 Preparation of chlorinated hydrocarbon solution.....	27

CONTENTS (Continued)

	Page
3.1.4.3.1 Effect of free volume in polymer film on diffusion behavior.....	38
3.1.4.3.2 Initial absorption.....	39
3.2 Slightly dissolved compounds contaminated in water.....	40
3.2.1 Materials and equipment.....	40
3.2.2 Methodology.....	41
3.2.2.1 Preparation of LDPE film.....	41
3.2.2.2 Preparation of 100 ppm pesticide solution.....	41
3.2.3 Determination of slightly dissolved compounds in water.....	41
3.2.3.1 Adsorption of fluorolube on LDPE film.....	41
3.2.3.2 Adsorption of pesticides on LDPE film.....	42
3.2.3.3 Diffusion behavior of the pesticides through LDPE film.....	43
 CHAPTER IV RESULTS AND DISCUSSION.....	 45
4.1 ATR FT-IR signal enhancement	45
4.2 Efficiency of the ATR sensor.....	47
4.3 Effect on diffusion behavior of dissolved chlorinated hydrocarbons into LDPE film.....	49
4.3.1 Time dependent phenomena.....	49
4.3.2 Effect of chlorinated hydrocarbon species.....	52
4.3.3 Effect of solution concentration.....	55
4.3.4 Effect of polymer morphology.....	57
4.3.5 Effect of polymer film thickness.....	59

CONTENTS (Continued)

	Page
4.3.6 Effect of additive in polymer matrix.....	63
4.3.7 Effect of free volume in polymer film on diffusion behavior.....	65
4.3.8 Initial absorption of 1000 ppm TCE on hot-pressed LDPE film.....	66
4.4 Slightly dissolved compounds contaminated in water.....	68
4.4.1 Adsorption of fluorolube and pesticides on LDPE film..	68
4.4.2 Diffusion behavior of pesticides.....	69
4.5 Drawback of current ATR sensor.....	71
CHAPTER V CONCLUSIONS.....	73
REFERENCES.....	74
APPENDICES.....	77
VITAE.....	87

สถาบันวิทยบริการ
จุฬาลงกรณ์มหาวิทยาลัย

LIST OF FIGURES

Figure	Page	
1.1	The schematic illustration of ATR FT-IR sensor based on evanescent wave for chlorinated analytes diffusing into the polymer layer.....	2
2.1	Molecular structure of polyethylene.....	4
2.2	Schematic illustration of linear polyethylene (HDPE) and branch polyethylene (LDPE).....	5
2.3	FT-IR spectrum of LDPE, the CH ₂ rocking vibration at 720 and 730 cm ⁻¹ represent the amorphous content in LDPE structure.....	6
2.4	Common IRE configurations used for experimental ATR setups: (1) single-reflection variable angle hemispherical or hemicylinder crystal, and (2) multiple-reflection planar crystal.....	8
2.5	A Schematic illustration of the variable-angle reflection attachment, the Seagull TM	9
2.6	Schematic illustration of the beam leading to the total internal reflection phenomenon.....	10
2.7	Decay pattern of evanescence wave under ATR condition.....	13
2.8	Relationship between penetration depth and wavenumber for Ge crystal ($n = 4.0$) and ZnSe crystal ($n = 2.45$) at different angle of incidence.....	14
2.9	The MSEF at various experimental condition (A, A') and its decay characteristic (B, B'). The simulation parameters are $n_1 = 4.00$, for Ge, $n_1 = 2.40$ for ZnSe, $\nu = 1000 \text{ cm}^{-1}$, $n_2(\nu) = 1.50$, $k_1(\nu) = 0.0, 0.1, 0.2, 0.3, 0.4, \text{ and } 0.5$, respectively.....	15
3.1	Experimental setup for the diffusion study of chlorinated hydrocarbon into LDPE film coated on the Ge IRE.....	30

LIST OF FIGURES (Continued)

Figure	Page
3.2	Configuration of ATR sensor using a thin LDPE film coated on PTFE plate as a probe..... 36
3.3	Setup for ATR experiment using a thick LDPE film as a probe..... 39
4.1	ATR spectrum of water with 1000 ppm chlorinated hydrocarbons (trichloroethylene and carbon tetrachloride). Note: the spectra are dominated by absorption band of water. Spectra of both solutions are indistinguishable..... 45
4.2	Spectral enhancement observed by coating LDPE film on Ge ATR prism as a probe for studying the enrichment of weak absorption peaks of chlorinated hydrocarbons: trichloroethylene (A) and carbon tetrachloride (B). The concentration of each sample solution is 1000 ppm..... 46
4.3	ATR spectra of the LDPE films with different preparation techniques: spin-coating (A), hot-pressing (B), and solution-casting..... 48
4.4	The determination of dissolved chlorinated hydrocarbon compounds in water by spin-coated LDPE film on IRE..... 49
4.5	Diffusion of trichloroethylene in LDPE film. The strongest peak at 932 cm^{-1} . (i.e., C-Cl stretching of trichloroethylene) was selected as a major peak for investigation..... 50
4.6	Time dependent absorption of TCE into LDPE film coated on Ge IRE. The absorption changed is observed at 932 cm^{-1} 51
4.7	Plot of $\ln (I-A_t/A)$ with time. The diffusion coefficient of trichloroethylene through LDPE film is calculated from slope..... 52
4.8	Enrichment response of dichloroethylene, trichloroethylene and carbon tetrachloride in LDPE film coated on Ge ATR prism. The concentrations of the analytes were all the same at 1000 ppm. New polymer films of same thickness were used for each experiment..... 53

LIST OF FIGURES (Continued)

Figure	Page	
4.9	Time dependent absorption carbon tetrachloride, dichloroethylene and trichloroethylene through the LDPE film coated on Ge IRE.....	54
4.10	Plot of $\ln (I-A_t/A)$ with time. The diffusion coefficients of 1000 ppm trichloroethylene, dichloroethylene and carbon tetrachloride through the LDPE film are calculated from slopes.....	54
4.11	Time dependent absorbance of 1000, 700 and 100 ppm trichloroethylene through the LDPE film coated on Ge IRE.....	56
4.12	Plot of $\ln (I-A_t/A)$ with time. The diffusion coefficients of 1000, 700 and 100 ppm trichloroethylene through LDPE film are calculated from slopes of the curves.....	56
4.13	Time dependent absorption for diffusion of 1000 ppm trichloroethylene through an annealed LDPE film, as compared to that un-annealed LDPE film. Diffusion in the un-annealed film reached an equilibrium state faster with a greater absorbance.....	58
4.14	Plot of $\ln (I-A_t/A)$ with time of trichloroethylene diffusing through LDPE films. The diffusion coefficients are calculated from slope of the curves.....	58
4.15	Effect of polymer film thickness on diffusion of trichloroethylene. Concentration of trichloroethylene is 1000 ppm. Peak height was observed at 932 cm^{-1} . In case of TCE, the thick film shows lower equilibrium than the thin film.....	60
4.16	The plot of $\ln (I-A_t/A)$ with time. The diffusion coefficients of trichloroethylene through thick and thin LDPE film were calculated from slopes.....	61

LIST OF FIGURES (Continued)

Figure	Page	
4.17	The spectral intensity of C-Cl stretching band at various film thickness after 1-minute enrichment. The LDPE coated on (1.3 x 2.5 cm ⁻¹) flat PTFE plate was used as a probe.....	62
4.18	ATR FT-IR spectrum of a dip-coated LDPE film on a PTFE plate. The LDPE solution is composed of 4-chlorobenzaldehyde, which shows characteristic of C=O stretching at 1758 cm ⁻¹	63
4.19	Absorbance of C-Cl stretching band after 15 minutes enrichment as a function of 4-chlorobenzaldehyde concentration	64
4.20	The absorption intensity of C-Cl stretching (932 cm ⁻¹) versus time presents diffusion behavior of 1000 ppm trichloroethylene through solvent-cast and hot-pressed LDPE films. The enriched analyte at surface of hot pressed film shows higher signal than using solvent cast film as a probe.....	66
4.21	Initial absorption of 1000 ppm trichloroethylene, detected on hot-pressed LDPE film of various thickness. The absorption is independent to the film thickness.....	67
4.22	Adsorption of fluorolube (A), DDT (B), Endosulfan-sulfate (C) and Endrin (D) on hot-pressed LDPE film. The sensor shows good response in a short period of time.....	69
4.23	ATR spectra of adsorbed species on spin-coated LDPE film: Endosulfan-sulfate (A), DDT (B) and Endrin (C). The molecule is allowed to diffuse into the polymer film for 30 minutes while spectra were collected at the interval of 5 minutes.....	70
4.24	Spectral comparison using hot-pressed (—) and spin-coated LDPE film (-----) as a probe.....	71

LIST OF TABLE

Table	Page
4.1 Effect of polymer morphology on diffusion coefficient.....	57



สถาบันวิทยบริการ
จุฬาลงกรณ์มหาวิทยาลัย

LIST OF ABBREVIATIONS

ATR	: attenuated total reflection
d_p	: penetration depth
FT-IR	: Fourier transform infrared
Ge	: germanium
IRE	: internal refraction element
A	: absorbance
R	: reflectance
D	: diffusion coefficient
MSEF	: mean square electric field
MSEvF	: mean square evanescent field
LDPE	: low-density polyethylene
TCE	: trichloroethylene
CTC	: carbon tetrachloride
DCE	: dichloroethylene
PTFE	: polytetrafluoroethylene or Teflon

สถาบันวิทยบริการ
จุฬาลงกรณ์มหาวิทยาลัย

LIST OF SYMBOLS

θ	: angle of incidence
θ_c	: critical angle incidence
μ	: micro
ρ	: density
n	: refractive index
n_{21}	: refractive index ratio for reflecting interface, $n_{21} = n_2/n_1$



สถาบันวิทยบริการ
จุฬาลงกรณ์มหาวิทยาลัย

CHAPTER I

INTRODUCTION

1.1 Diffusion behavior of chlorinated hydrocarbons into polymer film by ATR FT-IR spectroscopy

Chlorinated hydrocarbons (CHCs) have been widely used in industrial degreasing and dry-cleaning operations as well as agricultural activities such as pesticides and agrochemical. These chemicals are mostly found as contaminants in the ground water and soil. They have been increasingly hazardous to the environment and many of them are additionally known to be toxic or carcinogenic. Under whether anoxic or anaerobic condition, they can be fortuitously bio-transformed by reductive dechlorination to produce a series of lower chlorinated homologs. Trichloroethylene, dichloroethylene and carbon tetrachloride are among the most frequent chlorinated aliphatic primary contaminants presenting in the ground water at low quantity but its concentrations are non-negligible. As a consequence to quantify these pollutants in contaminant areas is of importance. Current methods for analysis of contaminants in water and soil involve sample enrichment by liquid-liquid extraction, solid-phase extraction for water or liquid-solid extraction for soils. In addition the CHCs can be analysed by gas chromatography (GC), gas chromatography-mass spectrometry (GC-MS) as well as liquid chromatography. In general, these techniques have been involved with complex experimental procedures and time-consuming separation steps with expensive operation costs. The methods are not practical for field-testing, continuous monitoring for screening a large number of samples.

Fourier transform infrared spectroscopy (FT-IR) has been successfully employed as a noninvasive technique for identifying chemical compositions and concentration of chemical moiety in a material. Used of FT-IR spectroscopy for the analyzing samples in

aqueous solution has been limited primarily by the broad absorption bands of water in the mid-infrared region, which obscures the infrared (IR) spectra of analytes. However, ATR FT-IR spectroscopy is successfully eliminate the water absorption problem and has been employed for determinations of dissolved chlorinated hydrocarbons in water.

ATR spectroscopy is well known surface-sensitive technique based on total internal reflection which occurs only if the incident IR light travels with angles larger than critical angle (θ_c) from a medium of internal reflection element (IRE) with high refractive index through the lower index medium of sample layer. The incident IR light inside the IRE is consequently reflected through its inner flat surfaces. At each reflection, a standing evanescent wave is established and penetrates a portion of radiation energy into the sample medium with a shallow depth of penetration (d_p) as presented in figure 1.1. With the traditional IR technique, the absorption bands of water completely cover the absorption peaks of analytes. Thus, water must be excluded in order to improve the sensitivity of the technique. Coating a hydrophobic polymer over the IRE surface impedes water molecules from interacting with IR radiation and results in the selective diffusion of chlorinated hydrocarbon molecules into polymer film where they are detected though their IR absorption. The polymer layer acts continuously as reversible extracting medium, so that detection limits of this method can be improved from high ppm to a few ppm and therefore the measurement with samples in very low concentrations becomes possible.

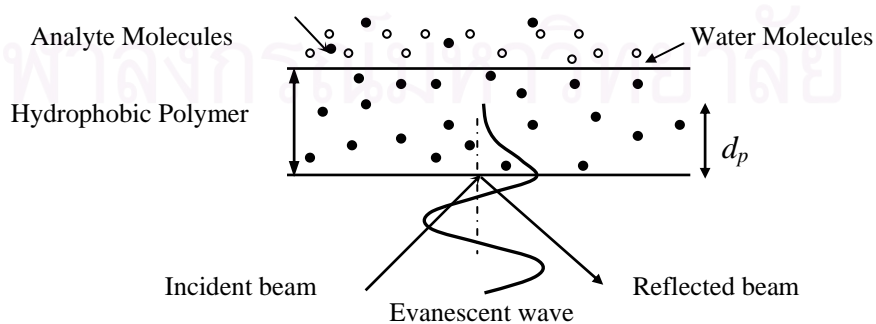

Figure 1.1 The schematic illustration of ATR FT-IR sensor based on evanescent wave for chlorinated analytes diffusing into the polymer layer.

The ATR technique gives a fairly general solution to the restriction of strong water absorption, even in case that analytes are insufficiently high concentrations in aqueous solution. Thin polymer films have been demonstrated as absorbers for chlorinated hydrocarbon molecules good upon exposure.¹ This property as well as general merits (i.e., good stability, fast response time), encourage polymer as receptor materials for IR chemical sensors. Even a little amount of analytes can be sensed selectively by their fundamental absorption bands in the mid-IR region. The molecules monitored diffuse into thin polymer layer with the thickness in range of sub-micrometer range.

1.2 The objective of this research

The objective of this research is to study the effect of both polymer film and the properties of dissolved organic compounds on diffusion behavior. And design new infrared sensor based on ATR FT-IR spectroscopy for determination of both dissolved (trichloroethylene, dichloroethylene and carbon tetrachloride) and non-dissolved chlorinated hydrocarbons (Endrin, Endosulfan-sulfate, and DDT) in water. The theoretical and experimental investigations of the new sensors will be performed in order to explore their limitation, advantages and disadvantages. The optical sensor is based on hemisphere Ge IRE with low-density polyethylene (LDPE) coating at the surface.

1.3 The scope of this research

1. To develop new ATR sensor with enhancing sensitivity for sensing dissolved chlorinated hydrocarbons diffusing into polymer film.
2. To study the effects of both polymer film and diffusing molecule on diffusion behavior for improving detection limit and decreasing the experimental time.

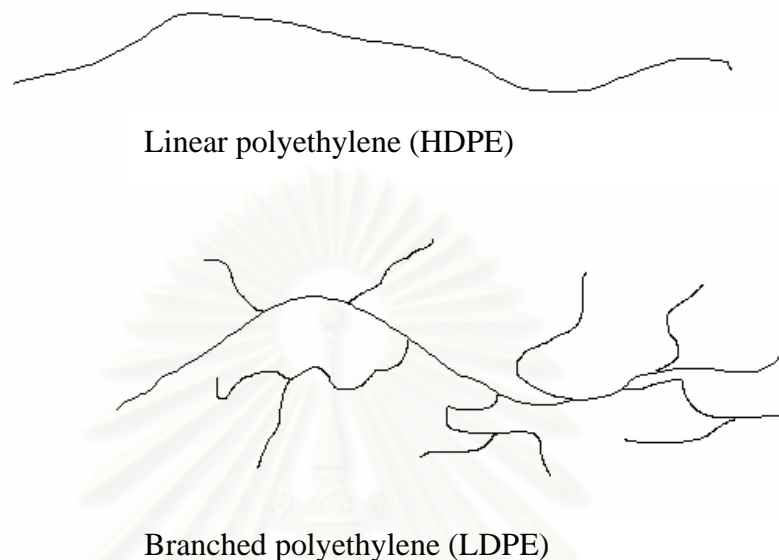

Figure 2.2 Schematic illustration of linear polyethylene (HDPE) and branch polyethylene (LDPE)

2.1.1 Processing and physical properties of LDPE film

Polyethylene, discovered in the early 1930s, was first produced by radical polymerization. It is called low-density polyethylene (LDPE) or high-pressure polyethylene in order to distinguish from the polyethylene synthesized using coordination catalysts. High-density polyethylene (HDPE) or low-pressure polyethylene (LDPE) is more highly branched (both short and long branches) than HDPE. As a consequence, LDPE has lower crystallinity (40-60% vs. 70-90% for HDPE) and density ($0.91-0.93 \text{ g/cm}^3$ vs $0.94-0.96 \text{ g/cm}^3$ for HDPE).²

LDPE has a wide range and combination of desirable properties. Its very low T_g (-120°C) and moderately high crystallinity with T_m of $105-115^\circ\text{C}$ give flexibility and utility for being applied over a wide range of temperature. It has a good combination of strength, flexibility, impact resistance, and melt flow behavior. The

nature of alkane appearing in polyethylene imparts a very good combination of properties. Polyethylene is highly resistant to water and many aqueous solutions even at high temperature. It has been a good oxidation resistance; although it is slowly attacked by oxidizing agent and swollen by hydrocarbon and chlorinated hydrocarbon solvents at room temperature. Polyethylene is a very good electrical insulator. Commercial LDPE have a number of average-molecular weights in the range of 20,000-100,000 with the \bar{X}_w/\bar{X}_n of 3-20. A wide varieties of LDPE products are produced with different molecular weight, molecular-weight distributions, and extents of branching (which affects crystallinity, density, and strength properties). The LDPE property depends on the polymerization temperature, pressure (i.e., concentration of ethylene and reactor type). Long-chain branching increases with increasing temperature and conversion, but it decreases with higher pressure applied.

2.1.2 Determination of LDPE crystallinity

FT-IR spectrum of LDPE shows three prominent peaks including C-H stretching at 2919, 2850 cm^{-1} and C-H bending at 1473, 1464 cm^{-1} as well as C-H rocking at 730, 720 cm^{-1} .

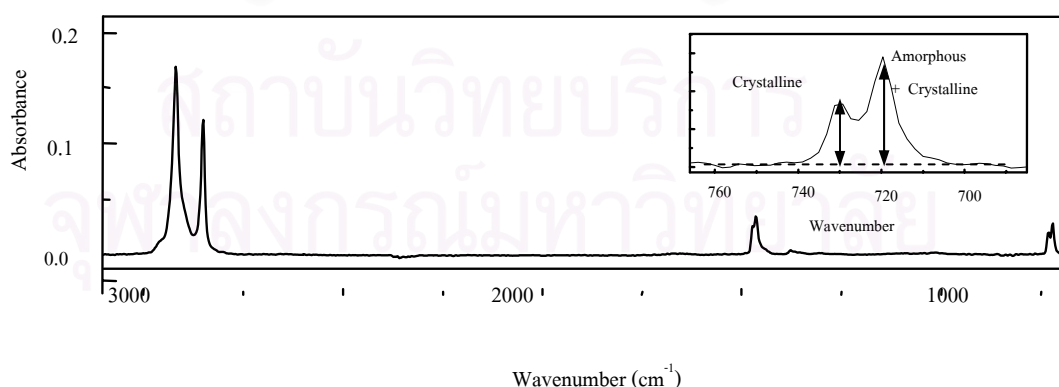

Figure 2.3 FT-IR spectrum of LDPE. The CH_2 rocking vibration at 720 and 730 cm^{-1} represent the amorphous content in LDPE structure.

The ATR spectrum of polyethylene contains only two bands as a result of pure crystalline (i.e., 1894 cm^{-1}) and pure amorphous (i.e., 1303 cm^{-1}) normal mode of vibration. Unfortunately the intensities of these bands are hardly sufficient for used in ATR quantitative analysis. Therefore, more intense band such as CH_2 bending (1473 and 1464 cm^{-1}) and rocking (730 and 720 cm^{-1}) normal vibrations were employed. The bands at 1473 and 730 cm^{-1} correspond to crystalline phase while those at 1464 and 720 cm^{-1} represent contributions from both crystalline and amorphous phases. In principle, these bands can be used to determine the amorphous content by means of the following empirical relationship:³

$$\% \text{Amorphous} = \frac{(I_b - I_a)/1.233}{I_a + I_b} \times 100 \quad (2.1)$$

where I_a and I_b are the peak intensities at whether 730 and 720 cm^{-1} , or 1474 and 1464 cm^{-1} bands, depending on which pair is chosen for analysis. The constant of 1.233 in both equations is a ratio of these intensities obtained with pure crystalline polyethylene and was further derived by applying factor group splitting to a single polyethylene crystal.

2.2 ATR FT-IR spectroscopy

Attenuated total reflection Fourier transform infrared (ATR FT-IR) spectroscopy was developed by Harrick and Fahrenfort in the 1960's.⁴ ATR FT-IR spectroscopy is well known as a surface characterization and depth profiling technique. In contrast to transmission technique, sampling depth in the ATR technique is defined with respect to the decay characteristic of electric field. The depth range from sub-micrometer to micrometer depending on experimental conditions and material characteristics. ATR FT-IR spectroscopy has been employed for various applications such as qualitative and quantitative analyses, surface characterization, molecular orientation, diffusion of small molecules into polymer film, and depth profiling. An ATR spectral intensity involves complex relationships between experimental conditions (i.e., angle of incidence, polarization, and number

of reflections) and material characteristics (i.e., refractive index of internal reflection element (IRE) and complex refractive index of absorbing medium).

2.2.1 Internal Reflection Elements (IRE)

The internal reflection element (IRE) is an important part of ATR accessories. IRE is basically made of infrared transparent material with high refractive index and such as zinc selenide (ZnSe) and germanium (Ge). In general, the IRE configuration included variable-angle hemispherical crystals with single reflection and multiple-reflection planar crystals (figure 2.4). ATR spectra are easily obtained by placing the sample against the IRE while infrared beam is couple into the IRE. The information obtained from the spectrum is dependent on several factors such as properties of IRE, angle of incidence, number of reflections, aperture, surface preparation, sample-IRE contact, and the material itself.

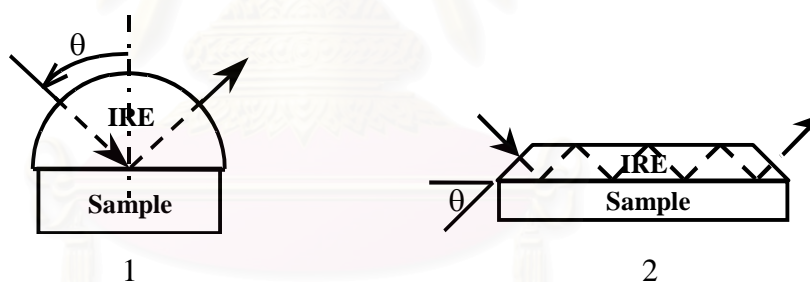

Figure 2.4 Common IRE configurations used for experimental ATR setups: (1) single-reflection variable angle hemispherical or hemicylinder crystal, and (2) multiple-reflection planar crystal.

2.2.2 ATR attachment

The ATR attachment holds the IRE, directs the incident beam into the IRE, and then redirects the emerging energy onto the detector without displacing or defocusing the beam while maintaining the same beam spread. The IRE is placed inside the sample compartment of a spectrometer.

The IRE configuration used in this research is single-reflection variable-angle hemispherical crystal made of germanium equipped with a multifunctional variable-angle reflection attachment, the SeagullTM (Harrick Scientific, Ossening, NY, USA). By using this accessory, the angle of incidence can be varied from 5° to 85°. A schematic illustration of SeagullTM is shown in figure 2.5. By changing the angle of mirror M₃, light can be directed to various areas of first ellipsoid, E₁. This ellipsoid reflects light to the sample and then reflected light from the sample is collected by the second ellipsoid, E₂ and then the light will be redirected to mirror M₄, M₅, M₆ and finally to detector.

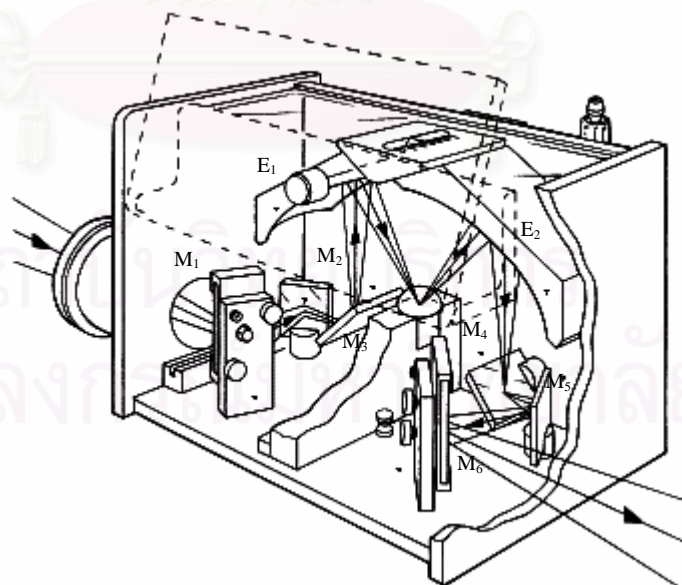

Figure 2.5 A schematic illustration of the variable-angle reflection attachment, the SeagullTM

2.2.3 Theory of total internal reflection spectroscopy

2.2.3.1 Theoretical background

According to total internal reflection at the interface between two media of different refractive indices, Newton discovered that the light extends into the rarer medium beyond the reflecting surface.⁵ In internal reflection spectroscopy this phenomenon is employed to obtain absorption spectra by investigating interactions of the penetrating radiation with a sample layer beyond the IRE.

Electromagnetic radiation that strikes at interface between two non-absorbing media with different refractive indices is partially transmitted and partially reflected. The angular relationship between the incident and refracted rays of the transmitted beam is given by Snell's law:⁶

$$n_1 \sin \theta_1 = n_2 \sin \theta_2 \quad (2.2)$$

where θ_1 is the angles of incidence, θ_2 is the angle refraction, n_1 is the refractive indices of optically dense medium, n_2 is the refractive index of the rarer medium, respectively.

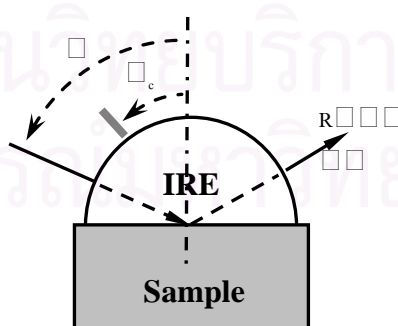

Figure 2.6 Schematic illustration of the beam leading to the total internal reflection phenomenon.

An IRE utilized in ATR spectroscopy is a crystal of IR transparent material with high refractive index, with which the sample is in intimate contact as illustrated in figure 2.6. The light strikes the crystal-sample interface with an angle of incidence greater than the critical angle (θ_c). The critical angle can be calculated from the refractive indices of the denser medium and the rarer medium by following expression:⁷

$$\theta_c = \sin^{-1} \frac{n_2}{n_1} \quad (2.3)$$

where θ_c is the critical angle. The complex refractive index of a medium $\hat{n}(\nu)$ is defined as:⁷

$$\hat{n}_2 = n_2 + i k_2 \quad (2.4)$$

where i is equal to $\sqrt{-1}$, n_2 and k_2 are refractive index and absorption index, respectively.

Under non-absorbing condition (i.e., the absorption index of the rarer medium equals zero), the incident light is totally reflected at the interface. Since no light travels across the interface and there is no reflection loss due to absorption, this phenomenon is defined as the total internal reflection. When the rarer medium is absorbing (i.e., the absorption index is greater than zero), there is a reflection loss due to absorption by the material. As a consequence, reflectance of the beam leaving IRE/sample interface is less than unity. This phenomenon is therefore defined as attenuated total reflection (ATR), the following expression is obtained for ATR spectral intensity:

$$A(\theta, \nu) = 1 - R(\theta, \nu) \quad (2.5)$$

where $A(\theta, \nu)$ is absorptance and $R(\theta, \nu)$ is reflectance. Absorptance in ATR can be expressed in terms of experimental parameters and material characteristics by the following expression:

$$A_{\bar{p}}(\theta, \nu) = \frac{4\pi\nu}{n_1 \cos \theta_0} \int_0^{\infty} n_2(\nu) k_1(\nu) \langle E_z^2(\theta, \nu) \rangle dz \quad (2.6)$$

where \bar{p} indicates degree of polarization of the incident beam, $\langle E_z^2(\theta, \nu) \rangle$ is the mean square electric field (MSEF) at depth z .

Under the ATR condition, although there is no light travels across the IRE/sample interface, there is an electric field generated at the boundary called the evanescent field. The field is strongest at the interface and exponentially decays as a function of distance from the interface. The rapid decay of the evanescent field is the unique characteristic of the technique that makes ATR as a powerful surface characterization. The decay pattern of the evanescent field can be expressed in terms of the distance from IRE/sample interface by the following expression:⁷

$$\langle E_z^2 \rangle = \langle E_0^2 \rangle e^{-2z/d_p} \quad (2.7)$$

when $\langle E_0^2 \rangle$ and $\langle E_z^2 \rangle$ are the mean square evanescent fields at the surface and at the depth z in the rarer medium, respectively. The evanescent field at the surface of a rarer medium is determined by the angle of incidence, the refractive indices of two media, and the polarization of the incident radiation.

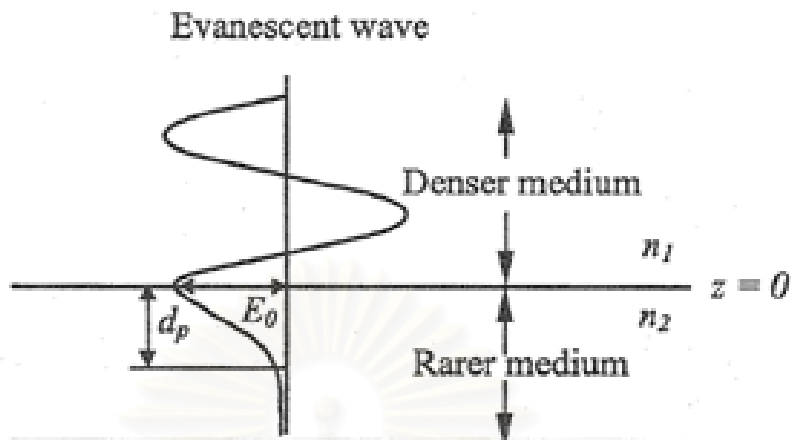

Figure 2.7 Decay pattern of evanescence wave under ATR condition

A penetration depth of the evanescent field is generally defined as the distance into the sample at which the amplitude of the field becomes to $1/e$ of its original value. The penetration depth is given by the following expression:⁷

$$d_p = \frac{\lambda}{2\pi n_1 (\sin^2 \theta - n_{21}^2)^{1/2}} \quad (2.8)$$

where λ is the wavelength of incident radiation, and n_{21} the ratio of refractive indices between sample (n_2) and IRE (n_1). By altering the angle of incidence while ensuring that it remains larger than the critical angle, the depth of penetration is consequently varied.

The penetration depth is a function of experimental conditions and material characteristic. Example of penetration depth at various experimental conditions and material characteristic are shown in figure 2.8.

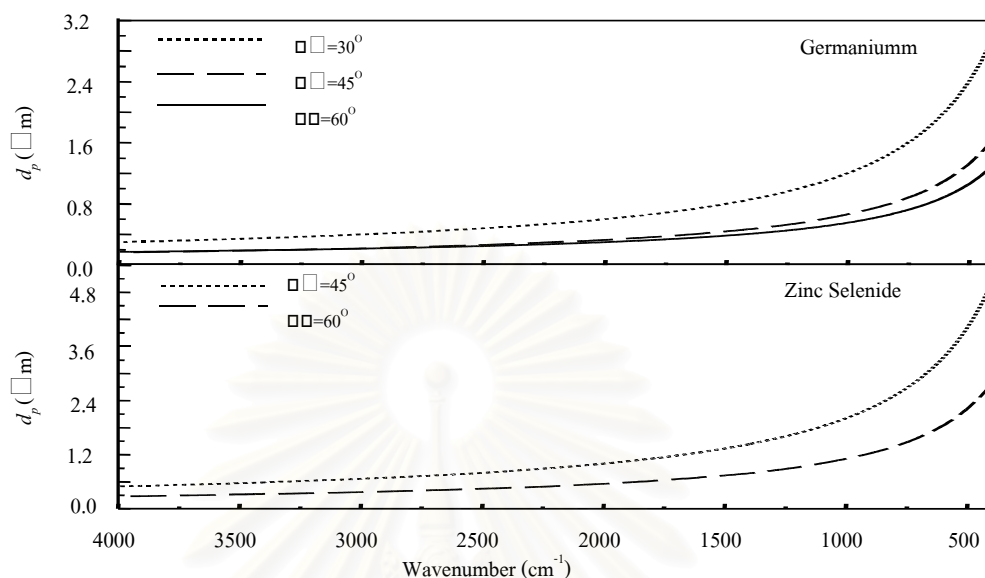

Figure 2.8 Relationship between penetration depth and wavenumber for Ge crystal ($n = 4.0$) and ZnSe crystal ($n = 2.4$) at different angle of incidence.

Figure 2.8 shows that the penetration depth depends strongly on the experimental condition and material characteristic. Under an experimental condition, the absorption increases with the absorption index $k_I(\nu)$. In fact, if one wants to calculate the MSEF, the complex refractive index of the material (i.e., the refractive index and the absorption index) must be known. Under a non-absorbing condition (i.e., $k_I(\nu) = 0$). The MSEF can be calculated if the refractive index of material is known. Under this condition, the MSEF is given a special name as the mean square evanescent field (MSEvF). The strength and decay characteristic of the MSEF is show in figure 2.9.

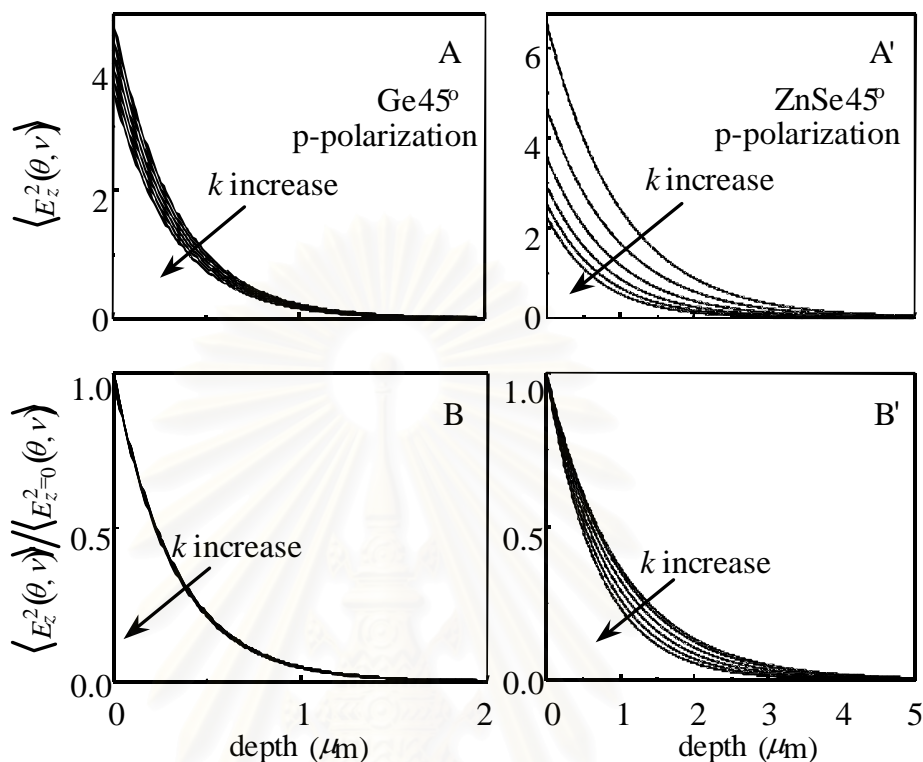

Figure 2.9 The MSEF at various experimental condition (A, A') and its decay characteristic (B, B'). The simulation parameters are $n_1 = 4.00$ for Ge, $n_1 = 2.40$ for ZnSe, $\nu = 1000 \text{ cm}^{-1}$, $n_2(\nu) = 1.50$, $k_1(\nu) = 0.0, 0.1, 0.2, 0.3, 0.4, \text{ and } 0.5$, respectively.

According to equation 2.6 and the decay characteristic of the electric field, only a thin layer of film near the surface is sampled. In principle, the spectrum depends on the composition of sample surface in contact with the IRE. This may be different from the bulk of sample. Absorption intensities at a certain wavenumber depend on the angle of incidence and relative refractive index, n_{21} , and therefore caution is advisable when comparing spectra with those obtained with transmission method.

2.2.3.2 Contact problem in ATR measurement

ATR FT-IR is a surface sensitive technique. In an attempt to achieve good ATR spectra, very good contact between the sample and an IRE is required. Liquid samples always have a perfect contact with an IRE. Solid samples, on the other hand, rarely have a good contact with an IRE even in the case where their surfaces are mirror flat. This is due to surface irregularity of the samples, imperfect flatness throughout the surface and defect on the surface. In order to gain a good contact between a solid sample and an IRE, pressure must be applied. If the sample is harder than the IRE material, the applied pressure might damage the prism while only a little bit better contact is obtained. Unfortunately IRE materials used for ATR experiment are mostly brittle and a much better contact is required for light at high frequency due to small penetration depth.

ATR spectral intensity may be increased with incident angles approaching the critical angle but this leads to severely distorted spectra. At the present, there is micro ATR accessory particularly for the solid samples in which the radiation is focused on the specimen's surface.⁸ Thus one can select the best part on sample surface for analysis. On the other hand, this would be useful only if the sample surface has uniform properties. However, according to higher sensitivity, multiple reflection ATR can reduce contact-quality requirements, but large sample is recommended. However, it is still difficult to observe weak peak. Moreover, requires a perfect optical contact between sample and an IRE is a must for quantitative analysis by ATR FT-IR spectroscopy.

2.3 Diffusion of small molecules into polymer film

Transportation or diffusion is a function of structure of both polymer and the diffusing molecules. This includes both local chemical structure and long-range order, described as morphology. Temperature, solubility, reactivity, orientation and composition affect the transportation process.⁹ If processing induces orientation, the crystalline lamellae will be aligned with channels from which rapid depletion can occur.

The diffusion of small molecules (compared to the polymer molecule) through the polymer matrix depends on the polymer morphology, which controls the propagation of the molecule and the flexibility of the polymer chains is required to cooperate with such a movement. Any morphological factors that influence either the structure or the flexibility of the polymer are theoretically expected to change the diffusivity of the molecule.

Mechanical relaxation time decreases with increasing temperature and concentration of diffusing molecules. As a result, motions of the polymer segments are enhanced as the temperature increasing. When a penetrant diffuses into a rubbery polymer above its glass temperature, a rapid adjustment of the polymer chains occurs as a described by Fickian behavior. Most polymers have a broad range of mechanical relaxation associated with structural changes.

2.3.1 Type of diffusion phenomena

According to the following definitions, it is common to formalize the experimental diffusion observation as:¹⁰

2.3.1.1 Case I diffusion or Fickian diffusion occurs when the rate of diffusion is much lower than relaxation rate of the polymer. This system is controlled by diffusion coefficient and the behavior of these systems can be described by only a

single parameter. The movement of diffusing molecule is simply based on a random walk with out any interaction.

2.3.1.2 Case II diffusion – The diffusion rate is very rapid as compared to the relaxation rate. In this case, the parameter of interest is the constant velocity of advancing liquid located at the boundary between swollen gel and glassy core. It has been assumed that the solvent front demarcates a rubbery shell from a glassy core. In case that the mechanical properties of the two states are sufficiently different, fracture can occur as a result in the glassy core. In this diffusion mode, strong interactions between diffusing molecules and the polymer may occur. Some of the diffusing molecules are either precipitated or form a new compound with a chemical reaction. They are rapid immobilization processes, compared with the rate of diffusion and the regions all the sites are occupied or unoccupied, respectively, are separate by sharp boundary.

2.3.1.3 Case III diffusion or non-Fickian or anomalous diffusion occurs only if the diffusion and relaxation rates are similar. Basically, all cases that can not be modeled by Case I or Case II are grouped to Case III. As an indicator for anomalous diffusions, some descriptions suggest mass sorption is related to time. An exception such as a shot times occurs when this is not a reliable indicator because of sensitivity of the diffusion solution to boundary and initial conditions.

The Fickian model is usually a good first approximation for modeling the transport behavior in a polymer. A mathematical model has been developed base on a symmetric film, for free standing film immersed at $t=0$ in an infinite solution. The results are applicable to have only one face is contact with the liquid phase and an impermeable barrier at the center of the film. This is equivalent to the free film because there is no net mass transport through the plan at the center of free film.

2.3.2 The mathematics of diffusion

The mathematics of diffusion process is based on Fick's hypothesis that the rate of transfer of diffusing molecules through a unit area of a section is proportional to the concentration gradient measured normal to the cross section:¹¹

$$F = -D \frac{\partial C}{\partial Z} \quad (2.9)$$

where F is the rate of transfer per unit area of a section, C is concentration of the diffusing substance, Z is the space coordinate normal to the surface.

For one-dimensional molecular diffusion in a polymer film with a constant diffusion coefficient, the film is significantly thin. So that the inter-diffusion direction is expected to be along only the Z -axis, which is the axis perpendicular to the surface of ATR prism. The continuity equation for the diffusing species is therefore reduces to:¹¹

$$\frac{\partial C}{\partial t} = D \frac{\partial^2 C}{\partial Z^2} \quad (2.10)$$

where D is diffusion coefficient. Equation 2.10 can be solved readily, giving the appropriate boundary conditions that apply to a particular experiment. This equation has been further simplified in the case that D depends only on temperature and is independent of other parameters (i.e., concentration, the position and thermal history).

One of the most common experimental techniques for diffusion studies of small molecules in to a polymer film is the method of sorption kinetics. In this technique, a polymer film of thickness $2L$ is placed in an infinite bath of penetrant. The concentrations at the two surfaces of the film ($Z = L$ and $Z = -L$) are instantaneously established at a zero concentration of penetrant, then the concentration C at any depth in the film Z and at any time t .

The boundary conditions for sorption are

$$C = C_S, \text{ for } Z < -L \text{ and } Z > L$$

$$C = C_0, \text{ for } t=0, -L \leq Z \leq L$$

where C_S is the bulk concentration outside the film, C_0 is the initial concentration inside the film. The general solution for this system is:¹¹

$$\frac{[C - C_{(0)}]}{[C_{(s)} - C_{(0)}]} = \frac{C}{C_S} = 1 - \frac{4}{\pi} \sum_{n=0}^{\infty} (-1)^n e^{-\frac{(2n+1)^2 \pi^2 D t / 4 L^2}{(2n+1)} \times \cos\left(\frac{(2n+1)\pi Z}{2L}\right)} \quad (2.11)$$

2.3.3 ATR FT-IR spectroscopy applied to diffusion in polymer

The root of applied spectroscopy is the basic relation between absorption of electromagnetic waves and quantity of the sorbing material. In FT-IR transmission spectroscopy at low absorbance, this relationship is expressed by the Beer-Lambert law that given by:¹¹

$$dI = -\alpha I dZ - \varepsilon C I dZ \quad (2.12)$$

where I is the light intensity at position Z , α is the absorption coefficient, ε is the molar extinction coefficient and C is the concentration of absorbing group. Integrating equation 2.12 gives rise to:¹¹

$$A = -\ln \left\{ \frac{I}{I_0} \right\} = \int_{-L}^L \varepsilon C dZ \quad (2.13)$$

where A is the measure absorption, I_0 is the intensity of the incident light, I is intensity of the transmitted light and $2L$ is the thickness of which the absorbing group is present.

By the nature of the experimental arrangement, ATR FT-IR spectroscopy can be experimented to obtain sorption kinetics in direct contact with the penetrant. ATR spectroscopy differs from traditional transmission spectroscopy. When total reflection of light occurs at the boundary between a propagating medium and a rarer medium, penetration of the electromagnetic field into the rarer medium would be resulted. This electromagnetic field produces an evanescent wave as a consequence of a super position of the incident and reflected waves at the surface with the requirement that the electric field has to be continuous through out the interface.

When the rarer medium absorbs certain frequencies of light via the evanescent wave, the reflection is frustrated and the reflected wave causes a reduced intensity at these wavelengths, showing in term of an absorption spectrum. In order to combine the evanescent field strength equation with the Beer-Lambert law, it is necessary to assume that only weak absorption occurs. With this assumption:¹¹

$$\frac{I}{I_0} = e^{-A} \approx (1 - A) \quad (2.14)$$

or

$$dI = -I \, dA \quad (2.15)$$

Substituting equation 2.15 into the differential form of the Beer-Lambert law 2.13 and then integrating:¹¹

$$A = \int_0^L \frac{\epsilon C I}{I_0} dz \quad (2.16)$$

In the ATR configuration, penetrant only enters into the film from one-side. So that, the integration has perform from 0 to L . Since $I = E^2$, we can substitute the field strength of the evanescent wave and rewrite the expression for multiple reflection, N , as:¹¹

$$A = \int_0^L N \varepsilon^* C E_0^2 \exp(-2\gamma Z) dZ \quad (2.17)$$

where $\varepsilon^* = \varepsilon / I_0$

Substituting equation 2.11, the Fickian concentration profile, into equation 2.17 and integrating:¹¹

$$\frac{A_t}{A_\infty} = 1 - \frac{8\gamma}{\pi [1 - \exp(-2\gamma L)]} \times \sum_{n=0}^{\infty} \left[\frac{\exp(g) \left[f \exp(-2\gamma L) + (-1)^n (2\gamma) \right]}{(2n+1)(4\gamma^2 + f^2)} \right] \quad (2.18)$$

where

$$g = \frac{-D(2n+1)^2 \pi^2 t}{4L^2} \quad (2.19)$$

$$f = \frac{(2n+1)\pi}{2L} \quad (2.20)$$

and

$$\gamma = 2n_2 \pi \sqrt{\frac{\sin^2 \theta - \left(\frac{n_1}{n_2}\right)^2}{\lambda}} \quad (2.21)$$

In equation 2.18, A_∞ represents the absorbance at equilibrium. This equation represents an exact solution for ATR FT-IR absorption of penetrant into a thin polymer film. It is possible for a particular set of experimental conditions to simplify this expression. Equation 2.18 can be simplified by eliminating all terms in a series beyond the first:¹¹

$$\frac{A_t}{A_\infty} = 1 - \frac{8\gamma}{\pi [1 - \exp(-2\gamma L)]} \times \left[\frac{\exp\left(\frac{-D\pi^2 t}{4L^2}\right) \left(\frac{\pi}{2L} \exp(-2\gamma L) \right) + (2\gamma)}{4\gamma^2 + \frac{\pi^2}{4L^2}} \right] \quad (2.22)$$

Values of L , D and γ are typical for experimental system operated. In the model development, γ is assumed to be constant. This is not entirely correct, giving the dependence of γ on n_1 . The refractive index of polymer can vary as the concentration of penetrant increases. However, the significance of γ in the model is dependent on the experimental condition.¹¹

$$4\gamma^2 = \frac{\pi^2}{4L^2} \quad (2.23)$$

$$1) \exp(-2\gamma L) \quad (2.24)$$

γ can be eliminated from equation 2.22. This requirement is readily met for most experimental systems. Under the condition, equation 2.22 can be reduced to the expression:¹¹

$$\ln\left(1 - \frac{A_t}{A_\infty}\right) = \ln\left(\frac{1}{\gamma}\right) - \frac{D\pi^2}{4L^2}t \quad (2.25)$$

In equation 2.25, the logarithm of the absorbance is plotted as a function of time, and the slope of a linear least square regression yields a value of the diffusion coefficient.

2.4 ATR FT-IR for observation of contaminants in wastewater.

The application of ATR technique for studying diffusion of small molecules into polymer film has been done for years. As early as 1975, Lavrentyev et al. reported the uses to measure diffusivities of solvents and non-solvents in polymers to independently determine the diffusion coefficient of different substances in multi-component medium, to appraise the decomposition of adhesive joints under the influence of diffusants. And to additional observe the various stages of diffusion in multi-layer systems.¹² Since then, a number of articles have been related as potential applications of ATR FT-IR spectroscopy for studies of small molecule diffusing into polymer film.

In 1988, S. Simhony et al.¹³ developed a silver halide coated with Teflon fluorocarbon resin to allow convenient and reproducible loading of organic solution and solid (amorphous or crystalline) derived by solvent evaporation. The features could detect with quantities as low as 6 ng.

In 1995, R. Gobel et al.¹⁴ investigated the diffusion behavior and determined the diffusion coefficient of CHCs (monochlorobenzene, tetrachloroethylene and chloroform) into polymer membrane (LDPE, PIB and ethylene/propylene copolymer). This work showed the importance to understand the diffusion process in different material for optimizing a fiber optic sensing system for CHCs in water.

In 1996, F. Regan et al.¹⁵ determined pesticides in water by using ATR FT-IR spectroscopy on PVC/chloroparaffin coating on IRE. The polymer film acts to enrich the pesticides and concentrates them within the penetration depth (d_p) of the evanescent region. Limit of detection in the region of 2 ppm has been achieved for atrazine and alachlor.

In 1999, J. Yang and J.W Her¹⁶ created a new rapid method for determination of semi-volatile compounds in contaminated soil samples by coupling solid-phase microextraction (SPME) with ATR FT-IR spectroscopy. Vaporized semi-volatile compounds were carried by stream of nitrogen gas to hydrophobic polyisobutylene (PIB) coated on IRE in the ATR flow cell. The detection limit of this method was in the range of 200-300 ppb.

In 2000, V. Acha et al.¹⁷ developed ATR FT-IR sensor for continuous on-line measurements of the toxic compounds in the dechlorinating bioreactor. The mixture contained trichloroethylene (TCE), tetrachloroethylene (PCE), carbon tetrachloride (CT), and hexachlorobutadiene (HCE). The concentration of organochlorine compounds in the bioreactor was successfully predicted from the absorbance spectra using a partial least square (PLS) calibration method.

CHAPTER III

EXPERIMENT

3.1 Dissolved chlorinated hydrocarbons in water

3.1.1 Preparation of low-density polyethylene (LDPE) film

3.1.1.1 Materials and equipment

1. Low density polyethylene (LDPE) beads
The LDPE beads used in this research received from Thai Petrochemical Industrial (TPI) Co., Ltd. The LDPE has an average molecular weight of 32,450.
2. Toluene; analytical grade from CARLO ERBA Reagent
3. Polytetrafluoroethylene (PTFE) plate with a dimension of 2.5 x 1.3 x 0.3 cm³
4. Hemisphere germanium (Ge) IRE
5. Hot plate and stirrer with magnetic bar
6. Spin coater
7. Leveling rod
8. Glass slide
9. Glassware

3.1.1.2 Methodology

3.1.1.2.1 Preparation of LDPE solution

LDPE beads were used as received. 100 mg of LDPE beads were dissolved in 50 mL of 98% toluene by heating up to 110 °C, stirring with magnetic bar until the homogeneous solution was obtained.

3.1.1.2.2 Preparation of spin-coated LDPE film on Ge IRE

The polymer films were prepared on a modified spin coater, which is able to produce a rotational velocity in the range of 1000-5000 rpm. Film was cast by spin coating at room temperature as the procedure shown below:

1. Locate the hemisphere Ge prism on the top of the modified spin coater.
2. Drop ~1 mL of the prepared polymer solution on a flat surface of Ge prism.
3. Turn on the power and adjust the rotational speed to 3000 rpm for 3 minutes.
4. Repeat the second and third step until getting a thin film with required thickness. Approximately 10 mL of the polymer solution was usually used at a time.
5. After that both the prism and thin film was transfer to a hood for scrubbing and the residue was removed. The coated is put into an oven for annealing at 90 °C for 90 minutes.
6. The coated prism is kept in a desiccator at room temperature for 24 hours.

3.1.1.2.3 Preparation of dip-coated LDPE film on PTFE plate

1. Flat PTFE plate was clean with acetone.
2. Immerse the cleaned PTFE plate into a stirred LDPE solution for coat LDPE film on the plate as times as a required thickness can be done (1-7 layers).
3. Solvent was allowed to completely evaporate at the room temperature and leave the coated thin film in a desiccator for 24 hours.
4. The final thickness of the film was in order of 0.112-0.221 micrometer.

3.1.1.2.4 Preparation of hot-pressed LDPE film

1. Place LDPE beads on a glass slide, which was being heated at ~110 °C on a hot plate.
2. Wait until the polymer beads were totally melted to transparent observed.
3. Place another glass slide onto the melted polymer.
4. Put a small pressure onto the top glass slide until a circular film between the glass slide appear.
5. Gently peel the film and kept it in a desiccator to prevent environmental moisture.
6. Thickness of the polymer film using this method is about 400 micrometer.

3.1.1.2.5 Preparation of solvent-cast LDPE film

1. Pour 30 mL of LDPE solution from 3.1.1.2.1 into a cleaned pettidish, which controlled level by leveling rod.
2. Allow the solvent to completely evaporate at room temperature and then leave the dish in a desiccator for 24 hours.
3. Thickness of the polymer film using this method is about 230 micrometer.

3.1.2 Preparation of chlorinated hydrocarbon solution

3.1.2.1 Materials and equipment

1. Chlorinated hydrocarbon compounds
 - Trichloroethylene; analytical grade from ARISTAR
 - Dichloroethylene; analytical grade from Merck
 - Carbon tetrachloride; analytical grade from Merck
2. Methanol; analytical grade from Merck

3. Deionized water
4. Exmire Microsyringe with a total volume of 10 micro-litter from ITO corporation.
5. SMI[®] Digital Adjust Micro/Pettor (50-250 microliter) from American Dade, American Hospital Supply corporation
6. Glassware

3.1.2.2 Methodology

3.1.2.2.1 Preparation of 1000, 700 and 100 ppm of trichloroethylene (TCE) solution

1. Pipet 68.0, 47.6 and 6.8 microliter of the analytical grade trichloroethylene into 100 mL of volumetric flasks.
2. Add 1 mL of methanol, as a mediator, into the flasks to dissolve these chlorinated hydrocarbons.
3. Make the total volume of all 100 mL flasks by adding deionized water to obtain final concentrations of 1000, 700 and 100 ppm, respectively.

3.1.2.2.2 Preparation of 1000 ppm dichloroethylene and carbon tetrachloride

1. Pipet 79.0 and 65.0 microliter of the analytical grade dichloroethylene and carbon tetrachloride into 100 mL of volumetric flasks.
2. Add 1 mL of methanol, as a mediator into the flasks to dissolve these chlorinated hydrocarbons.
3. Complete the total volume of all 100 mL flasks by adding deionized water to obtain final concentrations of 1000 ppm.

3.1.3 Acquisition parameters for FT-IR experiment

3.1.3.1 Bruker Vector 33 FT-IR spectrometer

Experimental setup

Resolution	4.0 cm ⁻¹
Number of scans	64
Result spectrum	Absorbance

Spectrometer parameters

Source	Globar
Detector	DTGS
Beam splitter	KBr

3.1.3.2 Bio-Rad FTS175 FT-IR spectrometer

Experimental setup

Resolution	4.0 cm ⁻¹
Number f scans	64
Result spectrum	Absorbance

Spectrometer parameters

Aperture	open
Gain Amp	8
Source	Globar
Detector	DTGS
Beam splitter	KBr

3.1.4 Diffusion study of dissolved chlorinated hydrocarbons into LDPE film

3.1.4.1 Spin-coated LDPE film on Ge IRE

Diffusion processes were observed by using ATR FT-IR technique. The experimental reservoir of coated LDPE film on a single reflection hemisphere Ge IRE was depicted in a Figure 3.1. The angle of incidence was set at 45° with non polarized beam. A LDPE film with refractive index of 1.4 was coated on the bottom of a flat surface of hemisphere Ge before mouthed to the liquid reservoir. The waterproof cover of the IRE was specially fabricated from bronze equipped with an o-ring. Spectra were recorded on Bruker Vector 33 and Bio-Rad FTS175 FT-IR spectrometer.

A SeagullTM- variable angle ATR accessory from Harrick Scientific Corporation was operated. The accessory requires a hemispherical IRE with 25-mm diameter and 12.5 height. The IRE used in all experiments was made of germanium, (Ge) having a reflective index of 4.0.

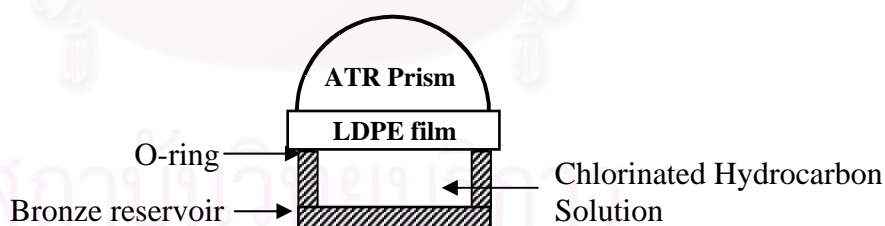

Figure 3.1 Experimental setup for the diffusion study of chlorinated hydrocarbon into LDPE film coated on the Ge IRE.

3.1.4.1.1 Effect of chlorinated hydrocarbon species

1. Materials and equipment

1. Hemisphere Ge with LDPE film coated on bottom flat surface
2. 1000 ppm of trichloroethylene, dichloroethylene and carbon tetrachloride
3. The liquid reservoir fabricated from bronze
4. SeagullTM-variable angle ATR attachment
5. FT-IR spectrometer

2. Spectral acquisition

1. Pour 4 mL of trichloroethylene solution into bronze reservoir.
2. Carefully attach the reservoir to the bottom surface of Ge IRE coated with LDPE film.
3. Put it into the SeagullTM accessory and Record the spectrum to collect a reference spectrum before diffusion occurs to ensure that there are no toluene left in the film i.e., the absorption peak at 728 cm^{-1} should not be observed.
4. Record a spectrum of coated LDPE film on IRE as a background.
5. To put upside down the reservoir and allow the solvent directly contact to the coated IRE for 1 minute and then take a series of spectra to observe changes in absorption intensity as a function of time.
6. At the end of the experiment, plot the relationship between absorption intensity at 932 cm^{-1} (i.e., C-Cl stretching vibration) and time.
7. Repeat above six steps by using 1000 ppm of dichloroethylene and carbon tetrachloride instead of trichloroethylene.
8. Study the diffusion behavior of three different chlorinated hydrocarbons by comparing the plot observed.
9. Calculate the diffusion coefficients of three systems for discussion.

3.1.4.1.2 Time dependent phenomena

1. Materials and equipment

1. Hemisphere Ge with LDPE film coated on bottom flat surface
2. 1000 ppm of trichloroethylene solution
3. Liquid reservoir made of bronze
4. The SeagullTM-variable angle ATR attachment
5. FT-IR spectrometer

2. Spectral acquisition

1. Pour 4 mL of trichloroethylene solution into the bronze reservoir.
2. Carefully attach the reservoir to the bottom surface of Ge IRE coated with LDPE film.
3. Put the sample cell into the SeagullTM accessory and Record the spectrum to collect the reference spectrum before diffusion occurs and ensure that there are no toluene left in the film i.e., the absorption peak at 728 cm^{-1} not should be observed.
4. Record the spectrum of coated LDPE film on IRE as a background.
5. To put upside down the reservoir and allow the solvent directly contact to the coated IRE for 1 minute and then take a series of spectra to observe changes in absorption intensity as a function of time.
6. At the end of the experiment, plot the relationship between absorption intensity at 932 cm^{-1} (i.e., C-Cl stretching vibration) as a function of time.
7. Calculate the diffusion coefficient of 1000 ppm TCE in LDPE film.

3.1.4.1.3 Effect of solution concentration

1. Materials and equipment

1. Hemisphere Ge with LDPE film coated on flat bottom surface
2. 100, 700, and 1000 ppm of trichloroethylene solution
3. Liquid reservoir made of bronze
4. The SeagullTM-variable angle attachment
5. Hemisphere Ge IRE
6. FT-IR spectrometer

2. Spectral acquisition

1. Pour 4 mL of trichloroethylene solution into the bronze reservoir.
2. Carefully attach the reservoir to the bottom surface of Ge IRE coated with LDPE film.
3. Put the sample cell into the SeagullTM accessory and collect a spectrum to obtain the reference spectrum before diffusion occurs to ensure that there are no toluene left in the film i.e., the absorption peak at 728 cm^{-1} should not be observed.
4. Record the spectrum of coated film on IRE as a background.
5. To put upside down the reservoir to allow the solvent directly contact to the coated IRE for 1 minute and then take a series of spectra to observe changes in absorption intensity as a function of time.
6. At the end of the experiment, plot the relationship between absorption intensity at 932 cm^{-1} (i.e., C-Cl stretching vibration) and time.
7. Use 100 and 700 ppm of trichloroethylene instead of 1000 ppm and plot the relationship between absorbance and time dependence for each system to comparing the different of three concentrations.
8. Calculate the diffusion coefficient of three concentrations to compare the diffusion behavior.

3.1.4.1.4 Effect of polymer morphology

1. Materials and equipment

1. Annealed LDPE film with 90°C for 90 minutes and un-annealed of LDPE film, which coated on one-side of IRE
2. 1000 ppm of trichloroethylene solution
3. Liquid reservoir made of bronze
4. The SeagullTM-variable angle ATR attachment
5. FT-IR spectrometer

2. Spectral acquisition

1. Pour 4 mL of trichloroethylene solution into the bronze reservoir.
2. Carefully attach the reservoir to the bottom surface of Ge IRE coated with un-annealed LDPE film.
3. Put the sample cell into the SeagullTM accessory and collect a reference spectrum to obtain the reference spectrum before diffusion occurs to ensure that there are no toluene left in the film i.e., the absorption peak at 728 cm⁻¹ should not be observed.
4. Record the spectrum of coated un-annealed LDPE film on IRE as a background.
5. To put upside down the reservoir to allow the solvent directly contact to the coated IRE for 1 minute and then take a series of spectra to observe changes in absorption intensity as a function of time.
6. At the end of the experiment, plot the relationship between absorption intensity at 932 cm⁻¹ (i.e., C-Cl stretching vibration) and time.
7. Repeat above six steps by use an annealed LDPE film instead of un-annealed film and repeating the whole procedures mentioned above.
8. Calculated the diffusion coefficient of 1000 ppm of trichloroethylene into un-annealed and annealed LDPE film.

3.1.4.1.5 Effect of film thickness

1. Materials and equipment

1. LDPE films coated on one-side of IRE with various thickness
2. 1000 ppm of trichloroethylene solution.
3. Liquid reservoir made of bronze
4. The SeagullTM-variable angle ATR attachment
5. FT-IR spectrometer

2. Spectral acquisition

1. Pour 4 mL of trichloroethylene solution into the bronze reservoir.
2. Carefully attach the reservoir to the bottom surface of Ge IRE coated with LDPE film.
3. Put the sample cell into the SeagullTM accessory and Record the spectrum to obtained the collect spectrum before diffusion occurs to ensure that there are no toluene left in the film i.e., the absorption peak at 728 cm^{-1} should not be observed.
4. Record the spectrum of coated LDPE film on IRE as a background.
5. To put upside down the reservoir for allow the solvent directly contact to the coated IRE for 1 minute and then take a series of spectra to observe changes in absorption intensity as a function of time.
6. At the end of the experiment, plot the relationship between absorption intensity at 932 cm^{-1} (i.e., C-Cl stretching vibration) and time.
7. Repeat the above six steps by vary diffusion time and record another spectral series by use the thicker LDPE film instead of thin film.
8. Calculate the diffusion coefficient of 1000 ppm of trichloroethylene into the various thickness LDPE film.

3.1.4.2 Dip-coated LDPE film on PTFE plate

3.1.4.2.1 Effect of film thickness

1. Materials and equipment

1. Various thickness of dip-coated LDPE film on PTFE plate.
2. 1000 ppm of trichloroethylene solution.
3. Beaker
4. The Seagull™-variable angle attachment
5. Hemisphere Ge IRE
6. FT-IR spectrometer

2. Spectral acquisition

1. Record the spectrum of 1 layer dip-coated LDPE film on PTFE plate to obtain the reference spectrum before diffusion occurs to ensure that there is no toluene left in the polymer matrix.
2. Pour 40 mL of the 1000-ppm trichloroethylene solution into a beaker.
3. Immerse the dip-coated LDPE film into the solution of trichloroethylene (Figure 3.2.) for 15 minutes.

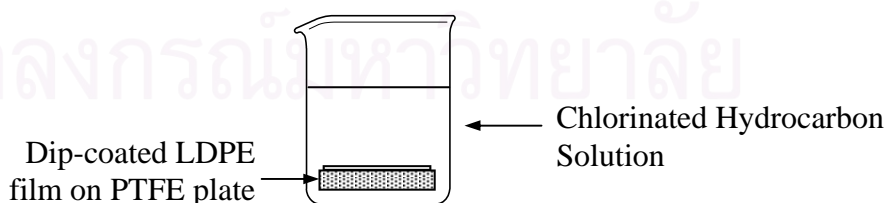

Figure 3.2 Configuration of ATR sensor using a thin LDPE film coated on PTFE plate as a probe.

4. Place the diffused LDPE film to the holder of Seagull™ attachment and carefully contact to the cleaned IRE surface and record the spectrum after diffusion occurs.
5. Use the 2-7 layers dip-coated film instead of 1 layer coated and repeating the whole above procedure to collect the series of diffusion behavior.

3.1.4.2.2 Effect of additive in polymer matrix

1. Materials and equipment

1. LDPE film with various quantities of 4-chlorobenzaldehyde (0-4.08 % w/v of toluene) in the polymer solution, dip-coated on PTFE plate for 1 layer.
2. 1000 ppm of trichloroethylene solution.
3. Beaker
4. The Seagull™-variable angle ATR attachment
5. Hemisphere Ge IRE
6. FT-IR spectrometer

2. Spectral acquisition

1. Record the spectrum of PTFE plate to obtain the reference spectrum before diffusion to ensure that there is no toluene left in the polymer matrix.
2. Pour 40 mL of the 1000-ppm trichloroethylene solution into a beaker.
3. Immerse the dip-coated pure LDPE film into the solution of trichloroethylene (Figure 3.2.) for 15 minutes.
4. Place the diffused LDPE film to the holder of Seagull™ attachment and carefully contacted to the Ge IRE surface and record the spectrum after diffusion.

5. Additional repeats the whole steps by varies time of diffusion and record the spectra by use the dip-coated film with various quantities of 4-chlorobenzaldehyde instead of dip-coated pure LDPE film.

6. At the end of the procedure, plot the relationship between absorbance of C-Cl stretching vibration at 932 cm^{-1} at 15 minutes.

3.1.4.3 Free standing LDPE film

3.1.4.3.1 Effect of free volume in polymer film on diffusion behavior.

1. Materials and equipment

1. LDPE film prepared by hot-pressing and solvent-cast methods with the dimension of $1 \times 1\text{ cm}^2$.
2. 1000 ppm of trichloroethylene solution
3. Beaker
4. The SeagullTM-variable angle ATR attachment
5. Hemisphere Ge IRE
6. FT-IR spectrometer

2. Spectral acquisition

1. Record the spectrum of hot-pressed LDPE film to obtain the reference spectrum before diffusion to ensure that there is no any contaminate left in the polymer matrix.

2. Pour 40 mL of the 1000-ppm trichloroethylene solution into a beaker.

3. Place the hot-pressed LDPE film onto the surface of trichloroethylene solution (Figure 3.3.) for 1 minutes.

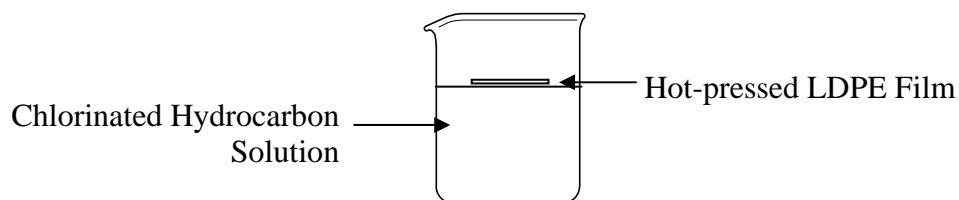

Figure 3.3 Setup for ATR experiment using a thick LDPE film as a probe.

4. Place the diffused LDPE film to the holder of Seagull™ attachment and carefully contact to the IRE surface and record the spectrum after diffusion.
5. Additional repeats the whole steps by vary time of diffusion and record the series of spectra.
6. Use solvent-cast LDPE film instead of hot-pressed LDPE film and collect the spectra by repeated the above procedure.
7. At the end of the procedure, plot the relationship between absorbance of C-Cl stretching vibration at 932 cm^{-1} and time of LDPE film preparation.
8. Calculate the diffusion coefficient of 1000 ppm TCE into the hot-pressed LDPE and cast film.

3.1.4.3.2 Initial absorption

1. Materials and equipment

1. Hot-pressed LDPE films with various thickness (varies from 380 to 580 μm)
2. 1000 ppm of trichloroethylene
3. Beaker
4. The Seagull™-variable angle ATR attachment
5. Hemisphere Ge IRE
6. FT-IR spectrometer

2. Spectral acquisition

1. Record the spectrum of hot-pressed LDPE film to obtain the reference spectrum before diffusion to ensure that there is no any contaminate left in the polymer matrix.
2. Pour 40 mL of the 1000 ppm trichloroethylene solution into a beaker.
3. Place the hot-pressed LDPE film onto the surface of trichloroethylene solution (Figure 3.3.) for 1 minutes.
4. Place the diffused LDPE film to the holder of the Seagull™ attachment and carefully contact to the IRE surface and record the spectrum after diffusion.
5. Additional repeats the whole steps to confirm the rate of diffusion by varied the thickness of the film to get the initial absorption rate of 1000 ppm trichloroethylene on hot-pressed film.
6. At the end of the procedure, plot the relationship between absorbance of C-Cl stretching vibration at 932 cm^{-1} .

3.2 Slightly dissolved compounds contaminated in water

3.2.1 Materials and equipment

1. Fluorolube
2. Standard solution of pesticide such as Endrin, Endosulfan-sulfate, and DDT
3. Hexane; analytical grade from Merck
4. Deionized water
5. Glassware

3.2.2 Methodology

3.2.2.1 Preparation of LDPE film

The polymer film, used in this section, was prepared by two procedures; (i) hot-pressing preparation for studying the adsorption behavior of fluorolube and organochlorine; (ii) spin-coated LDPE film on one side of IRE to observe the diffusion behavior of these large molecules into a polymer film, for further comparing to those of small molecules.

3.2.2.2 Preparation of 100 ppm pesticide solution

Weigh a powder of organochlorine compounds for 2.644, 2.641, and 2.589 mg of Endrin, Endosulfan-sulfate, and 6,6' DDT, respectively. Then pour the powder into the 25-mL volumetric flask and dissolve with hexane.

3.2.3 Determination of slightly dissolved compounds in water

3.2.3.1 Adsorption of fluorolube on LDPE film

1. Materials and equipment

1. Hot-pressed LDPE film.
2. Fluorolube
3. The SeagullTM-variable angle ATR attachment
4. Hemisphere Ge IRE
5. FT-IR spectrometer

2. Spectral acquisition

1. Record the spectrum of hot-pressed LDPE film to collect a reference spectrum before diffusion occurs.
2. Pour the 40-mL of deionized water into the beaker.
3. Add 2 drops of fluorolube on the water surface.
4. Place LDPE film on the water surface for 1 minute to adsorb the floated fluorolube.
5. Place the adsorbed LDPE film against the Ge IRE while pressure was applied to collect the spectrum after adsorption.

3.2.3.2 Adsorption of pesticides on LDPE film

1. Materials and equipment

1. Hot-pressed of LDPE film.
2. 100 ppm of pesticide solution such as Endrin, Endosulfan-sulfate and 6,6' DDT.
3. The SeagullTM-variable angle ATR attachment
4. Hemisphere Ge IRE
5. FT-IR spectrometer

2. Spectral acquisition

1. Record the spectrum of hot-pressed LDPE film to collect the reference spectrum before diffusion occurs.
2. Pour the 40-mL of deionized water into the beaker.
3. Add 2 drops of Endrin solution on the water surface.
4. Allow the solvent to completely evaporate at room temperature, observed by the thin white layer on the surface of water.
5. Place LDPE film to contact to the floated Endrin for adsorbing the compound.

6. Place the adsorbed LDPE film against the Ge IRE surface while slightly pressure was applied to collect the spectrum after adsorption.
7. Use Endosulfan-sulfate and DDT instead of Endrin and record the spectra by repeating the whole procedures mentioned above.

3.2.3.3 Diffusion behavior of the pesticides through LDPE film

1. Materials and equipment

1. Hemisphere Ge IRE with LDPE film coated on bottom flat surface.
2. 100 ppm of pesticides such as Endrin, Endosulfan-sulfate, and DDT.
3. Liquid reservoir made of bronze
4. The SeagullTM-variable angle ATR attachment
5. FT-IR spectrometer

2. Spectral acquisition

1. Record the spectrum of coated LDPE film on one-side of IRE to collect the reference spectrum before diffusion. And ensure that there are no toluene left in the polymer matrix, an ATR spectrum of the film was taken, and the band at 728 cm^{-1} was not observed.
2. Record the spectrum of coated IRE as a background.
3. Pour the deionized water for 40 mL into the beaker.
4. Add 2 drops of the Endrin solution on the water surface.
5. Allow the solvent to completely evaporate at room temperature by observed the thin white layer on the water surface.
6. Contact the coated IRE to the solution for adsorbs the floated Endrin.

7. Record the spectrum of adsorbed Endrin on LDPE film at every 5 minutes for 30 minutes in order to observe the diffusion behavior Endrin into LDPE film
8. Use Endosulfan-sulfate and DDT instead of Endrin and collect the spectra by repeating the whole procedure mentioned above.



สถาบันวิทยบริการ
จุฬาลงกรณ์มหาวิทยาลัย

CHAPTER IV

RESULTS AND DISCUSSION

4.1 ATR FT-IR signal enhancement

Low-density polyethylene (LDPE) was chosen as a polymeric material for analyzing the enrichment of weak absorption peaks of chlorinated hydrocarbons in the region of $1000\text{-}700\text{ cm}^{-1}$. Figures 4.1 and 4.2 show spectra of trichloroethylene and carbon tetrachloride with the concentration of 1000 ppm in water with and without a polymer coating. In an absence of polymer layer, the C-Cl stretching bands at 932 and 841 cm^{-1} for trichloroethylene, and 787 cm^{-1} for carbon tetrachloride could not be observed. These peaks are observable only when polymer film is present (Figure 4.2). The observation confirms that the polymer coating enhanced sensitivity of the ATR spectra as expected.

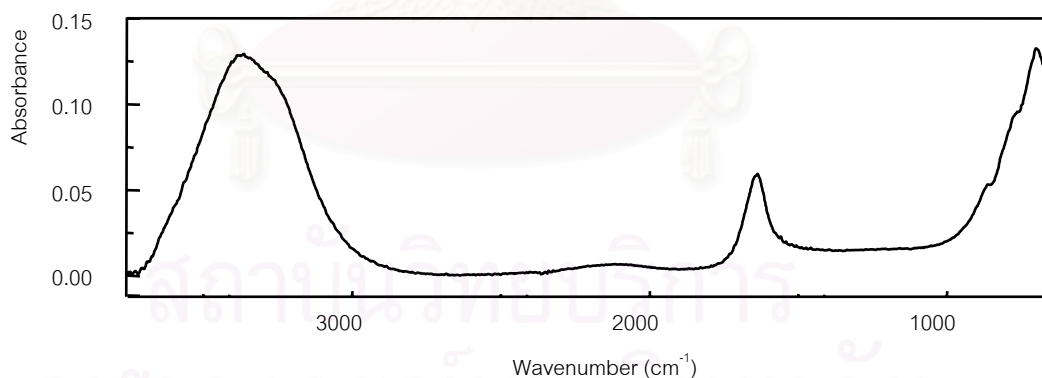

Figure 4.1 ATR spectrum of water with 1000 ppm chlorinated hydrocarbons (trichloroethylene and carbon tetrachloride). Note: the spectra are dominated by absorption bands of water. Spectra of both solutions are indistinguishable.

The detection limit of chlorinated hydrocarbon molecules in an aqueous solution can be improved if spectral features of the analyte are free of interference (i.e., water). On an IRE without coating, the water bands centered at 3400 and 1630 cm^{-1} are substantially strong and interfere with absorption peaks in the same region. For example, the water absorbance at 3400 cm^{-1} is strong and broad enough to interfere C-H stretching features of the most organic hydrocarbons in the region of 3000-2800 cm^{-1} . Moreover, in case of chlorinated hydrocarbons, C-Cl stretching appearing between 1000-700 cm^{-1} cannot be observed due to strong absorption of water.

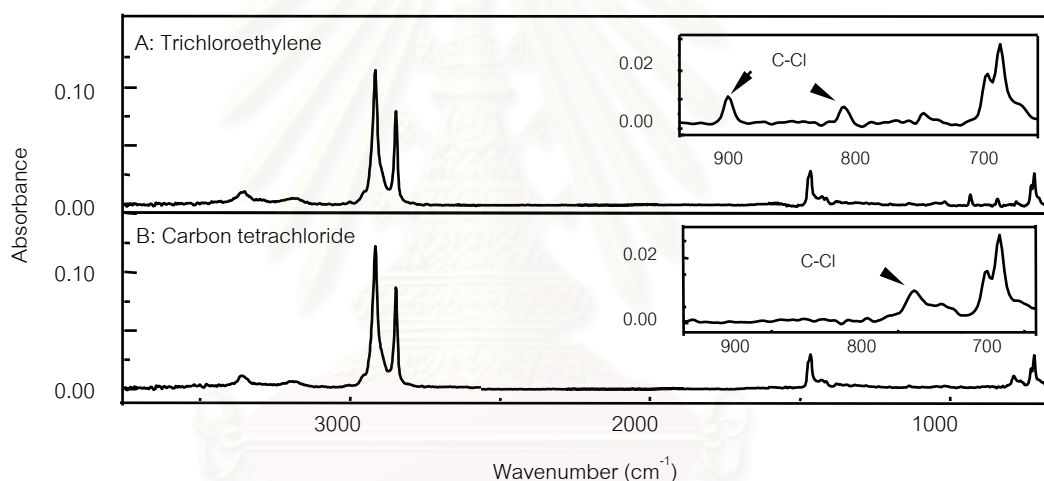

Figure 4.2 Spectral enhancement observed by coating LDPE film on Ge ATR prism as a probe for studying the enrichment of weak absorption peak of chlorinated hydrocarbons: trichloroethylene (A) and carbon tetrachloride (B). The concentration of each solution is 1000 ppm

If the hydrophobic surface of LDPE film prevents water entering the pores, the strong absorption bands of water presented on the IR spectrum should be significantly attenuated, especially if the film thickness is as large, or even larger than the penetration depth. The thin film might completely eliminate the water absorption band. The signal enhancement suggests that a hydrophobic polymer is an excellent choice to develop high sensitive ATR sensor for detecting small quantity of hydrocarbons in water. In principle, the sensitivity is enhanced by adsorption of

chlorinated hydrocarbons onto the hydrophobic polymer surface. It is well known that hydrophobic organic compounds preferentially separate from an aqueous solution, and penetrate into hydrophobic layer such as that provided by an organic polymer. This is supported by “like dissolves like” rule. In addition, this phenomenon results in a concentration enhancement relative to that of the bulk solution. As a result, the hydrophobic polymer film acts as a protective layer for an IRE and pre-concentrates the chlorinated hydrocarbon in an aqueous solutions (i.e., excluding the strongly absorbing water from contacting onto the optical sensing surface of an IRE).

4.2 Efficiency of the ATR sensor

The probe of ATR sensor in this work was prepared by three methods (i) coating the polymer film on the Ge IRE by spin coating process (ii) coating the polymer film onto flat PTFE plate by dip coating and (iii) free standing film by solution casting and hot pressing technique. The second and third sensors are novel ATR sensors. These probes were detecting the analyte at the surface, which is in contact with the analyte solution. In the current sensor, the analyte penetrating into coated film on IRE, can be observed at IRE-polymer interface by allowing the dissolved chlorinated hydrocarbons enriching into the polymer film until equilibrium stage is achieved. Unlike the old ATR sensor where the polymer film is coated on the IRE, the probing polymer film in the novel ATR sensor is separated from the IRE.

The ATR technique is a surface sensitivity technique. As a result, the major problem in ATR technique is the contact between IRE and sample. In order to achieve a good-quality ATR spectrum or to perform quantitative analysis with ATR spectra series, an optical contact between IRE and the sample must be achieved.

Since quantitative relationship between absorption intensity and concentration is based on optical contact between IRE and sample, the optical contact is the primary concern for new ATR sensors. In order to employ the acquired spectra for quantitative analysis, the material being investigated must always have good optical contact with the IRE. In order to ensure the optical contact, a flat and flexible probing film with an applied pressure is employed.

The degree of optical contact of LDPE film on Ge IRE prepared by three different processes are compared and shown in Figure 4.3. ATR spectra of the films for new ATR sensor are shown in Figures 4.3B and 4.3C. A thick film is melted on a piece of glass slide or cast as a film in pettidish. After cooling and solvent is completely evaporated, the film is taken out and is pressed against the IRE. The absorption intensities (i.e., C-H stretching) of the LDPE films in Figures 4.3A, 4.3B and 4.3C are exactly the same and closed to 0.17. Normally, an optical contact is assumed when a constant absorbance is observed with an increasing applied pressure on the film. The observed phenomena indicate that a good optical contact between sample film-Ge ATR prism can be experimentally achieved and can be verified in the direct contact operation.

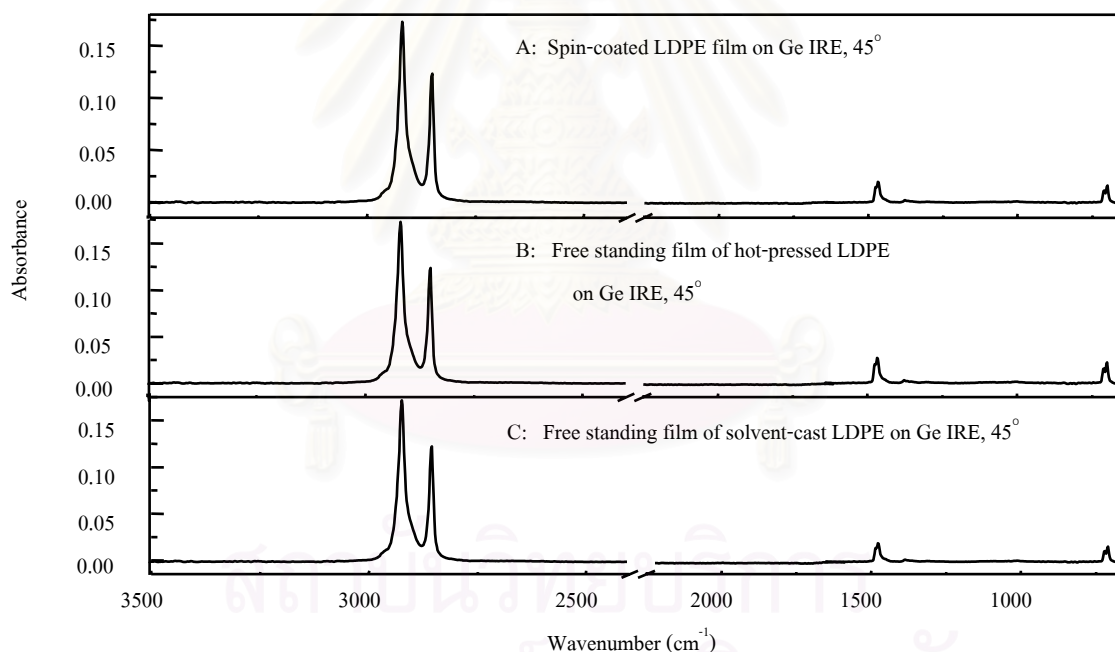

Figure 4.3 ATR spectra of the LDPE films with different preparation techniques: spin-coating (A), hot pressing (B), and solution casting (C)

4.3 Effect on diffusion behavior of dissolved chlorinated hydrocarbons into LDPE film.

4.3.1 Time dependent phenomena

For the determination of dissolved chlorinated hydrocarbons in water, a thin polymer film is coated on an Ge IRE by spin-coating technique. The film must be thick enough to prevent the absorption of water. When being used, the water with dissolved chlorinated hydrocarbon is brought into contact with polymer coated on IRE. The dissolved compounds are adsorbed onto the film surface as a result of their affinities toward the polymer film. The compounds diffuse into the film toward the IRE. When the chlorinated hydrocarbon molecules reach the IRE-polymer film interface region where the electric field is not zero, their spectra are observed. The diffusion is allowed to reach equilibrium where a uniform concentration of the analyte compound within the film is achieved (Figure 4.4).

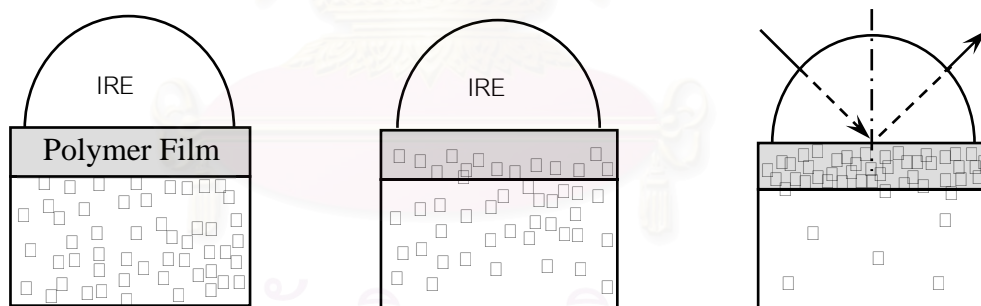

Figure 4.4 The determination of dissolved chlorinated hydrocarbon compounds in water by spin-coated LDPE film on IRE.

When chlorinated hydrocarbon compounds in aqueous solutions are dispersed into LDPE film, the compounds preferentially partition from the aqueous phase into polymer film. They preferentially diffuse into the amorphous region interrogated by the evanescent field without any chemical reactions occurring inside the film. Its presence can be sensed if the chlorinated hydrocarbon compounds has IR-active feature. There are two prominent peaks of C-Cl stretching observed in

the FT-IR spectra recorded with 1000 ppm TCE in the frequency range of 1000-800 cm^{-1} . As seen in Figure 4.5, the peak at 932 cm^{-1} is the strongest and expected to provide the highest sensitivity. Therefore, it is selected as a major trace for further investigation.

In addition, the diffusion of TCE could be clearly observed, as evidenced by significant changes in FT-IR spectra. Figure 4.6 shows an increase in absorbance of C-Cl stretching band at 932 cm^{-1} as a function of time. The observation demonstrates the transport of trichloroethylene through the polymer film and an increase in the concentration of trichloroethylene within the polymer film. In all experiments, an initially rapid increase in absorbance of the C-Cl band was investigated, as followed by a gradual increment to an asymptotic value corresponding to the equilibrium state. It is assumed that the polymer sorption occurs in two stages: (1) a rapid absorption into surface and (2) subsequent diffusion into the bulk.

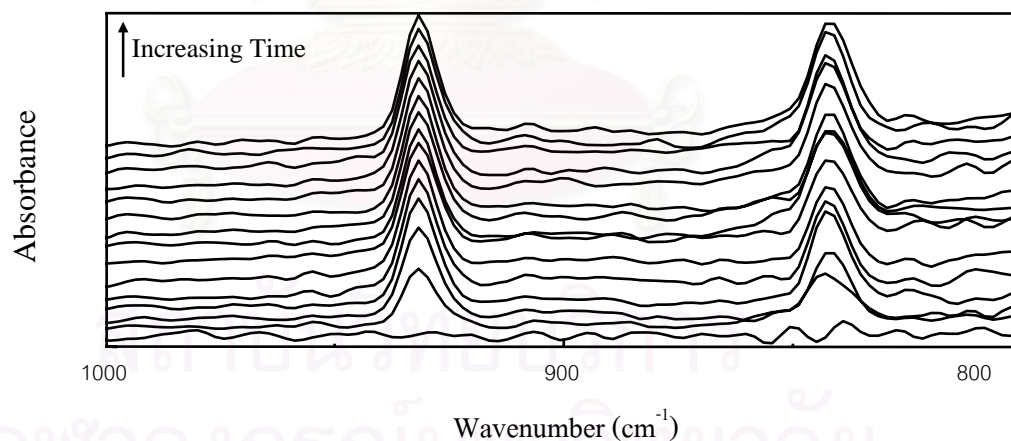

Figure 4.5 Diffusion of trichloroethylene in LDPE film. The strongest peak at 932 cm^{-1} (i.e., C-Cl stretching of trichloroethylene) was selected as a major peak for investigation.

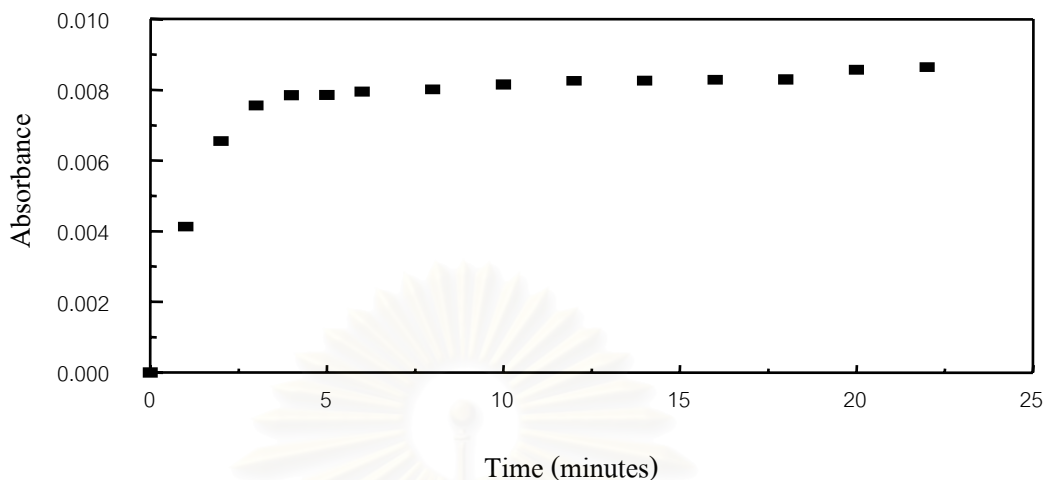

Figure 4.6 Time dependent absorption of TCE into LDPE film coated on Ge IRE. The absorption change is observed at 932 cm^{-1}

Since the analytes examined in this study are all presented in aqueous solution at part-per-million (ppm) concentration range, it will be assumed that minimal swelling of the polymer occurs during exposure. It can be simplified that the negligible boundary layer exists at the polymer/solution interface. Fieldson and Barbari have modeled small molecular diffusion kinetics in polymers based on the ATR technique.¹¹ The model simplified the molecular diffusion in a polymer sheet with a thickness $2L$, into one-dimensional diffusion (z -axis). The diffusion is governed by Fick's law. A more general form of the equation can be expressed as equation 2.18. In practice, equation 2.25 can provide a very good fit for $A_t/A_\infty \geq 0.5$.

Figure 4.7 illustrates that the experimental data can be fitted very well with equation 2.25. Intensities at C-Cl stretching vibration give a good fitting model. The diffusion coefficient of trichloroethylene through LDPE film was calculated based on equation 2.25 by a plot of $\ln(1 - A_t/A_\infty)$ with time. As a consequence, slope of a linear least square regression (i.e., $-D\pi^2/4\tau$) gives an estimated value of the diffusion coefficient D . For the experiment presented here, the diffusion coefficient of trichloroethylene through the film is $1.9755 \times 10^{-6}\text{ cm}^2/\text{s}$.

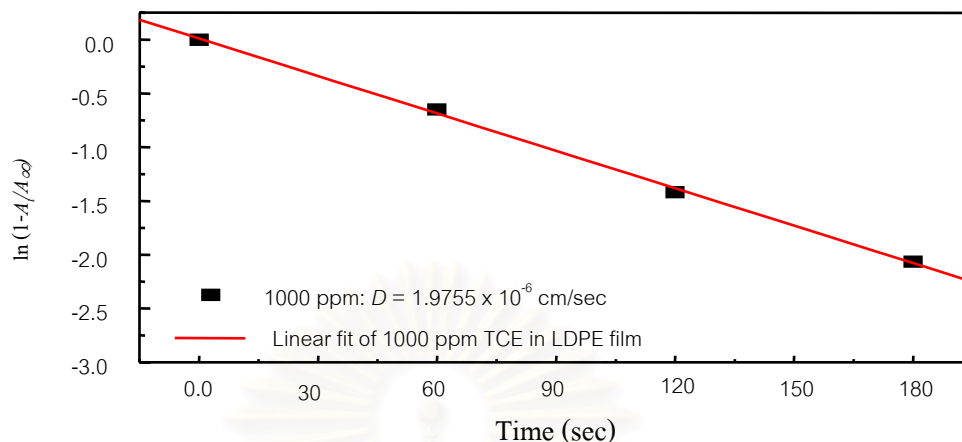

Figure 4.7 Plot of $\ln(1-A_t/A_\infty)$ with time. The diffusion coefficient of trichloroethylene into LDPE film is calculated from slope.

4.3.2 Effect of chlorinated hydrocarbon species.

For *in-situ* monitoring, an ability of rapid reaction is a crucial requirement in order to increase chlorinated hydrocarbon concentration. Figure 4.7 shows the enrichment of dichloroethylene, trichloroethylene and carbon tetrachloride as a function of diffusion time. According to Figures 4.8, 4.9 and 4.10, the diffusion of small molecules into the polymer film reached an equilibrium state faster than those of the larger molecules. As a result the diffusion coefficients were higher for small molecules.

The investigation gives the relative diffusion rates with the analytes of different sizes. Data for each analyte were achieved individually with the same thickness of polymer film (i.e., 53 μm), by re-coating the polymer on the ATR prism after diffusion measurement of each analyte. The analyte enrichment depends on how good the analyte can dissolve and diffuse into a polymer film, which is a function of diffusant properties. Figure 4.9 shows the comparison between the species of diffusant on diffusion behavior. Three species of chlorinated hydrocarbons were used in this section: dichloroethylene, trichloroethylene and carbon

tetrachloride. Each analyte has different size. Size of dichloroethylene is smaller than trichloroethylene and carbon tetrachloride, respectively. Dichloroethylene enriches rapidly and reaches a maximum absorbance in less than 15 minutes, while trichloroethylene takes approximately 20 minutes. However, carbon tetrachloride exhibits slower diffusion into the polymer film. This behavior demonstrates that the polymer layer is selective in the uptake of species. Size of the molecule has significant influence on the diffusion coefficient. The diffusion rate decreases as size increase. This observation presents a significant step in development of a chemical sensor used for particular families of chlorinated hydrocarbons.

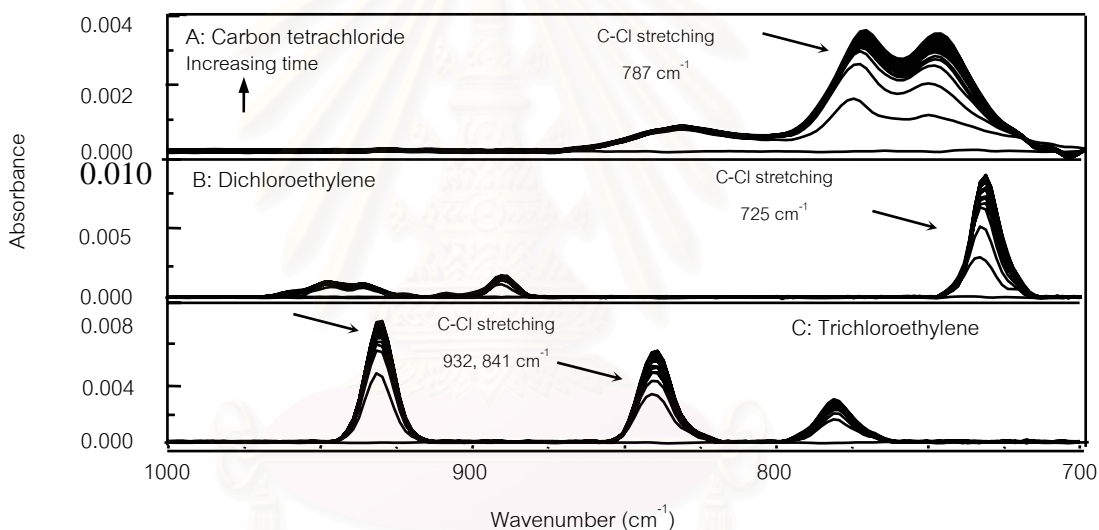

Figure 4.8 Enrichment response of dichloroethylene, trichloroethylene and carbon tetrachloride in a LDPE film coated on ATR prism. The concentrations of the analytes were all the same (1000 ppm). Polymer films of the same thickness were used for each experiment.

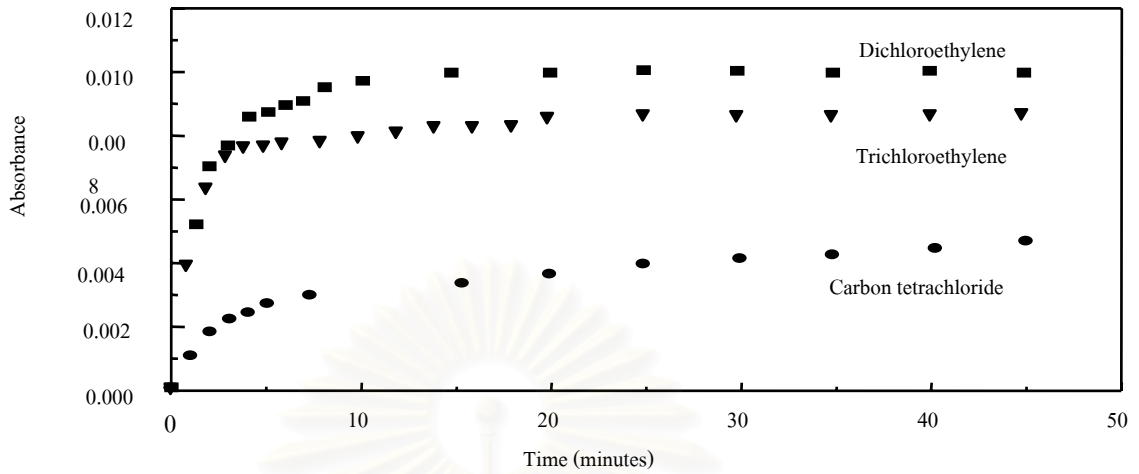

Figure 4.9 Time dependent absorption of carbon tetrachloride, dichloroethylene and trichloroethylene through the LDPE film coated on Ge IRE.

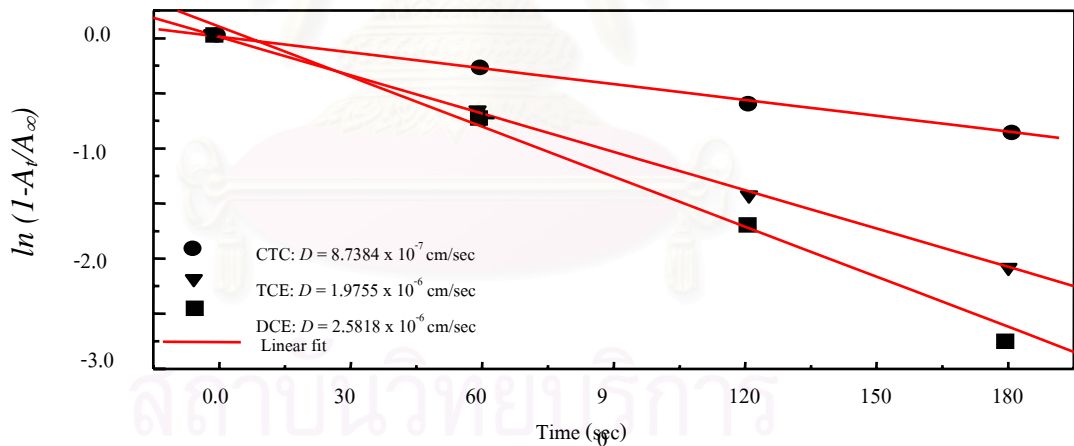

Figure 4.10 Plot of $\ln(I - A_t/A_\infty)$ with time. The diffusion coefficient of 1000 ppm trichloroethylene, dichloroethylene and carbon tetrachloride through the LDPE film are calculated from slopes.

4.3.3 Effect of solution concentration

By allowing the chlorinated hydrocarbon compounds to diffuse through the polymer film the chlorinated hydrocarbon is distributed uniformly over the entire film, when equilibrium is attained. Regarding to Figures 4.11 and 4.12, we investigated that (i) the concentration of organic compounds at the equilibrium becomes smaller with lower concentration of analyte and (ii) the diffusion coefficients obtained from the analyte with different concentrations are not significantly different. In addition, the diffusion coefficient for these three concentrations were 1.9755×10^{-6} , 1.8765×10^{-6} and 1.8092×10^{-6} cm/s for 1000, 700 and 100 ppm, respectively. It was determined that the terms of interfacial conductance were generally in the same order of magnitude for the analytes examined, suggesting a constant transport mechanism for the same analyte.

We measured changes in spectral intensities of two dominant peaks with trichloroethylene concentrations. There is readily discernible increase in intensity of the peaks as concentration of trichloroethylene is increased from 100 to 1000 ppm. Absorption intensity of the peak at 932 cm^{-1} (i.e., C-Cl stretching) increases with higher concentration of trichloroethylene in water.

In addition, solution containing <100 ppm of trichloroethylene were prepared in order to enable us to determine the lowest concentration level that the current experimental scheme can detect. The appearance of peak at 932 cm^{-1} became an evidence when ~90 ppm of solution was added to the water. Spectra recorded from the solutions with lower concentrations did not show any of the characteristic peaks presenting trichloroethylene in the polymer film.

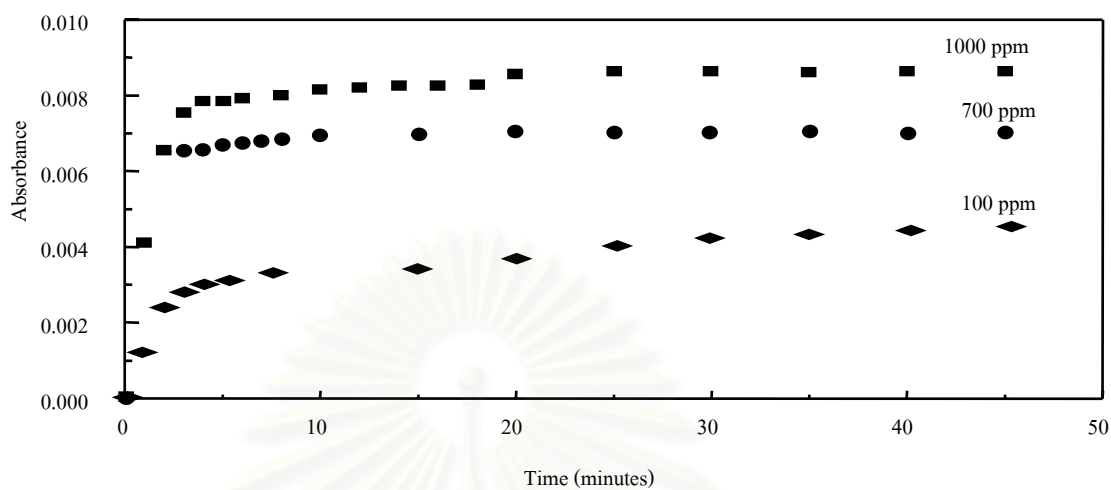

Figure 4.11 Time dependent absorption of 1000, 700 and 100 ppm trichloroethylene through the LDPE film coated on Ge IRE.

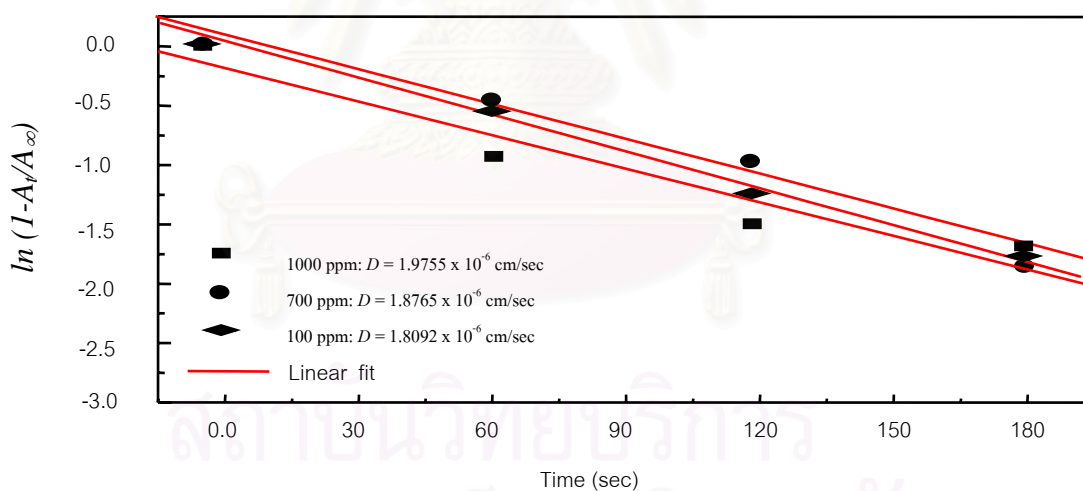

Figure 4.12 Plot of $\ln(I - A_t/A_\infty)$ with time. The diffusion coefficient of 1000, 700 and 100 ppm trichloroethylene through LDPE film are calculated from slopes of the curves.

4.3.4 Effect of polymer morphology

In order to study effect of the annealing temperature on diffusion of 1000 ppm trichloroethylene, the LDPE films are annealed at 90° C for 1.5 hour and used to compare with those un-annealed films. The percentage of crystallinity induced in the thermally annealed film was determined by equation 2.1. This involves in a quantitative monitoring of changes in the C-H rocking of LDPE at 730 and 720 cm⁻¹. Percent crystallinity of LDPE films are 58.559 % and 59.942 % for un-annealed and annealed films, respectively. Figure 4.13 shows a comparison of the C-Cl stretching of diffusing TCE into LDPE film. Figure 4.13 shows a plot of absorbance of the C-Cl stretching as a function of time, for diffusion of TCE in polymer film annealed at 90°. Furthermore, table 4.1 gives the diffusion coefficients obtained from the observation.

It is apparent from Figures 4.13, 4.14 and table 4.1 that (i) diffusion in the un-annealed films reached an equilibrium faster than that with annealed film; (ii) the spectral intensity at equilibrium was greater for the diffusion of the un-annealed film; (iii) the diffusion coefficients were lower with the un-annealed film.

Table 4.1 Effect of polymer morphology on diffusion coefficient.

Condition of LDPE film	% Crystallinity	<i>D</i> (cm/sec)
Un-annealing	58.559	1.9755 x 10 ⁻⁶
Annealing	59.542	9.4225 x 10 ⁻⁷

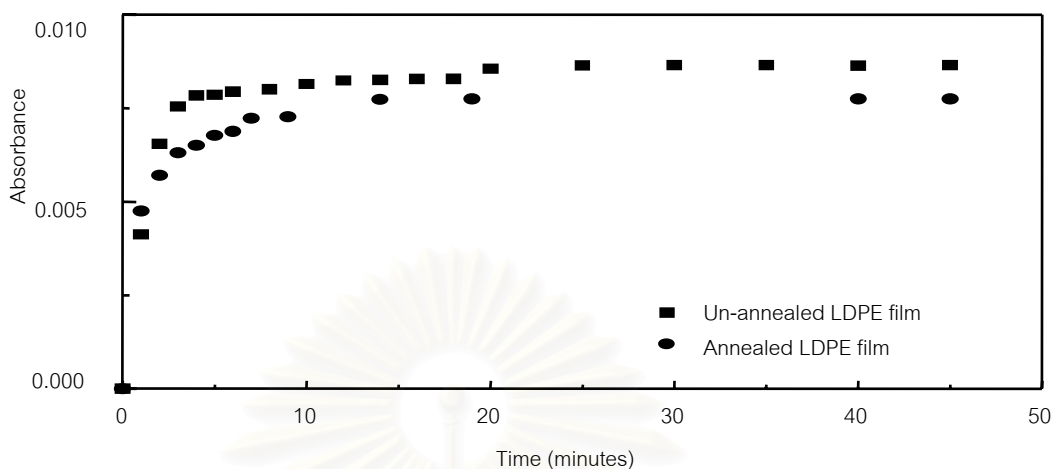

Figure 4.13 Time dependent absorption for diffusion of 1000 ppm trichloroethylene through an annealed LDPE film, as compared to that with an un-annealed LDPE film. Diffusion in the un-annealed films reached an equilibrium state faster with a greater absorbance.

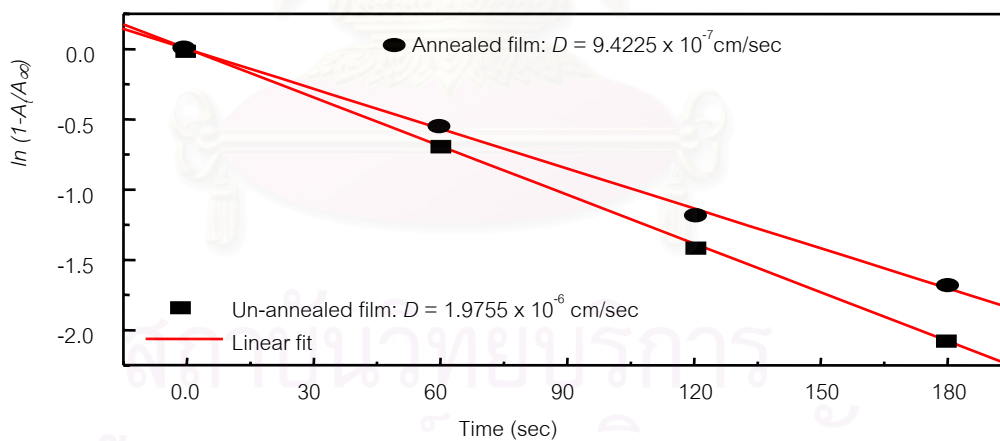

Figure 4.14 Plot of $\ln(1-A/A_\infty)$ with time of trichloroethylene diffusing through LDPE films. The diffusion coefficients are calculated from slope of the curves.

The above observations are probably due to the morphological changes in the polymer matrix as a result of annealing process. The diffusion of small molecules in the polymer matrix is partly dependent on the propagation of a molecule from one side to another. Flexibility of the polymer chain is necessary for the diffusion process. The diffusivity of the molecule can thus be influenced by factors that have influenced either structure or flexibility of the polymer. The diffusion pathways would be within the amorphous regions. So changes in crystallinity would consequently alter diffusion rate of the small molecule in the film. There are two major factors governing the morphology in this case: (i) processing history and (ii) defect content. The surface perfection and thickness of crystalline lamellae are modified by a number of random branches, which occur during the crystal-growth process as the defects are excluded to the lamellae surface. A number of defects moved to the surface of lamellae are determined by the thermal history; whereas the lamellae thickness can be evaluated from the annealing temperature and time. In melted crystallized PE surface, orientation effects (i.e., surface nucleation) might be an additional importance. Therefore, the time delay for diffusion in an annealed film at high temperature could be caused by an existence of some surface skins. This could also explain the lower diffusion coefficient for an annealed film.

4.3.5 Effect of polymer film thickness

Effect of LDPE thickness on diffusion of trichloroethylene was investigated. The concentration of trichloroethylene was kept as a constant at 1000 ppm, while the thickness of LDPE films were varied. Figure 4.15 shows enrichment curves for trichloroethylene (at 932 cm^{-1}) on LDPE films of different thickness.

Since all the films are exactly prepared in the same manner, the only variable is the concentration of LDPE affecting the film thickness. It was found that variation in LDPE concentration, 0.5 and 0.2 %, resulted in a regular decrease in polymer thickness coated on the ATR element. The thickness of two spin-coated LDPE films are 78 and 53 μm for thick and thin films, respectively. Since this work

is carried out on ATR element, the studies are limited by the penetration depth of the evanescent wave. Analytes that lie beyond this region in the polymer cannot be sensed until they enter to the region of informative depth. The rate of analyte diffusion decreases with increasing polymer thickness. Alternatively, LDPE film shows immediate detection indicating that the film thickness is within the sampling distance of the beam. The diffusion of trichloroethylene into LDPE films may be eliminated from the enrichment curves presented in Figure 4.15. The obtained results suggest that thin coating allow more rapid response. When a thick film is employed, a longer diffusion time is required. However, the concentration of the chlorinated hydrocarbon compounds at equilibrium is quite low. This may result in poor sensitivity and detection limit of the technique. In practice, when a very thin film ($< 5 \text{ }\mu\text{m}$) is employed, water absorption may obscure the absorption of chlorinated hydrocarbon molecules.

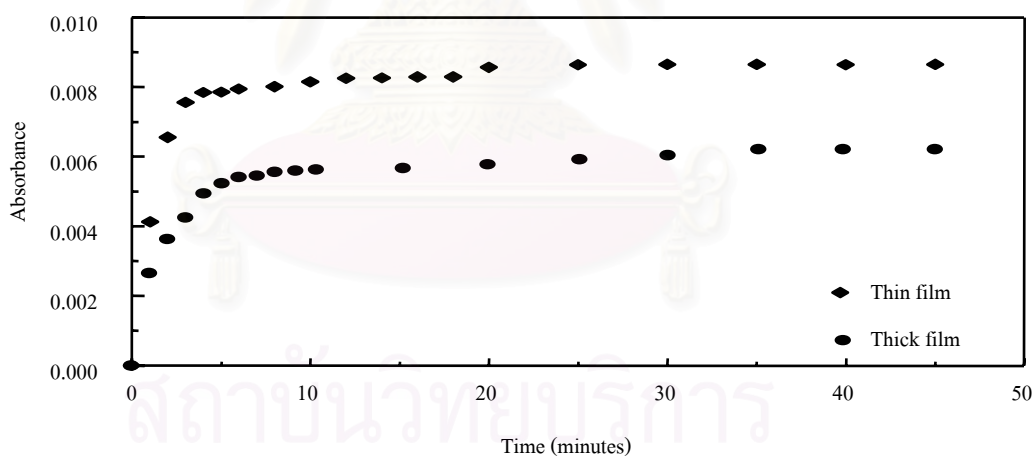

Figure 4.15 Effect of polymer film thickness on diffusion of trichloroethylene. Concentration of trichloroethylene is 1000 ppm. Peak height was observed at 932 cm^{-1} . In case of TCE, the thick film shows lower equilibrium than the thin film.

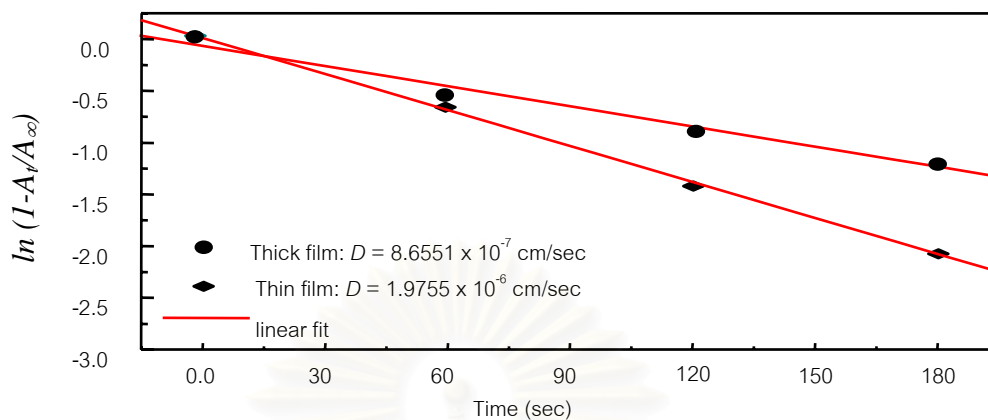

Figure 4.16 The plot of $\ln (I-A_t/A_\infty)$ with time. The diffusion coefficients of trichloroethylene through thick and thin LDPE films were calculated from slopes.

Moreover, The effect of film thickness on diffusion behavior was confirmed by new ATR sensor (i.e., coated LDPE film on a PTFE plate) as a probe. Various film thickness were prepared by adding a number of coating from 1 to 7 layers with dip coating process. The MatLab program was employed for estimating the LDPE film thickness coated on a PTFE plate. The thickness of thin LDPE film is calculated from spectral intensities of the film via three layer-models (i.e., Ge/LDPE/air and Ge/LDPE/PTFE). The thickness of the film are 0.112, 0.134, 0.140, 0.158, 0.181, 0.203 and 0.221, respectively, for 1 to 7 layers of coating.

The new ATR sensor also employs polymer film to enrich the dissolved chlorinated hydrocarbon compounds as similar to the current ATR sensors. However, the polymer film is not coated on the IRE as that for the current ATR sensors. The probing film is coated on water resistance polymer film (i.e., PTFE). When being used, each of probing sensor was immersed in 1000 ppm trichloroethylene for a short time (~1 minute) to detect the analyte. The dissolved chlorinated hydrocarbon is then adsorbed onto the film surface. The film is then brought into contact with the IRE, there might be some residual water left on the surface. Wiping the water is not necessary since the water will be squeezed out as a

small force is applied onto the film. As a result, no interference of water absorption bands was observed in the spectral region studied.

Figure 4.17 shows a comparison of absorption intensities of TCE obtained with various thickness of LDPE coating after 1-minute enrichment. The LDPE film with thickness of 0.112 μm gives the highest peak intensity at C-Cl stretching close to 0.002. This phenomena indicates that the ATR sensor using an IRE coated with a membrane thickness as thin as 0.112 μm was applicable for the enrichment of analyte. The better performance of LDPE film can be explained by reducing film thickness resulting in short enrichment time. In addition, this indicates that the thinner film shows rapid response and higher spectral intensity, which result in better sensitivity compared to those with thicker film.

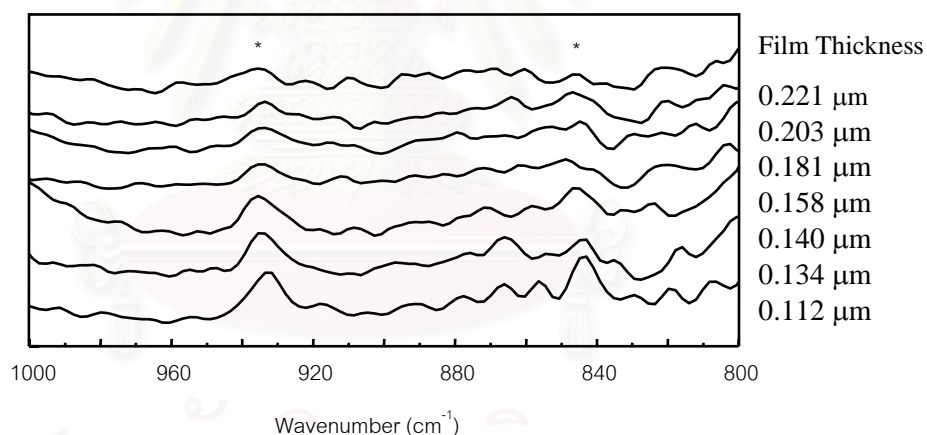

Figure 4.17 The spectral intensity of C-Cl stretching band at various film thickness after 1-minute enrichment. The LDPE film coated on ($1.3 \times 2.5 \text{ cm}^2$) flat PTFE plate was used as a probe.

4.3.6 Effect of additive in polymer matrix

Because of the subsequent measurement, the polymer film used in this work must be removed before re-coating the new polymer film onto the Ge IRE. The subsequent coating may damage an expensive IRE. Regeneration of the polymer film by rinsing with a large amount of organic solvent can be performed. Cross contamination can be introduced by the regeneration process. As a result, the effect of additives in LDPE matrix is observed using dip-coating preparation instead of spin coating.

Figure 4.18 shows the ATR FT-IR spectrum of coated LDPE on PTFE plate with 4-chlorobenzaldehyde added as an additive in the polymer solution. The absorption bands in the region of $2000\text{-}1500\text{ cm}^{-1}$ due to C=O stretching and C=C aromatic (i.e., 1758 and 1575 cm^{-1}) are readily apparent. These bands are caused by the 4-chlorobenzaldehyde in the polymer matrix. Systematic studies were carried out to determine the optimal concentration of the additive in LDPE solution with toluene.

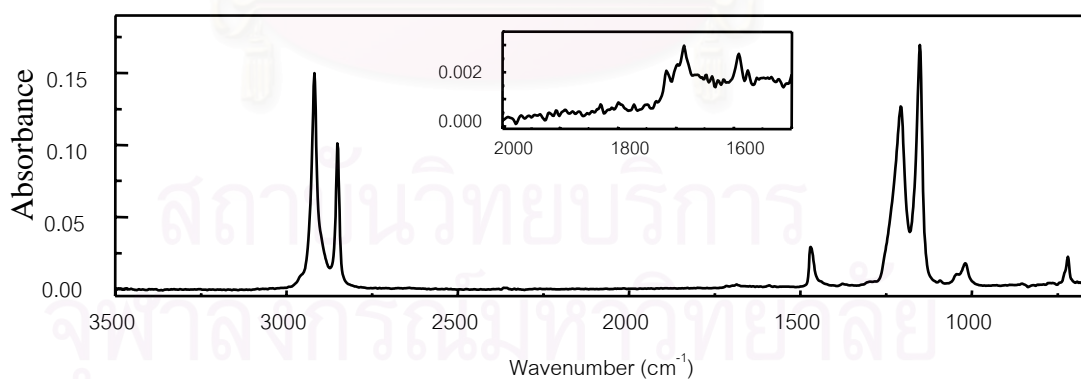

Figure 4.18 ATR FT-IR spectrum of a dip-coated LDPE film on a PTFE plate. The LDPE solution is composed of 4-chlorobenzaldehyde, which shows characteristic peak of C=O stretching at 1758 cm^{-1} .

Figure 4.19 represents effect of the additive concentration on absorption intensity of trichloroethylene at 932 cm^{-1} after 15-minutes enrichment. Concentrations of 4-chlorobenzaldehyde, expressed as % w/v in toluene, containing in LDPE solution were varied from 0.00 to 4.08 %. Figure 4.19 shows that increasing concentration of 4-chlorobenzaldehyde in the LDPE film results in higher diffusivity of the diffusant into polymer film. The polymer film, which consists of LDPE with 4-chlorobenzaldehyde, acts to enrich the chlorinated hydrocarbons and concentrates them within the penetration depth of the evanescent wave.

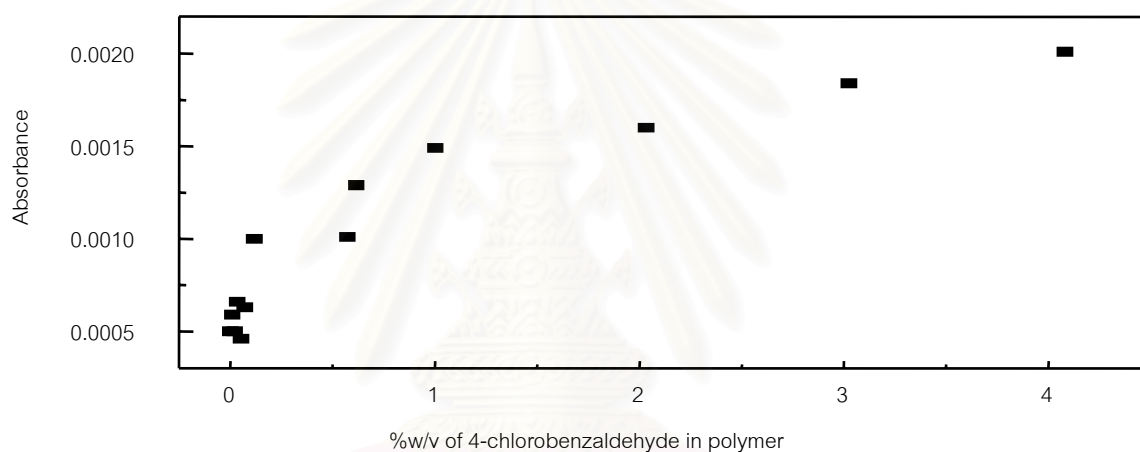

Figure 4.19 Absorbance of C-Cl stretching band after 15-minutes enrichment as a function of 4-chlorobenzaldehyde concentration.

The investigation demonstrates the interaction between diffusant and additive. 4-chlorobenzaldehyde has C=O band that can easily interact to hydrogen atoms in trichloroethylene. Increase of 4-chlorobenzaldehyde in polymer film gives a high probability of hydrogen bond to be occurred. When the hydrogen bonding increases, the trichloroethylene molecules preferentially partition from the aqueous phase by penetrating into polymer film, and increase with 4-chlorobenzaldehyde. As a result, studies of the chlorinated hydrocarbon show that much higher quantities of additive incorporated into the LDPE polymer matrix yield a substantially high enrichment.

4.3.7 Effect of free volume in polymer film on diffusion behavior

Two methods were employed for preparing two types of polymer film in order to study the effect of free volume on diffusion behavior. One film was prepared by hot pressing method; whereas another was solution casting technique. The dimensions of both films type were controlled and to be the same. The film thickness was about 230 μm with the area of 1 x 1 cm^2 . For comparison of LDPE film preparations, solvent-cast films were preparing by dissolved polymer beads in solvent (i.e., toluene) and then allowing the solvent to evaporate completely at room temperature. The slightly evaporation of solvent would produce many pores in the polymer film. In contrast to hot pressing method, the polymer film was prepared by adding a pressure onto melted polymer beads in order to obtain a dense film. As a result, the polymer film hot-pressed has lower free volume in polymer matrix.

Regarding to Figure 4.20, the absorbance of trichloroethylene is lower for solution cast film, as compared with hot-pressed film. The new ATR sensor can detect the analyte at the film surface, which is directly in contact with analyte solution. If there were many pores in polymer matrix, the diffusant would rapidly enter in to the film. Therefore, there is lower residual trichloroethylene detected at film surface. Pore size may also affect the adsorption of trichloroethylene in the coated film. A decrease of pore radius would increase the interaction between pore wall and organic compound resulting better adsorption of trichloroethylene on the film. However, if the pore size is very small and the trichloroethylene cannot enter into the pore, the compound would be excluded from the film. This would affect to observed absorbance by increasing the signal.

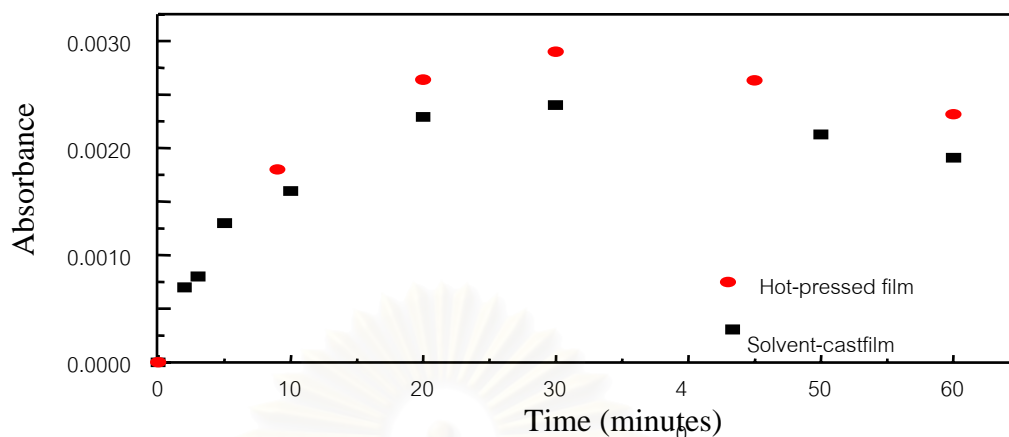

Figure 4.20 The absorption intensity of C-Cl stretching (i.e., 932 cm^{-1}) versus time presents diffusion behavior of 1000 ppm trichloroethylene through solvent-cast and hot-pressed LDPE films. The enriched analyte at surface of hot-pressed film shows higher signal than using solvent-cast film as a probe.

4.3.8 Initial absorption of 1000 ppm TCE on hot-pressed LDPE film

In case of the current ATR sensor with quantitative analysis, the calculation of diffusion rate is based on equilibrium concentration of analyte in polymer film. The diffusion is allowed to reach equilibrium where a uniform concentration of analyte compound within the film is obtained, and the polymer film thickness (the exact film thickness must be employed for all measurements). The concentration of the chlorinated hydrocarbon compounds on the film at equilibrium is greatly influenced by the film thickness. The concentration of chlorinated hydrocarbon compounds at the equilibrium becomes smaller with a thicker film. However, an uniform thickness of the coated film is difficult to be prepared.

On the other hand, the diffusion of chlorinated hydrocarbons through polymer film until reaching an equilibrium is not necessary for the new ATR sensor with quantitative purpose. There is no stripping of probing film out of the IRE or regeneration of the film required. Figure 4.21 shows effect of the film thickness on absorption intensity of trichloroethylene at 932 cm^{-1} after 1-minute enrichment. The

thickness of LDPE film was varied from 380 to 560 μm . It is apparent that the film thickness does not affect the absorption intensity. The absorption intensities of C-Cl stretching of all probes were close to 0.002. From the observation, it is possible to apply this technique for quantitative analysis without the dependence of film thickness. Moreover, a large number of probing films can be prepared at the same time, many samples can be investigated within a short period of time. In order to apply the new sensor for quantitative analysis, the spectral acquisitions have to be done at the beginning of the adsorption process where high concentration of analyte at the surface of probing film is achieved and additionally a fixed period of time for adsorption can be adopted. Under a constant adsorption period, a higher absorbance implies a greater concentration of chlorinated hydrocarbon compounds in the aqueous solution.

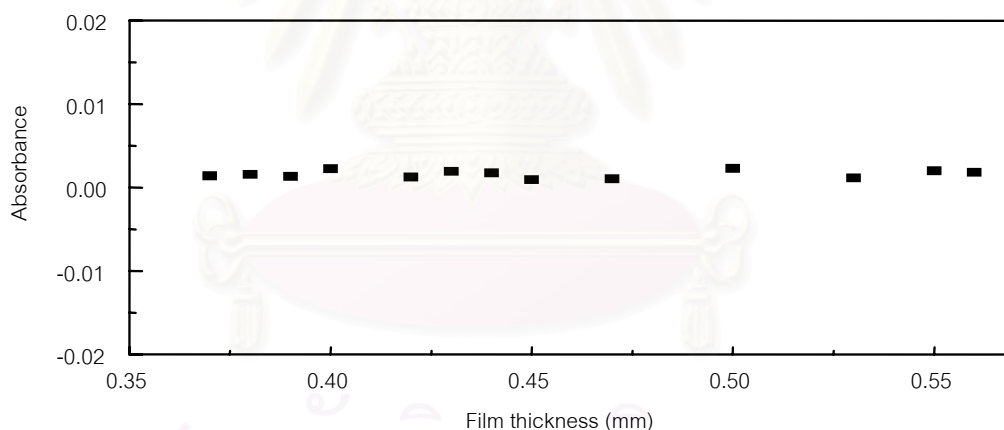

Figure 4.21 Initial absorption of 1000 ppm trichloroethylene, detected on hot-pressed LDPE film of various thickness. The absorption is independent to the film thickness.

4.4 Slightly dissolved compounds contaminated in water

4.4.1 Adsorption of fluorolube and pesticides on LDPE film

In this section, there are 4 species of slightly dissolved compounds contaminated in water used. One is fluorolube and others are standard solution of pesticides (Endrin, Endosulfan-sulfate and DDT). Due to the low solubility of fluorolube and these pesticides; it cannot be dissolved very well in water. In general, it can be found in ground water and water surface. Non-dissolved chlorinated hydrocarbons and fluorolube contaminated in water can be easily observed by using the new ATR sensor; i.e., freestanding film of hot-pressed LDPE with ATR FT-IR spectroscopy.

The probe was made in forms of a thick film. When used, the film was placed onto the surface of analyte solutions and analyte molecules were therefore adsorbed onto the film surface. After that, the film was brought into contact with the IRE and before collection. The adsorption peaks of pesticide and fluorolube were observed as seen in Figure 4.22. The concentration of each analyte was prepared at 100 ppm. Two drops (~ 0.1 mL) of the selection were used for spectral collection. From the calculation, there is only 10 µg in 0.1 mL in analyte solution for analysis. Since very low quantity of compound was determined, the ATR technique shows high sensitivity for the detection.

When the new experimental procedure for determining non-dissolved compounds is used. The analyte stay at the surface of probing film and cannot diffuse through polymer film. Therefore, the electric field of the ATR technique is effectively utilized since the adsorbed chlorinated hydrocarbon molecule interacts with the electric field of the greatest strength at the interface. The technique is robust and a large number of samples can be examined within a short period of time. As a result, a number of probing films can be prepared at the same time, applications of the sensor in field analysis are possible with high sensitivity and low detection limit

as well. Due to the elimination of frequent coating and stripping of probing polymer film, a long working lifetime of expensive IRE is expected.

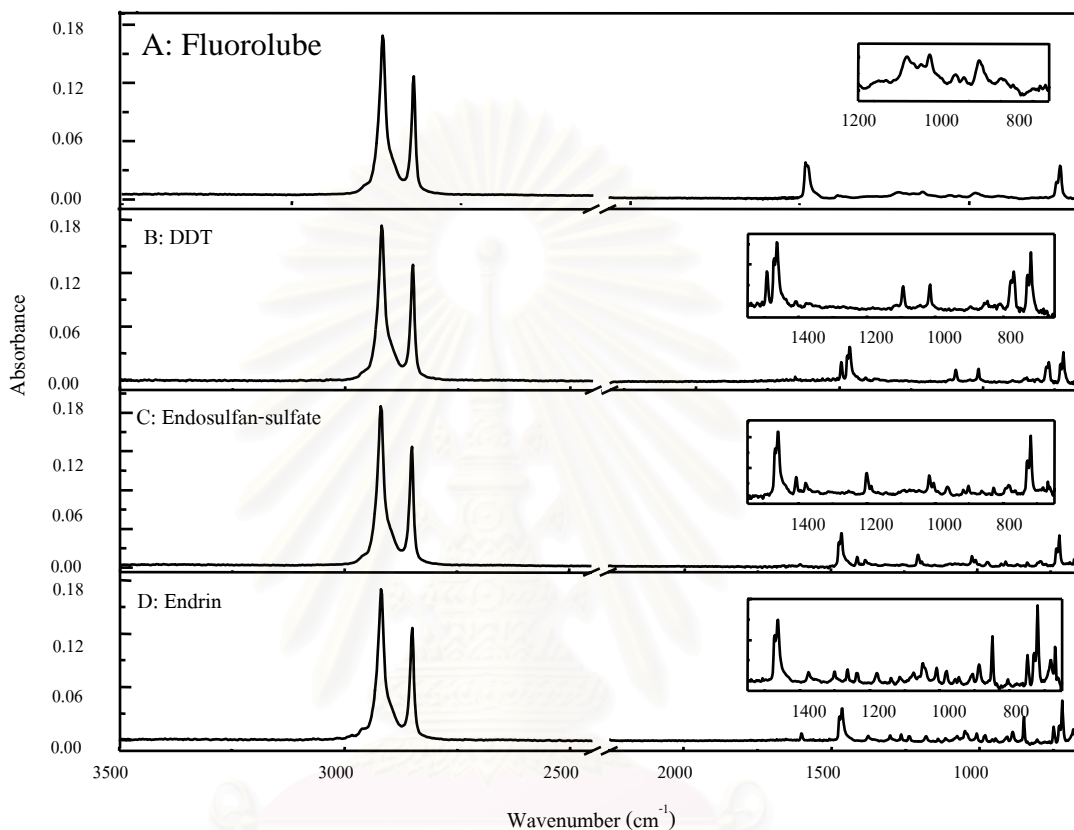

Figure 4.22 Adsorption of fluorolube (A), DDT (B), Endosulfan-sulfate (C) and Endrin (D) on hot-pressed LDPE film. The sensor shows good response in a short period of time.

4.4.2 Diffusion behavior of pesticides

To investigate the diffusion of three species of pesticides (Endrin, Endosulfan-sulfate and DDT) by current ATR sensor, a thin LDPE film is coated on the Ge IRE with the thickness less than the penetration depth. The polymer film is then placed onto the surface of solution to contact the analyte compound. The pesticides are rapidly adsorbed at the surface of probing film. The diffusion studies of large pesticide molecules were investigated as a function of time and as shown in

Figure 4.23. The molecules are allowed to diffuse into the polymer film for 30 minutes while spectra were collected at a time interval of 5 minutes. The spectral intensity does not change with time. The constant band intensity shows that large molecules of these pesticides do not diffuse into the polymer matrix.

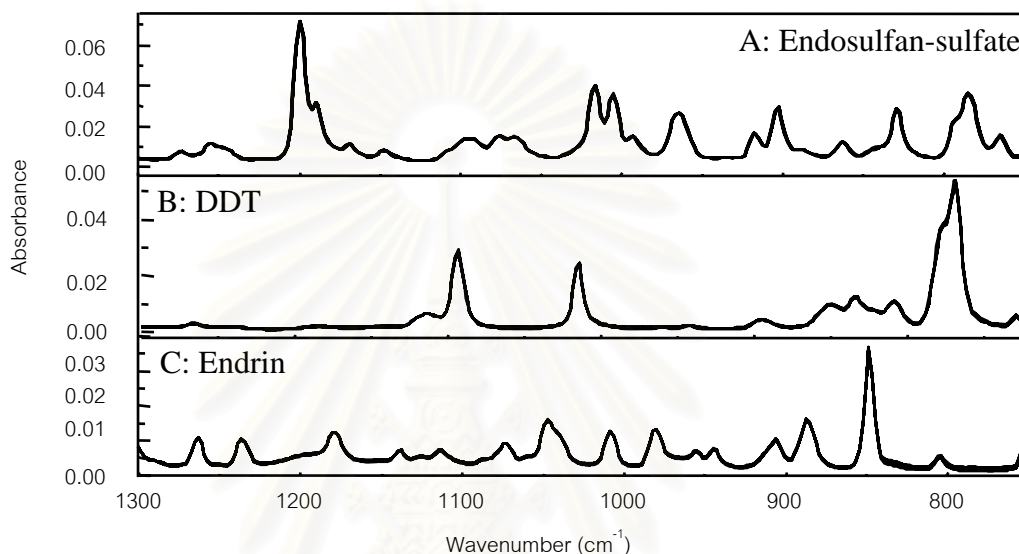

Figure 4.23 ATR spectra of adsorbed species on coated LDPE film: Endosulfan-sulfate (A), DDT (B) and Endrin (C). The molecules are allowed to diffuse into the polymer film for 30 minutes while spectra were collected at the time interval of 5 minutes.

In addition, the analysis procedure of new ATR sensor was compared to that of current ATR sensor as shown in Figure 4.24. Uses of new ATR sensor (hot-pressed LDPE films) as a probe present higher spectral intensities of adsorbed pesticide than those with current ATR sensor (spin-coated films). The higher absorbance observed in Figure 4.24 are due to the electric field strength. According to the decay characteristic of the electric field, molecules at the distance far away from the IRE do not have the same magnitude of absorbance as those near the IRE. In case of current ATR sensor, the molecules responsible for the absorption are those far away from the IRE surface because of the weak electric field at the IRE/sample interface region. Therefore, spectra of the spin-coated LDPE films show lower

intensities than those new ATR sensors, which can detect the adsorbed pesticides directly at the IRE surface.

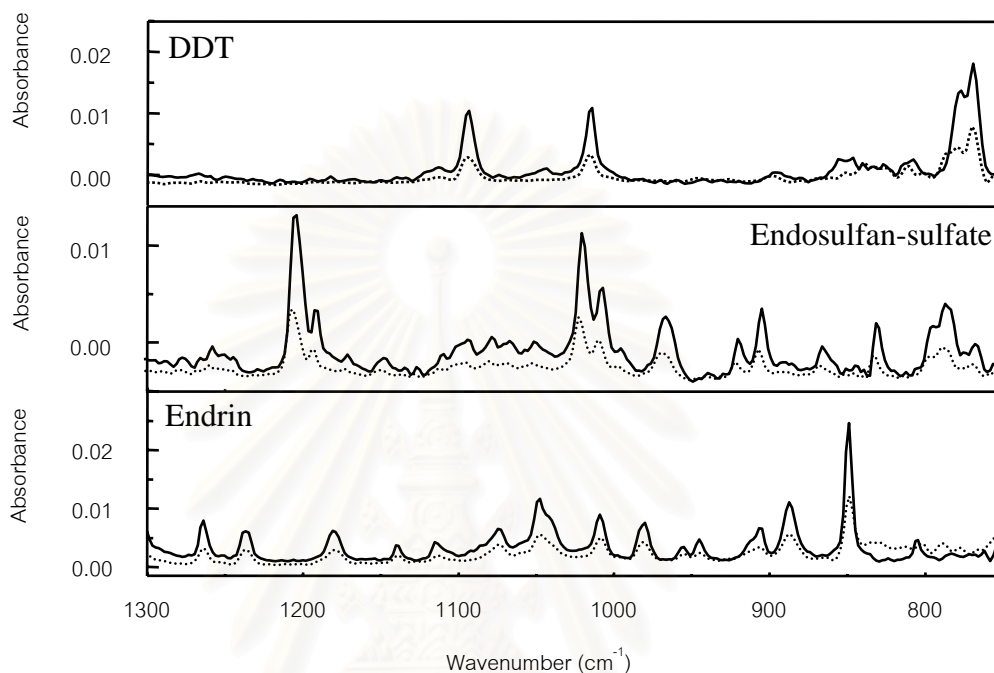

Figure 4.24 Spectral comparison using hot-pressed (—) and spin-coated LDPE film (.....) as a probe.

4.5 Drawback of current ATR sensor

The information obtained from study of effects on diffusion behavior by current ATR sensor will be employed for designing new ATR sensor in order to eliminate obstructions with current ATR sensor. The problems encountered by the current ATR sensor include:

1. According to the decay characteristic of the electric field, the current ATR sensor is appropriate for only determination of dissolved chlorinated hydrocarbons. When used with the non-dissolved compounds contaminated on water surface, the molecules responsible for the absorption are those far away from the IRE surface due to the weak field.

2. The thickness of polymer film must be optimized. When a thick film is employed, a long diffusion time is required. Moreover, the concentration of analyte compound in the film at equilibrium would be very low resulting in poor sensitivity and detection limit. When a very thin film is employed, water absorption may obscure the absorption of chlorinated hydrocarbon molecules. In general the thickness of coated film is greater than 5 μm .
3. For subsequent measurement, the used polymer film must be removed and the new polymer film is then coated on the IRE. The subsequent coating/stripping may damage an expensive IRE.
4. For quantitative analysis, the dissolved chlorinated hydrocarbon compounds diffuse toward the IRE until their concentration near the IRE are high enough to get significant absorbance. However, diffusion is allowed until equilibrium is reached and probably takes a long time for analysis.
5. The concentration of chlorinated hydrocarbon compounds at equilibrium becomes smaller with the thicker film.
6. In order to employ the observed spectra for quantitative comparison, an exact thickness must be prepared for subsequent measurements. The concentration of analyte compounds in polymer at equilibrium is greatly influenced by the thickness of polymer film. However, an exact thickness of coated film is difficult to achieve for quantitative comparison.
7. The polymer film must have optical contact with the IRE all the time. Spin coating of the probing film on IRE is employed to ensure the optical contact. A detachment may occur when the chlorinated hydrocarbon compounds and water swell the film.

CHAPTER V

CONCLUSIONS

LDPE coated ATR crystal is employed for monitoring chlorinated hydrocarbon concentration in aqueous solution using infrared spectroscopy. The chlorinated hydrocarbon compounds will preferentially separate from an aqueous solution into hydrophobic polymer. The hydrophobic polymer coating acts as a protective coating for IRE and pre-concentrated the analytes compounds from aqueous solution while excluding the strongly absorbing water from reaching the optical region of sensor.

The transport of some relatively low molecular weight organic analytes, such as trichloroethylene, dichloroethylene and carbon tetrachloride from an aqueous phase and through the LDPE cladding can be modeled by Fickian diffusion. The diffusion of liquid of liquids through polymer depends on the nature of polymer, time, the shape or size of diffusant molecules and filler or additive in polymer matrix but the rate independent to the concentration of penetrant.

In additional, the created new infrared sensor based on ATR FT-IR spectroscopy was successfully employed for determination of both dissolved and slightly dissolved chlorinated hydrocarbons with improving sensitivity, enhancing detection limit, and shortening the operation time. The spectral acquisition has to be done within a beginning of adsorption process where high concentration of analyte at the surface of the probing film is achieved.

REFERENCES

1. Blair, D. S., Burgess, L. W., and Brodsky, A. M. (1997). Evanescent Fiber-Optic Chemical Sensor for Monitoring Volatile Organic Compounds in Water. Anal. Chem., 69: 2238-2246.
2. Odian, G. (1991). Principles of Polymerization. New York: John Wiley & Sons, Inc.
3. Urban, M. W. (Ed.). (1996). Attenuated Total Reflectance Spectroscopy of Polymer: Theory and Practice. Washington, DC: American Chemical Society.
4. Fahrenfort, J. (1961). Attenuated Total Reflection A New Principle for the Production of Useful Infra-red Reflection Spectra of Organic Compounds. Spectrochim. Acta., 17: 698-709.
5. Annual Book of ASTM Standards., (1996). Standard Practices for Internal Reflection Spectroscopy, 10: 842-857
6. Harrick, N. J. (Ed.). (1979). Internal Reflection Spectroscopy. New York: Harrick Scientific Corporation.
7. Mirabella, F. M. (1993). Internal Reflection Spectroscopy: Theory and Applications. New York, USA: Marcel Dekker, Inc.
8. Ekgasit, S., and Padermshoke, A. (2001). Optical Contact in ATR/FT-IR Spectroscopy. Appl. Spectrosc., 55: 1352-1359.
9. Sammon, C., Yarwood, J., and Everall, N. (2000). A FTIR-ATR Study of Liquid Diffusion Processes in PET Films: Comparison of Water with Simple Alcohols. Polymer, 41: 2521-2534.
10. Hajatdoost, S., and Yarwood, J. (1997). ATR-FTIR Spectroscopic studies of the Structure and Permeability of Sulfonated poly(ether sulfone) Membranes: Part 3. Effect of Sorption and Desorption, and of Annealing. J. Chem. Soc., Faraday Trans., 93:1613-1620.
11. Fieldson, G. T., and Barbari, T. A. (1993). The Use of FTIR-ATR Spectroscopy to Characterize Penetrant diffusion in Polymers. Polymer, 34(6): 1146-1153.

12. Simhony, S. (Ed.). (1988). Fourier Transform Infrared Spectra of Organic Compounds in Solution and as Thin Layers Obtained by Using an Attenuated Total Reflected Fiber-optic Cell. Anal. Chem., 60: 1908-1918
13. Gobel, R. (Ed.). (1995). Infrared Attenuated Total Reflection Spectroscopic Investigations of the Diffusion behavior of Chlorinated Hydrocarbons into Polymer Membranes. Vibrational spectroscopy., 8: 141-149.
14. Regan, F. (Ed.). (1996). Determination of Pesticides in Water using ATR-FTIR Spectroscopy on PVC/paraffin Coating. Anal. Chem. Acta., 334: 85-92
15. Yang, J. and Her, J. W. (1999). Purge-and-Trap ATR/IR Spectroscopic Method for the Determination of Semivolatile Aromatic Compounds in Soils. Anal. Chem., 71: 4690-4696.
16. Acha, V. (Ed.) (2000). Detoxification of a Mixture of Aliphatic Chlorinated Hydrocarbons in a Fixed-bed Bioreactor: Continuous on-line Monitoring via an Attenuated Total Reflection-Fourier Transform Infrared Sensor. Wat. Sci. Tech., 40: 41-47.
17. Ekgasit, S., and Siesler, H. W. (1998). Simplified Equation for ATR Spectral Intensity of a Three-Phase System. Appl. Spectrosc., 52(3): 367-374.
18. Han, L. (Ed) (1999). Enhancing IR Detection Limits for Trace Polar Organics in Aqueous Solutions with Surface-Modified Sol-Gel-Coated ATR Sensors. Appl. Spectrosc., 53:381-389
19. Lu, Y. (Ed) (1996). Chemical Sensors Based on Hydrophobic Porous Sol-Gel Films and ATR FT-IR Spectroscopy. Sensors and Actuators B., 35-36: 517-521
20. Semwal, R. P. (Ed) (1996). Study of Diffusion and Sorption of Bis-(2-chloroethyl) Sulfide (SM) and Bis-(2-chloroethyl) ether (OM) Through Polyethylene (PP) and Biaxial-Oriented Polypropylene (BOPP) Films by the FTIR-ATR Spectroscopic Method. J. Appl. Polym. Sci., 60:29-35

21. Poston, P. E. (Ed) (1998). *In-Situ* Detection of Adsorbates at Silica/Solution Interfaces by Fourier Transform Attenuated Total Reflection Spectroscopy Using a Silica-Coated Internal Reflection Element. Appl. Spectrosc., 52: 1391-1398



สถาบันวิทยบริการ
จุฬาลงกรณ์มหาวิทยาลัย



APPENDICES

สถาบันวิทยบริการ
จุฬาลงกรณ์มหาวิทยาลัย

APPENDIX A
PICTURES OF INSTRUMENTS AND ACCESSORIES



Bruker Vector 33 FT-IR spectroscopy

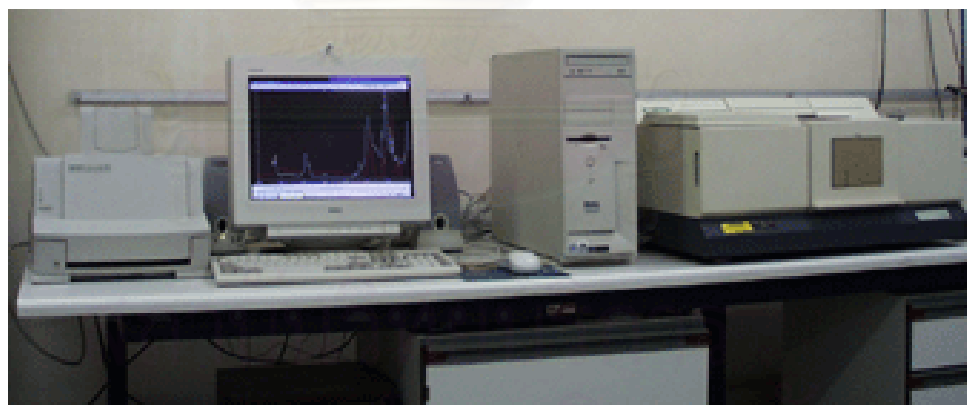

Bio-Rad FTS 175 FT-IR spectroscopy



Variable angle attachment accessory (The Seagull™)



IRE holder and bronze reservoir made of bronze for study the diffusion behavior of dissolved chlorinated hydrocarbons through LDPE film

APPENDIX B

PROGRAM FOR CALCULATING THICKNESS OF LDPE FILM IN

THREE-PHASE SYSTEM

1. CalThickFilm.data.m

```
% This is a data file for calculating the thickness of thin film
% The detail description for all parameters can be found in Sanong's paper;
% S. Ekgasit, Appl. Spectrosc, 52(3), 367(1998).

%file_out: filename (with dot '.') for output file
%file_3P: filename for ATR spectrum of Three-phase system(with %dot '.')
%file_film: filename for ATR spectrum of thin film medium (with %dot '.')
%file_subs: filename for ATR spectrum of substrate medium (with %dot '.')
%h: liquid film thickness in micrometer
%hs: increase of liquid film thickness per round of calculation in micrometer
%n0: refractive index of the incident medium
%nf: refractive index of the absorbing medium
%polarize: degree_of_polarization; -1=s, 0=non, 1=p
%t0: angle of incidence (degree)

file_out = char('bulk_GePETef');
file_3P = char(' GePETef');
file_film = char('Ge_PE');
file_subs = char('Ge_Tef');
h = 0.01;
hs = 0.001;
n0 = 4.0;
nf = 1.5;
polarize = 0
t0 = 45*pi/180;
```

2. CalThickFilm.main.m

```
%This program is for calculating the thickness of thin film;
% The detail description for all parameters can be found in Sanong's paper;
% S. Ekgasit, Appl. Spectrosc, 52(3), 367(1998).

CalThickFilm.data.m;
temp = load(file_3P);
wn = temp(:,1);
A3p = temp(:,2);
temp = load(file_film);
Af = temp(:,2);
```

```

%temp = load(file_thick);
%h = temp(:,2);
temp = load(file_subs);
As_2P = temp(:,2);
Dp = PenetrnDepth(wn,n0,nf,t0);

for k=1:20;
    Factor = exp(-2*h./Dp);
    As = (A3p-(1-Factor).*Af)./Factor;
    clf;
    plot(wn,As,wn,As_2P,wn,Af,wn,A3p);
    disp(h);
    pause;
    h=h+hs;
end

%disp('START WRITING ASCII FILES');
%file_name = strrep(file_out,','.As1');
%data_out = [wn As1];
%dlmwrite(file_name,data_out,'\t');
%file_name = strrep(file_out,','.As2');

data_out = [wn,As];
%dlmwrite(file_name,data_out,'\t');
%disp('STOP WRITING ASCII FILES');
disp('calculation finished')

```

3. PenetrnDepth.m

```

% This is program for calculating the penetration depth

function Dp = PenetrnDepth(wn,n0,nf,t0);
Dp=1./(2*pi*(wn/10000)*n0.*sqrt(sin(t0)^2-nf.^2/n0^2));

```

APPENDIX C

**FT-IR SPECTRA AND PEAK ASSIGNMENTS OF CHLORINATED
HYDROCARBON AND ADDITIVE**

1. Chlorinated hydrocarbons represent dissolved organic compounds (i.e., trichloroethylene, dichloroethylene and carbon tetrachloride)

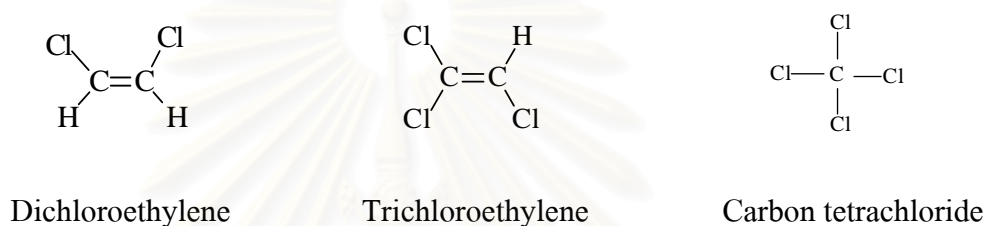

Figure 1. Chemical structures of dichloroethylene, trichloroethylene and carbon tetrachloride

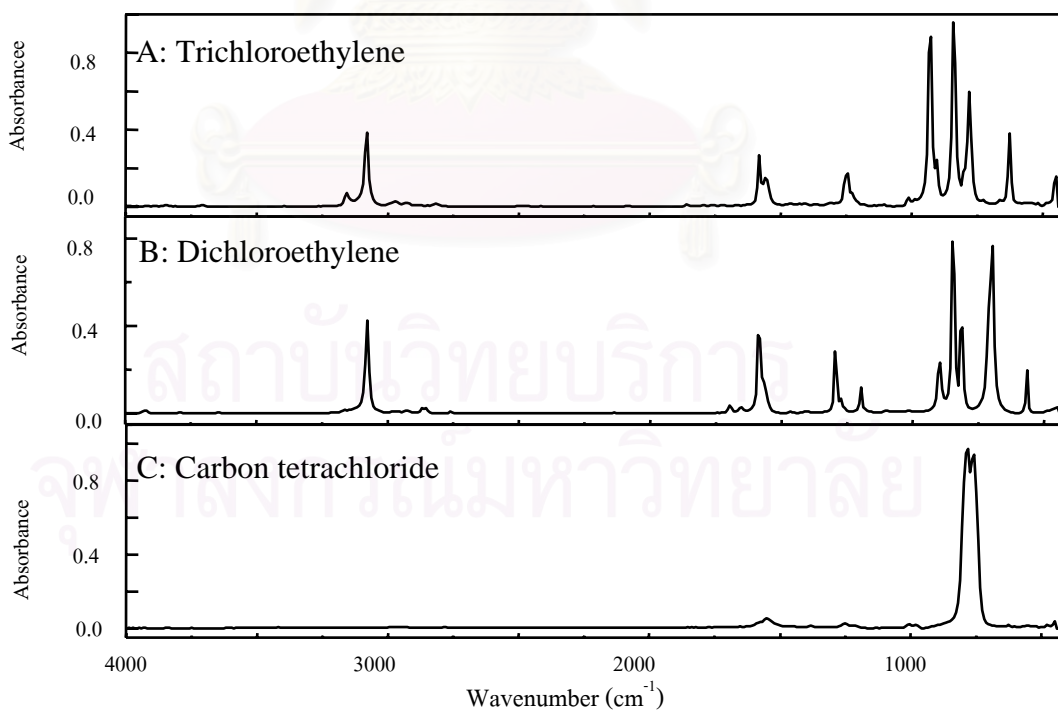

Figure 2. FT-IR spectra of trichloroethylene (A), dichloroethylene (B) and carbon tetrachloride (C)

Table 1. Peak assignments of trichloroethylene, dichloroethylene and carbon tetrachloride

Wavenumber (cm ⁻¹)	Peak Assignment
<u>Trichloroethylene</u>	
3072	=C-H stretching
2957	C-H stretching
1578	C=C stretching
1274	CH ₂ -Cl bending
932, 840	C-Cl stretching
<u>1, 2-Dichloroethylene</u>	
3083	C-H stretching
1584	C=C stretching
856	=C-H out of plane bending
700	C-Cl stretching
<u>Carbon tetrachloride</u>	
780	C-Cl stretching

2. Chlorinated hydrocarbons represent slightly dissolved organic compounds (i.e., Endrin, Endosulfan-sulfate and DDT)

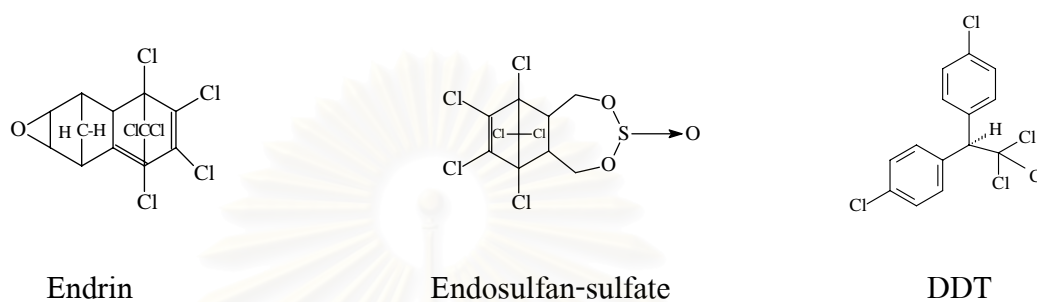

Figure 3. Chemical structure of Endrin, Endosulfan-sulfate and DDT

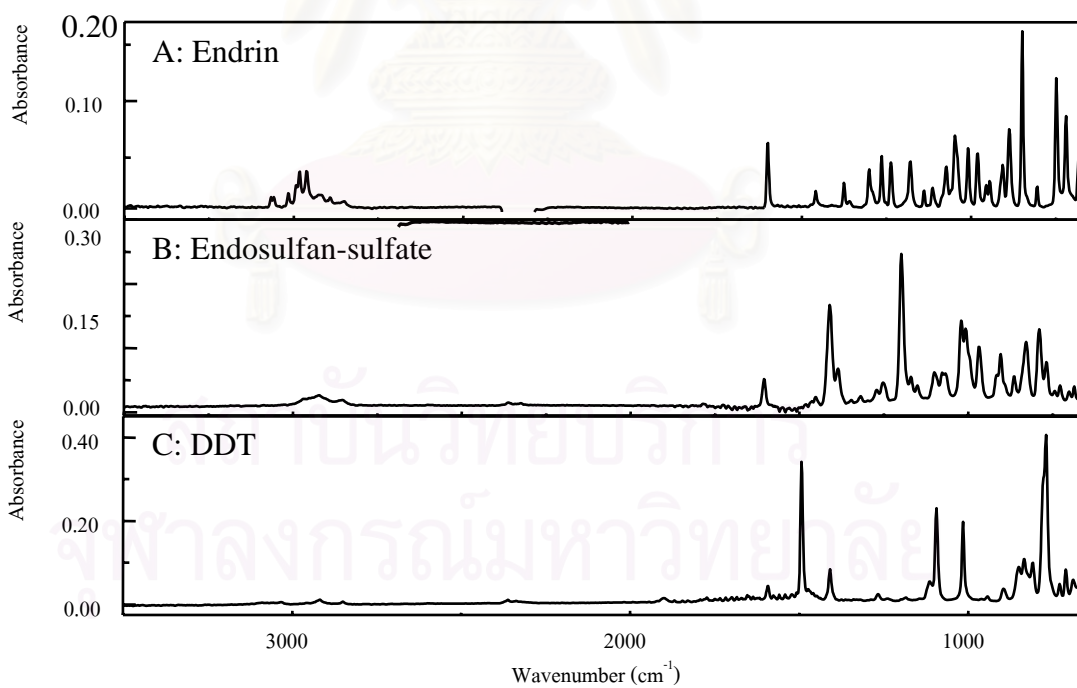
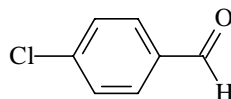
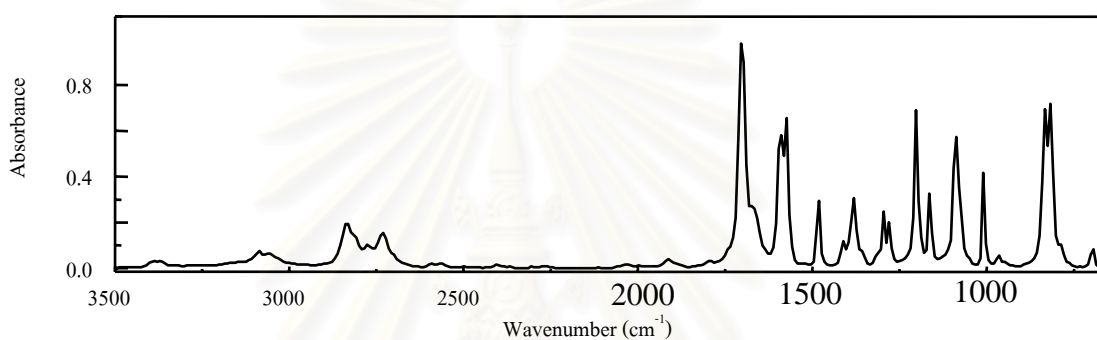

Figure 4. FT-IR spectra of Endrin (A), Endosulfan-sulfate (B) and DDT (C)

Table 2. Peak assignments of Endrin, Endosulfan-sulfate and DDT

Wavenumber (cm ⁻¹)	Peak Assignment
<u>Endrin</u>	
3087, 3063	Aromatic CH stretching
2968	CH ₂ Asymmetric stretching
2931	CH ₂ symmetric stretching
1604	Ring mode
1495	Ring mode
1235	C-O stretching
1048	Asymmetric C-O-C
849	Symmetric C-O-C
749	C-Cl stretching
683	Ring bending
<u>Endosulfan-sulfate</u>	
2903, 2863	C-H stretching
1643	C=C stretching
1202	S=O stretching
1019	C-O stretching
785	C-Cl stretching
<u>DDT</u>	
2910, 2871	C-H stretching
1584	Aromatic Ring Mode
1493	Aromatic Ring Mode
1408	Aromatic Ring Mode
1094	C-O stretching
863, 847	Aromatic out-of-plane CH bending
795	Out-of-plane CH bending
770	C-Cl stretching
698	Aromatic C-H bending

3. Additive in polymer matrix: 4-chlorobenzaldehyde

**Figure 5.** Chemical structure of 4-chlorobenzaldehyde**Figure 6.** FT-IR spectral of 4-chlorobenzaldehyde**Table 3.** Peak assignment of 4-chlorobenzaldehyde

Wavenumber (cm ⁻¹)	Peak Assignment
3086	=C-H stretching
2835, 2732	C-H stretching
1759	C=O stretching
1590, 1575	Benzene ring
1482	Ring stretching
1381	HC=O bending
1088	C-O stretching
819	C-Cl stretching
696	C-C-CHO bending
536, 479	In-plane and out-of-plane ring deformation

VITAE

Miss Tassimon Wiriyanachan was born in Songkhla, Thailand, on August 1st, 1977. She received bachelor degree of science in 1999 from Department of Industrial Chemistry, Faculty of Applied Science, King Mongkut's Institute of Technology North Bangkok. She started as a master degree student with a major in Polymer Science, Program of Petrochemistry and Polymer Science, Chulalongkorn University in 1999 and completed program in 2002.



สถาบันวิทยบริการ
จุฬาลงกรณ์มหาวิทยาลัย