

การเชื่อมโยงระหว่างสีของกาแฟในสื่อพิมพ์กับความคาดหวังของผู้บริโภค

นางสาวชุตติกาญจน์ อ่องจريت

วิทยานิพนธ์นี้เป็นส่วนหนึ่งของการศึกษาตามหลักสูตรปริญญาวิทยาศาสตรมหาบัณฑิต
สาขาวิชาเทคโนโลยีทางภาพ ภาควิชาวิทยาศาสตร์ทางภาพถ่ายและเทคโนโลยีทางการพิมพ์
คณะวิทยาศาสตร์ จุฬาลงกรณ์มหาวิทยาลัย
ปีการศึกษา 2554
ลิขสิทธิ์ของจุฬาลงกรณ์มหาวิทยาลัย

บทคัดย่อและแฟ้มข้อมูลฉบับเต็มของวิทยานิพนธ์ตั้งแต่ปีการศึกษา 2554 ที่ให้บริการในคลังปัญญาจุฬาฯ (CUIR)
เป็นแฟ้มข้อมูลของนิสิตเจ้าของวิทยานิพนธ์ที่ส่งผ่านทางบัณฑิตวิทยาลัย

The abstract and full text of theses from the academic year 2011 in Chulalongkorn University Intellectual Repository(CUIR)
are the thesis authors' files submitted through the Graduate School.

ASSOCIATION BETWEEN COLOUR OF COFFEE IN PRINT MEDIA AND
CONSUMER EXPECTATIONS

Miss Chutikarn Ongjarit

A Thesis Submitted in Partial Fulfillment of the Requirements
for the Degree of Master of Science Program in Imaging Technology

Department of Imaging and Printing Technology

Faculty of Science

Chulalongkorn University

Academic Year 2011

Copyright of Chulalongkorn University

Thesis Title ASSOCIATION BETWEEN COLOUR OF COFFEE IN PRINT
 MEDIA AND CONSUMER EXPECTATIONS

By Miss Chutikarn Ongjarit

Field of Study Imaging Technology

Thesis Advisor Assistant Professor Suchitra Sueeprasan, Ph.D.

Accepted by the Faculty of Science, Chulalongkorn University in Partial Fulfillment of
the Requirements for the Master's Degree

..... Dean of the Faculty of Science
(Professor Supot Hannongbua, Dr.rer.nat.)

THESIS COMMITTEE

.....Chairman
(Associate Professor Aran Hansuebsai, Ph.D.)

.....Thesis Advisor
(Assistant Professor Suchitra Sueeprasan, Ph.D.)

.....Examiner
(Assistant Professor Chawan Koopipat, Ph.D.)

.....External Examiner
(Professor Tetsuya Sato, Ph.D.)

ชุตติกาญจน์ อ่องจรีต: การเชื่อมโยงระหว่างสีของกาแฟในสื่อพิมพ์กับความคาดหวังของผู้บริโภค. (ASSOCIATION BETWEEN COLOUR OF COFFEE IN PRINT MEDIA AND CONSUMER EXPECTATIONS) อ. ที่ปรึกษาวิทยานิพนธ์หลัก: ผศ.ดร. สุจิตรา สื่อประसार, 94 หน้า.

งานวิจัยนี้จึงศึกษาสีของกาแฟในภาพพิมพ์ที่ผู้สังเกตชอบ และความสัมพันธ์ระหว่างสีของกาแฟกับความคาดหวังในด้านรสชาติ และคุณภาพ ภายใต้สภาวะแสงเดย์ไลท์ และทังสแตน เพื่อหาความแตกต่างระหว่างสีที่ผู้สังเกตชอบภายใต้แสงทั้งสองสภาวะ รวมถึงความแตกต่างในด้านความชอบ และความคาดหวังของกลุ่มผู้สังเกต โดยใช้ภาพพิมพ์กาแฟเอสเพรสโซสีต่าง ๆ จำนวน 40 สี แต่ละภาพมีเฉพาะสีของกาแฟที่แตกต่างกัน นำมาให้ผู้สังเกตจำนวน 40 คน ซึ่งแบ่งออกเป็น 2 กลุ่ม คือ กลุ่มผู้สังเกตที่เป็นผู้เชี่ยวชาญในด้านกาแฟจำนวน 10 คน และกลุ่มผู้สังเกตทั่วไปที่ดื่มกาแฟจำนวน 30 คน ประเมินความชื่นชอบ คุณภาพ ความตั้งใจในการซื้อ ความเข้มข้นของรสชาติ และความคาดหวังในด้านรสชาติ ด้วยสเกล 1-9 ตั้งแต่มีความคาดหวังด้านนั้นน้อยที่สุด จนถึงมากที่สุด จากการทดลองพบว่า แสงทั้งสองสภาวะส่งผลต่อการรับรู้สีของผู้สังเกตทั้งสองกลุ่ม ทำให้รับรู้สีแตกต่างกัน และให้ผลความคาดหวังแตกต่างกันในระหว่างแสงทั้งสอง ผู้สังเกตทั้งสองกลุ่มมีความชื่นชอบ และความคาดหวังทางด้านรสชาติต่อกาแฟเอสเพรสโซสีต่าง ๆ แตกต่างกัน กลุ่มผู้เชี่ยวชาญชื่นชอบภาพสีกาแฟที่มีความสว่างสูงและมีสีเข้ม โดยเชื่อมโยงความสว่างและความอึดอัดสีกับคุณภาพ นอกจากนี้สีเหลืองถูกเชื่อมโยงกับรสชาติหวาน ทั้งสองกลุ่มผู้สังเกตคาดหวังรสชาติขมกับภาพสีกาแฟที่มีความสว่างต่ำ

ภาควิชา _____ วิทยาศาสตร์ทางภาพถ่ายและเทคโนโลยีทางการพิมพ์

สาขาวิชา _____ เทคโนโลยีทางภาพ

ปีการศึกษา _____ 2554

ลายมือชื่อนิสิต _____

ลายมือชื่อ อ.ที่ปรึกษาวิทยานิพนธ์หลัก _____

5272280823 : MAJOR IMAGING TECHNOLOGY

KEYWORDS : ESPRESSO COLOUR/ COLOR APPEARANCE/ ESPRESSO COFFEE

CHUTIKARN ONGJARIT: ASSOCIATION BETWEEN COLOUR OF COFFEE IN
PRINT MEDIA AND CONSUMER EXPECTATIONS. ADVISOR: ASST. PROF.
SUCHITRA SUEEPRASAN, Ph.D. 94 pp.

This study aimed to investigate colour preference of coffee in print media and relationships between colour of coffee and expectations of tastes of coffee including quality. The visual assessments were conducted under two lighting conditions: daylight simulators and tungsten. This was done to investigate the differences in expectations between two lighting conditions. In the experiments, 40 image samples with different colours of coffee were assessed by two observers groups: 10 experts and 30 unexperts. All observers assessed all 40 images using a 1-9 scale, where 1 means the least and 9 means the most, for expectations of preference, quality, intention of purchase, flavour strength and tastes. It was found that the results from two lighting conditions and two observers groups were significantly different. The expert group preferred coffee images having high lightness and chroma, and associated them with quality of coffee. In addition, yellow was associated with sweetness. Both observer groups expected bitter taste from coffee images with low lightness.

Department : Imaging and Printing Technology

Student's Signature

Field of Study : Imaging Technology

Advisor's Signature

Academic Year : 2011

ACKNOWLEDGEMENTS

I would like to express my sincere gratitude to my advisor, Assistant Professor Dr. Suchitra Sueeprasan who provided me the opportunity to do research under her supervision and for her invaluable advices. I would like to thank Associate Professor Aran Hansuebsai, Associate Professor Chawan Koopipat, and Professor Dr. Tessuya Sato for their invaluable comments as committee members.

Many thanks also to all observers that dedicated their valuable time for participating to complete my experimentations.

Finally, I would like to affectionately give all gratitude to my family for their encouragement, assistance and patient support in everything throughout my entire study.

CONTENTS

	PAGE
ABSTRACT (THAI).....	iv
ABSTRACT (ENGLISH).....	v
ACKNOWLEDGEMENTS.....	vi
CONTENTS.....	vii
LIST OF TABLES.....	ix
LIST OF FIGURES.....	x
CHAPTER I INTRODUCTION.....	1
1.1 Objectives.....	2
1.2 Scope	3
1.3 Expected Outcomes	3
1.4 Contents	3
CHAPTER II THEORETICAL CONSIDERATIONS AND LITERATURE REVIEWS.....	4
2.1 Theoretical Considerations	4
2.1.1 Colour Appearance of Food	4
2.1.2 Espresso Coffee	5
2.1.3 Colour Visual System	7
2.1.4 Colour Space	16
2.1.5 Digital Image	22
2.1.6 Characterization of Printer	24
2.1.7 Transformation sRGB to LAB and Reverse	26
2.2 Literature Reviews	30
CHAPTER III METHODOLOGY	34
3.1 Materials	34
3.2 Apparatus	34

	PAGE
3.3 Observers	37
3.4 Procedure	37
3.4.1 Experimental preparation	38
3.4.2 Visual experiments	46
3.4.3 Data analysis	48
CHAPTER IV RESULTS AND DISCUSSIONS	51
4.1 Colorimetric Values	51
4.1.1 Colour values of image samples	51
4.1.2 Spectral data of image samples	53
4.2 Results from visual assessments	56
4.2.1 Comparisons between two groups of visual results.....	56
4.2.2 Relationships between two variables.....	60
4.2.3 Factor Analysis	66
CHAPTER V CONCLUSIONS.....	80
5.1 Conclusions	80
5.2 Suggestions	83
REFERENCES	84
APPENDICES.....	88
APPENDIX A THE COLOURS VALUES OF IMAGE SAMPLES.....	89
APPENDIX B THE FACTOR SCORES OF 40 IMAGE SAMPLES.....	91
VITA.....	94

LIST OF TABLES

TABLE		PAGE
4-1	xyY values of 40 colour samples and paper white under D65 and A simulator	52
4-2	Paired t-test between two observer groups for D65 condition.....	57
4-3	Paired t-test between two observer groups for A condition.....	58
4-4	Paired t-test between two lighting conditions for the experts.....	59
4-5	Paired t-test between two lighting conditions for the unexperts.....	59
4-6	Relationships between chroma and lightness, and eight expectations under D65 and A from two observer groups.....	60
4-7	Relationships between a^* , and b^* , and eight expectations under D65 and A from two observers groups.....	61
4-8	Eigenvalues, % variance and cumulative % of variance of each component for expert group.....	66
4-9	Factor loadings after rotation of components matrix for expert group...	67
4-10	Eigenvalues, % variance and cumulative % of variance of each component for unexpert group.....	69
4-11	Factor loadings after rotation of components matrix for unexpert.....	69
4-12	Top five best and worst image samples for expert group.....	74
4-13	Top five best and worst image samples for unexpert group.....	77
A-1	The colour values of images samples.....	90
B-1	Factor scores of 40 images samples in two conditions (D65 and A) of expert group with the number of images rearranged.....	92
B-2	Factor scores of 40 images samples in two conditions (D65 and A) of unexpert group with the number of images rearranged.....	93

LIST OF FIGURES

FIGURE		PAGE
2-1	The colour in each layers of espresso coffee.....	6
2-2	Factor of colour visual system.....	7
2-3	Surface of a reflective objects.....	8
2-4	The figure of human eye.....	9
2-5	The relative spectral sensitivity of L, M, and S cones.....	11
2-6	The visible spectrum.....	12
2-7	the relative spectral power distribution of daylight.....	12
2-8	The spectral power distribution of this illuminant and standard A, B and C.....	15
2-9	spectral power distribution of CIE illuminant F2, F7, F8, F11.....	15
2-10	The x, y chromaticity diagram.....	17
2-11	Dominant wavelength and complementary dominant wavelength and purity.....	19
2-12	CIELAB diagram.....	20
2-13	Three component of RGB image.....	23
2-14	Subtractive and additive colour mixing.....	25
3-1	Overview of process of experiment.....	38
3-2	Three parts in experimental preparation.....	39
3-3	Layout of photo-shooting.....	40
3-4	Original picture.....	41
3-5	The original images (a) Background image (b) Image after combineing with background.....	41
3-6	Flowchart of colour adjustment process.....	42
3-7	Printer calibration.....	43
3-8	Printing process of image samples.....	44
3-9	The distribution of fifty colours in print media and image samples in(a) a^* , b^* plane and (b) L^* , C^* plane.....	45

FIGURE	PAGE
3-10	Colour measurements in experimental room..... 47
3-11	Experimented set-up..... 48
4-1	Chromaticity co-ordinates of 40 colour samples and paper under two light sources..... 51
4-2	Spectral curves of all samples under D65 simulators..... 53
4-3	Spectral curves of all samples under A simulators..... 54
4-4	Spectral curves of white paper under (a) D65 and (b) A simulators.. 55
4-5	Correlations between expectation scale for (a) unexpert group of observers (b) expert group of observers under D65 simulators..... 63
4-6	Correlations between expectation scales for (a) unexpert group of observers (b) expert group of observers under A simulators..... 64
4-7	Correlations between bitterness and astringency for (a) unexperts under D65 (b) unexperts under A (c) experts under D65..... 65
4-8	Summary of underlying factor for the expert group..... 68
4-9	Summary of underlying factor for the unexpert group..... 70
4-10	Scatter plots between factor scores of each component and colour values, for expert group under D65 . (a) PC1 with chroma and lightness (b) PC2 with chroma and lightness (c) PC1 with b^* and (d) PC2 with b^* 71
4-11	Scatter plots between factor scores of PC1 and colour values for expert group under A. (a) PC1 with chroma and lightness (b) PC1 with b^* 72
4-12	Scatter plots between factor scores of PC2 and chroma, lightness, b^* plan of unexpert group under D65 simulator. (a) PC2 with chroma and lightness (b) PC2 with b^* plan..... 75
4-13	Scatter plots between factor scores of PC2 and chroma, lightness and a^* , b^* plan of unexpert group under A illuminant. (a) PC2 with chroma and lightness (b) PC2 with b^* plan..... 76

CHAPTER I

INTRODUCTION

Colour is an important part of our everyday lives. Everyday we make choices about colours: what colour to paint the bedroom, red rose or pink for new t-shirt. We judge how healthy we, our crops and our food are, with the help of colour. Colours often have different meanings in various mood. For example, red is the most emotionally intense colour, red stimulates a faster heartbeat and breathing, blue can also be cold and depressing and green symbolizes nature. Green is the easiest colour on the eye and can improve vision. It is a calming, refreshing color. In psychology, the colour of food correlates with the taste and expectation of human. Colour is involved in almost every aspect of our lives.

Colour is the first impression which can make consumers interested in products, especially, in food and beverage products. The colour appearance signifies quality and character of the food. Food or beverage can be appetizing due to its colour appearance. In other words, colour of food have relationships with flavour. Yellowish colour was influenced with sweetness and lower lightness correlated with bitterness.[1]

The colour appearance of food depends on the illuminating light. Different light sources results in different colours of food, such as tungsten light provides yellowish to the food or fluorescent illumination enhances the red colour of meat and is used in butcher's shop.[2] So, the lighting conditions under which the food is viewed also correlate with consumers' preference. From the research on the effect of different lightings on food, the results indicated that red meat and oven products were preferable under metal halide lamp with warm dichroic filter, metal halide lamp with neutral filter was suitable for fish and green-yellow vegetables and fruits, orange-red vegetables and fruits were preferable under white sodium lamp with neutral filter.[3]

The colour of food is the first contact point for consumers. The consumers judge the food from its colour appearance and then from other sensory attributes such as aroma or taste. Moreover, light sources have impacts on colour appearance of food.

Espresso coffee is widely known throughout the world. Espresso is the main type of coffee consumed almost in all parts of Europe and also popular in many other countries like Brazil, Cuba, Argentina, and many parts of the American and the Australian continents. An espresso is the base for other drinks, such as a latte, cappuccino, macchiato, mocha, or americano. Espresso coffee is the drink that uses the colour to judge its quality. The crema in the top layer of espresso should be hazel colour for the best espresso.

This study investigated associations between the colour of coffee in print media and consumer expectations. The image samples with various colours of espresso were evaluated by 40 Thai observers, including 10 experts who research and develop coffee and 30 unexperts who were general coffee drinkers. The observers rated in a 1-9 scale of expectations: preference, intention of purchase, quality, flavour strength and tastes: sweetness, bitterness, sourness and astringency. Data analysis was carried out to find relationships between colour and expectations of observers.

1.1 Objectives

1. To investigate relationships between colour of espresso coffee in print media and consumer expectations.

2. To investigate colour of coffee in print media in connection with observers' preference under daylight and tungsten.

1.2 Scope

Forty espresso image samples were evaluated by thirty general coffee drinker and ten coffee experts. All colours of espresso coffee in the image samples were selected based on CIELAB colour space, which comprehensively covered the colours of espresso in print media in the market. Only the colours of espresso coffee were varied for different image samples, the other parts were kept constants. The images samples were printed using an 8-colour-system inkjet printer. The printed samples were viewed under two lighting conditions: D65 and A. The observers evaluated colours of coffee image with respect to expectations including preference, intention of purchase, quality, flavour strength and tastes.

1.3 Expected Outcomes

1. The relationships between colour of coffee in print media and consumer expectations.
2. The differences between the results obtain from D65 and A lighting conditions.

1.4 Contents

Chapter 2 contains theoretical considerations and literature reviews which associate with this research. Chapter 3 gives the descriptions of materials, apparatus and methodology employed in the present study. Analysis of the results is also described in this chapter. Chapter 4 gives an account of results from colour measurement and visual assessments. Finally, Chapter 5 provides conclusions and suggestions for future work.

CHAPTER II

THEORETICAL CONSIDERATIONS AND LITERATURE REVIEWS

2.1 Theoretical Considerations

This study investigate the association between colour of coffee in print media and expectations of consumers. The coffee image samples were printed by inkjet printer and visual assessment by observers in preference, intention of coffee, quality flavour strength and taste included sweetness, bitterness, sourness and astringency under conditions D65 simulator and A. In this chapter the theoretical considerations and literature review are described as follows.

2.1.1 Colour appearance of food

Colour is importance in the human sense. In psychophysical the colours have relationship between color and flavor. The appearance are normally region based through local produce and economic also. As coloured of food, such as green or violet meat or immature green fruit, is rejected. [3] Characteristics of food has many various appearance such as texture, colour. one of those, colour is related to the flavor. [4] The colour of the food surface is indicated quality parameter evaluated by consumers and is critical in the accept or reject of the product. [5]

A sensory includes an assessment of visually perceived sensory properties for example, the yellow dessert will taste lemon. It is a response to the food to colour appearance. An emotional can have positive or negative connotations and include the reasons for the food. Product appearance is involved in all sensory testing through two enormous effected first, the intrinsic importance of appearance in the total mix of product properties, and second, the ability of appearance to influence judgments of texture and

particularly flavor. Moreover, colour appearance is the most significant factor in determining the choice of confection at the point of sale. [3] Whereas colour stimulus can make up the purchase of consumers. [6]

So, The colour of a food is the first contact point of the consumer with it. Thus, the consumer judge it from its colour appearance and then from other sensory attributes such as aroma or taste.

2.1.2 Espresso coffee

Espresso coffee is a concentrated beverage brewed by forcing a small amount of boiling water under pressure through finely ground coffee. [7] The espresso is derived from the Italian word for express since espresso is made for and served immediately to the customer.[8]

Espresso is widely known throughout the world. Espresso accounts for the main type of coffee consumed almost in all parts of Europe, especially the south, comprising Italy, France, Portugal and Spain. Moreover, espresso coffee is also popular in many other countries like Brazil, Cuba, Argentina, and many parts of the American and the Australian continent. An espresso is the base for other drinks, such as a latte, cappuccino, macchiato, mocha, or americano. [9]

The shot of espresso comprise of 3 parts. First heart, the body, and the crema. The crema is the floats on the surface of coffee (Figure 2-1 show the colour of each layers of espresso coffee)



Figure 2- 1 The colour in each layers of espresso coffee. [10]

The crema should be colour appearance hazel colored crema and smooth include thick. The best espresso should be extraordinarily sweet, have a potent aroma, and flavor similar to freshly ground coffee. So an espresso should be without additives as milk.[7]

For the best espresso coffee is many factor, coffee beans are blended to achieve the sweetness, aromatics, and smoothness desired in espresso. And the espresso blend must also be fresh. Coffee blending is necessary for espresso. It is important that the advantage of espresso over other brewing methods is a result of the formation of the crema. The crema in the espresso without strong. The crema is an emulsified layer of tiny, smooth bubbles that trap aromatic compounds. This layer coats the tongue and these small bubbles break over time allowing espresso. Therefore, it is essential to prepared espresso blend. Roasting is a chemical process by which aromatics, acids, and other flavor components are either created, balanced, or altered in a way that should augment the flavor, acidity, aftertaste and body of the coffee as desired by the roaster. An espresso roasted very dark. This results in a bitter. So the importance factor that make the perfect espresso, the water temperature should be stable and somewhere between 92-96°C. The last in factor of perfect espresso is the best espresso machine is very important to both water temperature and temperature stability.

From those factor can affects to the colour appearance of espresso. In the brewing, under extracted coffee is sour and very clear crema, presence of bubbles and little persistence. And over extracted coffee is weak, with bitter, strong flavor and acrid. The colour is dark brown crema. For the perfect the crema with reddish brown. So the color that corresponds to this so you can stop the extraction means getting the best espresso for a given pull every time.[11]

2.1.3 Colour visual system

The colour visual to describe both physical actions such as a producing a stimulus in the form of light and subjective results such as receiving and interpreting this stimulus in the eye and the brain.[12] Figure 2-2 show the factor of colour visual system.

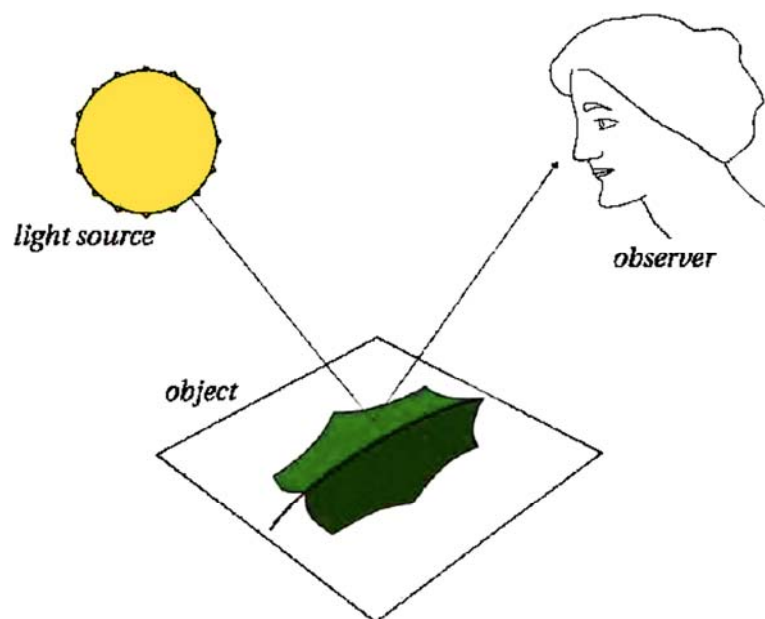

Figure 2-2 Factor of colour visual system. [13]

From Figure 2-2, the factor of colour visual system comprise of object, observer and light source. The three factor have importance of the colour visual represent three of science, physics, chemistry and biology which is the colour is complex phenomenon. an explore this factor of the colour visual as follow.[13]

2.1.3.1 An object

The objects is the first and most persistent view of colour. An object's surface must interacts with light to affect the light colour. Light strikes the objects, travel some way into the atoms at the surface, then re-emerges. During the light's interaction with these surface atoms of the objects absorbs some wavelength and reflects other (Figure 2-3). The spectrum make of the reflect light is not the same as that of the incoming light. The degree to which an objects reflects some wavelengths and absorbs other can called spectral reflectance. When light source is changed, the reflectance of the objects does not change even though the spectral energy that emerges different. The reflectance is an invariant property of the objects. [13]

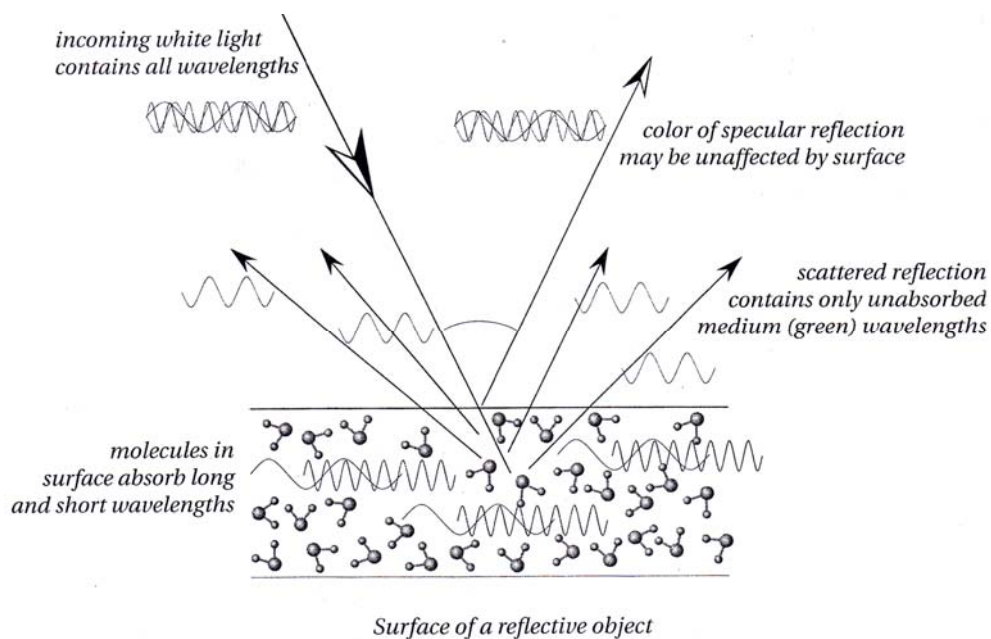

Figure 2-3 Surface of a reflective objects. [13]

In transmissive object, the wavelength is same as the reflective objects except that the this object must be least partially translucent so that the light can pass all the way through it. The wavelength make of the light by absorbing some wavelength and allowing others to pass through. The surface of reflective objects or the substance in a transmissive objects can affect the wavelength therefore the an object is the factor in the colour visual system. [13]

2.1.3.2 An observer

The light entering eyes is imaged onto the back of the eyeball, the retina, where light receptors absorb a portion of the light and generate a signal eventually interpreted by the brain. The capture of the eye is similar to the camera capture.[12] The colour reproduction of the eye is the three-channel of the human retina in the other words type of sensor in eye corresponding roughly reds, greens and blues. That is produce colour similar to three pigment on paper or phosphors in the monitor.[13] These is optical element influence the spectral and spatial properties of the light receptors. There two types of receptor, rod and cones name according to their shape. Figure 2- 4 show the comprise of human eyes and character of rods and cones cell.

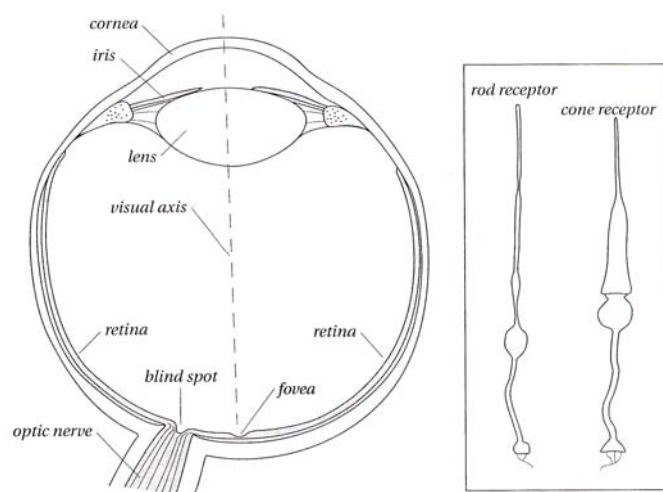

Figure 2-4 The figure of human eye. [13]

As Figure 2-4 , The cross section of right eye, most colour vision happen in the fovea where the three type of cones far outnumber the rods. The retina is a complex layer of nerve cells lining the back of eye. The nerve cells in the retina that respond to light and so called photoreceptors or receptor and receptor comes in two type rods and cones. [13]

2.1.3.2.1 Rods cell

Rods cell detect amount of light which only see object as shade of gray. As the amount of light increase so the rods become desensitized and cease sending signals to the brain. The rods cell inactive during the day or light appear.[12]

2.1.3.2.2 Cones cell

Cones cell are the second type of receptors. It have much lower sensitivity to incident light. When the amount of light increase, the cones start sending neural signals. The cones are colour receptors. Human sensations of colour are three type of cones responding differently to light various wavelength. Stimuli that cause different colour have different cone signals.[14] In the Figure 2-5 the relative spectral sensitivity of L, M, and S cones. These spectral sensitivities are based on measurement in front of eye rather than of isolated photoreceptors. The letter S, M, L are represent the three cones with their peak sensitivities in short, middle ,long wavelength Their spectral sensitivities overlap quite a bit of the L and M cones. If the receptor did not overlap, colour visual would only perceive three hues in the spectrum because of the uneven sampling of the wavelength. The spectral difference are only rarely used to predict visual differences. [12]

In human eye far more rods than cones about 120 million rods to about 6 million cones except in indentation in fovea where cones outnumber rods about 150,000 cones with a small number of rods [13]

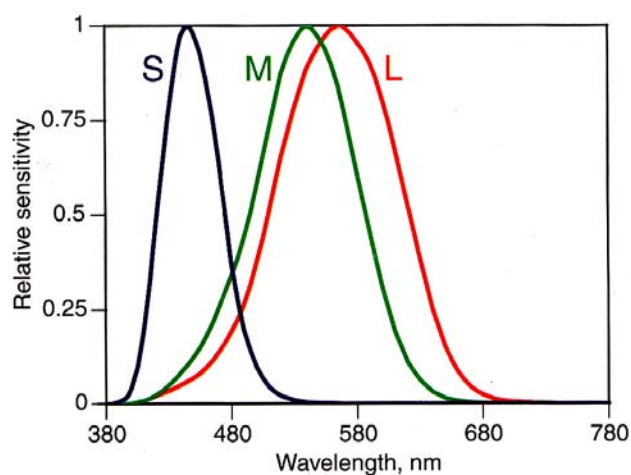

Figure 2-5 The relative spectral sensitivity of L, M, and S cones. [15]

2.1.3.3 The light source

Light source is emits large quantities of photons in the visible spectrum or visible radiation is a form of energy and light can be described by its wavelength for which the nanometer (nm) is a convenient unit of length. The relative insensitivity of the eye limits the visible part of the spectrum to a very narrow band of wavelength between 380 and 780 n m. Figure 2-6 show The hue as blue lies below about 480n m, green between 480 and 560, yellow between 560 and 590, orange between 590 and 630 and red at wavelength longer than 630 n m. The purple which produced by mixing red and blue light from the extremes of the spectrum which not found in the spectrum.[12]

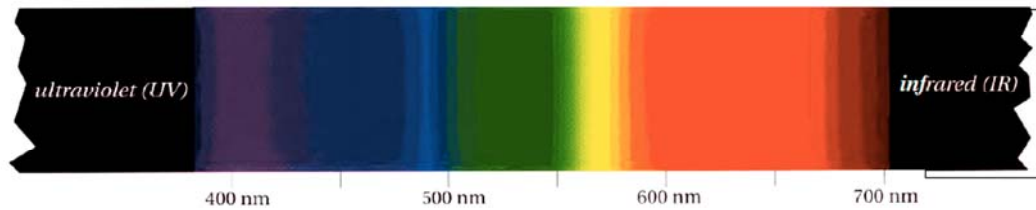

Figure 2-6 The visible spectrum. [13]

The light from source can be described in terms of the relative power or amount of light emitted at each wavelength. Plotting this power as a function of the wavelength gives the spectral power distribution curve of the light source that the curve has unit of relative power. Spectral distributions are normalized at 560 nm is defined as unity. The spectral power of a source is defined relative to its power at 560 nm. Standard source and illuminants usually their normalized at 560 nm. [12] Figure 2-7, show example of the relative spectral power distribution plot with wavelength for typical daylight.

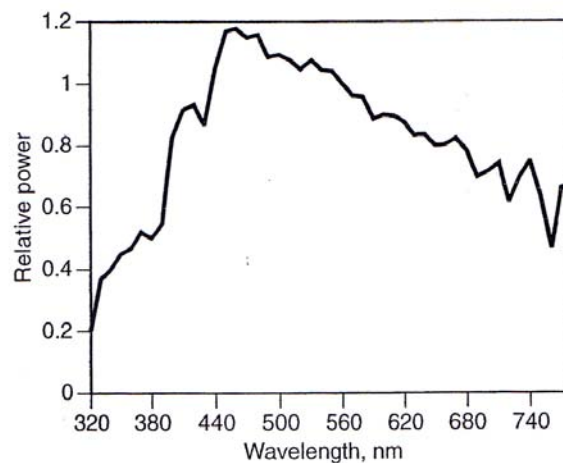

Figure 2- 7 the relative spectral power distribution of daylight. [12]

The colour of light source depend only on their temperature of blackbodies is so called colour temperature. Colour temperature usually expressed in kelvins (K) of blackbody radiator.[12] Other than colour rendering is effect of an illuminant on the colour

appearance of objects by conscious or subconscious comparison with their appearance under a reference illuminant [16]

A number of spectral power distributions have been defined by the CIE (International Commission on Illumination) for use in the describing colour which based on physical standard such blackbody radiator.

2.1.3.3.1 CIE Standard illuminant

Light is responsible for colour. It is the fact that the perception of colour varies under light source. It has been observed that the difference between an incandescent light source and that of a CFL or LED light source had not to do with the colour rendering index but also with the perceived brilliance and reflectance that the same hue can give under these different lighting conditions. [17]

the colour perceptions is depend on the viewing conditions and on adaptation and other characteristic of the observers. Therefore light source importance in colorimetry, without light their can not perceptual of colour. And the colour are associate with light source that nature of light sources can have profound effect on the appearance of coloured objects. It is well known that red and yellow objects seen under tungsten filament light look lighter and more colourful look in daylight while blue objects look darker and less colourful. The light sources provide a great variety of spectral power distribution which affect to colour appearance of light source is changed. So the CIE had introduced some standardization of the light which defined in term of spectral power distribution and sources which are defined as physically realizable producer of radiant power. [15]

2.1.3.3.1.1 Standard illuminant A

The most artificial light source is the tungsten lamp. In spite of the availability of fluorescent lamps and other discharge type of lamp. The tungsten lamp is also a very convenient standard illuminant because the spectral power distribution of its light is almost entirely dependent on just one variable. Standard illuminant A have the spectral power distribution at a temperature about 2856 K. [15]

2.1.3.3.1.2 Standard illuminant B and C

Standard illuminant B and C are daylight simulators which they are derived from Illuminant A by using a liquid filters. Standard illuminant B as a representative of noon sunlight, with a CCT (correlated color temperature) of 4874 K, while Standard illuminant C represented average day light with a CCT of 6774 K. [18]

2.1.3.3.1.3 Standard illuminant D

Standard illuminant D represent average daylight throughout the visible spectrum and into the ultraviolet region as far as 300 nm. Illuminant D65 has a correlated colour temperature of about 6504 K. The series of standard illuminant D comprise of example D50, D55, D65, D75 which represent daylight of different colour temperature. For D50 having correlated colour temperature of about 5000 K.[15]

The D series illuminant used in industries such as paints, plastic, and textile have adopted D65. The graphic arts and computer industries use D50.[12] The spectral power distribution of this illuminant and standard A, B and C also in the Figure 2- 8

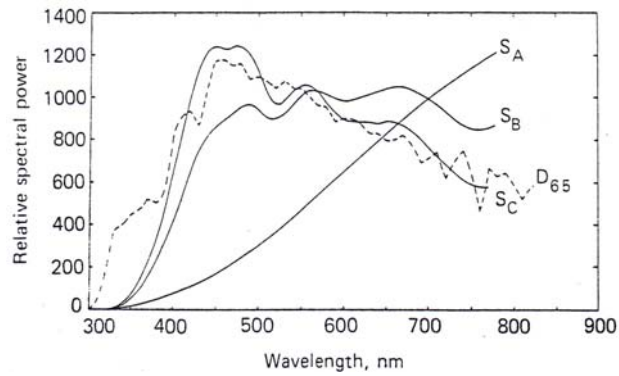

Figure 2-8 The spectral power distribution of this illuminant and standard A, B and C. [12]

2.1.3.3.1.4 Standard illuminant F

The F series of illuminants defined various types of fluorescent lamps including standard cool white, warm white. The total of 12 series in Standard illuminant F which full spectrum and tri-band. The spectral power distributions of The most common Standard illuminant F are show in the Figure 2-9

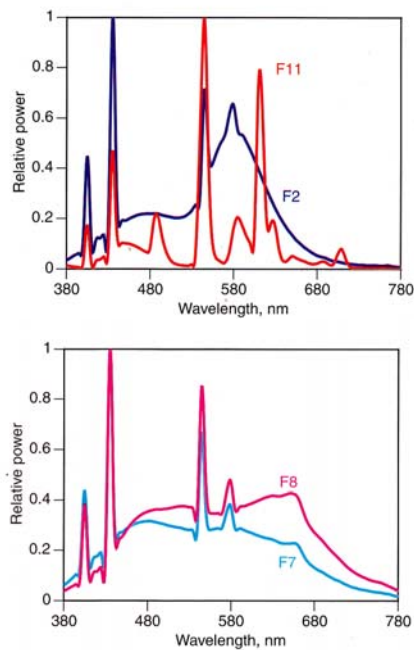

Figure 2-9 The spectral power distribution of CIE illuminant F2, F7, F8, F11. [12]

From Figure 2-9, the F series illuminants are many class fluorescent lamps have change in spectral property. F2 illuminant is the traditional cool white fluorescent, F7 and F8 illuminant are daylight fluorescent that F7 and F8 often are used to simulate D65 and D50 respectively. The narrow band fluorescent to establish illuminant F11. [12] Furthermore, the series of F illuminant comprise of The standard F1 to F6 are standard fluorescent lamps consist of two semi-broadband emissions of antimony and manganese activations in calcium halophosphate phosphor. F4 illuminant is of particular interest since it was used for calibrating the CIE Color Rendering Index. The standard F7 to F9 are broadband that full-spectrum light fluorescent lamps with multiple phosphors, and higher CRIs. For the standard F10 to F12 are narrow tri-band illuminants consisting of three narrowband emissions.[18]

2.1.4 colour space

Colour space is mathematical model describe the colour components that represent visual colour The colour plan using three or two co-ordinates or another parameter. The colour visual depends on the colour space that used. So colour space has various. Some colour space is better for some applications [19]

2.1.4.1 CIE x y chromaticity diagram

The CIE system allows the measurement of colour according to characteristics of human vision. The x, y chromaticity is two - dimensional map of colour and so called the chromaticity diagram which their step and spacing are not uniform. The chromaticity coordinate x,y, and z, are obtained by ratios of the tristimulus values to their sum $X+Y+Z$ that the sum of chromaticity coordinates is 1. The x, y chromaticity can be calculated from tristimulus value by equation 2.1 to 2.4 [12]

$$x = X/(X+Y+Z) \quad (2.1)$$

$$y = Y/(X+Y+Z) \quad (2.2)$$

$$z = Z/(X+Y+Z) \quad (2.3)$$

$$X = x/y(Y), Z = z/y(Y) \quad (2.4)$$

The chromaticity assign only two of the three coordinate to describe the colour and one of the tristimulus value which Y. Y tristimulus value is relate to percentage of luminance factor and this is an approximate correlate of the perceptual attribute of lightness. The range of Y value from 100 for white to zero for dark [15]

The colour can be plotted in chromaticity diagram usually plot of chromaticity coordinate x and y, two dimensional. The characteristic of xy chromaticity colour space familiar horseshoe shape and specify the spectral locus that the line connecting to the points. In the horse shape represent the chromaticities of the spectrum colour. [12] The x y chromaticity diagram as follow.

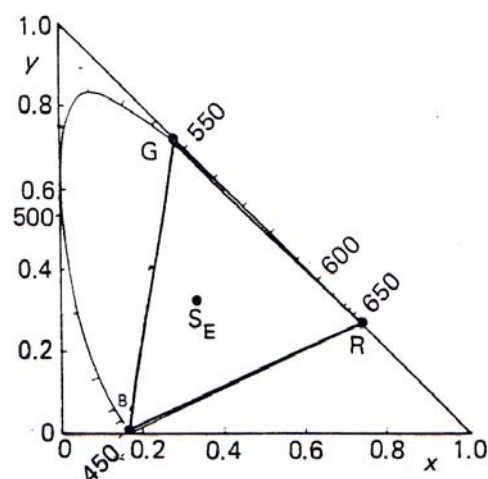

Figure 2-10 The x, y chromaticity diagram. [15]

From Figure 2-10, this diagram refer to x,y chromaticity diagram that provides a sort of colour map on which the chromaticity of all colours can be plotted. The S_E position is the equi-energy stimulus. The out of the curve boundary is the monochromatic. The curve line shows where the colour of the spectrum lie and the wavelength are along the curve. If the two ends of the spectrum are joined by a straight line, that line represent mixture of light from the two ends of the spectrum, as these colour are mixture of red and blue. This line is known as purple boundary. The area enclosed the spectral locus and the purple boundary enclosed the domain of all colour. This is because the spectral locus consists of a continuously convex boundary so that all mixtures stimuli, R having wavelength of 700 nm, G having 546.1 nm and B having 435.8 nm. The line joining the point R and G represents all the colour formed by the additive mixture of various amounts of the R and G stimuli. So the area inside the triangle formed by three stimuli.

The chromaticity diagrams are map of relationship between colour stimuli, not between colour perceptions. Although diagram consider the approximate nature of the colour perceptions that are similar to represented by various chromaticity but the exact colour perceptions will depend on the viewing conditions and on adaptation and other characteristic of the observers.[15]

An alternate set of coordinates in the x, y chromaticity called dominant wavelength and excitation purity which correlate with the hue and chroma. The dominant wavelength is the wavelength of the spectrum colour whose chromaticity is on the same straight line as the sample point and the illuminant point. And excitation purity is the distance from illuminant point to sample point, seperated by that from illuminant point to spectrum locus. The complementary dominant wavelength is the same point lies between the illuminant point and the purple boundary connecting the ends of the spectrum locus. The definitions of position of dominant wavelength and complementary dominant wavelength and purity show in Figure 2-11 as follow.[12]

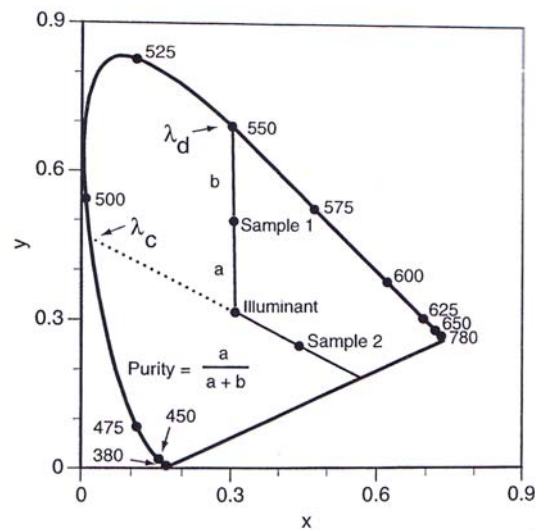

Figure 2-11 Dominant wavelength and complementary dominant wavelength and purity.

[12]

2.1.4.2 CIELAB colour space

The Lab colour space is a colour space with 3 dimension which comprise of L^* , a^* and b^* plan. L^* represent lightness and a^* and b^* are colour opponent whereas a^* represent redness - yellowness colour and b^* represent greenness - bluish colour. Lab colour space based on nonlinearly compressed CIEXYZ colour space coordinates. The lightness correlate in CIELAB is calculated using the cube root of the relative luminance.

[20]

The co-ordinate of L^* , a^* , b^* in CIELAB to define the location of any colour in the uniform colour space. CIELAB is based on the perception.[21]

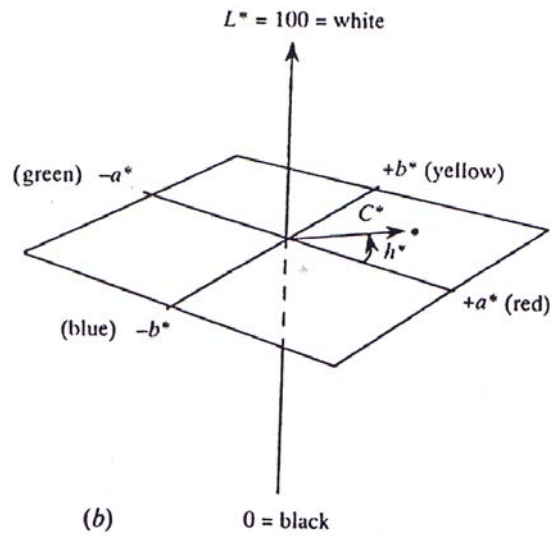

Figure 2-12 CIELAB diagram. [3]

Figure 2-12 shown CIELAB colour uniform diagram show three dimensional relationship of a^* plan which $+a^*$ represent redness and $-a^*$ represent greenness and b^* plan which $+b^*$ bluish and $-b^*$ to yellowness. And opponent coordinate to lightness or L^* .

The CIELAB formulae are equation 2.5 to 2.10 [22]

$$L^* = 116(Y/Y_n)^{1/3} - 16$$

$$a^* = 500[(X/X_n)^{1/3} - (Y/Y_n)^{1/3}] \quad (2.5)$$

$$b^* = 200[(X/X_n)^{1/3} - (Z/Z_n)^{1/3}]$$

With the constraint that for $X/X_n, Y/Y_n, Z/Z_n > 0.008856$. If in calculate less than 0.008856 may be included if the equation are replace by Equations 2.8 to 2.10

$$L^* = 903.3 (Y/Y_n) \quad \text{for } Y/Y_n \geq 0.008856$$

$$a^* = 500[f(X/X_n) - f(Y/Y_n)] \quad (2.6)$$

$$b^* = 200[f(X/X_n) - f(Z/Z_n)]$$

where

$$\begin{aligned} Y &= Y_n f(Y/Y_n)^3 && \text{If } f(Y/Y_n) > (0.008856)^{1/3} \\ Y &= Y_n f(Y/Y_n) - (16/116)/7.787 && \text{If } f(Y/Y_n) \leq (0.008856)^{1/3} \\ X &= X_n f(X/X_n)^3 && \text{If } f(X/X_n) > (0.008856)^{1/3} \\ X &= X_n f(X/X_n) - (16/116)/7.787 && \text{If } f(X/X_n) \leq (0.008856)^{1/3} \\ Z &= Z_n f(Z/Z_n)^3 && \text{If } f(Z/Z_n) > (0.008856)^{1/3} \\ Z &= Z_n f(Z/Z_n) - (16/116)/7.787 && \text{If } f(Z/Z_n) \leq (0.008856)^{1/3} \end{aligned}$$

where

$$f(Y/Y_n) = (L^*+16)/116$$

$$f(X/X_n) = a^*/500 + f(Y/Y_n)$$

$$f(Z/Z_n) = f(Y/Y_n) - b^*/200$$

Where X_n, Y_n, Z_n refer to the nominally white object colour tristimulus values. And L^* scale 0 to 100. To compute the polar coordinates chroma and hue angle can be calculate by equation 2.7 and 2.8

$$C_{ab}^* = (a^*+b^*)^{1/2} \quad (2.7)$$

$$\begin{aligned} h_{ab} &= \tan^{-1}(b^*/a^*)(180/\pi) \\ &= \arctan (b^*/a^*) \end{aligned} \quad (2.8)$$

Where the term $180/\pi$ is necessary to convert the output of the inverse tan function from radians to degrees. The polar coordinates are useful since the difference in the chroma term C^*_{ab} can correlate with the difference in perceived colourfulness and the difference in the term of hue can be correlated with differences in perceived hue.

When colours are defined by L^* , C^*_{ab} and h_{ab} can transform back to a^* and b^*

$$a^* = C^*_{ab} \cos(h_{ab} \pi/180) \quad (2.9)$$

$$b^* = C^*_{ab} \sin(h_{ab} \pi/180) \quad (2.10)$$

2.1.5 Digital image

In monochrome images defined as a two-dimensional function, $f(x,y)$, where x and y are spatial coordinates and the amplitude of f at any pair of coordinates (x,y) is called the intensity of the images at the point. The term gray level is used often to refer to the intensity of monochrome images. The colour images are formed by a combination of individual 2-D images or individual colour component.

An RGB colour image is an $M \times N \times 3$ array of colour pixel, where each colour pixel is a triplet corresponding to the red, green, and blue components of an RGB images at a specific spatial location. The Figure 2-13 show pixel of an RGB colour image are formed from the corresponding pixel of the three component images

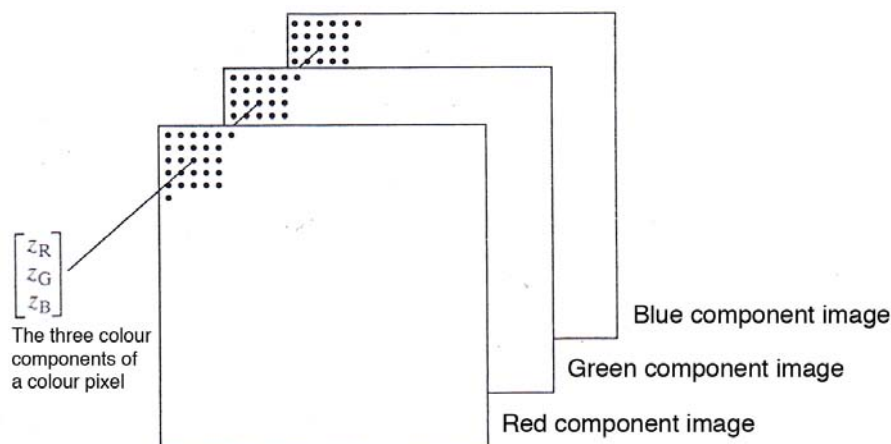

Figure 2-13 Three component of RGB image. [23]

An RGB image may be viewed as a stack of three gray scale images that, when fed into the red, green and blue inputs of the colour monitor, produce a colour image on the screen. By convention, the three images forming an RGB colour image are referred to as the red, green and blue component images. The data class of the component images determines their range of values. The range of values is $[0, 255]$ for RGB images of class 8 bits or $[0, 65535]$ for RGB images of class 16 bits. The number of bits used to represent the pixel values of the component images determine the bit depth of an RGB image. Generally, the number of bits in all component images is the same. The number of possible colours in an RGB image is $(2^b)^3$ where b is the number of bits in each component image. For 8 bits case, the number is 16,777,216 colours.[23]

The RGB color is the most to encode color in computing, and several different binary digital representations are in use. The main characteristic of all of them is the quantization of the possible values per component by using only integer numbers within some range, usually from 0 to some power of two minus one ($2^n - 1$) to fit them into some bit groupings. Encodings of 1, 2, 4, 5, 8, and 16 bits per color are commonly found; the total number of bits used for an RGB color is typically called the color depth.[23]

Color interleaving is a term used to describe which of the dimensions of an RGB image contain the three color channel values. An RGB image is contained within an image object where the interleave property dictates the arrangement of the channels within the image file. In the first dimension pixel interleaving (3, w, h), the second dimension is line interleaving (w, 3, h) and planar interleaving (w, h, 3) is the color information is contained in the third dimension [25]

For many applications, RGB colour information is transformed into mathematical space that decouples the brightness information from the colour information. This transformation referred to as colour model, colour transforms or mapping into another colour space [24]

2.1.6 Characterization of printer

Colour management used to describe in the procedures for same colour reproduction is achieved when the same image is reproduced across of media. Example in printing, encodes images by defining the amount of ink needed to reproduce an images. [27]

Most printers use three of four primaries colour as cyan, magenta, yellow, black. That the primaries of a subtractive colour mixing process which different from an additive colour mixing process as red, green, blue. For both additive and subtractive devices the primaries are selected to enabled the greatest gamut of colours to be reproduce. In a subtractive process, the intensities of the red, green and blue light in the print are indirectly controlled by the amount of the cyan, magenta, yellow ink deposited.[22] Figure 2-14 show The subtractive and additive colour mixing

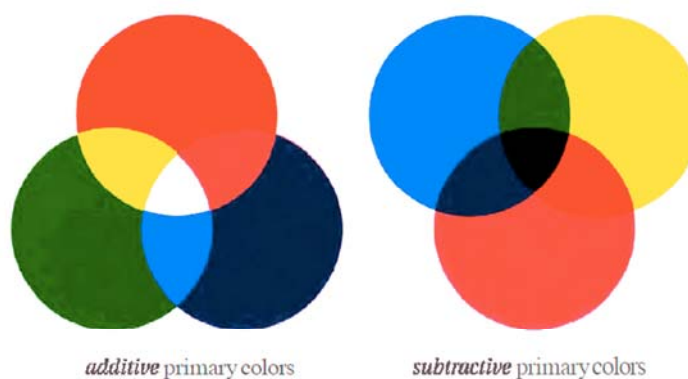

Figure 2-14 Subtractive and additive colour mixing. [13]

The aim of characterization of printer is device coordinates (cyan, magenta, yellow and black) are converted into device independent CIE XYZ values.[22]

Color calibration of a printer is typically a two-step process. In the first step, the printer response is characterized by 7 printing a number of color patches with known device control values, measuring the colors obtained, and generating a characterization function that maps device control values, such as CMYK, to corresponding colors specified in a device independent color space, such as CIELAB. In the second step, the characterization function is inverted to determine the device control values required to produce a color specified in device independent color space. The final color correction that inverts the characterization function is often implemented as a 3D look-up table that maps from a device independent color space (e.g. CIELAB) to the device control values (e.g. CMYK).[28]

2.1.6.1 The methods of mapping

Linear transforms are fundamental to about of the colorimetry and many applications, especially in the characterization of images devices such as printer. Device

calibration is concerned with the setting the imaging device to a known state and ensure that the device this producing consistent results. From the characterization is the relationship between device coordinates such as RGB or CMYK and some device independent colour space such as XYZ and LAB. Therefore, the method of mapping colour space have three methods physical model, look-up table, numerical method. The first physical model often include term of various properties of the device such as absorbance, scattering and reflectance of colorants. An example, the Kubelka-Munk model is of the physical model that can be used as the basic of characterization model for a printer[29],[30] and the gain offset gamma model (GOG model) is a physical model of the computer or visual display unit based on a cathode-ray-tube (CRT) that can be used for the characterization in display monitor. Physical model tend to play in the characterization of printers than they do with other imaging devices. That the relationship between printer inputs and CIE tristimulus values is usually extremely non-linear.

Second, look-up table define the mapping between a device space and a CIE colour space at the series of discrete measured coordinates within the colour space and may interpolate the values for intermediate co-ordinates. For the last, numerical method a series of coefficients in determined, usually based upon a set of measured samples, without prior assumptions about the physical behaviour of the device or its associate media.[22]

2.1.7 Transformation sRGB to LAB and reverse

The sRGB colour space (standard colour space) is well specified and designed to match typical home and office viewing conditions which sRGB defines the red, green, and blue chromaticities. sRGB is well inside the range of colors visible to a human. sRGB is sometimes avoided by printing professionals because its color gamut is not big enough, especially in the blue-green colors, to include all the colors that can be reproduced in

CMYK printing.[31] the benefit from sRGB colour space are monitors in compliance with the sRGB specification will get faster display times for objects in this color space and scanner and digital camera optimize the color transforms and gamma correction for compatibility with sRGB will benefit for the same reason.

In CMYK or sRGB are the device dependent and the device independent color spaces such as CIELAB or CIEXYZ has created a performance burden on applications that have attempted to avoid device color spaces. This is primarily due to the complexity of the color transforms they need to perform to return the colors to device dependent color spaces.

sRGB spaces are native to displays, digital cameras and scanner which are the devices with the highest performance constraints. sRGB spaces can be made device independent in a straightforward way. They can also describe color gamuts that are large enough for all but a small number of applications.

sRGB in combination with the reference viewing environments can be defined from standard CIE colorimetric values through simple mathematical transformations. For the calculation of CIE colorimetric values, it is necessary to specify a viewing environment and a set of spectral sensitivities for a specific capture device. The definitions for RGB given in the forward transformation in Equations 2.15 to 2.16 are based on the colorspace's respective viewing environment. [32]

$$\begin{bmatrix} R_{sRGB} \\ G_{sRGB} \\ B_{sRGB} \end{bmatrix} = \begin{bmatrix} 3.2410 & -1.5374 & -0.4986 \\ -0.9692 & 1.8760 & 0.0416 \\ 0.0556 & -0.2040 & 1.0570 \end{bmatrix} \begin{bmatrix} X \\ Y \\ Z \end{bmatrix}$$

(2.15)

In the sRGB encoding process that negative sRGB tristimulus values, and sRGB tristimulus values greater than 1.00 are not typically retained. The luminance dynamic range and color gamut of sRGB is limited to the tristimulus values between 0.0 and 1.0.

Next, The sRGB tristimulus values are transformed to nonlinear sR'G'B' values in Equation 2.16 as follows:

If $R_{sRGB}, G_{sRGB}, B_{sRGB} \leq 0.00304$

$$\begin{aligned} R'_{sRGB} &= 12.92 \times R_{sRGB} \\ G'_{sRGB} &= 12.92 \times G_{sRGB} \\ B'_{sRGB} &= 12.92 \times B_{sRGB} \end{aligned} \quad (2.16)$$

else if $R_{sRGB}, G_{sRGB}, B_{sRGB} > 0.00304$

$$\begin{aligned} R'_{sRGB} &= 1.005 \times R_{sRGB}^{(1.0/2.4)} - 0.055 \\ G'_{sRGB} &= 1.005 \times G_{sRGB}^{(1.0/2.4)} - 0.055 \\ B'_{sRGB} &= 1.005 \times B_{sRGB}^{(1.0/2.4)} - 0.055 \end{aligned} \quad (2.17)$$

The nonlinear sR'G'B' values are converted to digital code values. This conversion scales the above sR'G'B' values by using the equation below where WDC represents the white digital count and KDC represents the black digital count.

$$\begin{aligned} R_{8bit} &= ((WDC - KDC) \times R'_{sRGB}) + KDC \\ G_{8bit} &= ((WDC - KDC) \times G'_{sRGB}) + KDC \\ B_{8bit} &= ((WDC - KDC) \times B'_{sRGB}) + KDC \end{aligned} \quad (2.18)$$

This specification proposes using a black digital count of 0 and a white digital count of 255 for 24-bit (8-bits/channel) encoding. This obviously can be simplified as shown below.

$$\begin{aligned}
 R_{8bit} &= 255.0 \times R'_{sRGB} \\
 G_{8bit} &= 255.0 \times G'_{sRGB} \\
 B_{8bit} &= 255.0 \times B'_{sRGB}
 \end{aligned} \tag{2.19}$$

For The reverse is defined in Equation 2. to normalize as follows

$$\begin{aligned}
 R'_{sRGB} &= R_{8bit} \div 255.0 \\
 G'_{sRGB} &= G_{8bit} \div 255.0 \\
 B'_{sRGB} &= B_{8bit} \div 255.0
 \end{aligned} \tag{2.20}$$

If $R_{sRGB}, G_{sRGB}, B_{sRGB} \leq 0.003928$

$$\begin{aligned}
 R_{sRGB} &= R'_{sRGB} \div 12.92 \\
 G_{sRGB} &= G'_{sRGB} \div 12.92 \\
 B_{sRGB} &= B'_{sRGB} \div 12.92
 \end{aligned} \tag{2.21}$$

else if $R_{sRGB}, G_{sRGB}, B_{sRGB} > 0.003928$

$$\begin{aligned}
 R_{sRGB} &= \left[(R'_{sRGB} + 0.055) / 1.055 \right]^{2.4} \\
 G_{sRGB} &= \left[(G'_{sRGB} + 0.055) / 1.055 \right]^{2.4} \\
 B_{sRGB} &= \left[(B'_{sRGB} + 0.055) / 1.055 \right]^{2.4}
 \end{aligned} \tag{2.22}$$

And transforms to XYZ tristimulus

$$\begin{bmatrix} X \\ Y \\ Z \end{bmatrix} = \begin{bmatrix} 0.4124 & -0.3576 & 0.1805 \\ 0.2126 & 0.7152 & 0.0722 \\ 0.0193 & 0.1192 & 0.9505 \end{bmatrix} \begin{bmatrix} R_{sRGB} \\ G_{sRGB} \\ B_{sRGB} \end{bmatrix} \quad (2.23)$$

The sRGB support to the Internet, device drivers and operating systems is a complementary addition to the existing color management support.[32]

2.2 Literature Reviews

The package design has impact on marketing communications. Wei, Ou and Luo [33] studied about the association between package's colour and consumer expectations in orange juice packages. In the emotional responses, twelve terms of expectations of a product, including juice quality, position in the market, freshness, refreshingness, health and flavour strength, were examined. Two of them were related to observers' liking of a product, including liking and intention of purchase. The other 4 were related to observers' emotions of the package colour scheme, including colour activity, colour heat, colour weight and colour harmony. In experiment, the package colours were selected based on colour of orange juice package in the market and colours of orange juice package sample were selected in CIELAB colour space. From the experiment, they found high correlation between preference and colour harmony, and also preference and product quality. The results between male and female observers were different in the flavour strength scale, which female observers thought an orange juices had strong flavour when the package colour was dark but male observers thought strong flavour if chroma was lower. Moreover, they preferred orange juices having strong flavour when the package was yellowish colour. On the other hand, weak flavour was found for bluish colours. The results showed that colour harmony had effects on product quality and the expectations of consumers.

Yonemaru et al. [6] studied about influence of package colour to consumer's purchase. They investigated suitable colours for a label of mineral water. Visual assessments using a total of 199 PCCS colours as samples and presented in a viewing cabinet under D65 simulator were carried out. The observers rated in the scale suitability to unsuitability. The results showed that bluish colours were suitable and gave positive impressions in the label of mineral water and lower saturated colours were not suitable. Furthermore, they surveyed the colour label of mineral water in the market for overall 101 colours (Japanese and foreign products). It was found that 60% of colours were bluish colours. The resultant colour in the study related to colour label in the market.

The colour of orange juice package has impacts on consumer expectations about product and taste. Fernandez-Vazquez et al. [34] studied colour preference of orange juice. They brought the nine orange juice brands in the market to evaluate by consumers. The orange juices were contained in a clear bottle. Consumers were asked to choose sample according to their colour preferences. The consumers were grouped into six groups based on gender and age. Significant difference in gender was found in this assessment: male and female preferred different the colours of orange juice, male preferred redness colour but female preferred yellowness. Moreover, the consumers in each age range preferred different colours of orange juices, except in the range of 20-29 years male and female preferred similarly.

Wei et al. [35] investigated acceptability and relationships between juice colour and consumer expectations of tastes as sour, bitter, sweet, flavour including flavour strength and freshness. The digital image of orange juice in clear bottle were used in the experiment. Only the orange juice area was masked to change the colour of orange juice. The colour of orange juice were widely and evenly selected in terms of CIELAB colour space. In experiment, the observers evaluated the colour from CRT monitor in connection with acceptability and expectations of tastes of the 174 orange juice colours. Higher chroma had relationships with sweetness. Sourness was associated with redness of orange juice.

On the other hand, yellowness and lower lightness influenced bitterness. The results clearly showed that lower lightness affected bitterness.

Tang, Kälviäinen and Tuorila [36] studied about colour preference and sensory of sea buckthorn juice. Six of sea buckthorn juices represent origins and hybrids. In sensory experiment, observers evaluated intensity of aroma and tastes including sweetness, sourness, bitterness and astringency, and rated the colour of juices in yellow to red linear scale under fluorescent light. In addition to preference rating, the sweet and unsweet juice were brought to evaluate by observers under two light sources, fluorescent and red light. The results obtained from sensory attributes were different in all tastes in each genotype of sea buckthorn including colour, but aroma was not different. The results indicated the observers preferred the redness colour of juice. Significant difference was found in preference between male and female. Male preferred sweet juice while female preferred unsweet juice.

In the study by Sueeprasan and Traisiwaku [37] on green tea drinks, to evaluate colour preference, acceptability and association with taste. The samples were generated with mixture between water and food colourants based on colour of green tea drinks and comprehensive to the colour of green tea drinks in the Thai market. A total of 23 samples were evaluated in the centre of viewing cabinet under D65 simulators with dark room condition. For acceptability and preference, the results of colour preference were close to colour of green tea in the market. The colour of green tea that observers accepted and preferred was similar to colour in the market. In the case of association with taste, yellowish colour was influenced by sweetness and lower lightness correlated with bitterness.

In the effect of lighting, Rossi and Rizzi [2] studied food lighting in various colour temperature in relation to consumer preference. They experimented using five different light sources and filters included halogen (2900K with filter neutral anti-UV), sodium white (2550K with filter neutral anti-UV), and 3 metal halide light (4200K with filter neutral anti-UV,

warm dichroic, cold dichroic). Five types of food (three food categories): red meat, fish, products from oven such as bread and cakes, green-yellow vegetables and fruits, and orange-red vegetables and fruits. In the dark room, the observers were asked which product they would have bought. The same products were compared under various illuminations. The test on the effect of different lightings on food indicated that red meat and oven products were suitable for viewing under metal halide lamp with warm dichroic filter, metal halide lamp with neutral filter was suitable for fish and green-yellow vegetables and fruits, orange-red vegetables and fruits were best viewed under white sodium lamp with neutral filter.

CHAPTER III

METHODOLOGY

3.1 Materials

3.1.1 Arabica coffee beans

Growing:	from Viet Nam
Roasting:	Darker roast
Grounding:	Very finely

3.1.2 Epson Matt roll paper

Thickness:	10.3 mil
Basis weight:	192 gsm
Opacity:	94%
ISO brightness:	104%

3.1.3 Epson inkjet Inks:

T606: Black, Matt black, Light black, Cyan, Yellow, Magenta, Light cyan,
Light magenta,

3.1.4 ECI2002V CMYK Colour chart

3.2 Apparatus

3.2.1 Espresso Machine

Model:	Conti Xeos
Water temperature:	90 – 95 °C
Brewing Pressure:	8 -12 BAR

3.2.2 Medium-format digital camera

Model:	Phase One 645DF
Shutter speed:	1/125 s
Aperture:	f/11
ISO:	50

3.2.3 Digital back

Model:	Phase one P45+
Sensor format and size:	49.1mm x 36.8 mm
Lens factor:	1.1
Resolution:	39 megapixel

3.2.4 Lenses

Model:	Phaseone AF 150mm/f2.8 IF
Aperture Range:	f/2.8-22
Angel of View:	26°
Minimum Focusing Distance:	100 cm/ 3.3 ft.

3.2.5 Inkjet Printer

Model:	Epson stylus pro 4800/ eight colours
--------	--------------------------------------

3.2.6 Portable desktop viewer

Model:	GTIs' PDV-2e/M
Light source:	D65, CWF (TL84), Incandescent and UV
Viewing Area:	7.5" D x 19" W x 1

3.2.7 Spectrophotometer

Model:	Gretag Macbeth's Spectroscan transmission
spectral range:	
Measurement geometry:	d/0° and 180°/0°
Standard observers:	2° and 10°

3.2.8 Spectrodensitometer

Model:	X-Rite530
Geometry:	45° / 0°
Spectral Range:	400 - 700 nm
Standard observers:	2° and 10°

3.2.9 Spectroradiometer with standard lens

Model:	Konica Minolta CS-1000A
Wavelength range:	380 - 780 nm
Spectral bandwidth:	5 nm
Wavelength resolution:	0.9 nm/pixel

3.2.10 Software Applications:

MATLAB version 7.8
Adobe Photoshop CS3
Profile maker pro 5.0
CS-S10W
SPSS version 13.0
Microsoft office Excel 2008

3.3 Observers

Forty Thai observers participated in visual experiments, whereby they provided their opinions in association with coffee colour in prints. Amongst them were 10 experts call females on coffee making/drinking and 30 general coffee drinkers (16 females and 14 males). The experts were these who work in a coffee company as a researcher, developer, or quality controller. The unexpert were 14 students in Imaging and Printing Technology, 1 student in Biology Science, and 15 employees from Graphic Design Company. The experts ranged in from 28 to 36 years old with the average age of 30, and the unexpert from 18 to 32 years old with the average of 26.

3.4 Procedure

This study aimed to investigate correlation between colour of printed coffee images and observers' expectations. Observers assessed a series of printed coffee images that were varied in colour of only the coffee part under illuminants D65 and A. Expectations regarding product quality, taste and preference were collected and analysed statistically. The results from the expert group and unexpert group were compared, as well as the results from D65 and A viewing conditions.

The experimental process in this study was divided into 3 parts, as shown in Figure 3-1. The first part was experimental preparation in which printed samples of coffee images were made. The second part involved visual experiments whereby the printed samples were evaluated by observers. The experimental raw data were then analysed in the final part. The details of each part are described in Sections 3.4.1, 3.4.2 and 3.4.3, respectively.

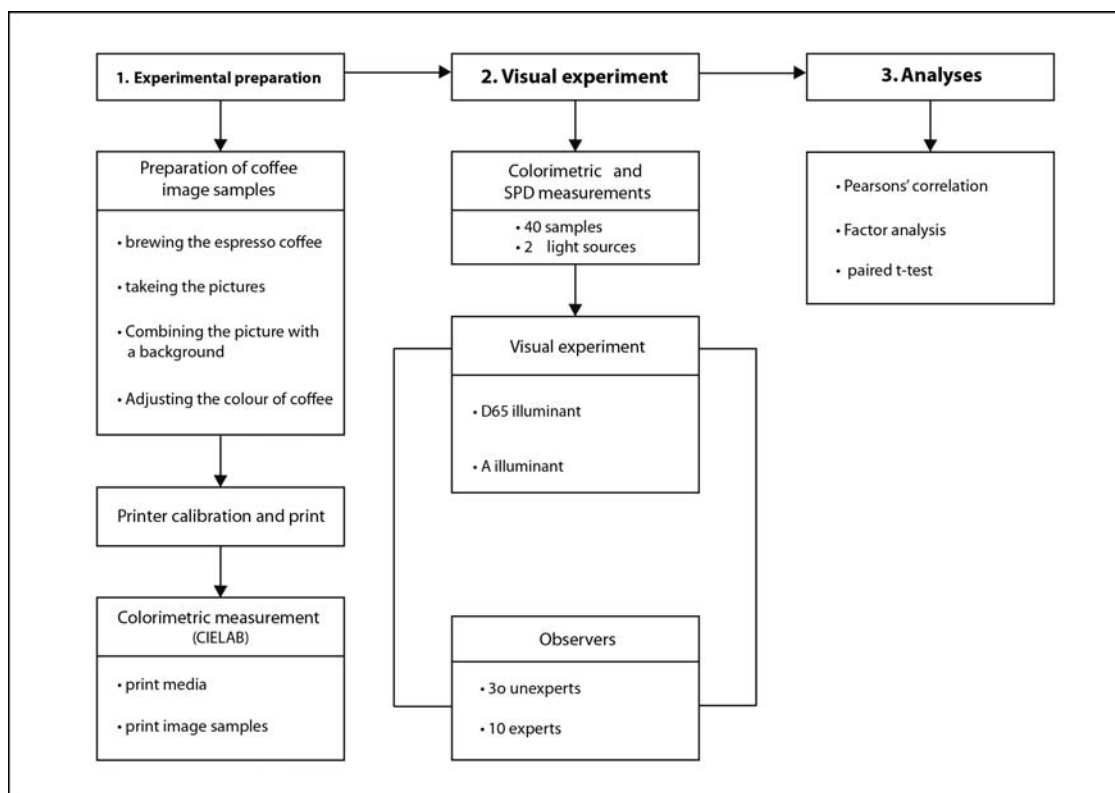

Figure 3-1 Overview of process of experiment.

3.4.1 Experimental preparation

The process of experimental preparation was divided into three parts, as shown in Figure 3-2. The first part was to prepare digital coffee images. In this part, the pictures of freshly-prepared espresso coffee were taken and combined with a background. The colour of coffee part were adjusted in term of CIELAB colour values. The second part was to print the coffee images, which involved a calibration of inkjet printer. Colorimetric measurements of printed coffee image samples were done in the final part. Colours of espresso coffee in print media were collected from the market survey and compared to the range of printed samples. The detailed descriptions of each part are given in the following sections.

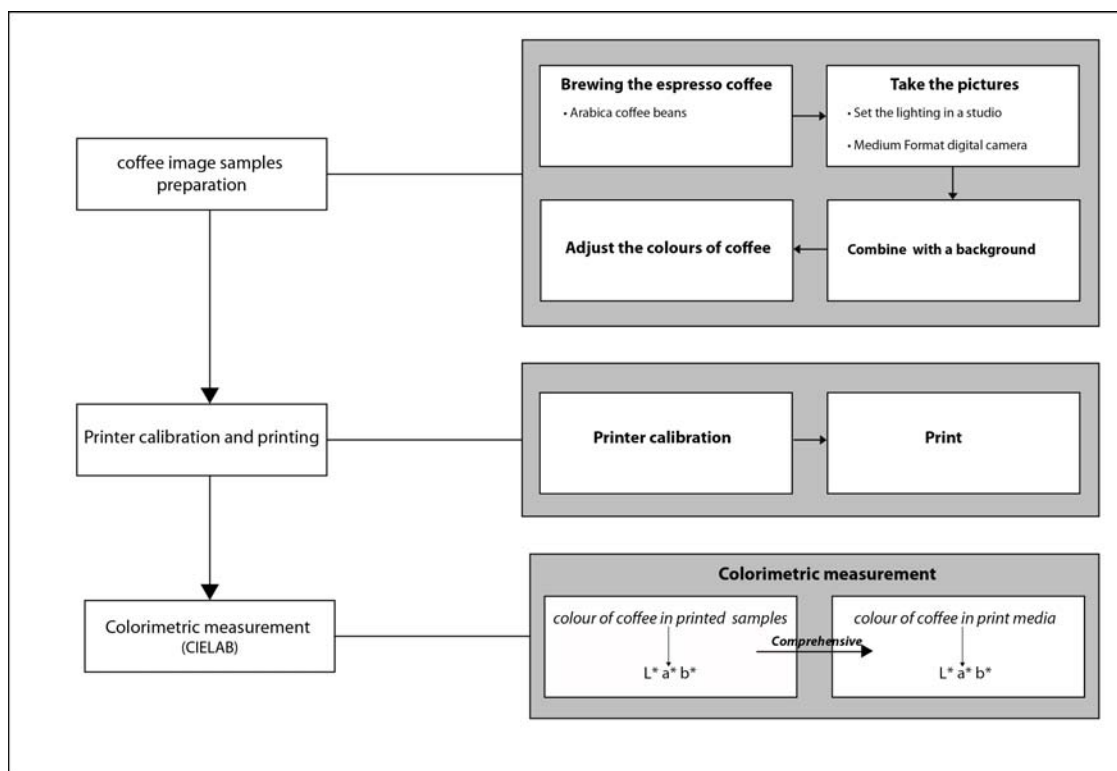

Figure 3-2 Three parts in experimental preparation.

3.4.1.1 Image preparation

3.4.1.1.1 Brewing espresso

Espresso was brewed by forcing boiling water under pressure through finely ground Arabica coffee beans. The roast level of the coffee beans was espresso roast, which is the darkest roast. The process of espresso brewing was controlled by a barista who ensured the perfect quality of espresso. The resultant espresso was approximately 75 ml.

3.4.1.1.2 Taking coffee picture

The images of espresso were taken in a photo studio. The layout of photo-shooting is shown in Figure 3-3. The medium-format digital camera (with 150 mm. lens) was set to encode picture in Raw-file format. The functions Colour and Exposure Management were set to off. Freshly-brewed espresso was contained in a white espresso cup and presented against a white background. The original picture obtained at this stage is shown in Figure 3-4.

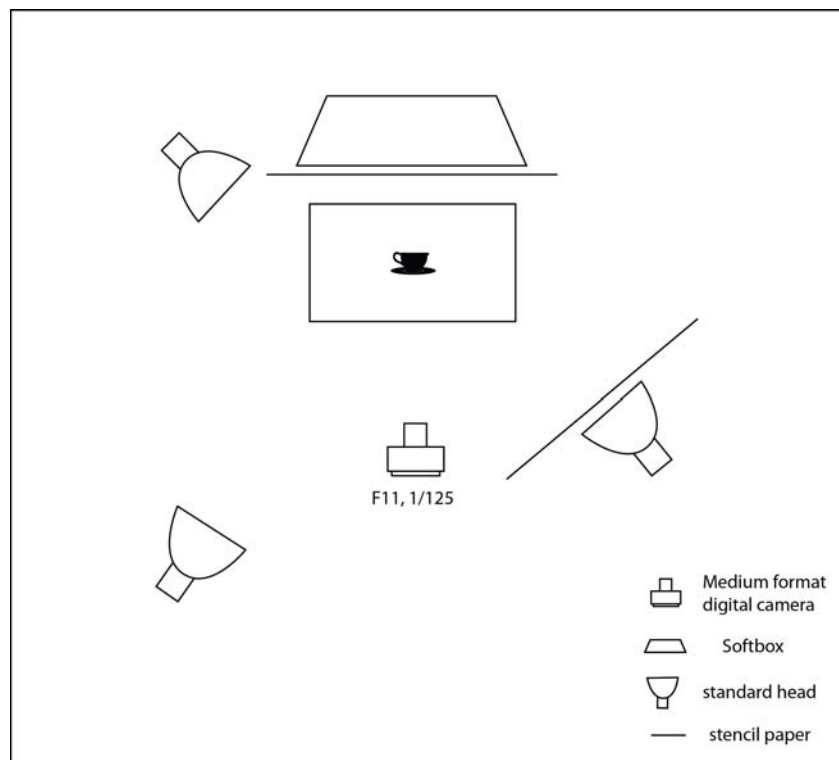

Figure 3-3 Layout of photo-shooting.



Figure 3-4 Original picture.

3.4.1.1.3 Combining coffee picture with a background

The coffee picture with a white background was combined with a picture selected from stock photos to create an original image with a complex background, simulating an image that usually found in coffee advertisement. This process was done using Adobe Photoshop CS3. The background image and the combined image are shown in figure 3-5.



Figure 3-5 The original images (a) Background image (b) Image after combineing with Background.

3.4.1.1.4 Adjusting colours of coffee

The colour of coffee in the original image was altered to generate a variety of colour samples. Figure 3-6 illustrates a flowchart of image processing done in the regard. First, sRGB data of the original coffee colour were converted to XYZ tristimulus values on a pixel-by-pixel basis. The XYZ data were then transformed to CIELAB colour values ($L^*a^*b^*$). The colour adjustment was done using $L^*a^*b^*$ values. The image data were varied along either L^* , or a^* , or b^* direction. For each direction, the new values deviated from the original values, or from the adjacent values, in 5 units. In addition to varying each direction separately, the image data were altered in a way that all directions were varied at the same time. Thus, the resulting colours of coffee covered the changes in lightness, chroma, and hue of the original coffee image. The new $L^*a^*b^*$ values were converted back to XYZ and from XYZ to sRGB data. This resulted in a total of 837 sample images. The sampled images replaced the original coffee colour in the original image using Adobe Photoshop CS3. Therefore, the only difference between the finished image samples and the original was the colour of coffee. The background and other part were kept constant.

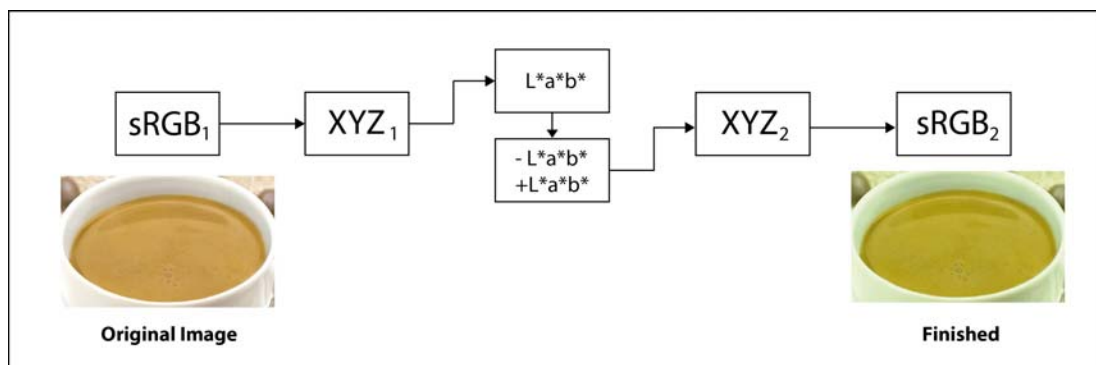

Figure 3-6 Flowchart of colour adjustment process.

3.4.1.2 Printer calibration and printing

In order to obtain printed samples with their colours as close to the digital images as possible, a printer must be calibrated and characterised. In this study, Colour Management Software was utilised to achieve the accurate colour prints. The procedures in which the printer was calibrated and the digital images were printed are explained in the following sections.

3.4.1.2.1 Printer calibration

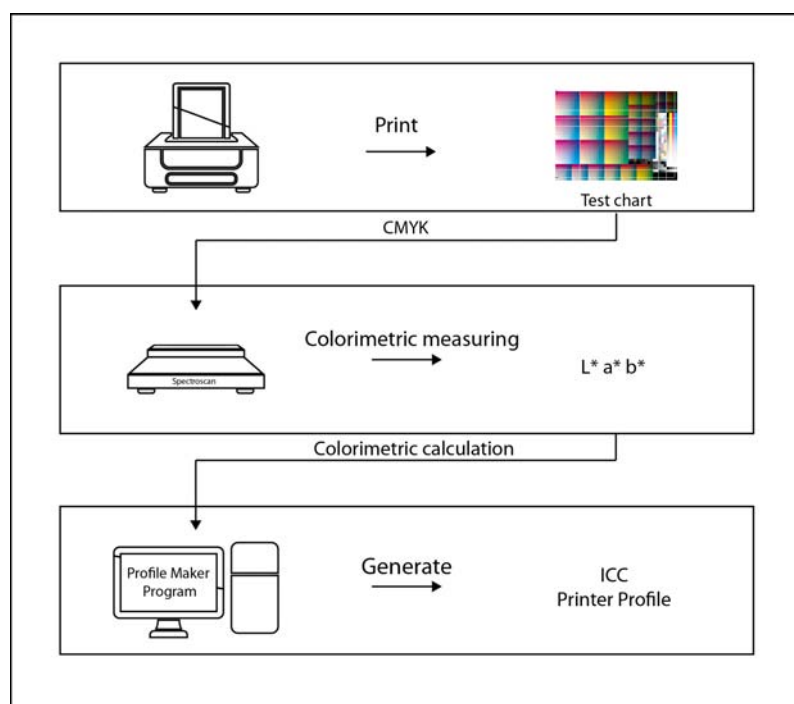

Figure 3-7 Process of printer calibration.

The purpose of printer calibration is to make the colours of printed image look like the colours of images shown in the monitor. The process of printer calibration using Profile Maker program is illustrated in Figure 3-7. The ECI2002V CMYK test was printed via Adobe Photoshop CS3 program selected matte paper media type was

selected and colour management system in printer driver program was turn off. Colours of the printed test chart were measured with Spectroscan transmission approximately 30 minutes after printing with the use of Profile Maker program, an International Color Consortium (ICC) printer profile was generated for the present seting of printer, ink and paper. The ICC printer profile was used as a destination colour space in printing control.

3.4.1.2.2 Printing image samples

After obtaining the ICC printer profile, the digital images were printed via profiles, the digital images were printed via Adobe Photoshop CS3. The digital images were converted from the source space to the destination space, printer profile, with relative colorimetric intent and colour management system (CMS) in printer driver software turning off. An illustrated flowchart of this process is shown in Figure 3-8.

The coffee images were printed by eight colour inkjet printer with high resolution on matte roll paper. A total of 837 coffee images were printed with 7 cm x 10 cm in size for colorimetric measurements to be described the next section. After colorimetric measurements the images samples were printed in 21 cm x 29 cm (A4) size.

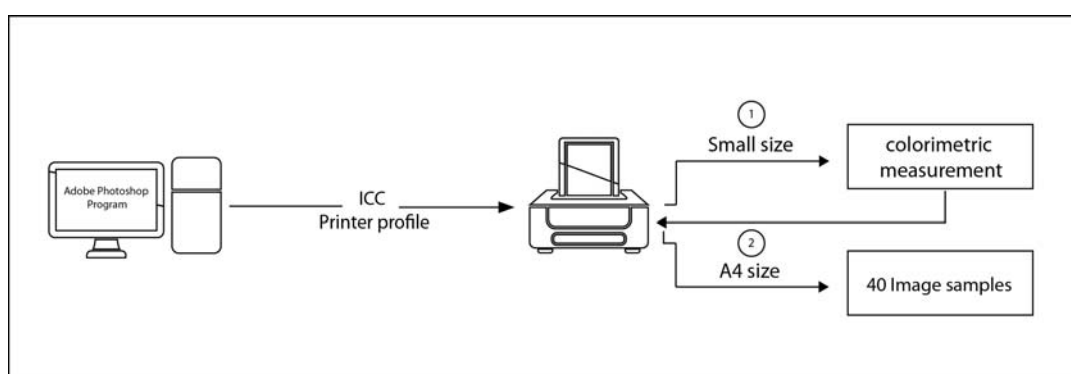

Figure 3-8 Printing process of image samples.

3.4.1.3 Colorimetric measurements

In order to ensure that the colours in image samples had a comprehensive coverage of espresso colours in print media in the market, 50 images of espresso coffee in print media were selected and their colours in coffee area were measured with a Spectrodensitometer under D65/10° conditions. Three positions in the coffee area were measured for large-size images, and two for small-size ones. The average $L^*a^*b^*$ values were calculated to represent coffee's colours for each image. Figure 3-9 shows the distributions of coffee colours in print media in CIELAB colour space.

Colours in coffee area in this image samples were measured the same way as was done for coffee images in print media. Two positions (left and right in coffee area) were measured and the colour data were averaged. Based on the distributions of colours from print media and image samples, 40 printed images, including the original image in which coffee colour was not adjusted, were selected to use experimental samples in visual assessments. The distributions of colour of 40 samples are also shown in Figure 3-9. It can be seen that the experimental samples cover the range of colour from print media currently used in the market in all dimensions of colour attributes, i.e. lightness, chroma and hue.

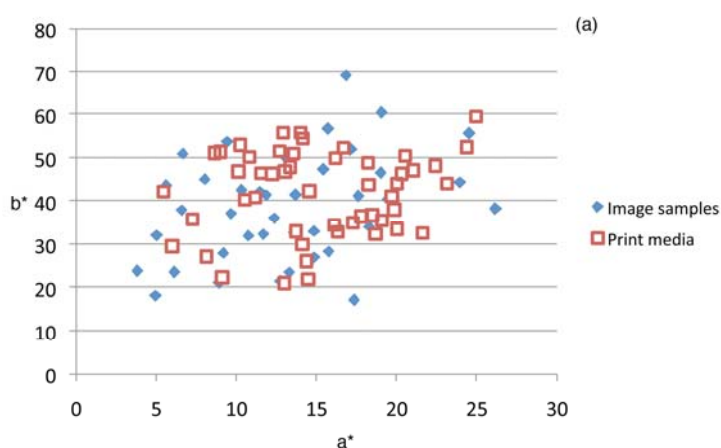
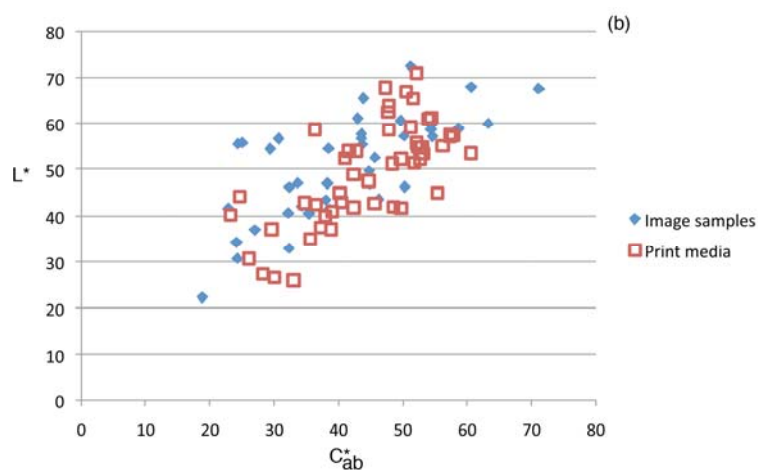

Figure 3-9 The distribution of fifty colours in print media and image samples in (a) a^* , b^* plane and (b) L^* , C^* plane.

Figure 3-9 (cont.)



3.4.2 Visual experiments

To study effects of espresso colour in print media in association with observers' expectations, visual assessments whereby observers made their judgements in regard to quality, taste and preference based on colour were carried out. Before conducting the visual experiments, colour of coffee in all samples were measured under the same set-up as when observers would view the samples (Figure 3-10). The measurements were done, using a spectroradiometer, in term of xyY values and spectral power distribution (SPD) values. The spectroradiometer was set to light source mode and the measurements were done under D65 illumination first, followed by A illumination, with 10° Standard Observer, in a darkened room. The image samples were placed in a light cabinet illuminated with either D65 or A simulators, with their distance from the spectroradiometer 60cm. The data values were transformed from the device to laptop computer via serial port cable (RS323) through CS-S10W program.

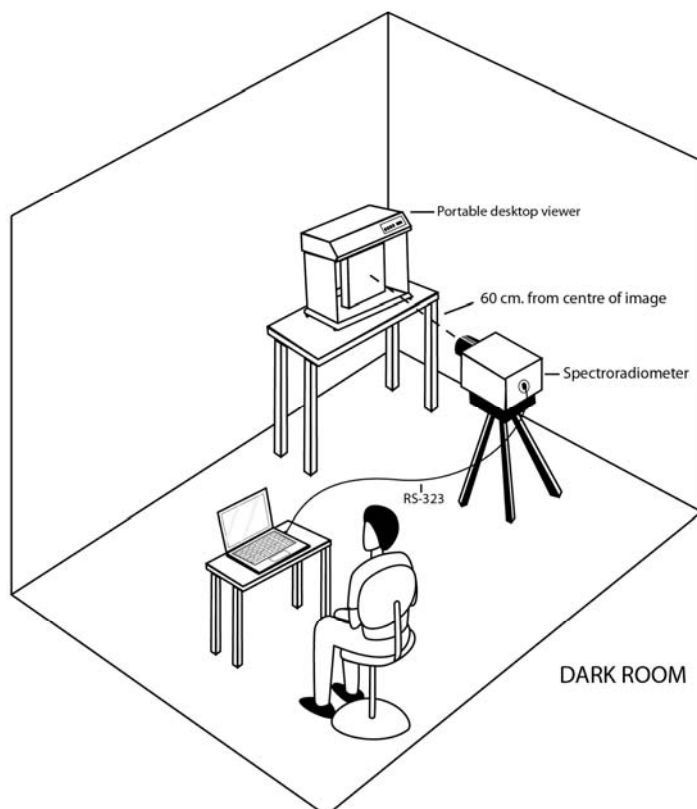

Figure 3-10 Colour measurements in experimental room.

The visual experiments were divided into 2 sessions according to light source illuminating the samples. Observers assessed the samples under D65 lighting in the first session, and A in the second session. The experiments were conducted in a darkened room where observers sat approximately 60 cm. away from the samples, which was the same position as when the measurements were done. The illustrated set-up of experiments is shown in Figure 3-11. Forty samples were presented to observers in random order for both sessions, Observers viewed the samples one by one and were instructed to evaluate each sample using a 1-9 rating scale, with the ends verbally anchored with not to very. For example in the preference scale, 1 rating represented “not preference” and 9 rating represented “very preference”. Eight expectations scales including preference, intention of purchase, quality, flavour strength and expectations of taste: sweet, bitter, sour and astringent, were investigated. The observers continued running the experiment until the last

image sample illuminated with D65 was assessed, they then assessed the samples under A illuminant. Each observers completed the experiments in approximately 30 minutes.

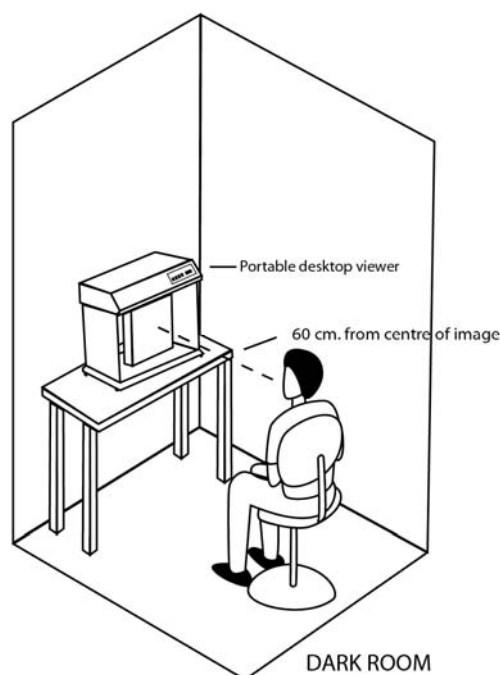

Figure 3-11 Experimented set-up

3.4.3 Data analysis

1. The xyY data of each sample viewed under D65 and A were converted to XYZ tristimulus values. The XYZ data were then calculated to obtain CIELAB colour values (L^* , a^* , b^* , C^*_{ab} and hue angle) using a white paper on which the image samples were printed as a reference white, which corresponded to lighting conditions. Hence, Two sets of colour data were obtained: 1) a set of 40 CIELAB colour values under D65 and 2) a set of 40 CIELAB colour values under A.

2. Two groups of observers, 10 experts and 30 unexperts, took part in the visual experiment. The visual scores for each of the 8 expectation scales (preference, quality, intention of purchase, flavour strength and 4 tastes: sweet, bitter, sour and astringent) were averaged from all observers in each group for each image under relevant lighting conditions.

3. The correlation coefficients (r value) were calculated to investigate relationships between two sets of data as follows:

- Colorimetric values (L^* , a^* , b^* , C^*_{ab} and h_{ab}) and expectation scales (preference, intention of purchase, quality, intention of purchase and taste).
- Each of the expectations scales against one another.

4. The paired t -test was employed to determine significant differences between the visual scores obtained from different lighting conditions (D65 vs. A), and from two observers groups (expert vs. unexperts). The paired t -test statistic is calculated by Equation 3.1.

$$t = \frac{\sum d}{\sqrt{\frac{n(\sum d^2) - (\sum d)^2}{n-1}}} \quad (3.1)$$

for degree of freedom = $n-1$

In this study, $\sum d$ represents the sum of score differences of variable pairs (between D65 and A, experts and unexperts) and n represents the number of sample pairs.

5. Factor analysis was employed to reduce the number of variables (expectation scales) by combining correlated variables into one factor and detecting structure in the relationships between variables.

CHAPTER IV

RESULTS AND DISCUSSIONS

4.1 Colorimetric values

4.1.1 Colour values of image samples

Forty printed images having different colours of coffee were viewed under two different lighting conditions: D65 and A. The xyY and spectral data of each image sample were measured under the same conditions the samples were viewed. The xyY data are presented in this section and the spectral data are discussed in Section 4.1.2

The spectroradiometer was set to light source mode, meaning that it measures the amount of light that reflects from printed colour as a result of interaction between incident light from light sources and optical properties of prints. In other words, it measures colour signals that enter the eye. According to 10° Observer, xyY data for images viewed under D65 and A were obtained. Figure 4-1 shows colour shifts in terms of chromaticity co-ordinates (xy) for different light sources. The xyY data are given in Table 4-1.

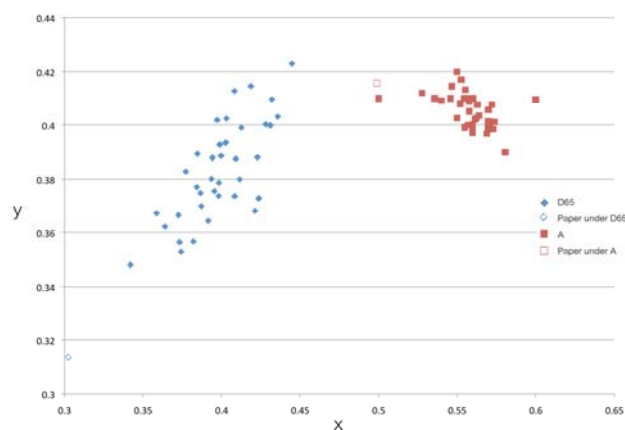

Figure 4-1 Chromaticity co-ordinates of 40 colour samples and paper under two light sources.

Table 4-1 xyY values of 40 colour samples and paper white under D65 and A simulator.

No.	D65			A		
	x	y	Y _(cd/m²)	x	y	Y _(cd/m²)
1	0.394	0.380	27.067	0.558	0.405	58.000
2	0.373	0.366	35.407	0.546	0.410	77.227
3	0.398	0.374	26.917	0.560	0.400	59.000
4	0.403	0.393	37.757	0.558	0.409	83.467
5	0.382	0.357	19.033	0.560	0.397	40.787
6	0.359	0.367	19.550	0.536	0.410	38.893
7	0.398	0.379	26.193	0.562	0.403	57.583
8	0.431	0.400	41.403	0.574	0.401	94.843
9	0.445	0.423	59.097	0.572	0.408	134.563
10	0.424	0.373	28.113	0.581	0.390	67.763
11	0.385	0.389	35.210	0.547	0.415	75.087
12	0.397	0.402	53.583	0.550	0.420	117.000
13	0.399	0.393	38.207	0.560	0.410	80.000
14	0.133	0.131	12.736	0.571	0.400	77.000
15	0.044	0.044	4.245	0.570	0.400	105.913
16	0.423	0.388	40.033	0.573	0.399	91.000
17	0.419	0.415	44.307	0.560	0.410	97.000
18	0.387	0.375	26.133	0.560	0.410	55.037
19	0.392	0.364	38.747	0.560	0.399	85.357
20	0.373	0.356	36.240	0.550	0.403	79.000
21	0.408	0.374	38.060	0.569	0.397	86.000
22	0.342	0.348	13.997	0.528	0.412	25.583
23	0.436	0.403	47.693	0.570	0.401	107.000
24	0.403	0.402	34.403	0.555	0.413	74.373
25	0.374	0.353	21.543	0.555	0.399	45.000
26	0.413	0.399	37.447	0.563	0.408	82.513
27	0.394	0.388	32.247	0.555	0.410	67.000
28	0.432	0.410	45.490	0.570	0.406	103.007
28	0.411	0.380	31.510	0.570	0.398	71.000
30	0.421	0.368	28.817	0.581	0.390	66.523
31	0.408	0.413	71.070	0.553	0.417	153.000
32	0.384	0.377	29.743	0.552	0.408	63.767
33	0.409	0.387	42.860	0.564	0.404	97.000
34	0.395	0.375	26.053	0.561	0.402	56.000
35	0.400	0.389	35.390	0.558	0.410	80.000
36	0.377	0.383	28.570	0.500	0.410	59.027
37	0.364	0.362	23.987	0.540	0.409	51.000
38	0.403	0.394	45.383	0.600	0.410	100.807
39	0.428	0.400	46.083	0.570	0.400	104.000
40	0.387	0.370	24.787	0.557	0.400	53.017
white paper	0.303	0.314	110.697	0.416	0.499	237.313

The chromaticity co-ordinates represent relative magnitudes of XYZ tristimulus values. The chromaticity diagrams provide a colour map in which the chromaticities of all colours can be plotted. From Figure 4-1, xy chromaticity co-ordinates of colour samples and printing paper under D65 and A were different. It means that the colours of coffee in image samples were different when viewed under different light sources. When the image

samples were viewed under A, the colours of coffee from different samples became more similar and shifted towards yellowish colours. In contrast, the samples viewed under D65 spread out in greenish direction and were less saturated. The printing paper under D65 appeared bluish white whilst the same paper viewed under A appeared yellowish. It should also be noted that A illumination (237.3 cd/m^2) was brighter than D65 illumination (110.7 cd/m^2).

4.1.2 Spectral data of image samples

Spectral data indicate spectral characteristics of materials under light source per unit wavelength interval. In this study, the spectral data were measured every 10 nm from 400 to 700 nm. The spectral curves of all samples under D65 and A simulators are shown in Figures 4-2 and 4-3, respectively.

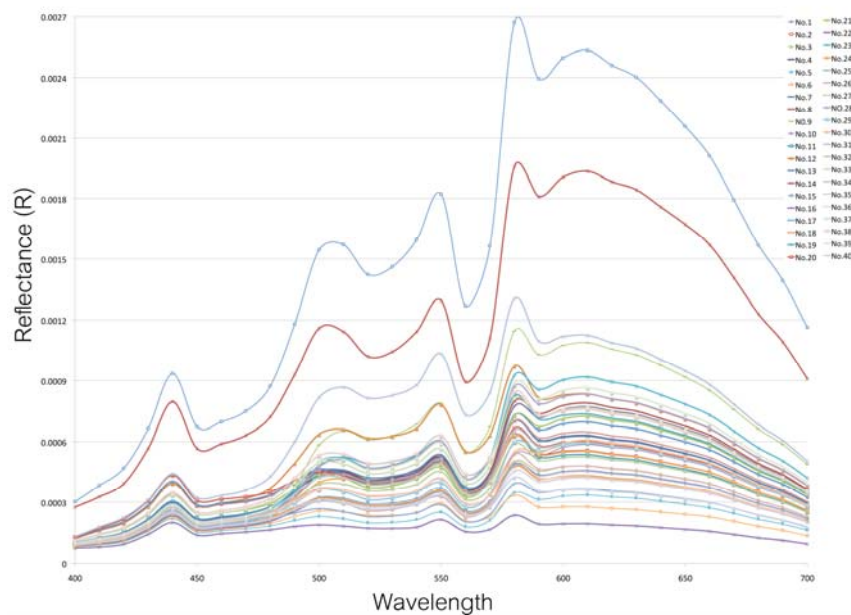

Figure 4-2 Spectral curves of all samples under D65 simulators.

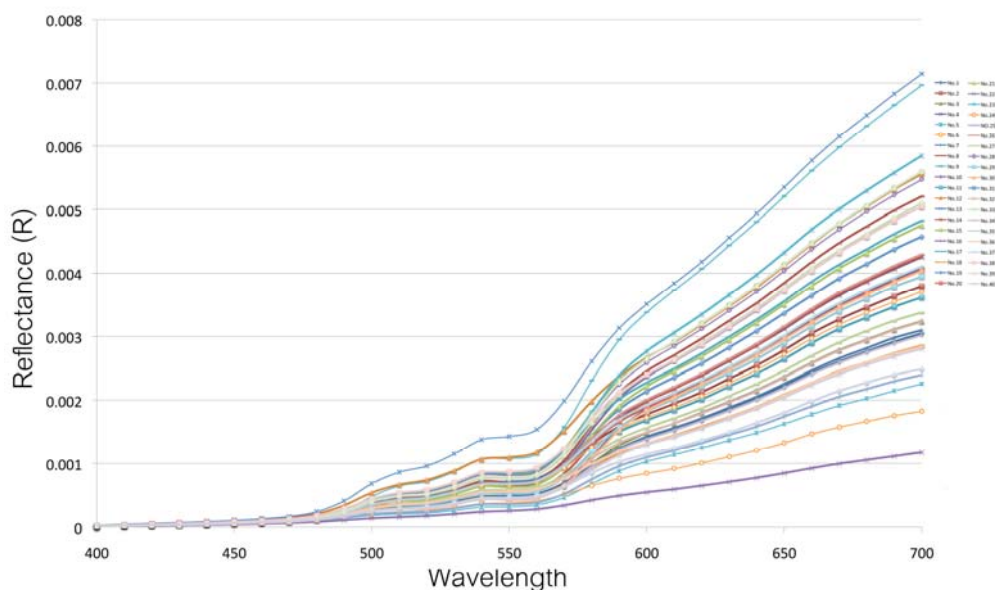

Figure 4-3 Spectral curves of all samples under A simulators.

From Figures 4-2 and 4-3, the spectral curves show colour output under given light sources by the level of energy presented by wavelength in the spectrum. A perception of colour by the human eye limits in spectrum between 380 and 780 nm. The hue can be recognized following on wavelengths between 380 to 780 nm; blue is shorter wavelengths about 480 nm; between 480 to 560 are green; yellow is between 560 to 590 nm; orange 590 to 630 nm and wavelengths longer than 630 are red.

All of image samples had different spectral curves under D65 simulators (Figure 4-2) as well as A simulators (Figure 4-3). This is due to the fact that all images had different colours of coffee. The differences between images viewed under two different lighting conditions arise from the fact that D65 and A have different spectral power distributions (Figure 4-4), which affect spectral intensity reflected from the images, and thus colour appearance. Since D65 have more powers in shorter wavelengths than A, colours of coffee images viewed under D65 appeared more distinguishly different than those viewed under A, where the differences were present only in longer wavelengths. This could explain the

different spreading of chromaticity data between images viewed under D65 and A found in Section 4.1.1.

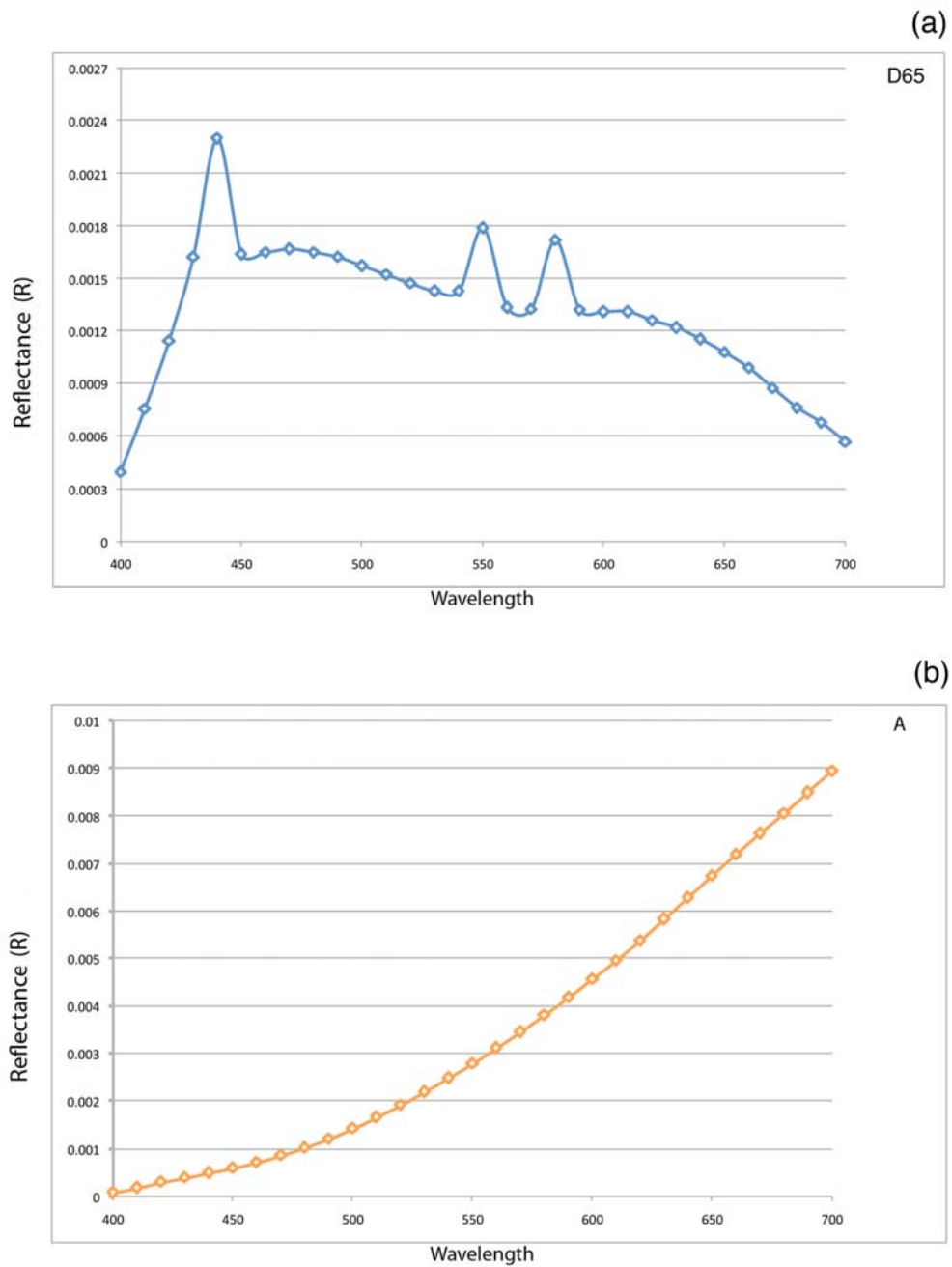

Figure 4-4 Spectral curves of white paper under (a) D65 and (b) A simulators.

4.2 Results from visual assessments

In visual assessments, observers were instructed to associate colour of coffee with their expectations regarding preference, intention of purchase, quality, flavor strength, and tastes. A rating scale ranging from 1-9 was applied to each expectation, where 1 indicates not having very much of that expectation (for example, not very sweet); 9 indicates having very much of that expectation (for example, very sweet); 5 is neutral.

The observers were separated into two groups: expert and unexpert groups, so the visual scores for each image were averaged from all observers in each group. In addition, observers assessed the images under two lighting conditions: D65 and A. The visual scores were also separated according to lighting conditions. Comparisons between the visual scores obtained from two groups of observers (expert vs. unexpert) and from two lighting conditions (D65 vs. A) are given in Section 4.2.1. Section 4.2.2 discusses relationships between colorimetric values and expectation scales. Relationships between expectation scales are also investigated. Factor analysis was employed to find underlying factors that explain the data and the results are given in Section 4.2.3.

4.2.1 Comparisons between two groups of visual results

In this study, the visual scores (observers' expectations) for each image were averaged according to observer groups and lighting conditions. Significant differences between the results from two observer groups and from two lighting conditions were analysed by means of the paired t-test, which is a hypothesis test of the difference between means of each pair. The hypotheses are as follows.

$$H_0: \mu_1 = \mu_2$$

$$H_1: \mu_1 \neq \mu_2$$

H_0 represents the null hypotheses that the population means are not significantly different. H_1 represents the alternative hypothesis that the population means are significantly different. The level of significance in which the null hypothesis is rejected in this study is 0.05. In other words, the null hypothesis is rejected when t-value is greater than critical t-value at 95% confidence interval.

4.2.1.1 Experts vs. unexperts

To investigate the significance of differences between the visual results obtained from two different groups of observers, the paired t-test was calculated and the results are shown in Tables 4-2 and 4-3. If the p-value is less than the significance level of 0.05, it means that the difference between two observer groups is significant at 95% confidence.

Table 4-2 Paired t-test between two observer groups for D65 condition.

variables	Paired Differences		t	df	Sig. (2-tailed)
	Mean	Std. deviation			
Preference	-.95000	1.09381	-5.493	39	.000
Intention of Purchase	-.54250	1.37727	-2.491	39	.017
Quality	-.65750	1.28938	-3.225	39	.003
Flavour Strength	.55000	.99228	3.506	39	.001
Sweetness	-1.06000	.77055	-8.700	39	.000
Bitterness	.88250	.71068	7.854	39	.000
Sourness	1.08750	.82156	8.372	39	.000
Astringency	1.26750	.77274	10.374	39	.000

Highlighted figures indicate the cases that the results from two groups are significantly different.

Table 4-3 Paired t-test between two observer groups for A condition.

variables	Paired Differences		t	df	Sig. (2-tailed)
	Mean	Std. deviation			
Preference	-.37575	1.12997	-2.103	39	.042
Intention of Purchase	-.16475	1.28296	.812	39	.422
Quality	.03175	1.21820	.165	39	.870
Flavour Strength	.56125	.90026	3.943	39	.000
Sweetness	-.90675	.85101	-6.739	39	.000
Bitterness	.26000	.84362	1.949	39	.058
Sourness	1.53425	.98844	9.817	39	.000
Astringency	1.34259	.85332	9.950	39	.000

Highlighted figures indicate the cases that the results from two groups are significantly different.

The results showed that under D65 conditions, the results of all expectation scales from the experts and unexperts were significantly different. In other words, the experts had different expectations from the unexperts in all aspects when seeing the same coffee images. The similar results were found for A lighting condition. Most expectation scales fail the paired t-test, i.e. the results between expert and unexpert groups for that expectation scale were significantly different. Only three expectation scales: intention of purchase, quality and bitterness, shown that the experts were in agreement with the unexperts. Hence, the following analyses of the visual results will be carried out with respect to two observer groups.

4.2.1.2 D65 vs. A

The visual results for two different lighting conditions were examined the significant between them. Tables 4-4 and 4-5 show the paired t-test between the results from D65 and A conditions for the experts and the unexperts, respectively. If the p-value is less than the significance level of 0.05, it means that the same image when viewed under D65 will give different expectations from under A. In the case of expert, four out of eight

expectation scales showed significant differences between two lighting conditions. They were preference, intention of purchase, quality and bitterness. However, the unexperts significantly gave different expectations for the some images viewed under D65 and A in all scales. Since different lighting conditions cause different colour appearance of the same image, it implies that the observers relate certain colours with certain expectation; when the colours change, the expectations change. Hence, the visual results will be separately analysed according to lighting conditions.

Table 4-4 Paired t-test between two lighting conditions for the experts.

variables	Paired Differences		t	df	Sig. (2-tailed)
	Mean	Std. deviation			
Preference	-.87750	.81161	-6.838	39	.000
Intention of Purchase	-1.04250	.96340	-6.844	39	.000
Quality	-.91250	.97117	-5.942	39	.000
Flavour Strength	-.04750	.89871	-.334	39	.740
Sweetness	.07000	.88294	.501	39	.619
Bitterness	.75250	.85064	5.595	39	.000
Sourness	-.09750	1.13442	-.544	39	.590
Astringency	.16000	.87788	1.153	39	.256

Highlighted figures indicate the cases that the results from two groups are significantly different.

Table 4-5 Paired t-test between two lighting conditions for the unexperts.

variables	Paired Differences		t	df	Sig. (2-tailed)
	Mean	Std. deviation			
Preference	-.30325	.46137	-4.157	39	.000
Intention of Purchase	-.33525	.47811	-4.435	39	.000
Quality	-.22325	.39186	-3.603	39	.001
Flavour Strength	-.03625	.36801	-.623	39	.537
Sweetness	.22325	.33537	4.210	39	.000
Bitterness	.13000	.40268	2.042	39	.048
Sourness	.34925	.38295	5.768	39	.000
Astringency	.23500	.39194	3.792	39	.001

Highlighted figures indicate the cases that the results from two groups are significantly different.

4.2.2 Relationships between two variables

In this study, Pearson's correlation coefficient (r-value) was used as a measure of a relationship between two variables. The variables in this study were colorimetric values in CIELAB space and eight expectation scales. All possible pairs of variables were evaluated the relationships between them. The results are given in the following sections.

4.2.2.1 Colorimetric values vs. expectations

Colorimetric values (C^*_{ab} , L^* , a^* and b^*) were paired with each of the eight expectations: preference, intention of purchase, quality, flavour strength and tastes including sweet, bitter, sour and astringent. The relationships between each pair were determined by r values. The results are shown in Tables 4-6 and 4-7.

Table 4-6 Relationships between chroma, and lightness, and eight expectations under D65 and A from two observer groups.

r value	C*				L*			
	D65		A		D65		A	
	expert	unexpert	expert	unexpert	expert	unexpert	expert	unexpert
Preference	0.36	-0.36	0.19	-0.35	0.45	-0.23	0.34	-0.19
Purchase	0.52	-0.34	0.34	-0.33	0.59	-0.21	0.46	-0.18
Quality	0.47	-0.39	0.31	-0.41	0.53	-0.28	0.47	-0.27
Flavour Strength	-0.49	-0.85	-0.37	-0.87	-0.51	-0.83	-0.32	-0.82
Sweetness	0.61	0.82	0.39	0.91	0.61	0.86	0.53	0.93
Bitterness	-0.71	-0.89	-0.61	-0.9	-0.71	-0.88	-0.7	-0.88
Sourness	0.21	-0.15	0.05	0.27	0.02	-0.34	-0.08	0.09
Astringent	-0.38	-0.05	-0.48	-0.5	-0.45	-0.6	-0.59	-0.57

Highlighted figures indicate strong correlations.

The r value is a number between +1 and -1 that describes the linear relationship between two variables. An r value of +1 means a perfect positive correlation, 0 means no correlation, and -1 means a perfect negative correlation. From Table 4-6, it can be seen that for the group of unexperts, chroma and lightness had negative correlations with flavour strength and bitterness. These results were found in both lighting conditions. It means that when coffee colours became dark and less chromatic, the unexperts associated them with strong flavour and having bitter taste. Moreover, positive correlations were found between chroma/lightness and sweetness, i.e. when coffee colours were lighter and more chromatic, the unexperts expected the coffee to be sweeter. On the other hand, the experts showed negative correlations between chroma/lightness and bitterness (only in D65 in the case of chroma). Positive correlations were also found for chroma/lightness and sweetness but they were moderate correlations (0.61) and found only in D65. In addition, The experts tended to buy espresso coffee if its colour was high in chroma (moderate correlation of 0.52) and/or high in lightness (moderate correlation of 0.59).

Table 4-7 Relationships between a^* , and b^* , and eight expectations under D65 and A from two observers groups.

r value	a^*				b^*			
	D65		A		D65		A	
	expert	unexpert	expert	unexpert	expert	unexpert	expert	unexpert
Preference	-0.03	-0.12	-0.06	-0.31	0.39	-0.34	0.24	-0.33
Purchase	0.07	-0.13	0.04	-0.31	0.54	-0.33	0.38	-0.31
Quality	0.10	-0.2	0.00	-0.36	0.49	-0.36	0.36	-0.39
Flavour Strength	0.02	-0.5	-0.41	-0.74	-0.51	-0.81	-0.34	-0.85
Sweetness	0.45	0.51	0.34	0.75	0.59	0.79	0.38	0.9
Bitterness	-0.38	-0.52	-0.42	-0.8	-0.70	-0.85	-0.61	-0.87
Sourness	0.12	-0.23	-0.04	0.19	0.21	-0.14	0.06	0.27
Astringent	-0.28	-0.43	-0.32	-0.45	-0.37	-0.47	-0.49	-0.48

Highlighted figures indicate strong correlations.

From Table 4-7, it was found that the unexperts associated b^* with flavour strength/sweetness/bitterness for both lighting conditions. When coffee colours were less yellowish, the unexperts thought the coffee to be strong in flavour and bitter. On the contrary, when the colours became yellowish, the unexperts expected the coffee to be sweet. In the case of a^* , similar trends were found for the unexpert group only in A condition. The unexperts tended to expect higher flavour strength and/or more bitterness of coffee when its redness decreased. In contrast, the experts showed no association between a^* and expectations. They correlated b^* with bitterness only in D65 condition. They tended to think that coffee was bitter when its colour was less yellowish. However, moderate correlation was found for b^* and intention of purchase. The experts had a tendency to buy coffee which was yellowish.

In summary, the results indicated that the unexpert group associated chroma/lightness/ b^* with flavour strength/sweetness/bitterness. Dark, less chromatic/less yellowish coffee was thought to be strong in flavour and bitter. Light, yellowish coffee was expected to be sweet. The experts associated lightness/chroma with bitterness. Dark, less chromatic coffee was expected to be bitter. Differences were found between two lighting conditions and two observers groups.

4.2.2.2 Between eight expectations

The eight expectation scales: preference, intention of purchase, quality, flavour strength and four tastes, were paired with one another to examine the relationships between to them. The results were classified according to observer groups and lighting conditions. Figures 4-5 and 4-6 illustrate correlations between expectation scales for expert and unexpert groups for images viewed under D65 and A, respectively.

In Figures 4-5 and 4-6, correlations between expectation scales are presented by a line connecting two expectation scales together. Only the strong correlations are shown and their r values are given on or next to the connecting lines.

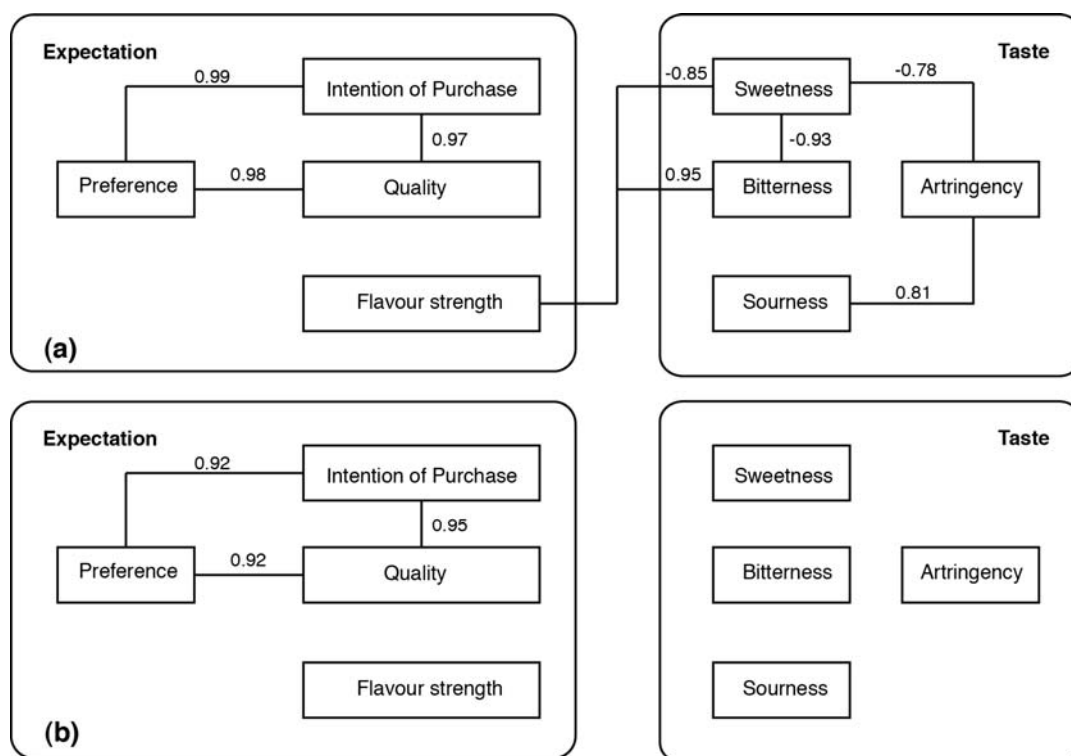

Figure 4-5 Correlations between expectation scale for (a) unexpert group of observers (b) expert group of observers under D65 simulators.

From Figure 4-5, preference strongly correlated with intention of purchase and quality. These results were found for two observer groups. This suggests that observers associated colour with quality and would buy the product if they thought the colour, and therefore the quality, was right. Moreover, only unexpert group had relationships between flavour strength and tastes (sweetness and bitterness). Sweetness had negative relationships with flavour strength, bitterness and astringency. This indicates that observers

expected espresso coffee having strong flavour when it was bitter, not sweet. When it was sweet, it tended to be void of bitterness and astringency. It was also found that astringency had a positive correlation with sourness. It should be noted that these associations were found only for the unexpert group, whereas the experts did not correlate tastes with any aspects.

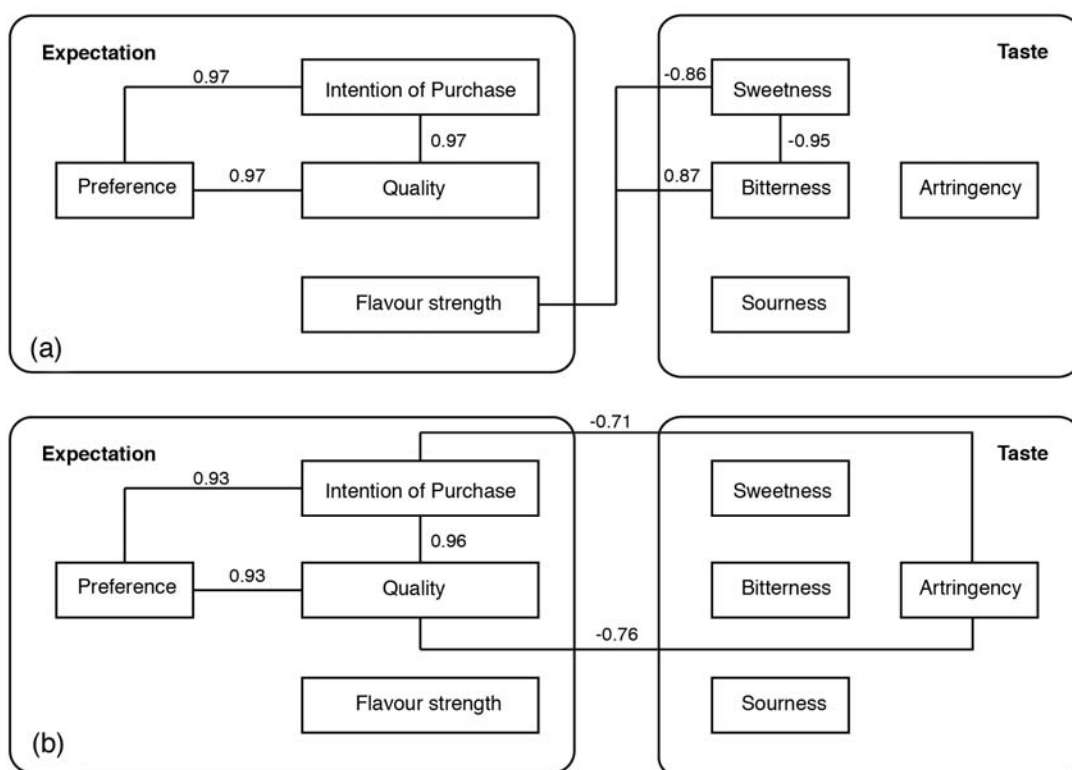

Figure 4-6 Correlations between expectation scales for (a) unexpert group of observers (b) expert group of observers under A simulators.

Similar results found in D65 lighting condition were found in A for the unexpert group. The unexperts positively correlated preference with intention of purchase and quality, and intention of purchase with quality. Sweetness inversely correlated with flavour strength and bitterness, while flavor strength positively correlated with bitterness.

In the case of the expert group, differences between D65 and A were found. Under A lighting condition, the experts inversely correlated astringency with intention of purchase and quality. This suggests that the experts thought that good-quality espresso should not have this taste and they would not buy it if it were to have this taste. All in all, the results from both observer groups in both lighting conditions showed positive correlations between preference, intention of purchase, and quality.

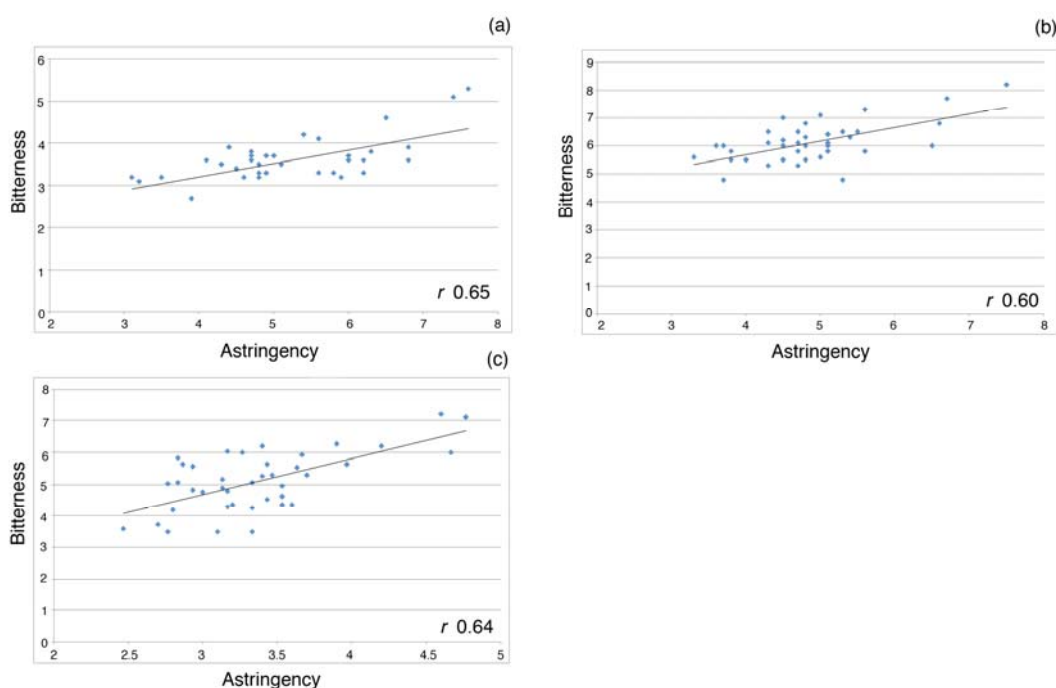

Figure 4-7 Correlations between bitterness and astringency for (a) unexperts under D65 (b) unexperts under A (c) experts under D65.

Some moderate correlations between bitterness and astringency were found. The results are plotted in Figure 4-7. It can be seen that the expectation of bitterness increases with the expectation of astringency.

4.2.3 Factor analysis

The method of factor analysis is used to extract a few underlying components from a large number of variables by cluster of homogeneous variables in the components. Each variable in the component has mutual relationships. In this study, factor loading of each variable in components obtained factor extraction by Principle Components Analysis (PCA) and Correlation matrix method. A factor loadings passed factor rotation matrix by Orthogonal Rotation method. In addition to Factor Analysis, Kaiser-Meyer-Olkin (KMO) measuring of sampling adequacy was used for investigating a relationship of all variables.

The factor analysis method was used to find the components in two lighting conditions and two groups of observers. Factor scores of each components were calculated to link colour values with image samples.

4.2.3.1 Underlying components of expectations in expert group.

All of the expectation scales in two lighting conditions were analysed using factor analysis. Factor scores of each component (PC) after factor extraction by PCA are given in Table 4-8.

Table 4-8 Eigenvalues, % variance and cumulative % of variance of each component for expert group.

Component	D65			A		
	Eigenvalues	% of Variance	Cumulative % of Variance	Eigenvalues	% of Variance	Cumulative % of Variance
1	4.18	52.32	52.32	4.77	59.67	59.67
2	1.54	19.27	71.60	1.34	16.83	76.51
3	1.17	14.71	86.31	.80	10.00	86.51
4	.55	6.92	93.23	.54	6.81	93.33
5	.24	3.09	96.33	.27	3.44	96.78
6	.19	2.37	98.70	.17	2.12	98.90
7	.06	.86	99.56	.06	.75	99.65
8	.03	.43	100.00	.02	.34	100.00

An eigenvalue indicates a number of components. The eigenvalue must be more than one for that component to be counted. From Table 4-8, the results showed that for D65 condition, there were three components that could explain the relationships between variables (expectation scales). The first component (PC1) contained the maximum amount of the remaining data variability (52.32% of variance). All components accepted must have the cumulative percentage of variance more than 80 percentage.

Table 4-9 shows factor loading after rotating the component matrix. Each number of factor loadings represents the correlations between components and variables, for example, the correlation between quality and Component 1 is 0.964. The correlation is used to sort the variables into the components by cluster variables which have large loadings for a particular component.

The underlying factors of expectations of expert group under D65 simulators had three factors. The first factor comprised of quality, intention of purchase, preference, sweetness and astringency (inverse relationship). The second factor included flavour strength and bitterness. The third factor was only sourness.

Table 4-9 Factor loadings after rotation of components matrix for expert group.

Variable	D65			Variable	A		
	Component				Component		
	1	2	3		1	2	3
Quality	.964			Intention of Purchase	.952	-.127	.107
Intention of Purchase	.952			Quality	.943	-.197	
Preference	.939	.133	-.105	Preference	.930	-.155	.225
Sweetness	.772	-.486	.221	Astringency	-.745	.450	.336
Astringency	-.689	.341	.475	Sweetness	.648	-.452	-.203
Flavour Strength	.219	.834		Bitterness	-.612	.340	.563
Bitterness	-.388	.819		Flavour Strength	-.188	.938	
sourness			.975	Sourness	.186	-.106	.895

In the case of A condition, the eigenvalues from the Table 4-8 indicated two components but the cumulative percentage of variance was less than 80%. Thus, third component, with the eigenvalue of 0.8, was included and all of the accept components had the cumulative percentage of variance of 86.51%. Three underlying factors were found, (Table 4-9). The first factor included intention of purchase, quality, preference, sweetness, astringency and bitterness (inverse relationship). The second factor and the third factor contained only flavour strength and sourness, respectively.

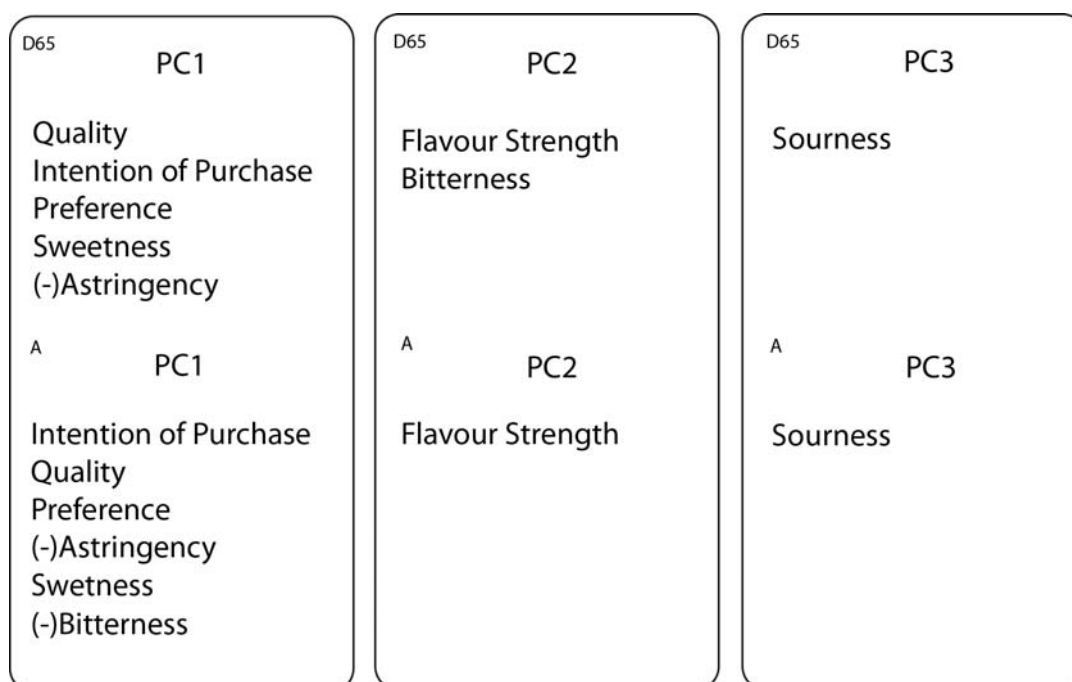

Figure 4-8 Summary of underlying factor for the expert group.

Figure 4-8 illustrates a summary of underlying factors that explain the expectations. It can be that from eight expectation scales the variables were reduced to three scales. This is because the variables in the same component were highly correlated and they could be explained by the same factor.

4.2.3.2 Underlying components of expectations in unexpert group

The method of factor analysis was also applied to find underlying factor for expectations of the unexpert group. Two components were found for D65 and A, with the cumulative percentages of 93.40 and 88.68, respectively.

Table 4-10 Eigenvalues, % variance and cumulative % of variance of each component for unexpert group.

Component	D65			A		
	Eigenvalues	% of Variance	Cumulative % of Variance	Eigenvalues	% of Variance	Cumulative % of Variance
1	4.02	50.34	50.34	4.41	55.22	55.22
2	3.44	43.05	93.40	2.67	33.46	88.68
3	.30	3.76	97.16	.53	6.62	95.30
4	.11	1.49	98.65	.26	3.24	98.55
5	.04	.58	99.23	.04	.54	99.09
6	.03	.42	99.66	.03	.37	99.47
7	.01	.22	99.88	.02	.29	99.76
8	.00	.11	100.00	.01	.23	100.00

Table 4-11 Factor loadings after rotation of components matrix for unexpert group.

Variable	D65		Variable	A	
	Component			Component	
	1	2		1	2
Preference	.986		Preference	.966	.116
Intention of Purchase	.984		Intention of Purchase	.957	.120
Quality	.966	.142	Quality	.954	.198
Sweetness		-.967	Sourness	-.735	
Bitterness	.318	.926	Sweetness	-.113	-.963
Astringency	-.392	.867	Bitterness	.222	.962
Flavour Strength	.508	.835	Flavour Strength	.541	.805
Sourness	-.634	.640	Astringency	-.491	.777

The factor loadings can be found in Table 4-11, For D65, the first component included preference, intention of purchase and quality. Sweetness (inverse relationship), bitterness, astringency, sourness and flavour strength were in the second component. In the case of A, the first component included quality, flavour, preference, intention of purchase, sourness (inverse relationship) and bitterness. The second component contained astringency and sweetness (an adverse relationship). A summary of scales in each component is illustrated in Figure 4-9.

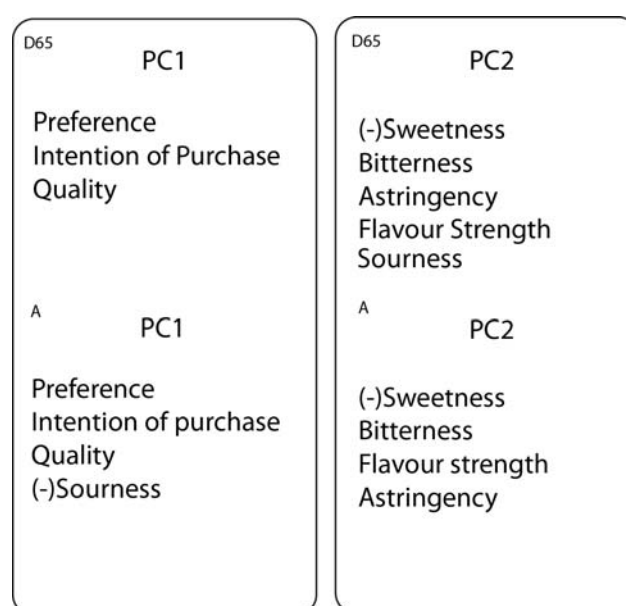

Figure 4-9 Summary of underlying factor for the unexpert group.

From the results of factor analysis, it was found that eight expectation scales could be reduced to either two or three scales. The scales that were in the same component had mutual relationships with the same factor. The first component contained the expectation scales that related to observers' preference, while the other components contained the scales that related to flavor strength or tastes. Further analyses were carried out to investigate whether the underlying factors were colours values.

4.2.3.3 Relationships between factor scores and colour values in expert group.

To identify colour values in relation to image samples as latent variables, factor scores were calculated by multiplying the case's standardized score on each variable by the corresponding factor loading of the variable for the given factor, and summing these products. The relationships between the new factors for each image and colour value were then investigated.

The factor scores of each image were plotted against colour values that showed a tendency of having correlations with expectation scales (see Section 4.2.2.1). The results are shown in Figure 4-10.

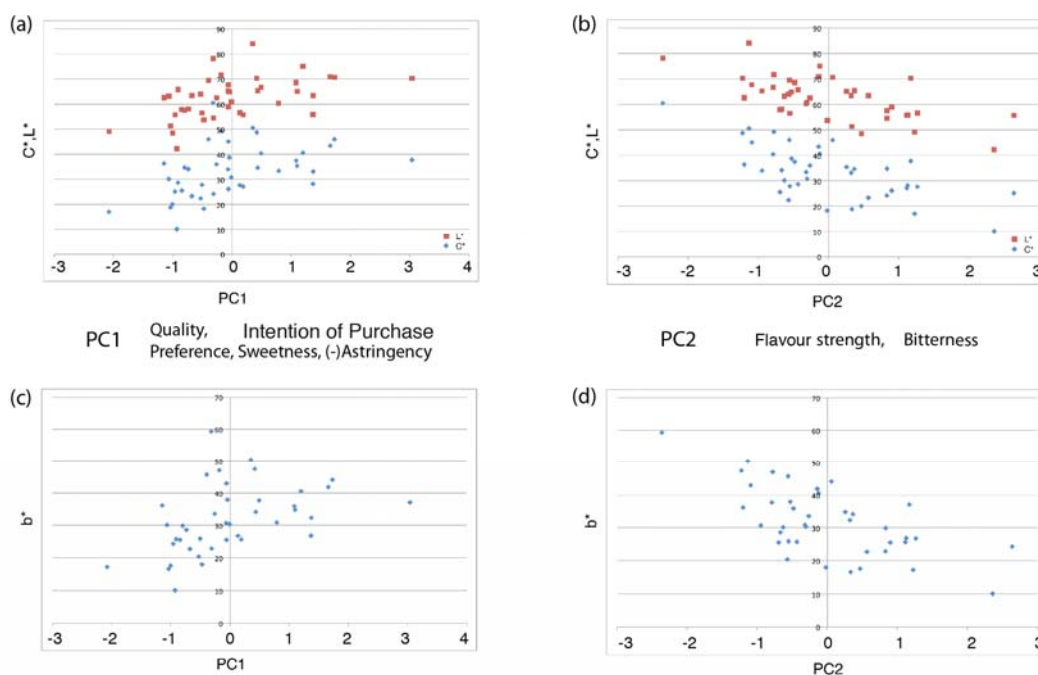

Figure 4-10 Scatter plots between factor scores of each component and colour values, for expert group under D65. (a) PC1 with chroma and lightness (b) PC2 with chroma and lightness (c) PC1 with b^* and (d) PC2 with b^*

Based on the results in this study, PC1 represented a preference dimension, including five variables: intention of purchase, preference, sweetness and astringency (inverse relationship). PC2 represented a flavour dimension, including two variables: flavour strength and bitterness. As mentioned above, each variable in the same dimension had mutual relationships. The results showed that PC1 tended to correlate with lightness and chroma, as when the factor scores became higher, the L^* and C^*_{ab} became higher as well. This means that the expert preferred somewhat light and high chroma espresso images. As for PC2, the relationships were found to be negative, revealing that when images had low lightness and chroma, the experts associated them with strong flavour and bitterness. In the case of b^* , it was found that the experts preferred espresso images having yellowish colour, and that they expected the taste to be less bitter.

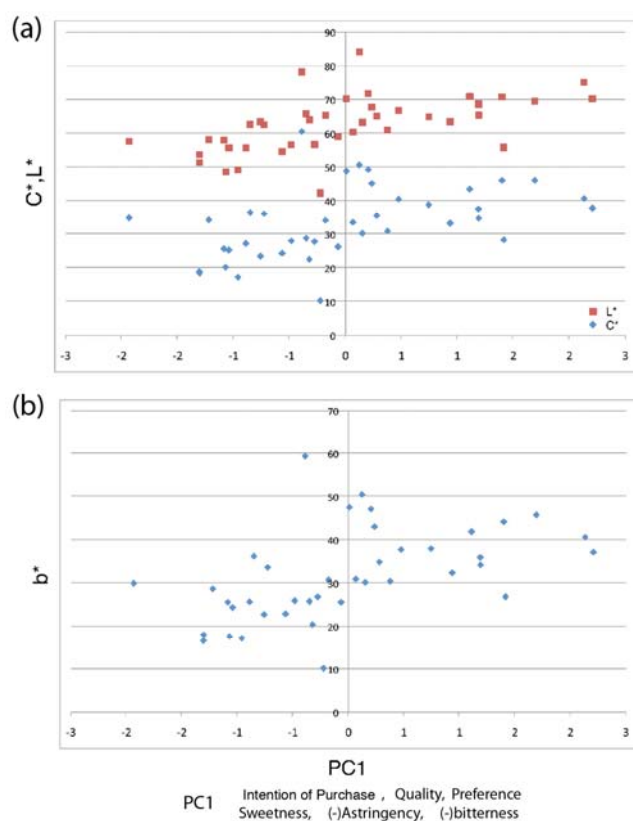





















Figure 4-11 Scatter plots between factor scores of PC1 and colour values for expert group under A. (a) PC1 with chroma and lightness (b) PC1 with b^*

Figure 4-11 shows the results for A condition. Only the relationships between PC1 (preference dimension) and colour values were investigated because PC2 had only one variable (sourness) and it accounted for only 17% of variance. The results for A were similar to those found for D65, in which the positive relationships were found for $L^*/C^*_{ab}/b^*$ and factor scores. This implies that the experts preferred espresso images with high lightness, chroma and yellowish. They associated these colours with quality.

The factor scores of each image represented the magnitudes of correlation between the image and dimension (factor). Hence, The factor scores of PC1 were rearranged in descending order to find the best five and the worst five images that the experts associated with preference and/or quality for both lighting conditions. These results are shown in Table 4-12.

The number in a parenthesis represents the sample number (Image No.1 to Image No.40). The results showed that the top five images were images with high lightness and yellowish, while the worst five images were images with dull colour. This could be because the experts associated the quality of espresso with its crema colour. For good quality espresso, the colour of crema should be hazel colour and its taste must not be too bitter. The similar results were found for both D65 and A. Note that the same sample (the same image number) appeared different under different light sources due to the colour of the light source. Thus, different image samples were ranked for D65 and A. Nevertheless, these image samples had similar colour appearance when viewed under different conditions. For example, Image No.39 was the second best for D65 and it had nearly identical CIELAB values to Image No.12 that was the second best for A. In other word, the expert gave the same rank to two images with the same colour appearance. This implies that regardless of lighting conditions, the espresso images should have lightness, chroma and yellowish for the experts to like.

Table 4-12 Top five best and worst image samples for expert group.

D65			A		
Sample	L* a* b* C* _{ab}	PC1 Score	Sample	L* a* b* C* _{ab}	PC1 Score
	L* 70.17 a* 7.34 b* 37.04 C* _{ab} 37.76	3.04 (38)		L* 71.2 a* 16.09 b* 39.74 C* _{ab} 42.88	2.21 (38)
	L* 70.61 a* 13.06 b* 44.06 C* _{ab} 45.96	1.73 (39)		L* 75.76 a* 13.07 b* 41.58 C* _{ab} 43.58	2.14 (12)
	L* 70.08 a* 11.7 b* 41.79 C* _{ab} 43.4	1.66 (15)		L* 69.98 a* 15.49 b* 47.69 C* _{ab} 50.15	1.69 (7)
	L* 63.32 a* 7.35 b* 32.3 C* _{ab} 33.12	1.37 (35)		L* 63.32 a* 7.35 b* 32.3 C* _{ab} 34.99	1.42 (7)
	L* 55.75 a* 9.03 b* 26.74 C* _{ab} 28.22	1.37 (7)		L* 56.35 a* 16.22 b* 31.01 C* _{ab} 53.14	1.40 (39)
	L* 48.5 a* 9.9 b* 17.48 C* _{ab} 20.08	-1 (5)		L* 50.95 a* 9.64 b* 26.59 C* _{ab} 28.29	-1.09 (36)
	L* 51.22 a* 9.29 b* 16.42 C* _{ab} 18.86	-1.03 (25)		L* 59.92 a* 24.82 b* 35.87 C* _{ab} 43.62	-1.22 (30)
	L* 63.18 a* 2.76 b* 30.03 C* _{ab} 30.16	-1.06 (11)		L* 53.34 a* 10.05 b* 19.7 C* _{ab} 22.11	-1.3 (37)
	L* 62.57 a* 4.26 b* 36.1 C* _{ab} 36.35	-1.15 (24)		L* 50.56 a* 14.45 b* 20.16 C* _{ab} 24.8	-1.3 (25)
	L* 40.08 a* 1.17 b* 17.06 C* _{ab} 17.1	-2.08 (6)		L* 60.39 a* 24.55 b* 37.69 C* _{ab} 49.98	-1.93 (10)

4.2.3.4 Relationship between factor scores and colour values in unexpert

group.

In this section, relationships between the factor scores of each image and colour values in unexpert group are presented. Since no correlation was found between PC1 (preference dimension and any colour values, the scatter plots are not shown here. Hence, only factor scores of PC2 plotting with chroma, lightness and b^* are shown in Figure 4-12.

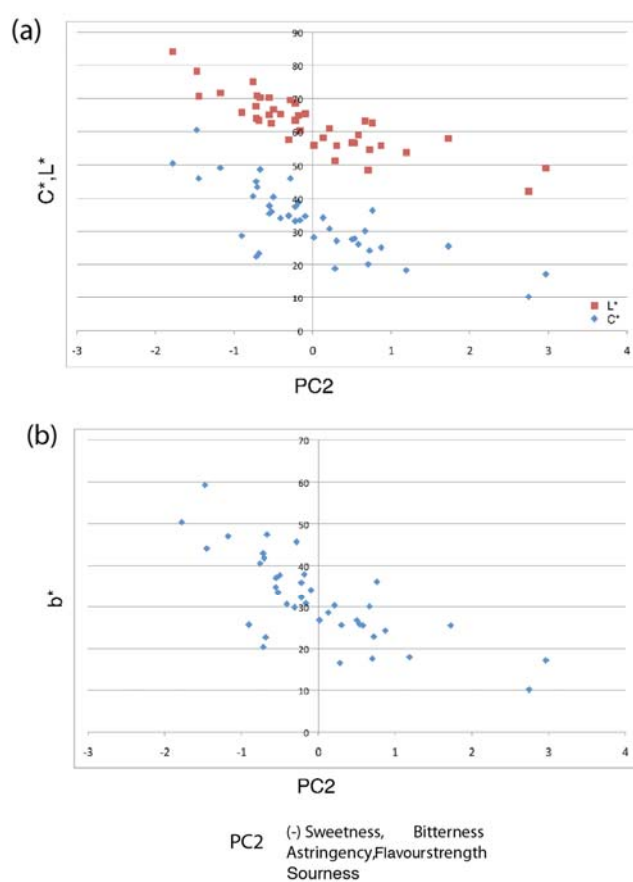

Figure 4-12 Scatter plots between factor scores of PC2 and chroma, lightness, b^* plan of unexpert group under D65 simulators. (a) PC2 with chroma and lightness (b) PC2 with b^* plan

In the case of unexpert group, under D65 simulators, PC2 represented a flavour dimension including four variables: sweetness, bitterness, astringency, and sourness. From Figure 4-12, each variable in the same dimension had mutual relationships. The negative relationships were found between lightness/chroma and tastes, revealing that when images had low lightness and chroma, the unexperts associated them with strong flavour, bitterness and astringency but not sweet. In the case of b^* , it was found that they associated yellowish colour with sweetness.

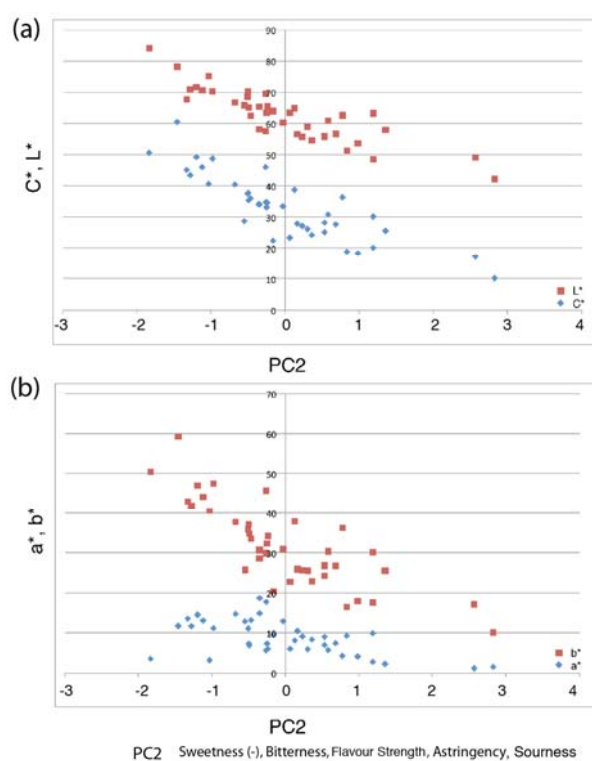

Figure 4-13 Scatter plots between factor scores of PC2 and chroma, lightness and a^* , b^* plan of unexpert group under A illuminant. (a) PC2 with chroma and lightness (b) PC2 with b^* plan.

Figure 4-13 shows the results for A condition, only the relationships between PC2 (flavour dimension) are presented. The results showed that when the factor scores became lower, the L^* and C^*_{ab} became higher. This means the unexperts associated high lightness and chroma with sweetness and not bitterness, flavour strength and not astringency. In the case of a^* and b^* , it was found that the unexpert associated yellowish and reddish colour of coffee with sweetness.

The factor scores of PC1 were rearranged in descending order to find the best five and the worst five images that the unexperts associated with preference and/or quality. These results are shown in Table 4-13.

Table 4-13 Top five best and worst image samples for unexpert group.





















D65			A		
Sample	L^* a^* b^* C^*_{ab}	PC1 Score	Sample	L^* a^* b^* C^*_{ab}	PC1 Score
	L^* 65.37 a^* 6.06 b^* 34.08 C^*_{ab} 34.62	1.69 (13)		L^* 54.39 a^* 14.81 b^* 25.81 C^*_{ab} 29.75	1.59 (40)
	L^* 60.09 a^* 5.75 b^* 30.3 C^*_{ab} 30.84	1.52 (27)		L^* 64.83 a^* 15.67 b^* 35.81 C^*_{ab} 39.09	1.55 (35)
	L^* 56.54 a^* 7.44 b^* 26.69 C^*_{ab} 27.71	1.29 (1)		L^* 64.73 a^* 14.4 b^* 36.11 C^*_{ab} 38.87	1.44 (13)
	L^* 55.75 a^* 9.03 b^* 26.74 C^*_{ab} 28.22	1.24 (7)		L^* 55.75 a^* 16.04 b^* 29.61 C^*_{ab} 33.67	1.4 (34)
	L^* 55.62 a^* 9.13 b^* 25.57 C^*_{ab} 27.15	1.22 (34)		L^* 55.27 a^* 13.79 b^* 27.29 C^*_{ab} 30.58	1.25 (18)

Table 4-13 (cont.)

D65			A		
Sample	L* a* b* C* _{ab}	PC1 Score	Sample	L* a* b* C* _{ab}	PC1 Score
	L* 84.07 a* 3.55 b* 50.41 C* _{ab} 50.53	-1.42 (31)		L* 60.39 a* 24.55 b* 37.69 C* _{ab} 44.98	-1.44 (10)
	L* 58.07 a* 18.69 b* 28.56 C* _{ab} 34.14	-1.46 (30)		L* 47.48 a* 6.91 b* 17.94 C* _{ab} 19.22	-1.58 (6)
	L* 70.24 a* 11.17 b* 47.41 C* _{ab} 48.71	-1.54 (28)		L* 72.87 a* 23.32 b* 51.7 C* _{ab} 56.71	-1.68 (23)
	L* 49.08 a* 1.17 b* 17.06 C* _{ab} 17.1	-1.69 (6)		L* 59.92 a* 24.82 b* 35.87 C* _{ab} 43.62	-1.71 (30)
	L* 78.1 a* 11.75 b* 59.31 C* _{ab} 60.46	-1.99 (9)		L* 80.01 a* 22.28 b* 63.04 C* _{ab} 66.86	-1.8 (9)

The results showed that the worst five images were images with high lightness, chroma and yellowish, while the best five images were images with lower lightness and chroma than the worst five images. The unexperts associated the preference, intention of purchase and quality of espresso with low chroma. In A condition, the worst five images were images with high chroma and reddish. This indicated that the unexperts disliked the espresso coffee if its colour tendency was to reddish colour. It should be noted that the experts and unexperts preferred different colours of espresso images. While the top five favourite colours of the experts were high lightness and yellowish, the unexperts thought they were the worst and preferred lower lightness and chroma instead. It is possible that

while the experts looked for the crema colour of espresso, which is supposed to be hazel colour, the unexperts considered espresso as black coffee (no sugar, milk, or cream added) and therefore looked for black or dark colour, resulting in different results between two observers group.

CHAPTER V

CONCLUSIONS

5.1 Conclusions

This study investigated associations between the colour of coffee in print media and consumer expectations and investigated the colour of coffee that observers most preferred under two lighting conditions (D65 and A). Observers assessed 40 printed images presented in a viewing cabinet in a darkroom. A rating scale ranging from 1-9 was applied to each expectation, where 1 indicates not having very much of that expectations (for example, not very sweet); 9 indicates having very much of that expectation (for example, very sweet); 5 is neutral. Forty observers, including 10 coffee experts and 30 unexperts, took part in visual experiments. The visual results were analysed to find relationship between two sets of data (eight expectations and colorimetric values, and each of the expectations scales against one another). The paired t-test was applied to investigate differences between two lighting conditions and two observer groups.

The colorimetric values of colour of coffee in printed samples were measured with a spectroradiometer under two lighting conditions in terms of xyY and spectral data. The results showed that the same image samples had different colour appearance under different conditions. When the image samples were viewed under D65, the colours spread out in green direction, while under A they shifted towards yellow colours. It was also found that colours of 40 samples under A were more similar to one another than those viewed under D65. The comparison between visual results obtained from the experts and unexperts showed that the experts gave significantly different expectations from the unexperts under

both lighting conditions, with exceptions of quality, intention of purchase and bitterness under A. Moreover, the experts showed no significant differences in flavour strength, sweetness, sourness and astringency between two lighting conditions. On the other hand, the unexperts showed no significant difference only in flavour strength between D65 and A.

The colorimetric values (C_{ab}^* , L^* , a^* and b^*) were paired with eight expectations (preference, intention of purchase, quality, flavour strength and 4 tastes) to investigate their relationships. It was found that chroma and lightness correlated with flavour strength and bitterness in two lighting conditions for the unexpert group. It means when coffee became dark and less chromatic, the unexperts associated them with strong flavour and having bitter taste. Positive correlations between chroma/lightness and sweetness were also found. When the coffee colours were lighter and more chromatic, they expected the coffee to be sweeter. On the other hand, the experts showed negative correlations between chroma/lightness (only in D65). They also positively correlated chroma/lightness with sweetness. The results also indicated that the experts would buy espresso coffee if the colour was high in chroma. Moreover, in the expert group when the coffee colours were less yellow, the unexperts thought the coffee to be strong in flavour and bitter. When the coffee became yellowish, they expected the coffee to be sweet. Similarly, the experts thought that coffee was bitter when its colour was less yellowish.

In the case of correlating between eight expectation scales, correlations between preference, intention of purchase and quality were found for D65. Intention of purchase, correlated with quality for two observer groups and two lighting conditions.

Factor analysis was employed to find the underlying factor in two lighting conditions and two groups of observers. The underlying factor in expert group in the preference dimension (PC1) comprised of five variables: preference, intention of purchase, quality, sweetness and astringency (inverse relationship) in D65. In A, the preference dimension included all variables found in D65 with inclusion of bitterness (inverse relationship). The underlying factor in unexpert group under D65 shows only preference, intention of purchase and quality. In A, PC1 comprised preference, intention of purchase, quality and sourness (inverse relationship). The PC2 can be called a taste dimension. In PC2 of the experts and unexperts comprised component of taste expectations.

The factor scores of each image from all expectations showed that under D65, the experts preferred somewhat light and high chroma espresso images and they associated these colours with strong flavour and bitterness. Moreover, the experts preferred espresso images having yellowish colour and they expected the taste to be less bitter. They also associated these colours with quality. The results for A condition were similar to those found for D65, in which the experts preferred espresso images with high lightness, chroma and yellowish. The best five images were images with high lightness and yellowish, while the worst five images were images with dull colour. This could be because the experts associated the quality of espresso with its crema colour.

In the case of unexpert group, under D65, the negative relationships were found between lightness/chroma and flavour strength bitterness/astringency, revealing that when images had low lightness and chroma, the unexperts associated them with strong flavour, bitterness and astringency but not sweet. They associated yellowish colour with sweetness. For A condition, they associated lightness and chroma with sweetness and not bitterness, flavour strength and not astringency, and yellowish and reddish colour with sweetness. The worst five images were images with high lightness, chroma and yellowish, as opposed to the results found in expert group that high lightness, chroma and yellowish images were preferred. The unexperts associated preference, intention of purchase and quality of

espresso with low chroma. In the case of A condition, the worst five images had higher chroma and more reddish than the best five images. It indicated that the unexperts disliked the espresso coffee if its colour tended to be.

5.2 Suggestion

This study investigated relationships between colour of coffee in print media. The factors in this experiments are lighting conditions (D65 and A) and observers (expert and unexpert). Normally, There are many factors that affect colour perception, such as printing substrate (glossy paper, plastic), culture, observers. preference and experience. Consequently, future study could focus on the other factors.

REFERENCES

- [1] Saenz, C., Hernandez, B. and Beriain, M. J., Meat color in retail displays with fluorescent illumination. Color research and application. 30 (August 2005):304 – 31
- [2] Rossi, M., Rizzi, A., Color temperature variation for food lighting: A test on user preference. AIC 2010 Color and Food, Interim Meeting of the International Color Association - Proceeding. pp.310-313. Mar del Plata: Argentina, 2010.
- [3] Huchting, J. Food color and appearance. 2nd. Marryland: An espen Publication, 1999.
- [4] Piggott, J. Sensory analysys of foods. London: Elsevier applied science publishers, 1995.
- [5] Leon, K., Mery, D., Pedreschi, F. and Leon, J., Color measurement in L*a*b* unit from RGB digital images. Food research International. 39 (March 2006):1084-1091
- [6] Yonemaru, Y., Panyarjun, O., Kitaguchi, S., Kitani, Y. and Sato, T. Influence of package colour for mineral water plastic bottle to consumer's purchase motivation. AIC 2010 Color and Food, Interim Meeting of the International Color Association - Proceeding. pp.266-269. Mar del Plata: Argentina, 2010.
- [7] Café Britt. Perfect Espresso. [Online]. 2009. Available from:
<http://www.cafebritt.com/how-to-make-the-perfect-espresso> [2010,September 10]
- [8] Coffee Research Institute. Espresso. [Online]. Available from:
<http://www.coffeeresearch.org/espresso/potential.html> [2010,September 10]
- [9] Kainoa. Why Espresso Coffee Is Different. [Online]. Available from:
<http://www.easy-coffee-recipes.com/espresso-coffee.html> [2010,September 10]

- [10] Lameen. Tag Archives:crema. [Online]. 2009. Available from:
<http://fromcoffeewithlove.wordpress.com/tag/crema/> [2010,September 10]
- [11] Home-barista. Barista Technique: Good Extraction, Good Espresso. [Online].
Available from: <http://www.home-barista.com/espresso-guide-good-extractions.html>
[2010,September 10]
- [12] Berns, R. principle of colour tech. 3rd. New York: A Wiley-Interscience Publication, 2001.
- [13] Fraser, B., Murphy, C. and Bunting, F. colour management. California: Peachpit Press.
2003.
- [14] A. Stockman, D. I. A. MacLeod, and N. E. Johnson, Spectral sensitivities of the human
cones, *J. Opt. Soc. Am. A* 10 (1993): 2491-2521.
- [15] Hunt, R.W.G. Measuring colour. 2nd. London: Ellis Horwood Limited, 1992.
- [16] CIE No, 17.4, International Lighting Vocabulary, 4th (Joint publication IEC/CIE), 1987.
- [17] Villar, I., Enjoying food under a new light. AIC 2010 Color and Food,
Interim Meeting of the International Color Association - Proceeding. pp.206-208.
Mar del Plata: Argentina, 2010.
- [18] Adoniscik. Standard illuminant. [Online] 2008. Available from:
http://en.wikipedia.org/wiki/Standard_illuminant [2010, September 21]
- [19] Ford, A. and Roberts, A Color Space Conversions [online]. 1998. Available from:
<http://www.poynton.com/PDFs/coloureq.pdf> [2010, September 18]
- [20] Jacobolus. Lab color space. [Online]. 2010. Available from:
http://en.wikipedia.org/wiki/Lab_color_space [2010, September 18]
- [21] MacDougall, D. Colour in food. New York: CRC press, 1990.
- [22] Westland, S. and Ripamonti, C. Computational colour science. London: John Wiley
& Sons Ltd, 2004.

- [23] Gonzalez., R. Woods. and R. Eddins., S. Digital Image Processing. Massachusetts: Pearson Prentice Hall, 2004.
- [24] Dicklyon. colour model. [Online]. 2011. Available from:
http://en.wikipedia.org/wiki/RGB_color_model#Color_depth [2011, September 8]
- [25] Idlastro. Indexed and RGB Image Organization. [Online]. 2007. Available from:
http://idlastro.gsfc.nasa.gov/idl_html_help/Indexed_and_RGB_Image_Organization.html [2010, September 14]
- [26] Umbaugh., S. Computer imaging digital image analysis and processing. Florida: CRC press, 2005.
- [27] Edward, J. Giorgianni and Thomas E. Madden, Digital Color Management—Encoding Solutions, Color research and application. 5 (October 1998): 341-345.
- [28] Shaw, M., Shama, G., Bala, R. and Dala, E. Color Printer Characterization Adjustment for Difference Substrates. Color research and application. 6 (December 2003): 454 – 467.
- [29] Kang, 1994; Johnson, 1996 color mixing models to electronic printing Journal of Electronic Imaging, 3, 276-287.
- [30] Johnson, Method for characterizing colour printers, Displays, 16, 193- 202 1996.
- [31] Spitzak, sRGB. [Online]. 2010. Available from:
http://en.wikipedia.org/wiki/SRGB#The_forward_transformation.28CIE_xyY_or_CIE_XYZ_to_sRGB.29 [2010, June 6]
- [32] Stokes., M. Anderson., M. Chandrasekar. and S. Motta., R. A Standard Default Color Space for the Internet - sRGB. [Online]. 1996 Available from:
<http://www.w3.org/Graphics/Color/sRGB.html> [2010, March 6]

- [33] Wei, S., Ou, L., Luo, M., The association between package colour and consumer expectations: Taking juice package design as an example. Association Internationale de la Couleur (AIC). Interim Meeting in Stockholm, Conference Theme: Colour - Effects & Affects. pp.15-18. Stockholm: 2008.
- [34] Fernandez-Vazquez, R., Stinco, C., Melendez-Martinez, F., Heredia, F. and Vicario, I., Orange juice colour: visual evaluation and consumer preference. AIC 2010 Color and Food, Interim Meeting of the International Color Association - Proceeding. pp.357-359. Mar del Plata: Argentina, 2010.
- [35] Wei, S., Ou, L., Luo, M., Hutchings, J., Quantification of the relation between juice colour and consumer expectations. Proceedings of the 11th Congress of the Association Internationale de la Couleur (AIC). Sydney: Australia 2009.
- [36] Tang, X., Kälviäinen, N. and Tuorila, H., Sensory and hedonic characteristics of juice of seabuckthorn (*Hippophae rhamnoides* L.) origins and hybrids. Lebensm.-Wiss. u.-Technol 34 (February 2001):102-110.
- [37] Sueeprasan, S., Traisiwaku, C., Colour evaluation of greentea drinks by Thai observers. AIC 2010 Color and Food, Interim Meeting of the International Color Association - Proceeding. pp.154-157. Mar del Plata: Argentina, 2010.

Appendices

Appendix A

The colour values of image samples

Table A-1 : The colour values (L^* , a^* , b^* , C^*_{ab} , h_{ab}) of 40 image samples in two conditions (D65 and A).

No.	D65					A				
	L^*	a^*	b^*	C^*_{ab}	h_{ab}	L^*	a^*	b^*	C^*_{ab}	h_{ab}
1	56.54	7.44	26.69	27.71	74.4	56.54	14.7	29.51	32.96	63.5
2	63.33	6.02	22.59	23.38	75.1	63.79	12.71	24.8	27.87	62.9
3	56.4	10.51	25.82	27.88	67.9	57.07	17.35	30.17	34.8	60.1
4	65.05	6.88	34.77	35.44	78.8	65.88	15.45	37.66	40.7	67.7
5	48.5	9.9	17.48	20.08	60.5	48.49	15.42	21.66	26.59	54.6
6	49.08	1.17	17.06	17.1	86.1	47.48	6.91	17.94	19.22	68.9
7	55.75	9.03	26.74	28.22	71.3	56.35	16.22	31.01	34.99	62.4
8	67.58	13.54	42.94	45.03	72.5	69.45	22.26	48.22	53.11	65.2
9	78.1	11.75	59.31	60.46	78.8	80.01	22.28	63.04	66.86	70.5
10	57.46	17.73	29.86	34.72	59.3	60.39	24.55	37.69	44.98	56.9
11	63.18	2.76	30.03	30.16	84.7	63.04	10.96	31.45	33.3	70.8
12	75.08	3.17	40.51	40.63	85.5	75.76	13.07	41.58	43.58	72.6
13	65.37	6.06	34.08	34.62	79.9	64.73	14.4	36.11	38.87	68.3
14	62.39	13.19	33.51	36.01	68.5	63.58	20.78	38.66	43.89	61.7
15	70.78	11.7	41.79	43.4	74.4	72.65	20.55	46.06	50.43	66.0
16	66.64	14.73	37.64	40.42	68.6	68.24	22.57	42.93	48.5	62.3
17	69.49	5.61	45.66	46	83.0	69.98	15.49	47.69	50.15	72.0
18	55.69	6.97	24.2	25.18	73.9	55.27	13.79	27.29	30.58	63.2
19	65.75	12.87	25.63	28.68	63.3	66.5	19.23	30.11	35.73	57.4
20	63.95	9.57	20.29	22.44	64.7	64.44	15.37	23.57	28.14	56.9
21	65.26	14.87	30.62	34.04	64.1	66.61	21.78	35.89	41.99	58.7
22	42.22	1.55	10.08	10.2	81.3	39.21	5.27	10.2	11.48	62.7
23	71.61	14.53	47.02	49.21	72.8	72.87	23.32	51.7	56.71	65.7
24	62.57	4.26	36.1	36.35	83.3	62.79	13.12	38.34	40.53	71.1
25	51.22	9.29	16.42	18.86	60.5	50.56	14.45	20.16	24.8	54.4
26	64.83	8.13	37.88	38.74	77.9	65.57	16.93	41.4	44.72	67.8
27	60.9	5.75	30.3	30.84	79.3	59.95	13.56	32.45	35.17	67.3
28	70.24	11.17	47.41	48.71	76.7	71.83	20.52	51.65	55.58	68.3
28	60.31	12.91	30.83	33.42	67.3	61.51	20.19	36.02	41.3	60.7
30	58.07	18.69	28.56	34.14	56.8	59.92	24.82	35.87	43.62	55.3
31	84.07	3.55	50.41	50.53	86.0	84.27	14.66	50.58	52.66	73.8
32	58.85	5.94	25.46	26.14	76.9	58.85	13.25	28.35	31.29	64.9
33	68.55	11.09	35.82	37.5	72.8	69.95	19.33	39.82	44.27	64.1
34	55.62	9.13	25.57	27.15	70.4	55.75	16.04	29.61	33.67	61.6
35	63.32	7.35	32.3	33.12	77.2	64.83	15.67	35.81	39.09	66.4
36	57.85	2.28	25.45	25.55	84.9	56.95	9.64	26.59	28.29	70.1
37	53.67	4.14	17.83	18.31	76.9	53.34	10.05	19.7	22.11	63.0
38	70.17	7.34	37.04	37.76	78.8	71.2	16.09	39.74	42.88	68.0
39	70.61	13.06	44.06	45.96	73.5	72.07	21.83	48.45	53.14	65.7
40	54.44	8.36	22.73	24.22	69.8	54.39	14.81	25.81	29.75	60.2

Appendix B

The factor scores of 40 image samples

Tabel B-1: Factor scores of 40 images samples in two conditions (D65 and A) of expert group with the number of images rearranged (No. 4 is the original image taken from freshly-brewed espresso without colour adjustment).

D65						A					
No.	PC1	No.	PC2	No.	PC3	No.	PC1	No.	PC2	No.	PC3
38	3.04	18	2.64	7	2.18	38	2.21	6	1.86	22	2.64
39	1.73	22	2.36	10	1.78	12	2.14	11	1.85	36	1.97
15	1.66	1	1.26	9	1.70	17	1.69	39	1.64	18	1.87
35	1.37	6	1.23	11	1.59	7	1.42	8	1.38	32	1.66
7	1.37	38	1.17	3	1.53	39	1.40	22	1.35	5	1.02
12	1.20	7	1.13	6	1.46	13	1.19	32	1.26	27	0.98
4	1.10	34	1.11	39	1.15	33	1.19	9	1.16	29	0.85
33	1.09	32	0.90	15	0.88	15	1.11	28	1.13	40	0.75
29	0.79	10	0.83	8	0.85	35	0.94	7	1.13	13	0.52
16	0.49	40	0.83	17	0.77	26	0.75	30	0.88	17	0.50
13	0.44	2	0.57	16	0.72	16	0.48	36	0.73	12	0.49
28	0.42	5	0.47	14	0.64	27	0.38	37	0.69	38	0.49
31	0.35	13	0.37	1	0.40	4	0.28	23	0.68	37	0.49
34	0.19	25	0.33	26	0.35	8	0.24	31	0.52	20	0.48
1	0.13	35	0.32	2	0.30	23	0.21	29	0.34	15	0.29
27	-0.01	4	0.25	38	0.28	11	0.15	17	0.29	34	0.26
26	-0.04	39	0.06	23	0.28	31	0.12	40	0.20	6	0.13
32	-0.06	37	-0.02	40	0.12	29	0.07	13	0.11	30	0.09
8	-0.06	12	-0.12	5	-0.17	28	0.01	1	0.07	33	0.06
21	-0.07	15	-0.14	32	-0.23	32	-0.06	16	-0.09	7	0.03
23	-0.18	14	-0.26	22	-0.32	21	-0.18	26	-0.09	24	0.01
14	-0.26	27	-0.31	24	-0.38	22	-0.22	34	-0.35	35	-0.03
40	-0.31	29	-0.32	27	-0.49	1	-0.28	27	-0.37	16	-0.14
9	-0.32	19	-0.43	18	-0.50	20	-0.32	21	-0.46	4	-0.22
17	-0.39	33	-0.48	4	-0.58	19	-0.35	20	-0.61	1	-0.22
37	-0.47	26	-0.53	12	-0.64	9	-0.39	2	-0.63	39	-0.45
3	-0.50	3	-0.55	31	-0.65	3	-0.48	24	-0.64	10	-0.53
20	-0.53	17	-0.56	36	-0.67	40	-0.57	3	-0.78	11	-0.59
2	-0.68	20	-0.57	30	-0.73	14	-0.73	25	-0.87	26	-0.65
30	-0.74	11	-0.63	34	-0.76	2	-0.76	5	-0.88	25	-0.78
10	-0.80	30	-0.67	21	-0.80	24	-0.85	10	-0.95	2	-0.92
36	-0.84	36	-0.69	35	-0.82	34	-0.89	15	-0.97	23	-0.98
19	-0.91	23	-0.78	33	-0.83	6	-0.96	19	-1.05	21	-0.99
22	-0.93	16	-0.79	20	-0.90	18	-1.04	12	-1.06	14	-1.01
18	-0.96	21	-0.95	19	-0.94	5	-1.07	38	-1.07	9	-1.18
5	-1.00	8	-1.09	37	-1.05	36	-1.09	35	-1.14	19	-1.20
25	-1.03	31	-1.13	29	-1.14	30	-1.22	33	-1.15	28	-1.25
11	-1.06	24	-1.20	28	-1.21	37	-1.30	4	-1.21	3	-1.35
24	-1.15	28	-1.23	13	-1.25	25	-1.30	14	-1.24	31	-1.37
6	-2.08	9	-2.36	25	-1.92	10	-1.9	18	.65	8	-1.74

Tabel B-2: Factor scores of 40 images samples in two conditions (D65 and A) of unexpert group with the number of images rearranged (No. 4 is the original image taken from freshly-brewed espresso without colour adjustment).

D65				A			
No.	PC1	No.	PC2	No.	PC1	No.	PC2
13	1.69	6	2.97	40	1.59	22	2.83
27	1.52	22	2.75	35	1.55	6	2.57
1	1.29	36	1.73	13	1.44	36	1.36
7	1.24	37	1.19	34	1.40	5	1.19
34	1.22	18	0.88	18	1.25	11	1.19
40	1.20	24	0.77	4	1.18	37	0.98
4	0.98	40	0.73	1	1.09	25	0.83
32	0.97	5	0.71	32	1.06	24	0.77
35	0.89	11	0.67	27	1.02	1	0.68
38	0.81	32	0.59	29	0.71	27	0.58
18	0.81	3	0.54	37	0.66	18	0.53
2	0.74	1	0.51	38	0.62	7	0.53
33	0.66	34	0.31	20	0.60	40	0.36
15	0.61	25	0.29	7	0.49	32	0.30
37	0.60	27	0.22	25	0.48	34	0.23
12	0.46	30	0.13	12	0.44	3	0.16
29	0.42	7	0.02	2	0.43	26	0.13
25	0.38	13	-0.09	33	0.41	2	0.06
14	0.28	29	-0.16	26	0.26	29	-0.03
21	-0.01	26	-0.18	14	0.12	20	-0.16
5	-0.04	33	-0.22	3	0.12	13	-0.24
16	-0.05	35	-0.22	39	0.01	35	-0.25
39	-0.05	17	-0.28	15	-0.05	10	-0.26
20	-0.11	10	-0.30	19	-0.15	17	-0.26
19	-0.22	21	-0.41	31	-0.47	30	-0.35
3	-0.25	16	-0.50	36	-0.50	21	-0.35
11	-0.29	14	-0.52	21	-0.51	14	-0.46
26	-0.34	38	-0.55	17	-0.53	4	-0.49
10	-0.84	4	-0.55	16	-0.56	38	-0.50
8	-0.90	28	-0.67	28	-0.84	33	-0.51
22	-0.99	2	-0.68	8	-0.84	19	-0.55
36	-1.03	15	-0.70	5	-0.87	16	-0.68
24	-1.04	20	-0.71	11	-1.06	28	-0.98
23	-1.11	8	-0.72	24	-1.10	12	-1.03
17	-1.36	12	-0.76	22	-1.24	39	-1.12
31	-1.42	19	-0.90	10	-1.44	23	-1.19
30	-1.46	23	-1.17	6	-1.58	15	-1.28
28	-1.54	39	-1.45	23	-1.68	8	-1.33
6	-1.69	9	-1.47	30	-1.71	9	-1.46
9	-1.99	31	-1.78	9	-1.80	31	-1.83

VITA

Ms. Chutikarn Ongjarit was born on May 12, 1985 in Bangkok, Thailand. She received a Bachelor's Degree of Science in Cinematography and photography from the Faculty of Mass Communication, Rajamangala University of Technology Thanyaburi in 2007. She worked at Graphic design division, Itorama Co., Ltd. from 2007 to present. She entered the Department of Imaging and Printing Technology, Faculty of Science, the Graduate School, Chulalongkorn University in 2009.