

CHAPTER 2

MATERIALS AND METHODS

The experiments were carried out in 4 parts, as follows :

1. Development of experimental set-up for brain slice preparation. This part concerns with descriptions of construction of (1) an Oscillotome, (2) a hand-slicing apparatus, (3) a tissue bath, and (4) a simple perfusion system.

2. Methods of preparing cerebellar slices. This part describes steps in preparing the cerebellar vermis slices using the Oscillotome constructed in Part 1, as well as manual techniques.

3. Electrophysiological Studies. This part describes the techniques for making microelectrode, extracellular recording, and processing of spike data as well as the use of cerebellar slices in electrophysiological studies.

4. Application in Physiology and Pharmacology. This part concerned with the use of this preparation in some physiological and pharmacological studies by employing superfusion and microiontophoretic techniques.

1. Developmental Set Up of Brain Slice Preparation.

1.1 Oscillotome.

The Oscillotome was a laboratory tissue slicer which has been designed in this study, based on two basic principles employing in the vibrating blade tissue slicer, i.e. (1) the horizontal vibrating or sawing motion of the knife, and (2) the totally submerged sectioning in the cold oxygenated ACSF. The machine form consists physically of four main parts : a main box, an oscillator box, a sectioned bath, and a control box, as illustrated in Fig. 3.

The machine operates as follows. A cutting arm (CA) was oscillated in a horizontal plane by a linear oscillating motor (Mo ; modified from an electric shaver) and driven slowly by a unit of gear reduced DC motor (M1) either in a forward or backward direction, and a moving carriage (MC) located in the oscillator box (Fig. 4). The other end of the cutting arm was attached to by the stem of a blade holder (BH) which positions in the sectioned bath. The frequency of the oscillation could be adjusted between 30 and 35 /sec (or 1800 and 2100 rev/min) using the left slide control potentiometer (OSC), and the driving speed could be also adjusted between 0 and 3.5 mm/sec by the right slide control (Drive).

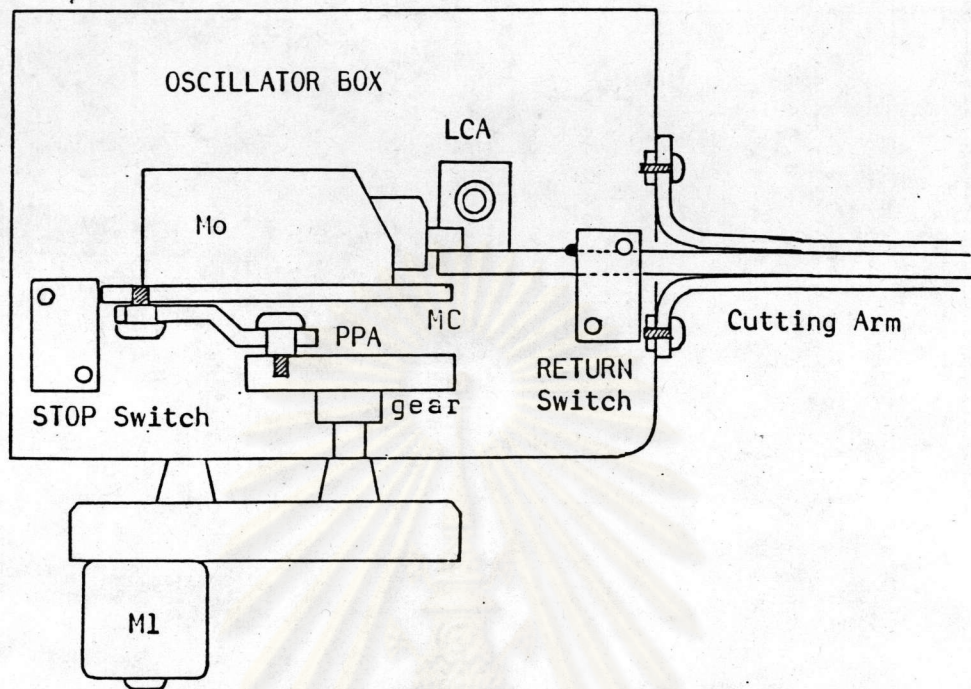

Fig. 4. Cross-sectioned diagram of the oscillator box showing the relation of interior components, which are : an oscillating motor (Mo), a moving carriage (MC), a linear oscillating controlled assembly (LCA), a push-pulled assembly (PPA), a microswitch 'RETURN' (RETURN), a microswitch 'STOP' (STOP) and a gear-reduced driving motor (M1).

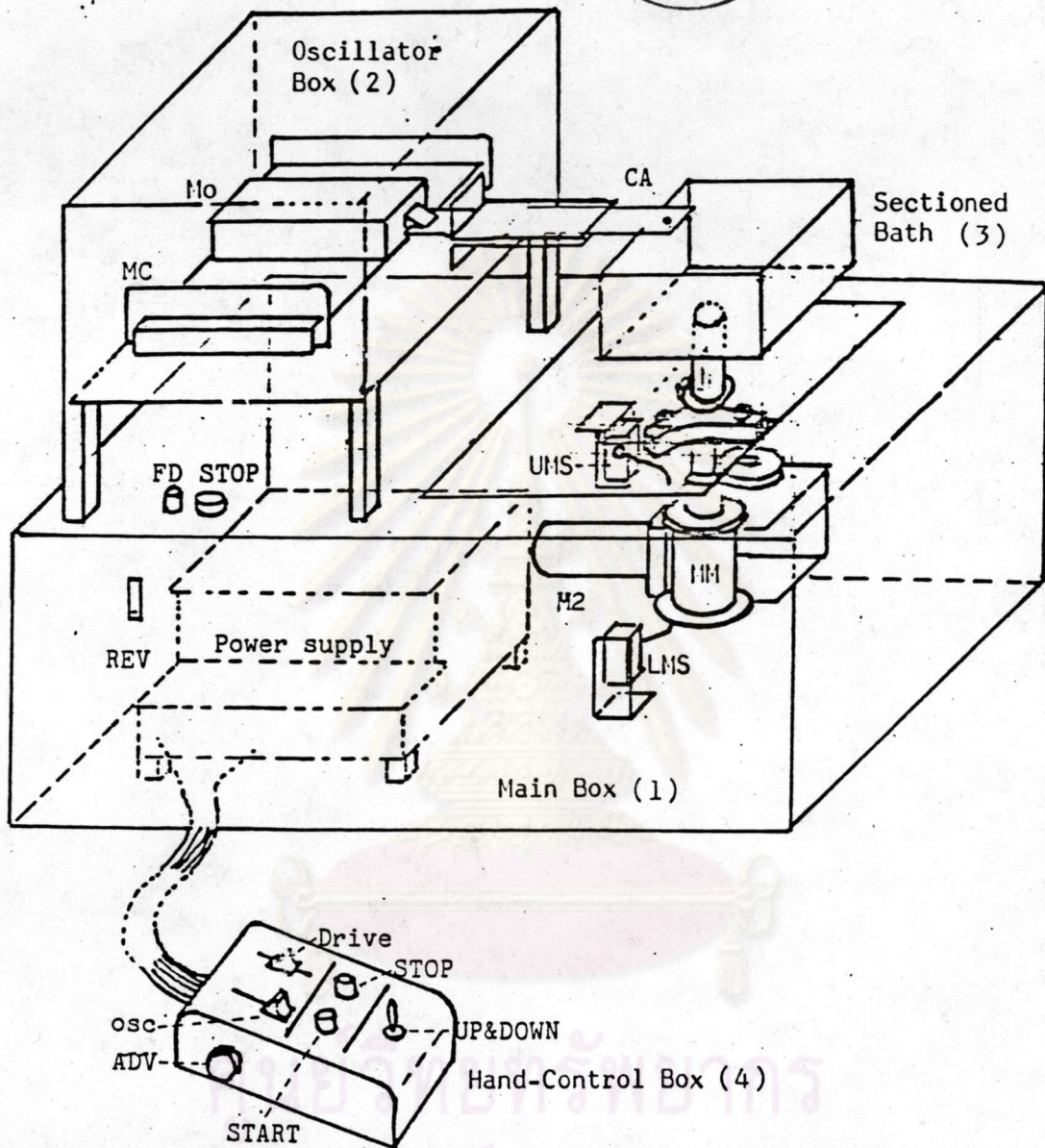

Fig. 3. Perspective diagram of the Oscillotome showing the four main components : (1) a main box, (2) an oscillator box, (3) a section bath and (4) a hand-control box.

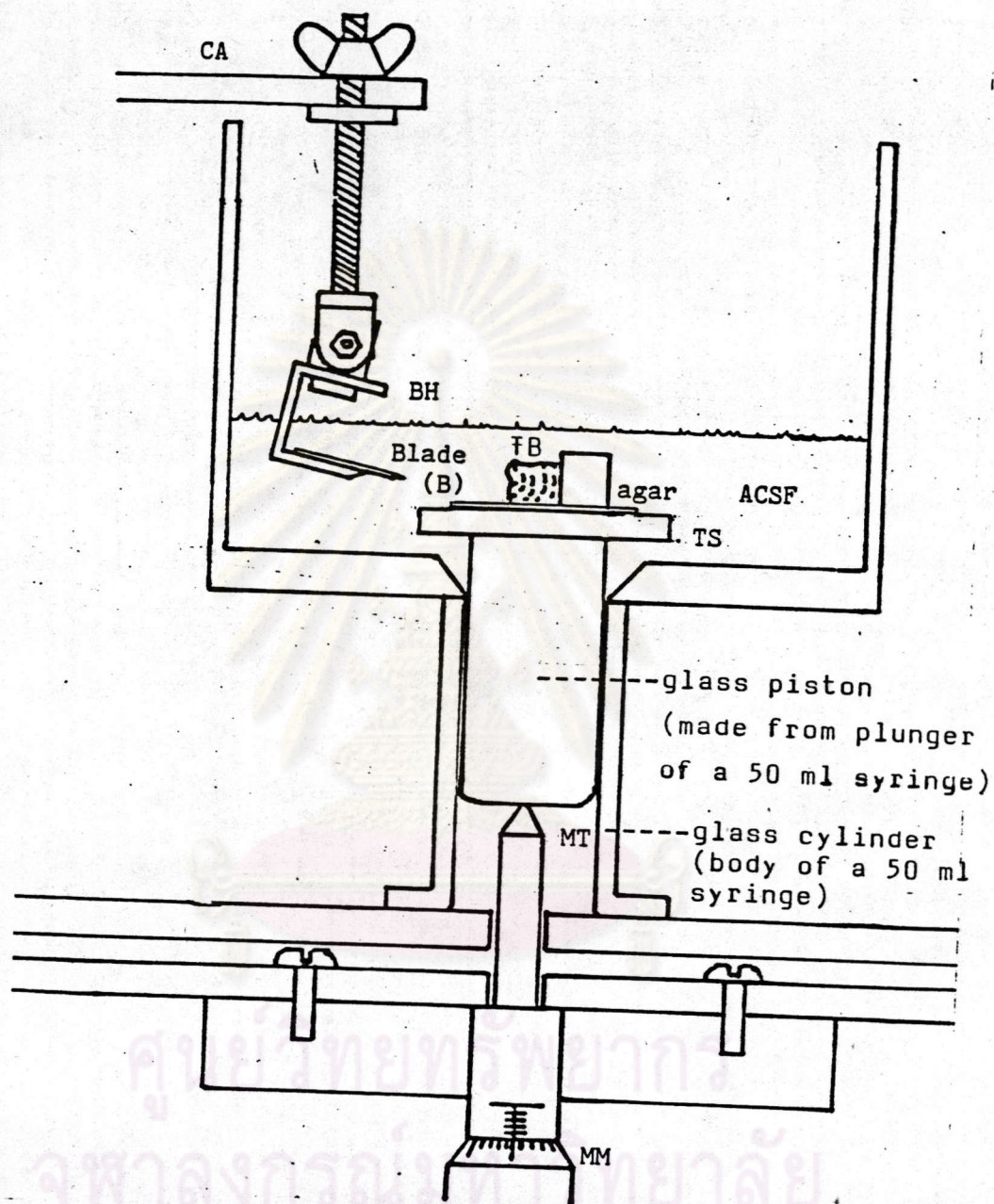

Fig. 5. Cross-Sectioned diagram of interior components of the section bath of the Oscillotome showing the relation of the blade (B), a tissue block (TB), and a tissue stage (TS). CA = cutting arm; BH = blade holder assembly; MT = tip of micrometer; MM = micro-meter.

In the 200 ml sectioned bath, a moving stage (MS) elevated by glass piston made from a 50 ml syringe, filled with mercury and covered with a piece of small plastic plate that fits into a glass tube made from a cylinder of the same syringe, has been designed for the effective prevention of water leakage from the bath (Fig. 5). The stage (MS) was moved vertically in a microns distance by means of a micrometer (MM) positioned below the piston. One revolution of the micrometer (MM) yields a 500 um displacement of the micrometer tip (MT) and also the stage (MS). The micrometer (MM) is driven by a driving DC motor (M2) via a rubber belt (RB). The motor (M2) was manually operated by using a two-way toggle switch, the UP&DOWN, on the control box. Additionally, to accelerate the movement of the stage (TS) the machine provides a fast-downward switch (FD - green) positioned on the main box below the oscillator box, a stop switch (STOP/RET - red), and a reverse switch (REV - toggle switch). A rapid falling of the stage (TS) was controlled by the fast-downward switch (FD), and, on the other hand, a rapid raising by the combination of the fast-downward switch (FD) and the reverse switch (REV). All of these quick motions could be interrupted by depressing the stop switch (STOP).

1.2 Hand-Slicing apparatus.

Materials and the apparatus needed for cutting the brain are described as follows (see also Fig. 6).

Blade. An available hair-cut razor blade such as Feather-Cut (Japan) with handle is used.

Glass Guide. The guide was made of two glass slides with dimension of $2.5 \times 7.5 \text{ cm}^2$ and has thickness of 1.0 mm. The slides were glued onto both sides of a small piece of Plexiglas ($1.5 \times 2.8 \times 1.8 \text{ cm}^3$) at the middle with separation 8 mm. The two parallel edges of the slides was used as a linear guide for the control of the sawing blade.

Tissue support. The whole cerebellum which was separated from the surrounding tissue is placed on a moist filter paper (Whatman no. 1, dia. 7 cm) supported with a square piece of polystyrene foam ($14 \times 14 \times 3 \text{ cm}^3$) and then fixed in place using two small pins (2.3 cm) that inserted at one hemisphere.

Dissecting microscope. The slicing should be performed carefully under a dissecting microscope which had a long working distance objective lens (x 0.5) and the sufficient illumination, using a low power magnification.



Fig. 6. Photograph showing the whole equipments used in hand-slicing technique. M = stereozoom dissecting microscope, G = a glass guide, HB = a razor blade, FB = a fine brush (no. 1), P = filter paper, F = foam, D = petri dish filled with ACSF (25°C), B = a small bowl filled with cold ACSF (2°-8°C).

1.3 Tissue Bath.

The slice bath used in this experiment was a submersion chamber. The bath was constructed of Plexiglas and had a dimension of 15 x 15 x 10 cm³. It consists of three main parts, an inner chamber, an outer chamber (OC), and a reservoir chamber (RC), as shown in Fig. 7.

The inner chamber was made of Plexiglas with a dimension of 5.0 x 4.5 x 1.5 cm³, and has a bubble trapping well (BTW) with a diameter of 1.2 cm that connected to an incubating chamber (IC). This well (BTW) is designed for trapping air bubbles that take place in the perfusion vessel and also reducing mechanical switching artifacts from the changing of solutions. At the inner chamber, the tissue specimens are held between two brass mesh (BM) which fits into the tissue incubating hole (IH).

The outer chamber had capacity about 900 ml provides ACSF at suitable temperature, 35°-37°C, perfusing into the chamber via small polyethylene tube (PE). The bath temperature was stabilized at 37°C by circulating warm water (38°C) through a heat exchange glass coil (GC) situated inside the outer chamber. The circulating water was prewarmed at (38°C) in a thermoregulator bath.

1.4 Perfusion system.

A gravity-feeding perfusion system has been designed by using low cost materials such as, a one liter hanging bottle (HB) connected to a flow control set (a microdrip chamber - MC), through which the ACSF flow was regulated by an adjustable clamp (Fig. 8). The medium was perfused at a constant rate of 2 to 2.5 ml/min through a small PE tube, prewarmed in outer chamber (OC) and pushed into the bubble trapping well (BTW) and then filling in the incubation chamber (IC). The excessive amount of the perfusate was pulled out of the chamber via a gauze wick (GW), and collected in the reservoir chamber (RC). Finally, the overflow of the perfusate was siphoned via the drainage tube (DT) into the collecting bottle (CB) located below the table.

A commercially available carbogen containing 95% O₂, 5% CO₂ (Thai Industrial Gas, TIG) was bubbled into the incubating medium through a pressure regulator valve.

ศูนย์วิทยุโทรพยากร
จุฬาลงกรณ์มหาวิทยาลัย

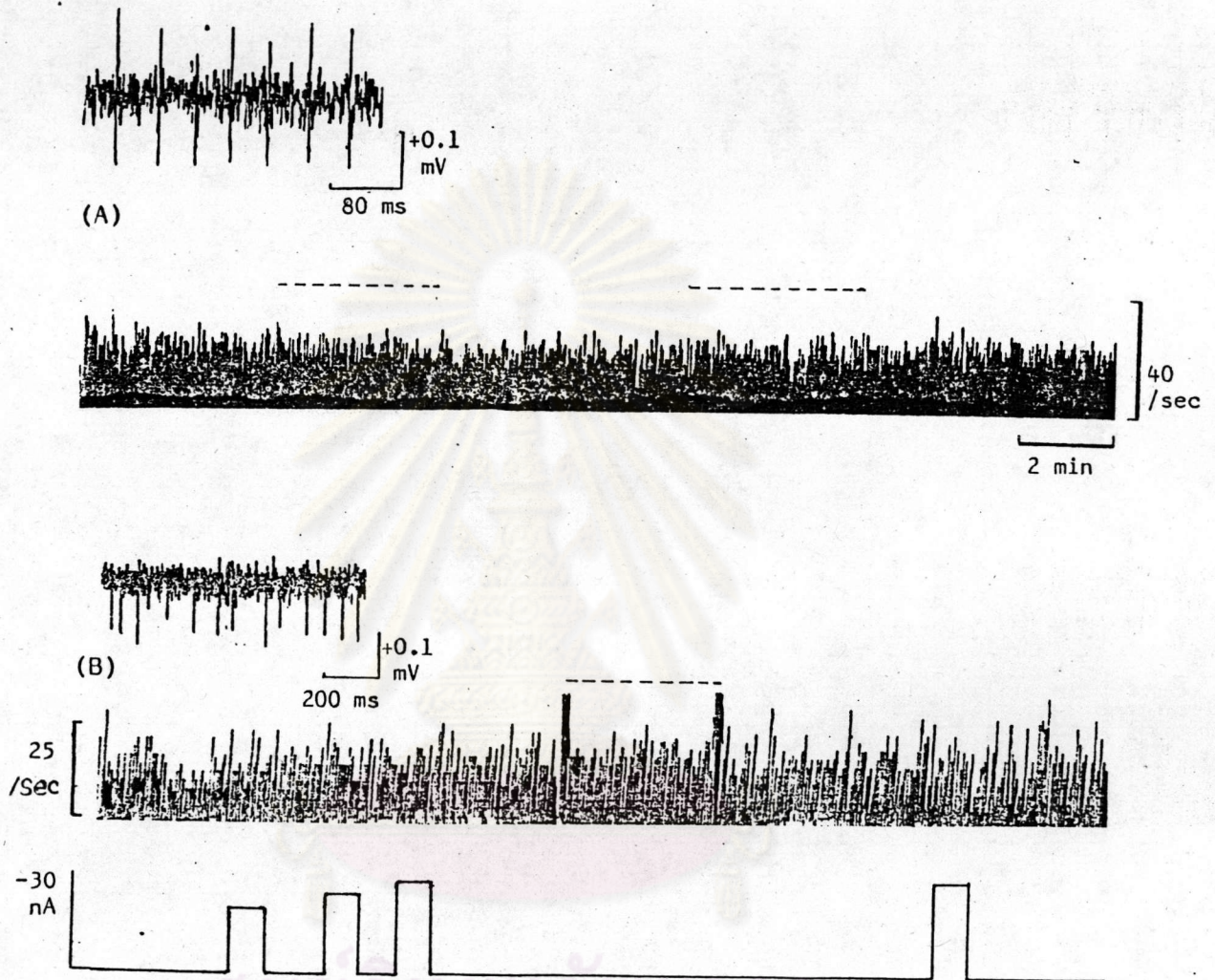

Fig. 21. Ratemeter records of interneuron in the molecular layer show no response to the glutamate when applied by perfusion technique (in A) or by microiontophoresis (in B). (--- = period of 0.2 mM glutamate administration).

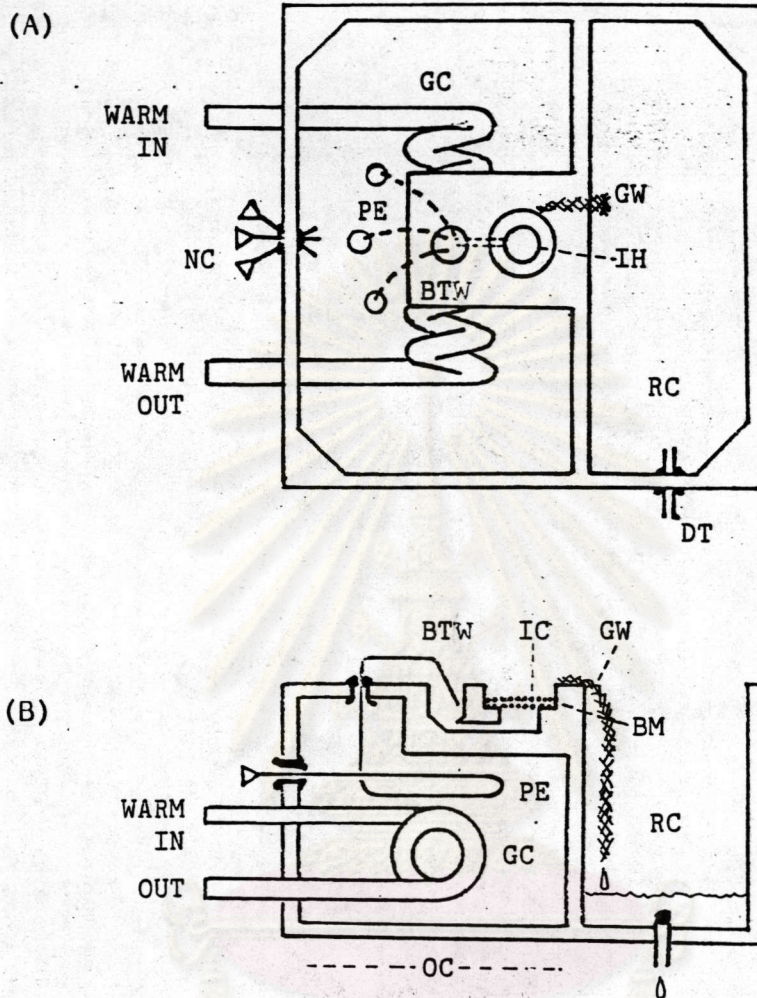

Fig. 7. Diagrammatic picture of the perfusion chamber.

A: above view. GC = glass coil, NC = three needle connectors, PE = polyethylene tube, BTW = bubble trapping well, GW = gauze wick, IH = incubating hole, RC = reservoir chamber, DT = a drainage tube.

B: right side view. BM = brass mesh, IC = inner chamber, OC = outer chamber.

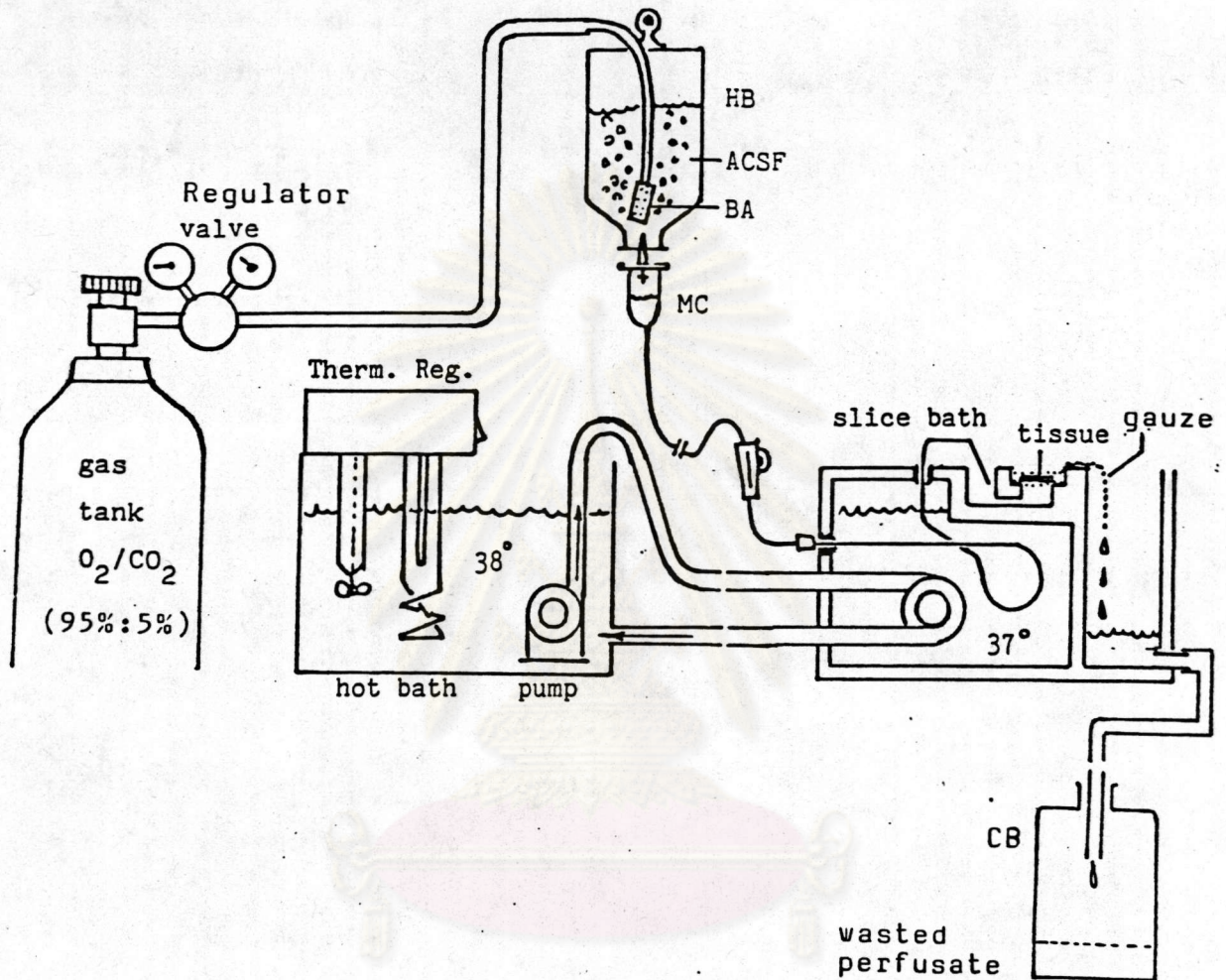

Fig. 8. Diagrammatic picture of the simple perfusion system (gravity-feed) showing technique for oxygenation and warming of the ACSF, for details see text (1.4). HB = a hanging bottle of the ACSF, BA = a ball aerator, MC = microdrip chamber and a tubing set, Therm. Reg. = a thermo-regulator.

2. Methods for Preparation of Cerebellar Slice.

2.1 Experimental Animal.

The experimental animals used were albino rats (Wistar strain) of both sexes. The animals (n=60) were divided into two groups according to their ages. The young group (n=30) has age range between 2 to 8 weeks, weighing 90 - 200 g, while the old group (n=30) has aging more than 8 weeks (weighing more than 200 g).

2.2 Bathing medium.

The incubating media, or ACSF, was prepared from stock solutions of 1 M NaCl (2 liters), 1 M KCl (250 ml), 0.5 M KH_2PO_4 (100 ml), 0.5 M $\text{MgSO}_4 \cdot 7\text{H}_2\text{O}$, 0.5 M NaHCO_3 (1 liter), and 1 M $\text{CaCl}_2 \cdot 2\text{H}_2\text{O}$ (100 ml). Routinely, the composition of the ACSF used was base on that of Yamamoto and McIlwain (1966) which contains (in mM, final concentrations) NaCl, 124; KCl, 5; KH_2PO_4 , 1.25; MgSO_4 , 1.3; $\text{CaCl}_2 \cdot 2\text{H}_2\text{O}$, 0.75; NaHCO_3 , 26; and D-glucose, 10 at pH 7.4. Method of preparing the media here follows the instruction of Hubbard (1988). Glucose was added at the beginning of the experiment and then bubbled with a mixture of 95% O_2 and 5% CO_2 . The calcium was added after, at least, 10 minutes after starting bubbling of ACSF. The medium was continuously bubbled through the experiment in order to maintained the osmolarity at 295 mOsm.

2.3 Killing and Brain Extracting Techniques.

In young group, the animal was suddenly decapitated at level of the obex using a large scissors. Next, a small surgical scissors was used to clean up the underlining tissues around the skull base and then inserted laterally at the lower portion of occipital condyle and cut antero-laterally toward the eye of both sides. The skull was opened to expose the brain. Afterward, a flat lomboidal spatula was used to separate the posterior portion of the cerebrum including cerebellum and the lower brainstem. The brain block was then placed gently in a beaker with 6 ml cold oxygenated ACSF (approx. 2^o C), chilled for 15 seconds and then placed on a piece of filter paper (Whatman no. 1, dia. 7.0 cm). This step usually completed within 1 min after death.

In old group, the techniques used was similar to the above but the rat should be mildly anesthetized with ether before starting to cut the neck. One of the trouble in dealing with the old animal was a difficulty of cutting the harden skull.

2.4 Slicing Procedures.

Two different techniques in preparing cerebellar slice have been attempted : (1) Manual



Method, and (2) Oscillotome Sectioning.

Manual Method. After the brain was removed and chilled properly, it was then placed gently on filter paper moisten with ACSF. The cerebellum was dissected from the rest of brain tissue using a razor blade fixed on the paper at one hemisphere by two small pins. Under microscope and adequate light illumination, the other hemisphere was sagittally cut away using blade and glass guide apparatus. Two or three pieces of vermian slice with the thickness about 450 to 500 μm could be obtained. Using a fine brush, each slice was transferred for preincubation in a petri dish filled with oxygenated ACSF at room temperature.

Oscillotome Sectioning. After a few second of cooling the brain, the cerebellum was rapidly cut into a block containing vermis and then glued onto a square piece of glass slide which was then fixed on the tissue stage (TS) of the Oscillotome. The block was aligned so that the vermis was on the opposite side of the blade. The tissue block was supported against an agar block (4 mm x 4 mm x 3 mm) which was glue on the slide using a liquid super glue (cyanoacrylate adhesive, Loctite, Ireland). Next, the stage with the brain block was put into the sectioned bath of the Oscillotome. The bath was filled with 150 ml of cold

oxygenated ACSF. Under direct visual observation, 6-7 vermicular slices were cut by the Oscillotome at 300 μ m thick. Finally, intact slices were selected and transferred into a petri dish containing cold oxygenated ACSF using the spatula and the fine brush.

In case of Oscillotome method, time taken from the point of stunning the animal to the beginning of incubation was usually within 5-8 min, while by hand slicing method only 5 min were required.

2.5 Incubation Technique.

The slices, having severe damage to their processes and being anoxia during the time of preparing, require a period of recovery. During this period the tissues can adapt themselves to the new environment.

Only one or two slices obtained from above were chosen for further studies. The most perfect piece was gently transferred into the incubation chamber (IC) of the tissue bath. The tissues were stabilized between two pieces of brass mesh, and submerged in 36°C oxygenated ACSF which was constantly perfused at the rate of 2 ml/min. The period of incubation took at least 1 hr. before starting the electrophysiological recording.

3. Electrophysiological Techniques.

3.1 Microelectrode Techniques.

Microelectrode used in the experiment were either single or double barrel micropipette. The former was used for general extracellular recording of bioelectric activities, while the latter was used for recording with concomitant iontophoretic application of glutamate through the additional barrel. The glass tubing used for preparing of the both micropipettes was glass fiber filled capillary tube with outer/inner diameters of 1.4 mm/1.0 mm.

For making of the single barrel microelectrode, the tube was pulled in the nicrome ribbon heater of a horizontal glass microelectrode puller (PN-3, Narishige). By adjusting of the heat level and the force of pulling magnet, two identical microelectrodes could be obtained. To make the double barrels microelectrode two glass tubing were fastened side-by-side at both ends by small pieces of heat shrink tubings. Using a vertical puller, the double-tube assembly was heated at mid-length and twisted by 30° to fuse the walls together. It was then pulled at the fused part to yield a double barrel pipette. Under microscopic observation, these electrode tip was then broken back to yield 1-2 μm tip diameter for the single

and 2-3 μm for the double barrel.

Finally, the recording micropipette was filled with 2 M NaCl Stained with red ink to facilitate visual guidance of the tip when in the bath solution. The recording microelectrode was routinely tested of its DC resistance using a digital volt-ohm meter and also the electrode checking unit from the microelectrode preamplifier (MEZ-8201, Nihon Kohden). The range of resistivity used was 2 - 5 megaohm.

3.2 Recording Technique.

Site of Recording. The electrode prepared from 3.1 was placed on the Purkinje cell layer of the cerebellar slice using a three dimensional micro-manipulator. Advancement of the microelectrode into the tissue is achieved with the aid of a hydraulic microdrive (MO-10; Narishige). Movement of the electrode was observed under a stereozoom dissecting microscope.

Amplification and Display of Unit Activity (Fig. 9). The interfering signals, generated from the surrounding electronic instruments and fluorescent light were reduced by a Faraday's cage. The bioelectric signal from tissue preparation was picked up as a single ended input via a fine Ag-AgCl wire

connected to a high impedance probe (JZ-802J; Nihon Kohden), with respects to a reference electrode (also using a Ag-AgCl wire) placed in the bubble trapping hole. Output from the probe was fed into a microelectrode amplifier (MEZ-8201; Nihon Kohden) which had a ten times amplification (gain x10) and a band pass filter which were used to minimize background noises and to flatten the base-line of the signals.

Next, output from the preamplifier was amplified further and filtered with HI and LO cut function of a variable gain AC amplifier (AVH-10; a plug-in amplifier; Nihon Kohden). The signals were then displayed on channel A of a dual-beam memory oscilloscope (VC-10; Nihon Kohden). In the usual cases the signals were stored in the memory of the oscilloscope displayed as a stored waveform on the CRO screen. Subsequently, the waveform were either plotted on a laboratory pen recorder (Harvard) or photographed.

3.3 Processing of spike data.

Spike discharges of the cells were discriminated from background interferences using a window discriminator circuit and counted digitally (Spike Processor, Department of Physiology, Faculty of Pharmacy, CU.), see Fig. 9. The count was then converted into analog output and plotted on a pen-

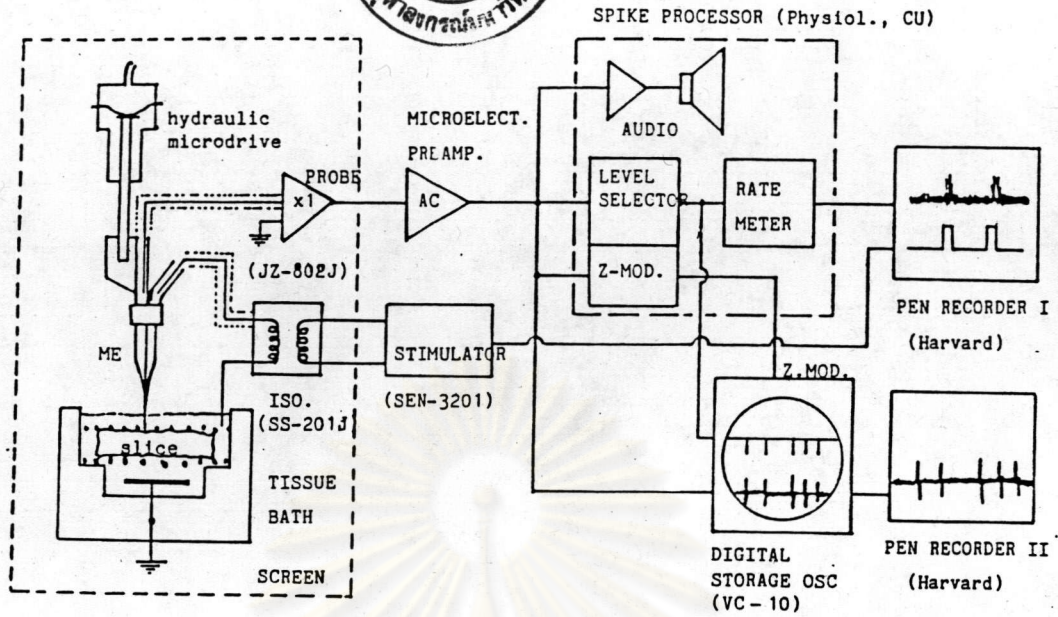

Fig. 9. Wiring diagram showing a standard electro-physiological set-up used for long-time observation of the spike activity. The microelectrode preamplifier (MEZ-8201) has improved the bioelectrical signals by means of amplifying and filtering. The signals are fed into a plug-in amplifier (AVH-10) of the oscilloscope (VC-10) and displayed on channel A of the scope, and also fed into the spike processor.

recorder as number of impulses over each consecutive epochal periods. Usually, the time base (epoch) of a rate meter was set at one second thus yielded a frequency histogram of the spikes in pulses per second (/sec) on Y scale of the pen recorder. The calibration pulses of a constant frequency, for example, 25 and 50 /sec, were routinely used on the running paper before starting the count.

4. Application in Physiology and Pharmacology.

4.1 Technique of Lowering Temperature.

In some experiments, effects of cold environment was tested on Purkinje cell performance by superfusing the slice with cold ACSF prechilled by running the ACSF through a coil of PE tubing in a beaker contained ice flake. This manure could reduced the temperature of ACSF down to 6°C in the ice bath, and subsequently elevated to 20°C when the solution reached the tissue chamber.

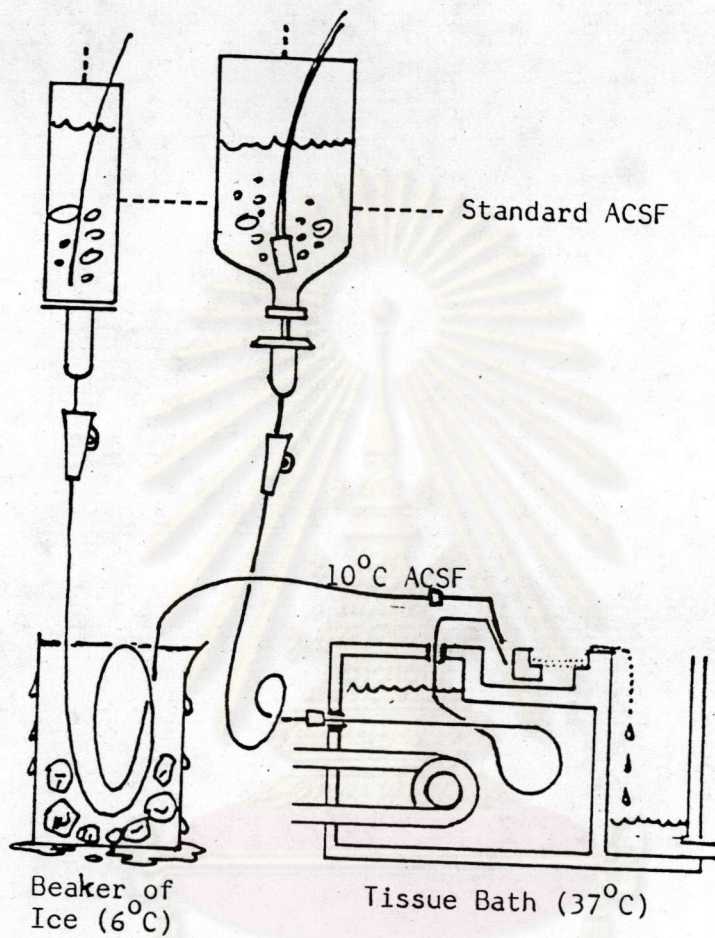

Fig. 10. Diagrammatic picture illustrating method of changing medium temperature.

4.2 Drug Application.

The advantage of using a submersion chamber is that it facilitates the tests of drugs or ions which can be administered by means of either micro-iontophoresis or superfusion techniques.

With using superfusion technique, 0.2 mM sodium glutamate was prepared in 100 ml of ACSF. The treated solution was then filled in a 100 ml volume control drip set and bubbled with a gas mixture of CO₂/O₂. The treated medium was kept at the same level of the bottle of standard media so that the same rate of perfusion (2 ml/min) could be adjusted easily. A superfusing medium could therefore be made between either of selection these two mediums using the gravity-feed perfusion system as previously described in 1.4.

An alternative technique for drug application was microiontophoresis which is the technique dealing with electrically driven microinjection of ionic substances. In the present study the technique used was based on that described by Tongroach (1988). The solution was prepared from monosodium glutamate salt at concentration of 0.5 M (pH 7.5). The solution was then filled in the drug-barrel of the double barrel micropipette. The glutamate was ejected by passing a negative current within a duration of 9.9 sec, obtained

from DC pulsed mode of a laboratory electrical stimulator (Sen-3201 and isolator SS-201J, Nihon Kohden). Strength of the ejected current was varied between 10 and 30 nA as measured by the voltage drop across a 10 kOhm resistance connected in series with the current passing circuit. Circuit diagram of the microiontophoretic arrangement is shown in Fig 11.

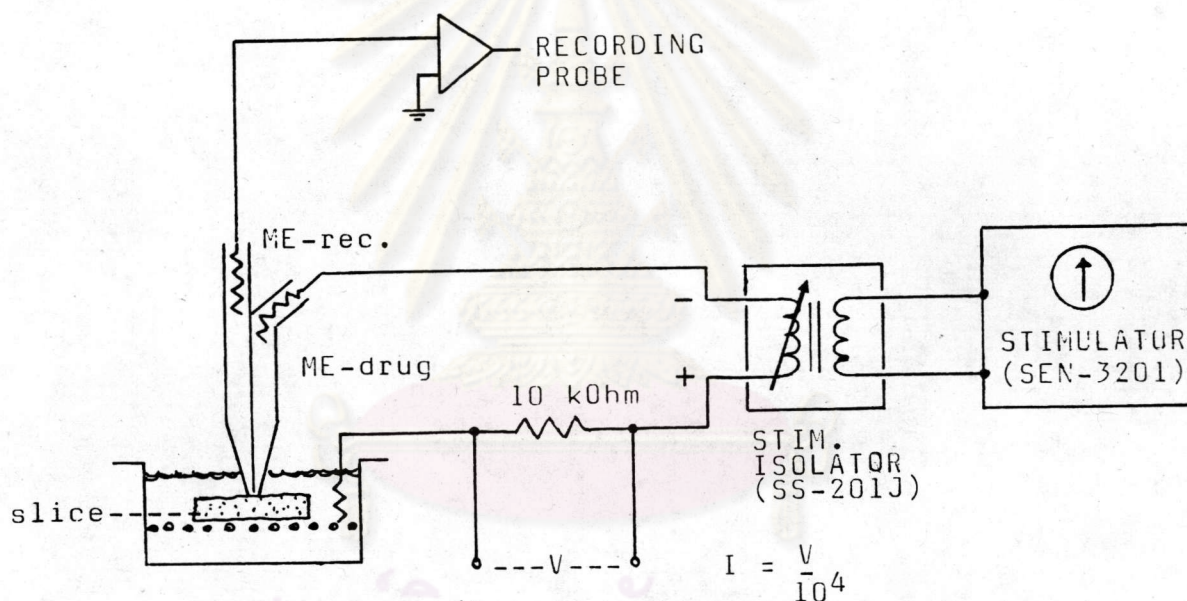

Fig. 11. Wiring diagrammatic picture of the microiontophoretic arrangement shows the drug filled microelectrode (ME-drug) attached to the recording microelectrode (ME-rec.). The ejected current is monitored as the voltage dropped between the resistor 10 kOhm.