



Reference

1. Rabo, J.A., Zeolite Chemistry and Catalysis, pp.3-8, American Chemical Society, U.S.A., 1976.
2. Barrer, R.M., "Zeolite structure, "Zeolite : Science and technology, pp.35-79, NATO Scientific Affairs Division, 1984.
3. Clifton, R.A., "Natural and synthetic zeolites," Bureau of Mines Information Circular, IC9140, 1-19, 1987.
4. Chang, C.D., and N.J. Princeton, "Production of Gasoline Hydrocarbon," U.S.Pat 3,928,483, December 23, 1975.
5. Breck, D.W., Synthetic Zeolites : Properties and Applications, Soc. Min. Eng. AIME, 32pp., 1973.
6. Mumpton, F.A., "Natural Zeolites : A New Industrial Mineral Commodity," Natural Zeolites : Occurrence, Properties, Use (Sand, L.B. and F.A. Mumpton, eds.), pp.3-27, Pergamon, 1978.
7. Breck, D.W., "Crystalline Molecular Sieves," J. Chem. Educ., 41, 1964.
8. Breck, D.W., Zeolite Molecular Sieves : Structure, Chemistry, and Use, Wiley, New York, 1974.
9. Kokotailo, G.T., "Zeolite Crystallography," Zeolite : Science and Technology, pp.83-103, NATO Scientific Affairs Division, 1984.
10. Meier W.M., Molecular sieves, pp.10, Soc.Chem.Ind.London, 1968.
11. Thomas J.M., and G.R. Millward, "Direct Real-Space Determination of Intergrowths in ZSM-5/ZSM-11," J. Chem. Soc. Chem. Commun., 24, 1380-3, 1982.

12. Kokotailo G.T. and J. Ciric, Molecular Sieve Zeolites-1, pp.109, American Chemical Society, U.S.A., 1971.
13. Barrer, R.M. and B.M. Munday, "Cation Exchange Reactions of a Sedimentary Phillipsite," J.Chem.Soc.A, 2904, 1971.
14. Bibby, D.M., N.B. Milestone, and L.P. Aldridge, "Silicalite-2, a Silica Analogue of the Aluminosilicate Zeolite ZSM-11," Nature, 280, 664, 1979.
15. Hay, R.L., "Geologic Occurrence of Zeolites," Zeolites : Occurrence, Properties, Use (Sand, L.B. and F.A. Mumpton, eds.), pp.135-143, Pergamon, 1978.
16. Iijima, A., "Geologic Occurrences of Zeolite in Marine Environments," Natural Zeolites : Occurrence, Properties, Use (Sand, L.B. and F.A. Mumpton, eds.), pp.175-198, Pergamon, 1978.
17. Chu, P., and N.J. Woodbury, "Crystalline Zeolite ZSM-11," U.S.Pat 3,709,979, January 9, 1973.
18. Rubin, M.K., and B. Cynwyd, "Crystalline Zeolite ZSM-34 and Method of Preparing the Same," U.S.Pat 4,086,186, April 25, 1978.
19. Inui, T, Dh. Medhanavyn, and P. Prasertthdam, "Methanol conversion to hydrocarbons on novel vanadosilicate catalysts," Applied Catalysis, 18, 311-324, 1985.
20. Argauer, R.J, M.D. Kensington, and G.R. Landolt, "Crystalline Zeolite ZSM-5 and Method of Preparing the Same," U.S.Pat 3,702,886, November 14, 1972.
21. Kokotailo, G.T., S.L. Lawton, D.H. Lawson, and W.M. Meier, "Structure of Synthetic Zeolite ZSM-5," Nature, 272, 437, 1978.
22. Kokotailo, G.T., P. Chu, S.L. Lawton, and W.M. Meier, "Synthesis and Structure of Synthetic Zeolite ZSM-11," Nature, 275, 119, 1978.

23. Fischer, K.F., " Zeolite Structure Refinement, " Molecular Sieves(Meier, W.M. and J.B. Kytterhoeven, eds.), pp.31, American Chemical Society, Washington D.C.,1971.
24. Flanigen, E.M., and H. Khatami, "Infrared Structural Studied of Zeolite Frameworks," Molecular Sieve Zeolites-I, pp.201-227, American Chemical Society, Washington, D.C., 1971.
25. Angell, C.L., and P.C. Schaffer, Infrared Spectroscopic Investigation of Zeolites and Adsorbed Molecules," J. Phy. Chem.,69,3464, 1965.
26. Thomas, J.M., and W.J. Thomas, Introduction to the Principle of Heterogeneous Catalysis, pp.365-424, Academic Press,New York , 4th ed., 1975.
27. Satterfield, C.N., Heterogeneous Catalysis in Practice, pp.164-177 and 239-268, McGraw-Hill Book Co., New York, 1980.
28. Gabelica, Z., and E.G. Derouane, " Factors Affecting the Synthesis of Pentasil Zeolites," Catalytic Materials, pt.12, pp.219-246, American Chemical Society, Washington D.C., 1984.
29. JCPDS, " Powder Diffraction File : Inorganig Phase Search Manual, " International Centre for Diffraction Data, 1983.
30. Cullity, B.D., "Chemical Analysis by X-ray Diffraction," Elements of X-ray Diffraction, pp. 397-420, Addison- Wesley Publishing Co.,Philippines, 2nd ed., 1978.
31. Shimadzu Corporation, "Infrared Spectroscopy," pp.23-51, Shimadzu Co., Kyoto, Japan, 1976.
32. Analytical Instrument Division, "Operator's Manual : Model IL551 AA/AE Spectrophotometer," pp. 2.2-2.4, Instrumentation Laboratory Inc., U.S.A., 1981.

33. Ward, F.N., "Analytical Methods Used in Geochemical Exploration," Geol. Surv. Bull., 1152, United States Printing Office, Washington D.C., 1963.
34. Dawson, V.C.D., " High Pressure Vessels , " High Pressure Technology(Spain, I.L. and J. Paauwe, eds.), pp.229-279, Marcell Dekker Inc., New York, 1977.



ศูนย์วิทยทรัพยากร
จุฬาลงกรณ์มหาวิทยาลัย

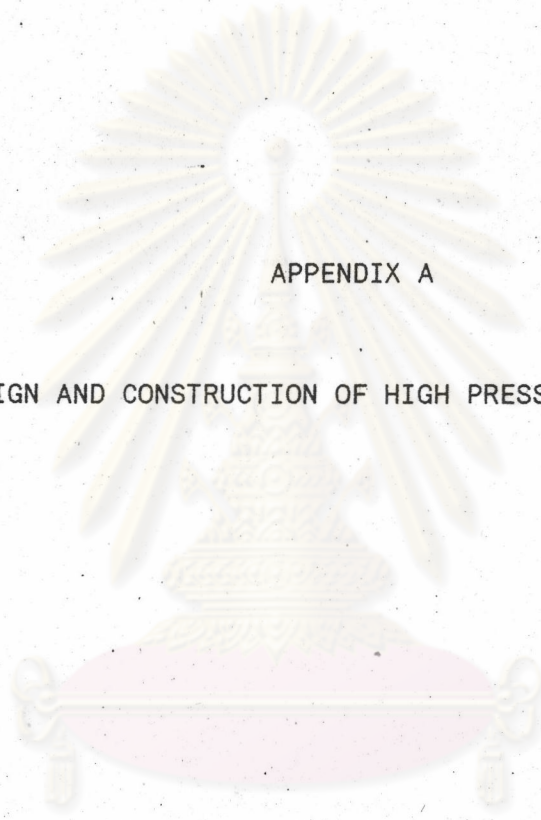

APPENDIX A

DESIGN AND CONSTRUCTION OF HIGH PRESSURE AUTOCLAVE

ศูนย์วิทยทรัพยากร
จุฬาลงกรณ์มหาวิทยาลัย

Design and Construction of High Pressure Autoclave

High Pressure Autoclave Design

Thickness of Wall and Flanged [34]

$$t = PDa_1/SE - a_0P + 0.005 \text{ inches/foot (corrosion allowance)}$$

where P = design pressure or maximum allowable working pressure, psi

S = stress value of materials, psi

D = inside diameter, inches

E = joint efficiency = 0.85

Conditions

$$P = 60 \text{ kg/cm}^2 \text{ (gauge)}$$

S at temperature $\leq 370^\circ\text{C}$ is 25,000 psi

D = 6 inches

Wall thickness

$$\begin{aligned} t &= \frac{853.38 (3.0 - t)}{25000(0.85) - 0.6(853.38)} \\ &= 0.119 \text{ inches} + 0.005 \text{ inches/foot} \\ &= 0.124 \text{ inches (4 mm)} \end{aligned}$$

Flanged thickness

$$\begin{aligned} t &= \frac{853.38(0.88)(6.0 - 2t)}{25000(0.85) - 0.1(853.38)} \\ &= 0.199 \text{ inches} + 0.005 \text{ inches/foot} \\ &= 0.204 \text{ inches (6 mm)} \end{aligned}$$

Welding

$$t = P(D^2/4) / S$$

where $S = 0.48 S$

$$= 0.48(25000) = 12000 \text{ psi}$$

$$t = 853.38(6(25.4)-8) / [4(12000)]$$

$$= 2.57 \text{ mm}$$

Stud

$$d = (P D^2/4) / L$$

where $d =$ stud diameter

$L =$ thread length

$$= 0.48 S \text{ (For stud at temperature } \leq 370^\circ\text{C, } S \text{ is 11,000 psi)}$$

$$= 0.48(11,000)$$

$$= 5280 \text{ psi}$$

$$d = \{853.38[(6(25.4)-8)^2]\} / 5280 \text{ (20)}$$

$$= 42.13 \text{ mm}$$

Use 8 studs...

$$d = 42.13/8 = 5.27 \text{ mm/1stud (minimum requirement)}$$

High Pressure Autoclave Construction

Material used to make an autoclave is stainless steel 304. The details of this autoclave was shown in figs. a.1 and a.2.

Piping of the High Pressure Autoclave to the Other Equipment

The high pressure autoclave was jointed with oxygen-free nitrogen bomb, pressure gauge and safety valve, gas outlet line, and temperature read-out apparatus.

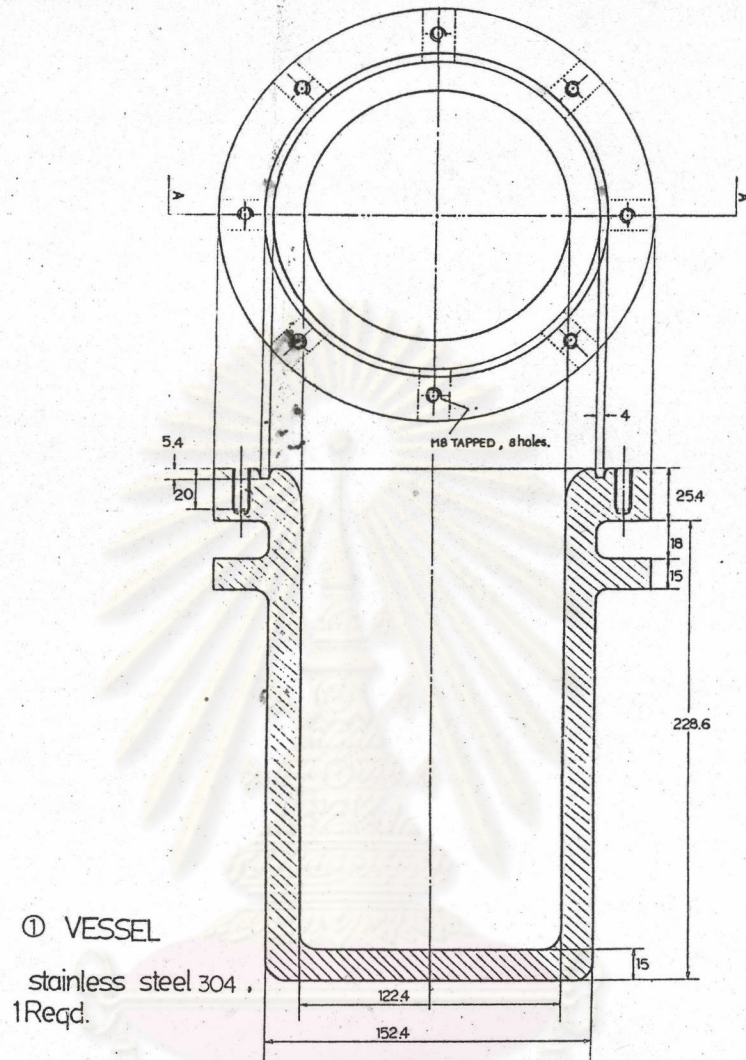

Figure A.1 Detail of the high pressure autoclave

ศูนย์วิทยุทรัพยากร
จุฬาลงกรณ์มหาวิทยาลัย

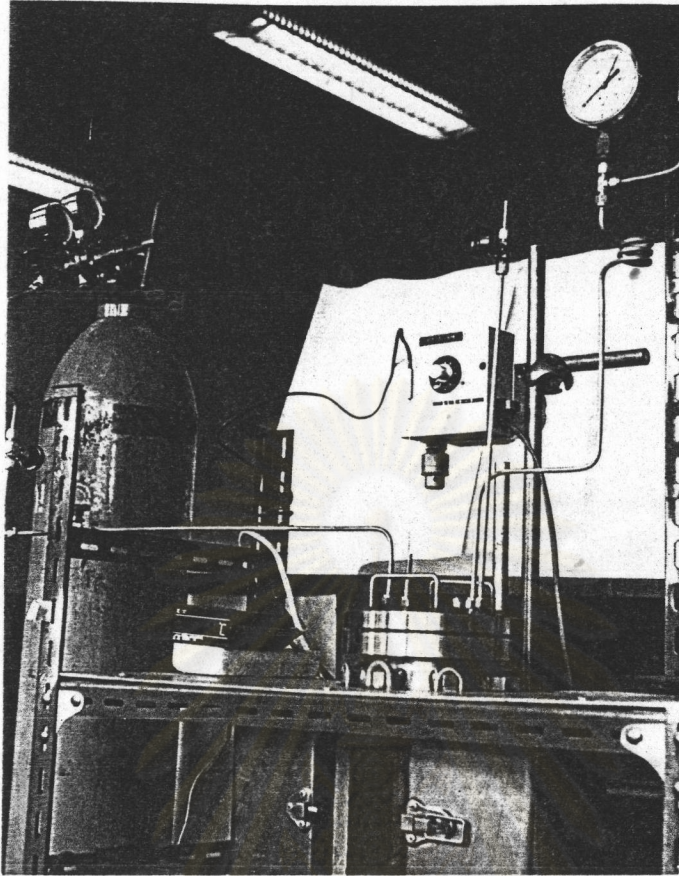

Figure A.2 High pressure autoclave set

ศูนย์วิทยทรัพยากร
จุฬาลงกรณ์มหาวิทยาลัย



APPENDIX B

CALCULATION FOR WEIGHT OF ALUMINIUM NITRATE

ศูนย์วิทยทรัพยากร
จุฬาลงกรณ์มหาวิทยาลัย

Calculation for Weight of Aluminium Nitrate

Example At water glass = 20.14 ml (sp.gr.=1.37)

$$= 27.59 \text{ g}$$

$$= 27.59(28.5\% \text{ SiO}_2) = 7.863 \text{ g}$$

$$\text{SiO}_2 \text{ 7.863 g} = 7.863/(\text{MW.60.1 g/mol}) = 0.1308 \text{ mol}$$

At Si/Al mole ratio 20

$$\text{Si/Al} = 20$$

$$\text{Al} = \text{Si}/20$$

$$= 0.1308/20$$

$$= 0.00654 \text{ mol}$$

$$\text{Al } 0.00654 \text{ mol} = \text{Aluminium nitrate } 0.00654(\text{ MW.375.13 g/mol})$$

$$= 2.46 \text{ g}$$

ศูนย์วิทยทรัพยากร
จุฬาลงกรณ์มหาวิทยาลัย

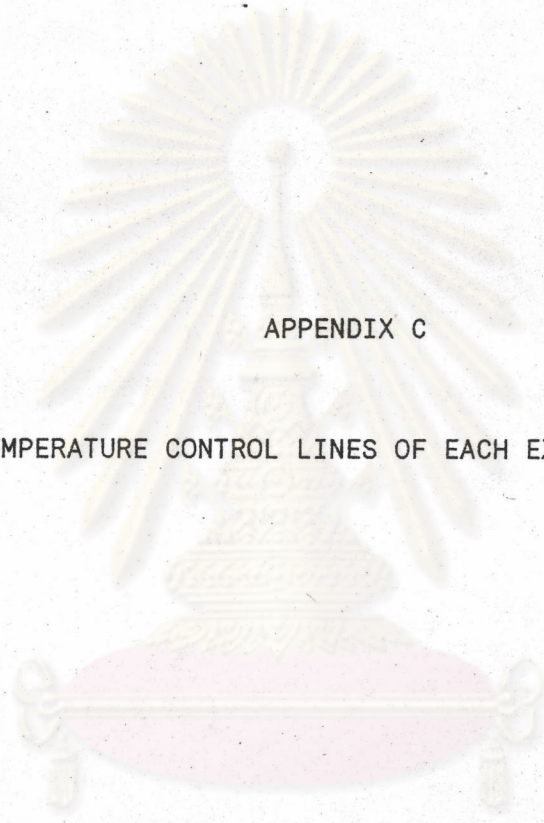

APPENDIX C

TEMPERATURE CONTROL LINES OF EACH EXPERINENTS

ศูนย์วิทยทรัพยากร
จุฬาลงกรณ์มหาวิทยาลัย

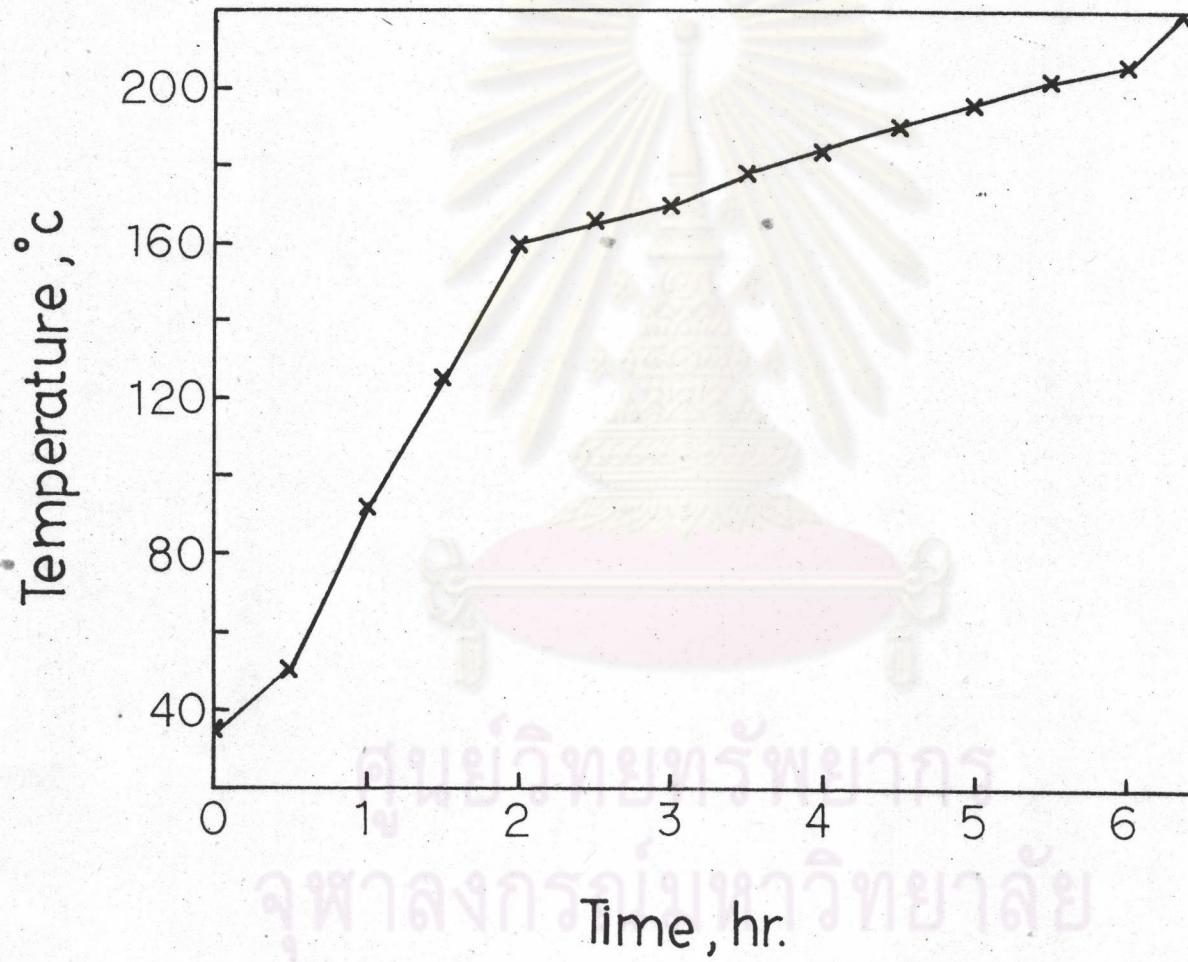

Figure C.1 Temperature control lines of section 3.1.3.1

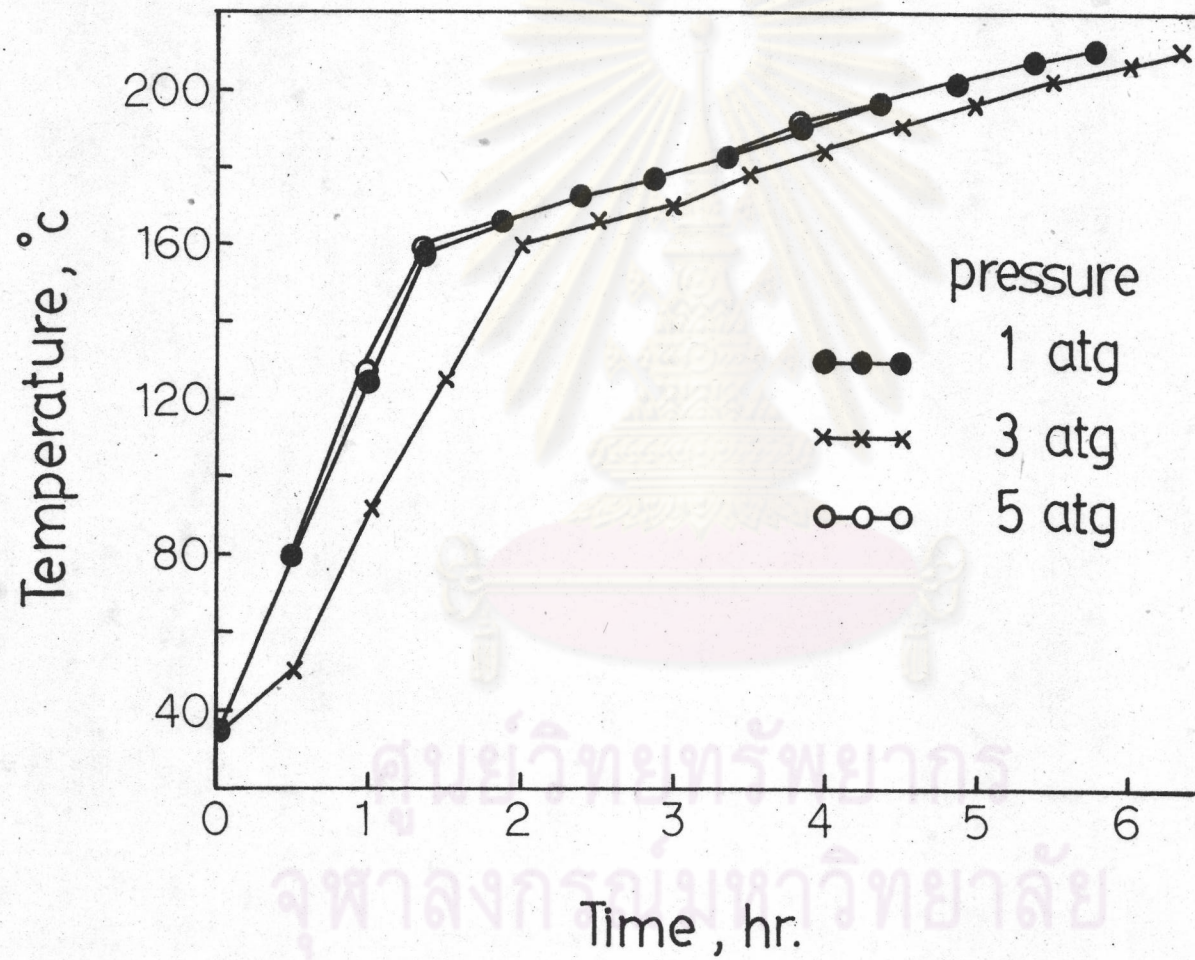

Figure C.2 Temperature control lines of section 3.1.3.2

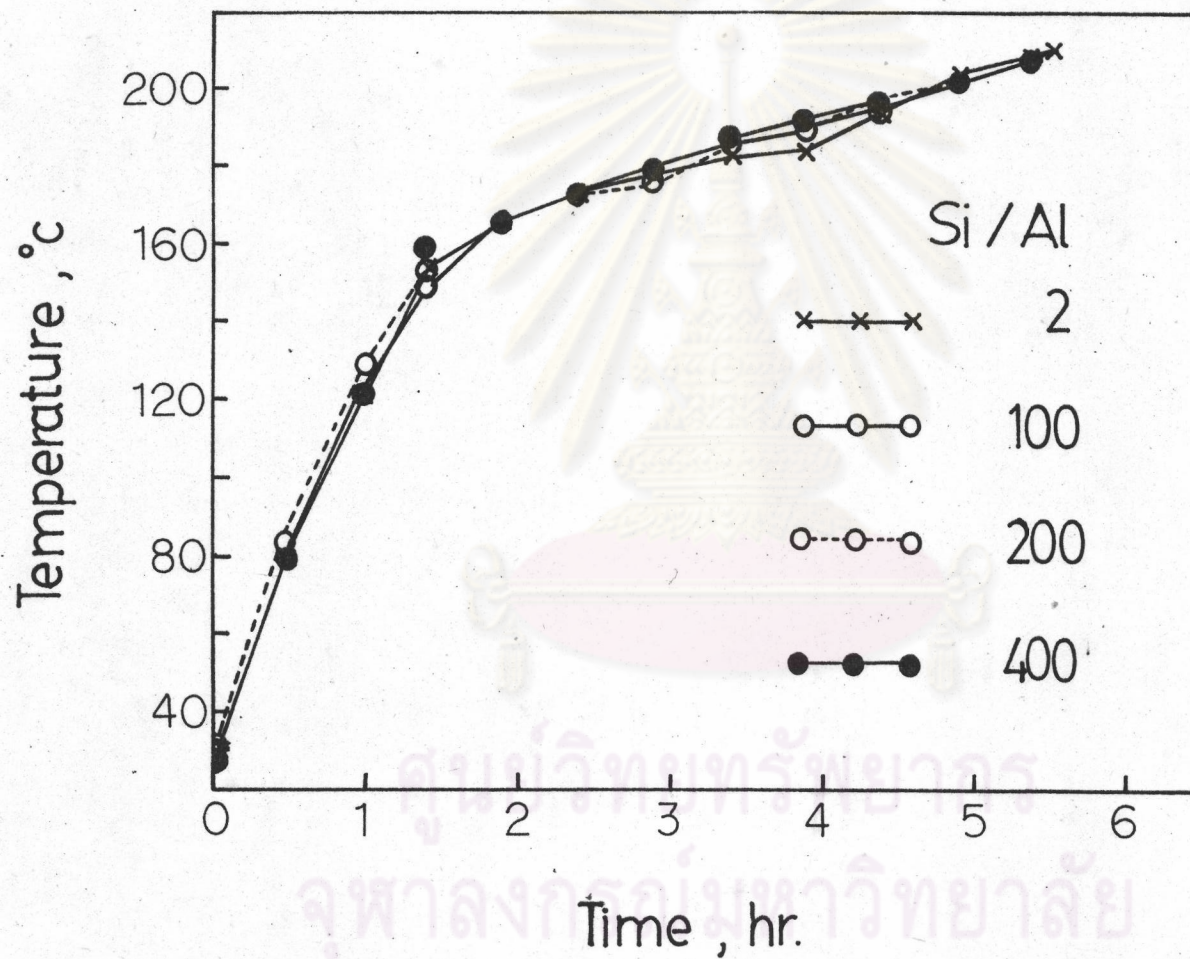

Figure c.3 Temperature control lines of section 3.1.3.3

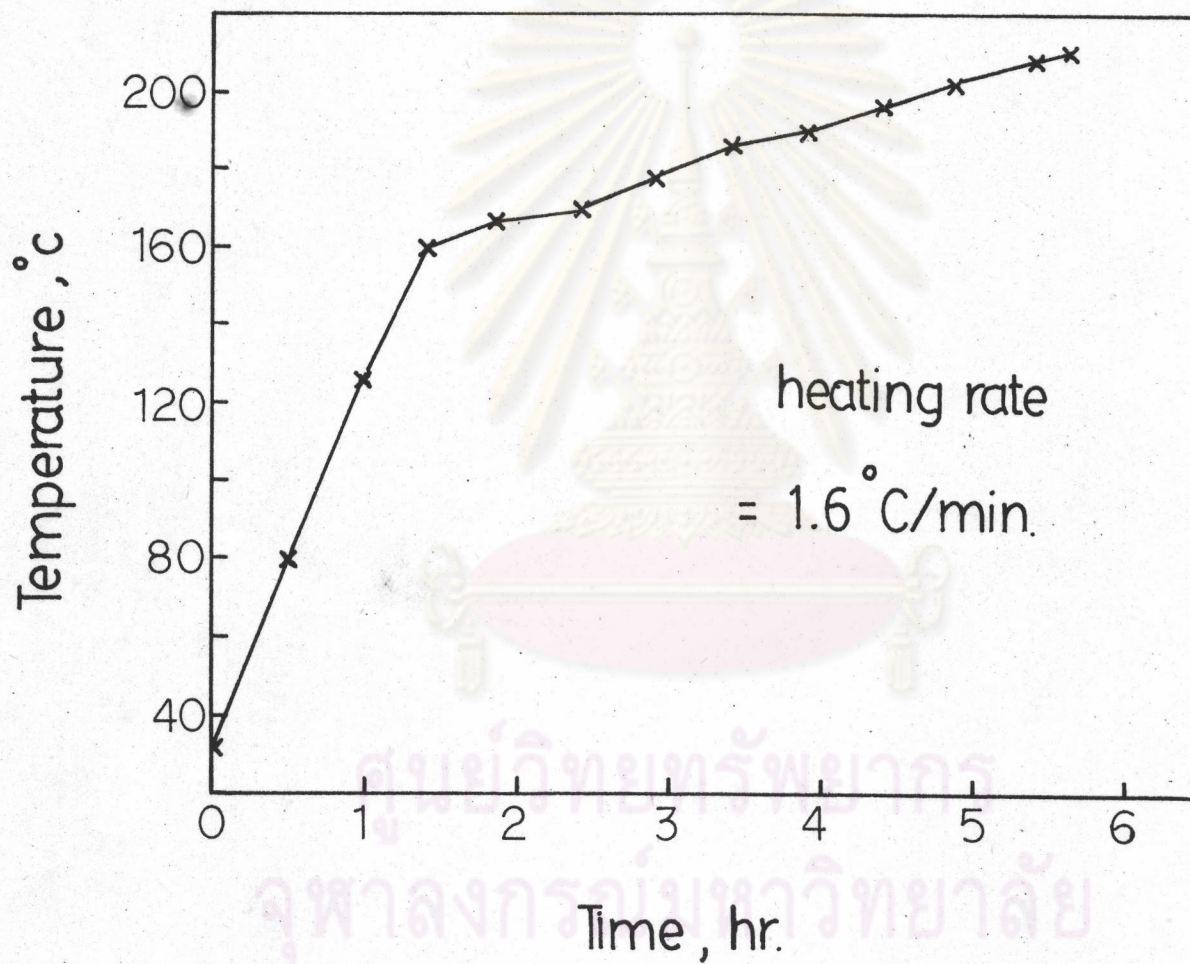

Figure C.4 Temperature control lines of section 3.1.3.4

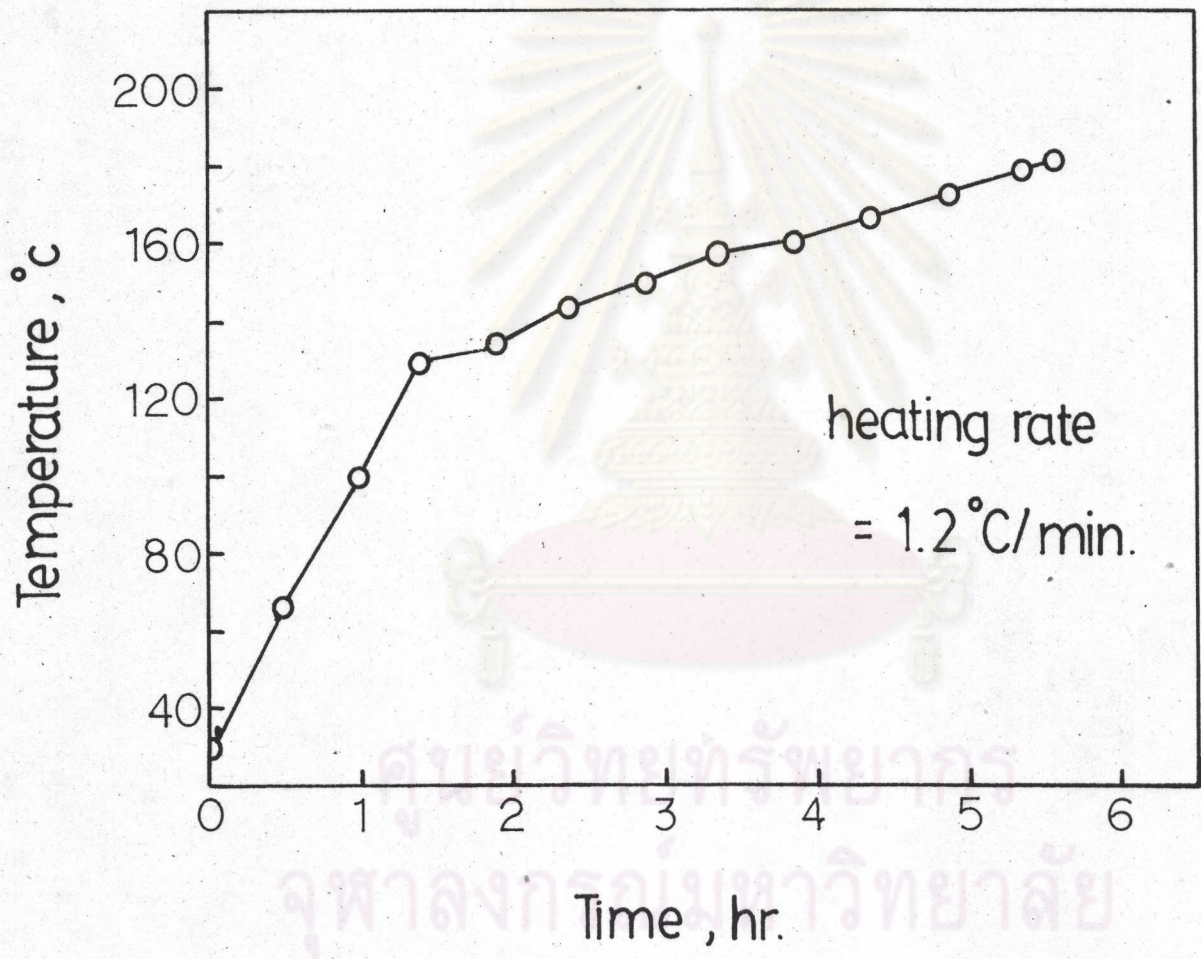

Figure C.5 Temperature control lines of section 3.1.3.4

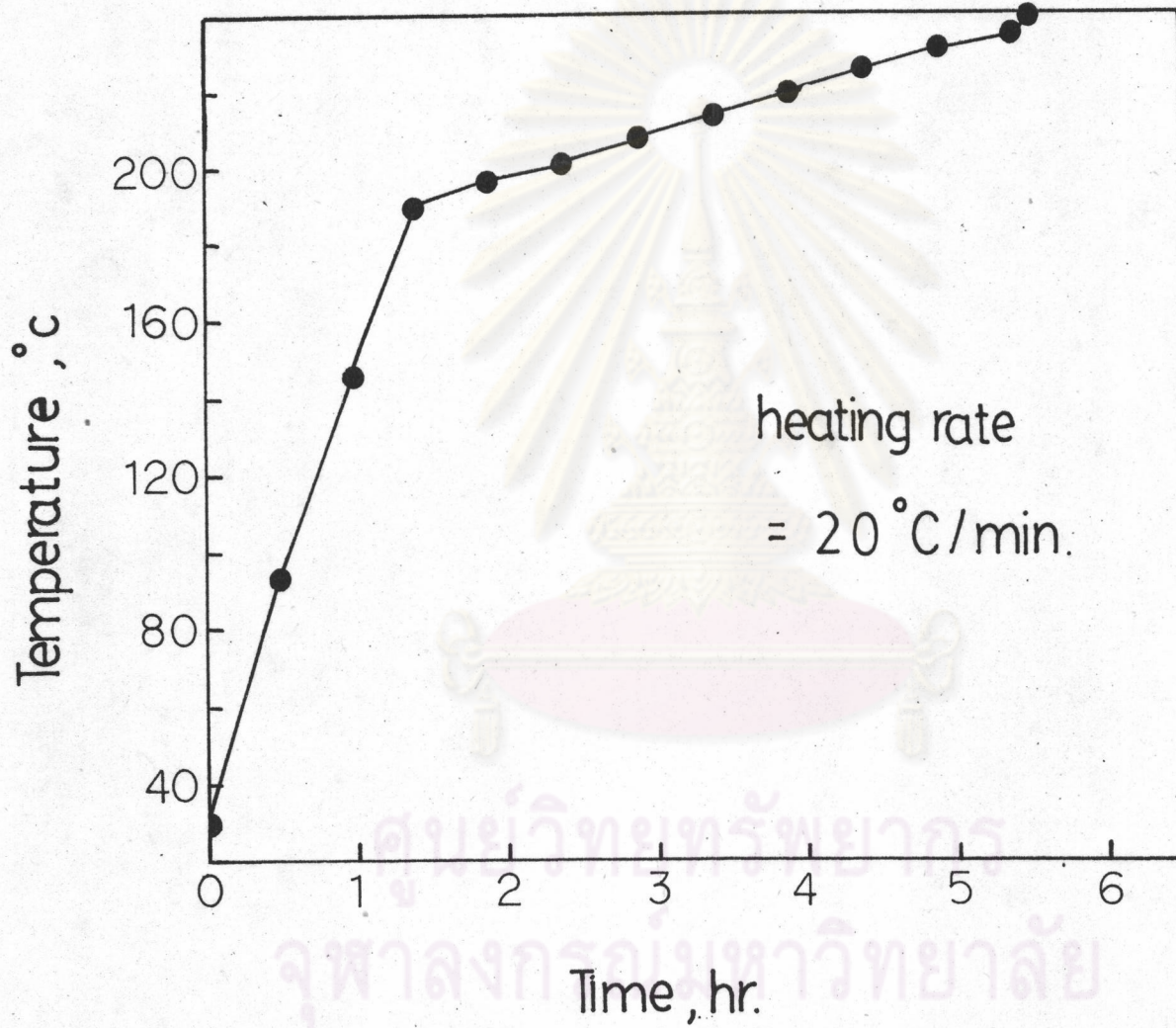

Figure C.6 Temperature control lines of section 3.1.3.4

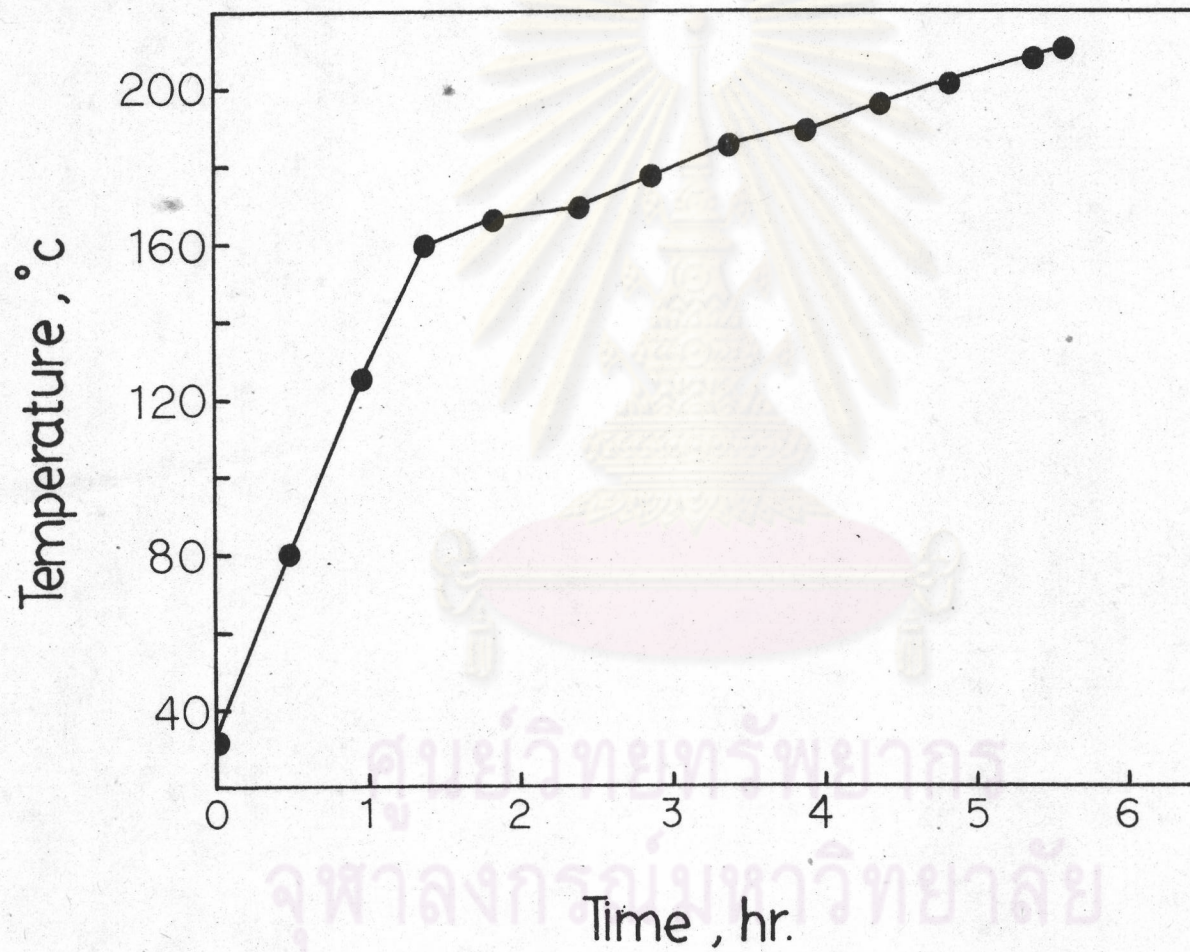

Figure C.7 Temperature control lines of section 3.1.3.5

AUTOBIOGRAPHY



Metta Chareonpanich was born on December 20, 1964 in Rayong, Thailand. She received her Bachelor Degree of Science in Chemistry from Faculty of Science, Kasetsart University, Thailand, in March 1986. She continued her Master's study at Chulalongkorn University in 1986.



ศูนย์วิทยุทรัพยากร
จุฬาลงกรณ์มหาวิทยาลัย