

Colloids

CAMP(1963) indicated that the size of colloidal particles ranged from about 0.001 micron to less than 1.0 micron.

Colloids are classified as hydrophilic and hydrophobic. A hydrophilic colloid like gelatin disperses spontaneously in water to form colloidal suspensions which can be dehydrated to the original material and then redispersed repeatedly. This is true of proteins, starches, synthetic macromolecules, or polyelectrolytes in general.

By contrast, dispersion of hydrophobic sols (colloidal dispersion of solids in liquids) are prepared by physical and chemical means. If such dispersions are dehydrated, they do not spontaneously redisperse in water. Clay and Metal oxides are largely hydrophobic in nature. The distinction between the two classes of compounds is that in hydrophilic systems the particles chemically react with the water in which they are dispersed and with metal coagulants. Purely hydrophobic systems do not react with the water phase, and coagulation is achieved by reactions that are largely physical rather than chemical.

BLACK and his co-worker(1961) and of RIDDICK(1961) have shown that raw waters contain microscopically visible colloids which characteristically possess high electrophoretic mobilities according to BLACK or high zeta potential according to RIDDICK on addition of coagulation agents, the electrophoretic mobility is found to decrease tending to zero at optimum coagulation proportions. Charge reversal may occur also.

It is obvious, however, that the considerations relating electrokinetic characteristics of a colloid and its stability apply only to hydrophobic colloids. Hydrophilic colloids are by definition **are** soluble also at their isoelectric point, and therefore may not be coagulable over any and all ranges of zeta potential or electrophoretic mobility.

#### Mechanism of Coagulation

The term "coagulation" describes the effect produced by the addition of a chemical to a colloidal dispersion resulting in particle destabilization by the reduction of the forces tending to keep the particle apart.

The second stage of the formation of settleable particles from destabilized colloidal-sized particles is termed "flocculation". In contrast to coagulation, where the primary force is electrostatic or interionic, flocculation occurs by a chemical bridging or physical enmeshment mechanism.

#### Colloidal Stability and Instability

Stability refers to the inherent property of colloidal particles to remain disperse despite passage of time, whereas instability describes the tendency of particles to coalesce whenever particle-to-particle contact is made. Two broad theories have been advanced to explain the basic mechanism of colloid stability.

1. The Chemical theory assumes the colloids are aggregates defined chemical structures, that the primary charge of surface arises from the ionization of complex chemical groups present on the surface of the particles and that the destabilization of the colloids is due to such chemical interaction as complex formation and proton transfer.

2. The physical emphasizes the concept of the electrical double layer and the significance of predominantly physical factors, such as counter-ion adsorption, reduction of zeta potential and ion pair formation in the destabilization of colloids.

#### Electrical Phenomena at Surfaces

It is agreed among colloid scientist that the stability of hydrophobic particles is due largely to the phenomenon of the electrical double layer consisting of the charged-particle surface and a surrounding sheath of ions of charge opposite to that of particle surface.

HELMBOLTZ(1879), GOUY, CHAPMAN and STERN proposed theories to quantitatively describe the concept of the electrical double layer. STERN's Theory is more generally accepted. The theory states that hydrophobic particles suspended in natural water, the charge is usually negative. These electrical charges may arise through ionization of atoms at the particle surface, by replacement of elements in a crystal lattice by element having a different charge, or particle may acquire the charge through adsorption of ions, particularly hydroxide ions from the water itself.

These ions are tightly bound to the surface of the particle and attract ions of opposite charge from the mixture of positive and negative ions in the water. This layer of oppositely charged ions (called counterions) is held near the particle by the electrostatic forces. Thermal agitation of the molecules of water causes the counterions to form a diffuse layer extending out from the particle surface into the bulk solution. As shown in Fig 1, the potential decays exponentially from the particle surface and eventually becomes zero where equal concentrations of cations and anions are presented.

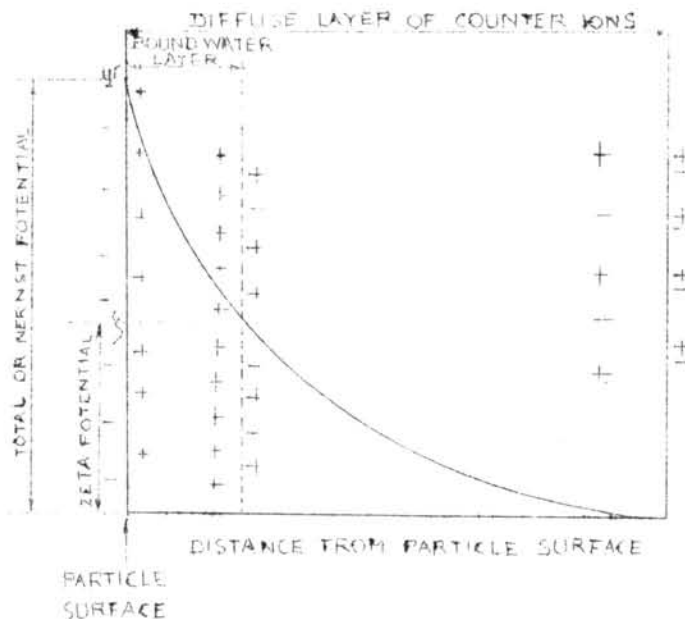

Fig. 1 - Structure of Double Layer and Corresponding Potentials.  
 $\psi$  is at the Particle Surface, and  $\xi$  is at the Hydrodynamic Plane of Shear.

The particle surface is shown as a plane containing negatively charged ions. Cations from the bulk solution are attracted to this surface. At increasing distances from the particle, the forces of attraction quickly decrease, and there arises a diffuse layer of ions trailing out into the bulk solution. At some distance from the particle and within the diffuse layer. There is a plane of shear representing the portion of bound water and ions that will remain attached to the particle as it moves through the suspending liquid. Hence, in a sense the bound water layer can be considered as an integral part of the charged particle surface. It is important to note that the thickness of double layer related to particle diameter is extremely small, for example, the thickness of the double layer in a solution of monovalent ions at a concentration of  $10^{-3}$  molar (about the concentration in surface water) is approximately 0.01 micren.

The electrical double layer surrounding each particle in water is to create regions of electrical potential in a bulk solution that nominally has a zero potential. The electrostatic work require to transport a unit charge from this bulk solution through the phase boundaries of each layer surrounding a particle to any point measures the potential at that point. The potential increases sharply with increasing approach to the primary particle surface. The potential at the surface of the particle,

also called the "total potential" or Nernst potential, is represented by  $\Psi$  (psi). The second potential is called the "Zeta potential" ( $\zeta$ ), and is located at the "plane of shear" at the boundary between the solvent adhering to the particle in its motion and that which can move with respect to it. This "plane of shear" essentially separates the water of hydration from free water.

The zeta potential is important because it is related to particle stability, and approximate values of zeta potentials can be calculated based on the four basic eletrokinetic phenomena.

1. Electrophoresis: imposed electrical field causes migration of particles.
2. Electroosmosis: imposed electrical field causes migration of solvent.
3. Sedimentation potential: arises from an imposed movement of charged particles.
4. Strenaming potential: arises from imposed movement of solvent through capillaries.

The net effect of the existence of electrical double layers around particles is to inhibit the close approach of particles to each other, and hence the double layers confer stability to the suspension. Both the thickness of the double layer and the surface-charge density are sensitive to concentration and valence of the ions in solution and hence stability of the suspension can be marketly affected by adding suitable ions to the solution.

While the phenomena of surface hydration and double layer formation contribute to the stability of colloidal particles, there are forces which operate in the opposite direction to cause the particles to become destabilized or coagulated.

One of the factors caused to instability of colloid particle is Brownian movement. It was discovered that very small particles suspended in water with diameter 100  $\mu$  or less, are in constant motion. The energy for this motion of the particles is obtained from collisions with water molecules and is directly related to temperature, the energy increasing with increasing temperature. The particles are bombarded from all directions, resulting in a rapid and random movement of the colloids. Moreover, for larger particles, Brownian Movement becomes a negligible factor. A far more effective was of promoting areas of turbulence.

Another force which is always a force of attraction between particles and leads ultimately to instability is the London-Van der Waals force. It may be described as an atomic cohesive force and exists between all atoms. Although these forces are generally considered to operate within distances of the order of atomic dimensions, the aggregate effect of the attractive forces is to extend the range of effectiveness to the order of colloidal dimensions.

If the electrical forces of repulsion between particles are sufficiently reduced to permit particle-to-particle contact, then the London-Van der Waals forces will cause particles to stick to each other, leading to progressive agglomeration of particles.

### Theory of Coagulation

SCHULTZE(1882) and HARDY(1900) studied monodisperse colloidal sols at relatively high concentration, and the results led to what are now known as the Schultze-Hardy rules. They stated that coagulation is caused by ions having a charge opposite to that of the colloidal particles and that of coagulating power of an ion is markedly dependent on its valency. Thus, a bivalent ion is approximately 30 to 60 times more effective than a monovalent ion, and a trivalent ion is 700 to 1000 times more effective than a monovalent ion. They further showed that the stability of a colloidal suspension was due to the electrical repulsion existing between particles and that the introduction of ions of opposite charge results in charge neutralization with consequent zeta potential reduction to zero. Under these conditions coagulation of the colloid occurs.

It was shown that coagulation of a colloid could also be achieved by colloids of opposite charge as well as by ions. This reaction was termed " mutual coagulation "

DERJAQUIN(1940), VERWEY(1941) and OVERBEEK(1948) confirmed the Schultze-Hardy rule of valency dependence. They showed that stability was not due to the electrical repulsion between two primary particles but that this reaction had to consider interaction between two particles, each of which was surrounded by an electrical double layer. The effect of double layer was to prevent the close approach of particles to distances within which the short-range London-Van der Waals forces could operate to cause coagulation.



The net effect, however, of the addition of electrolytes is to decrease the thickness of the electrical double layer and at certain concentrations, coagulation would occur because of the reduction of the barrier to close approach of particles. In coagulation, whether by electrolytes or by colloid interaction, element of time is important. The simplest case of coagulation occurs when enough electrolyte has been added to so reduce the double layer barrier that each contact between particles as result of Brownian movement produces an irreversible coalescence. SMOLUCHWSKI has shown that under these condition coagulation is rapid.

Under conditions where only enough electrolyte has been added to partially reduce the thicknees of the double layer, then coagulation is slow. It has been shown that rate of coagulation is determined by particle size, shape, and heterogeneity.

#### Hydrolysis of Aluminum Salts

The hydrolysis of Aluminum ions form a series of multivalent charged hydrous oxide species. Depending on pH, These compound may range from positive at the lower pH values to negative at the more basic pH values. These reactions are termed "ligand" exchange reaction and can be represented as follows:

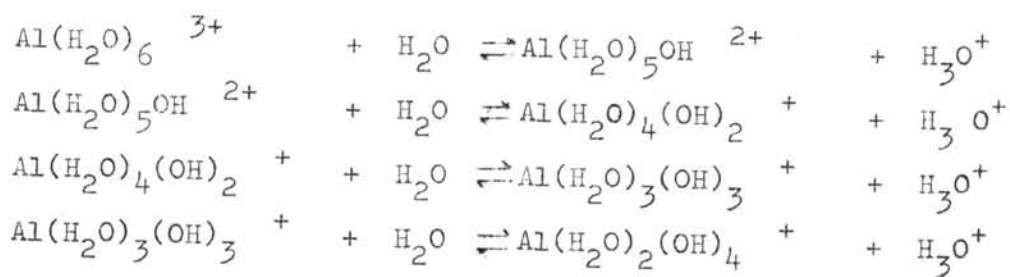

In addition to pH, the chemical composition of water also influences the species of complex produced, since negative ions, other than hydroxide, particularly the di-trivalent ions, may enter the complex and significantly change its properties. Thus the present of sulfate, one or more sulfate ions may substitute for hydroxide ions.

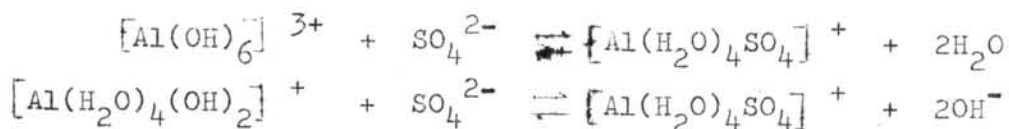

A second type of reaction, "olation" has been postulated which gives a poly nuclear complex in which two hydroxyl groups act as a bridge between two metallic atom.

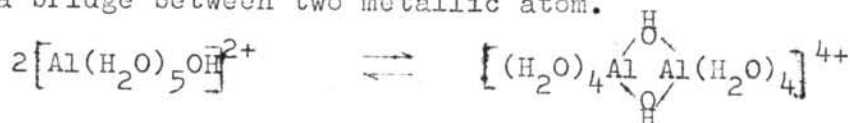

The polymerization process can continue, yielding complexes containing several metallic atoms.

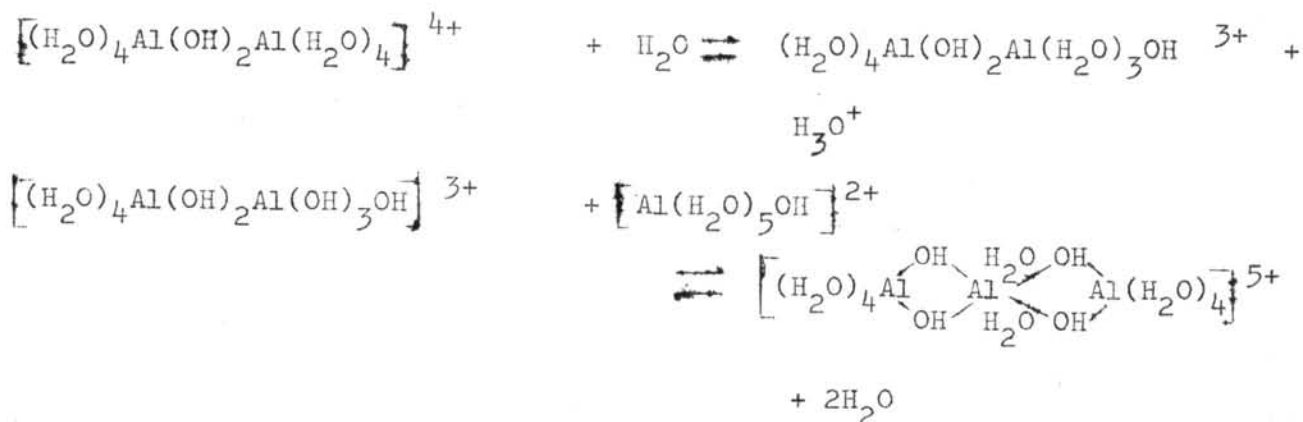

It has been suggested that the complex most important in coagulation at low concentrations of aluminum is a polynuclear complex containing eight aluminum ions carrying a tetrapositive charge, of the form  $[Al_8(OH)_{20}]^{4+}$ .



### Mechanism of Floc Formation

Immediately upon addition of aluminum salts to the water, reaction with water and other ions occur, resulting in the production of multipositive hydroxo and polynuclear species of compounds. The coagulant species are rapidly adsorbed onto the surface of turbidity particles (hydrophobic particles) which ultimately become coated with coagulant. The electrostatic attraction between the negatively charged particles and the positively charged hydrolysis products enhances the deposition. The net result is that the electrical charges on the particle are reduced. Depending on pH and coagulant dose, the charges on the particle as measured by zeta potential may vary from slightly negative to neutral to slightly positive. The suspension is now considered to be destabilized and the process of flocculation, where the particle can agglomerate to settleable size, can proceed unhindered. Mixing or turbulence promotes collisions, and because the particles have now been destabilized, each collision results in a lasting union.

Under the proper condition for the coagulation, and even in the absence of turbidity, coagulant will hydrolyze and form progressively larger masses of flocculent material. In the process

of this formation and during its settling when sufficient size has been attained, the floc may also physically enmesh the turbidity particles and simply act like a "sweep" as it settles.

For the destabilization of hydrophilic colloids, such as natural color in water; which contain polar groups such as hydroxyl, carboxyl, or phosphate groups that are negatively charged. They are thus able to combine chemically, rather than by electrostatics, with the positively charged coagulant hydrolysis products, forming an insoluble product that is electrically neutral or destabilized.

### Factor Influencing Coagulation

#### Effect of pH

There is at least one pH for any given water within which good coagulation-flocculation occurs in the shortest time with a given coagulant dose. The extent of the pH range is affected by the type of coagulant used and by the chemical composition of the water as well as by the concentration of coagulant. Failure to coagulate within the optimum zone for a given water may be wasteful of chemicals and may be reflected in lower quality of the water plant effluent.

#### Effect of Salts

001031

BLACK, RICE, and BARTOW(1933) investigated the effect of the sulfate ion  $\text{SO}_4^{2-}$  on alum coagulation. In the absence of additional sulfate ions the pH zone of floc formation is narrow with occurring at the pH of about 7.5 as the sulfate ion is increased, the pH zone is markedly broadened extending toward the acid side. With 125 mg/l. of additional sulfate ion, floc formation is obtained within a broad pH zone extending from 4.8 to 7.2.

### Effect of Coagulant

For alum the pH zone for optimum coagulation is quite narrow, ranging from about 6.8 to 7.5.

### Effect of Mixing

Rapid mixing is essential to uniformly disperse the coagulant and to promote collisions of coagulant particles with turbid particles, at the end of which the coagulant has hydrolyzed and has been adsorbed on the turbidities particles.

The second stage of floc growth or flocculation is accomplished by gentle stirring. The degree of agitation must be great enough to keep the floc particles suspended in motion, but not so great that the floc is disintegrated by the shearing forces.

Detention time as little as 10 minutes, but more frequently 30 to 60 minutes, are generally adequate to produce a floc that will settle in a reasonable time.

### Water Purification by Electrophoresis

COOPER(1965) explained the forced-flow electrophoresis which is illustrated by means of the schematic presentation in Figure 2.

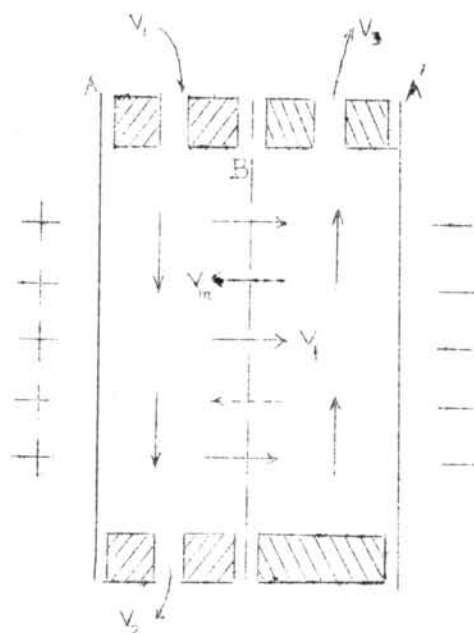

Fig.2- Schematic Diagram of A Forced-Flow Electrophoresis Cell

A, A' -Membranes, B-Filter,  $V_1$ -Raw Water Inflow,  $V_2$ - Waste Outflow,  $V_3$ - Purified Water Outflow, Solid Arrow- Direction of Flow of Water, Broken Arrows- Direction of Electrophoretic Migration

An electrophoretic cell is defined by means of two membranes, A and A' , that are separated into an input half-cell and output cell by means of filter B. The membranes and filters are held in position by means of appropriate spacers. These spacers have dimensions of 2.25" x 6" x 0.07". The membranes are the usual dialyzing membranes such as Visking or Cellophane. A variety of non-metallic filters can be employed, including filter paper, microporous plastic battery separators, or even millipore filters.

The essential difference between membranes and filters is that the membranes allow free passage of electrolytes, but do not allow free flow of water, or diffusion of colloids and free flow of water. A direct current electrical field is established across the cell by means of electrodes external to the cell assembly.

Raw water is fed continuously through the top inlet  $V_1$  and is separated into two streams, part of which is collected from the opposite end,  $V_2$ , of the input spacer, while the remainder is forced through the filter and collected from the outlet  $V_3$ . The direction of flow of liquid through the cell and filter is indicated by solid arrows. At the same time the imposed electrical field causes a migration of electrically charged colloids in the direction opposite to the flow of the liquid through the filter. This electrophoretic migration is indicated by the broken arrow in the diagram.

If the linear migration velocity  $V_m$  is equal to or bigger than the linear rate of flow of the liquid  $V_f$  the passage of colloids through the filter is prevented effectively. Thus the apparent effect of the electrical field is to modify the properties of the filter, which becomes a retentive for electrical charged colloids, while at the same time allowing an easy and free flow of solvent. Colloids retained by the filter normally are not allowed to accumulate in the cell, but are eliminated through the liquid collected from the bottom outlet of the apparatus. The same apparatus can be used also as a simple filtering device if the water carries coarsely suspended materials or supra-colloids

such as clay, algae, and gelatinous precipitates which would tend to clog the filter. As a result clogging is prevented and continuous filtration can be maintained even with most troublesome suspensions. In some cases actual deposition of the coarse material occurs at the membrane opposite to the filter and cleaning may be effectuated through periodic rapid reversals of the polarity of the current.

In normal paper electrophoresis separations are made within the plane of the paper. In forced-flow electrophoresis, the separation is made perpendicularly to the plane of the filter. Therefore, high rates of flow were obtained as the whole filtering surface is utilized. On the other hand, only two fractions are obtained, a colloidal free fraction which has passed through the filter and a colloid enriched fraction which has been retained. The apparatus is also similar to that used in electro dialysis for desalting of saline waters. The essential difference is that in electro dialysis, ion exchange membranes are employed, while the present method a combination of semipermeable membranes and filters is used.

Of their work on large scale purification of flood runoff contained 1500 mg/l. silt load by means of forced-flow electrophoresis, they showed the treatment was effective in removing all visible turbidity. The treatment was less effective for dissolved solids with their concentration decreasing only about 50%. An electric field of 30 V/cm was applied and the flow rate of the product stream was 120 ml/min/sq. ft.



Each off-current cycle resists in progressive deterioration of the filter, but even without deterioration, most efficient utilization of electrical power is obtained on continuous application of the field.

The economy of the process depends mainly on two factors: (a) Electrical conductance of the raw water, and (b) Type of pollutant to be eliminated. For example, cost estimate for treatment of water contained 1500 mg/l. silt having specific conductance of 250 micromhos with flow rate 120 ml/min/sq.ft. was \$1.24/1000 gal.

### Electrodialysis

Electrodialysis is the application of an electromotive force to transport ionized materials through permeable membrane separating two or more solution. Membranes are made of ion exchange materials such as polystyrene cross-linked with divinyl benzene. Such membranes have a low electrical resistance and are more or less selective in the transport of ionised materials of one charge. Electrodialysis method can desalt of brackish water containing from 1000 to 5000 ppm of salts.

### Electrohydraulic Effect

YUKIN (1938), the Russian Scientist, refined and demonstrated the primitive technique of electrohydraulics after that LAWRENCE (1969) explained electrohydraulic effect is due to stored electrical energy suddenly released by high speed electronic switches and electrodes immersed in water, an intense mechanical

shock wave is created. The wave is characterized by a steep leading edge and a minor bubble pulse trailing at the end. Termed electrohydraulic effect, it's an easy way to convert electrical energy into a moving force. It can be used to split hard rock, propel marine vehicles.

A basic electrohydraulic system is shown in Fig.3

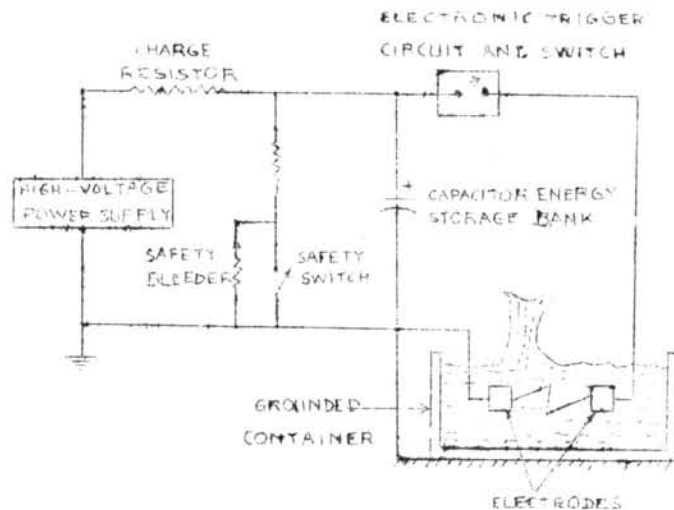

Fig.3-Electrohydraulic System Has Power Supply, Trigger, Storage Capacitor, and Submerged Electrodes in Circuit

The necessary high voltage, about 20 kV, is obtained from a line operated d.c. power supply and charges a capacitor storage bank rated from 1 to 15 microfarads. Safety devices "bleed" the circuit via high-resistance discharge paths. When electronic trigger circuit is activated, energy is rapidly dumped into concentric or opposing spark-gap electrodes submerged in the

water-filled tank. The resulting shock wave sheared a metal sheet as shown in Fig.4.



Fig.4- Shock Wave Used For Shearing Metal.

Although the outward appearance of the electrohydraulic effect is that of a simple chemical explosion, for example, flash of light, noise, hefty splash of water, its constituents are much more complex.

Unlike a chemical explosion whose dynamics are measured in terms of millisecond, the sudden release of stored energy results in the generation of a small vapor bubble which, for all practical purposes, acquires the characteristics of a plasma. Its temperature can be as high as 30,000° C, accompanied by pressures estimated to peak out at approximate 20,000 atmospheres. Active chemical species generated by the short-term plasma include hydroxyl radical (OH), ozone, and oxygen. This attendant electrochemistry is recognized as an effective method for destroying

harmful micro-organisms in water and it might, in time lead to the development of economical methods for treating polluted river and streams.

An electrohydraulic discharge unit suitable for laboratory application is shown in Fig.5. The safety spark gap,  $C_s$ , protect the main storage capacitor ( $C_o$ ) from rupture caused by over voltage.

Using equation,  $W = \frac{1}{2} CE^2$ , it can be shown that the efficiency for converting electrical input power to the electrohydraulic is about 50%.

The energy can be fed to a variety of high speed release devices, such as the ignitron or triggered spark-gap, to provide a rapid dumping cycle.

The spark-gap switch, as shown in Fig.5 is triggered by a high voltage pulse to start conduction. The pulse is supplied by energy stored in capacitor  $C_t$  and released by the firing the SCR and automatic pulsing is possible.

However, automatic pulsing which requires an exact determination of power supply capabilities is not too common is simple electrohydraulic application. The flasher can be used to trigger the UJT. This provides additional assurance that the energy storage capacitor  $C_e$  has been charged to its maximum design potential. The method, as drawn, depict, a non-synchronized, free-running trigger mode. The UJT trigger circuit and  $C_e$  's charging rate must be synchronized for marine and related application.

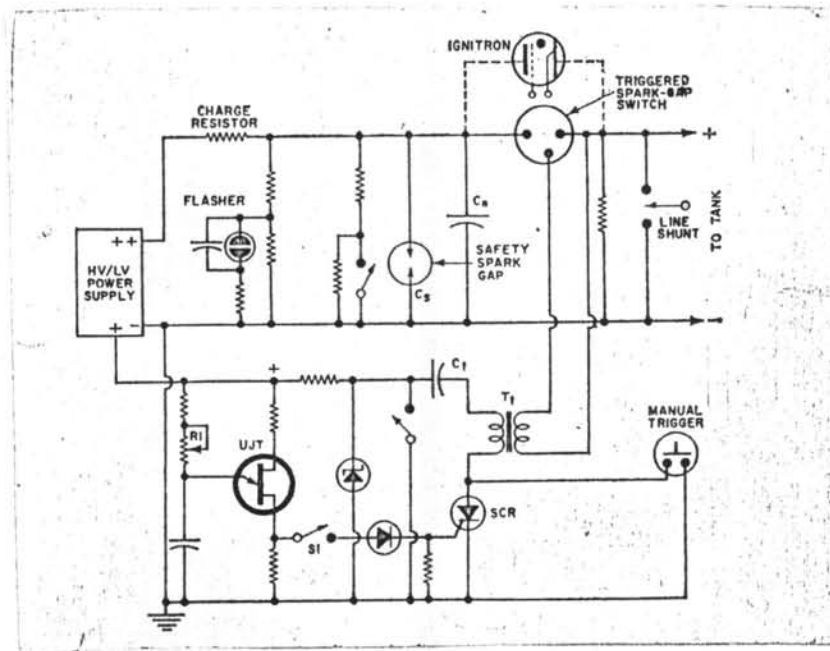

Fig.5-Power Unit Schematic Diagram. Either a Trigger Spark Gap or Ignitron Can Be Used to Discharge Capacitor  $C_e$  into an External Work Circuit.