

เอกสารอ้างอิง

1. Faires, V.M. Design of Machine Elements. 4 th Edition.
New York : Macmillan Company, 1965
2. Wahl, A.M. Mechanical Springs. Mc Graw - Hill Book Co.,
1963.
3. Timoshenko, S. Elements of Strength of Materials. 5 th
Edition. New York : D. Van Nostrand Company,
1968
4. Rothbart, H.A. Mechanical Design and Systems Handbook,
New York : Mc Graw - Hill Book Co., 1964

ภาคผนวก

แบบประกอบและแบบแยกชิ้นส่วน

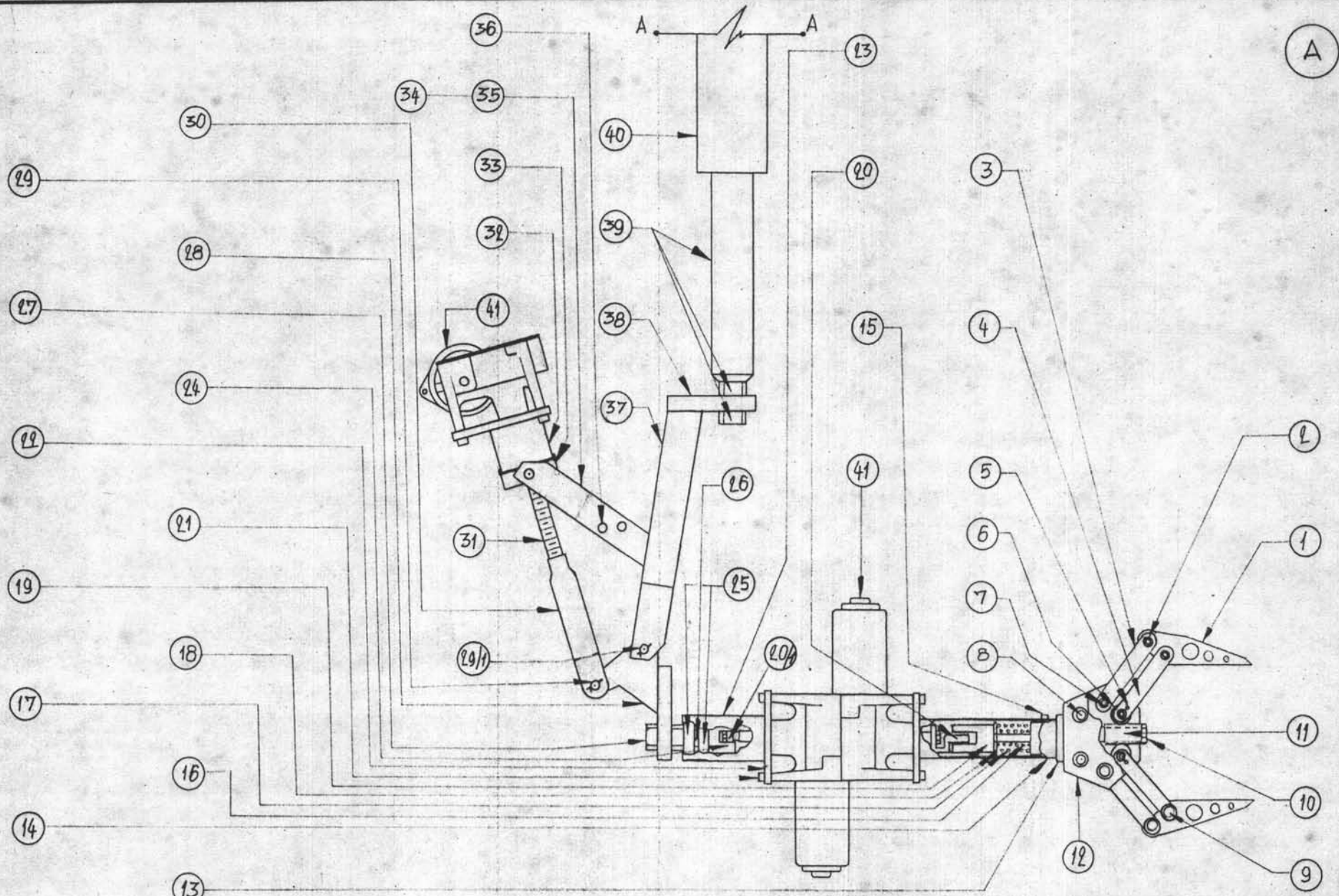

No. of Piece	Nomenclature	Pos No.	Mat/Dim.
List of Parts			
Scale [SKETCH]			Name: <i>சாதினா முத்துமணி</i>
			Date: 1 / 9 / 24

B

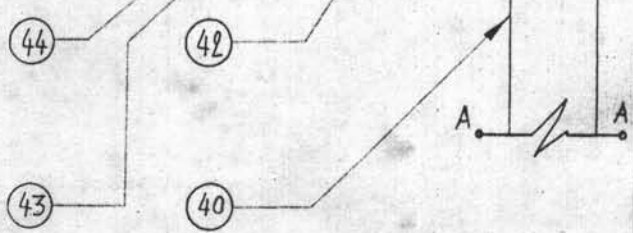
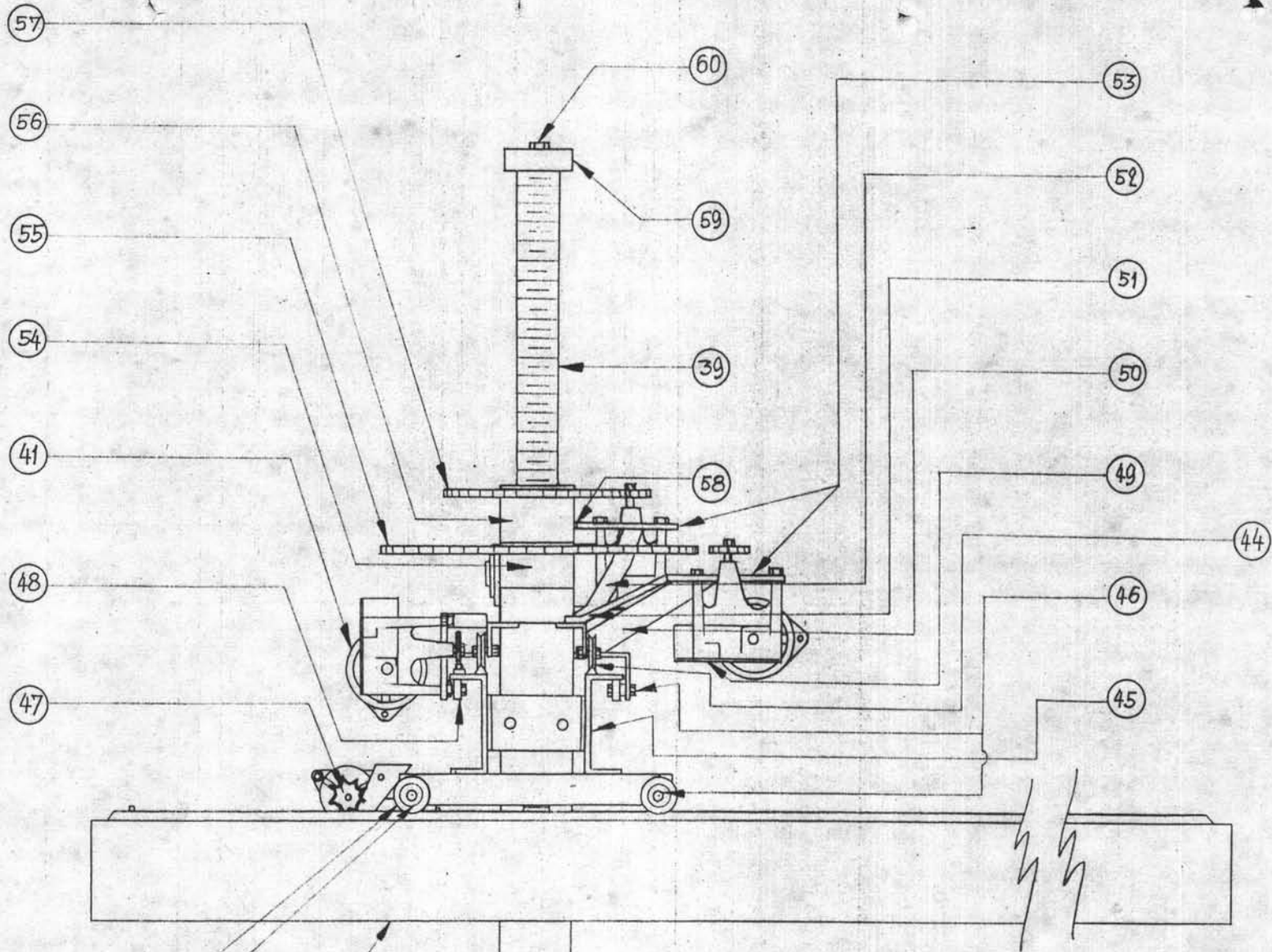

No. of Piece	Nomenclature	Pos No.	Mat/Dim.
List of Parts			
Scale [SKETCH]			Name: <i>SAIBU IMANUD</i>
			Date: 1/9/24

1		24	St.37	φ10×86
1		23	St.37	φ45×66
3	ฐานมอเตอร์	22	St.37	88×85×4
3	BOLT	21	St.37	φ8×133
2		20/1	St.37	22×12×5
1		20	St.37	43×22×20
1		19	St.37	φ18×138
1	แหวนรอง	18	St.37	φ29×2
1	สปริง	17	D20×d2×42; 9 ขด	
1	สปริง	16	D13×d1.5×55; 12 ขด	
1	สลัก	15	M6×10	
1		14	St.37	φ42×107
1		13	St.37	φ48×55
2		12	St.37	96×64×5
1	ตัวหนอน	11	St.37	φ12×29
1	น๊อต	10	M6	
4	สลักและน๊อตพร้อมแหวนรอง AL.	9	M5×29	
6	สลักและน๊อตพร้อมแหวนรอง AL.	8	M6×45	
4	BUSH	7	BRASS	φ9×18
2	เฟืองหนอน	6	St.37	φ26×8
2	สลัก	5	St.37	φ5×17
4	LINK OF FINGER	4	St.37	75×15×4
4	LINK OF FINGER	3	St.37	75×15×4
4	BUSH	2	BRASS	φ10×9
2	FINGER	1	St.37	100×43×8
No. of Piece	Nomenclature	Pos No.	Mat/Dim.	

List of Parts

Scale

Name: สมชาย วัฒนวิเศษ

Date: 1/9/24

4	BALL BEARING	48	$\phi_1 10$	$\phi. 26$
4	เฟืองขับ	47	St.37	$\phi 40 \times 3$
12	สลักและน๊อต	46	M10	$\times 30$
1	ฐานรวมเลือนชุดบน	45	U3"; L1/L"; L1'; L2'	
8	ล้อ	44	St.37	$\phi 43 \times 8$
8	BALL BEARING	43	$\phi_1 10$	$\phi. 26$
1	ฐานรวมเลือนชุดล่าง	42	U3"; L1/L"	
7	มอเตอร์	41	12V.	ปิดหน้าฝนรถยนต์
1	ปลอกเพลลา ไตรรงค์ตั้งล้อ	40	St.37	$\phi 60 \times 468$
1	เพลลา	39	St.37	$\phi 36 \times 1023$
1		38	St.37	$67 \times 27 \times 10$
1		37	St.37	$185 \times 30 \times 16$
2	สลักและน๊อต	36	M8	$\times 30$
1		35	St.37	$90 \times 29 \times 7$
1		34	St.37	$110 \times 29 \times 8$
1		33	St.37	$62 \times 42 \times 17$
1		32	St.37	$\phi 42 \times 46$
1	BOLT สวมติดกับชิ้นที่ 31.	31	St.37	$\phi 14 \times 10L$
1		30	St.37	$20 \times 20 \times 108$
1	สลัก	29/1	St.37	$\phi 10 \times 28$
1	สลัก	29	St.37	$\phi 10 \times 30$
1		28	St.37	$96 \times 58 \times 26$
2	น๊อต	27	M16	
1	แหวนรอง	26	St.37	$\phi 21 \times 5$
1	BALL BEARING	25	$\phi_1 17$	$\phi. 40$
No. of Piece	Nomenclature	Pos No.	Mat/Dim.	
List of Parts				
Scale		Name: <i>สมชาย วัฒนรัตน์</i>		Date: <i>1/9/24</i>
—				

1	ฉีกกล่องวางรวมคุม	68	Al. 500x350x2
1	ฉีกกันหน้ากล่อง	67	Al. 500x100x2
1	ฉีกด้านบนกล่อง	66	Al. 500x60x2
2	ฉีกด้านข้างกล่อง	65	Al. 350x250x2
1	ฉีกด้านหลังกล่อง	64	Al. 500x250x2
1	แผ่นสลักไม้บนกล่อง	63	Al. 500x350x2
1	โครงกล่องวางรวมคุม	62	St.37 500x350x250
1	วางรวมคุม	61	
1	สลัก	60	M6x15
1	ฝาปิดหัวเพลลา	59	St.37 $\phi 43 \times 16$
1	ขารองรับฐานมอเตอร์	58	St.37 95x25x4
1	เฟืองพานจักรยานขับโดยโซ่	57	40 ฟันเชื่อมต่อกับชิ้น 56
1	ฐานเฟืองพานขับเพลลา ชิ้น - ดง	56	St.37 $\phi 48 \times 43$
1	เฟืองพานจักรยานขับโดยโซ่	55	52 ฟันเชื่อมต่อกับชิ้น 54
1	ฐานเฟืองพานขับเพลลาให้หมุนรอบแกน	54	St.37 $\phi 51 \times 18$
2	ฐานมอเตอร์	53	St.37 105x85x4
1	ขารองรับฐานมอเตอร์	52	St.37 120x25x4
1	ขารองรับฐานมอเตอร์	51	St.37 78x25x4
1	ขารองรับฐานมอเตอร์	50	St.37 100x25x4
7	ชุดเฟืองทดติดมากับมอเตอร์	49	

No. of Piece	Nomenclature	Pos No.	Mat/Dim.
--------------	--------------	---------	----------

List of Parts

Scale		Name: สุรชัย วัฒนวิทย์
—		Date: 1/9/24

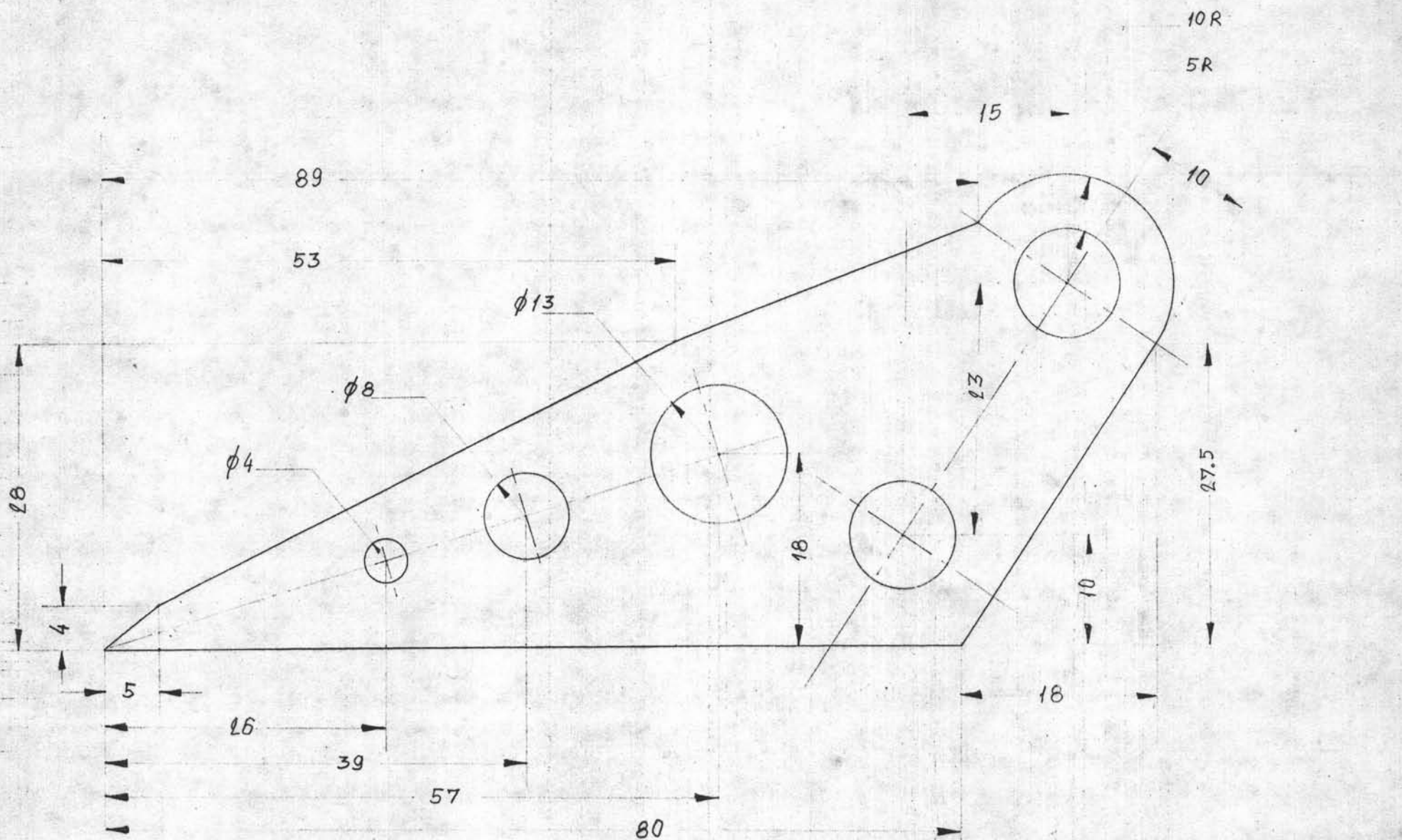

Ø117 8 mm

2	FINGER	1	St.37 100x43x8
No. of Piece	Nomenclature	Pos No.	Mat/Dim.
List of Parts			
Scale	2:1	Name:	DATE: 1/9/14

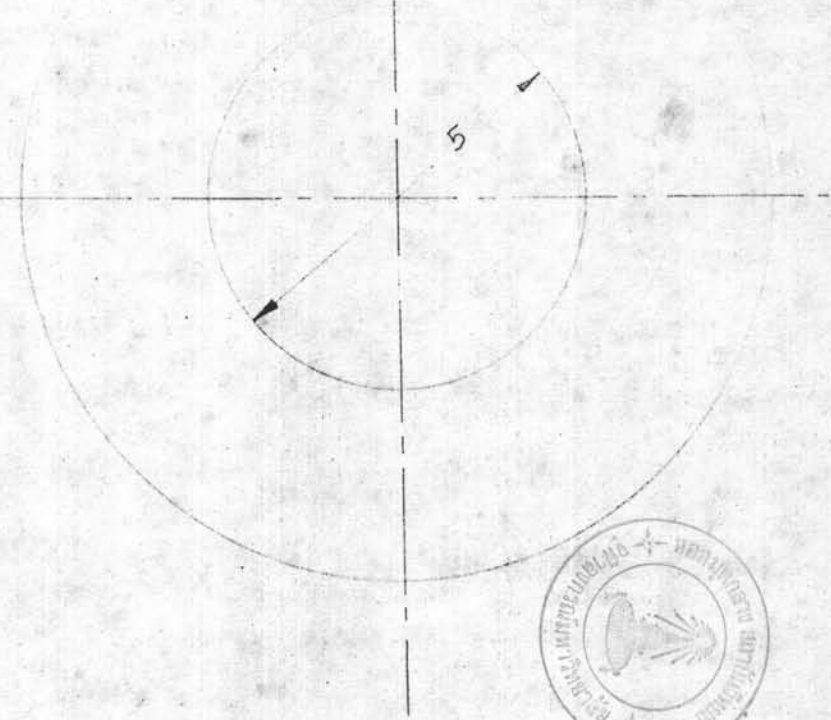
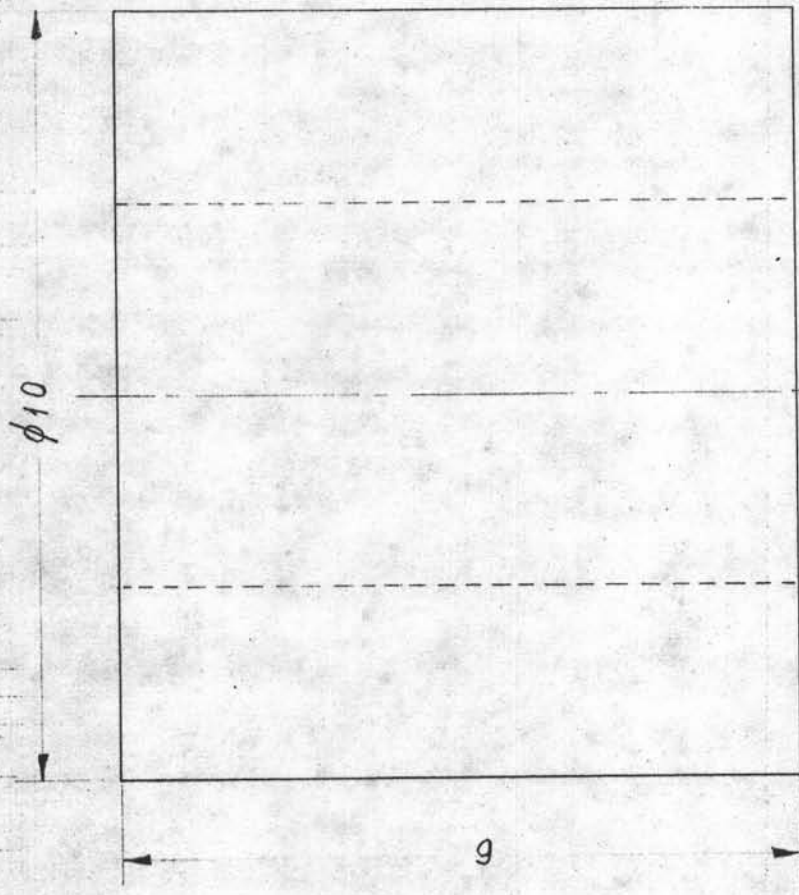

4	BUSH	2	BRASS $\phi 10 \times 9$
No. of Piece	Nomenclature	Pos No.	Mat/Dim.
List of Parts			
Scale 10:1		Name: <i>सत्यमेव जयते</i>	
		Date: 1/9/24	

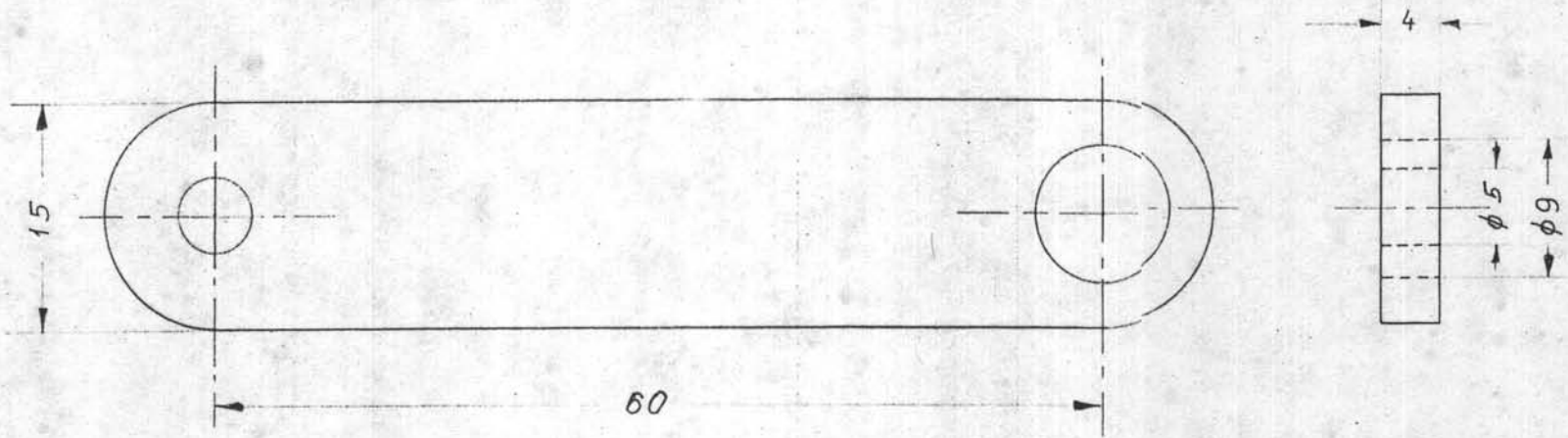

4	LINK OF FINGER	3	St.37 75x15x4
No. of Piece	Nomenclature	Pos No.	Mat/Dim.
List of Parts			
Scale	2:1	Name:	JANUJ INSAJOL
		Date:	1/9/24

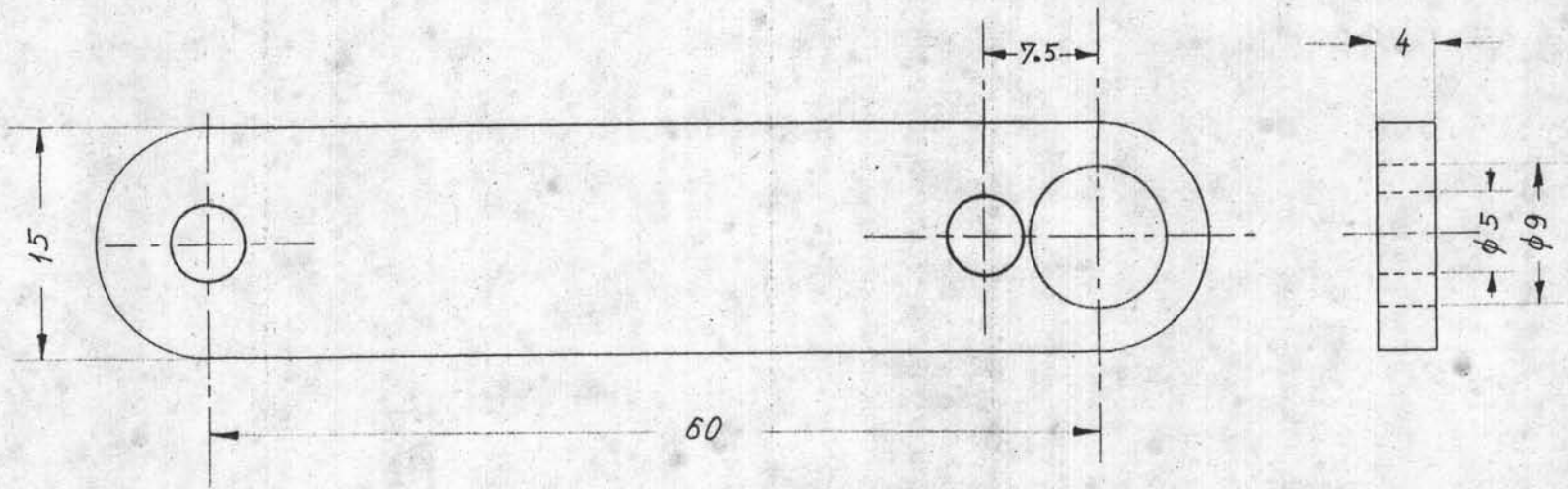

4	LINK OF FINGER	4	St.37 75x15x4
No. of Piece	Nomenclature	Pos No.	Mat/Dim.
List of Parts			
Scale	2:1	Name:	Handwritten Name
		Date:	1/9/24

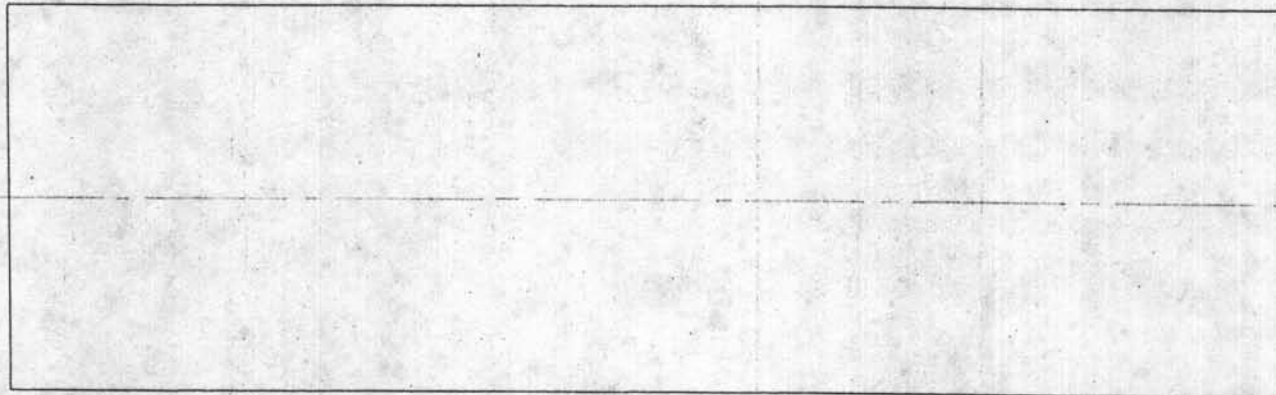

17

φ5

2	ماد	5	St.37 φ5 × 17
No. of Piece	Nomenclature	Pos No.	Mat/Dim.
List of Parts			
			Name: <i>محمد محمد</i>
Scale 10:1			Date: 1 / 9 / 24

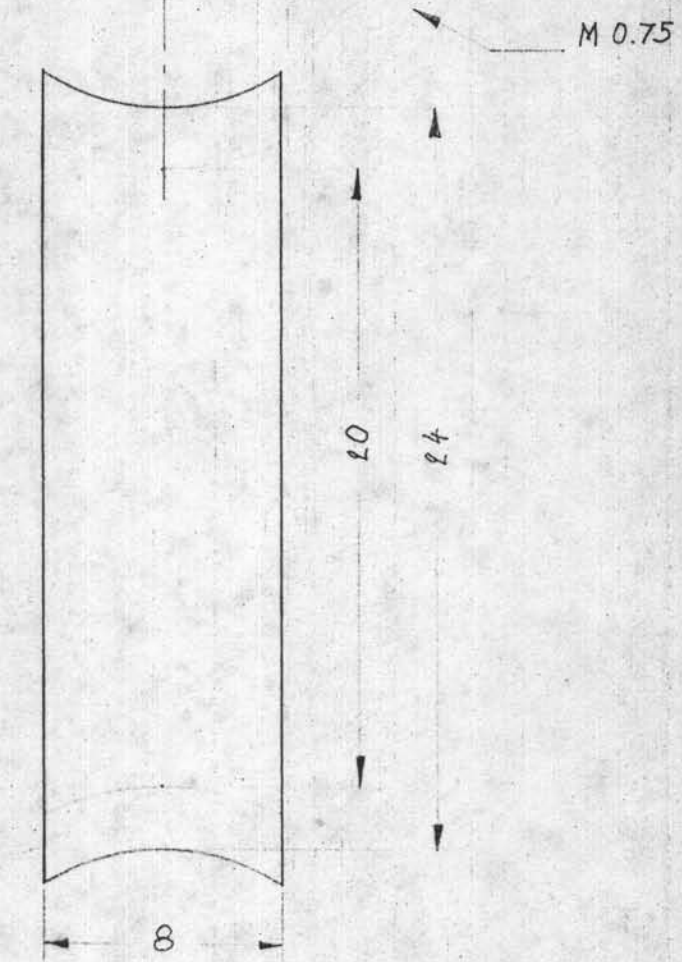
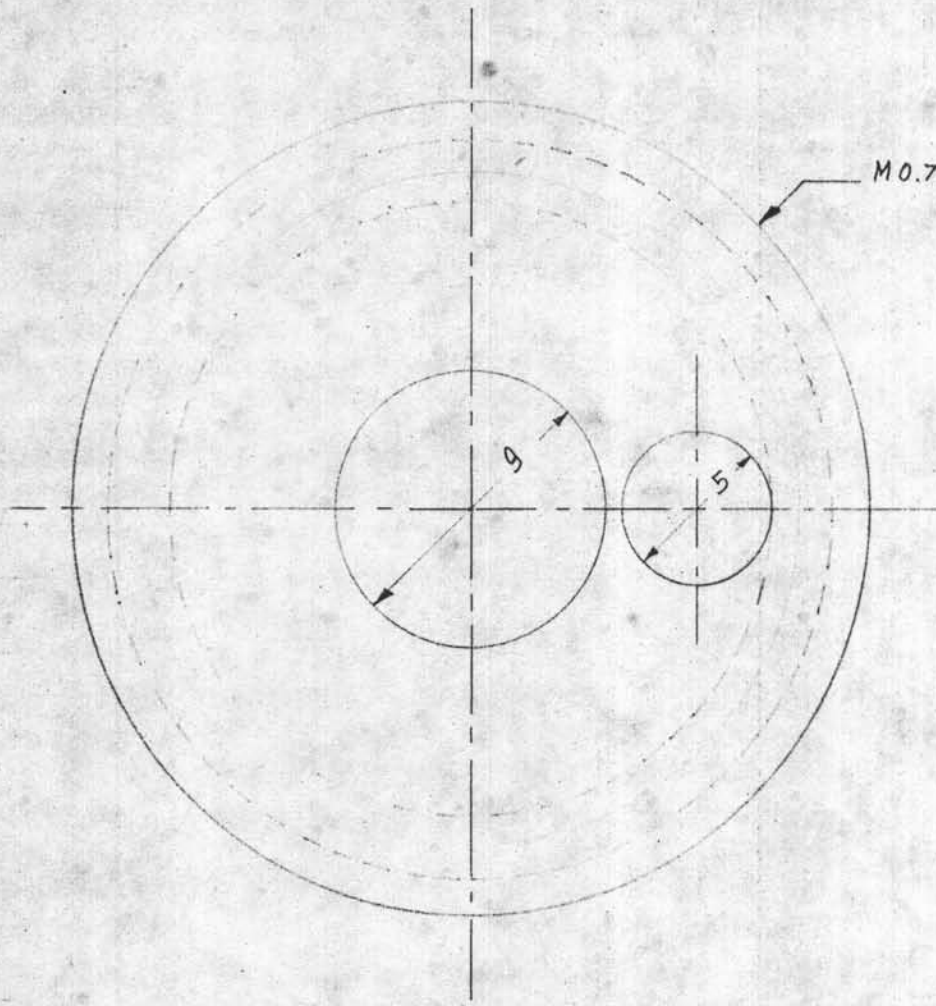

2	เฟืองท่อน	6	St.37 ϕ 26 x 8
No. of Piece	Nomenclature	Pos No.	Mat/Dim.
List of Parts			
			Name: สนิท วัฒนศิริ
Scale 4:1			Date: 1 / 9 / 24

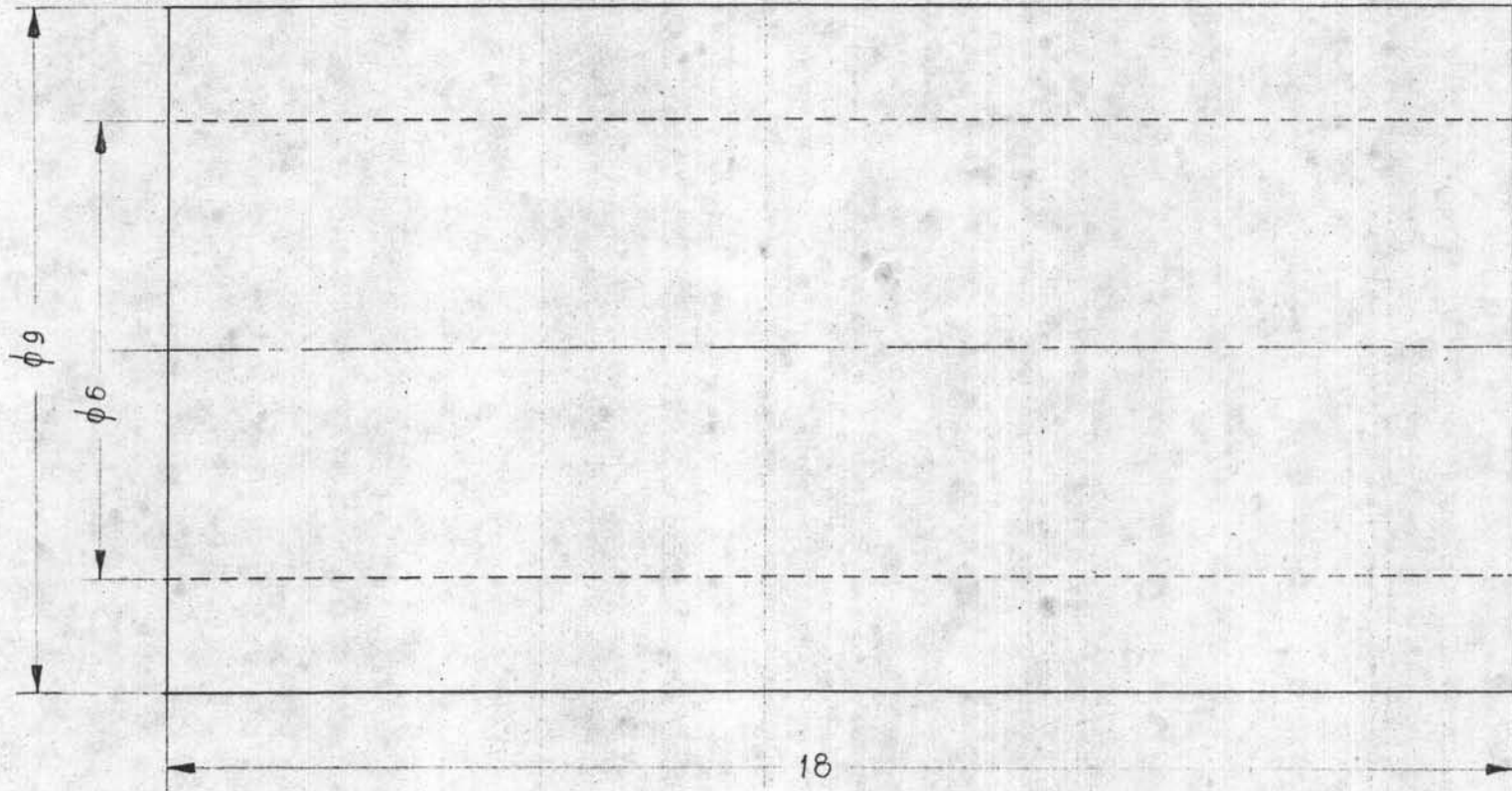

4	BUSH	7	BRASS $\phi 9 \times 18$
No. of Piece	Nomenclature	Pos No.	Mat/Dim.
List of Parts			
Scale 10:1		Name: <i>JUSU IANJUNAH</i>	Date: 1 / 9 / 24

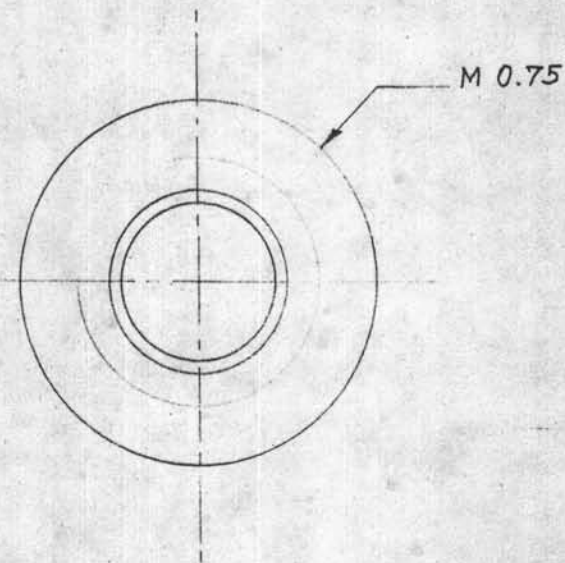
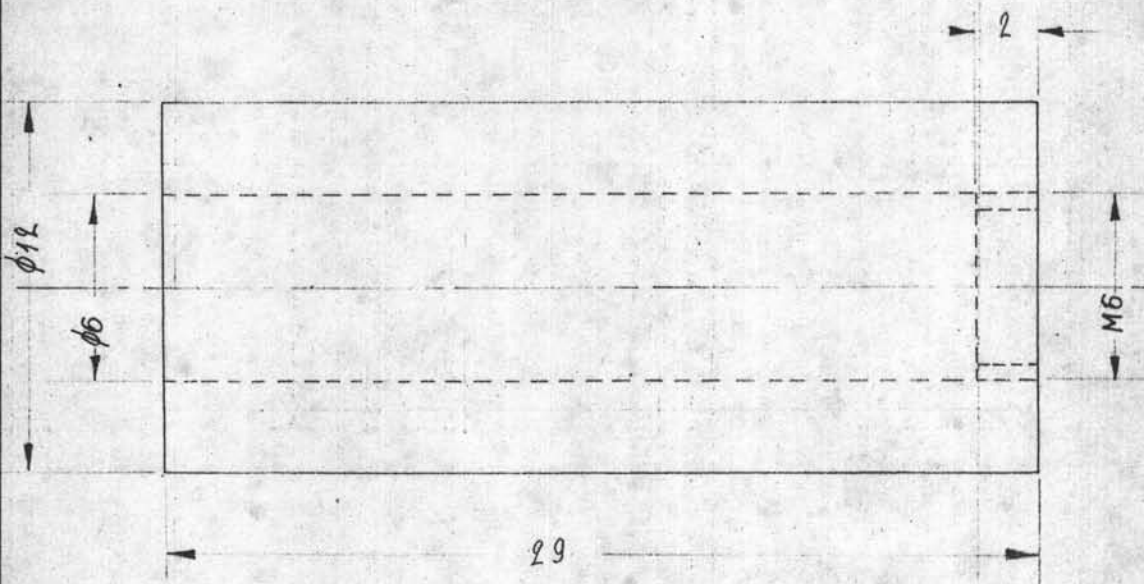

1	ທັບທອນ	11	St.37 $\phi 12 \times 29$
No. of Piece	Nomenclature	Pos No.	Mat/Dim.
List of Parts			
Scale 4:1		Name: ສາວ ນາມວິນ Date: 1 / 9 / 24	

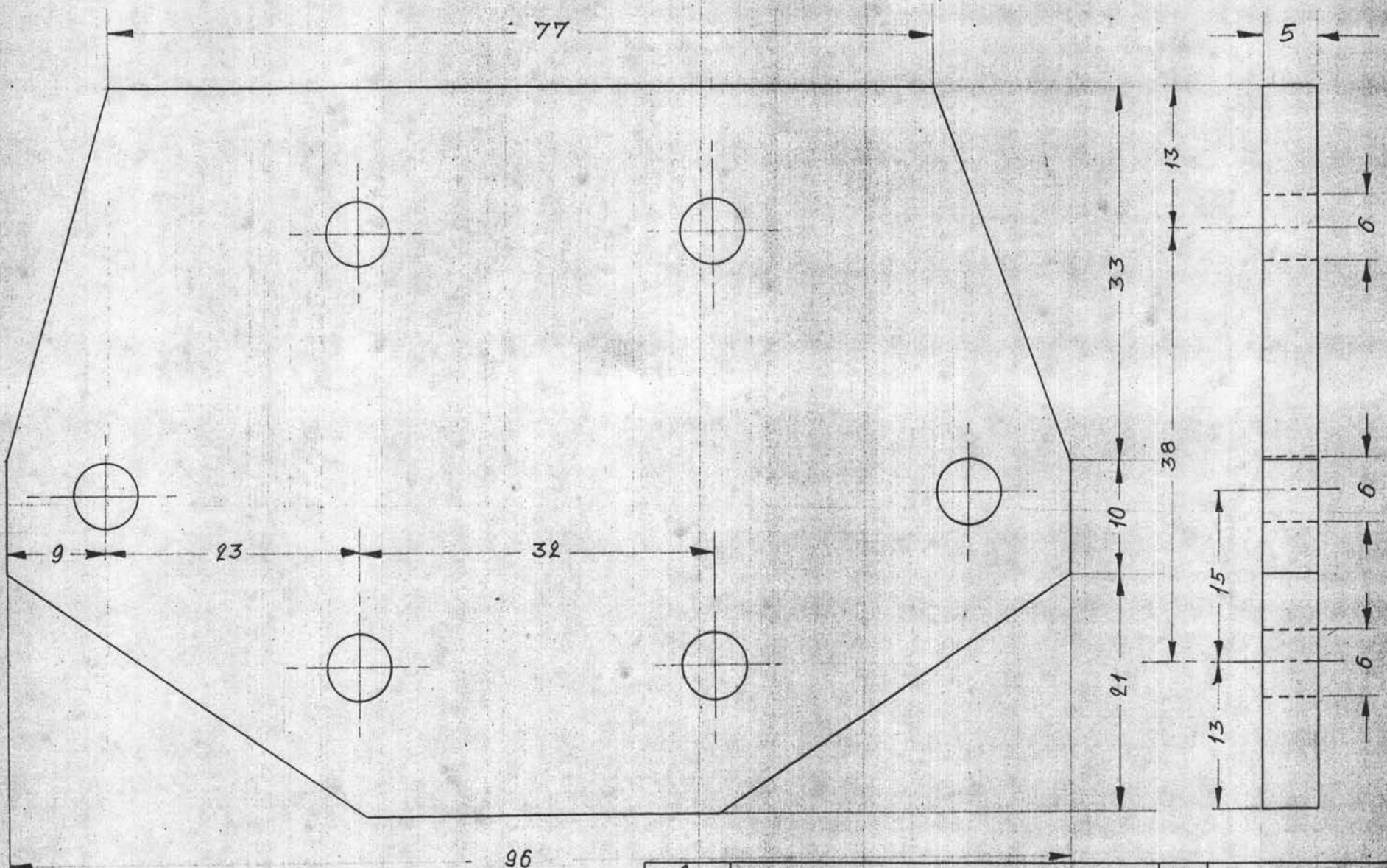

2		12	St.37 96x64x5
No. of Piece	Nomenclature	Pos No.	Mat/Dim.
List of Parts			
			Name: <i>SADE INJASA</i>
			Date: 1/9/24
Scale			
2:1			

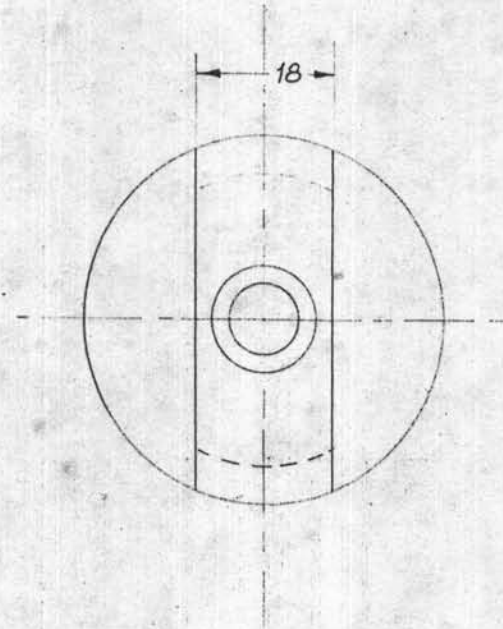
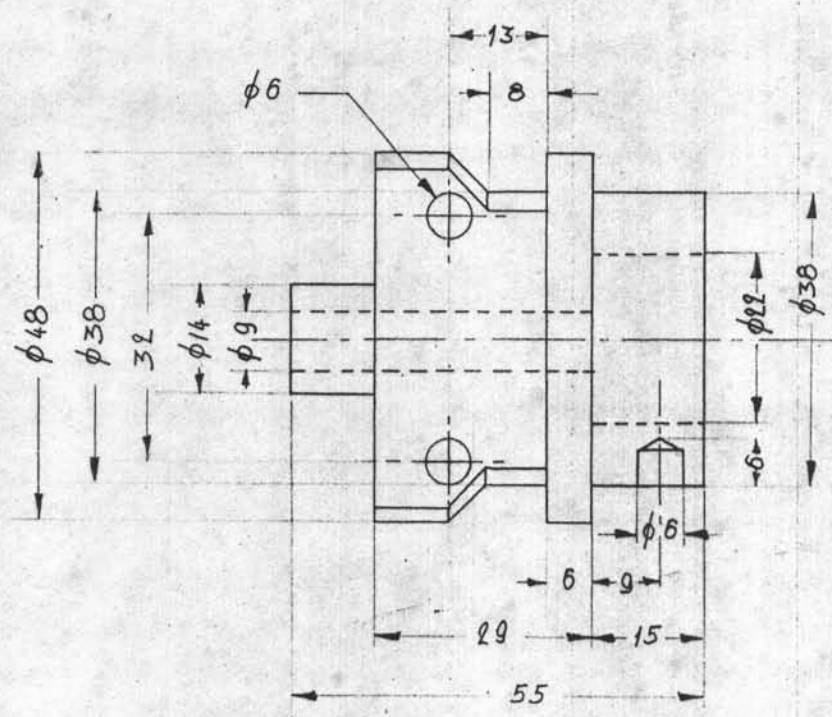

1		13	St.37 $\phi 48 \times 55$
No. of Piece	Nomenclature	Pos No.	Mat/Dim.
List of Parts			
			Name: <i>SUSEN TANUWISAN</i>
Scale		Date: 1/9/14	
1:1			

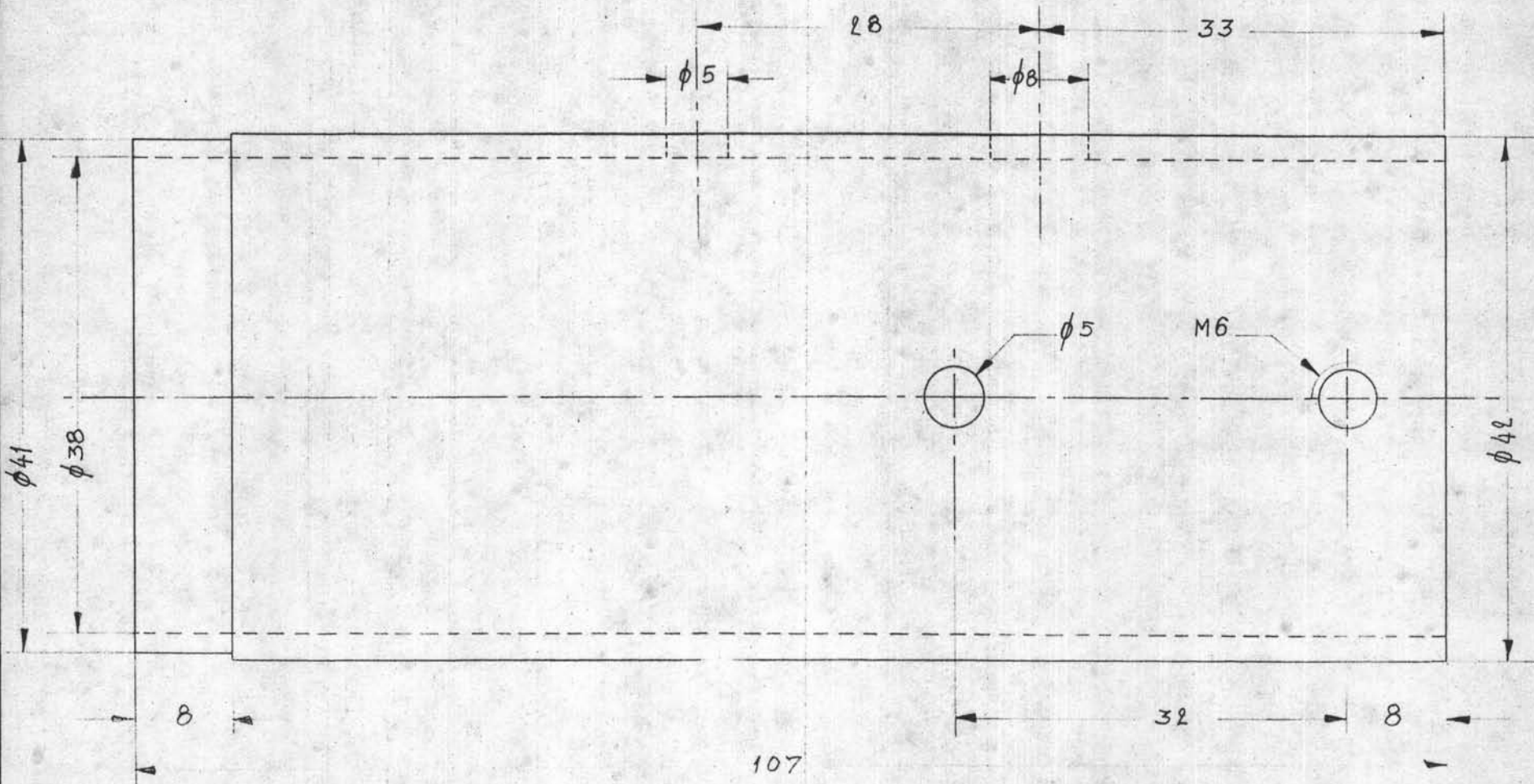

107

1		14	SE-37 $\phi 42 \times 107$
No. of Piece	Nomenclature	Pos No.	Mat/Dim.
List of Parts			
			Name: <i>د.م.م. م.م.م.م.م.</i>
Scale 2:1			Date: 1 / 9 / 24

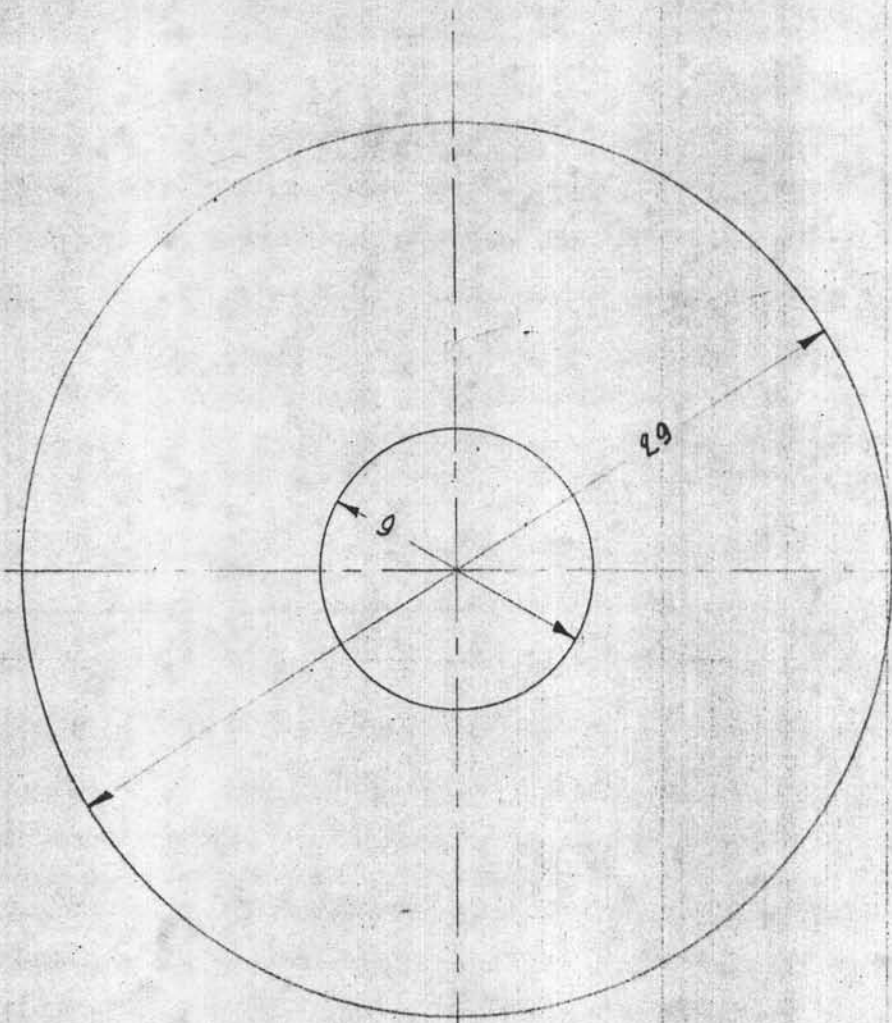

1	ИИМШРОД	18	St.37 $\phi 29 \times 2$
No. of Piece	Nomenclature	Pos No.	Mat/Dim.
List of Parts			
Scale	4:1	Name: <i>ИИМШРОД</i>	Date: 1 / 9 / 24

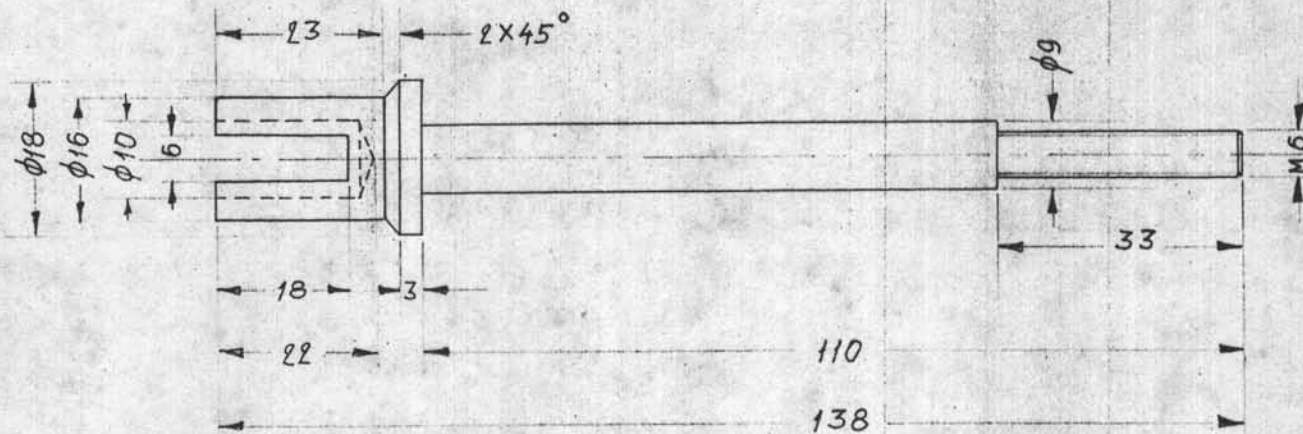

1		19	St.37 $\phi 18 \times 138$
No. of Piece	Nomenclature	Pos No.	Mat/Dim.
List of Parts			
Scale		Name: <i>...</i>	
1:1		Date: 1/9/24	

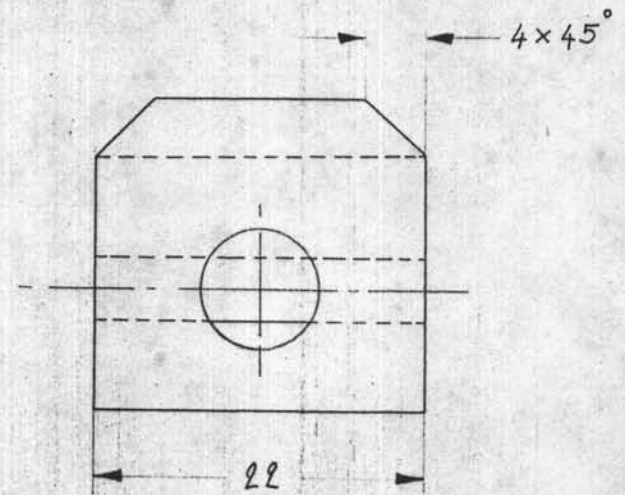
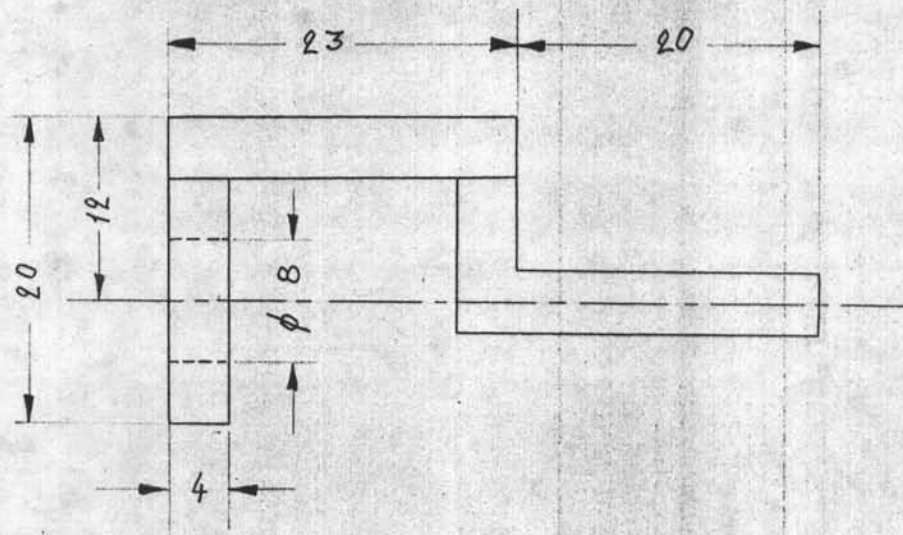

1		LO	St. 37 43x22x20
No. of Piece	Nomenclature	Pos No.	Mat/Dim.
List of Parts			
Scale	2:1	Name:	سید امجد
		Date:	1 / 9 / 24

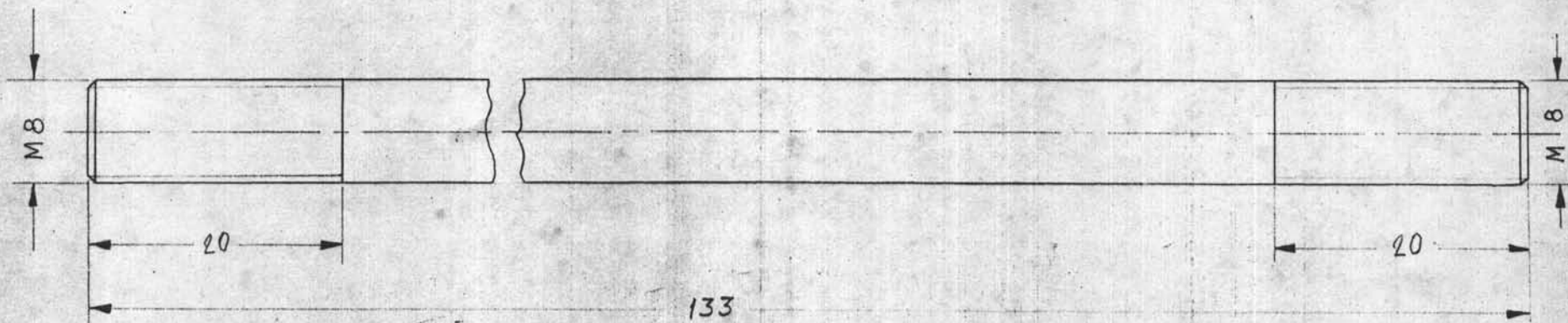

3	BOLT	21	St.37 $\phi 8 \times 133$
No. of Piece	Nomenclature	Pos No.	Mat/Dim.
List of Parts			
Scale			Name: <i>אוריאל אביב</i>
2:1			Date: 1/9/24

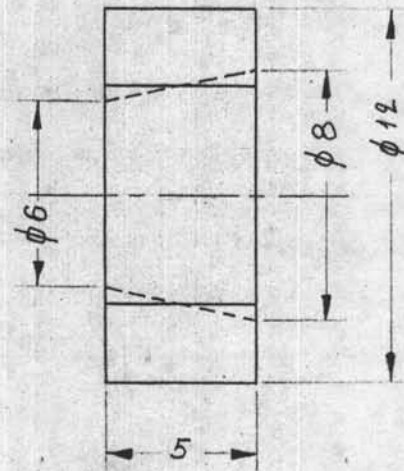
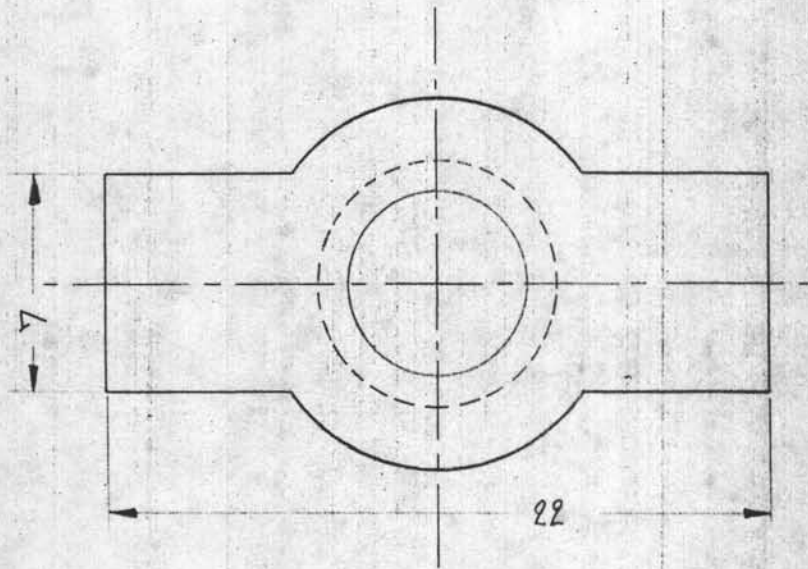

2		20/1	St.37 22x12x5
No. of Piece	Nomenclature	Pos No.	Mat/Dim.
List of Parts			
Scale 4:1		Name:	Handwritten Name
		Date:	1/0/24

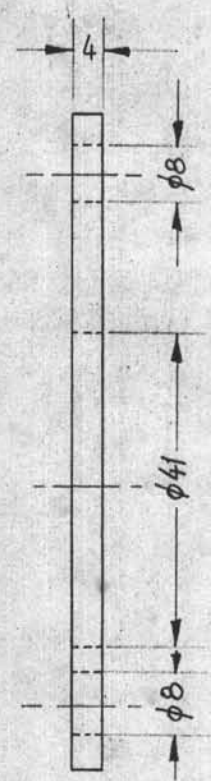
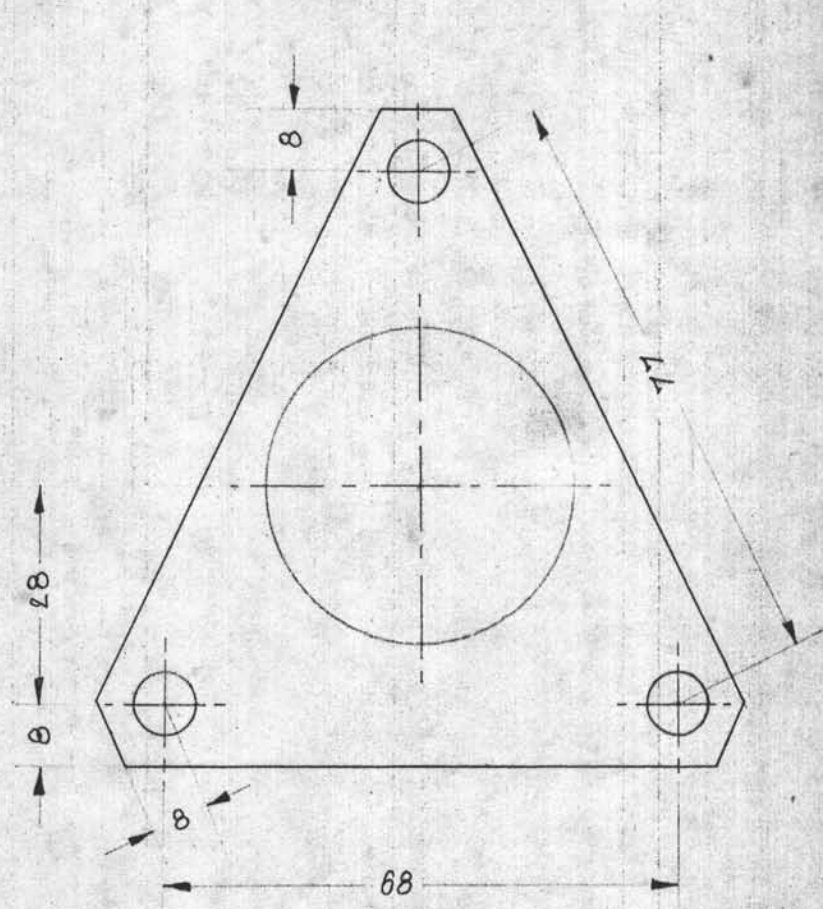

3	สามเหลี่ยม	22	St.37 68x65x4
No. of Piece	Nomenclature	Pos No.	Mat/Dim.
List of Parts			
Scale	1:1	Name: สมชาย วัฒนกุล Date: 1/9/24	

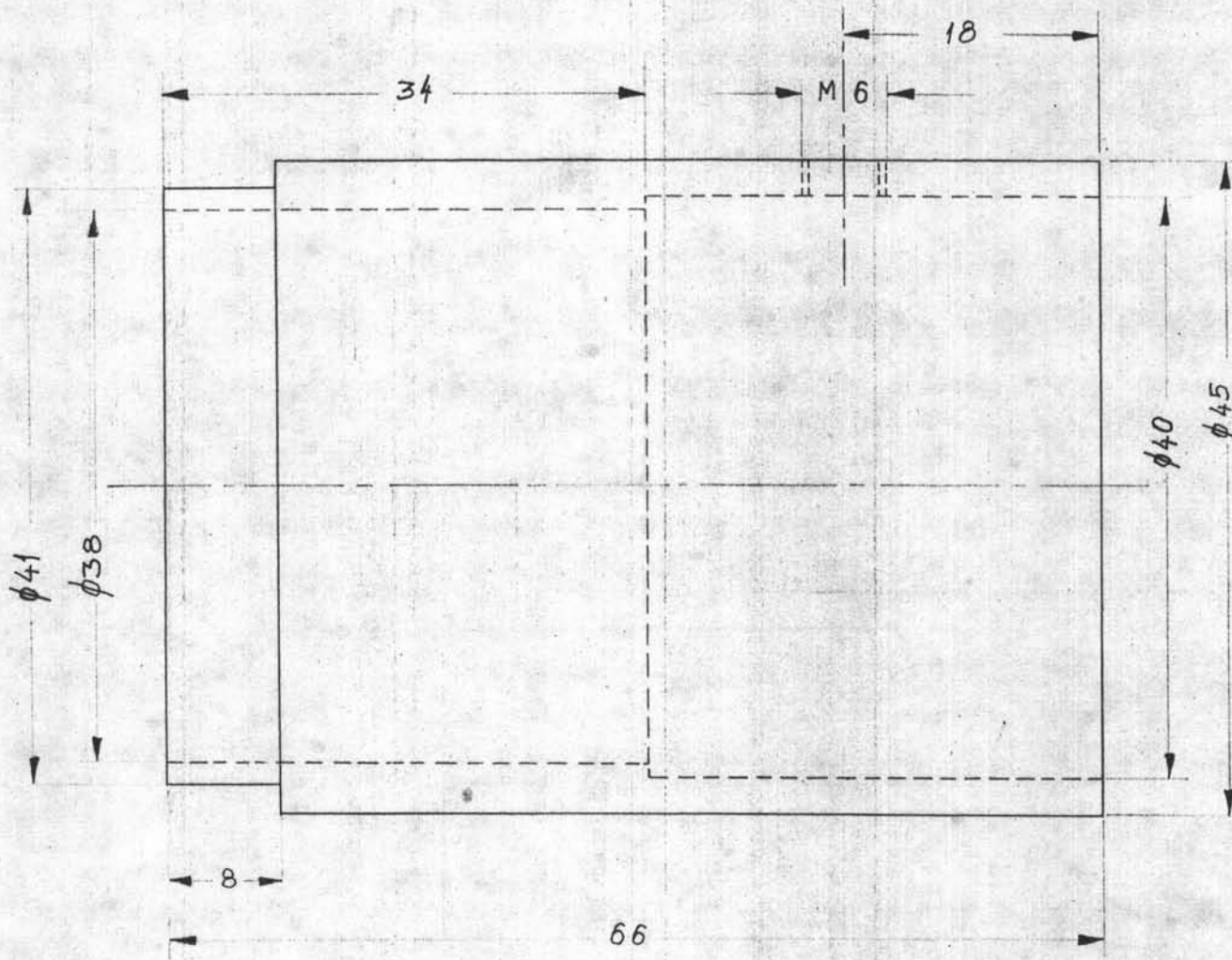

1		23	St. 37 $\phi 45 \times 66$
No. of Piece	Nomenclature	Pos No.	Mat/Dim.
List of Parts			
Scale	2:1	Name: <i>Handwritten Name</i>	
		Date: 1 / 9 / 24	

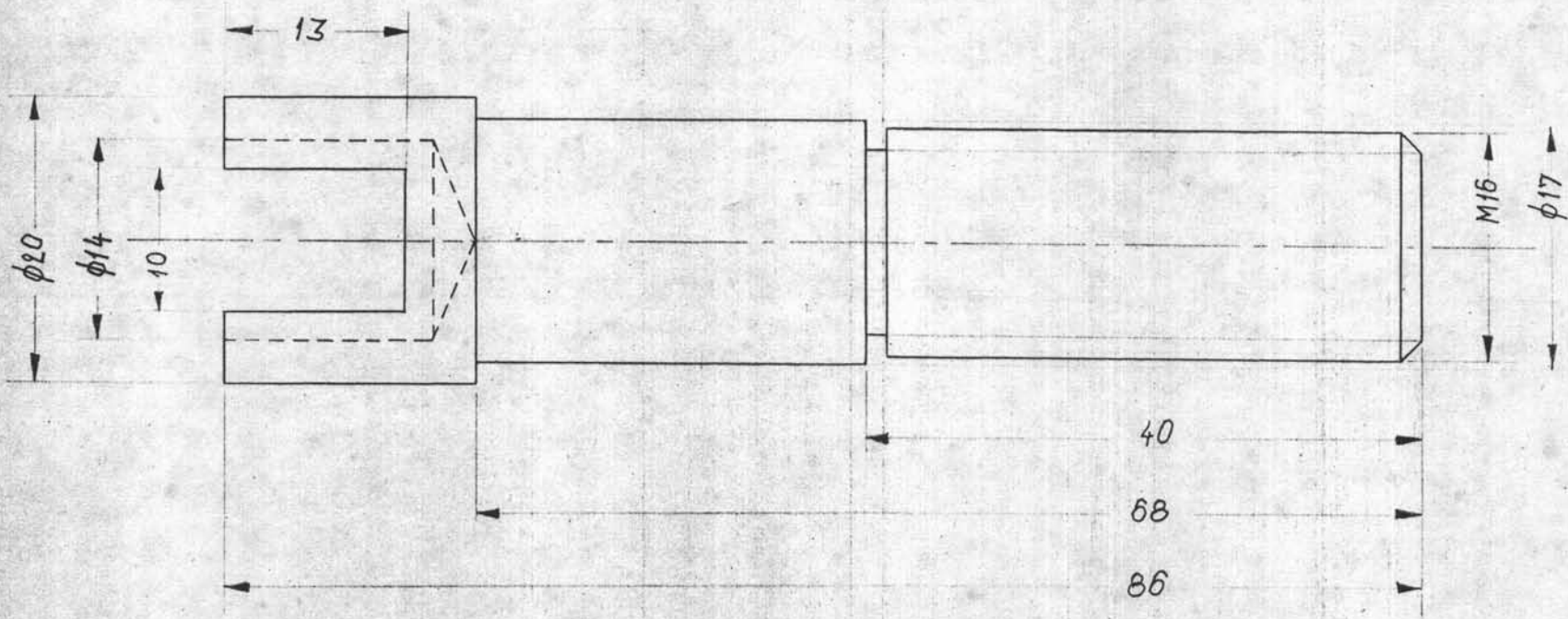

1		24	St. 37 $\phi 20 \times 86$
No. of Piece	Nomenclature	Pos No.	Mat/Dim.
List of Parts			
Scale		Name: <i>AMU IANAN SA</i>	
2:1		Date: 1 / 9 / 24	

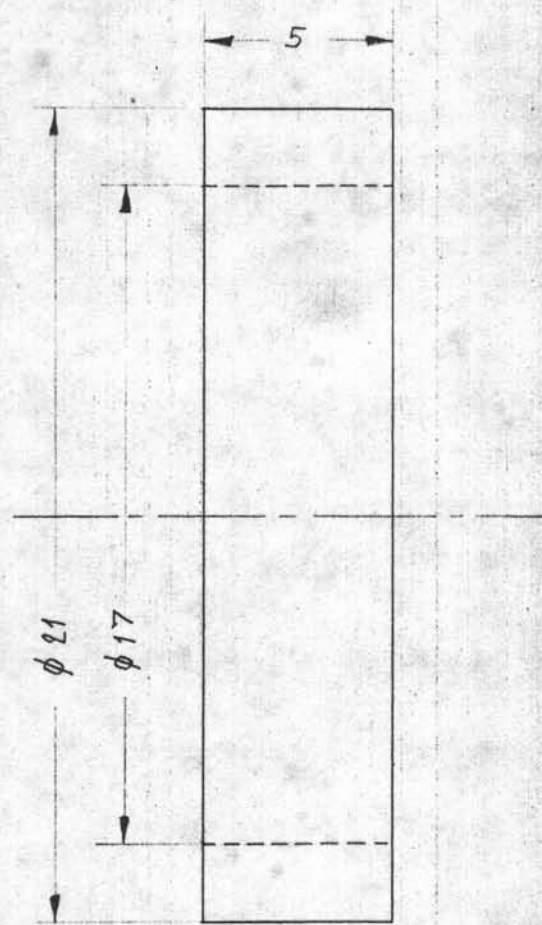

1	11974709	26	St.37 φ 21 x 5
No. of Piece	Nomenclature	Pos No.	Mat/Dim.
List of Parts			
Scale	5:1	Name:	Handwritten signature
		Date:	1 / 9 / 24

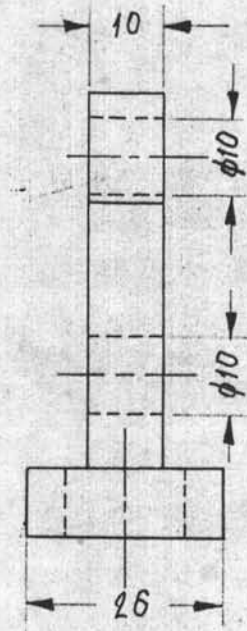
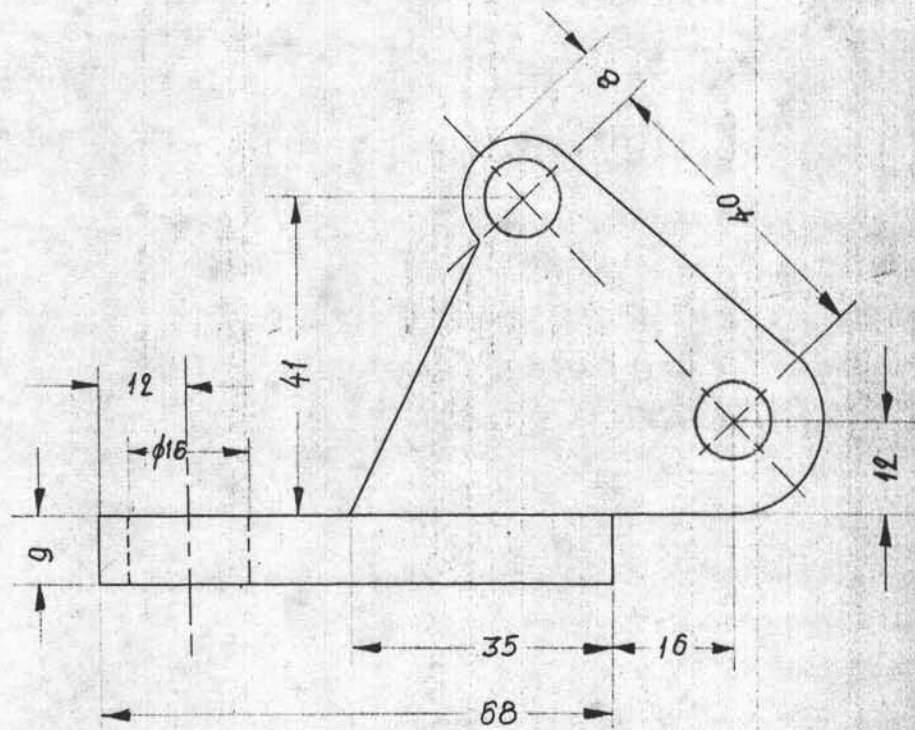

1		28	St.37 96x58x26
No. of Piece	Nomenclature	Pos No.	Mat/Dim.
List of Parts			
Scale	1:1	Name:	اسماء محمد احمد
		Date:	1 / 9 / 24

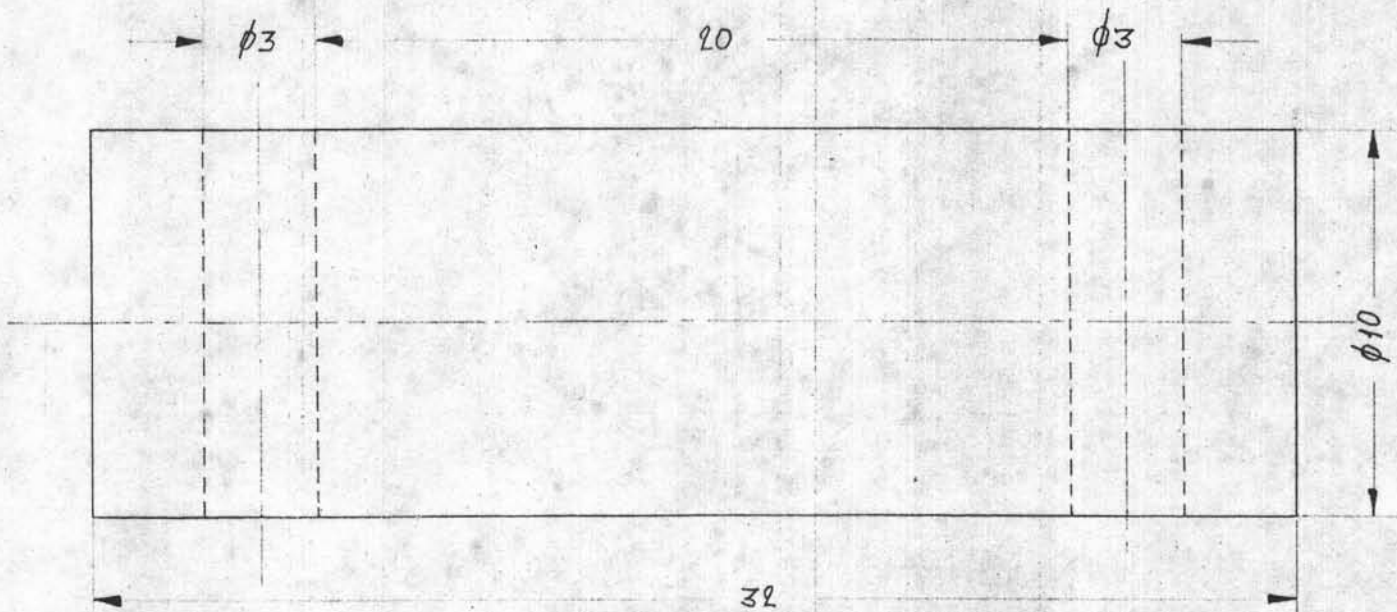

1	شفت	29	St.37 $\phi 10 \times 30$
No. of Piece	Nomenclature	Pos No.	Mat/Dim..
List of Parts			
Scale 5:1		Name: <i>Amr Mohamed</i> Date: 1 / 9 / 24	

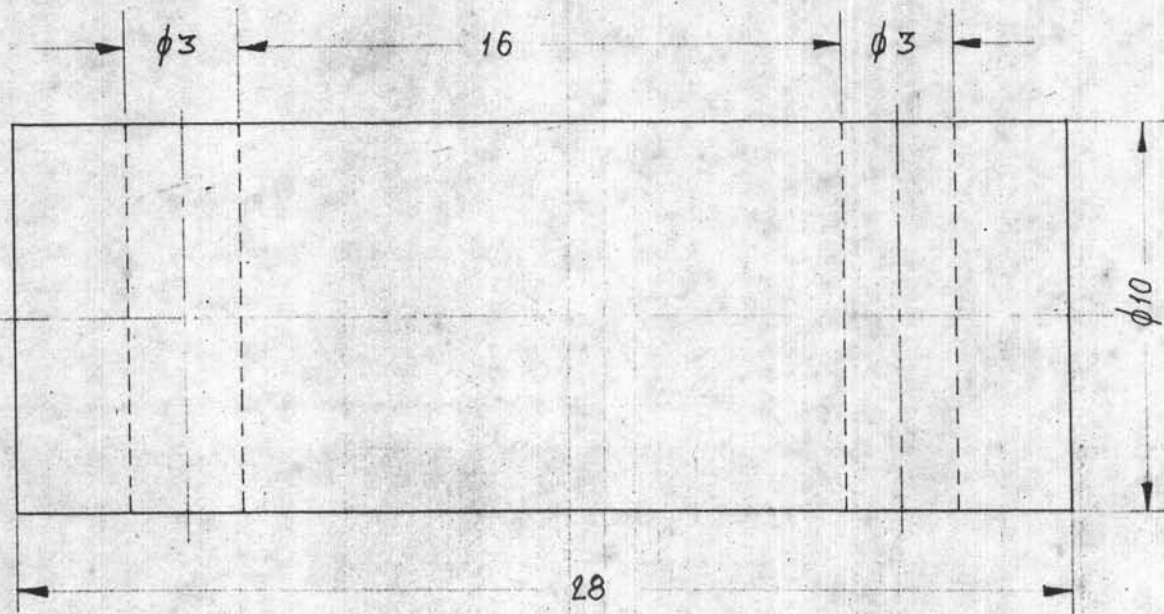

1	شفت	20/1	St.37 φ10 × 28
No. of Piece	Nomenclature	Pos No.	Mat/Dim.
List of Parts			
Scale 5:1		Name: <i>د. محمد / محمد / محمد</i> Date: 1 / 9 / 24	

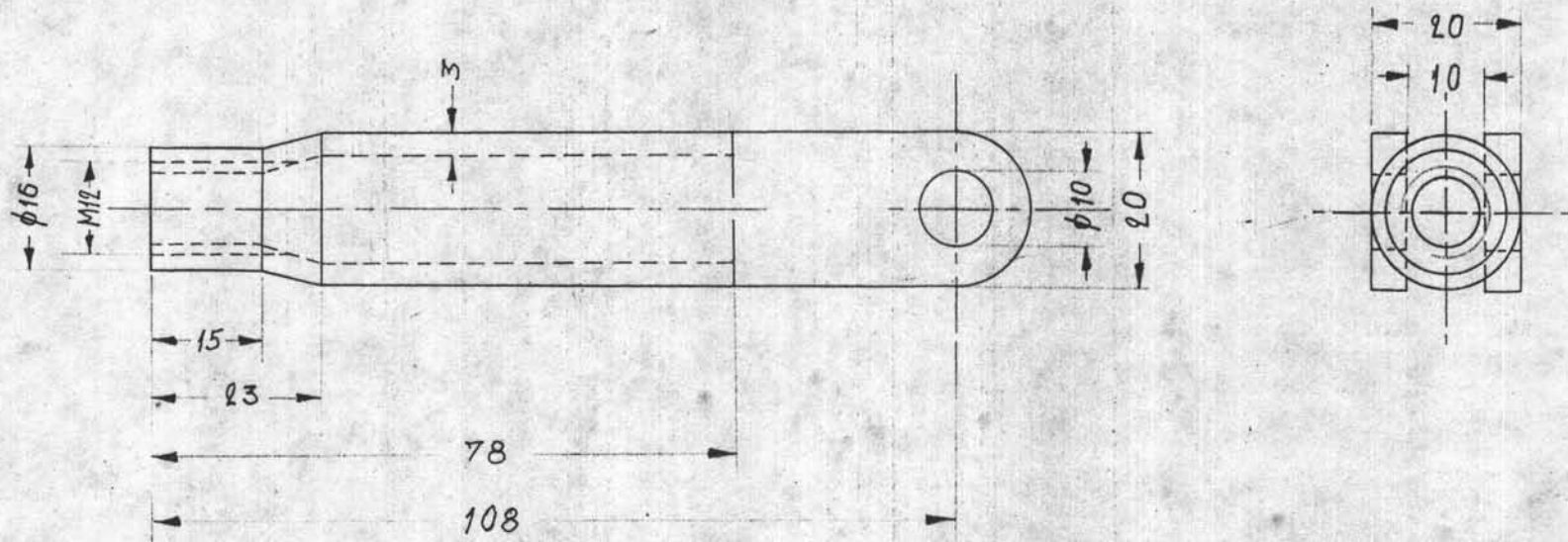

1		30	St.37 20x20x108
No. of Piece	Nomenclature	Pos No.	Mat/Dim.
List of Parts			
Scale 1:1		Name: <i>ANBU IANUSIA</i>	
		Date: 1 / 9 / 24	

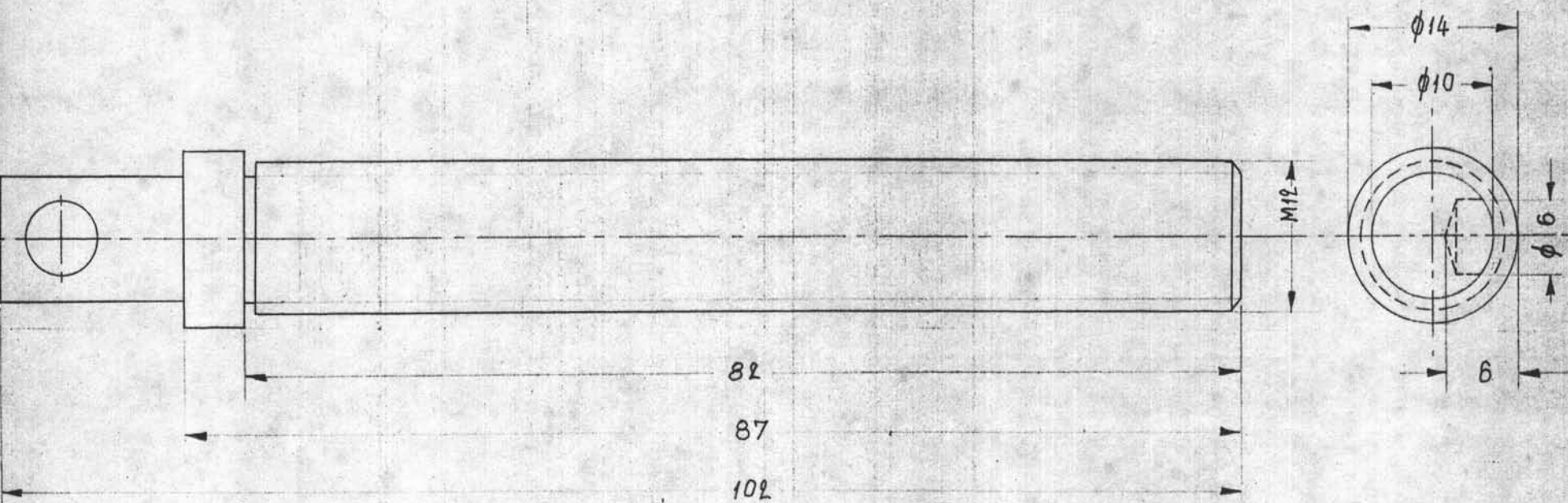

1	BOLT	31	St. 37 $\phi 14 \times 102$
No. of Piece	Nomenclature	Pos No.	Mat/Dim.
List of Parts			
			Name: <i>ASD</i>
Scale			Date: 1 / 9 / 24
2:1			

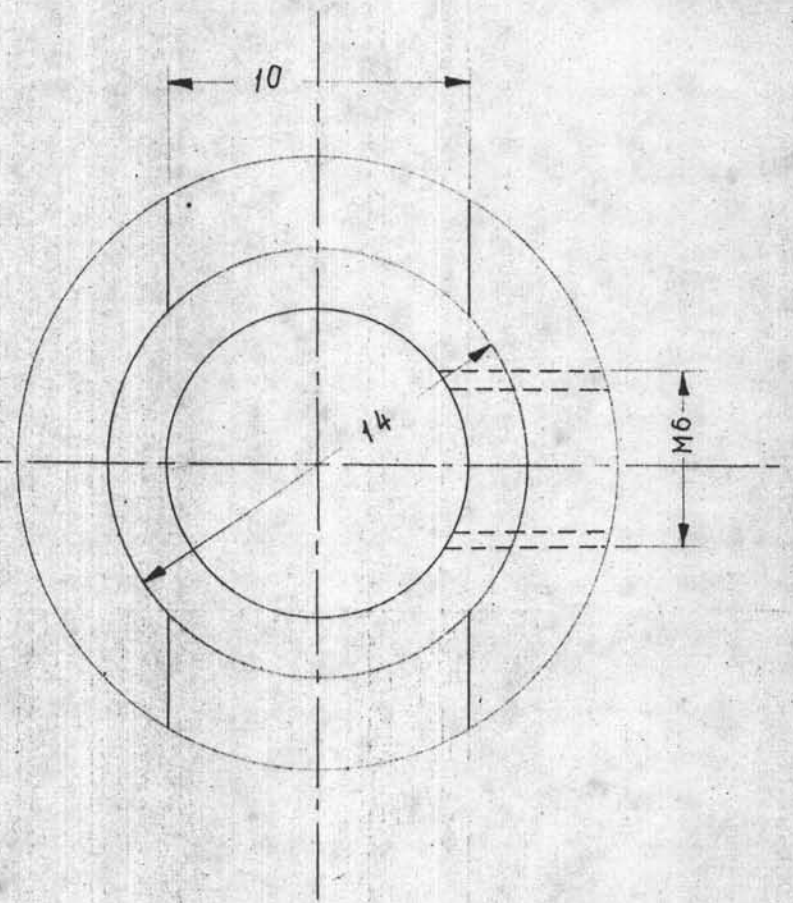
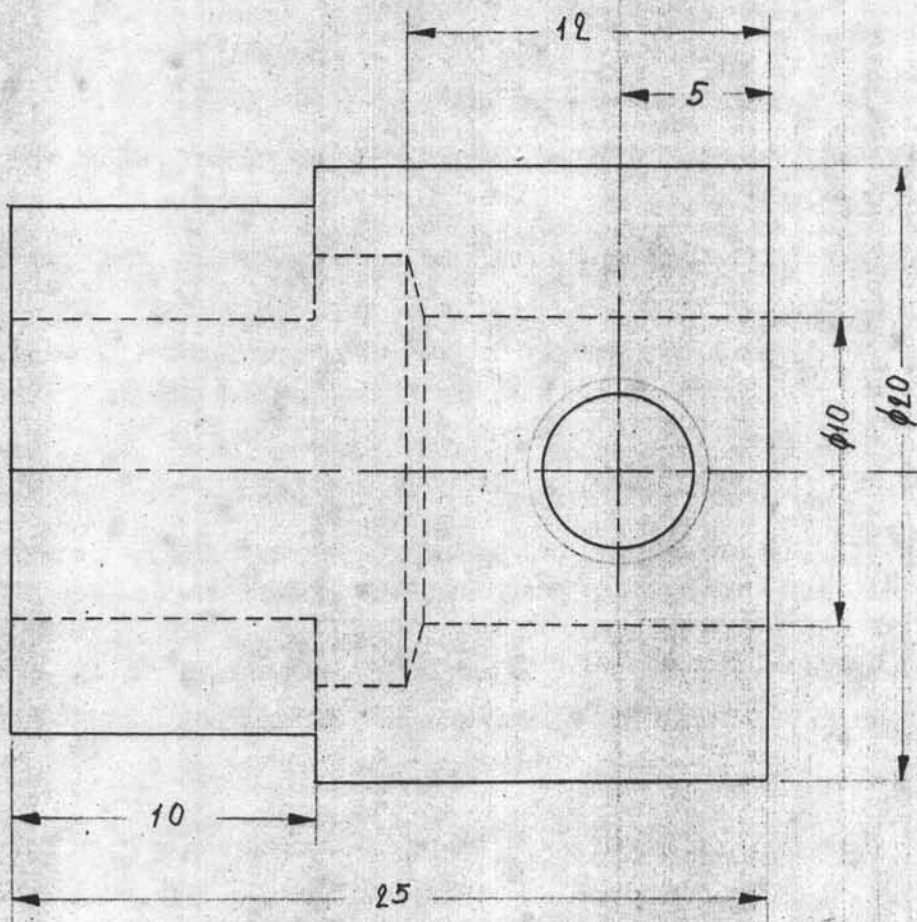

1		31	St.37 $\phi 20 \times 15$
No. of Piece	Nomenclature	Pos No.	Mat/Dim.
List of Parts			
Scale		Name: <i>ANIS IMAN</i>	
4:1		Date: 1/9/24	

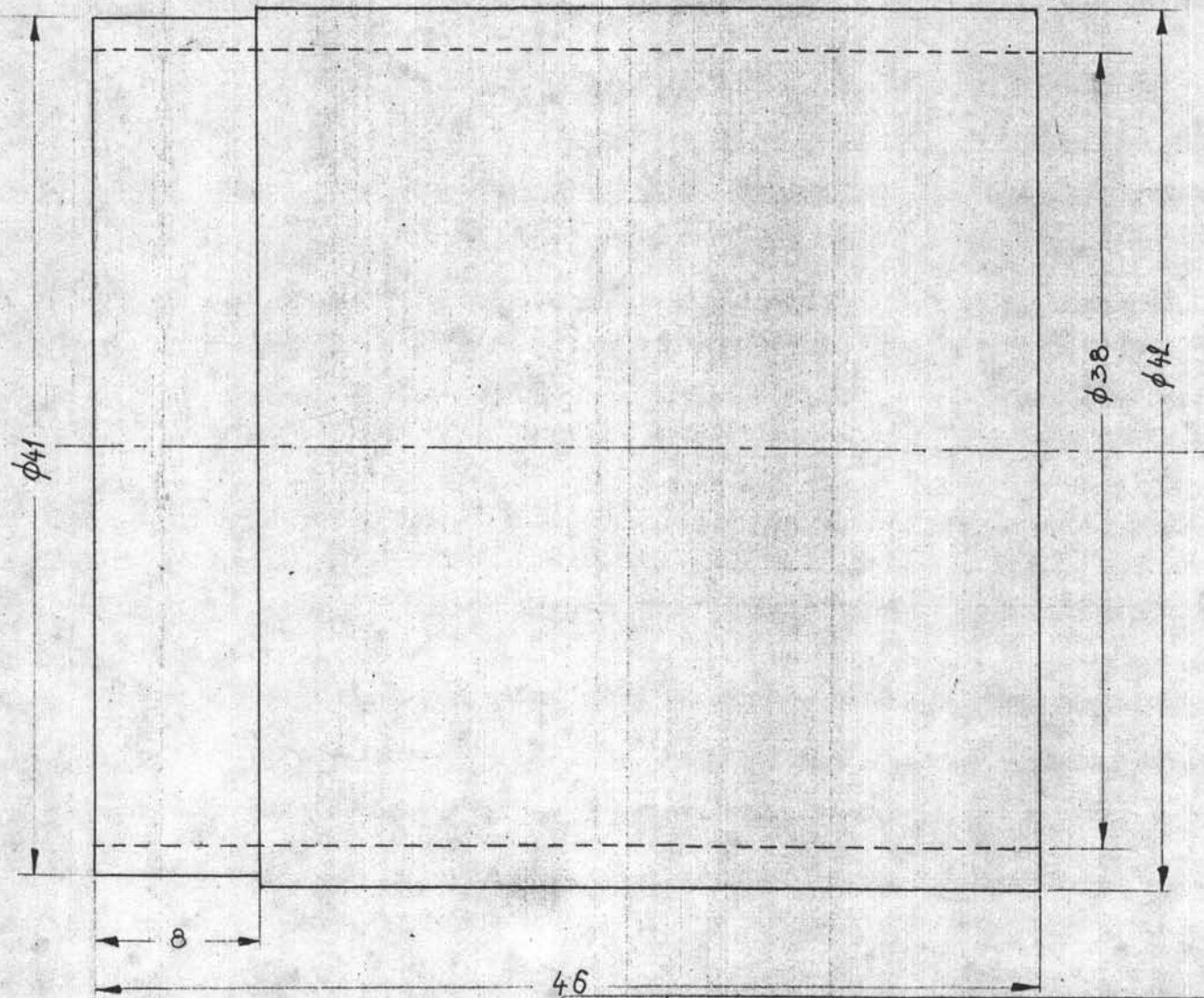

1		32	ST.37 $\phi 42 \times 46$
No. of Piece	Nomenclature	Pos No.	Mat/Dim.
List of Parts			
Scale		Name: <i>AMU IMSDA</i>	
3:1		Date: 1/9/24	

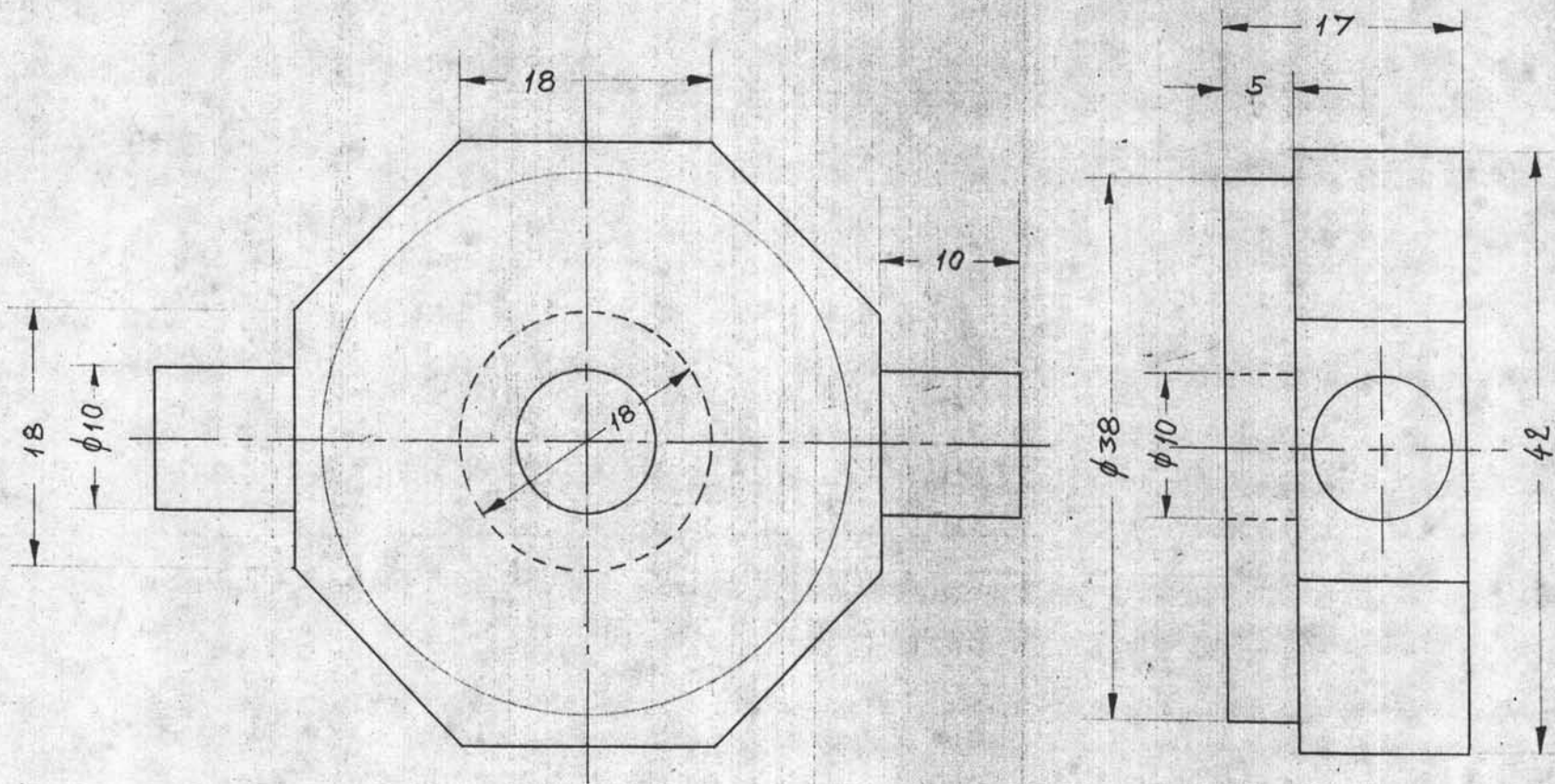

1		33	St.37 62x42x17
No. of Piece	Nomenclature	Pos No.	Mat/Dim.
List of Parts			
Scale		Name: <i>ANDU IMANIND</i>	
2:1		Date: 1 / 9 / 24	

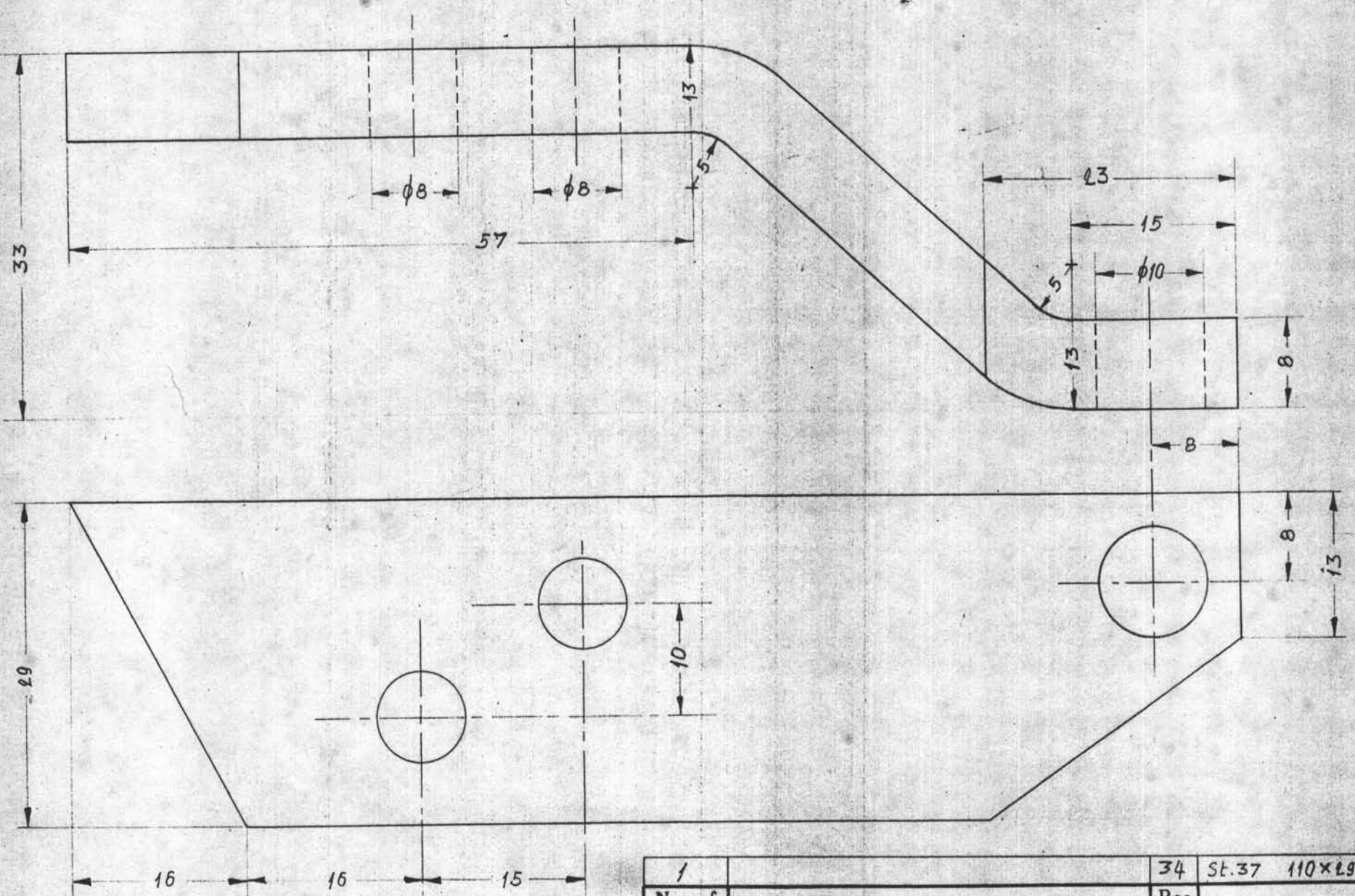

1		34	St.37 110x29x8
No. of Piece	Nomenclature	Pos No.	Mat/Dim.
List of Parts			
Scale 2:1		Name: <i>Handwritten Name</i>	
		Date: 1/9/24	

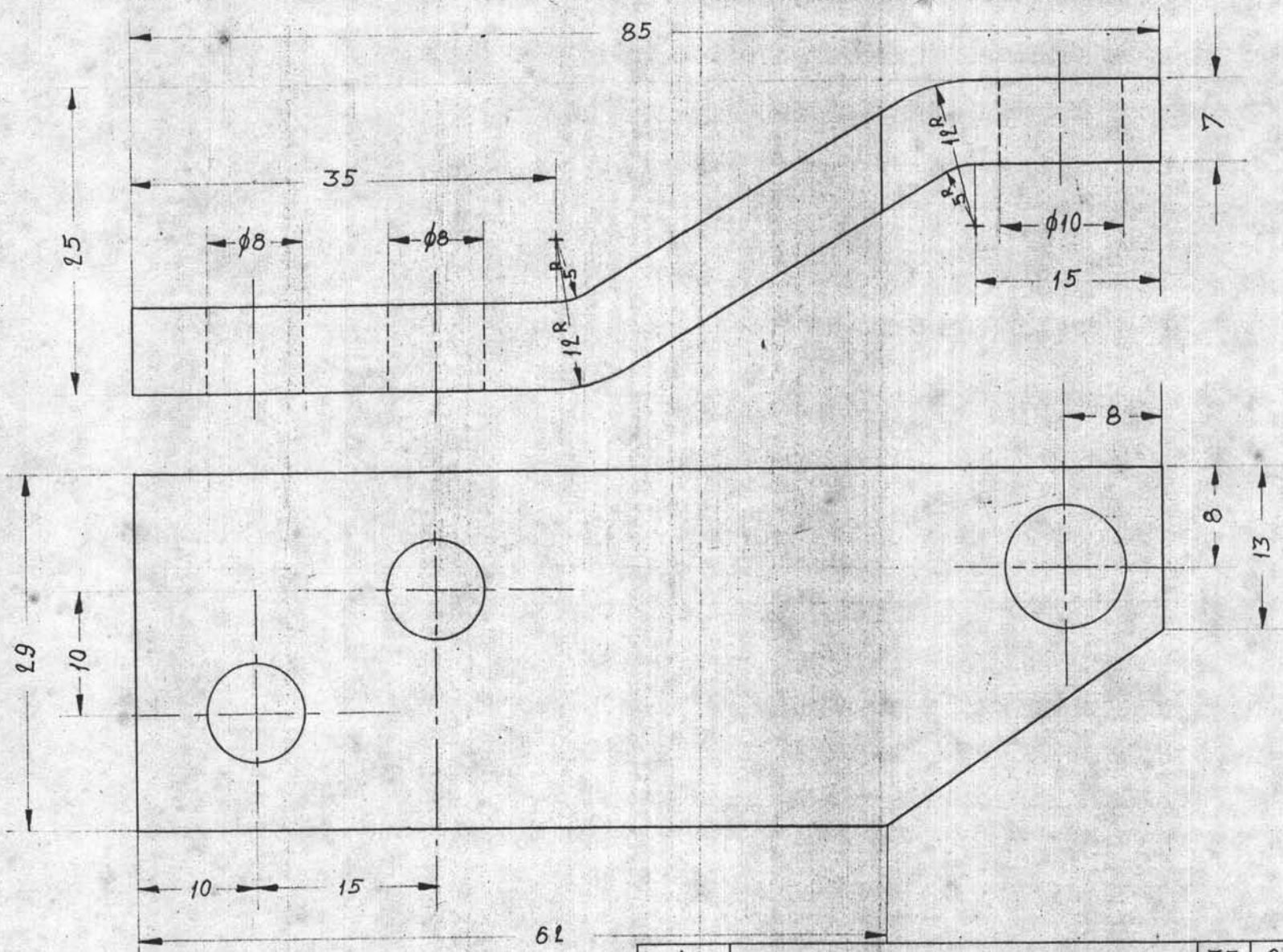

1		35	St.37 90x10x7
No. of Piece	Nomenclature	Pos No.	Mat/Dim.
List of Parts			
Scale 2:1		Name: <i>SAUDU MAMUDU</i>	
		Date: 1/9/24	

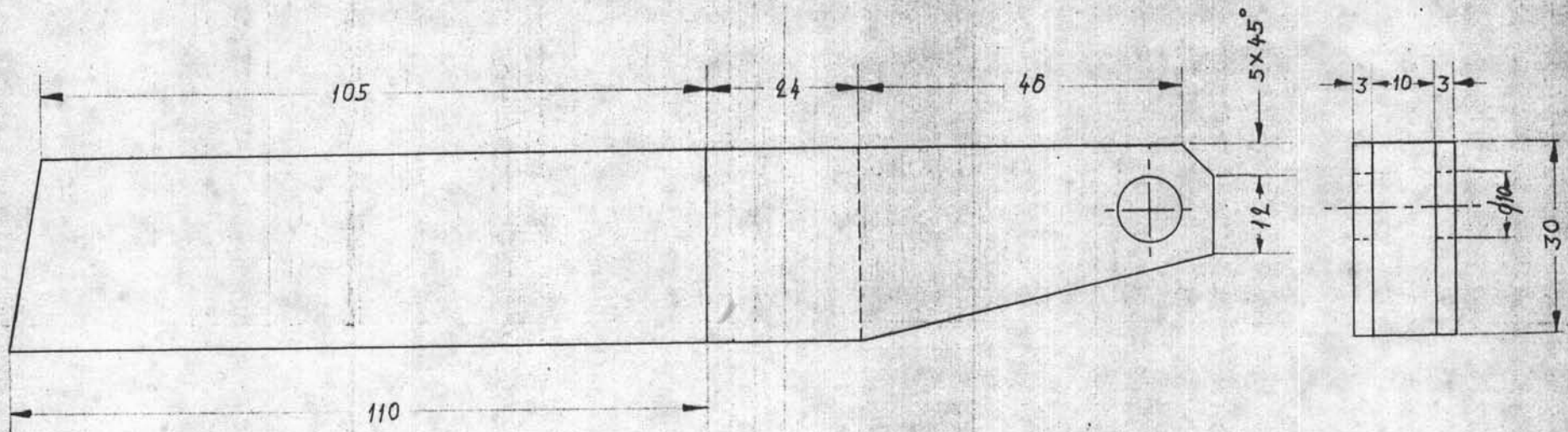

1		37	St.37 185x30x16
No. of Piece	Nomenclature	Pos No.	Mat/Dim.
List of Parts			
			Name: <i>ANON INSURER</i>
Scale			Date: 1/9/24
1:1			

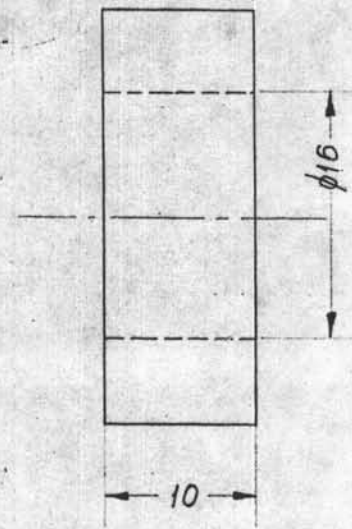
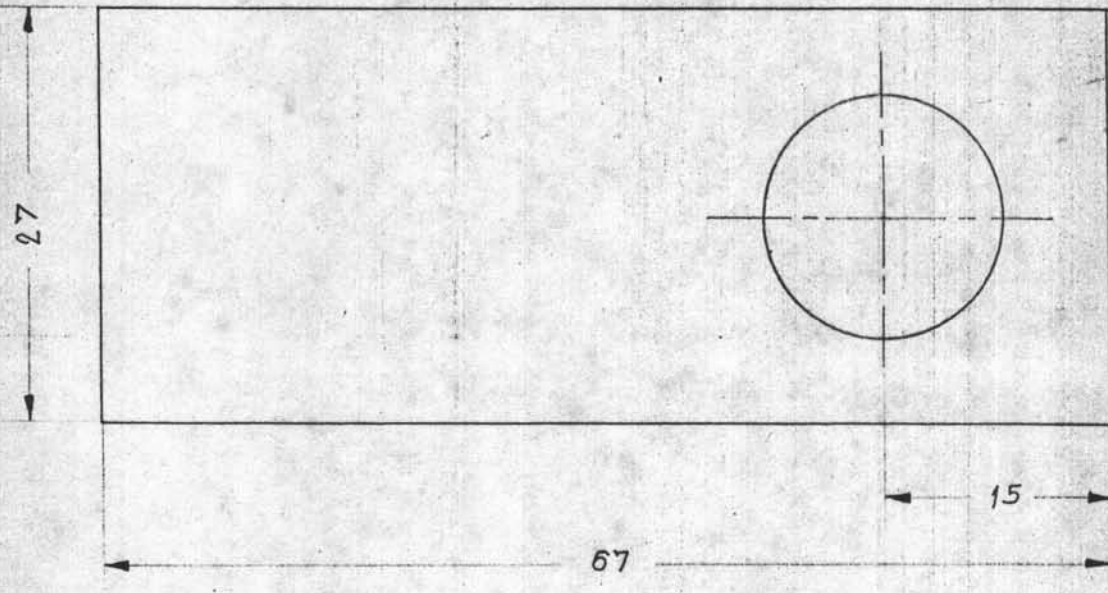

1		38	St. 37 67x27x10
No. of Piece	Nomenclature	Pos No.	Mat/Dim.
List of Parts			
		Name: <i>מסגרת / מסגרת</i>	
Scale 2:1		Date: 1/9/24	

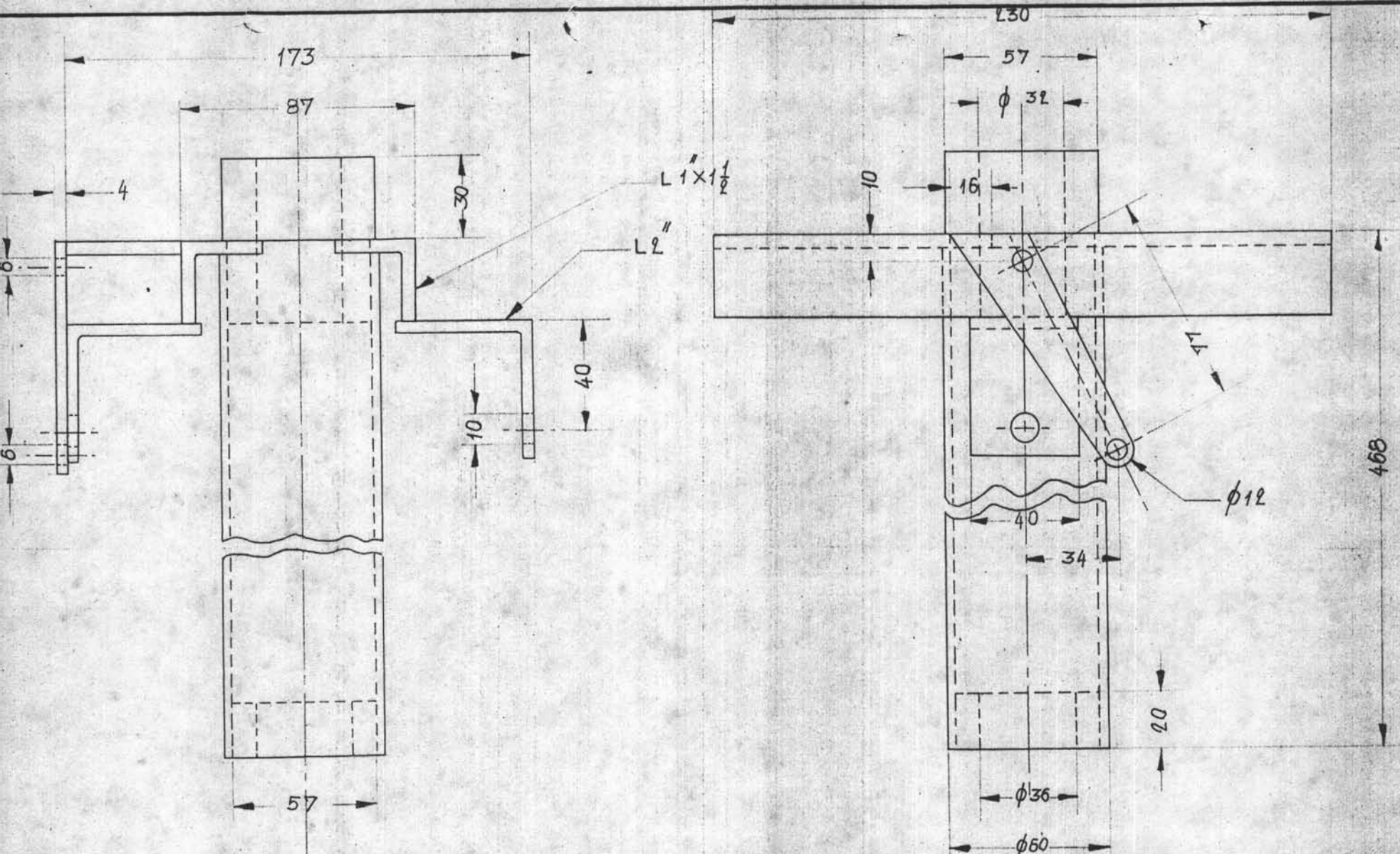

1	ปลอกเพลา และ โครงยึดที่ล้อ, 100เมตร	40	ST37 $\phi 60 \times 468$
No. of Piece	Nomenclature	Pos No.	Mat/Dim.
List of Parts			
			Name: <i>สมชาย</i>
			Date: 1/9/24
Scale 1:2			

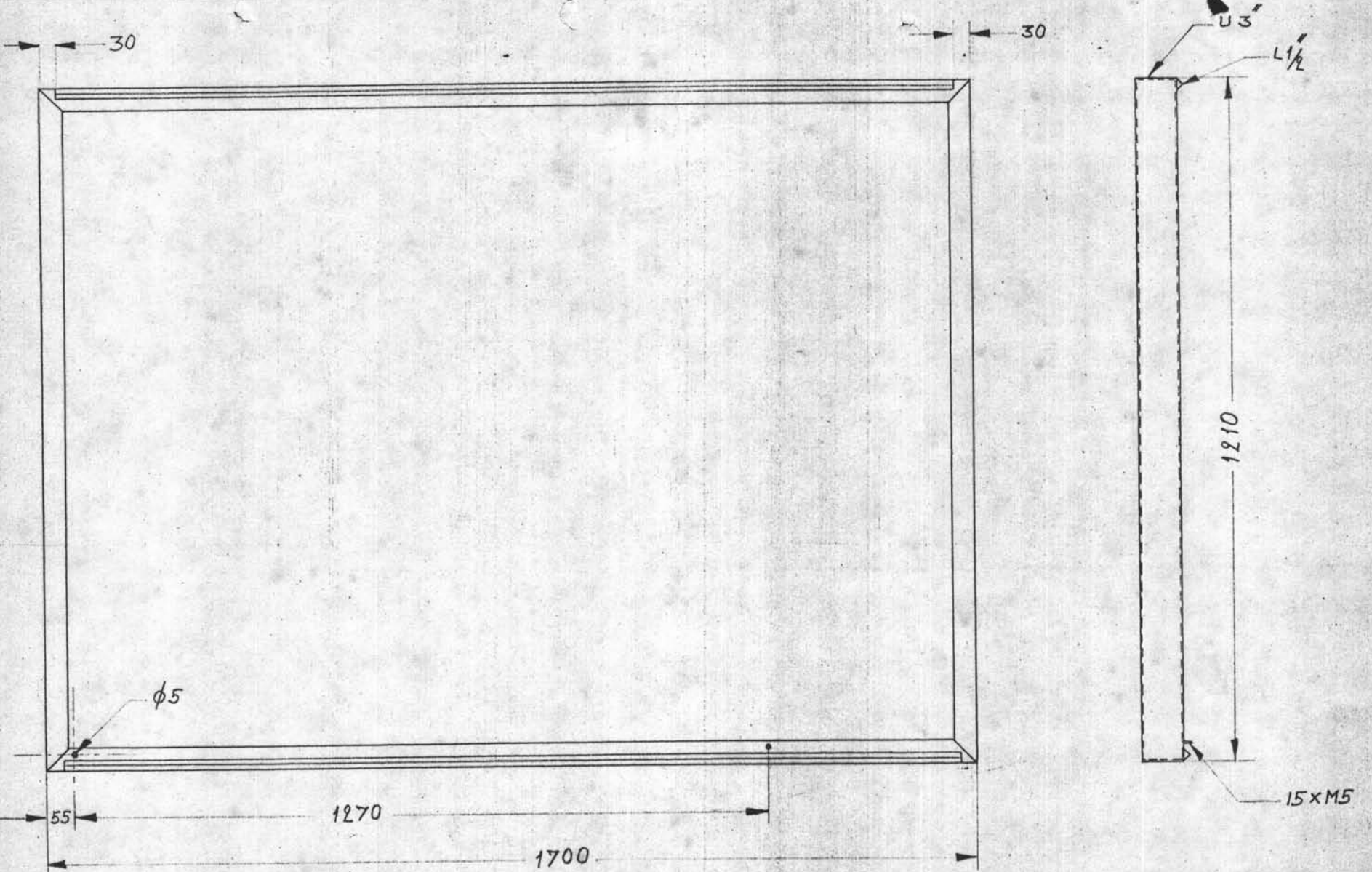

1	ฐานวางเครื่องวัด	42	U3", L 1/2"
No. of Piece	Nomenclature	Pos No.	Mat/Dim.
List of Parts			
			Name: นายสมชาย ใจดี
			Date: 1/9/44
Scale			
1:10			

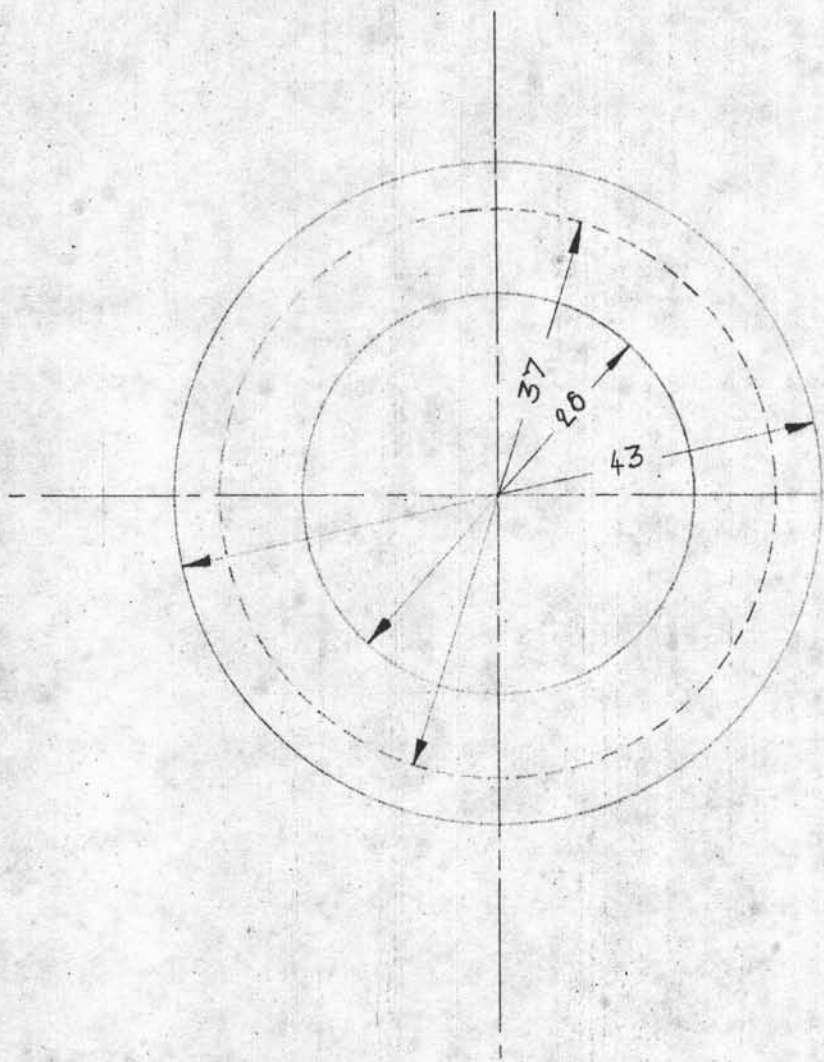

8	WHEEL	44	St. 37 $\phi 43 \times 8$
No. of Piece	Nomenclature	Pos No.	Mat/Dim.
List of Parts			
Scale	2:1	Name:	ASIBU MURUGAN
		Date:	1/9/24

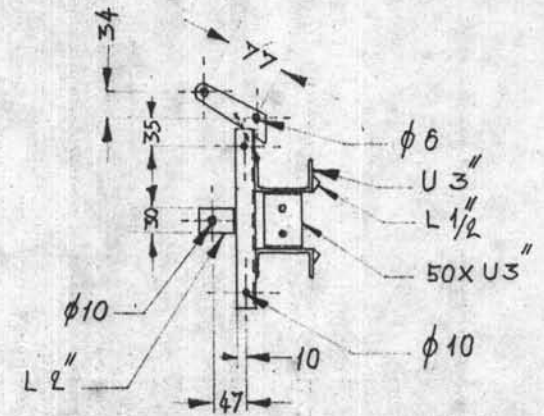
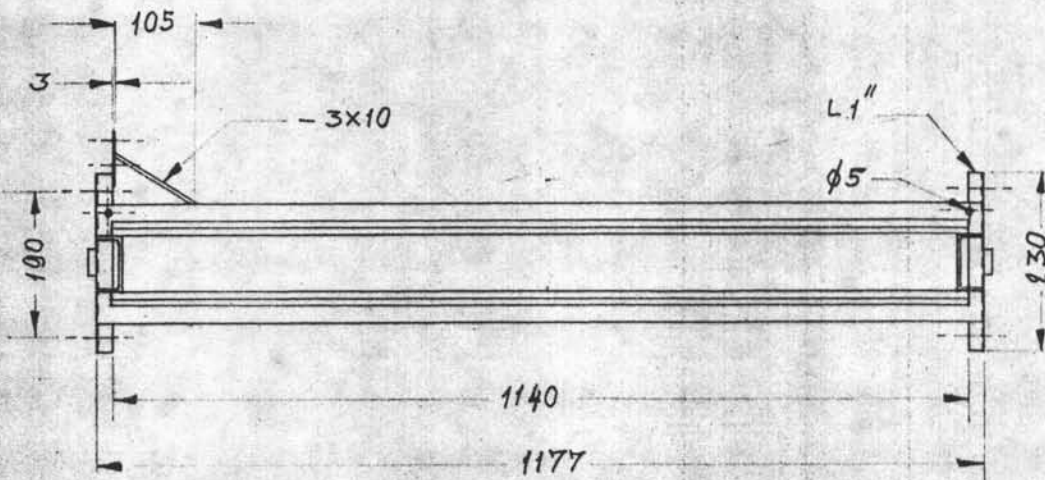

1	ฐานขาเครื่องวัด	45	U3", L1/2", L1", L2"
No. of Piece	Nomenclature	Pos No.	Mat/Dim.
List of Parts			
Scale	1:10	Name:	สุวิทย์ วัฒนวิเศษ
		Date:	1/9/14

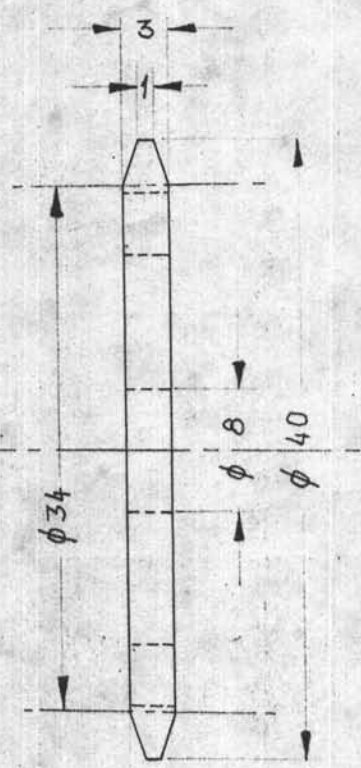
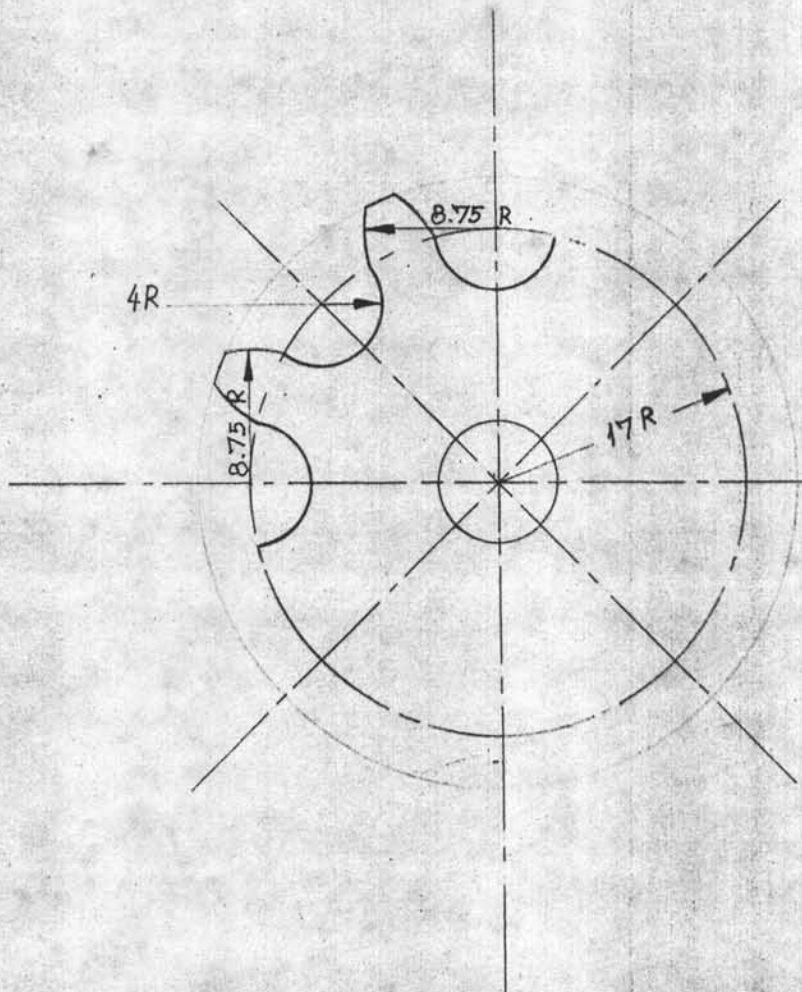

4	ເປືອກຊັບ	47	St.37 $\phi 40 \times 3$
No. of Piece	Nomenclature	Pos. No.	Mat/Dim.
List of Parts			
Scale	2:1	Name:	ສາສຸ ພິມມະວິໄນ
		Date:	1 / 9 / 24

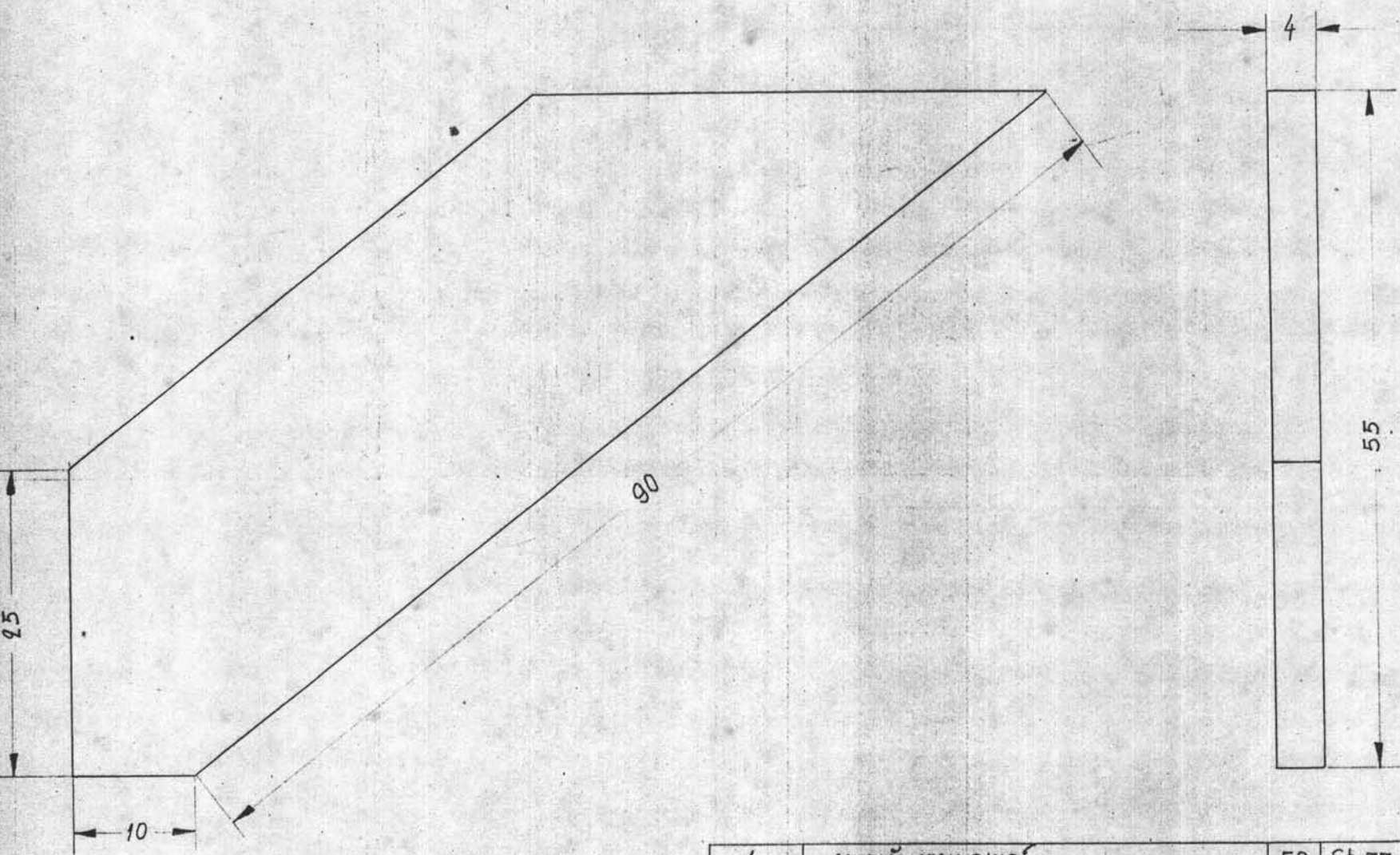

1	กรอบรับฐานมอเตอร์	50	St.37 100x25x4
No. of Piece	Nomenclature	Pos No.	Mat/Dim.
List of Parts			
			Name: <i>สมชาย ใจดี</i>
Scale 2:1			Date: 1 / 9 / 24

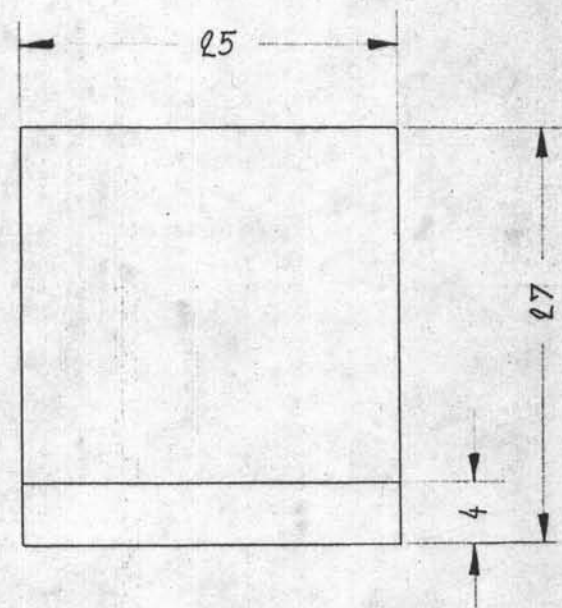
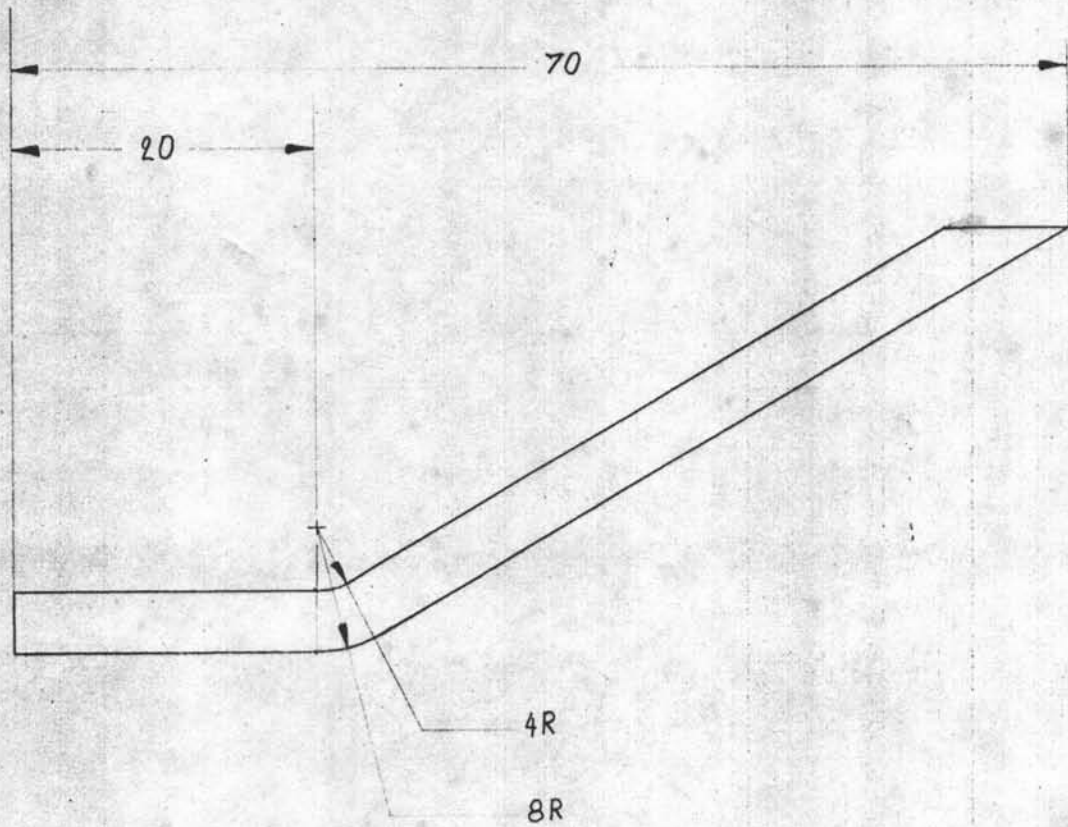

1	173023117744012705	51	St.37 78x25x4
No. of Piece	Nomenclature	Pos No.	Mat/Dim.
List of Parts			
			Name: 5182U
Scale			Date: 1/9/24
2:1			

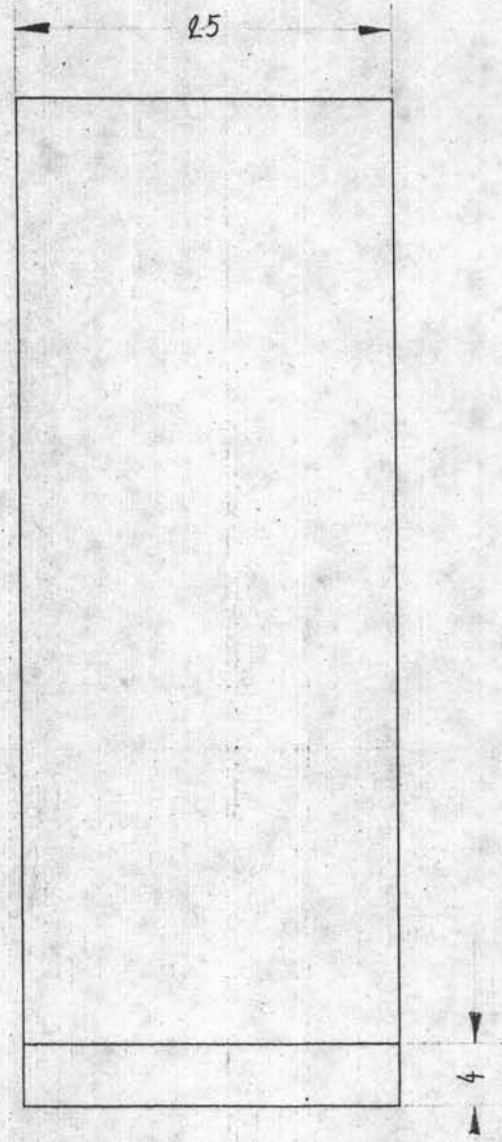
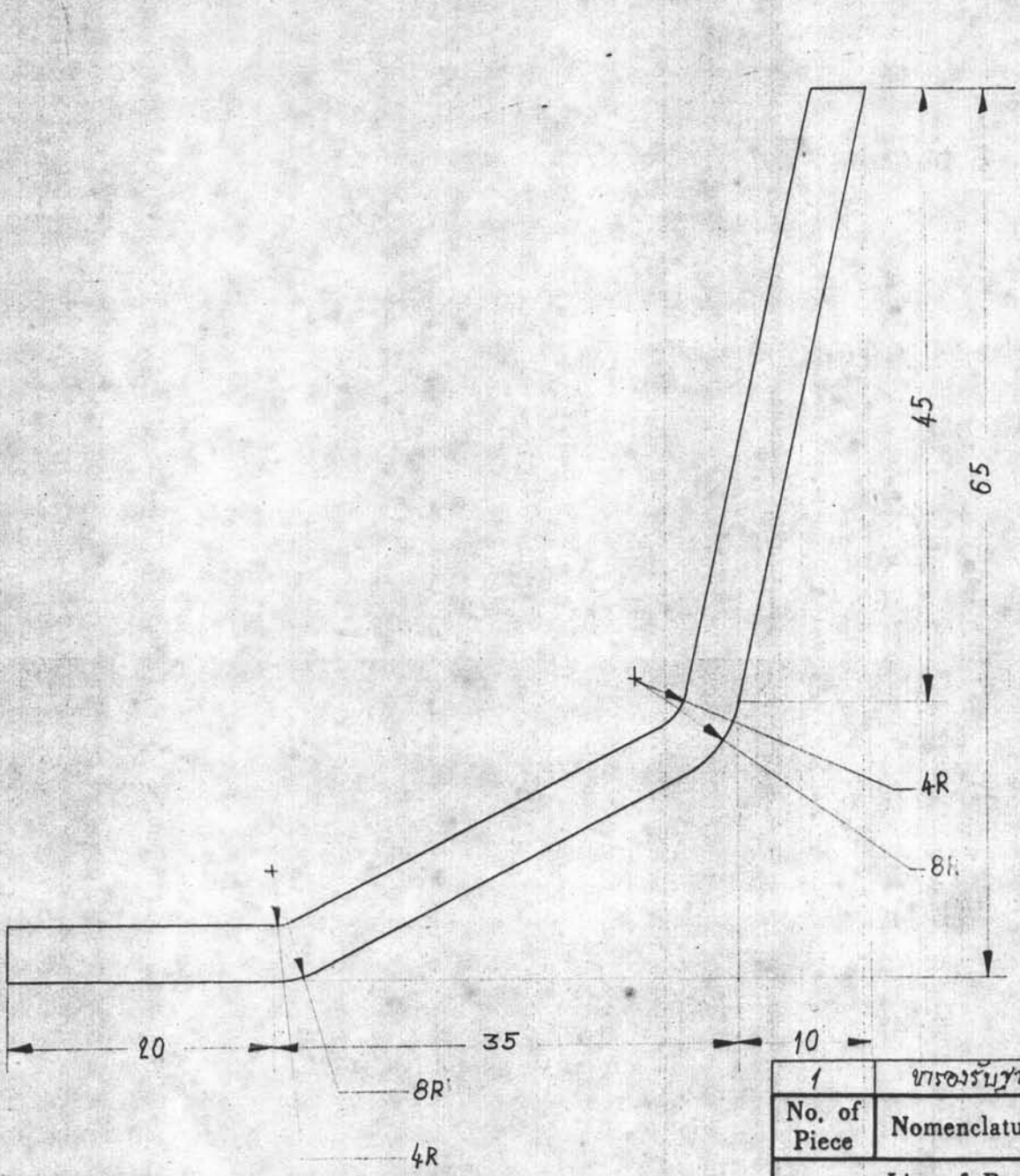

1	ทรงแรงรับน้ำหนักท่อ	52	St.37 120x25x4
No. of Piece	Nomenclature	Pos No.	Mat/Dim.
List of Parts			
Scale	2:1	Name: นายสมชาย ใจดี Date: 1/9/24	

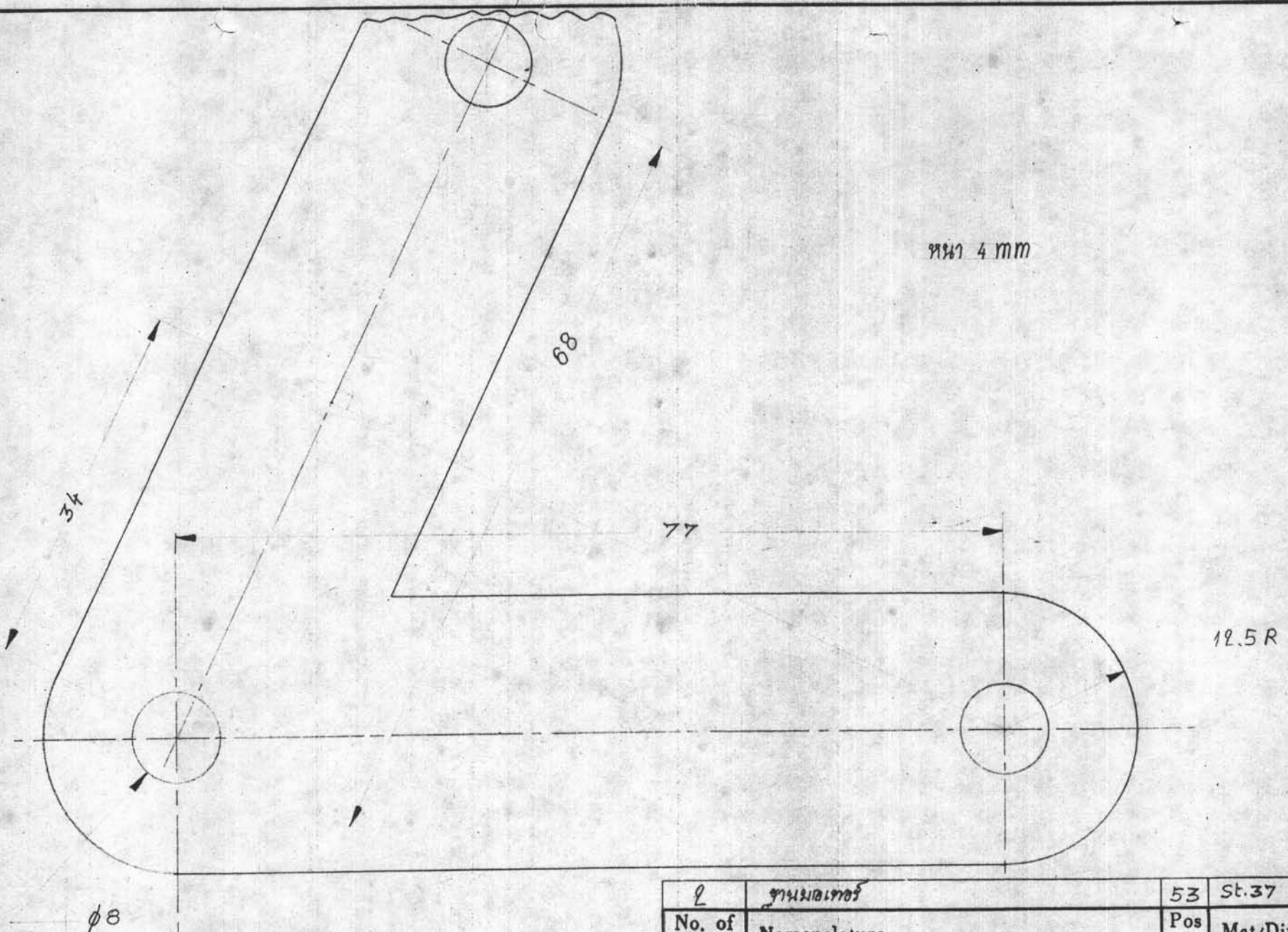

2	ชิ้นประกอบ	53	St.37 105X85X4
No. of Piece	Nomenclature	Pos No.	Mat/Dim.
List of Parts			
Scale	2:1	Name:	วชิระ
		Date:	1 / 9 / 24

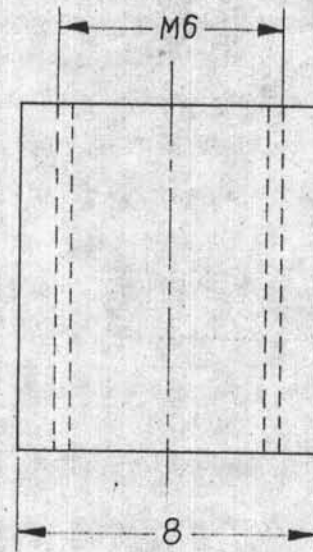
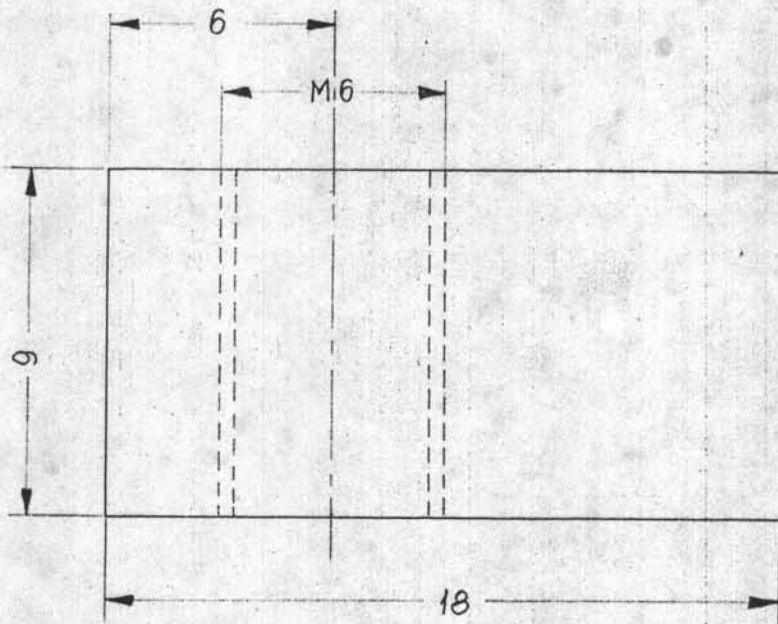

1	AN	54	St. 37 18x9x8
No. of Piece	Nomenclature	Pos No.	Mat/Dim.
List of Parts			
		Name: <i>Handwritten Name</i>	
Scale		Date: 1/9/24	
5:1			

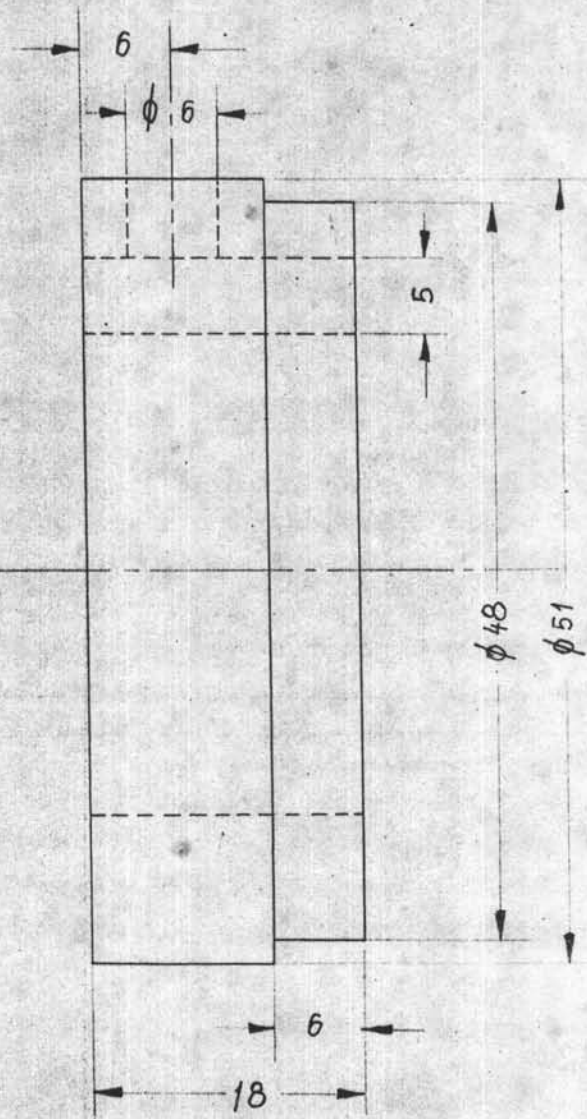
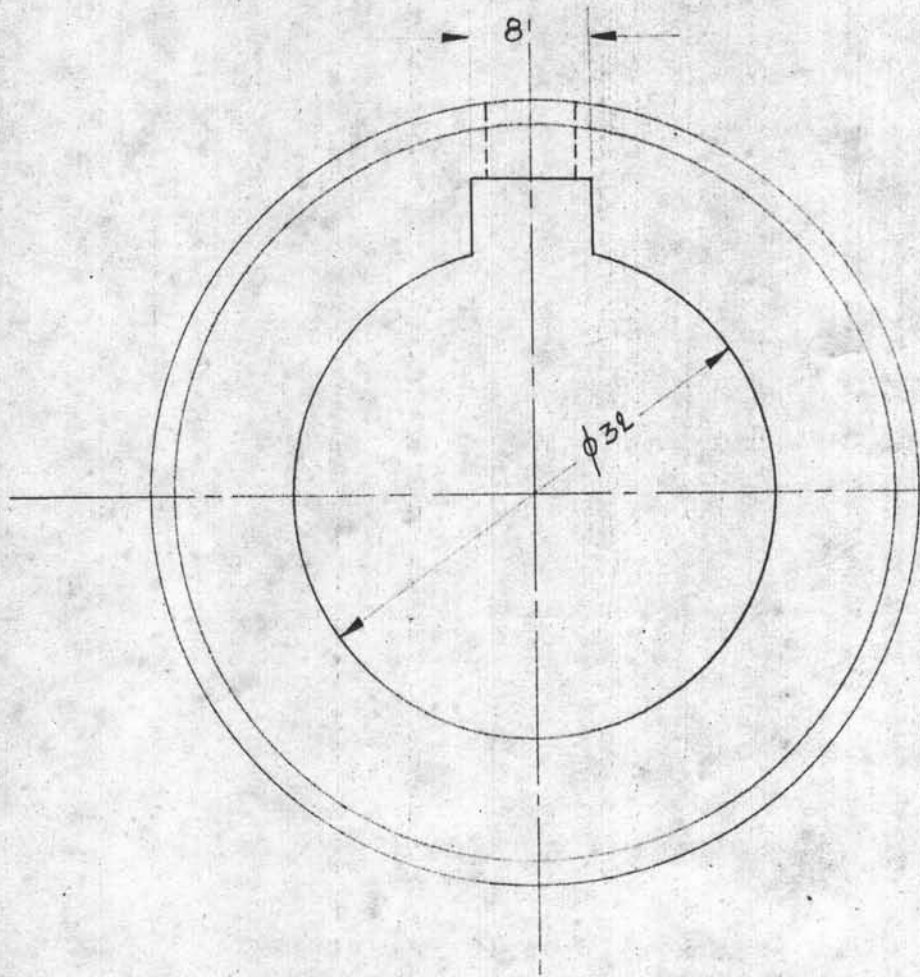

1		54	St.37 $\phi 51 \times 18$
No. of Piece	Nomenclature	Pos No.	Mat/Dim.
List of Parts			
Scale	2:1	Name: <i>...</i>	
		Date: 1/9/24	

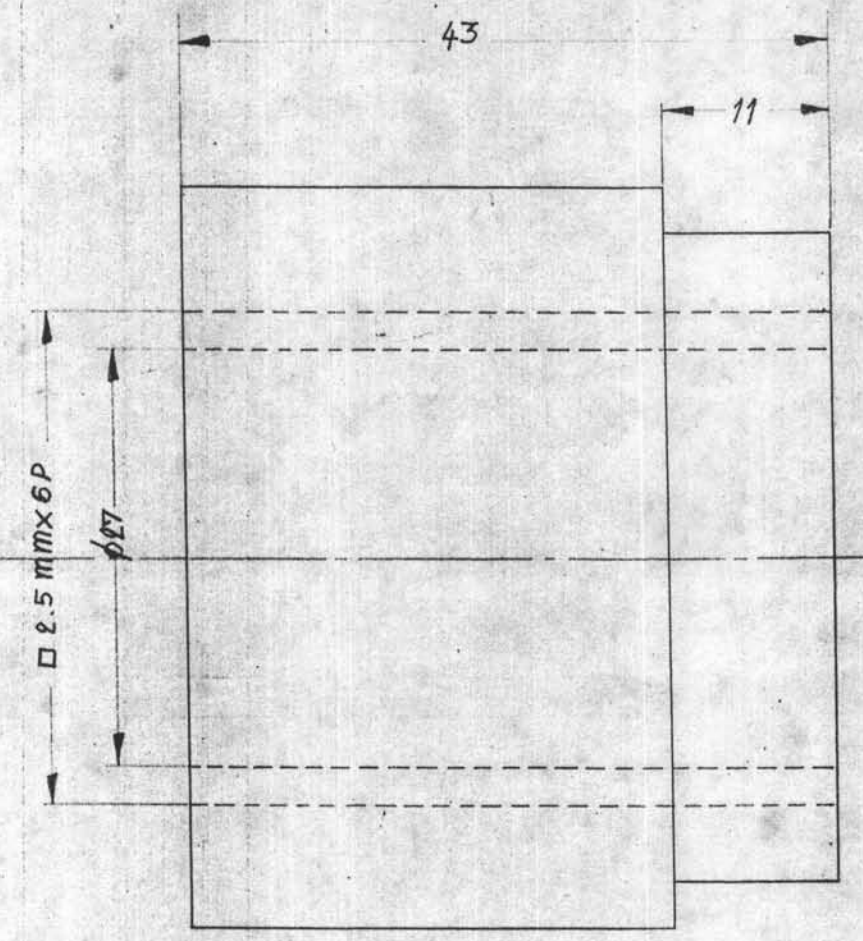
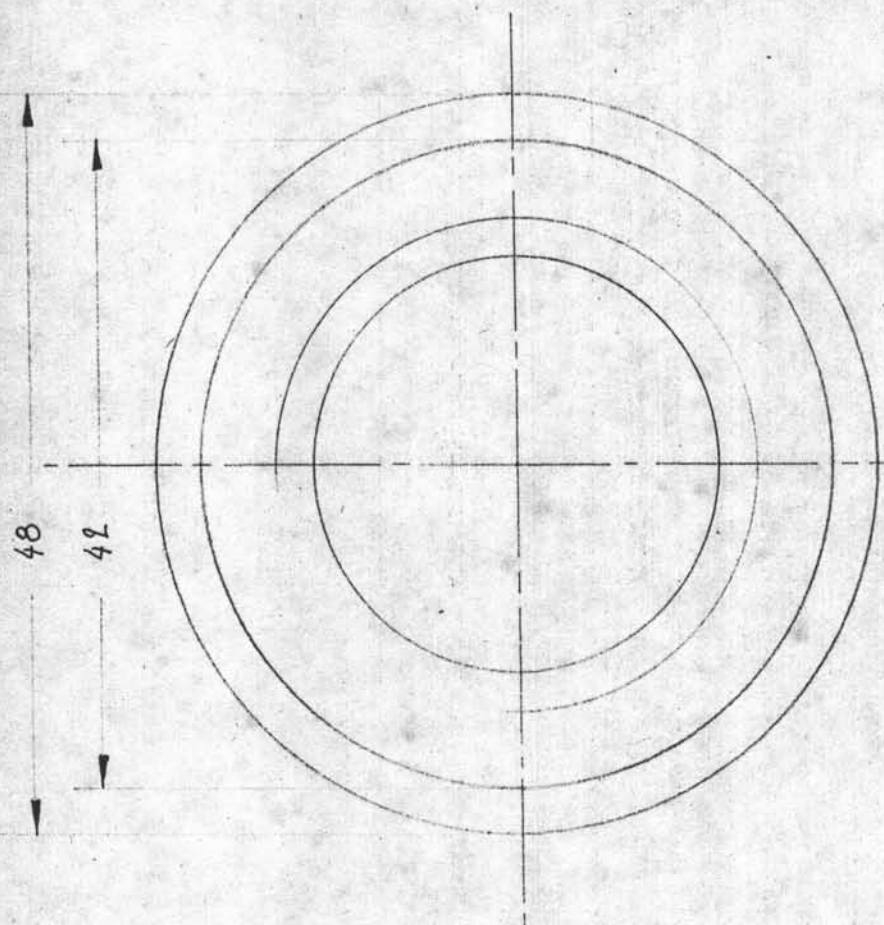

1		56	St. 37	φ 48 × 43
No. of Piece	Nomenclature	Pos No.	Mat/Dim.	
List of Parts				
Scale	2:1	Name: <i>SVS</i>		Date: 1 / 9 / 14

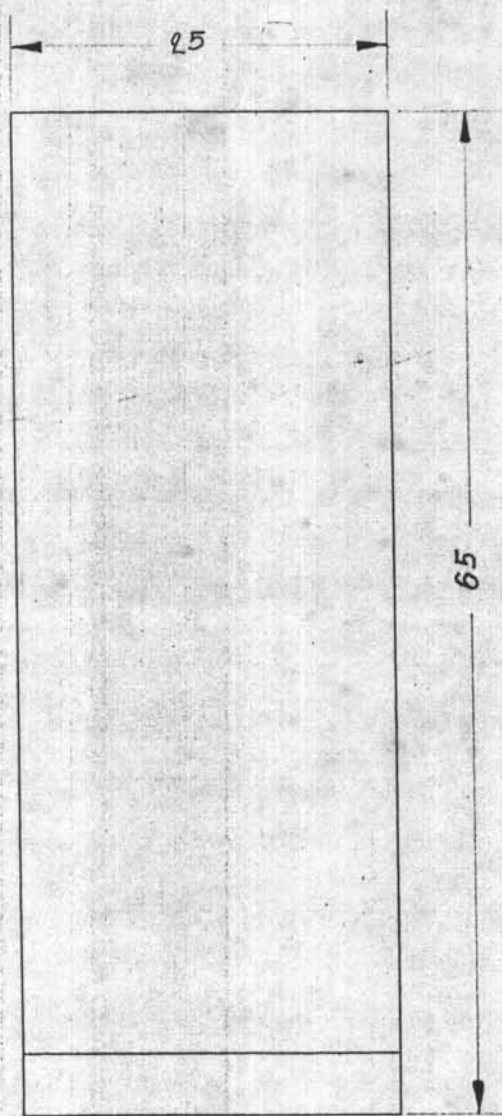
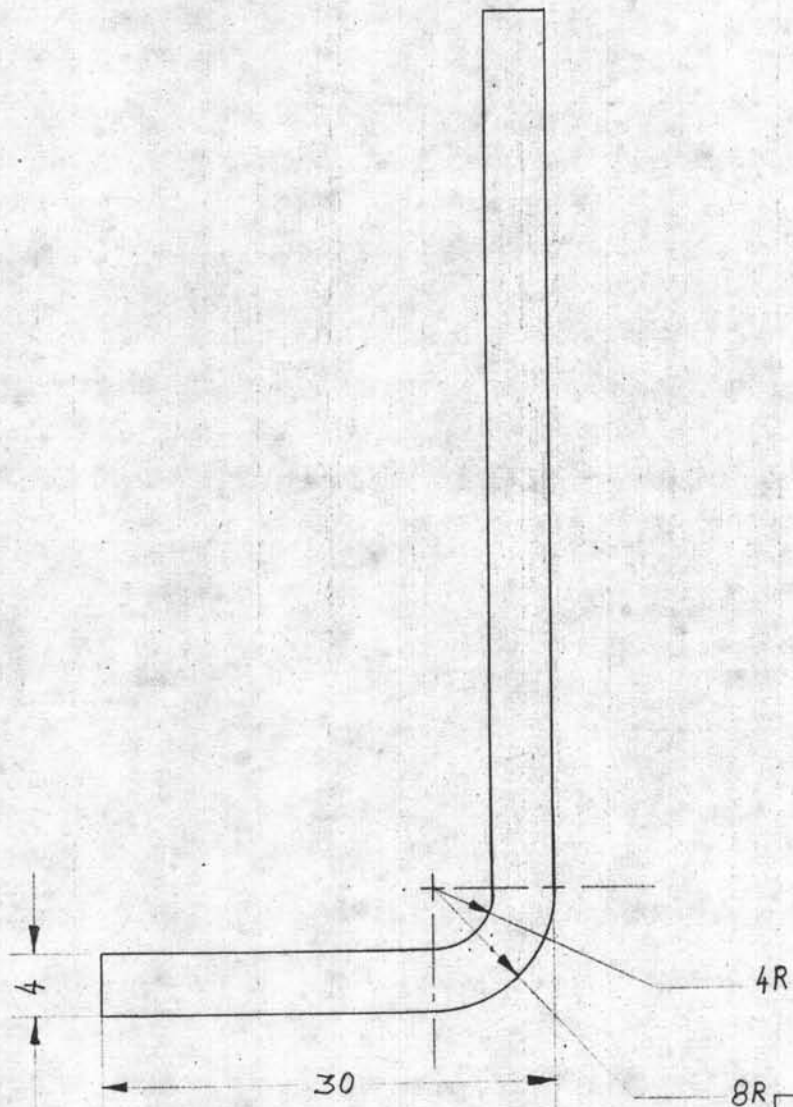

1	ขั้วต่อรับน้ำหนักท่อ	58	St.37 95x25x4
No. of Piece	Nomenclature	Pos No.	Mat/Dim.
List of Parts			
Scale		Name: วิศวกร วิศวกร	
		Date: 1/9/24	

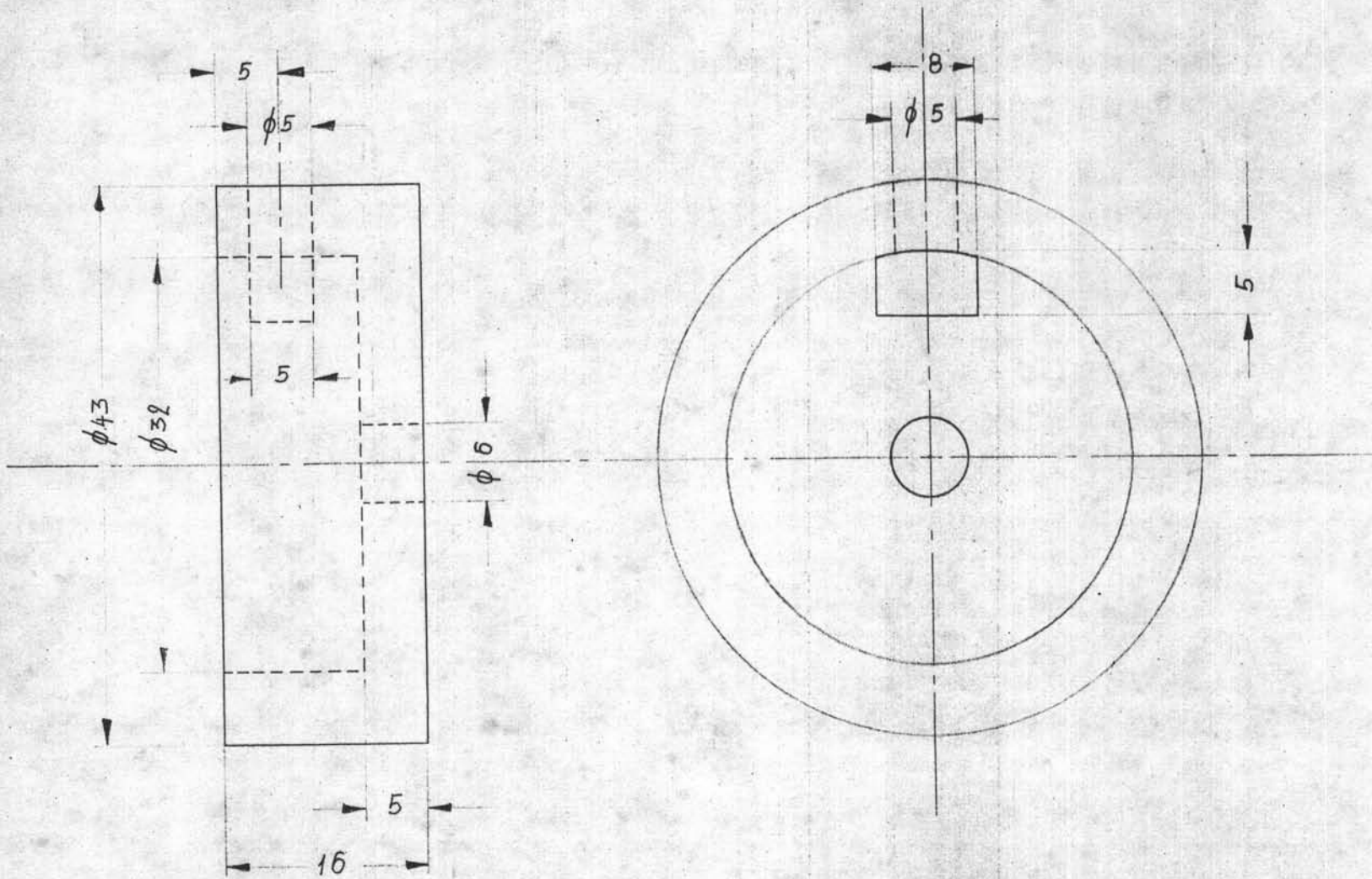

1	ชนิด/รหัส/เลข	59	St.37 φ43×16
No. of Piece	Nomenclature	Pos No.	Mat/Dim.
List of Parts			
Scale	2:1	Name: <i>สมชาย วัฒนกุล</i> Date: 1/9/24	

X MOTION

Y MOTION

Z MOTION

AZIMUTH ROTATION

ELEVATION ROTATION

SQUEEZE MOTION

TWIST ROTATION

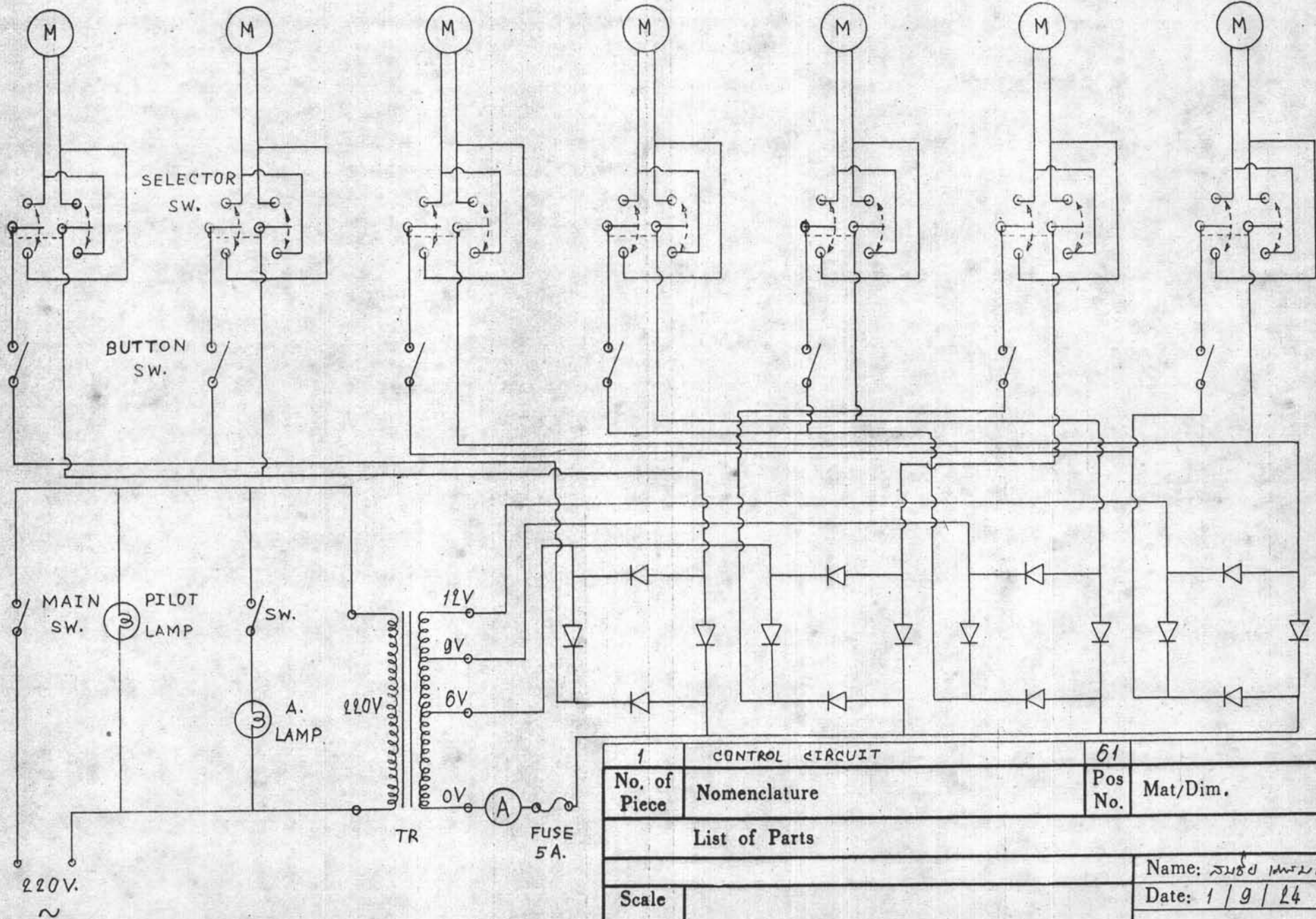

1	CONTROL CIRCUIT	61	
No. of Piece	Nomenclature	Pos No.	Mat/Dim.
List of Parts			
Scale		Name: <i>SUBU MULLI</i>	
		Date: 1/9/24	

พย.แผ่นดัดมีเหลี่ยมเท่าก.ท.ท.น.น.ด.น.ท.

325
แผ่นดัดที่ยาว 500mm

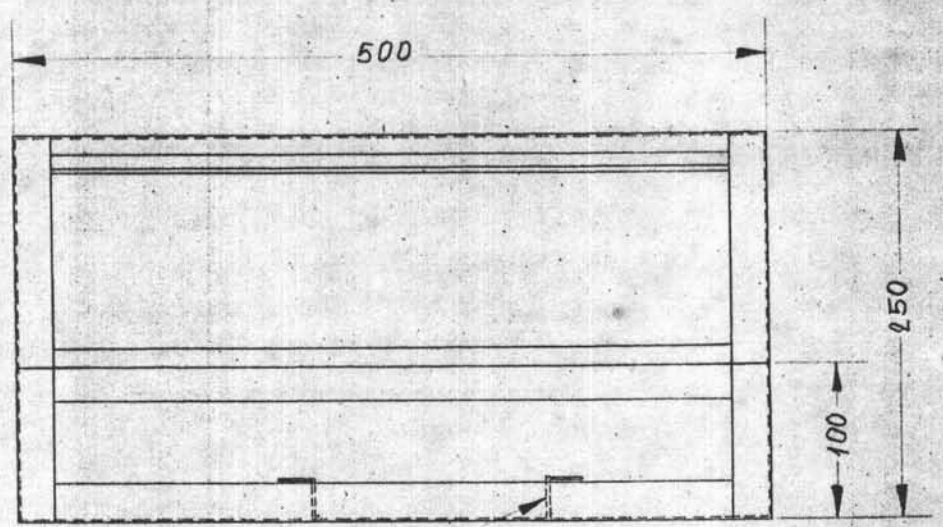
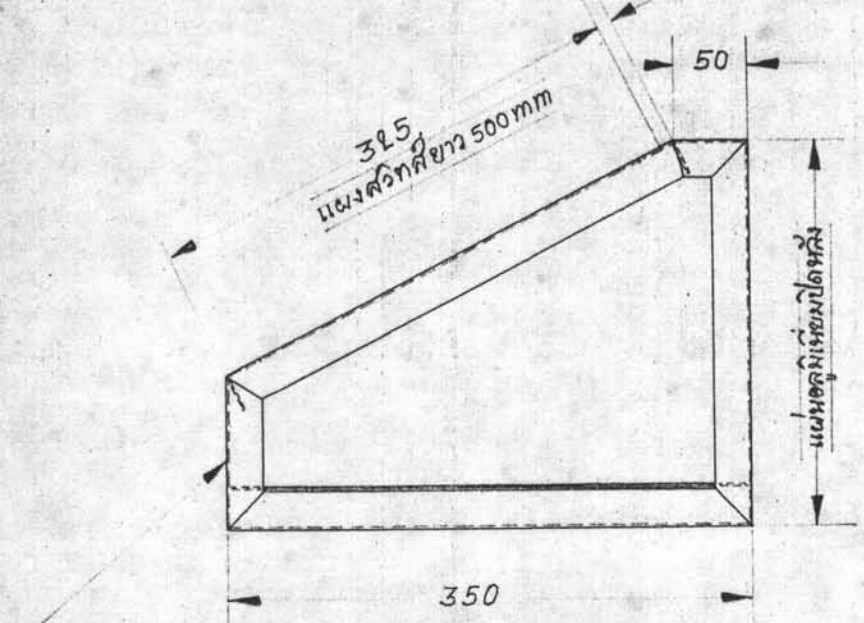

L 1" เจะร φ 6 ขงรกัน 10mm ทลตคความยาว

L 1" หน ทกขินลว ทดกันตวการเซอ

1	โครงกลวง	62	SE.37 500x350x150
No. of Piece	Nomenclature	Pos No.	Mat/Dim.
List of Parts			
			Name: <u>วิรัตน์ เภทวิไล</u>
Scale 1:5			Date: <u>1/9/24</u>

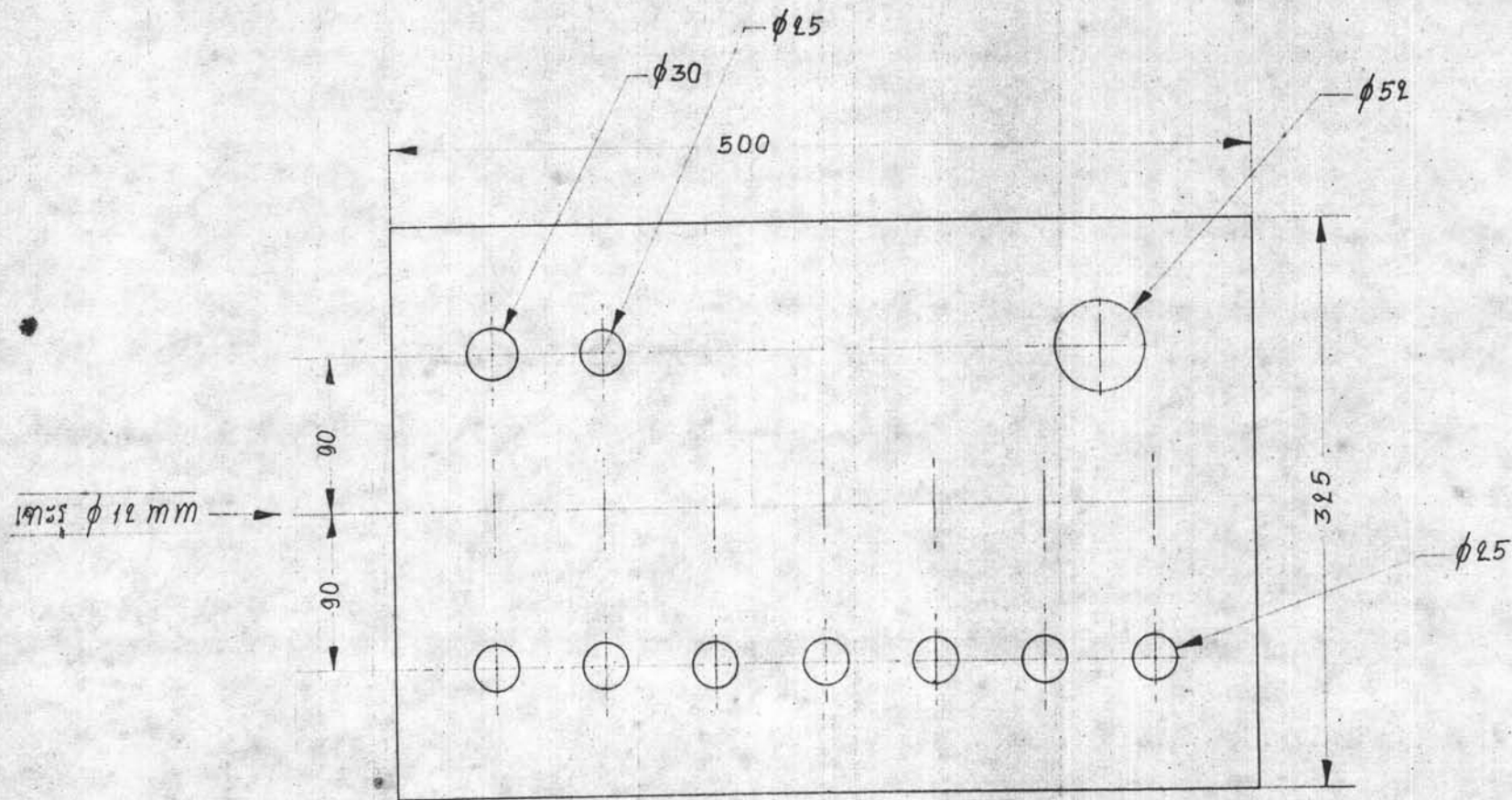

เจาะรู $\phi 6$ mm เพื่อยึดติดกับโครงกลอง

1	แผงสวิตช์บนกลอง	63	ALUMINUM 500x325x2
No. of Piece	Nomenclature	Pos No.	Mat/Dim.
List of Parts			
			Name: สหชัย เสงี่ยมศักดิ์
			Date: 1 / 9 / 14
Scale	1:4		

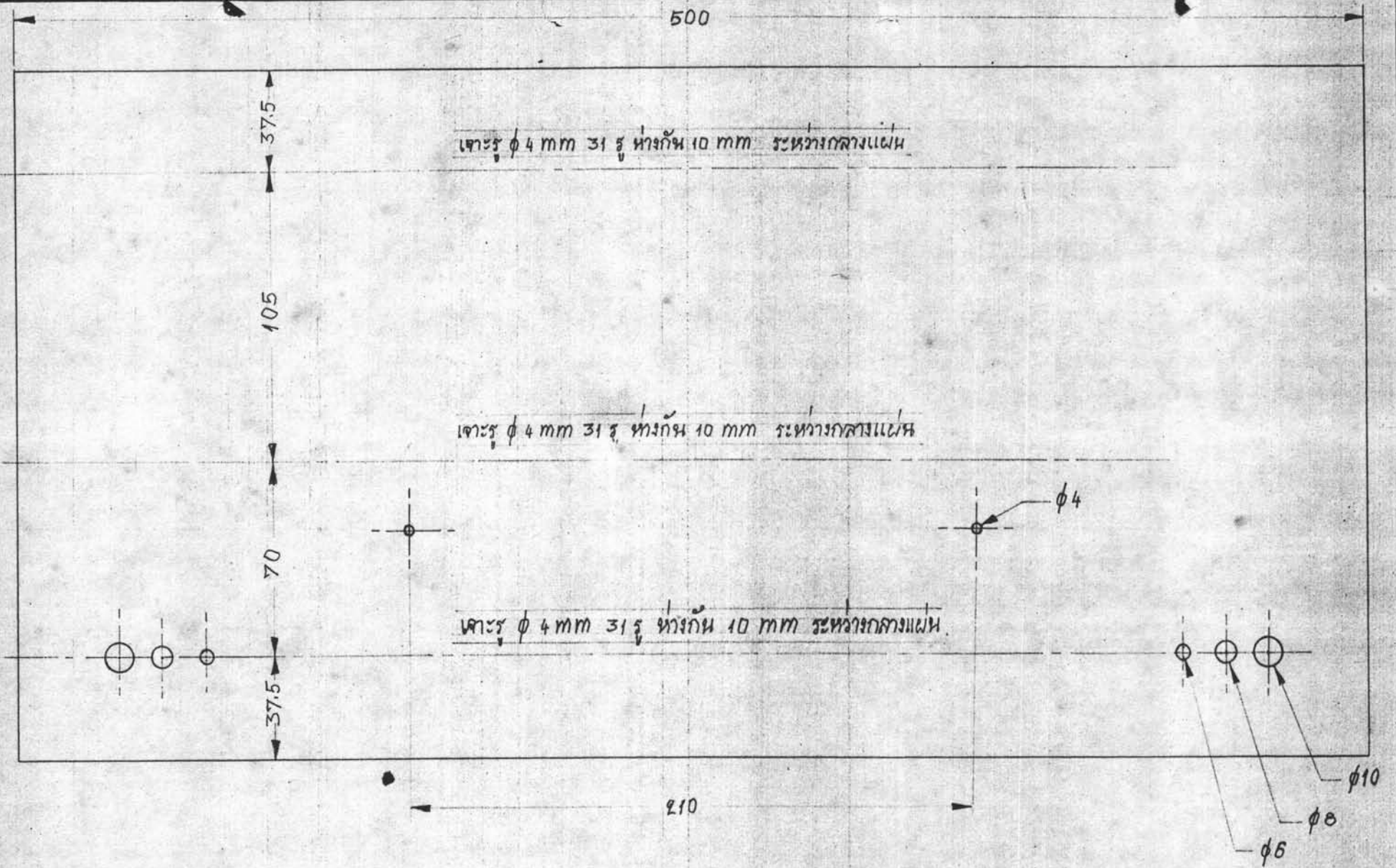

เจาะรู ϕ 4 มม 31 รู ห่างกัน 10 มม ระหว่างกลางแผ่น

เจาะรู ϕ 4 มม 31 รู ห่างกัน 10 มม ระหว่างกลางแผ่น

เจาะรู ϕ 4 มม 31 รู ห่างกัน 10 มม ระหว่างกลางแผ่น

เจาะรู ϕ 6 มม เพื่อยึดติดกับโครงกลอง

1	ผนังกันหลังกลอง	64	Al 500x250x2
No. of Piece	Nomenclature	Pos No.	Mat/Dim.
List of Parts			
Scale	1:2	Name: สมชัย	
		Date: 1/9/24	

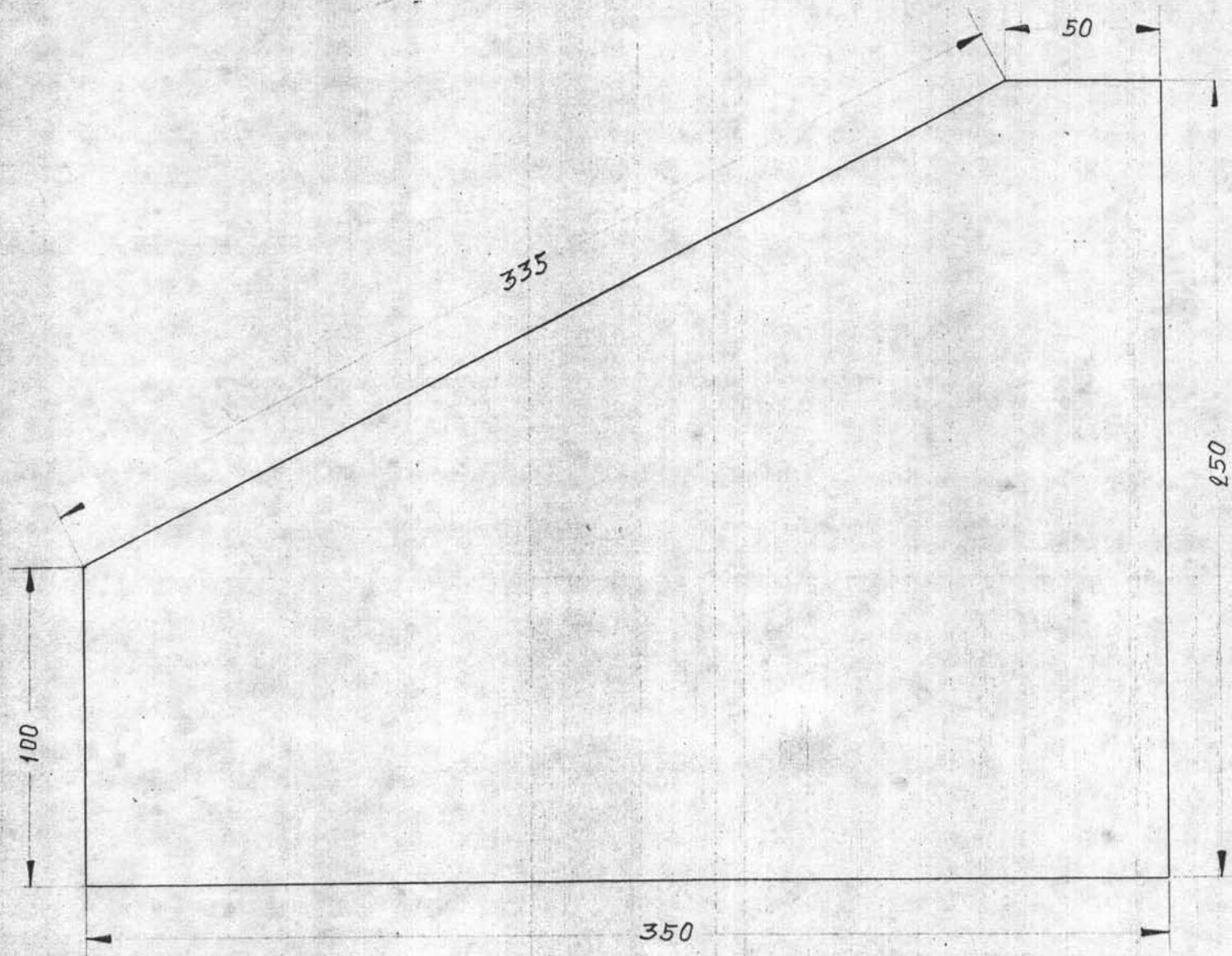

2	แผ่นตัดข้างกล่อง	65	ALUMINUM 350x250
No. of Piece	Nomenclature	Pos No.	Mat/Dim.
List of Parts			
Scale	1:2	Name:	นายสมชาย ใจดี
		Date:	1/9/24

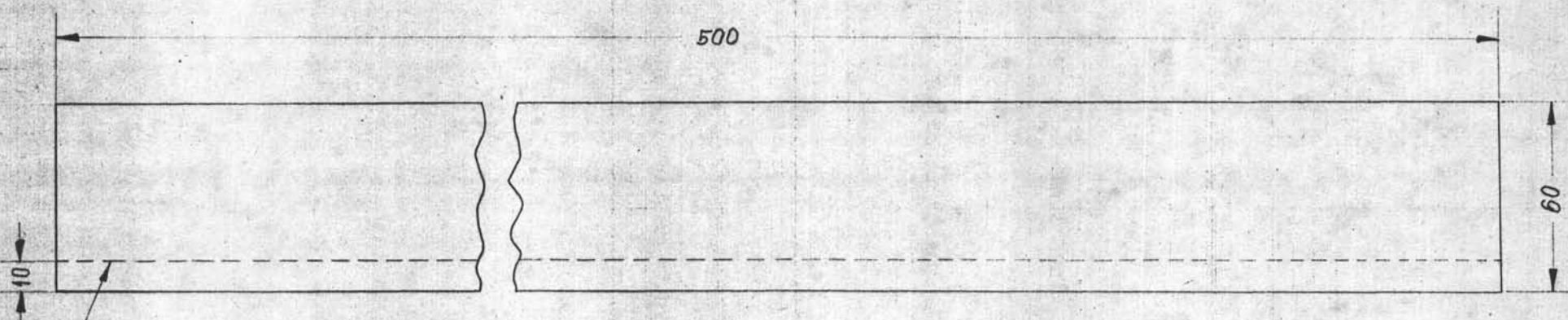

พิงตามแนวเส้นประให้เข้ากับหมวกคล่อง

แผ่นอลูมิเนียมหนา ๔ มม ปิดกั้นค้ำหมักคล่องด้วยท่อน้ำ

1	แผ่นค้ำหมักคล่อง	66	ALUMINUM 500x60x4
No. of Piece	Nomenclature	Pos No.	Mat/Dim.
List of Parts			
Scale	1:2	Name: สมชาย เหมรัมย์	Date: 1 / 9 / 24

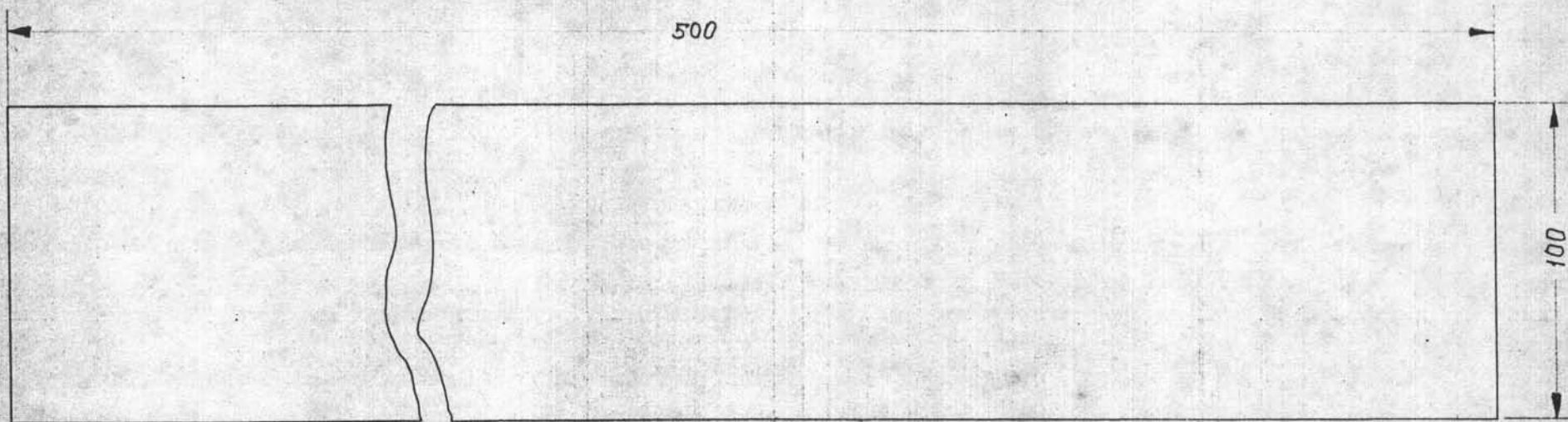

แผ่นอลูมิเนียมหนา 2 มม ปิดติดกันหน้ากล่องด้วยหมุดย้ำ

1	ผนังด้านหน้ากล่อง	67	ALUMINUM 500x100x2
No. of Piece	Nomenclature	Pos No.	Mat/Dim.
List of Parts			
Scale 1:2		Name: ทรัพย์ ทรัพย์	Date: 1/9/24

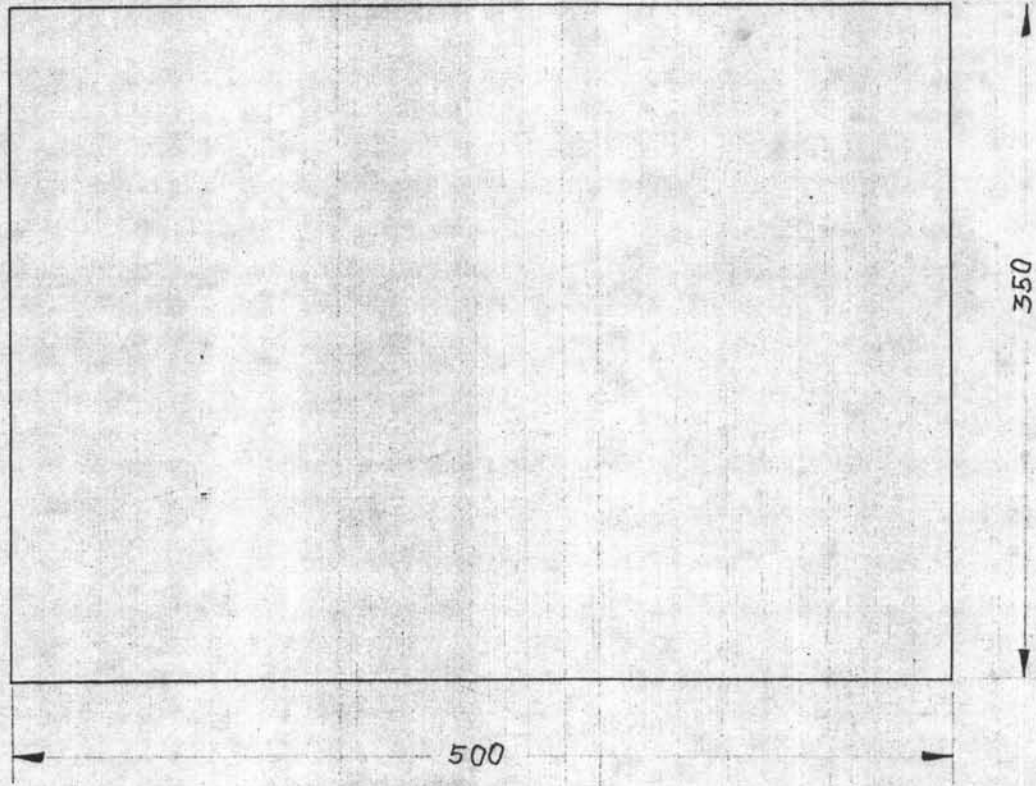

แผ่นอลูมิเนียมหนา 1 mm ยึดติดไว้กับกล่องด้วยหมุดดำ

1	ฉีกกล่อง	68	ALUMINUM 500x350x1
No. of Piece	Nomenclature	Pos No.	Mat/Dim.
List of Parts			
Scale	1:4	Name:	สมชาย เหมรัตน์
		Date:	1/9/24

ประวัติ



นายสมชัย เถาสมบัติ เกิดเมื่อวันที่ 30 พฤษภาคม พ.ศ. 2499
สถานที่เกิด จังหวัดสมุทรสงคราม สำเร็จการศึกษาชั้นปริญญาบัณฑิตจากสถาบันเทคโนโลยี
พระจอมเกล้า วิทยาเขตพระนครเหนือ ปี พ.ศ. 2522 ปัจจุบันรับราชการตำแหน่ง
อาจารย์ สถาบันเทคโนโลยีพระจอมเกล้า วิทยาเขตเจ้าคุณทหารลาดกระบัง