

การใช้เทคนิคท่อดักลมเพื่อเพิ่มการเคลื่อนไหวของอากาศในตึกแถว



นายเหงียบเฮียง ลาย

จุฬาลงกรณ์มหาวิทยาลัย

CHULALONGKORN UNIVERSITY

วิทยานิพนธ์นี้เป็นส่วนหนึ่งของการศึกษาตามหลักสูตรปริญญาสถาปัตยกรรมศาสตรมหาบัณฑิต

สาขาวิชาสถาปัตยกรรม ภาควิชาสถาปัตยกรรมศาสตร์

คณะสถาปัตยกรรมศาสตร์ จุฬาลงกรณ์มหาวิทยาลัย

ปีการศึกษา 2556

ลิขสิทธิ์ของจุฬาลงกรณ์มหาวิทยาลัย

บทคัดย่อและแฟ้มข้อมูลฉบับเต็มของวิทยานิพนธ์ตั้งแต่ปีการศึกษา 2554 ที่ให้บริการในคลังปัญญาจุฬาฯ (CUIR)

เป็นแฟ้มข้อมูลของนิสิตเจ้าของวิทยานิพนธ์ ที่ส่งผ่านทางบัณฑิตวิทยาลัย

The abstract and full text of theses from the academic year 2011 in Chulalongkorn University Intellectual Repository (CUIR) are the thesis authors' files submitted through the University Graduate School.

THE USE OF WIND-CATCHER TECHNIQUE TO IMPROVE NATURAL AIR MOVEMENT
IN ROW-HOUSES

Mr. Ngeabheang Lay



จุฬาลงกรณ์มหาวิทยาลัย

CHULALONGKORN UNIVERSITY

A Thesis Submitted in Partial Fulfillment of the Requirements
for the Degree of Master of Architecture Program in Architecture

Department of Architecture

Faculty of Architecture

Chulalongkorn University

Academic Year 2013

Copyright of Chulalongkorn University

Thesis Title	THE USE OF WIND-CATCHER TECHNIQUE TO IMPROVE NATURAL AIR MOVEMENT IN ROW- HOUSES
By	Mr. Ngeabheang Lay
Field of Study	Architecture
Thesis Advisor	Associate Professor.Phanchalath Suriyothin

Accepted by the Faculty of Architecture, Chulalongkorn University in
Partial Fulfillment of the Requirements for the Master's Degree

.....Dean of the Faculty of Architecture
(Assistant Professor Dr.Pongsak Vadhanasindhu)

THESIS COMMITTEE

.....Chairman
(Associate Professor Dr.Pinraj Khanjanusthiti)

.....Thesis Advisor
(Associate Professor.Phanchalath Suriyothin)

.....Examiner
(Assistant Professor Dr.Atch Sreshthaputra)

.....Examiner
(Assistant Professor Dr.Vorapat Inkarojrit)

.....External Examiner
(Dr.Jayada Boonyakiat)

เทียบเคียง ภาย : การใช้เทคนิคท่อดักลมเพื่อเพิ่มการเคลื่อนไหวของอากาศในตึกแถว. (THE USE OF WIND-CATCHER TECHNIQUE TO IMPROVE NATURAL AIR MOVEMENT IN ROW-HOUSES) อ.ที่
ปริญญาวิทยานิพนธ์หลัก: รศ.พรรณชลัท สุริโยธิน, 101 หน้า.

โดยทั่วไปแล้ว ตึกแถวเป็นอาคารพักอาศัยประเภทหนึ่งที่มีลักษณะการก่อสร้างเป็นตึกเรียงเป็นแนว ยาว
ซึ่งแต่ละบ้านใช้ผนังด้านข้างร่วมกัน จึงช่วยประหยัดพื้นที่ก่อสร้างได้การใช้พื้นที่ก่อสร้างน้อยลงนำมาสู่การ ลดค่า
ก่อสร้าง ซึ่งเป็นปัจจัยหนึ่งที่ทำให้การเคลื่อนไหวของลมในที่พักอาศัย ไม่เพียงพอที่จะทำให้รู้สึกสบาย

การศึกษาครั้งนี้จึงมีวัตถุประสงค์เพื่อแก้ไขปัญหาดังกล่าวด้วยการใช้ท่อดักลมเพื่อเพิ่มการเคลื่อนไหวของ
อากาศภายในพื้นที่ใช้สอยร่วมกัน (sharing space) ซึ่งได้แก่ ห้องนั่งเล่น ห้องรับแขก และครัวในตึกแถว สองชั้น

ผู้ศึกษาใช้แบบสอบถาม เพื่อเก็บข้อมูลที่เกี่ยวข้องกับสภาวะน่าสบายจากผู้อยู่อาศัยตึกแถวสองชั้นจำ
นวน 30 แห่ง ในกรุงเทพมหานคร โดยผู้ศึกษาเลือกตึกแถวแห่งหนึ่งมาเป็นกรณีต้นแบบ (base case) นอกจากนี้ยังได้
ทำการวัดค่าความเร็วลม อุณหภูมิ และความชื้นสัมพัทธ์ ของบ้านหลังหนึ่งในตึกแถวกรณีต้นแบบ จากนั้น จึงใช้
โปรแกรมจำลองสภาพสำหรับการไหลของอากาศ (Heat X) จำลองท่อดักลม 2 กรณี กรณีแรก (ช่อง เปิดของบ้านเปิด
ทั้งหมด ตั้งการใช้งานในเวลากลางวัน) ประกอบด้วย แบบที่นำเสนอ (proposed design) จำนวน 5 แบบ ได้แก่ ท่อ
ดักลมที่ตำแหน่งบันได ท่อดักลมรูปแบบตัว X แบบที่ 1 ท่อดักลมรูปแบบตัว X แบบที่ 2 ท่อดักลมรูปแบบตัว K คู่
แบบที่ 1 และท่อดักลมรูปแบบตัว K คู่แบบที่ 2 ซึ่งพบว่าท่อดักลมรูปแบบตัว K คู่ แบบที่ 2 ให้ผลดีที่สุด ผู้วิจัยจึง
เลือกท่อดักลมรูปแบบนี้มาใช้ในการจำลองกรณีที่สองด้วย โดยกรณี ที่สอง (ช่อง เปิดของบ้านปิดทั้งหมด ตั้งการใช้
งานในเวลากลางคืน) ประกอบด้วย ท่อดักลมรูปแบบตัว K คู่แบบที่ 2 และ ท่อ ดักลมที่นำเสนอเพิ่มเติม แบบที่ 1 และ
แบบที่ 2 จากนั้นจึงใช้โปรแกรมจำลองการไหลของอากาศ เพื่อ วิเคราะห์ ผลจากการเคลื่อนไหวของลมที่ความเร็ว 2
เมตร/วินาที และ 4 เมตร/วินาที จาก 3 ทิศทาง (ทิศใต้ ทิศ ตะ วัน ตก และทิศตะวันตกเฉียงใต้)

ผลการศึกษาพบว่า การใช้ท่อดักลมไม่สามารถให้ผลอย่างมีนัยสำคัญกับห้องรับแขกและห้องครัว (ชั้น
ล่าง) ทั้งในกรณีที่ 1 และกรณีที่ 2 อย่างไรก็ตาม การใช้ท่อดักลม นั้นสามารถให้ผลอย่าง มีนัยสำคัญกับ ห้อง นั่ง เล่น
(ชั้นบน) ทั้งในกรณีที่ 1 และกรณีที่ 2 และที่สำคัญยิ่งไปกว่านั้น การใช้ท่อดักลมยังนำ มาประ สาน การ ใช้ งานได้เป็น
อย่างดีเมื่อใช้กับแบบที่นำเสนอเพิ่มเติมแบบที่ 1 และ แบบที่ 2 ซึ่งสามารถเพิ่มการ เคลื่อน ไหว ของ อากาศได้ทั้งกับ
ห้องพักผ่อน ห้องรับแขก และครัว ทั้งสองกรณี นอกจากนี้ยังพบว่า การใช้ ท่อ ดัก ลม รูป แบบ K คู่ แบบที่ 2 จะให้
ผลดีที่สุด เมื่อเปรียบเทียบกับแบบอื่นๆที่นำเสนอ ยิ่งไปกว่านั้น การศึกษา ครั้งนี้ ยัง แสดง ให้เห็นว่า ท่อดักลม
สามารถนำไปใช้งานได้เป็นอย่างดีในสภาพภูมิอากาศร้อนชื้นแบบมรสุม เช่นที่ กรุงเทพมหานคร ประเทศกัมพูชา เพื่อเพิ่ม
การเคลื่อนไหวของอากาศ ภายในอาคารและเพิ่มสภาวะ น่า สบาย ให้ กับ ผู้อยู่ อาศัย ในตึกแถว

จุฬาลงกรณ์มหาวิทยาลัย
CHULALONGKORN UNIVERSITY

ภาควิชา สถาปัตยกรรมศาสตร์

ลายมือชื่อนิสิต

สาขาวิชา สถาปัตยกรรม

ลายมือชื่อ อ.ที่ปรึกษาวิทยานิพนธ์หลัก

ปีการศึกษา 2556

5573348325 : MAJOR ARCHITECTURE

KEYWORDS: ROW-HOUSE / WIND-CATCHER / THERMAL COMFORT

NGEABHEANG LAY: THE USE OF WIND-CATCHER TECHNIQUE TO IMPROVE NATURAL AIR MOVEMENT IN ROW-HOUSES. ADVISOR: ASSOCIATE PROFESSOR.PHANCHALATH SURIYOTHIN, 101 pp.

Typically, row-houses also known as residential buildings were constructed as rows. Each row house shares its side walls with the attached row house, as doing so can save space. The saving of space comes at a cost. However, one of the issues is always an inadequate airflow.

Thus, the intent of this research study is to address the problem by focusing on the use of wind-catchers in order to improve indoor air movement of sharing spaces – family room, living room, and kitchen – in a two-story row-house.

A questionnaire relate to thermal comfort was created and row-houses occupants were asked to fill the answers. Thirty row houses which are two stories level were selected and the owners of those houses were interviewed. A row-house was selected to be the base case. Measurements of wind velocity, temperature, and humidity were conducted at the. Additionally, there were two categories of model simulation were conducted. First category (all apertures of the house were completely open as this condition was considered as the day time) consisted of five proposed designs such as a stair case wind-catcher, an X-type wind-catcher I, an X-type wind-catcher II, a twin K-type wind-catcher I, and a twin K-type wind-catcher II. As the results, the twin K-type wind-catcher II provided the best result amongst other proposed designs. Therefore, it was selected to use in second category. Second category (all apertures of the house were completely closed as this condition was considered as the night time) consisted of three proposed designs such as a twin K-type wind-catcher II, an Extra design I, and an Extra design II. Furthermore, the CFD program was employed to analyze the effects of air flow as wind speed 2m/s and 4m/s from three wind directions (south direction, west direction, and south-west direction).

As the results from this research study indicated that the use of wind-catcher did not provide any significant effect to the living room and the kitchen (ground floor) for both the first category and the second category. However, the use of wind-catcher provided the significant effect to the family room (first floor) for both the first category and the second category. More importantly, the use of wind-catcher integrated with an Extra design I and an Extra design II provide the significant effect the air movement in the family room, the living room, and the kitchen for both categories. Additionally, the use of the twin K-type wind-catcher II is the most appropriate one amongst all the proposed designs. Moreover, this research also indicates that wind-catchers can be used properly in tropical monsoon climate as Phnom Penh, Cambodia in order to enhance indoor air movement and to increase thermal comfort to row-houses' occupant.

Department: Architecture

Student's Signature

Field of Study: Architecture

Advisor's Signature

Academic Year: 2013

ACKNOWLEDGEMENTS

First of all, I would like to express my sincere gratitude to the supported scholarship for my study and living allowance till my graduation date.

Then, I would like to express my sincere gratitude to my advisor Associate Professor. Phanchalath Suriyothin for her support of my master research study, for her patience, her kindness, her motivation, and her guidance. She always help me in all the time not only in this research, but in all the problems of my study.

Besides my advisor, I would like to thank to all my thesis committee as Dr. Pinraj Khanjanusthiti, Assistant Professor Dr. Atch Sreshthaputra, Assistant Professor Dr. Vorapat Inkarojrit , and Assistant Professor Dr. Chayada Boonyajakiat, for their encouragement and their comments. Also, Thanks a lot to teacher Sarin Pinit for all her comments and her encouragements.

Finally, I would like to thanks a lot to Mr. Chantha Sorachan and his wife who help me a lot in editing English.

CONTENTS

	Page
THAI ABSTRACT	iv
ENGLISH ABSTRACT	v
ACKNOWLEDGEMENTS	vi
CONTENTS	vii
Chapter I Introduction	1
1.1 Research Background	1
1.2 Research Problem.....	2
1.3 Research Questions	2
1.4 Purposes.....	3
1.5 Restrictions.....	3
1.6 Expected outcomes	3
Chapter II literature reviews	4
2.1 Row-house	4
2.2 Wind-catcher	9
2.3 Thermal comfort.....	12
2.3.1 Principle of Air movement.....	12
2.3.2 Natural ventilative cooling	15
2.3.3 Possibility of Using Wind Velocity to induce thermal comfort to building occupants in Phnom Penh, Cambodia	17
Chapter III Methodology	27
3.1 Description of Methodology	27
3.2 Diagram of methodology.....	29
3.3 Data collection and data analysis.....	30
3.3.1 Interview section	30
3.3.2 Base Case Measurement Processing	30
3.3.2.1 Base case	30
3.3.2.2 Measurement instruments	31

	Page
3.3.2.3 Measurement Method	31
3.3.2.3.1 Measurement Positions	31
3.3.2.3.2 Measurement Schedule	33
3. 4 Proposed Designs	33
3.4.1 Selection of wind-catchers	33
3.4.2 Determination of wind directions in the designs	34
3.4.3 Categorization of the models simulation design	34
3.4.3.1 First category	35
3.4.3.2 Second category	35
3.4.4 Design Process	35
3.4.4.1 Design Strategies	35
3.4.4.2 Sizing of Designs	36
Chapter IV Results and Discussion	39
4.1 Results	39
4.1.1 Results from site survey	39
4.1.1.1 Interview	39
4.1.1.1.1 Percentage of houses' apertures opening	39
4.1.1.1.2 Occupants' feeling of comfort of living in row houses	40
4.1.1.2 Actual Measurement Result	42
4.1.1.2.1 Measurement Result of Living room	43
4.1.1.2.1 Measurement Results of kitchen	44
4.1.1.2.3 Measurement Results of Family room	45
4.1.2 Results from Models simulation	46
4.1.2.1 First category	46
4.1.2.1.1 Vector plots results	46
a. Base case	46
b. Stair case wind-catcher	48

	Page
c. X-type wind-catcher I.....	49
d. X-type wind-catcher II.....	50
e. Twin K-type wind-catcher I.....	51
f. Twin K-type wind-catcher II.....	52
4.1.2.1.2 Contour Plots.....	53
a. Results of the base case simulation.....	53
b. Comparison of the results between the base case and the proposed designs as wind speed 4m/s.....	56
c. Comparison between the base case and the K-type wind-catcher II with wind speed 2m/s.....	60
4.1.2.2 Second category.....	63
4.1.2.2.1 Vector plots results.....	63
a. Twin K-type wind-catcher.....	63
b. Extra design I.....	64
c. Extra design II.....	65
4.1.2.2.2 Contour Plots.....	66
a. Comparison of the results of the base case, the Twin K-type wind-catcher II, the extra design I and II with wind speed 4m/s.....	66
b. Comparison of the results between the base case and the extra design II with wind speed 2m/s.....	69
4.2 Discussion.....	72
Chapter V Epilogue.....	74
5.1 Conclusion.....	74
5.2 Application.....	76
5.3 Recommendation.....	76
5.4 Future researches.....	77
REFERENCES.....	78

	Page
APPENDICES	81
VITA.....	101



จุฬาลงกรณ์มหาวิทยาลัย
CHULALONGKORN UNIVERSITY

LIST OF FIGURES

Figure 1 CFD model of a residential house considered in this study.....	5
Figure 2 Architectural plans of the case study.....	6
Figure 3 The position of wind-catcher	7
Figure 4 Function of wind-catcher during day-time and night-time	9
Figure 5 The wind-catchers in the hot.....	9
Figure 6 The wind-catcher in.....	9
Figure 7 The elements of a wind-catcher	10
Figure 8 The structure of a wind-catcher	11
Figure 9 The various types of wind-catcher.....	11
Figure 10 Airflow patterns.....	13
Figure 11 A cross section of a space showing the performance of a basic wind-catcher	14
Figure 12 A cross section of homes with courtyard and garden, showing the air movement by convection	14
Figure 13 Reduction of free wind speed (100%) by an opaque wind barrier	16
Figure 14 The Bioclimatic Chart shows about the possibilities to spread thermal comfort	17
Figure 15 The monthly temperature in Phnom Penh, Cambodia and its possibility that can be used the natural ventilation to increase thermal comfort	18
Figure 16 Daily temperature in March in Phnom Penh, Cambodia.....	19
Figure 17 Daily temperature in April in Phnom Penh, Cambodia.....	19
Figure 18 Daily temperature in May in Phnom Penh, Cambodia	20
Figure 19 Monthly humidity in Phnom Penh, Cambodia	20
Figure 20 Daily humidity from day 1st to day 31st in March in Phnom Penh, Cambodia	21
Figure 21 Daily humidity from day 1st to day 30th in April in Phnom Penh, Cambodia	22
Figure 22 Daily humidity from day 1st to day 31st in May in Phnom Penh, Cambodia	23
Figure 23 Monthly wind velocity in Phnom Penh, Cambodia.....	24
Figure 24 Daily wind velocity In April in.....	25

Figure 25 Daily wind velocity In March in.....	25
Figure 26 Daily wind velocity In April in Phnom Penh, Cambodia.....	25
Figure 27 A bioclimatic version of the psychometrics chart showed about the possibilities to use natural ventilation to increase thermal comfort	26
Figure 28 Views of the case study row-house.....	30
Figure 29 The measurement tools for measuring wind velocity, humidity,.....	31
Figure 30 A position (A) of actual measurement on a roof plan of a case study.....	31
Figure 31 The positions (C and D) of actual measurement on the ground floor of case study.....	32
Figure 32 The position (D) of actual measurement on the first floor	32
Figure 33 The positions (A, B, C, and D) of actual measurement.....	32
Figure 34 The possibility of the four sided openings and three sided opening wind-catchers to capture the wind.....	33
Figure 35 The three wind directions in the program represent the eight actual wind directions.....	34
Figure 36 The various forms of proposed designs (all apertures of the house are completely open).....	37
Figure 37 The sizes and the positions of extra design I and II	38
Figure 38 This graph shows the percentage of houses' apertures usage.....	40
Figure 39 The feeling of row houses' occupants related to thermal comfort in the houses.....	40
Figure 40 The feeling of stuffiness of row houses' occupants.	41
Figure 41 The feeling of row houses' occupants related to wind blowing inside the houses.....	41
Figure 42 The results of the wind velocity from the actual measurement in	43
Figure 43 The results of the temperature from the actual measurement in	43
Figure 44 The results of the humidity from the actual measurement in.....	43
Figure 45 The results of the wind velocity from the actual measurement in the kitchen	44
Figure 46 The results of the temperature from the actual measurement in the kitchen	44
Figure 47 The results of the humidity from the actual measurement in the kitchen of	44

Figure 48 The results of the wind velocity from the actual measurement in the family	45
Figure 49 The results of the temperature from the actual measurement in the family	45
Figure 50 The results of the humidity from the actual measurement in the family room	45
Figure 51 A plot plan section level of a ground floor at the left side and a plot plan section level of a first floor at the right side (1.1 m above floor level)	46
Figure 52 A plot plan section level of a ground floor (left) and a first floor (right) as porosity	47
Figure 53 A vector plot results of a ground floor (left) and a first floor (right)	47
Figure 54 A section position I (left) and II (right) of the stair case wind-catcher	48
Figure 55 A vector plots of a section I (left) and II (right) of the stair case wind-catcher	48
Figure 56 A section position I (left) and II (right) of the X-type wind-catcher I	49
Figure 57 A vector plots of a section I (left) and II (right) of the X-type wind-catcher I	49
Figure 58 A section position I (left) and II (right) of the X-type wind-catcher II	50
Figure 59 A vector plots of a section I (left) and II (right) of the X-type wind-catcher I	50
Figure 60 A section position I (left) and II (right) of the twin K-type wind-catcher I	51
Figure 61 A vector plots of a section I (left) and II (right) of the twin K-type wind-catcher I	51
Figure 62 A section position of	52
Figure 63 A vector plot of a section of the twin	52
Figure 64 The results as contour plots of the family room, the kitchen, and	53
Figure 65 The results of the wind velocity in the living room, the kitchen, and	54
Figure 66 The results as contour plots of the living, the kitchen, and	54
Figure 67 The results of the average wind velocity in the living room, the kitchen,...	55
Figure 68 The results as contour plots after applying proposed designs in	56
Figure 69 The results of the average wind speed in the living room before and	57
Figure 70 the results of the average wind speed in the kitchen before and	58
Figure 71 the results as contour plots after applying proposed designs in the family	59

Figure 72 the results of the average wind speed in the family room before and after applying the proposed designs with wind speed 4m/s.....	59
Figure 73 the results as contour plots before and after applying the twin k-type	60
Figure 74 the of the average wind speed before and after applying the twin K-type	61
Figure 75 The of the average wind speed before and after applying the twin K-type	61
Figure 76 The results as contour plots before and after applying the twin k-type	62
Figure 77 the of the average wind speed before and after applying the twin K-type wind-catcher in the family room with a wind aped 2m/s	62
Figure 78 A section position I (left) and II (right) of the twin K-type wind-catcher II....	63
Figure 79 A vector plots of a section I (left) and II (right) of the twin K-type wind-catcher II.....	63
Figure 80 A section position of the extra design I	64
Figure 81 A vector plot of the section of	64
Figure 82 A section position of	65
Figure 83 A vector plot of the section of the extra design II	65
Figure 84 The results as the contour plots before and after applying the proposed designs in.....	66
Figure 85 the average wind speed in the living room before and after applying.....	67
Figure 86 The average wind speed in the kitchen before and after applying	67
Figure 87 The results as the contour plots before and after applying the.....	68
Figure 88 The average wind speed in the family room before and after applying the proposed designs with a wind speed 4m/s	68
Figure 89 The results as the contour plots before and after applying the extra design II in the family room and the kitchen with a wind speed 2m/s	69
Figure 90 the average wind speed in the living room before and after	70
Figure 91 The average wind speed in the kitchen before and after applying	70
Figure 92 The results as the contour plots before and after applying the extra design II in the family room with a wind speed 2m/s	71
Figure 93 The average wind speed in the family room before and after applying the extra design II with a wind speed 2m/s	71

Chapter I

Introduction

In this chapter, the research background, the research questions, the research problems, the aims of study, the restriction of study and the expected outcomes are illustrated.

1.1 Research Background

Cambodia is among the poorest countries in the world as a result of long decades of civil unrest and conflict. Since 1989, this country was introduced to the free market economic policy by the government. At the same time, many investments took place in the country and led to high demand for land and real estate development. Since the early 1990's, Phnom Penh City Hall has attempted to revive the economy and quickly develop Phnom Penh, the capital of Cambodia. Phnom Penh has been taken long time in order to relief from the wars. After Paris treaty 1991, the reformation of the old city had started. After the national election in 1993 as well as the coming of the UN, many types of buildings were reused and constructed such as villas, row-houses, and the other administrative buildings. In the last period of the 90s, the city started to develop faster. At the same time, land-use was managed and the division of plots for row-house constructions also started to manage along the main roads. Starting from 2001, row-houses were built continuously in Phnom Penh city

According to a 2008 census report, it showed that 48.49% of residential buildings in Phnom Penh city are row-house type. Moreover, if we divide as quarter, 4/7 quarters which are located in the middle of the city resulted that 54.59% up to 79.83% is row-house type while 3/7 quarters which is not the trade zones resulted 14.51% to 20.22%. Therefore, we consider that row-houses play the important role in residing for people in Phnom Penh city (Penh 2009).

According to VPC Asia Pacific Regional Conference on 16th March 2012 in Phnom Penh, Cambodia showed that there were many big satellite cities in Phnom Penh such as Grand Phnom Penh, Camko City, Diamond Island, Beong Kok and so on; they didn't look over the row-house projects. Furthermore, this type of house has been being constructed everywhere in Phnom Penh city by foreign investments as well as local investments such as Borey Mengly's project, Borey Peng Hout's project, Borey 999's project, and Borey Sopheak Mongkol's project etc. So the number of this type of house would be increased more and more in the future. Therefore, the raise of housing is still in strong demand in the current Cambodian market. So if

we do a comparison between types of houses in Phnom Penh city, we will see that the majority of residential type buildings are row-houses. That's why this type of house will always be seen everywhere in Phnom Penh city.

Although this type of house is popular for Phnom Penh people since the past till nowadays, it was noticed that the form and concept of spaces design are deemed to be an unnoticeable improvement. The issues of narrow spaces, lack of natural ventilation and light still remain till nowadays. At the same time, the numbers of people which have been living and coming to live in row-houses are increasing every year; this number might cover almost half of the number of people who are living in the other dwellings. Citing the reasons above, should people continue to live in those houses, houses which lack natural ventilation and light, when we can improve them to the point of comfortability?

1.2 Research Problem

Row houses in Cambodia, by design are commonly deep and dark, and harbors issues that can cause problems for occupants. Lack of proper ventilation is one of the factors causing the houses to be hot in the summer. In fact, natural ventilation is one of the important elements which can be used in order to provide comfortableness and healthiness to building occupants; furthermore, it can also deduct the use of non-renewing polluting fuel consumption. Most of us seem to forget that wind is a renewable energy source which is very important and a very efficient element for spreading a thermal comfort area.

Thus, this study will address the natural ventilation issue commonly found in row-houses by doing an analysis of building form, air apertures' position, and air movement in order to find out the main causes for lack of airflow. Then a new extra design is going to be applied to existing buildings or newly constructed buildings by applying wind-catcher with passive design techniques in order to improve natural ventilation movement in row-houses.

1.3 Research Questions

1.3.1 How do the differences of wind-catcher's positions and wind-catcher's types affect row-house in terms of natural ventilation?

1.3.2 Can wind-catcher be applied appropriately to a row-house in a tropical monsoon area in order to improve indoor air movement and decrease the thermal discomfort people feel?

1.4 Purposes

1.4.1 To understand the differences of wind-catcher's positions and its types affect to the row-house in terms of natural ventilation

1.4.2 To confirm that wind-catcher is able to apply to row-house in a tropical monsoon area appropriately (Cambodia) in order to improve indoor air movement to increase thermal comfort.

1.5 Restrictions

1.5.1 This study focuses on sharing space (living room, kitchen, family room) of a row-house, which is a two story residential building (4.1m width, 16m length, and 14.60 m height) in Phnom Penh, Cambodia

1.5.2 This study focuses on only an improvement of air movement in row-house in order to decrease the thermal discomfort people feel.

1.5.3. This study focuses on only three months (March, April, and May) which are the months that consist of the highest average temperatures in the year and when the average relative humidity is not too high to use natural ventilation in order to increase thermal comfort.

1.6 Expected outcomes

After this research we expect as follow:

1.6.1 Understanding the effects of wind-catchers to the row-houses in Phnom Penh, Cambodia

1.6.2 Finding out which wind-catcher causes the best results when applied to the row-houses in a tropical monsoon region, such as Cambodia.

1.6.3 Providing an adequate indoor natural ventilation to induce thermal comfort for row-house occupants.

Chapter II

literature reviews

In order to spread the knowledge in the field of study, some literatures need be reviewed. The reviews focused on the previous study of row-house in terms of improving natural ventilation, the wind-catchers, the thermal comfort, and the wind cooling strategies.

2.1 Row-house

The designs of row-houses have many flaws that haven't been improved for years (M.M. Tahir 2010). Lacking airflow as well as inadequate indoor air quality in row-houses is one of the most prominent issues that have yet to be addressed in its designs. Therefore, there were many studies conducted by various researchers intended to revive the usage of natural ventilation in row-houses.

Agung Murti Nugroho, Mohd Hamdan Ahmad and Dilshan Remaz Ossen conducted a research aimed to investigate the comfort condition in single-storey row-houses in Malaysia. Actual measurements and the CFD (FloVent) method were carried out. The results of this research showed that the thermal environment outcomes were not enough to supply thermal comfort. Additionally, poor air movement of the single-side ventilation reduces the level of indoor thermal comfort (Angung Murti Nugroho 2007).

Agung Murti Nugroho conducted a research aimed to find out the effect of solar chimney geometry for stack induced ventilation strategies. A single story row-house located in Malaysia was selected to study. CFD (FloVent) was carried out to investigate airflow as well as solar radiation. Then, new proposed designs of solar induced ventilation have been conducted and assessed. As the result, the solar chimney geometry of 1m width, 3m length, and 3.5 height can increase wind velocity up to 0.6m/s. Moreover, the study concerned that for all various terms, internal natural ventilation in a row- house with solar chimney was better than one that did not have a solar chimney (Nugroho).

Nurulashikin conducted a research to find out the effect of frontage enlargement design to natural air movement in a two-storey row-house in Kuala Lumpur. CFD (FloVent) was carried out in this research. As the result, the proposed design with frontage enlargement provided the best solvent, but it was inadequate to meet a need of wind speed 1m/s to reach thermal comfort (TALIB 2007)..

Nasibeh Sadafi conducted their research intended to measure the thermal conditions and to model the comfort condition in a two-storey row-house situated in Kuala Lumpur, Malaysia. Inova Thermal Data Logger equipment was used in this research and ceiling fans were installed to the building to enhance indoor air movement in order to provide a better thermal condition. The results showed that thermal comfort time was approximately fifteen hours per day (6:30 pm to 10:30 am). On the other hand, using ceiling fans to enhance indoor wind speed was capable of improving thermal condition. However, using ceiling fans was less effective while the air with the ambient temperature being above the comfort range (Nasibeh Sadafi 2007).

M.M. Tahir et al (2010) did a research aimed to solve many problems such as thermal issues, safety problems and improper renovations of row-houses. Existing literatures related to the raised floor innovation concept were reviewed. As the result, the ground floor level of row-houses should be raised above the ground level in order to enhance air movement (M.M. Tahir 2010).

A.R. Mohammadi et al conducted a research intended to analyze the effect of a balcony to induce natural air movement and to prove that the balcony was workable as a transitional space to monitor and enhance outside air into a two-storey residential row-house located in Kuala Lumpur, Malaysia. MacroFlo simulation method was carried out in this study in order to investigate the effects of air flow pattern. The results concluded that the variability of a balcony was not workable to enhance the natural air movement in row-house in a hot and humid climate experienced by Malaysia (A.R. Mohammadi 2010).

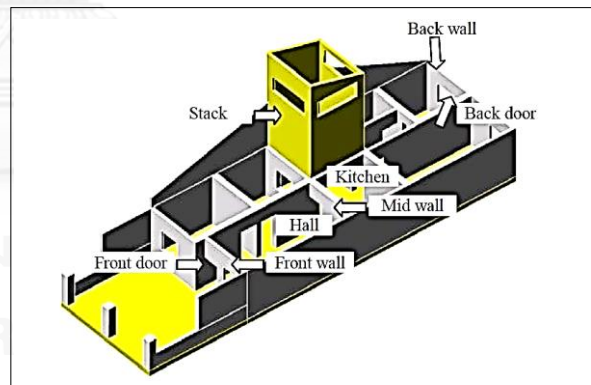


Figure 1 CFD model of a residential house considered in this study

Source: A.R. Mohammadi 2010

Haslinda Mohamed Kamar et al did a research intended to observe the thermal comfort level caused by natural ventilation in a single-storey row-house in Malaysia. Actual measurements and the CFD method were carried out. The effects of airflow were investigated by use of the CFD program before and after installing a ceiling fan in the middle of the hall and using small extractor fans on the front and back walls of the house. The study found that air movement in the house experienced a different pattern. Moreover, wind velocity was normally not less than

0.2m/s. Wind velocity increased in the middle of the hall section. The airflow became a bit turbulent in the stack as it meet outside air coming in. On the other hand, there is no any effect in thermal comfort level by installing fans as described above (Haslinda Mohamed Kamar 2012). This result was not consistent with a research conducted by (Nasibeh Sadafi 2007).

H.Altan and M. B. Tabriz conducted research aimed to apply four sides of wind-catcher to a two-storey house, ground floor sized 14.95m x 14.85m and first floor sized 11.90m x 14.85m, in Larnaca which is a hot and humid climate region as shown in Fig. 2

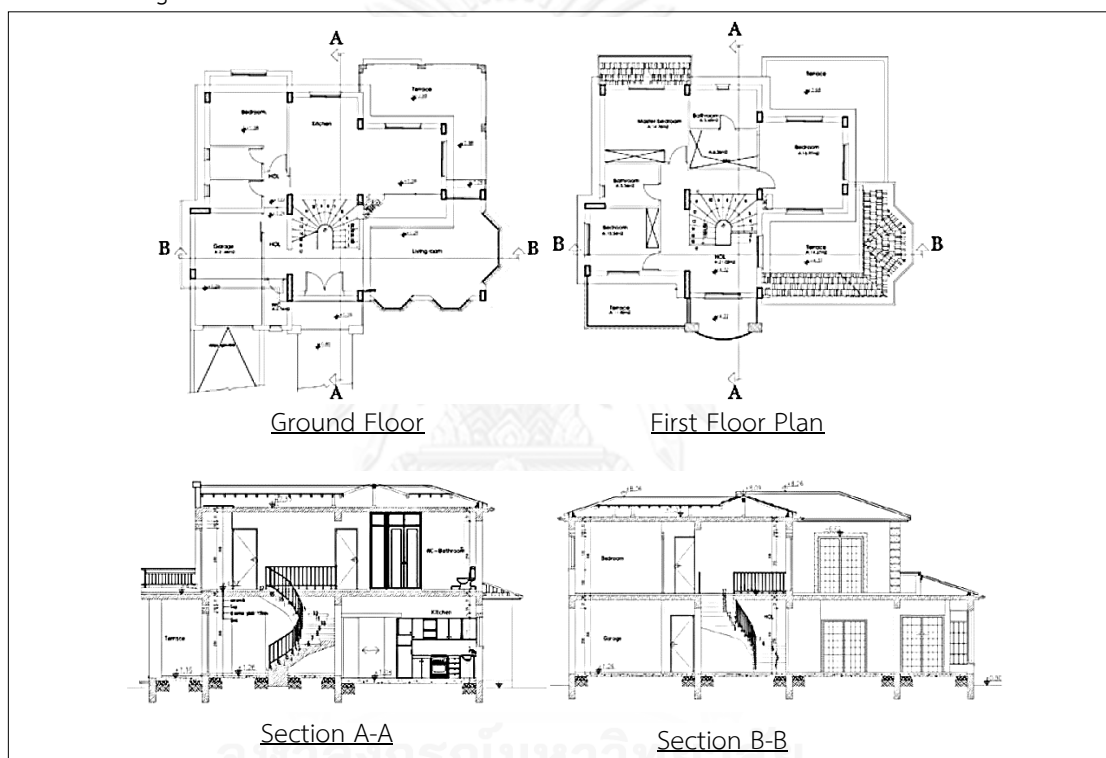


Figure 2 Architectural plans of the case study

Source: Tabriz 2011

The wind-catcher was installed to the stair case of the building as shown in Fig. 3. Ecotect and WinAir 4 programs were carried out to analyze thermal and air movement. As the results of applying the wind-catcher, during the night time, the temperature in the building decreased from 1°C to 2°C and provided thermal comfort to building occupant. However, the temperature inside the building increased by 3°C to 4°C during the day time. Therefore, the study suggested that closing the wind catcher's aperture that faces the prevailing wind is a good solution; doing so wind catcher can work as a stack ventilation by exhausting warm air through the leeward opening of wind-catcher during the day time (Tabriz 2011).

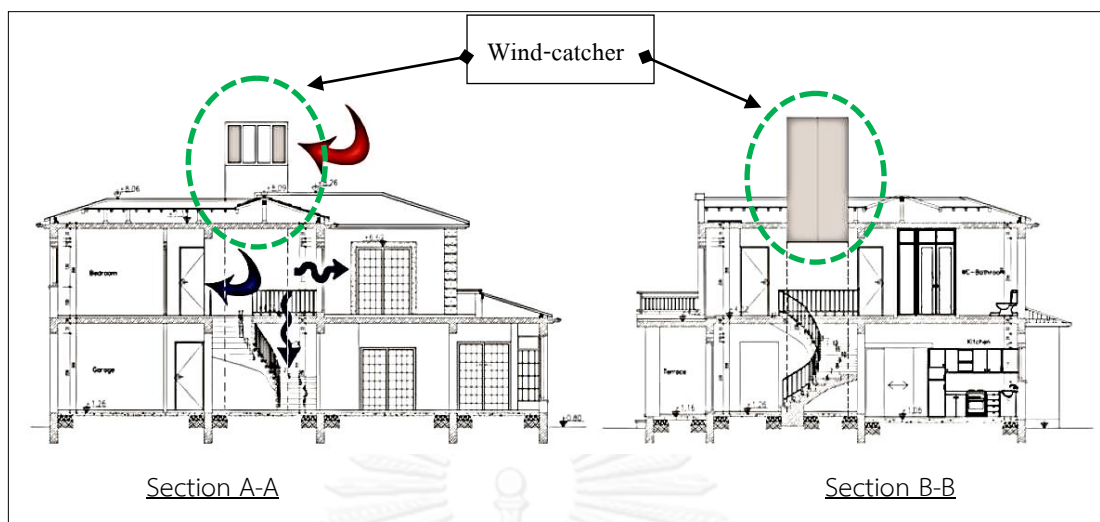


Figure 3 The position of wind-catcher

Source: Tabriz 2011

Mohamad Mohd Faizal et al conducted a research intended to investigate the effects of air movement in a row-house with a porch and without a porch located in Malaysia. The models have been simulated by using Reynolds-Averaged Navier-Stokes model. The results showed that some types of porch were capable of inducing airflow. Some would decrease airflow depending on the size of porch and its relation to its position between a porch and apertures (Mohamad Mohd Faizal 2013).

Yaik-Wah Lim conducted a research aimed to evaluate the impacts of indoor comfort on occupants' perceived health in Malaysia. A questionnaire was carried out for this research and many different types of row-house were studied in order to find out the comfort problems and health issues in those buildings. As the result, natural ventilation issue was worse than daylighting problem in row-houses. This study discerned that indoor air movement was a serious problem that should be addressed in order to provide indoor comfort as well as well-being to building occupants (Lim 2013).

Literatures reviewed above indicated that there were many studies aimed to improve natural ventilation in row-house by various strategies. However the strategies, pro and con, success and failure, and inadequacy of the studies always prevailed. Enlargement of frontage can significantly affect airflow in a row-house while the wind flow perpendicularly or obliquely to the façade, front or rear side, of the house. But it might not significantly affect when the wind flow perpendicularly to the side-walls of the house because row-houses are typically constructed sharing side-walls with another row-house. Therefore, side-walls of row-houses are normally incapable to capture the wind. On the other hand, the concept of raising the ground floor above the ground level is a very good solution for enhancing air movement, but in terms of privacy, security, and the amount of space efficient use might be decreased. Another solution, solar chimney induced ventilation might be acceptable by all terms, but it needs more advanced techniques to enhance air temperature difference from inside and outside. As a tropical climate, hot and humid, there has little air temperature difference between inside and outside is commonly not higher than 5°C (Rajeh 1989). Therefore, solar induced ventilation might be difficult to work in tropical climate (Wardah Fatimah Mohammad Yusoff 2012).

A research study conducted in 2011 by M. B. Tabriz about applying a wind-catcher to a residential building, which was reviewed above showed the result that the use of wind-catcher can increase ambient temperature inside the building during the day time and during the night time the wind-catcher cooled the building. Almost all of the houses' apertures were opened during the day time so the wind coming through various apertures from outside of the house crashed with the wind flowing downward through the wind-catcher resulting in cause the problem of airflow circulation inside the building. This caused internal wind velocity to decrease and increased the ambient temperature inside the house. At night, almost all of houses apertures are closed so wind-catcher might be workable without disturbance. Wind-catcher can work efficiently alone as it consists of two functions, capture fresh air outside into the building and exhaust stall air out. Therefore, in the case of a row-house in a tropical region, which is limited in cross-ventilation, wind-catchers should be a very good natural ventilation device to enhance natural air movement into a building because it is workable for all directions of wind flow.

2.2 Wind-catcher

Wind-catchers are environmentally friendly, depending on only natural forces to operate (A'ZAMI 2005). People have used wind-catchers for the reasons of providing fresh air into the buildings, decreasing the indoor temperature if the indoor temperature is between 25-35 °C, extracting warm air from the building when the indoor temperature is higher than 35 °C, and cooling during the night time (Roaf 2005).

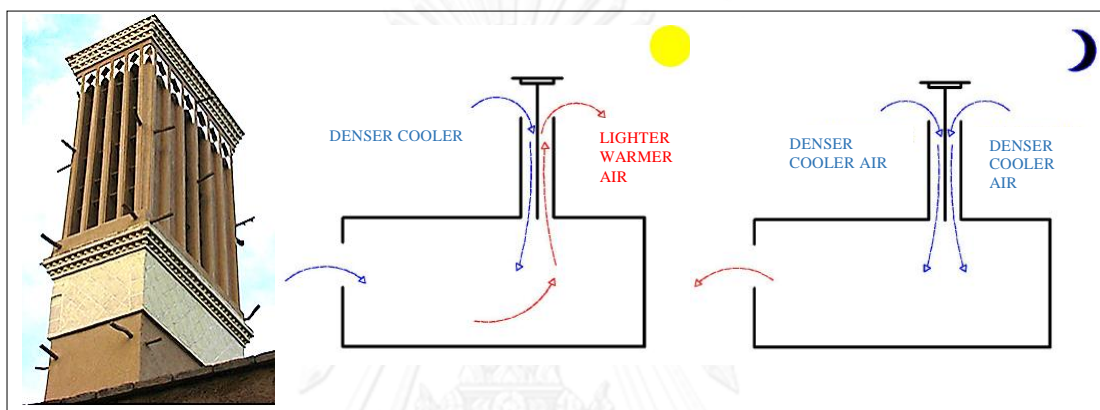


Figure 4 Function of wind-catcher during day-time and night-time

Source: A'ZAMI, A. 2005

Traditionally wind-catchers were installed on the top of the buildings to capture outside fresh air into the interior of the buildings from inlets and to exhaust stale air outside the building through outlets. The wind-catchers work as stack ventilations when there is no wind pressure. There are two primary types of traditional wind-catchers; wind-catchers in hot and humid areas and another one in hot and arid areas (Khatami 2009) as shown in Fig. 5 and Fig. 6



Figure 5 The wind-catchers in the hot and humid areas

Source: Khatami 2009



Figure 6 The wind-catcher in the hot and arid areas

Source: Khatami 2009

Typically, wind-catchers in hot and humid regions have larger apertures and a shorter stack than the wind-catchers in hot and arid areas (Ghobadian 2006). Moreover, traditionally each room of the houses consists of its own wind-catcher in order to enhance air movement as well as to improve indoor air quality (Roaf 2005); additionally, in the hot and humid regions, plaster of lime, ashes and mortar plaster have been used to create wind-catchers (A'ZAMI 2005). In the hot and arid regions, mud bricks or the backed bricks, and plaster of straw were used. Mud bricks enable to absorb heat during the day time and to exhaust heat during the night time (Ghaemmaghmi 2005) and (Mohamad Mohd Faizal 2013).

Both wind-catcher types comprise of three of the same main elements, the tower, opening, and partition. The tower is an important element which is installed on the roof of the building, its height relies on its position and the surrounding. Vents or openings are positioned in the highest part of the wind-catcher in order to capture fresh air into the buildings. The number of vents relies on the wind directions in the specific zones or regions.

Partitions are divided into two main types, the main partitions and sub partitions. Main partitions are used to divide the tower into many shafts in order to capture air from one or more shafts and to exhaust stall air from one of more shafts. Sub partitions are used to strengthen the wind-catcher's structure, increase wind velocity which affects the overall air flow rate (Ghaemmaghmi 2005).

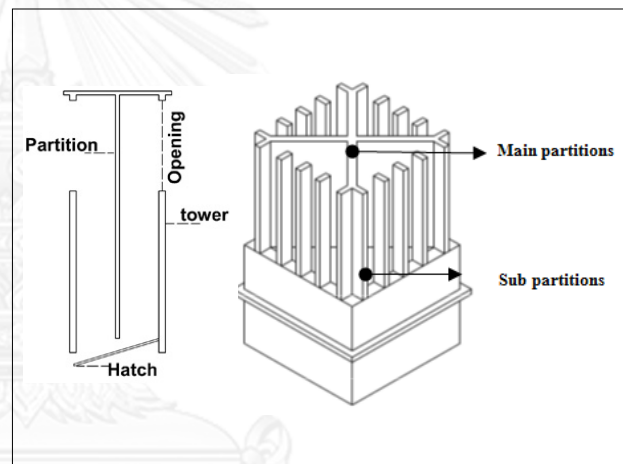


Figure 7 The elements of a wind-catcher

Source: Ghaemmaghmi 2005

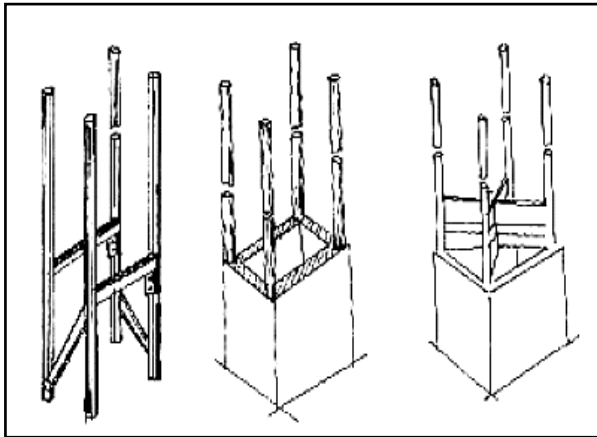


Figure 8 The structure of a wind-catcher

Source: Ghaemmaghami 2005

In order to set up a wind-catcher as traditionally constructed, first, build a wooden frame covered by mud bricks. Then, build bricked mud main partitions inside, the full length of the wind-catcher in order to support the structure. After that, use the horizontal wooden beams at various levels of the wind-catcher's structure (Ghaemmaghami 2005)

Normally wind-catchers are classified based on their cross sectional plan as well as the number of their openings (maleki 2011)

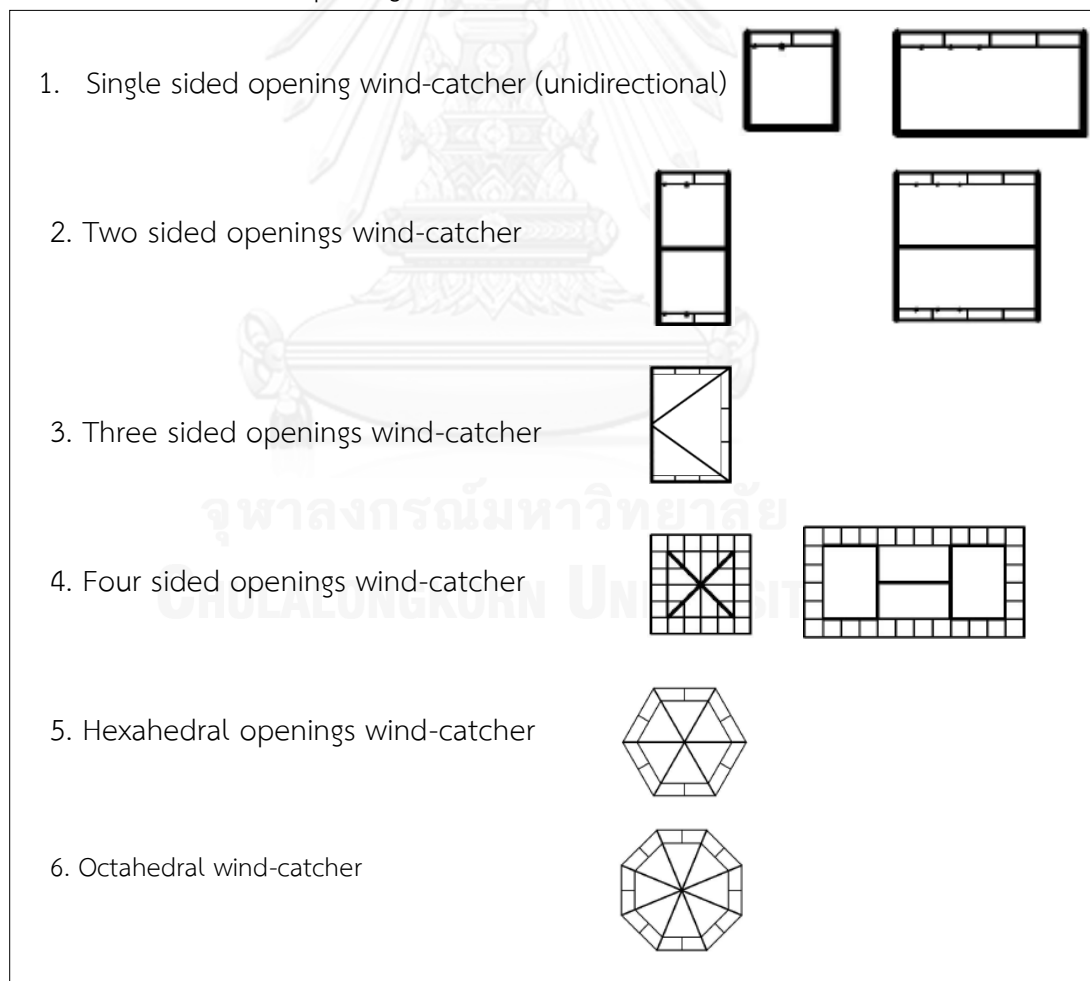


Figure 9 The various types of wind-catcher

Source: Maleki 2011

According to a review of wind-catchers above showed that there were many types of wind-catcher, but in this research study only a three sided openings and a four sided openings were selected to study. As the wind rose in appendix A indicated that there were eight wind directions in Phnom Penh, Cambodia; therefore the use of double three sided openings wind-catcher and a single four sided wind-catcher are suitable because they capable of capturing wind from eight directions. A single sided opening wind-catcher and a two sided openings wind-catcher were not suitable in Cambodia climate because they cannot capture wind from eight directions. In fact, a hexahedral sided openings wind-catcher and an octahedral wind-catcher can be used in Cambodia climate, but a restriction of model simulation of a Heat X program led to a decision in eliminating these two cases.

2.3 Thermal comfort

Thermal comfort is the condition of mind that expresses satisfaction with the thermal environment and is assessed by subjective evaluation (ANSI/ASHRAE Standard 55-2013, Thermal Environmental Conditions for Human Occupancy). There are six factors which influence human thermal comfort. Those factors are air temperature, relative humidity, mean radiant temperature, air velocity, clothing insulation, and metabolism rate (Fanger 1967).

Yet this review focuses on wind velocity which is a very important factor to provide thermal comfort to occupants. This review intends to emerge that wind velocity is proper to be used in order to provide thermal comfort to people in tropical monsoon as Phnom Penh city, Cambodia.

2.3.1 Principle of Air movement

Wind is one of the important components for architecture designs to induce the level of building occupants' gratification as well as to increase the feeling of comfort. So, it is very important to understand the nature of wind in order to design the buildings to be able to function usefully without providing negative effects to the environment (Al-Shaali 2002). Although the phenomenon of the wind is irregular, we can assess the characteristic of its movements. The differences of landform as well as objects can change the wind patterns. Sometimes those factors can slow the wind velocity; sometimes they can increase its velocity (Allard 1998) as shown in Fig.

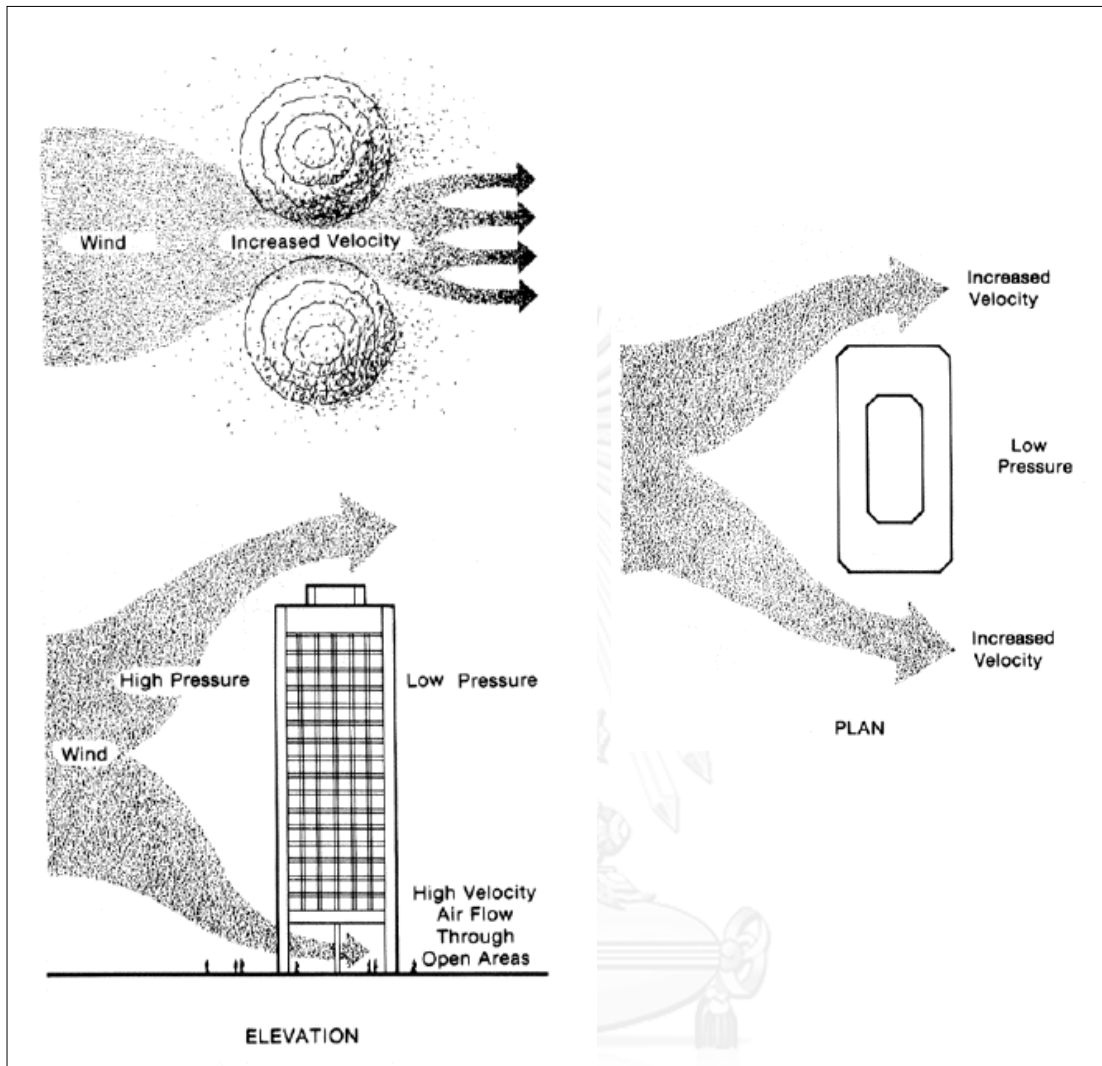


Figure 10 Airflow patterns

Source: Allard 1998

Basically, there are two principle of air movement; air movement by pressure differential and air movement by convection. According to the Bernoulli theory, pressure differential produced by variability of wind velocity, this causes air flow from a higher pressure zone to a lower pressure zone. The theory presents that the pressure dismisses when a moving of fluid increases in speed (Fathy 1986). A good example of a system that runs with pressure differential is a wind-catcher (Tavakolinia 2011) as shown in Fig.11

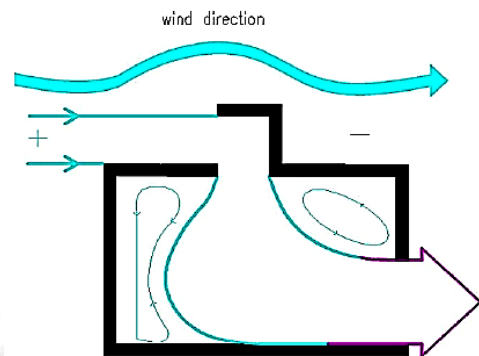


Figure 11 A cross section of a space showing the performance of a basic wind-catcher

Source: Tavakolinia 2011

The convection causes by warmer air move upward because of the difference in density between cool air and warmer air. Therefore, the more the buoyancy force and stack effect will be, the higher the temperature is. This can lead to a stack effect driven by buoyancy (Tavakolinia 2011). The tendency of a liquid or gas to cause less dense object to float or rise to the surface is called buoyancy (Encyclopedia 2011) as shown in Fig. 12

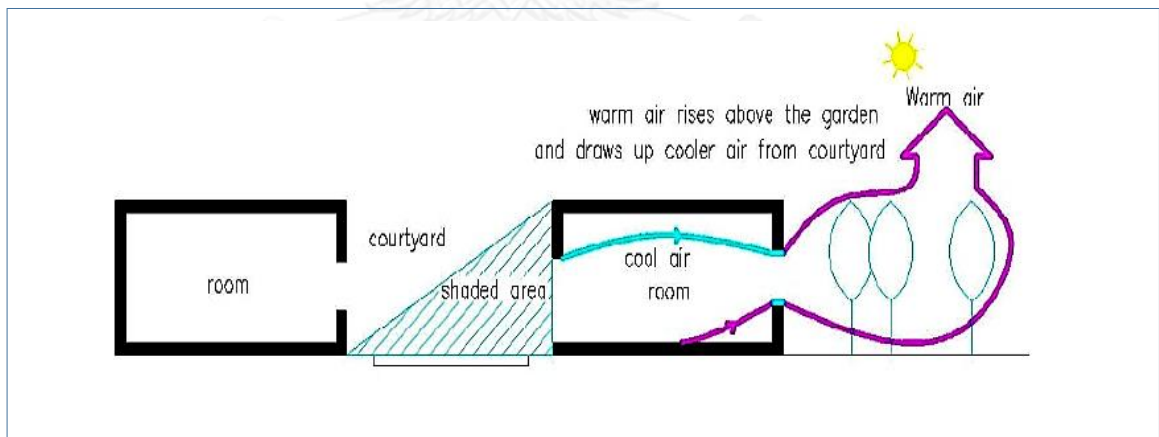


Figure 12 A cross section of homes with courtyard and garden, showing the air movement by convection

Source: Tavakolinia 2011

2.3.2 Natural ventilative cooling

Typically, natural ventilation can increase thermal comfort by use of two strategies, comfort ventilation and nocturnal ventilative cooling. The comfort ventilation strategy is a direct physiological effect by allowing wind flow in to the building to reduce the thermal discomfort people feel. The nocturnal ventilative cooling strategy is an indirect one by using the cooled mass to decrease temperature during day time and only ventilate during night time. If humidity is high, natural ventilation can be used to increase thermal comfort by providing a direct physiological cooling effect to the building occupants, although doing so can increase interior temperature. Yet, increasing air speed is the condition of high humidity which is needed to enhance the rate of sweat evaporation from the skin to reduce the thermal discomfort people feel. According to the evaluation of the ventilation from the human comfort opinion, not only does the overall amount of airflow needs to be stressed, but also the speed of the airflow distribution in the space. Especially considering that all points of wind speeds have a strong relationship to each other as the airflows follow each other from the inlet to the outlet. In the case that a small inlet and a larger outlet is in a linear arrangement, the average wind speed in the room will be much lower while the wind speed at the inlet is maximum. Furthermore, when the inlet and the outlet are not arranged in a linear position or the wind flows obliquely, the wind will change the direction of the existing airflow in the room, creating wind turbulence in the entire room. Although the overall airflow is reduced, the average wind flow in the room is better and at the same time, the average wind velocity might be increasable. More importantly, when the wind flows obliquely to the building, it can provide a better airflow condition in the building because a pressure gradient can be produced along the windward walls. Moreover, in this such case, if there are two openings positioned at the building or at the ventilated room along the windward wall, the upper aperture works to capture outside air and the lower one works to extract stale air from the ventilated space. In contrast, when the wind flows perpendicularly to the wall positioned at the two openings, both apertures are not different in pressure led to decrease the ventilation of the building (Givoni 1994).

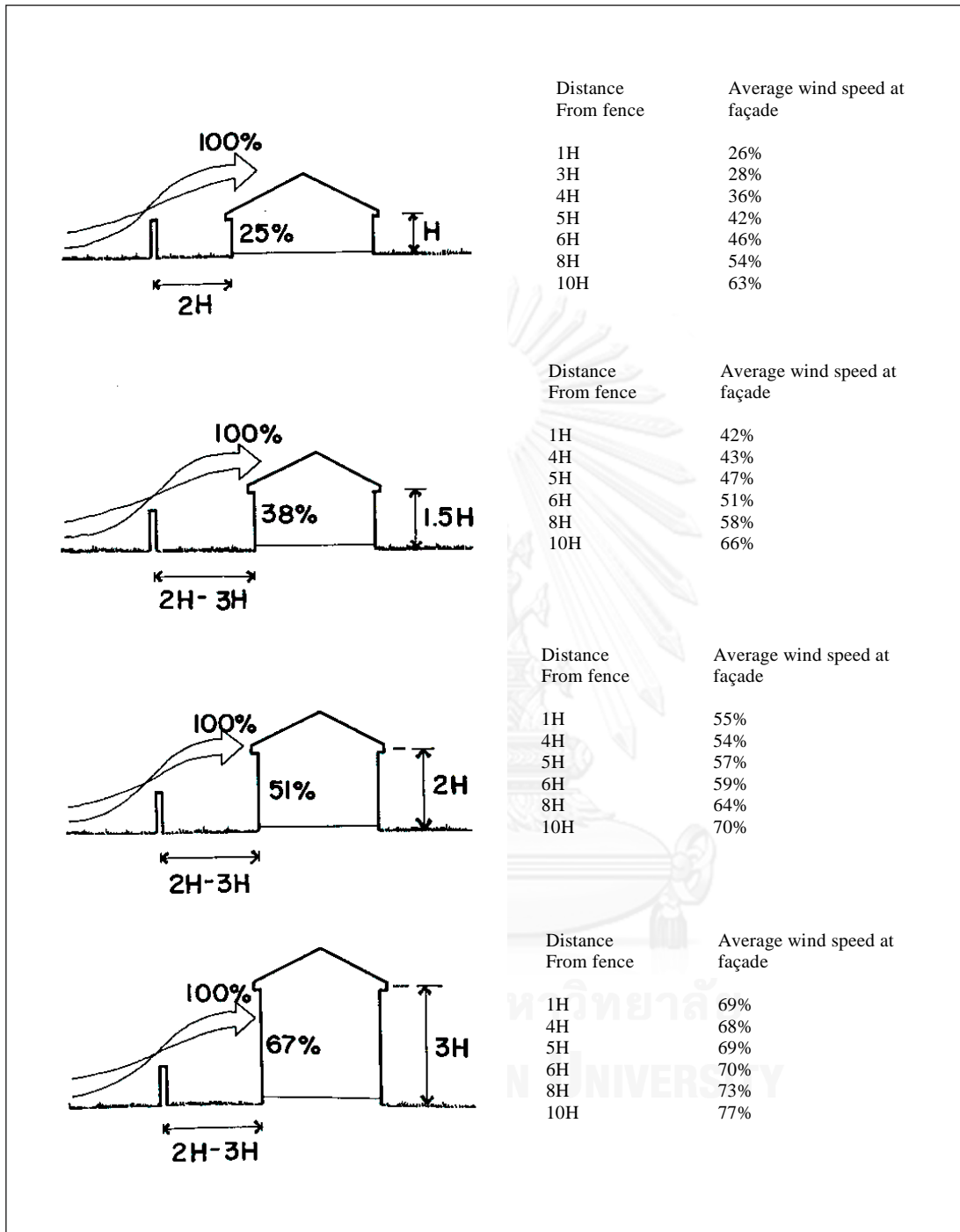


Figure 13 Reduction of free wind speed (100%) by an opaque wind barrier
 Source: Gerd Hauser and Gernot Minke 1994

2.3.3 Possibility of Using Wind Velocity to induce thermal comfort to building occupants in Phnom Penh, Cambodia

According to the Bioclimatic chart (Olgay 1961) which was re-prepared by Dr. Sunthorn Boonyathikan as shown in Fig. 14 indicated that there are many strategies to spread the thermal comfort zone. Those strategies can be used effectively depending on two main factors; air temperature and humidity. More importantly, the thermal comfort zone can spread by the use of air velocity when air temperature is between 23 °C to 33 °C and humidity between 37% to 75% (บุญญาธิการ 2000)

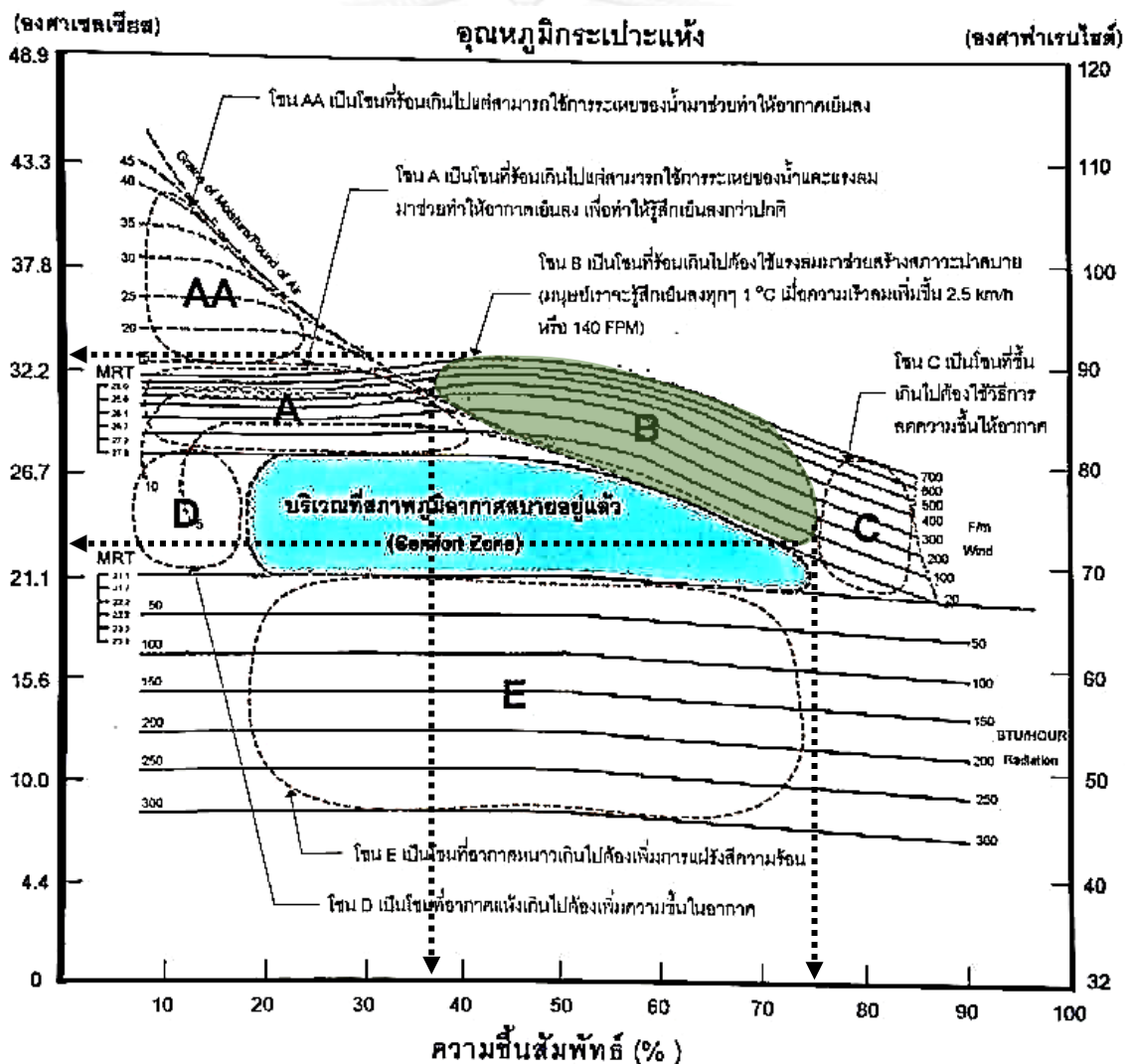


Figure 14 The Bioclimatic Chart shows about the possibilities to spread thermal comfort
Source: บุญญาธิการ 2000

In order to find out the possibility of using natural ventilation to increase thermal comfort for row-house's occupant in Phnom Penh, Cambodia, looking to the temperature, humidity, and wind velocity need to be considered.

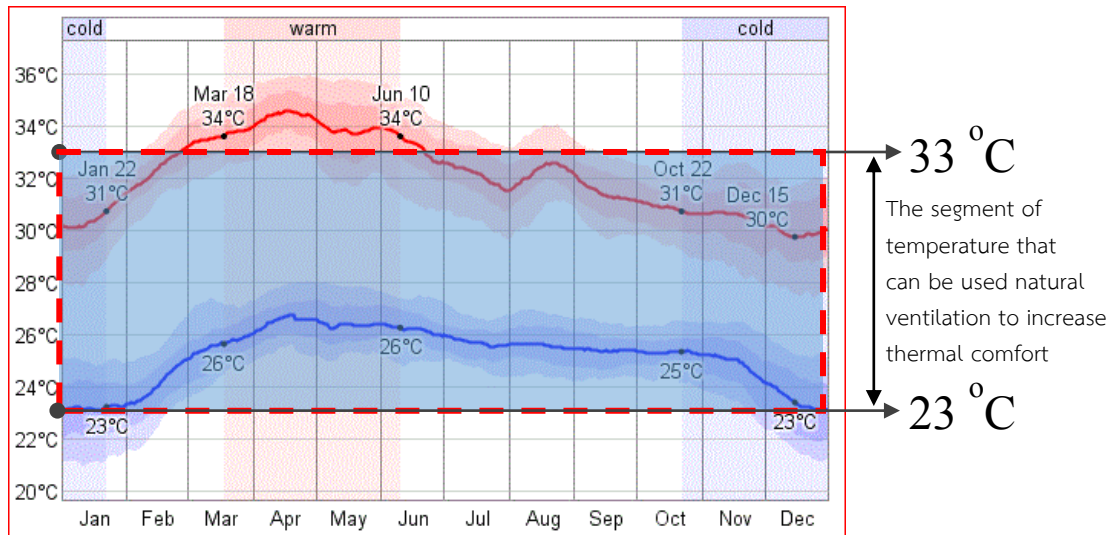


Figure 15 The monthly temperature in Phnom Penh, Cambodia and its possibility that can be used the natural ventilation to increase thermal comfort

Source: Phnom Penh International Airport (Pochentong International) weather station

As the temperature shown in Fig. 15 indicated that March, April, and May are the hottest months in the year in Cambodia. Therefore, the need of thermal comfort should be much more than other months. However, we have to look closer to the daily temperature in those months in order to make sure that the use of natural ventilation is possible for increase thermal comfort.

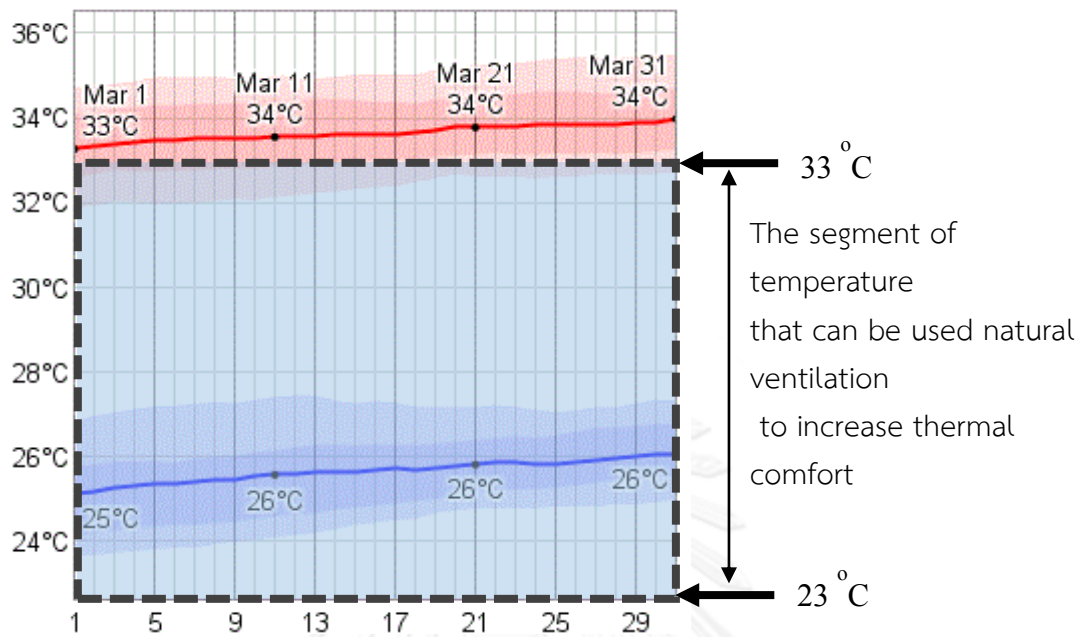


Figure 16 Daily temperature in March in Phnom Penh, Cambodia
 Source: Phnom Penh International Airport (Pochentong International) weather station From 2003-2012

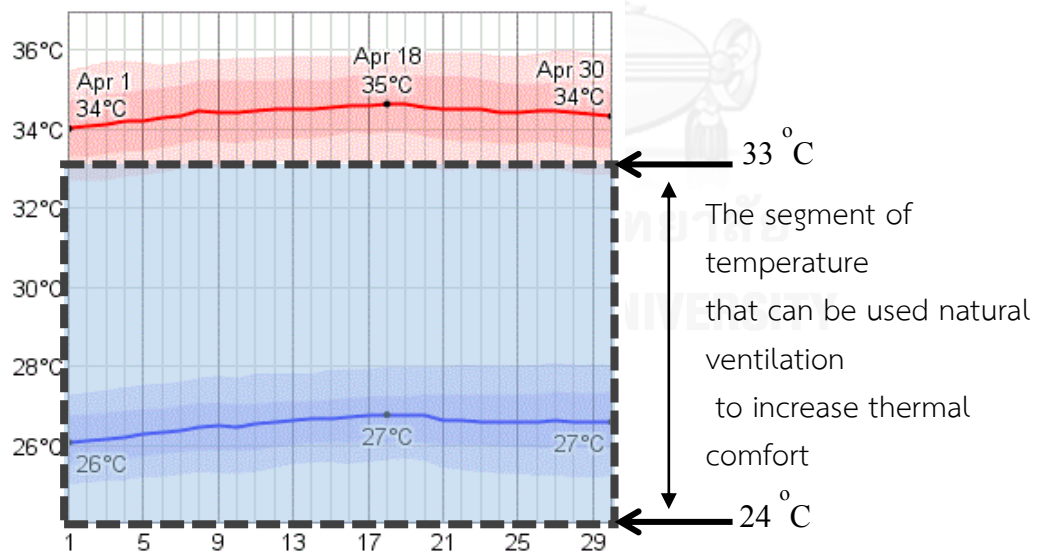


Figure 17 Daily temperature in April in Phnom Penh, Cambodia
 Source: Phnom Penh International Airport (Pochentong International) weather station From 2003-2012

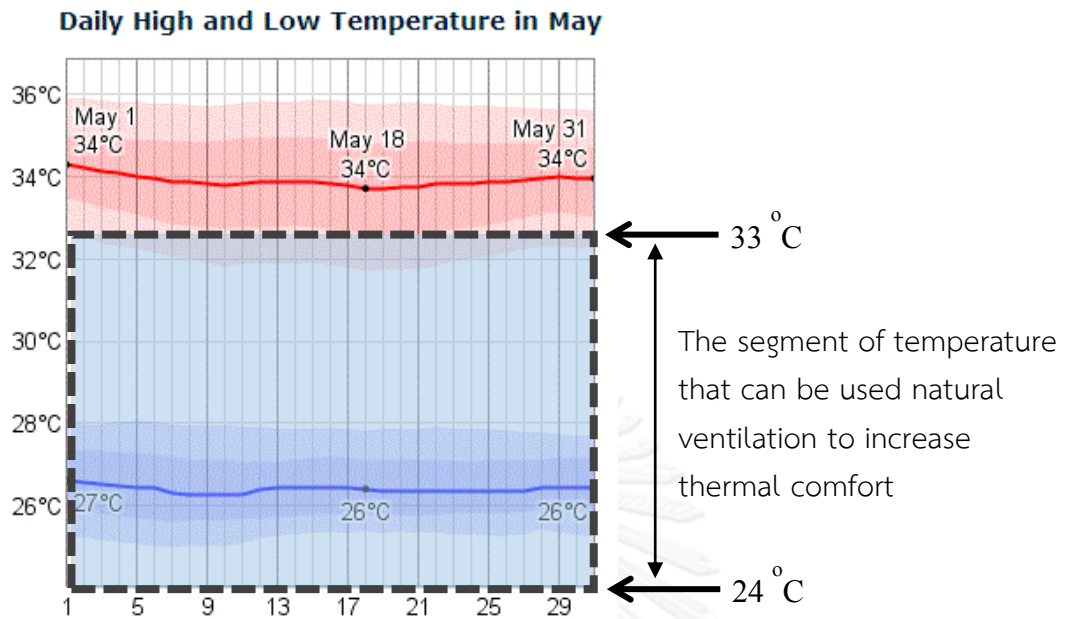


Figure 18 Daily temperature in May in Phnom Penh, Cambodia
 Source: Phnom Penh International Airport (Pochentong International) weather Station From 2003-2012

According to Fig. 16, Fig. 17, and Fig. 18 indicated that the majority of daily temperature in March, April, and May are not too high to use natural ventilation to increase thermal comfort. So, the temperature in those months were not the problem for increase the thermal comfort by using wind velocity.

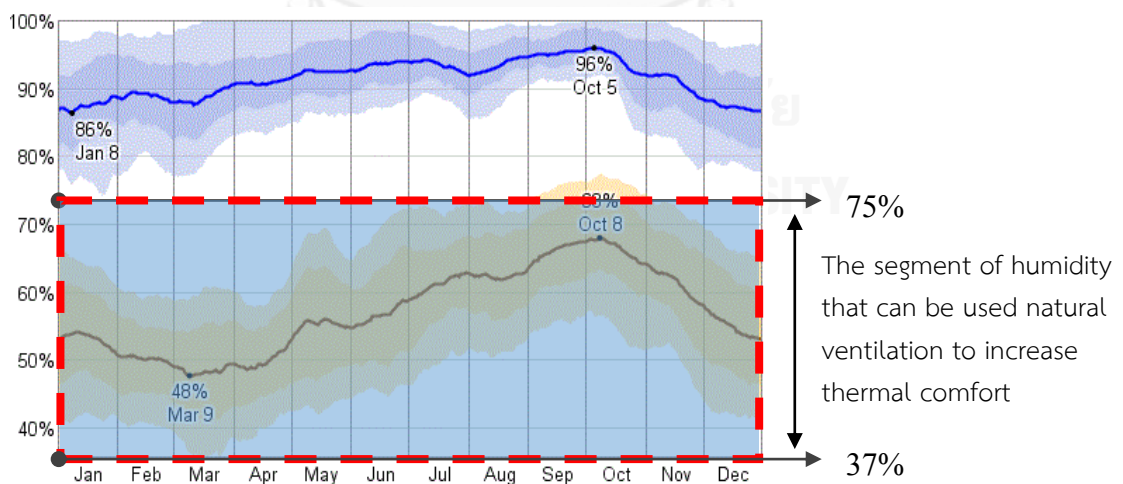


Figure 19 Monthly humidity in Phnom Penh, Cambodia
 Source: Phnom Penh International Airport (Pochentong International) weather station From 2003-2012

According to Fig. 19 demonstrated that nearly half part of the humidity in March, April, and May was in a limitation of the possibility to use natural ventilation to increase thermal comfort and other half part was out of the limitation. However, we need to look closer to daily humidity in order to make sure about the duration that we can get benefits.

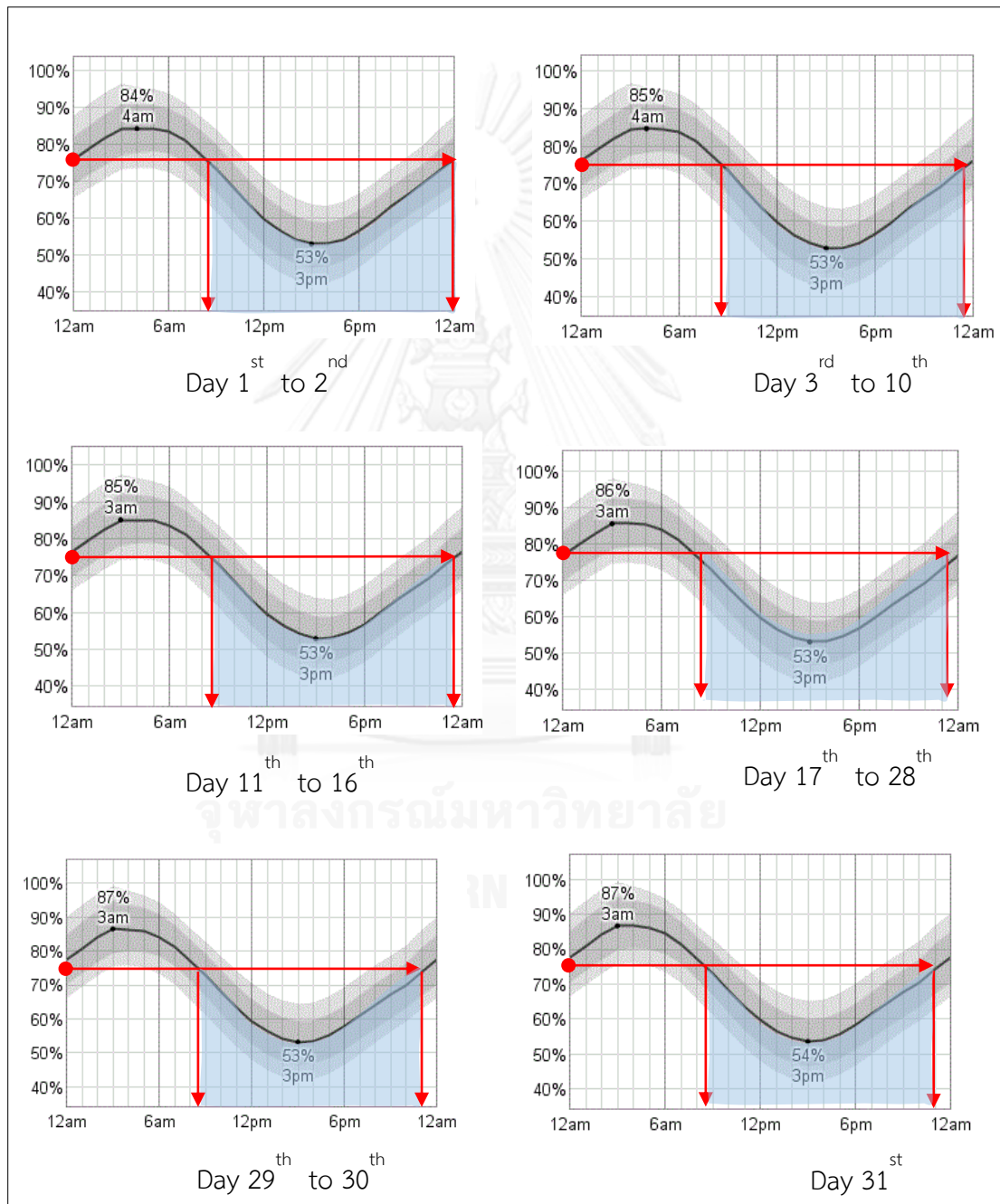


Figure 20 Daily humidity from day 1st to day 31st in March in Phnom Penh, Cambodia
 Source: Phnom Penh International Airport (Pochentong International) weather station
 From 2003-2012

According to Fig. 20 indicated that the possibility of using natural ventilation to increase thermal comfort in March depend on daily humidity is between 8:30 am to 11:30 pm as the blue highlights of possible areas were emerged.

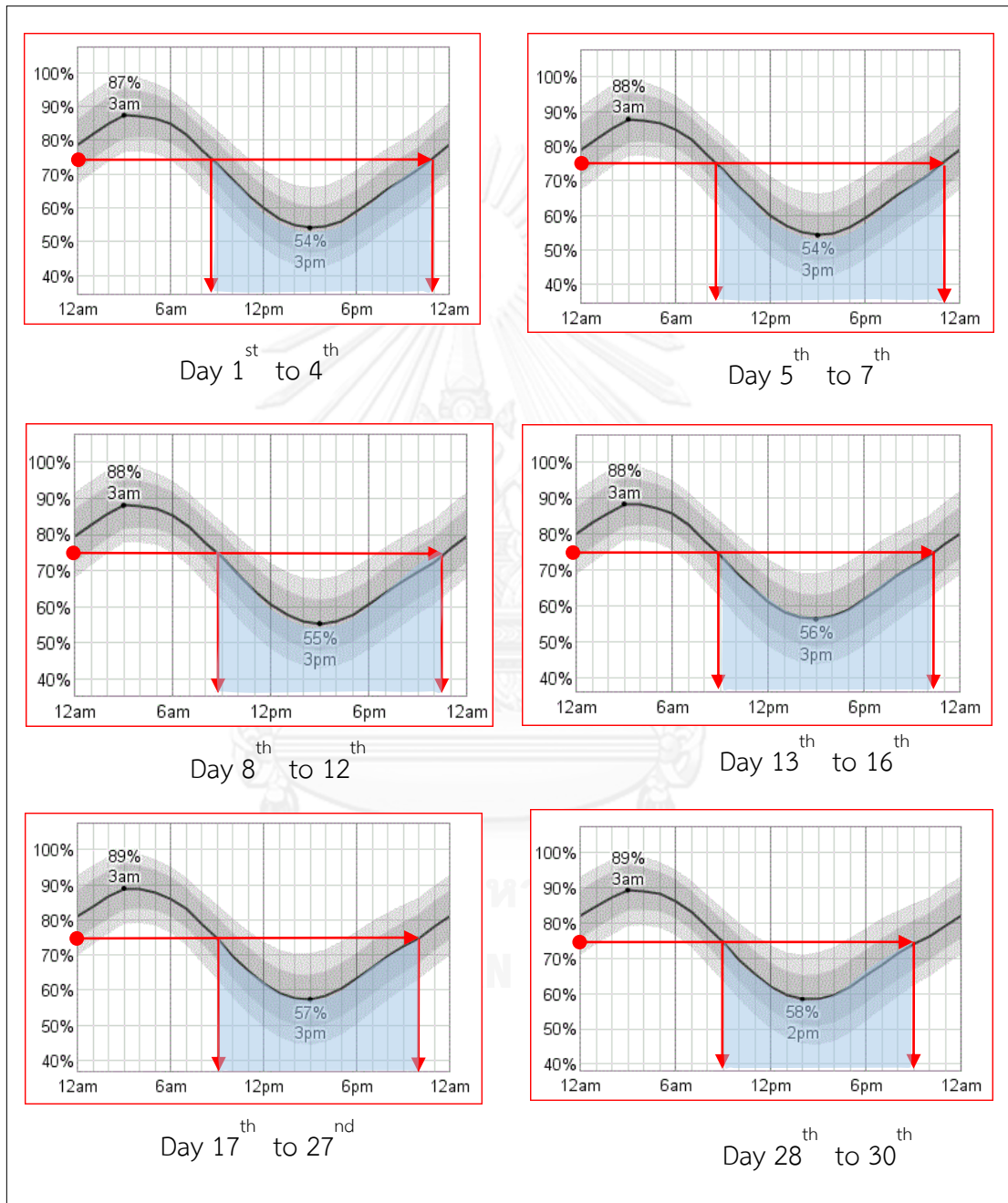


Figure 21 Daily humidity from day 1st to day 30th in April in Phnom Penh, Cambodia
Source: Phnom Penh International Airport (Pochentong International) weather station
From 2003-2012

According to Fig. 21 indicated that the possibility of using natural ventilation to increase thermal comfort in April depend on daily humidity is between 9 am to 11 pm as the blue highlights of possible areas were emerged.

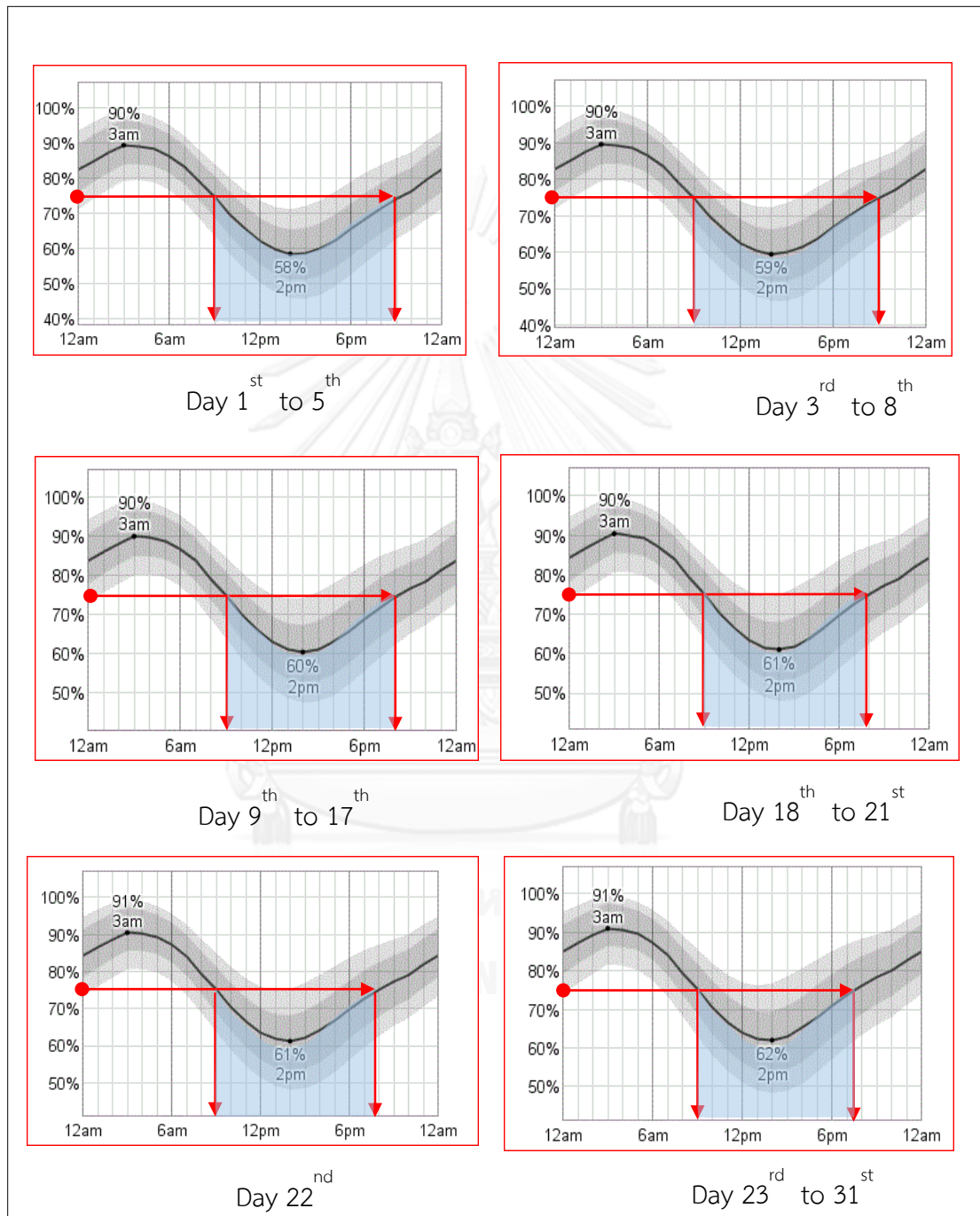


Figure 22 Daily humidity from day 1st to day 31st in May in Phnom Penh, Cambodia
 Source: Phnom Penh International Airport (Pochentong International) weather station
 From 2003-2012

According to Fig. 22 demonstrated that the possibility of using natural ventilation to increase thermal comfort in May depend on daily humidity was between 9 am to 8 pm as the blue highlights of possible areas were emerged.

According to the Fig. 20, Fig. 21, and Fig. 22 indicated that the possibility of humidity to increase thermal comfort by using natural ventilation was around 9 am to 10 pm. However, the duration that impossible was the sleeping time. Therefore, the natural ventilation device should be closed before go to the bed and start to use it again in the morning.

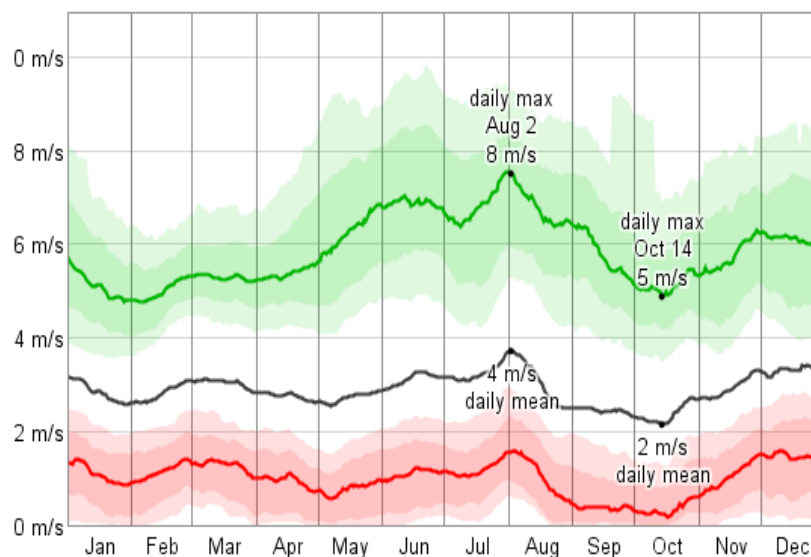


Figure 23 Monthly wind velocity in Phnom Penh, Cambodia

Source: Phnom Penh International Airport (Pochentong International) weather station From 2003-2012

According to Fig. 23 indicated that the average wind velocity in Phnom Penh, Cambodia was between 2m/s to 4m/s for all months. However, looking closer to the daily wind speed in March, April, and May need to be considered.

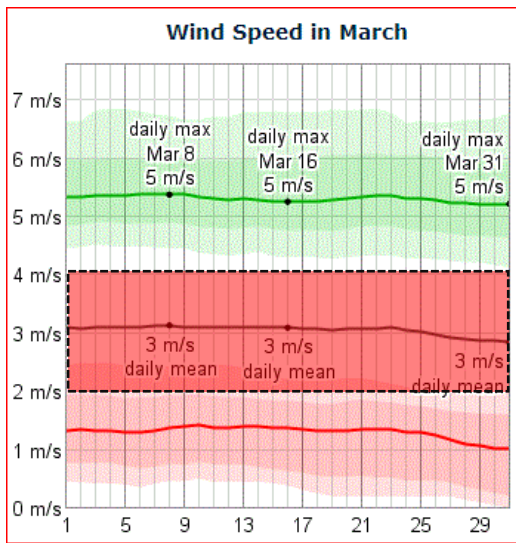


Figure 25 Daily wind velocity In March in Phnom Penh, Cambodia

Source: Phnom Penh International Airport (Pochentong International) Weather Station From 2003-2012

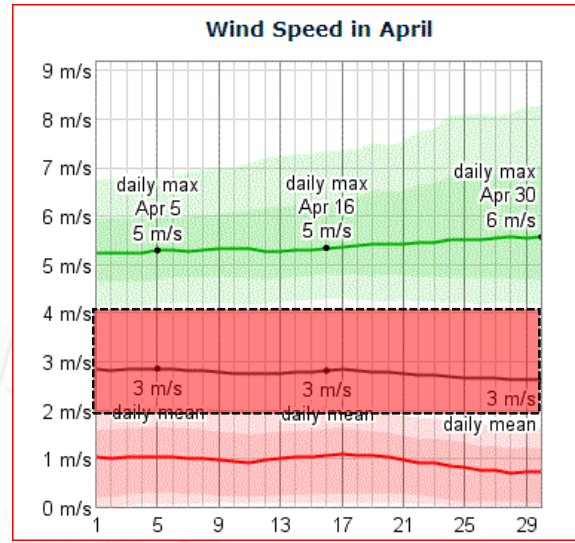


Figure 24 Daily wind velocity In April in Phnom Penh, Cambodia

Source: Phnom Penh International Airport (Pochentong International) weather station From 2003-2012

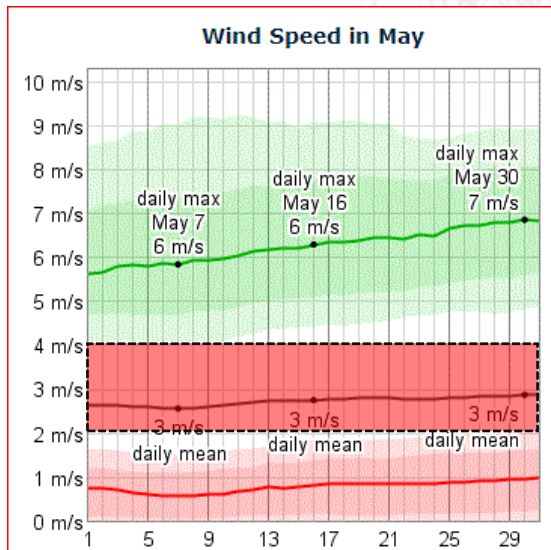


Figure 26 Daily wind velocity In April in Phnom Penh, Cambodia

Source: Phnom Penh International Airport (Pochentong International) weather station From 2003-2012

According to the Fig. 24, Fig. 25, and Fig. 26 indicated that the average wind velocity in March, April, and May was between 2m/s to 4m/s; these data led to make a decision of using wind speed for the model simulations in this research study.

As a bioclimatic version of the psychometrics chart (Nugroho 2006) showed that when relative humidity between 80% to 90% and air temperatures between 26 °C to 33 °C wind velocity from 0.6m/s to 1m/s can be used to provide thermal comfort to occupants (Agung Murti Nugroho 2007)

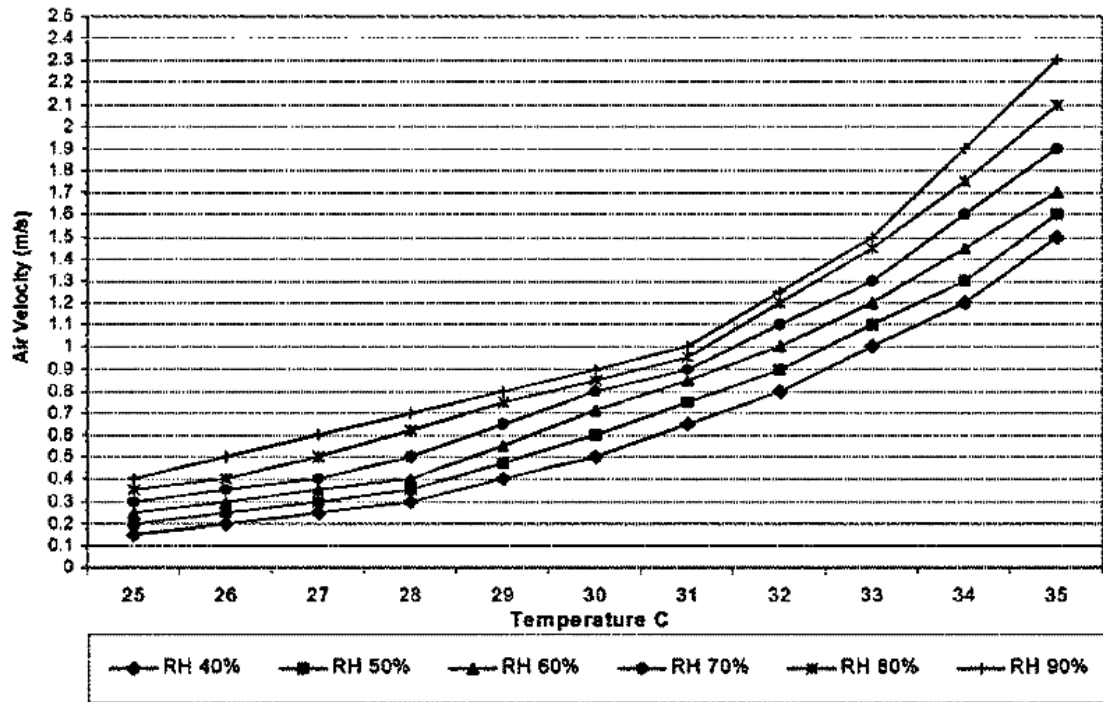


Figure 27 A bioclimatic version of the psychometrics chart showed about the possibilities to use natural ventilation to increase thermal comfort

Source: Nugroho 2006

According to the Bioclimatic chart as showed in Fig. 14, the Bioclimatic version of the psychometrics chart showed in Fig. 27, and all the weather data above, we expect that the wind velocity is enable and proper to be used in the weather condition of Phnom Penh, Cambodia in order to increase the thermal comfort.

Chapter III

Methodology

In this chapter, the detail of methodology is illustrated. First, the description of methodology from step to step, the diagram of methodology, and the process of data collection were illustrated. Then, the process of proposed designs were described in detail. All the results of these methodology are shown in chapter IV.

3.1 Description of Methodology

This research paper aims to improve indoor air movement in row-houses. In order to reach the goals, the methodology was conducted step by step as following:

Step 1: This is an important part for emerging the research background, research problems, research questions, objective, and scope of study and so on. Theories, standards, previous research papers, journals, and media related to how to improve indoor air movement with passive design technique and wind catcher were reviewed.

Step 2: In this step, the pilot experiment was conducted and computation fluid dynamic (Heat X) was employed in order to simulate base case model, various physical wind catchers, and design models.

Step 3: In this step, a comparison between the results from base case and pre-design which were simulated was conducted in order to find out causes of inadequate natural airflow in row-houses. Moreover, a comparison of various types of wind catcher was carried out in order to find out which is most efficient in solving the current problems.

Step 4: In this step, data collection was conducted via row-house occupant interviews and measurement of wind speed, wind direction, temperature, and humidity inside and outside row houses. In order to interview row-house occupants, a quantitative research was employed as “in-person interviews”. A questionnaire related to thermal comfort was created and the interviewees were asked to complete the answers which were prepared already in the sheets, ranked from least comfortable to most comfortable. Then, a row-house was selected to be a base case. Measurement of wind speed, wind direction, temperature, and humidity were conducted to the house.

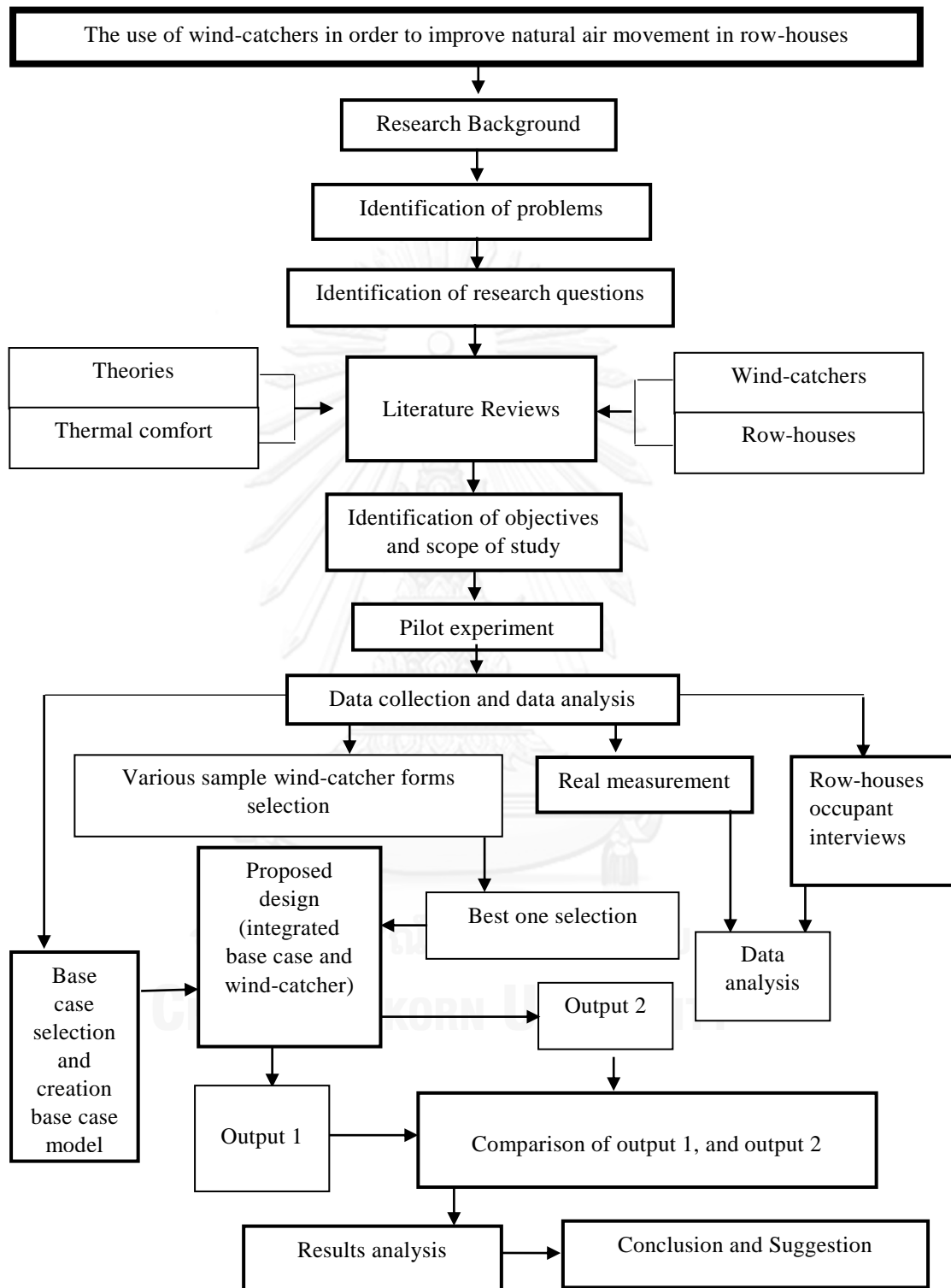
Step 5: In this step, the results from real measurements and interviews were analyzed to confirm if the hypothesis of lacking air movement and discomfort of living in row-houses are facts.

Step 6: In this step, propose new detail designs were conducted by employing passive design technique as applying wind-catchers in order to solve the problem of lacking air movement as well as discomfort of living. Moreover, Computation fluid dynamics (CFD) was conducted as Heat X was employed in order to simulate the models.

Step 7: In this step, results of new designs, results of base case in order to make sure that the results from the new designs caused for improved indoor air movement. Finally, a conclusion and recommendations were provided.



3.2 Diagram of methodology



3.3 Data collection and data analysis

3.3.1 Interview section

For this interview, 30 row houses which are two floors level were selected to interview. 15 houses are located at the north of Phnom Penh and other 15 houses are located at the south of Phnom Penh. Questionnaires related to thermal comfort was given to row houses' occupant and the interviewees were asked to complete the answers which were prepared already in the sheets, ranked from the least comfortable to the most comfortable. The main questions were asked as above:

- Do you feel hot of living in row-house?
- Do you feel stuffy of living in row-house?
- Do you feel the wind blow across inside the house?

The list of questionnaire is shown in appendix E at the end of the book.

3.3.2 Base Case Measurement Processing

3.3.2.1 Base case

A two stories (ground floor and first floor) row house which is consist of 4.3 m width, 16 m long, and 14.60 m height was selected as base case which is located in Phnom Penh city, Cambodia. The house oriented to the east, the windward mostly blow from the north at the time of wind speed record.



Figure 28 Views of the case study row-house

3.3.2.2 Measurement instruments

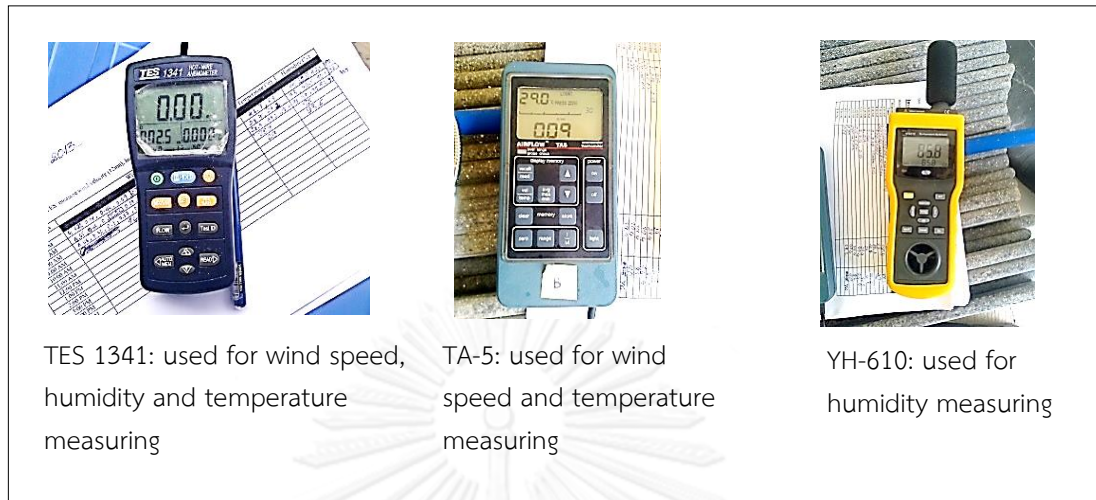


Figure 29 The measurement tools for measuring wind velocity, humidity, and temperature

3.3.2.3 Measurement Method

3.3.2.3.1 Measurement Positions

The position of measurement was divided into two main zones which were outside and inside. Moreover, inside zone was divided into 3 blocks for measurement which were living room, kitchen, and family room. For outside zone, a measurement instrument (TES 1341) was installed fixedly in the place where no any partition as barrier of windward and heightened it 1.1m above roof slab as point A.

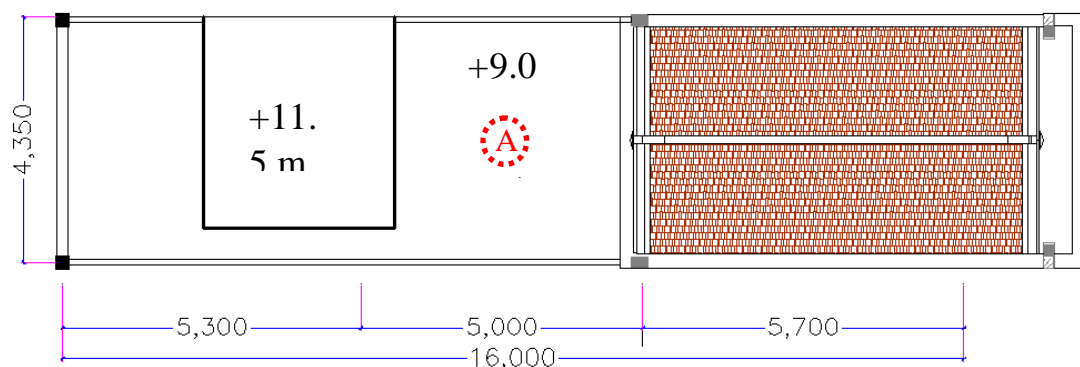


Figure 30 A position (A) of actual measurement on a roof plan of a case study

For inside zone, two measurement instruments (TA-s and YH-610) were installed in the middle of the rooms and heightened them 1.1 m above the floors as points B, C, and D.

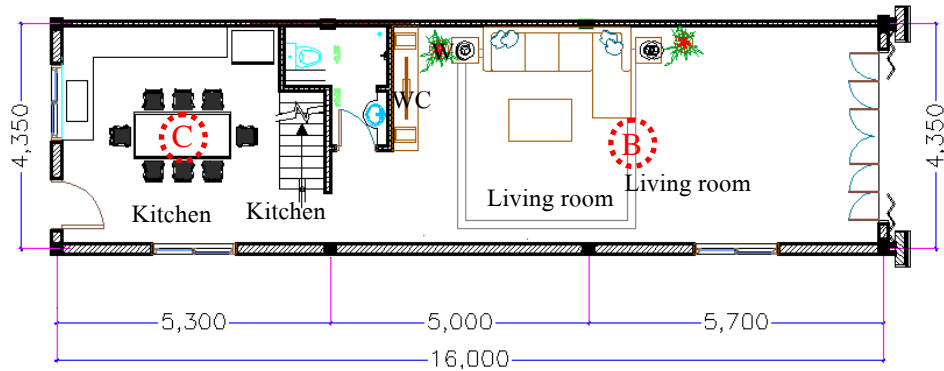


Figure 31 The positions (C and D) of actual measurement on the ground floor of case study

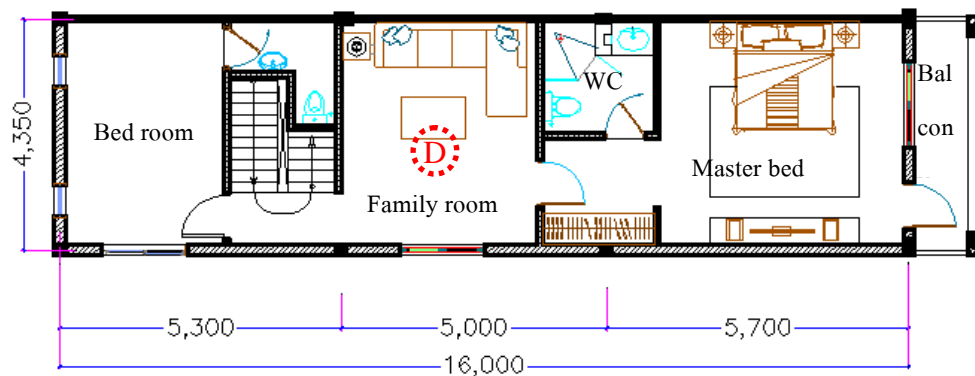


Figure 32 The position (D) of actual measurement on the first floor of case study

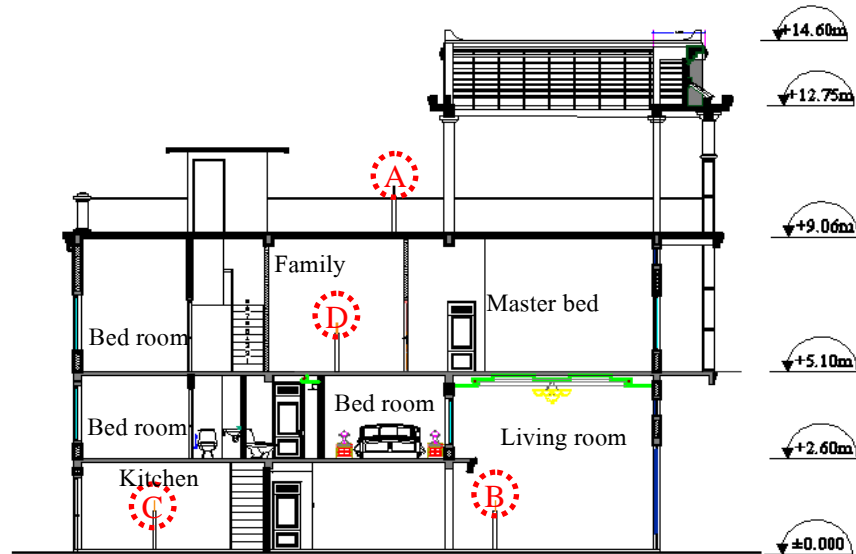


Figure 33 The positions (A, B, C, and D) of actual measurement

3.3.2.3.2 Measurement Schedule

The base case was measured for 12 hours; started from 6:00 am to 6:00 pm on 17 October 2013. Wind speed, temperature, and humidity of each position were recorded every hour and final data was summed up for average within the periods for each position per hour.

3.4 Proposed Designs

3.4.1 Selection of wind-catchers

The wind in Cambodia comes from all directions although more often it comes from the north and south-west directions. Therefore, in order to capture the wind and channel it down into the buildings, the X-type wind-catcher and the K-type wind-catcher were carried out in this study. The X-type wind-catcher and the K-type wind-catcher were selected in this study because they were capable of capturing the wind from all directions. In this study, a single X-type wind-catcher was used because it could capture wind from all directions; however, double K-type wind-catchers were used in order to capture wind from all direction as a single K-type wind-catcher capable of capturing wind only seven directions. As the wind rose in the appendix A showed that there were eight wind directions in Phnom Penh, Cambodia. Therefore, these two types of wind-catcher are the most appropriate.

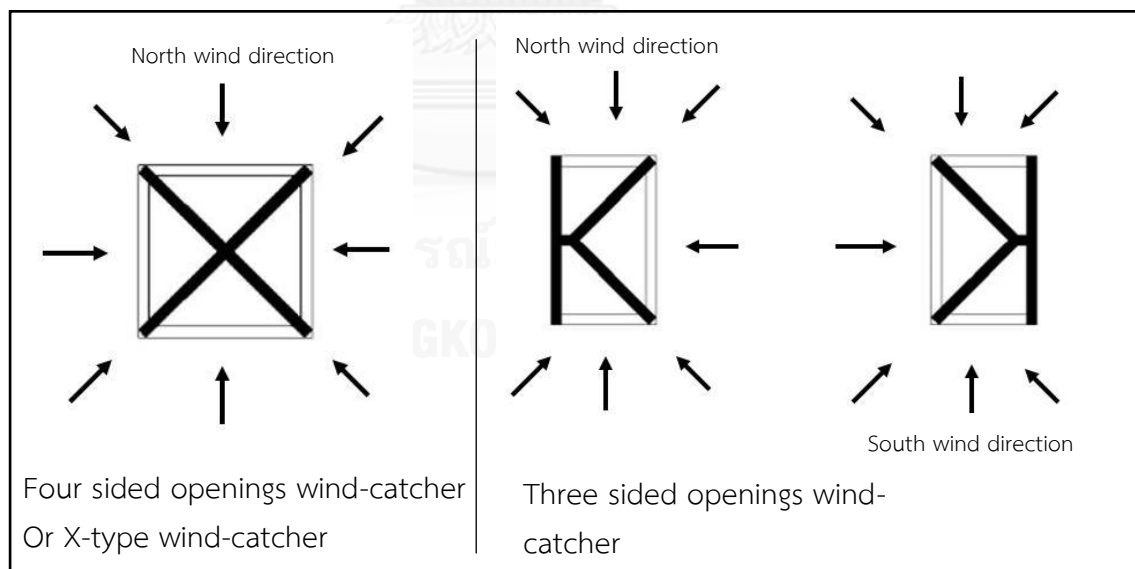


Figure 34 The possibility of the four sided openings and three sided opening wind-catchers to capture the wind

3.4.2 Determination of wind directions in the designs

In these designs, there were only three wind directions were used to simulation because of the restriction of the program. The south wind direction, the south-west direction, and the west wind direction were used to represent the actual wind directions in various degrees. The south wind direction in the program was used to represent the actual wind direction in 90° and 270° . The south-west wind direction in the program was used to represent the actual wind direction in 45° , 135° , 225° , and 315° . The west wind direction in the program was used to represent the actual wind direction in 0° , and 180° .

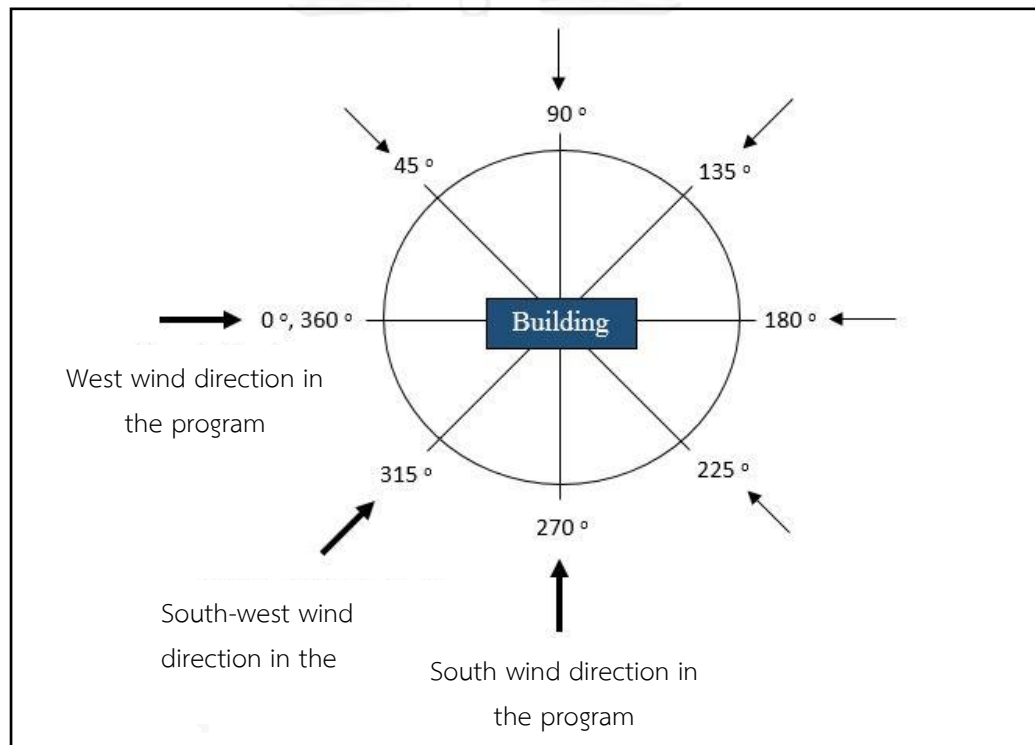


Figure 35 The three wind directions in the program represent the eight actual wind directions

3.4.3 Categorization of the models simulation design

There were two categories of the model simulations. First, the base case as well as all the proposed designs was simulated while all the apertures of the house were open (day-time). Second, the base case and all proposed designs were simulated while all the apertures of the house were closed (night-time). The processes of the model simulations were carried out as follow:

3.4.3.1 First category

First category focused on all the models simulation conducted when all the apertures of the house were open. When all the apertures of the houses were open, it was considered as the day-time. As Fig. 37 shows that during the day-time 56.66 % of the houses were completely open. First, the base case and all the proposed designs were simulated with a wind speed 4m/s while all the apertures of the house were open. Then, a comparison between the results of the base case and the proposed designs were done in order to find out the best proposed design. Next, the base case and the best proposed design were simulated with wind speed 2m/s. The 2m/s and 4m/s were used to simulation because the wind speed between 2m/s and 4m/s were always occur in Phnom Penh, Cambodia according to the record of Phnom Penh International Airport (Pochentong International) weather station From 2003-2012.

3.4.3.2 Second category

Second category focus on all the models simulation conducted when all the apertures of the house were closed. When all the openings of the house were closed, it was considered as the night-time. As Fig. 37 shows that during the night-time 60 % of the houses were completely closed. First, the base case, the best proposed design, and two extra designs are simulated with wind speed 4m/s. The wind speed 4m/s was used for simulation before the wind speed 2m/s because we want to know about the possibility of the study as we simulate the highest wind speed in this research study. If all the proposed designs were simulated with the wind speed 4m/s and there was no any significant effect to the base case; therefore, the proposed designs need to be edited in order to revive the research study. It is useless to simulate a lot of wind speeds to test the proposed designs. Then, a comparison of the results was done in order to find out the most effective design. Finally, the base case and the most effective design were simulated with wind speed 2m/s in order to find out the lowest possibility of the proposed designs.

3.4.4 Design Process

3.4.4.1 Design Strategies

There were five main strategies used in this research study in order to enhance air movement in the two-story row-house as well as to increase the perceived of thermal comfort of the building occupants.

First, an X-type wind-catcher was installed on the top of the stair box; namely stair case wind-catcher. Second, an X-type wind-catcher was installed on the flat roof

as it stands as a tower above the middle of a family room. Third, an X-type wind-catcher was set up on the side area of the flat roof above the family room (above sitting area). Next, a twin wind-catcher I was installed opposite in orientation to each other on the flat roof above the family room. Last but not least, a twin wind-catcher II was set up opposite in orientation and face to each other on the flat roof above the family room.

The stair case wind-catcher was used as the first strategy because on the top of the stair case is a free space in use; doing so we can save a space. The X-type wind-catcher I was used as the second strategy because it was expected that it might provide a better airflow in the family room as it was set up directly above the family room. The X-type wind-catcher II was carried out as third strategy because it was expected that it might provide more airflow rate directly to the sitting area and it does not decrease the average airflow in the room. The twin K-type wind-catcher I was used as the fourth strategy because it was expected that it can provide a better airflow than the first, the second, and the third strategies as it capable to provides a better long-circuiting than the others. The twin K-type wind-catcher II was used as the final strategy because it was expected that it might produce lower pressure in a space between each other to attract airflow.

3.4.4.2 Sizing of Designs

The sizes of the wind-catchers were limited because of the narrow size of the house. Therefore, we disenabled to enlarge the wind-catchers in a purpose of capturing more outside fresh air because we need to save some spaces for using.

To size the stair case wind-catcher, it depends on the size of existing stair case. It was sized 1.6 m width, 1.6 length, and 2.6 m height. The X-type wind-catcher I and II were sized 1.6 m width, 1.6 m length, and 4.1m height. Moreover, the twin K-type wind-catcher I and II were sized 1m width, 1.6 m length, and 4.1 m height. Additionally, at the end of the designs while all apertures of the house were closed two extra designs were carried out in order to enhance airflow in the house. First, One aperture was designed as positioned at the façade of the ground floor of the house. Second, another one aperture was designed as positioned at the rear wall of the ground floor of the house. Both are the same size (0.6 m width and 3.4 m length).

In this research study, 2m/s and 4m/s wind speed were input to simulate. According to Phnom Penh International Airport (Pochentong International) weather station showed that 3m/s is an average wind speed in Cambodia, that's why the number of wind speed a bit lower average (2m/s) and the number of wind speed a bit higher average (4m/s) were chosen as min and max of the wind speeds to

simulate, doing so we can assume the result of average wind speed (3m/s) as it is between 2m/s and 4m/s.





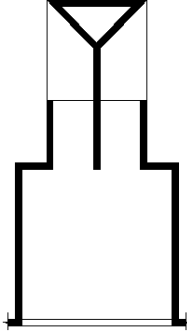
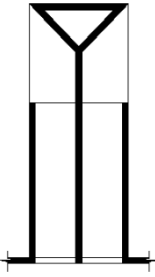
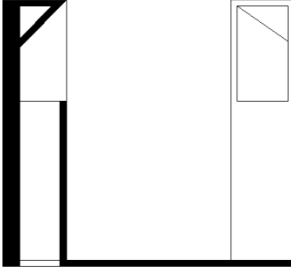
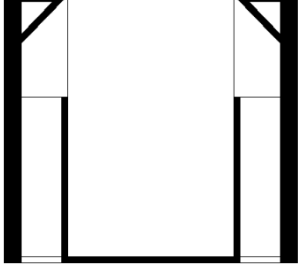
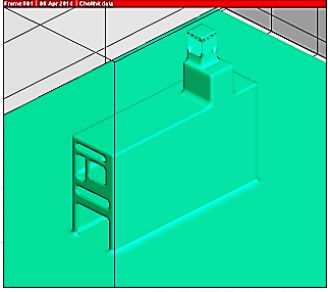
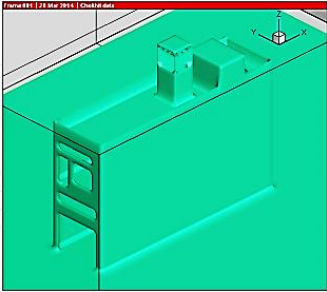
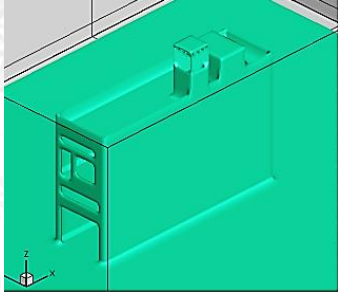
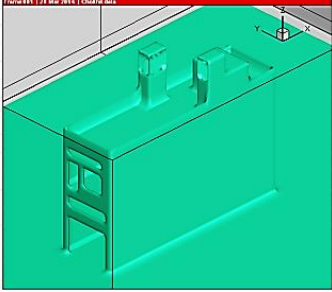
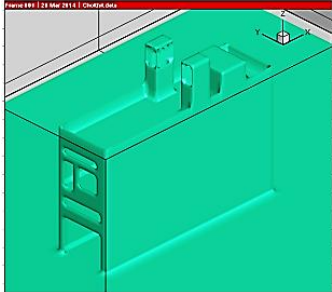
<u>Stair case wind-catcher</u>	<u>X-type wind-catcher I and II</u>	<u>Twin K-type wind-catcher I</u>	<u>Twin K-type wind-catcher II</u>
 <p>Plan</p>	 <p>Plan</p>	 <p>Plan</p>	 <p>Plan</p>
 <p>Section</p>	 <p>Section</p>	 <p>Section</p>	 <p>Section</p>
 <p>Position of stair case wind-catcher</p>	 <p>X-type wind-catcher I</p>	 <p>X-type wind-catcher II</p>	
 <p>Twin K-type wind-catcher I</p>	 <p>Twin K-type wind-catcher II</p>		

Figure 36 The various forms of proposed designs (all apertures of the house are completely open)

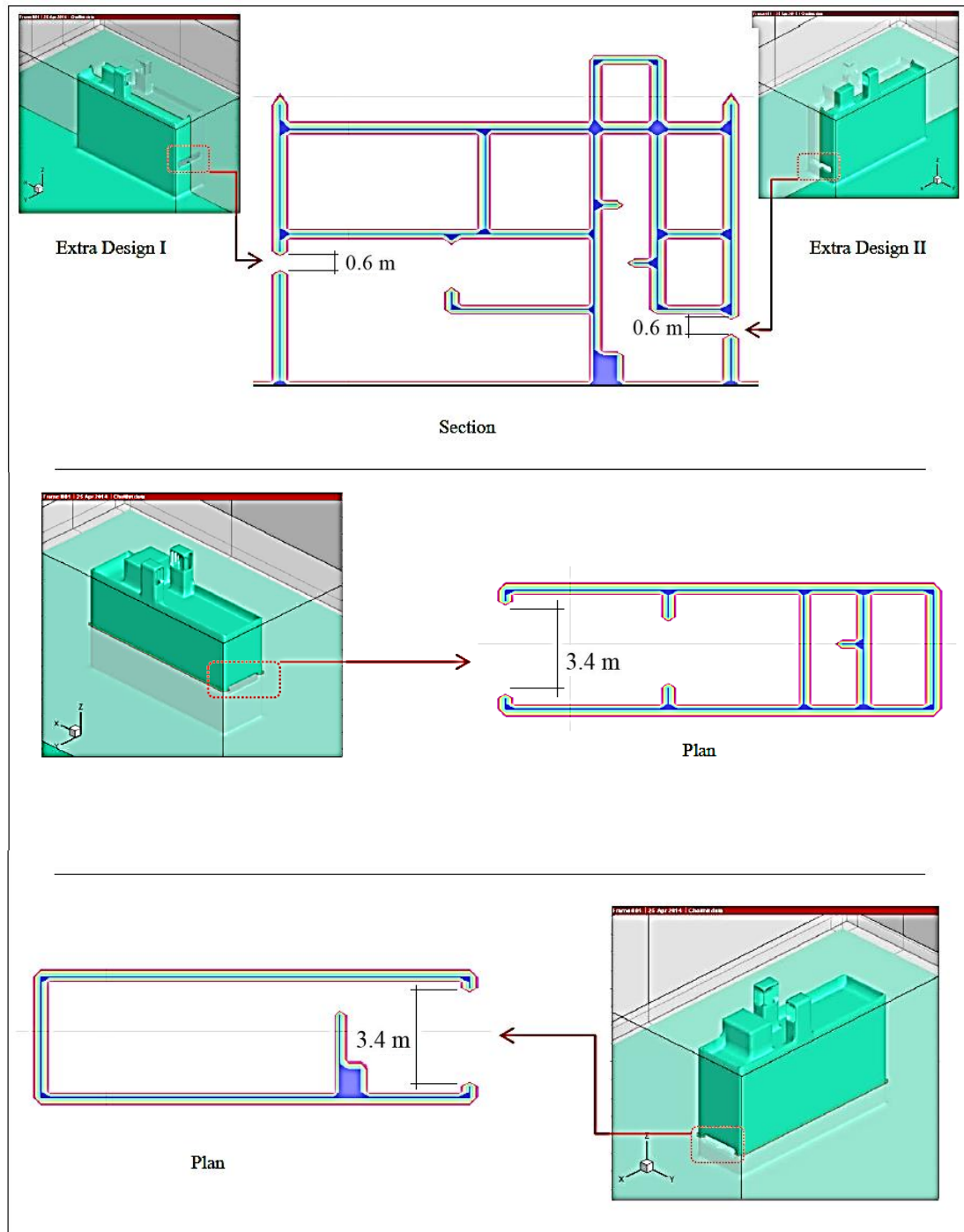


Figure 37 The sizes and the positions of extra design I and II (all apertures of the house are completely closed)

Chapter IV

Results and Discussion

This chapter is divided into two main parts. First part is the results of site survey and models simulation. Second part is the discussion of the results of the study.

4.1 Results

The results are divided into two parts. One is the results from site survey conducted as interviews and actual measurements. And another one is the results from models simulation by using computation fluid dynamic (Heat X) program.

4.1.1 Results from site survey

4.1.1.1 Interview

The results from the interviews are classified into two parts. One is the result of percentage of the houses' apertures opening and another one is the result of perceiving thermal comfort of the row-houses occupants.

4.1.1.1.1 Percentage of houses' apertures opening

According to the interviews there are three categories of houses' apertures usage, completed close, completed open, and semi-open. Completed close means all doors and windows were closed completely, completed open means all doors and windows were open completely, and semi-open means some apertures were opened and some were closed such as the doors were closed and the windows were opened or the doors were opened and the windows were closed or some doors were opened and some were closed and some windows were opened and some were closed. For semi-open case, we cannot be sure about the percentage of openings and closings because unfortunately we were not allowed to go inside the house to see the house to see the houses' apertures.

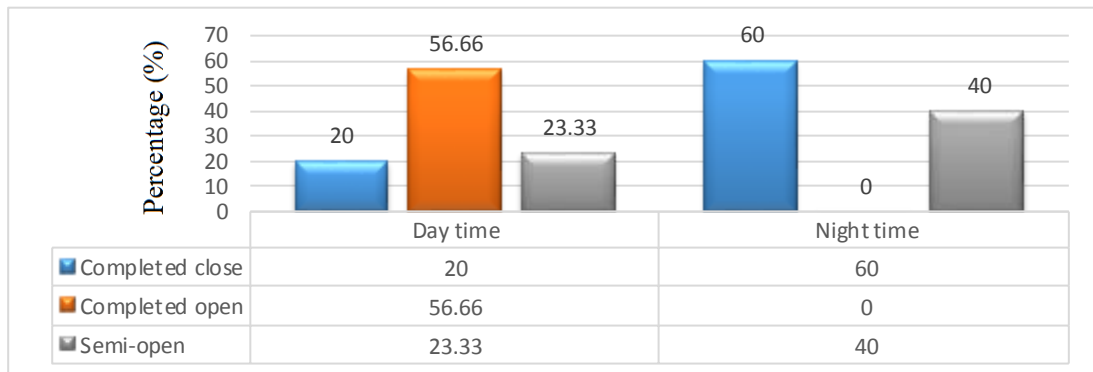


Figure 38 This graph shows the percentage of houses' apertures usage.

As the results from Fig. 38 shows that during day time the majority of houses' apertures were opened completely. However, the majority of houses' apertures were closed completely during night time. These results led to a decision of the model simulation category.

4.1.1.1.2 Occupants' feeling of comfort of living in row houses

In this case, the row houses' occupants were interviewed about their perception related to thermal, stuffiness, and wind blowing inside the houses. According to the interviews, the results showed as follows:

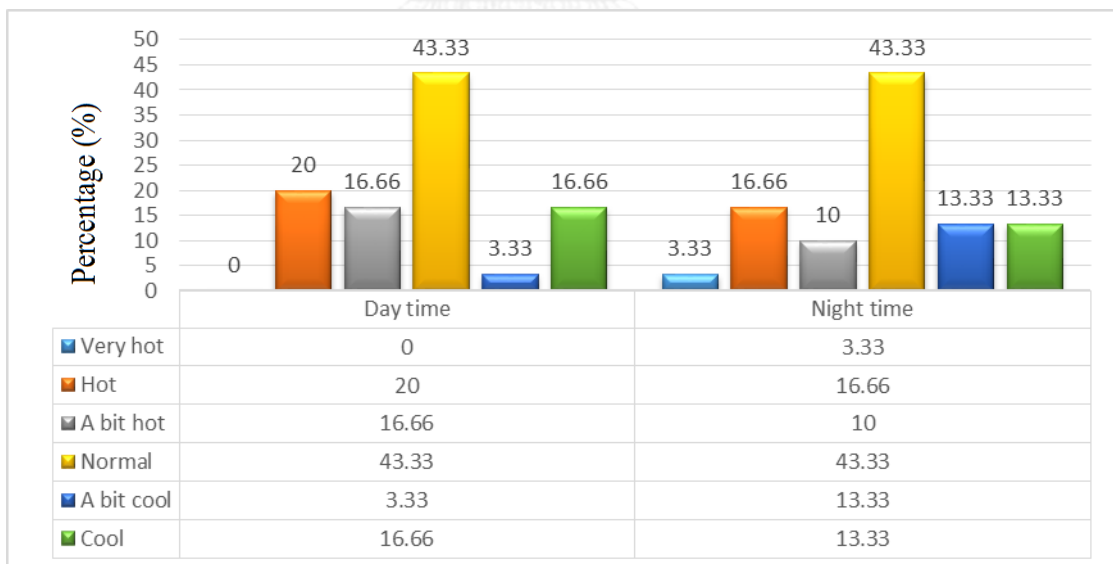


Figure 39 The feeling of row houses' occupants related to thermal comfort in the houses.

As the results from Fig. 39 shows that during day time 26.66% of row-houses occupants perceived hot, 43.33% felt normal, and 19.99% perceived cool. However, during night time, 29.99% of row-houses occupants perceived hot, 43.33% felt normal, and 26.66% perceived cool.

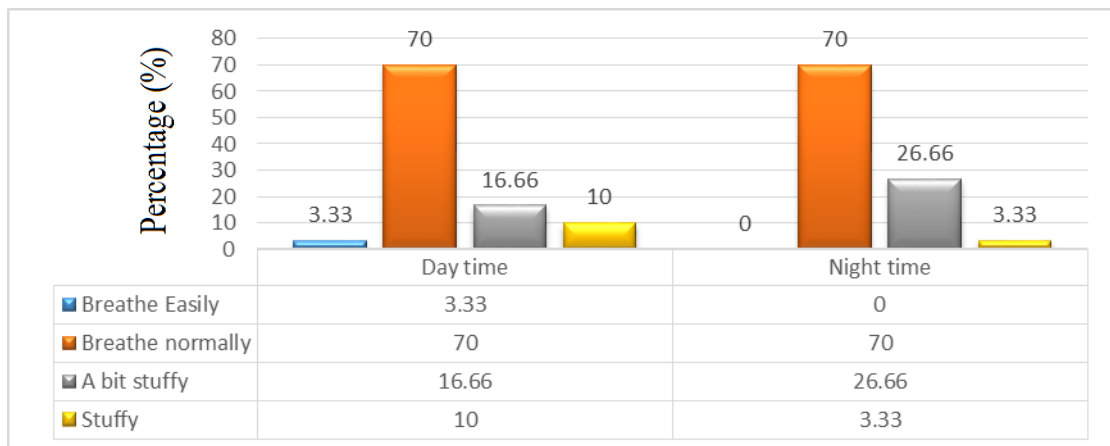


Figure 40 The feeling of stuffiness of row houses' occupants.

As the results from Fig. 40 shows that during day time 3.33% of row-house occupant breathed easily, 70% breathed normally, and 26.66% felt stuffy. However, during night time, 70% of row-house occupant breathed normally, 29.99% felt stuffy.

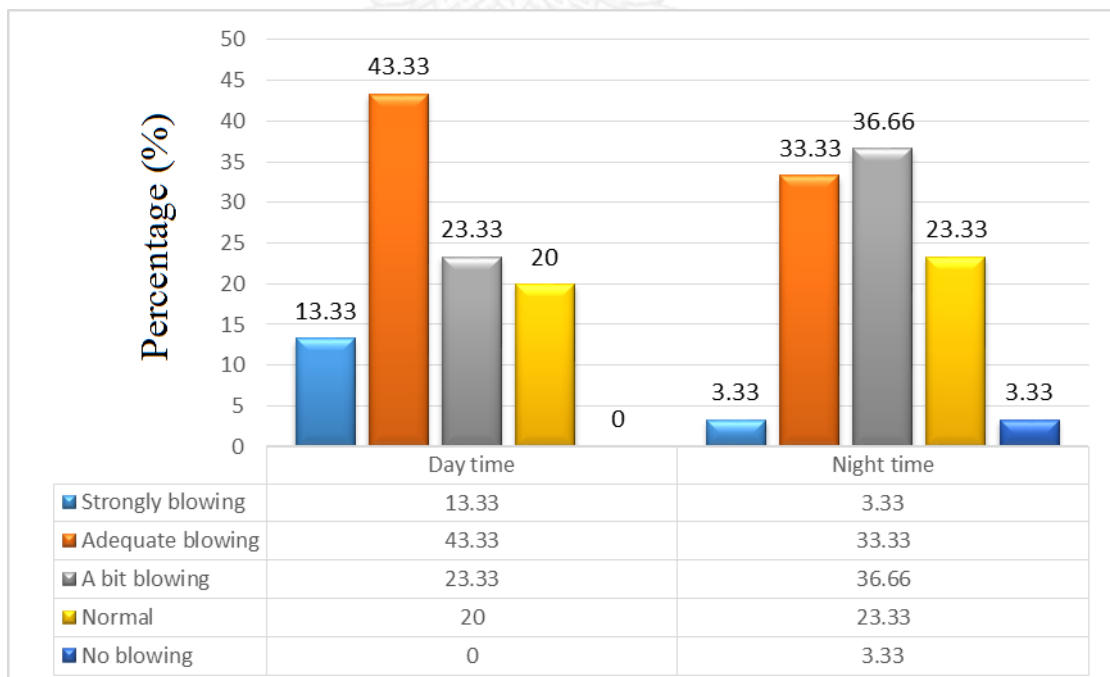


Figure 41 The feeling of row houses' occupants related to wind blowing inside the houses

As the results from Fig. 41 shows that during day time 13.33% of row-house occupants perceived the wind blows strongly inside the house, 43.33% perceived adequate wind blowing, 23.33% perceived light wind blowing, 20% was unperceivable to any wind blowing. However, during day time, 3.33% of row-house occupants perceived the wind blows strongly, 33.33% perceived adequate wind blowing, 36.66% perceived light wind blowing, 23.33% was unperceivable to wind blowing, and 3.33% perceived calm wind.

Conclusion:

According to the results from interviews above showed that the main problems of thermal comfort, stuffiness, and lacking air movement in row houses occurred more often at night time than day time as 36.66% felt hot, 26.66% feeling stuffy, and 43.33% felt airless at day time; 39.99% felt hot, 29.99% feeling stuffy, and 63.33% felt airless at night time. During day time, the apertures of the houses were open completely or semi-open so the air can flow into the houses and spread it flow to some parts of the houses. Therefore, the problems were not too serious during the day time. However, during night time, the apertures of the houses were completely closed or semi-open. Therefore, the air cannot flow into the house which caused the serious problems of indoor air movement.

4.1.1.2 Actual Measurement Result

The results of actual measurement are divided into three parts. First, the results of wind velocity, temperature, and humidity in the living room. Second, the results of wind velocity, temperature, humidity in the kitchen. Third, the results of wind velocity, temperature, humidity in the family room.

4.1.1.2.1 Measurement Result of Living room

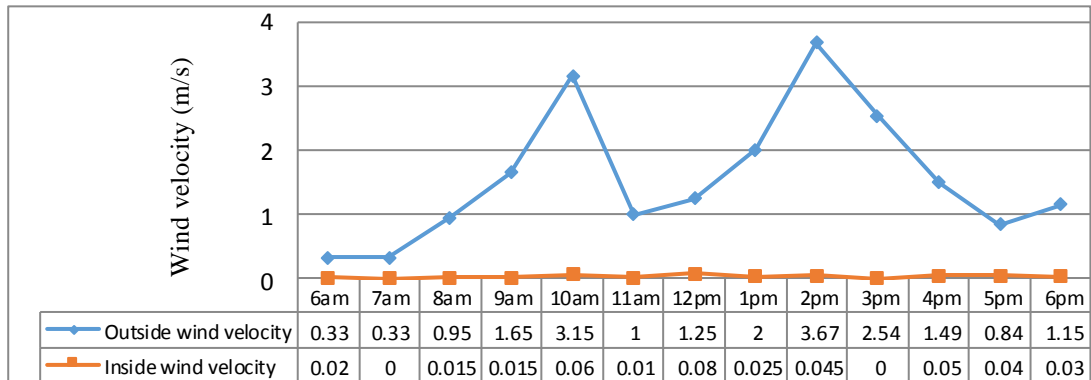


Figure 42 The results of the wind velocity from the actual measurement in the living room of the case study

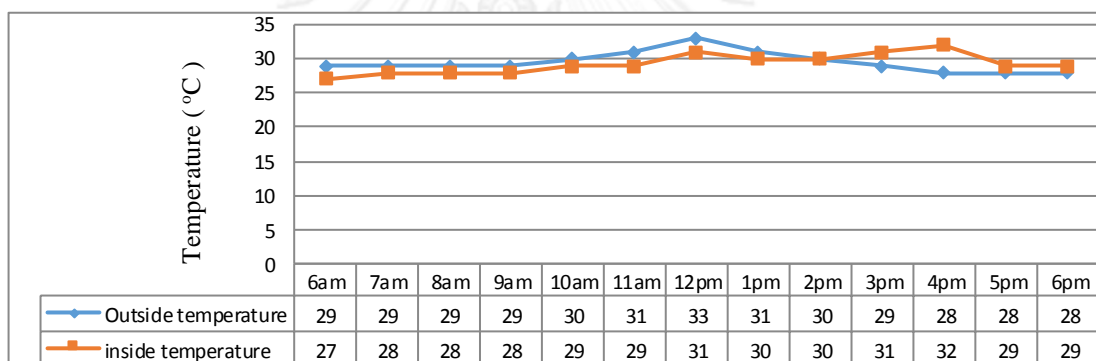


Figure 43 The results of the temperature from the actual measurement in the living room of the case study

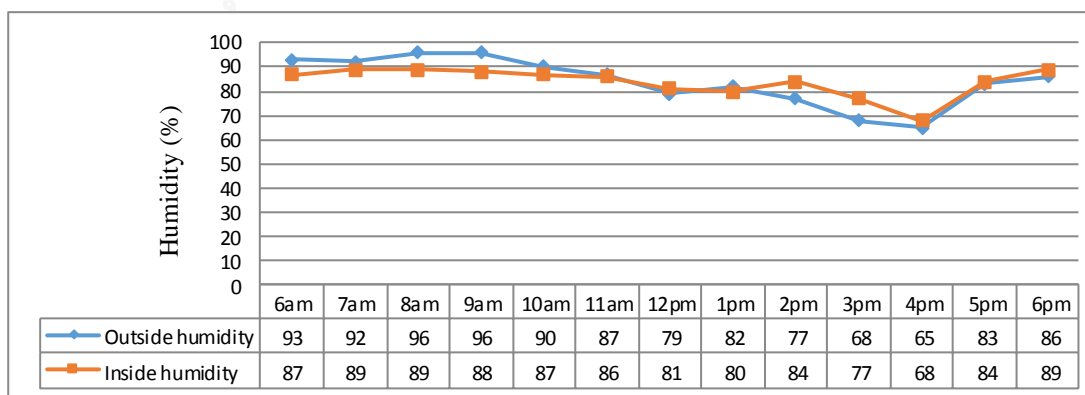


Figure 44 The results of the humidity from the actual measurement in the living room of the case study

4.1.1.2.1 Measurement Results of kitchen

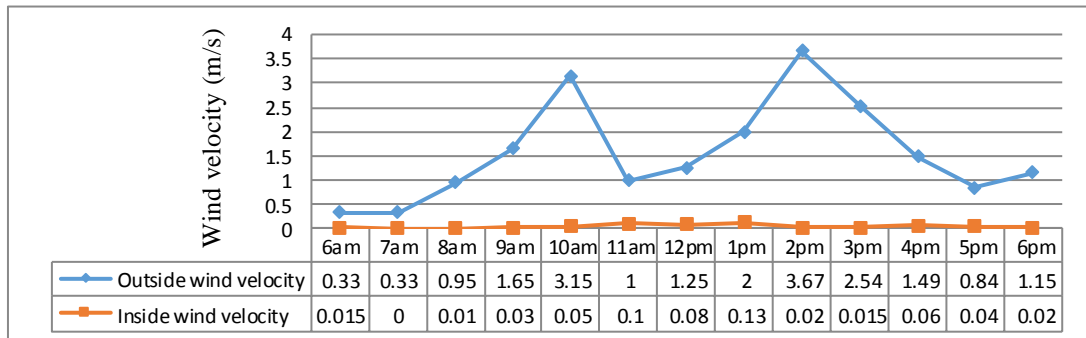


Figure 45 The results of the wind velocity from the actual measurement in the kitchen of the case study

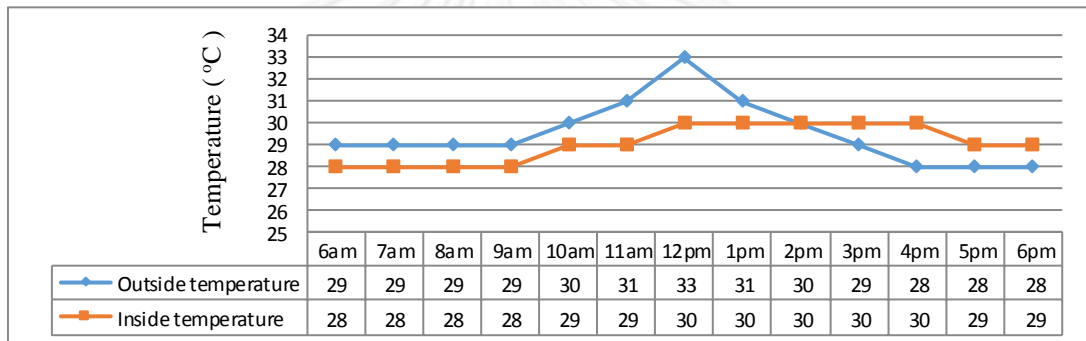


Figure 46 The results of the temperature from the actual measurement in the kitchen of the case study

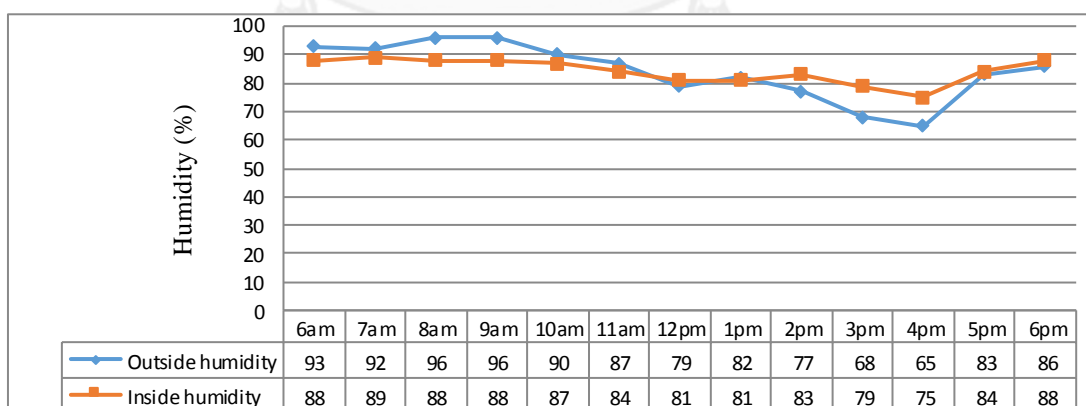


Figure 47 The results of the humidity from the actual measurement in the kitchen of the case study

4.1.1.2.3 Measurement Results of Family room

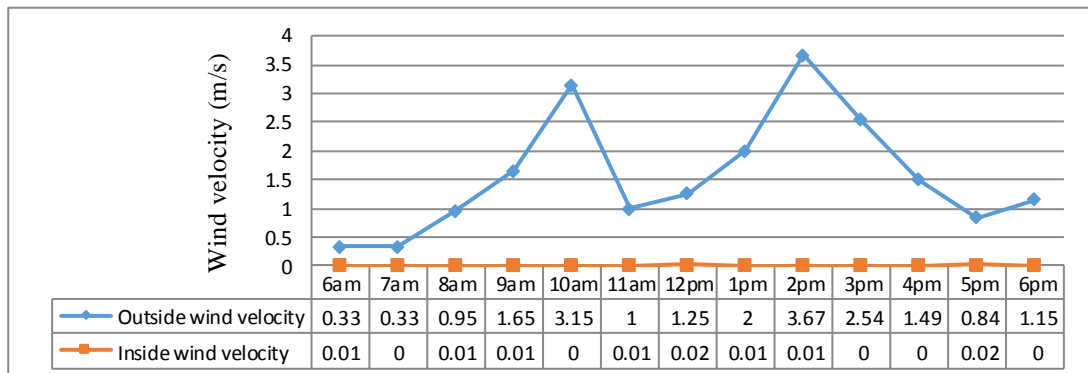


Figure 48 The results of the wind velocity from the actual measurement in the family room of the case study

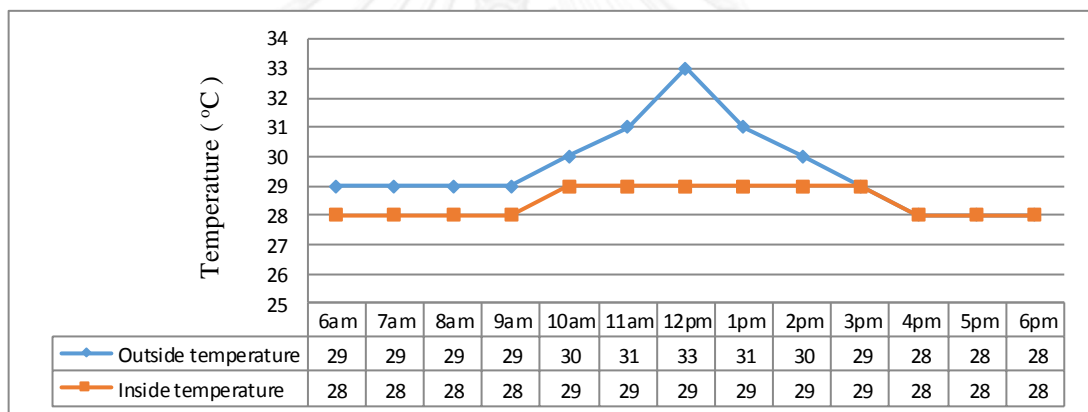


Figure 49 The results of the temperature from the actual measurement in the family room of the case study

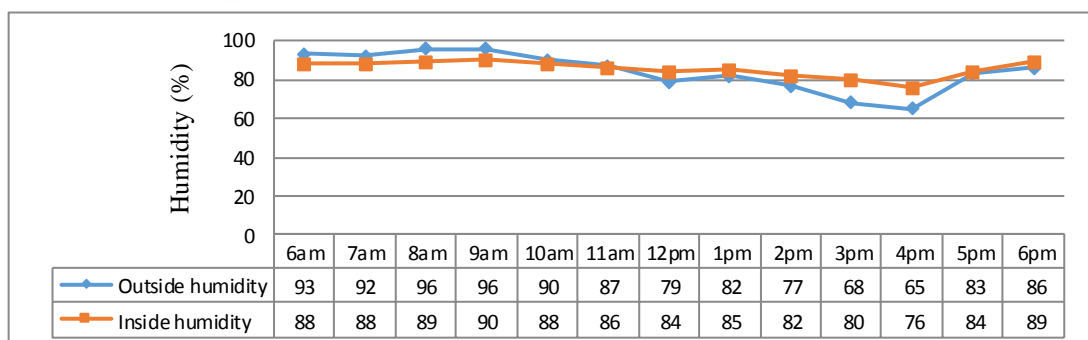


Figure 50 The results of the humidity from the actual measurement in the family room of the case study

According to the measurements, outside temperature and inside temperature are a little bit different, outside and inside humidity are also different a little bit, but outside wind velocity and inside wind velocity are very different. In the morning outside temperature is higher than inside; in contrast, around 2pm to 3pm inside temperature started to get higher than outside because the houses' materials absorbed heat and exhausted heat when the sun started to gradually set. Furthermore, outside humidity is higher than inside in the morning, but it started to be lower than the inside at around 11am to 12pm because the heat from the sunlight dried the air outside. Moreover, according to the result of wind velocity measurements showed that the fluctuation of outside wind speed slightly affected the inside wind speed because the windward was blown perpendicular to the side-walls of the houses which did not have any air apertures.

4.1.2 Results from Models simulation

This section showed about the results from models simulation before and after applying proposed designs to improve indoor air movement in common spaces (family room, living room, and kitchen) of a two-story row-house by using CFD program (Heat X). In these simulations, a top front roof of the house was removed because doing so can reduce heavy running of the program. The results were categorized into two main categories, first category and second category, as the categorization of the models simulation design illustrated in chapter III. All results of plot plans below were sectioned 1.1m above the floor level as this level was considered the working level.

4.1.2.1 First category

4.1.2.1.1 Vector plots results

Vector plots showed the results of airflow patterns as well as directions of air movement.

a. Base case

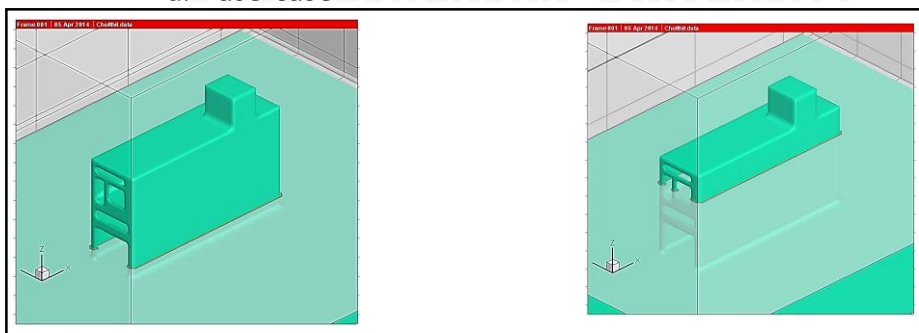


Figure 51 A plot plan section level of a ground floor at the left side and a plot plan section level of a first floor at the right side (1.1 m above floor level)

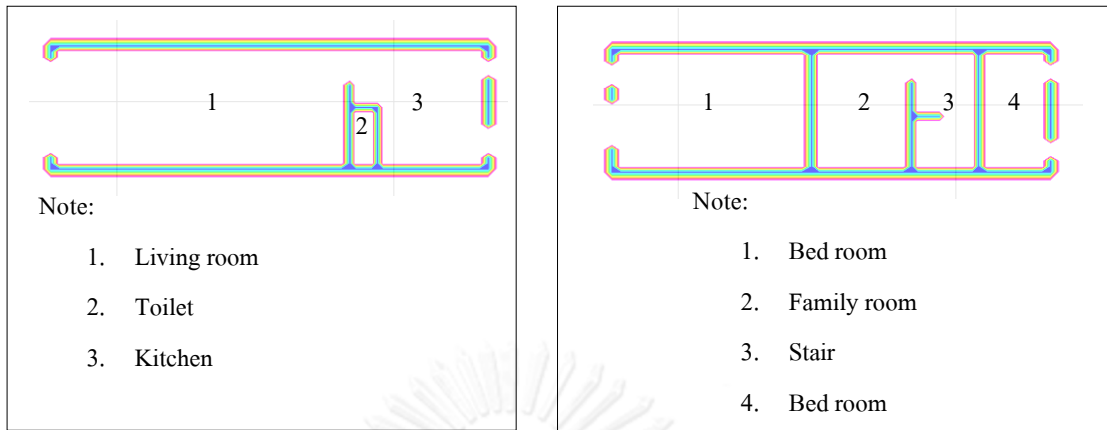


Figure 52 A plot plan section level of a ground floor (left) and a first floor (right) as porosity

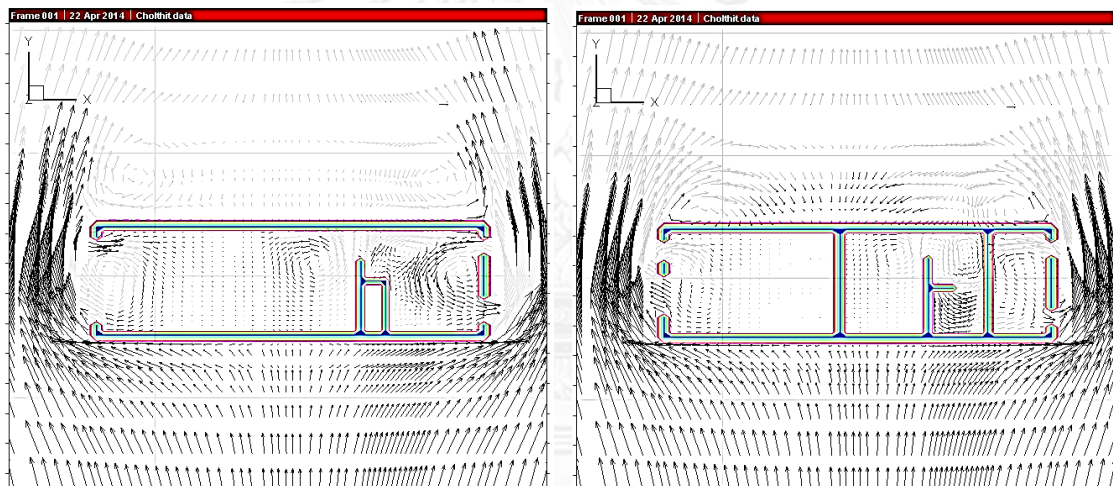


Figure 53 A vector plot results of a ground floor (left) and a first floor (right)

As the results in Fig. 53 showed that a front door of ground floor was an important aperture which allowed the wind flowed into the living room from one side of the aperture and allowed wind flowed out through another side of the aperture. Moreover, a rear door of the house functioned as a device to capture air into the kitchen and a rear window functioned as a device to extract stale air out. The oppositional directions of airflow from the façade of the house and the rear of the house caused the turbulence in the middle of the ground floor of the house. On the other hand, as the result of the first floor showed that two openings of a front bed room of the house functioned as the devices to capture and to extract stale as out. Furthermore, two apertures of a rear bed room of the house also functioned as the devices to catch air into the room and to allow stale air flows out. However, it

also demonstrated that the air flowed upward from the ground floor and channeled to a family room, but it seemed lightly affect because the family room did not have another aperture to allow the air flowed out.

b. Stair case wind-catcher

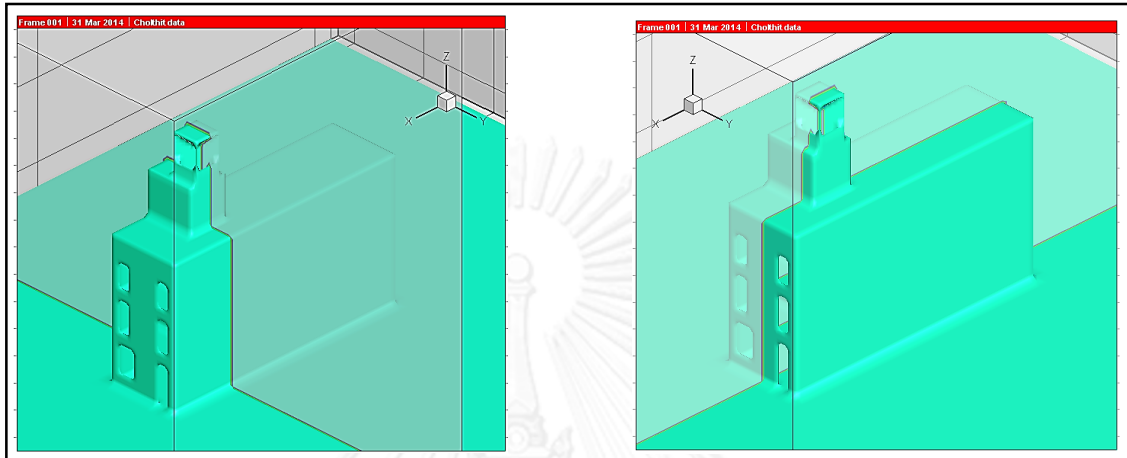


Figure 54 A section position I (left) and II (right) of the stair case wind-catcher

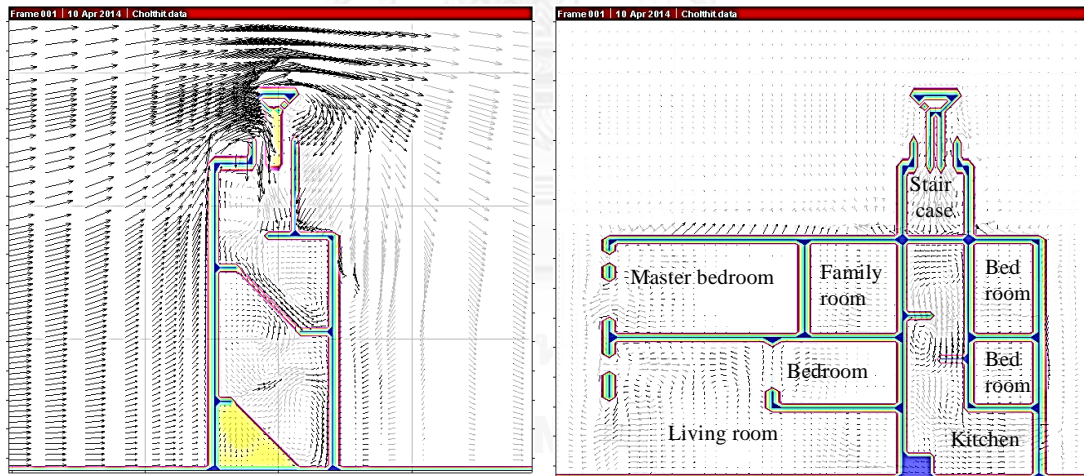


Figure 55 A vector plots of a section I (left) and II (right) of the stair case wind-catcher

According to Fig. 55, it was shown that the outside wind channeled down to the building from an opening (inlet) of the wind-catcher, but it seemed less effective to the ground floor because the stair was a barrier of the wind flowing down that made a turbulence occur in the middle of the stair space. Moreover, a distance between the wind-catcher and the ground floor was too far to get the significant effect from the wind-catcher. So, the airflow on the ground floor could not be improved. However, the power of the wind-catcher slightly affected the family room as it was positioned not too far. Additionally, the wind channeled down from the wind-catcher crashed against the wind coming from other apertures of the ground floor, making the wind turbulence occur in the middle of the stair space. This condition caused the problem of airflow.

c. X-type wind-catcher I

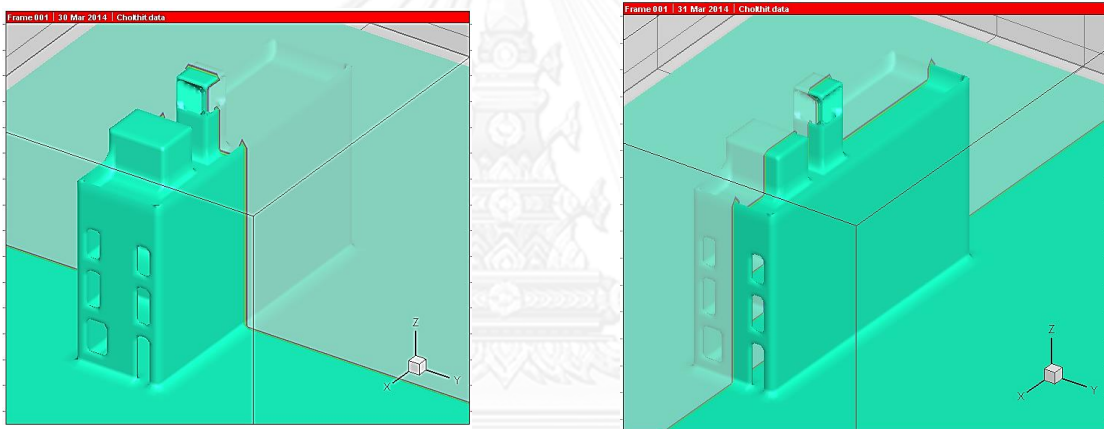


Figure 56 A section position I (left) and II (right) of the X-type wind-catcher I

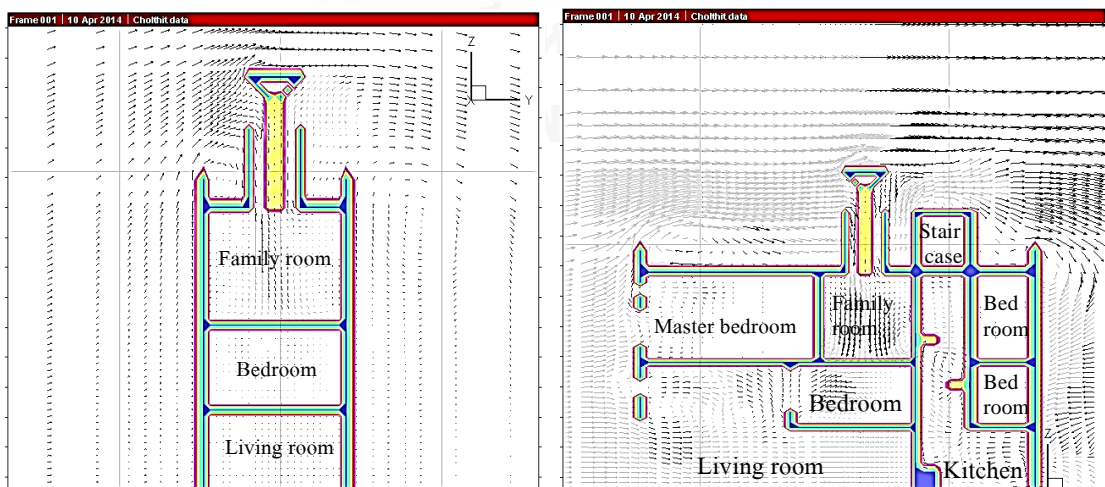


Figure 57 A vector plots of a section I (left) and II (right) of the X-type wind-catcher I

According to the Fig. 57 showed that the outside wind came from an opening of the wind-catcher (inlet) and the stall air flowed out from the other openings (outlets) of the wind-catcher. The effect of the wind-catcher was significant displayed in the family room, but it did not show any significant effect to the ground floor. The wind channeled down to the middle of the family room and spread its flow to the lower pressure zones.

d. X-type wind-catcher II

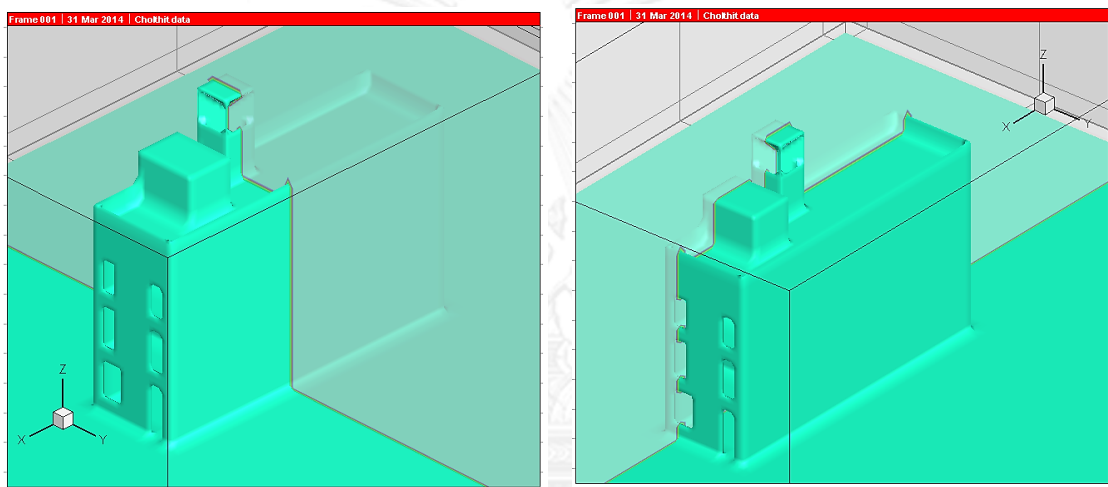


Figure 58 A section position I (left) and II (right) of the X-type wind-catcher II

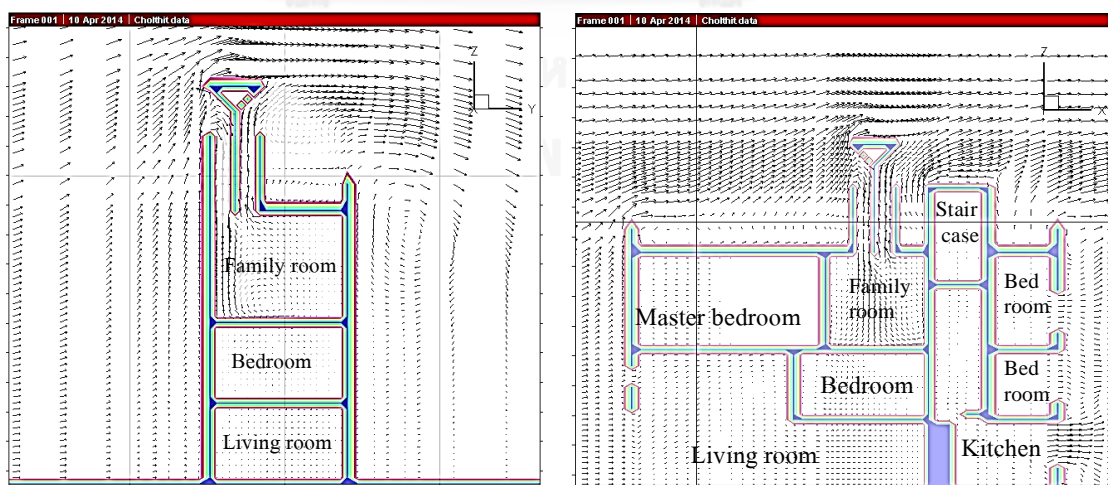


Figure 59 A vector plots of a section I (left) and II (right) of the X-type wind-catcher I

According to the Fig. 59 showed that the outside wind came from an inlet of the wind-catcher and channeled downward to a sitting area of the family room and spread its flow to another side of the room. However, it seemed to be insufficient to the ground floor.

e. Twin K-type wind-catcher I

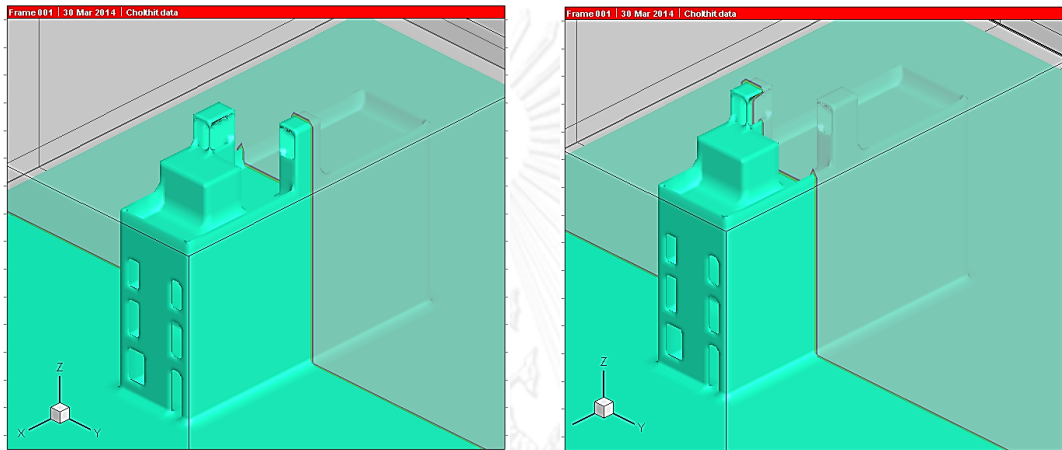


Figure 60 A section position I (left) and II (right) of the twin K-type wind-catcher I

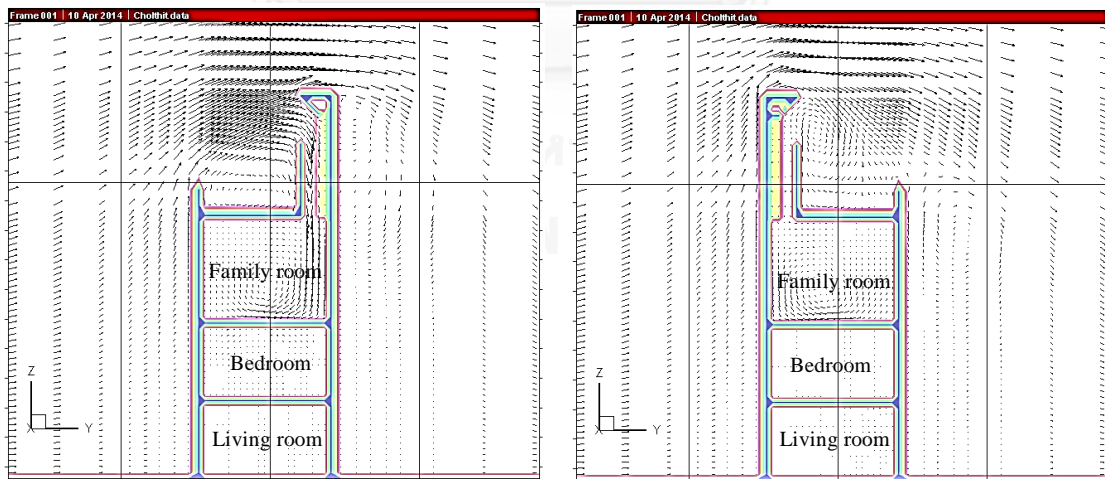


Figure 61 A vector plots of a section I (left) and II (right) of the twin K-type wind-catcher I

According to the Fig. 61 showed that the outside fresh air came from an aperture (inlet) of the wind-catcher and channeled down to the house and the stall air in the room flowed upward and tried to escape through the outlets. In this case, typically one wind-catcher functioned as a device to capture the outside fresh air into the building and another wind-catcher functioned as a stack ventilation to extract stall air out. Although this system could run for the family room, it could not run for the living and the kitchen as they were too far to get the effect.

f. Twin K-type wind-catcher II

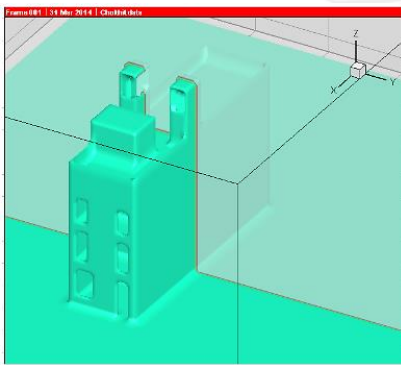


Figure 62 A section position of the twin K-type wind-catcher II

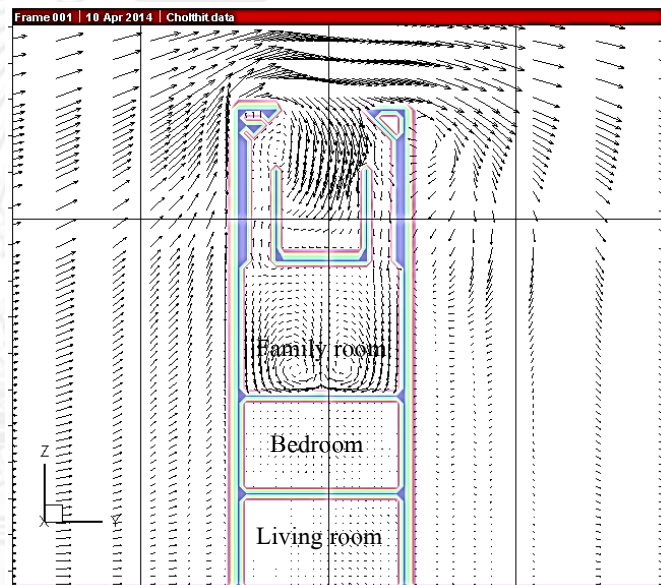


Figure 63 A vector plot of a section of the twin K-type wind-catcher II

According to the Fig. 63 showed that one wind-catcher functioned as a natural ventilation device to capture fresh air into the building and another one functioned as the stack ventilation to extract stall air out. A space between these two wind-catchers created the lower pressure as one of both wind-catchers performed as a barrier alternatively when the wind flowed from the south or the north.

As all the results above demonstrated that all types of wind-catcher did not provide any effects to the living room and the kitchen during the day time when all the apertures of the house were open. However, those wind-catchers could improve air movement in the family room significantly.

4.1.2.1.2 Contour Plots

Contour plots showed the results of varieties of wind velocity for all study positions in the houses.

a. Results of the base case simulation

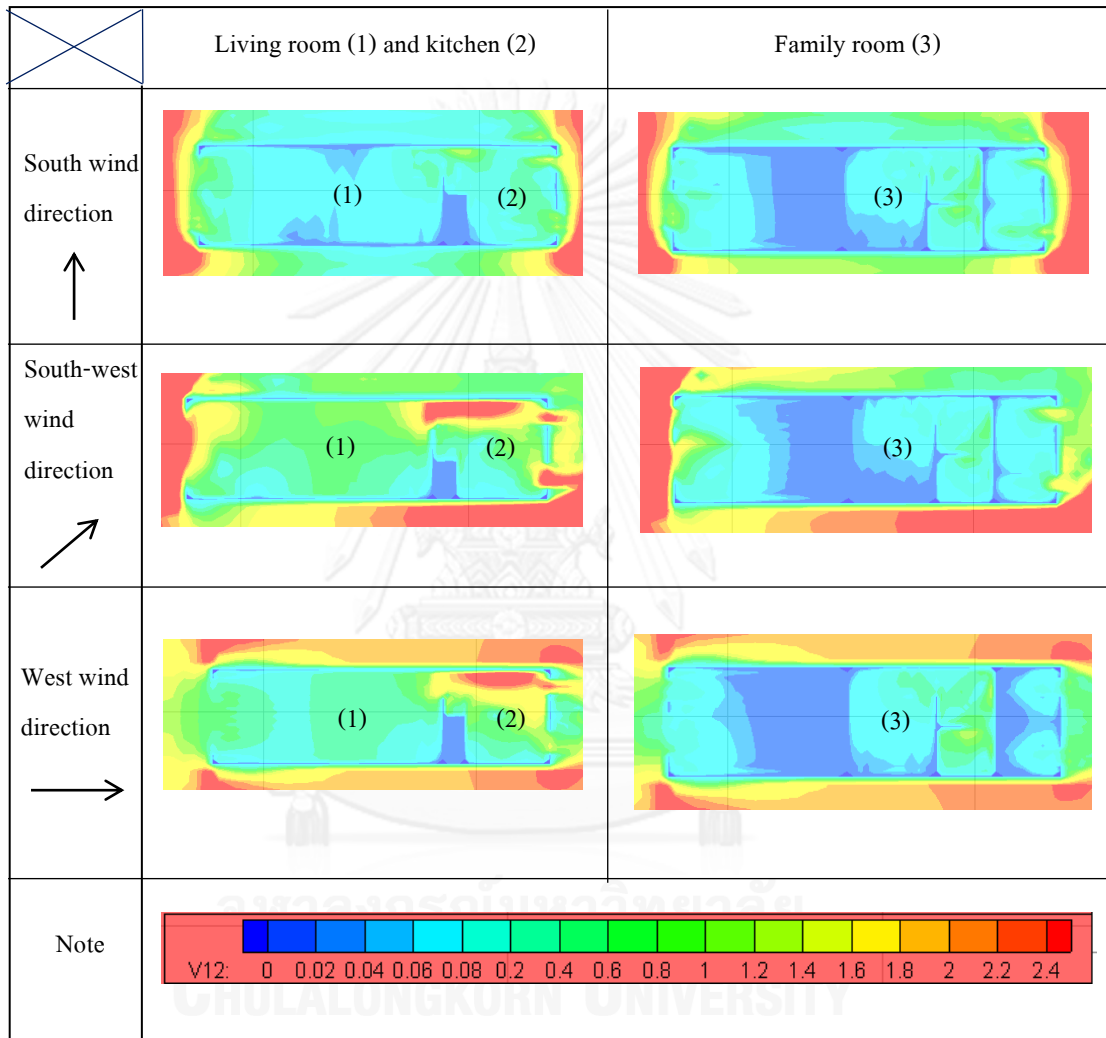


Figure 64 The results as contour plots of the family room, the kitchen, and the family room with a wind speed 2m/s

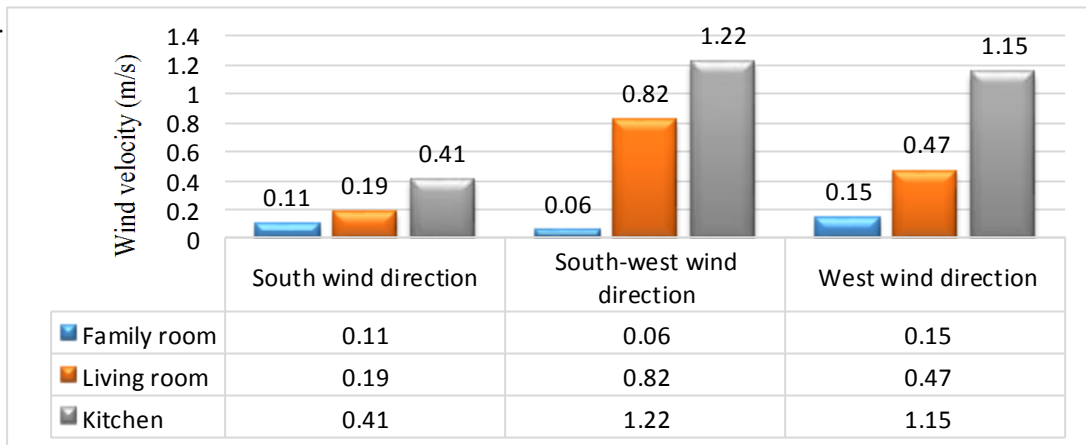


Figure 65 The results of the wind velocity in the living room, the kitchen, and the family room with a wind speed 2m/s

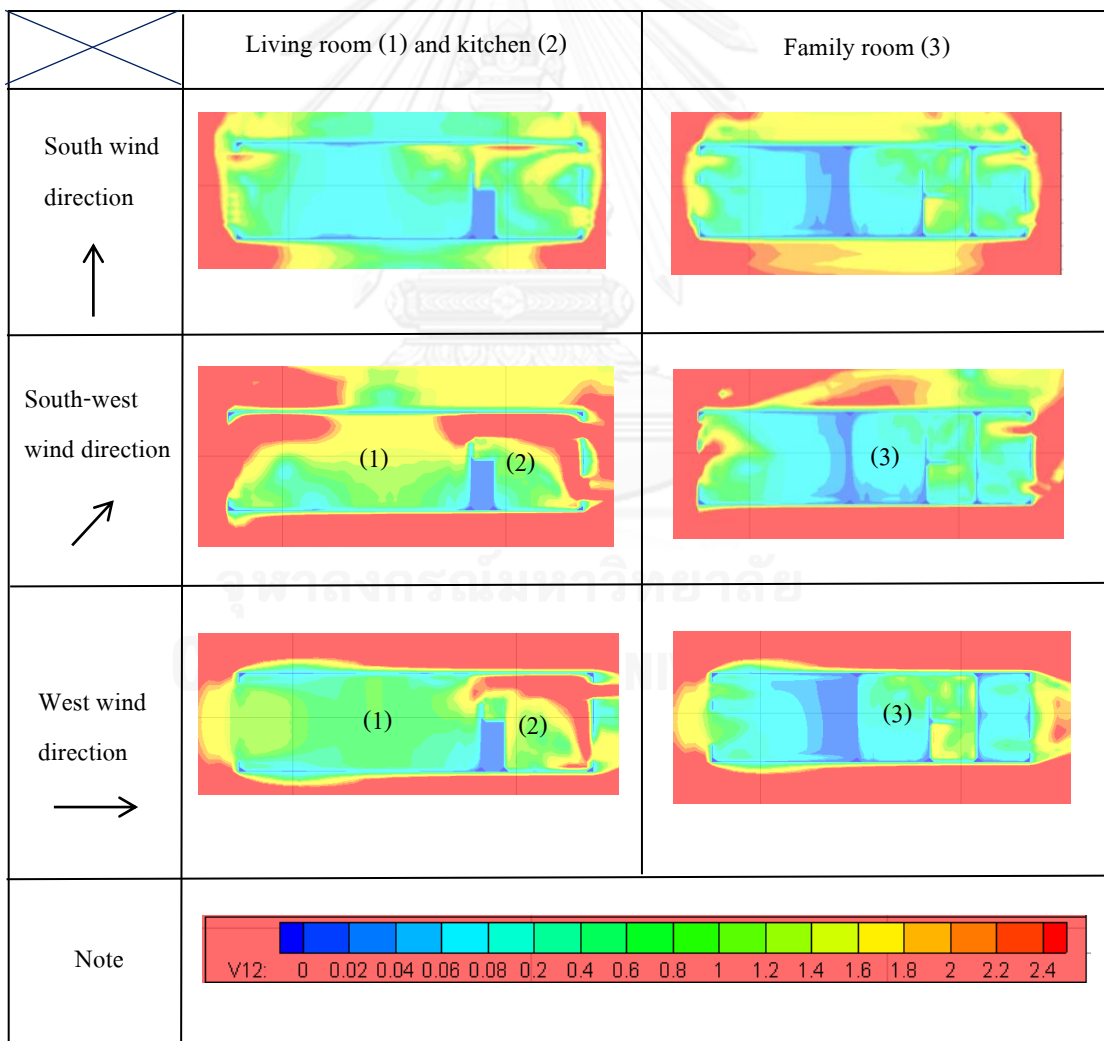


Figure 66 The results as contour plots of the living, the kitchen, and the family room with a wind speed 4m/s

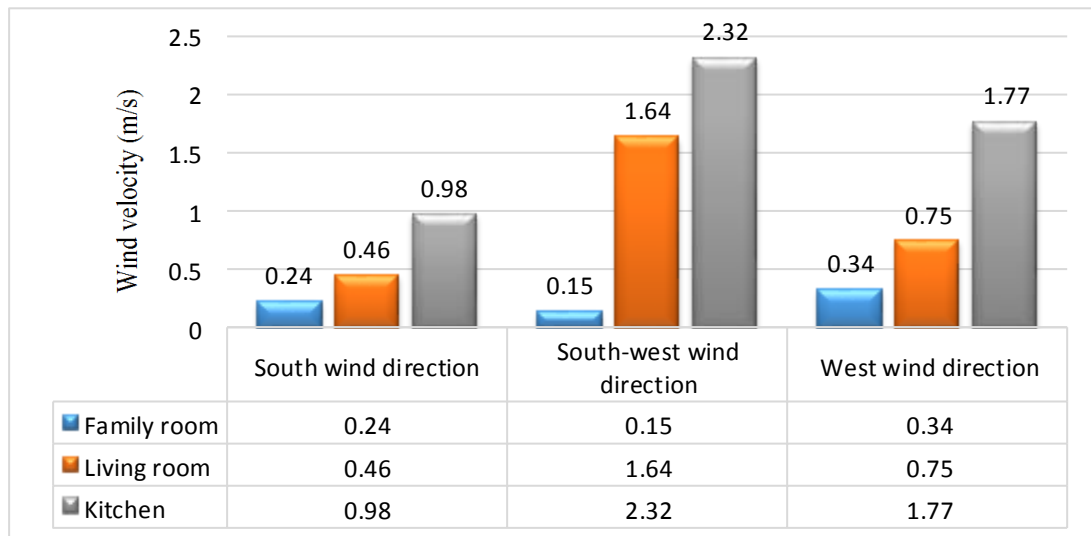


Figure 67 The results of the average wind velocity in the living room, the kitchen, and the family room with a wind speed 4m/s

These results showed that when the outside wind velocity was 4m/s, the average wind speed in the family room was between 0.15 to 0.34 m/s, the average wind speed in the living room was between 0.46 to 1.64 m/s, and the average wind speed in the kitchen was between 0.98 to 2.32 m/s.

According to the results of simulation with the wind speed 2m/s and 4m/s above indicated that the serious of inadequate airflow occurred in the family room more than the two other rooms. As Agung Muri Nugroho et al mentioned that the building occupants required at least 0.6 m/s to 1m/s for thermal comfort condition in the tropical monsoon region (Agung Murti Nugroho 2007)

b. Comparison of the results between the base case and the proposed designs as wind speed 4m/s

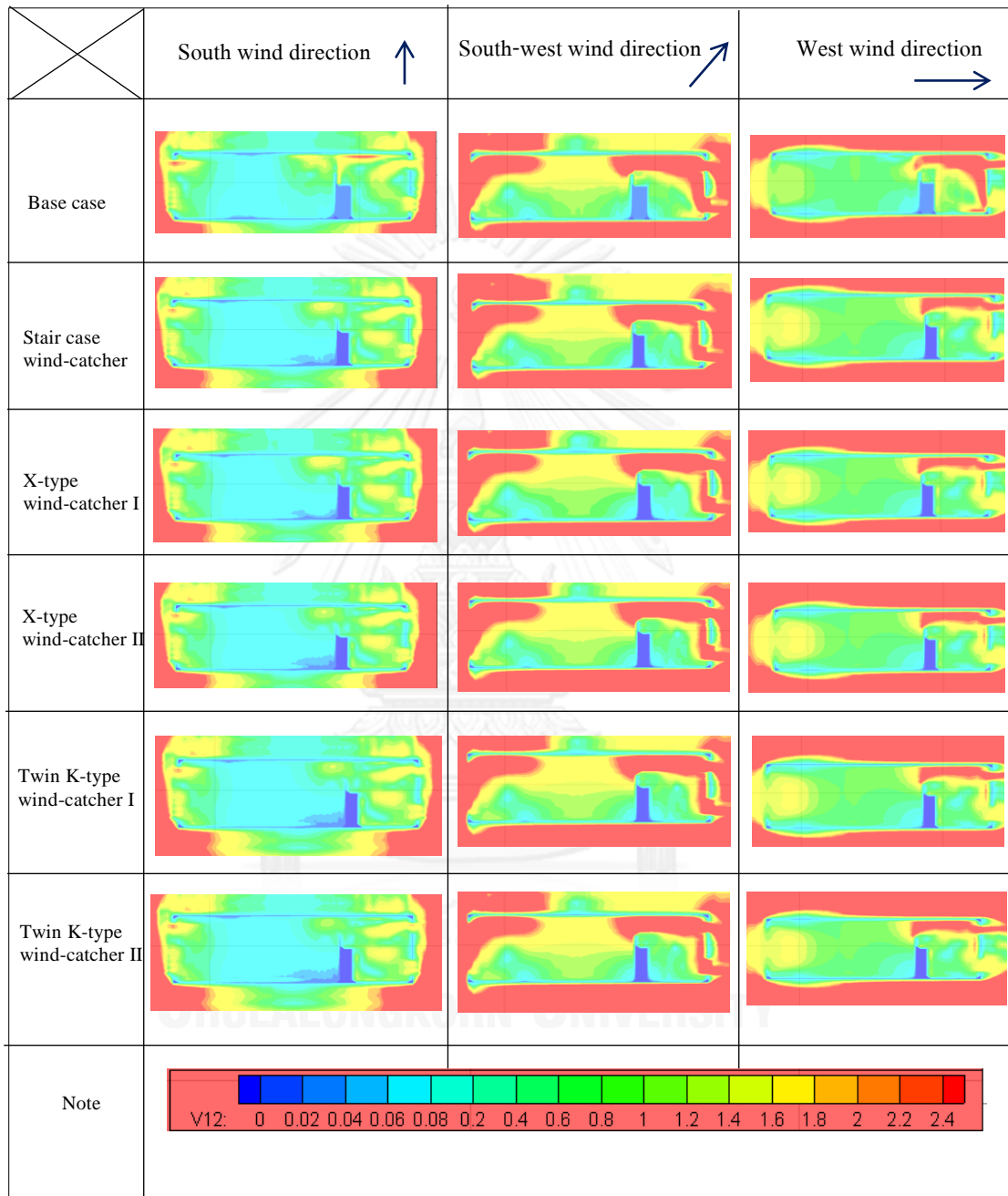


Figure 68 The results as contour plots after applying proposed designs in the living room and the kitchen with a wind speed 4m/s

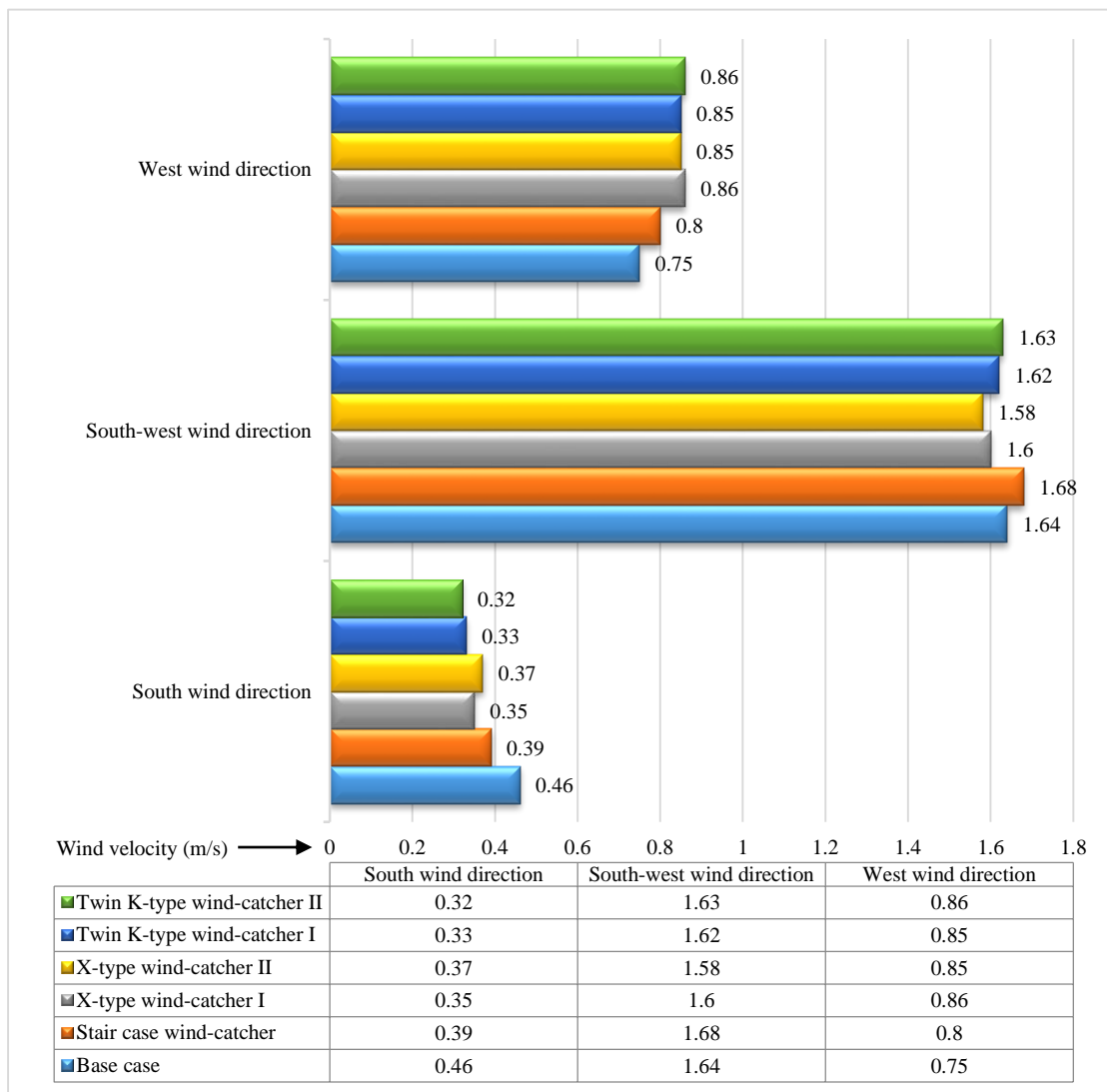


Figure 69 The results of the average wind speed in the living room before and after applying the proposed designs with wind speed 4m/s

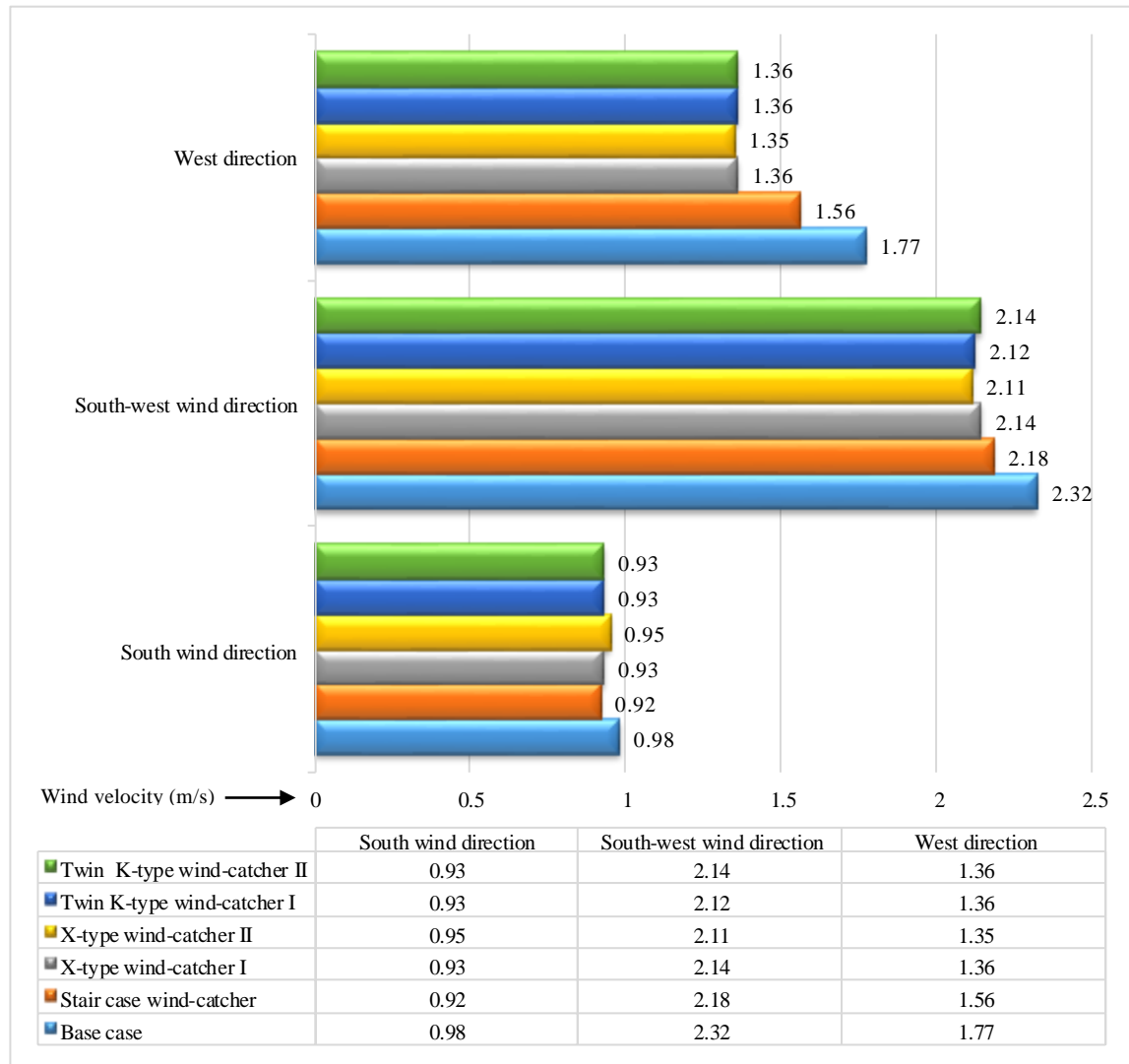


Figure 70 the results of the average wind speed in the kitchen before and after applying the proposed designs with wind speed 4m/s

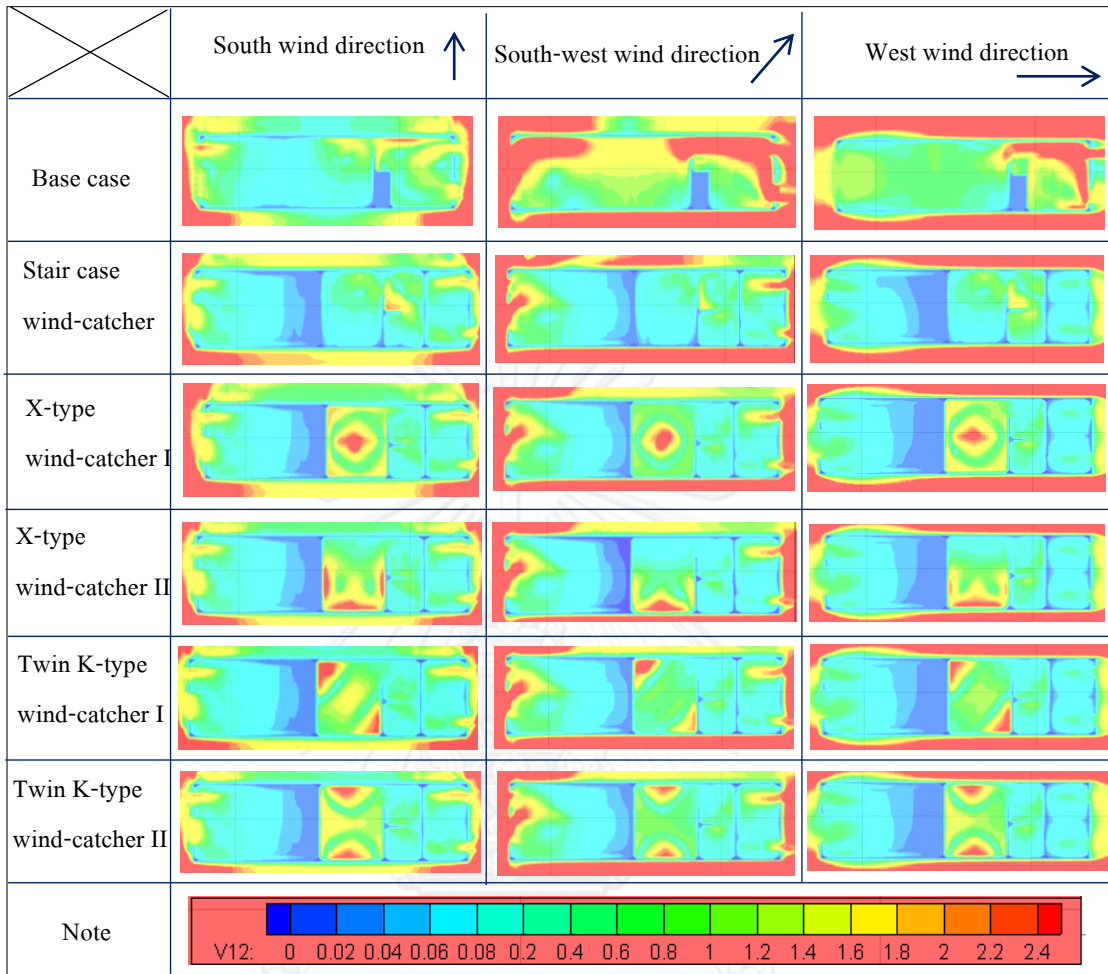


Figure 71 the results as contour plots after applying proposed designs in the family room with a wind speed 4m/s

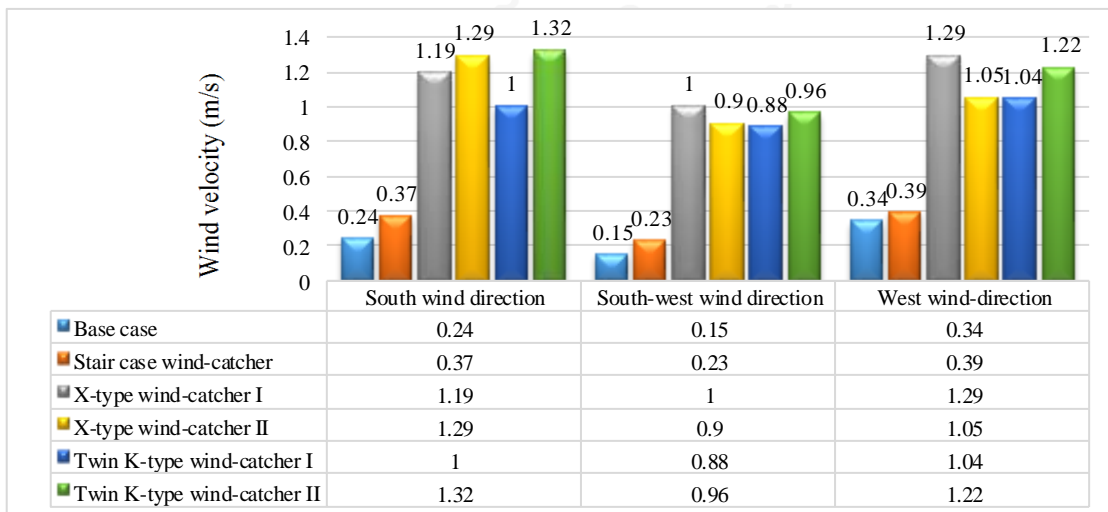


Figure 72 the results of the average wind speed in the family room before and after applying the proposed designs with wind speed 4m/s

The results above showed that there was no any significant effects to the living room and the kitchen although the wind speed 4m/s was input to simulate. However, all the designs provide the significant effects to the family room because they were installed directly above the family room. The airflow in the family room was improved and the average of wind speed increased. Additionally, the twin K-type wind-catcher II provided the highest effect as it could increase average wind speed 0.92 m/s approximately in the family room because it was installed in an appropriate position that could generate long air flow circuiting and could make more negative pressure between wind-catchers that could attract airflow.

c. Comparison between the base case and the K-type wind-catcher II with wind speed 2m/s

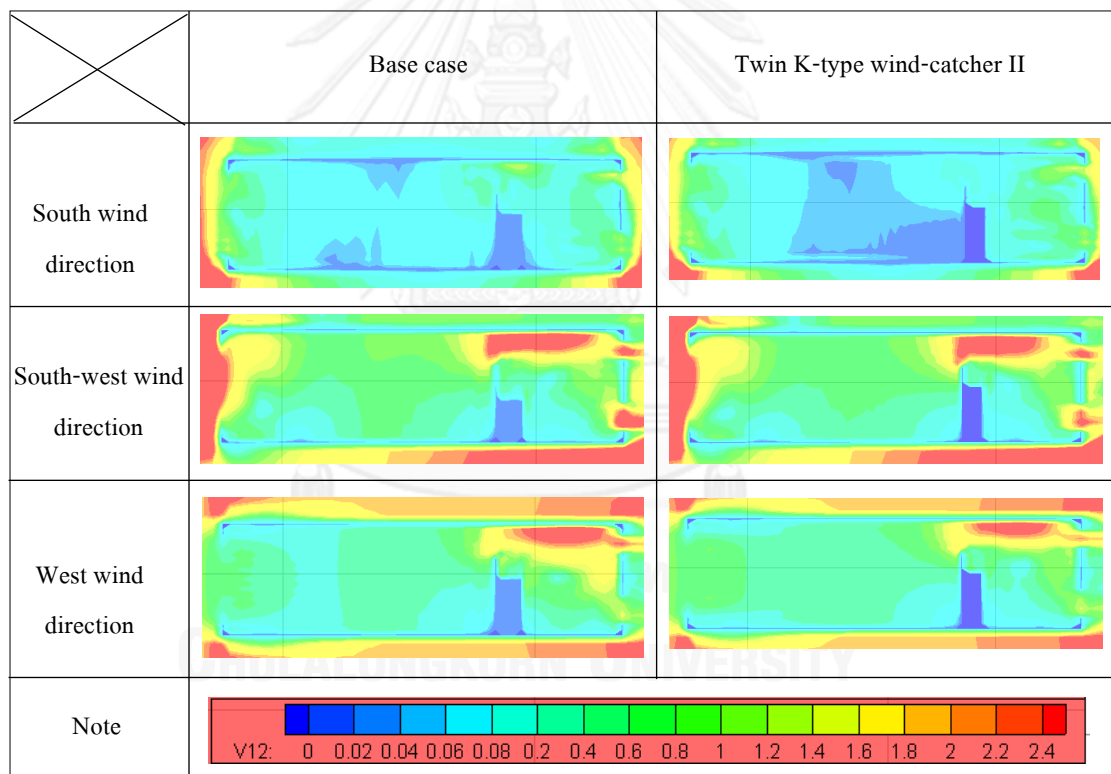


Figure 73 the results as contour plots before and after applying the twin k-type wind-catcher II in the living room with a wind speed 2m/s

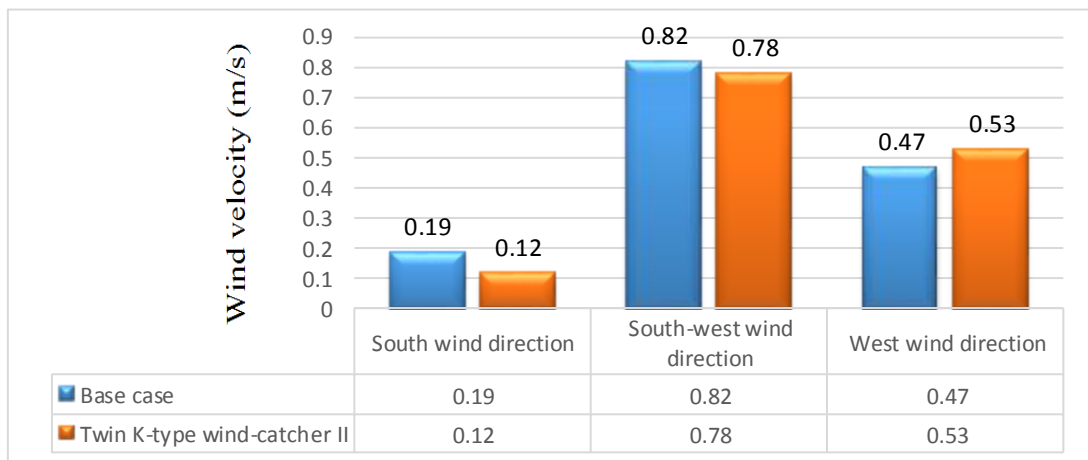


Figure 74 the of the average wind speed before and after applying the twin K-type wind-catcher II in the living room with a wind speed 2m/s

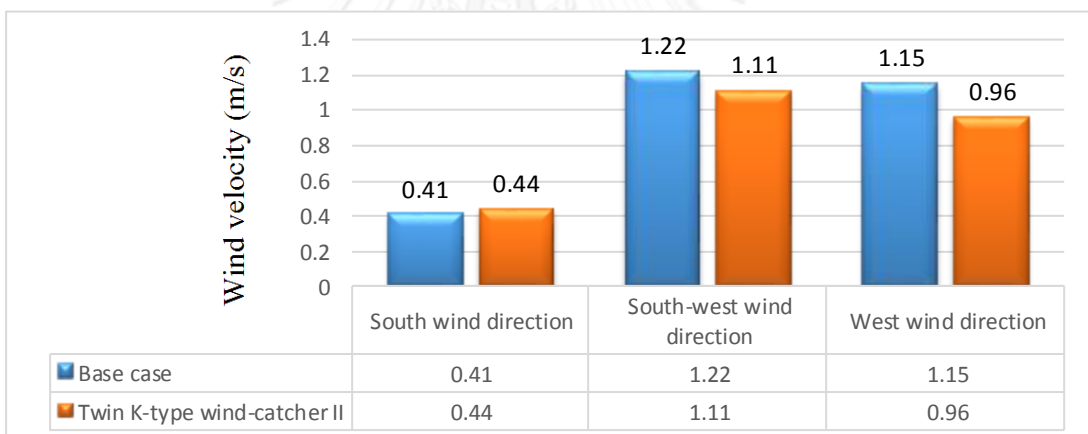


Figure 75 The of the average wind speed before and after applying the twin K-type wind-catcher II in the kitchen with a wind speed 2m/s

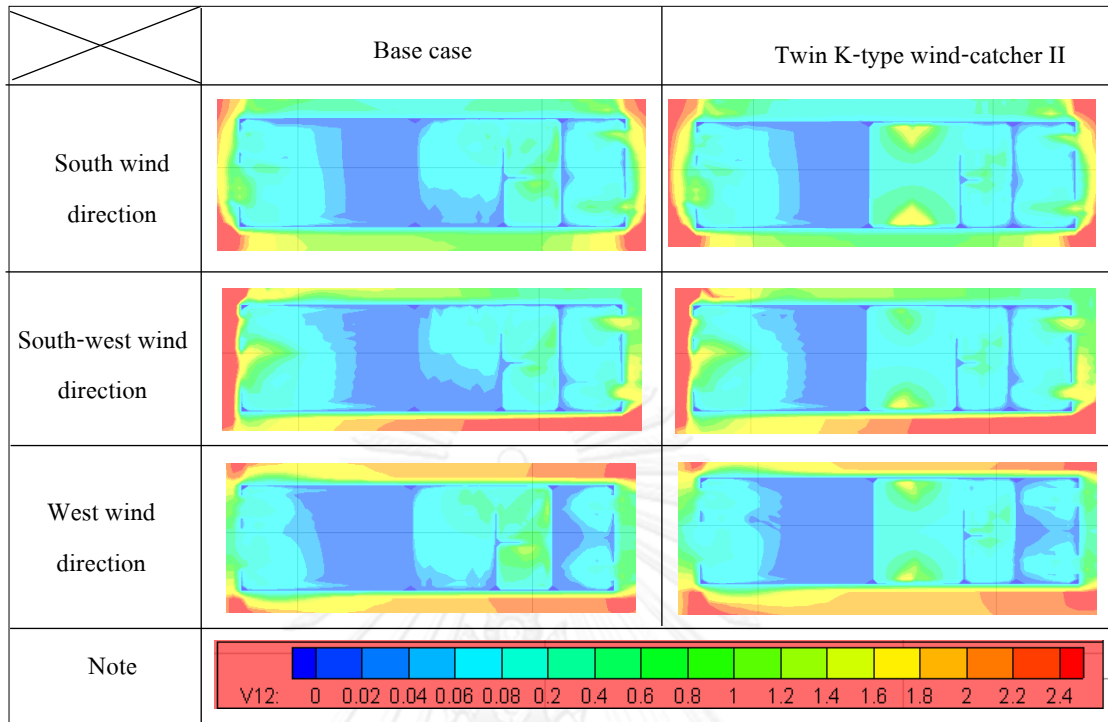


Figure 76 The results as contour plots before and after applying the twin k-type wind-catcher II in the family room with a wind speed 2m/s

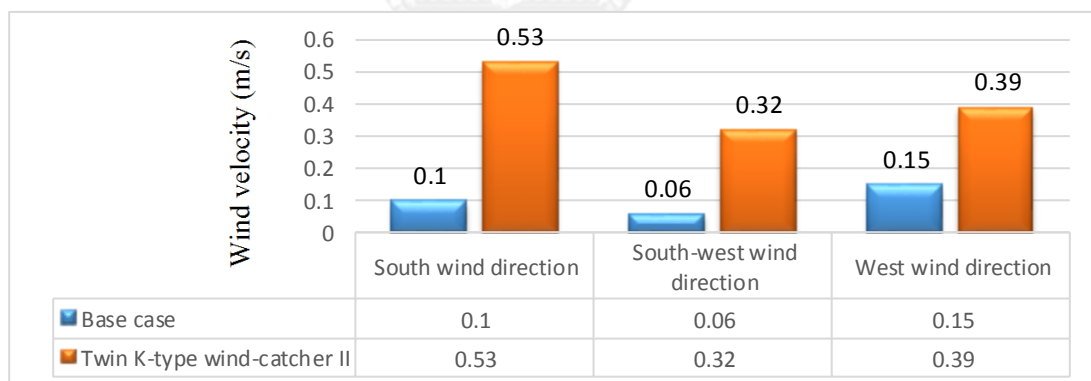


Figure 77 the of the average wind speed before and after applying the twin K-type wind-catcher in the family room with a wind aped 2m/s

As all the results from contour plots above indicated that although all the proposed designs were applied to the base case, wind velocity in the living room and the kitchen did not increase. The living room and the kitchen seemed no any significant effect from the proposed designs. However, all the proposed designs provided the significant effects to the family room as average wind velocity increased 0.31 m/s approximately if a 2m/s wind velocity was simulated.

4.1.2.2 Second category

4.1.2.2.1 Vector plots results

a. Twin K-type wind-catcher

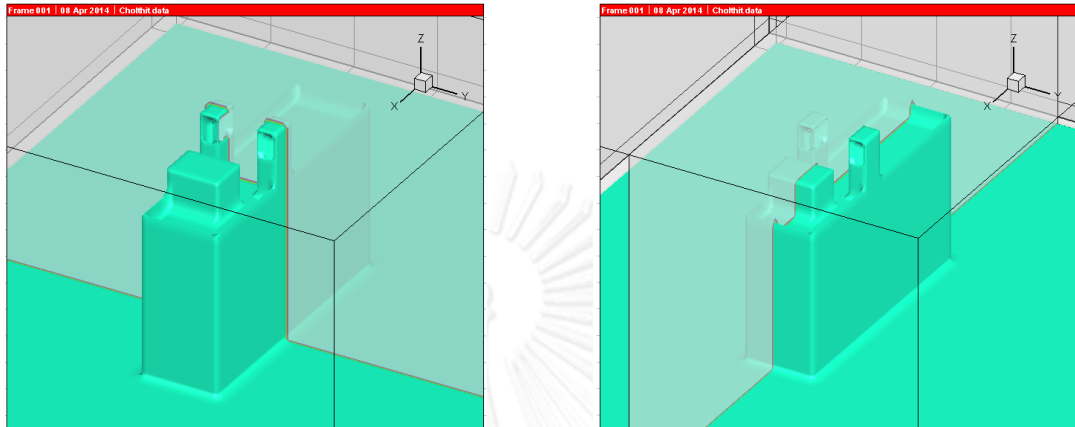


Figure 78 A section position I (left) and II (right) of the twin K-type wind-catcher II

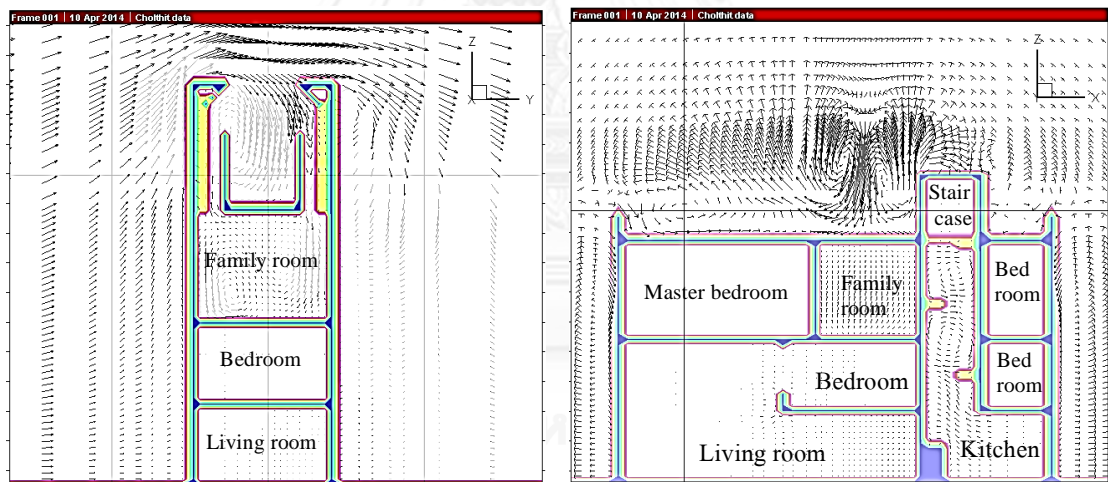


Figure 79 A vector plots of a section I (left) and II (right) of the twin K-type wind-catcher II

According to Fig. 79 showed that the outside side wind channeled down through the K-type wind-catcher to the family room and spread its flow into the ground floor, but it seemed slightly effect to the living room and the kitchen.

b. Extra design I

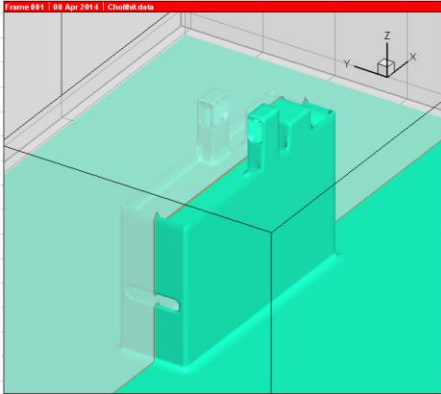


Figure 80 A section position of the extra design I

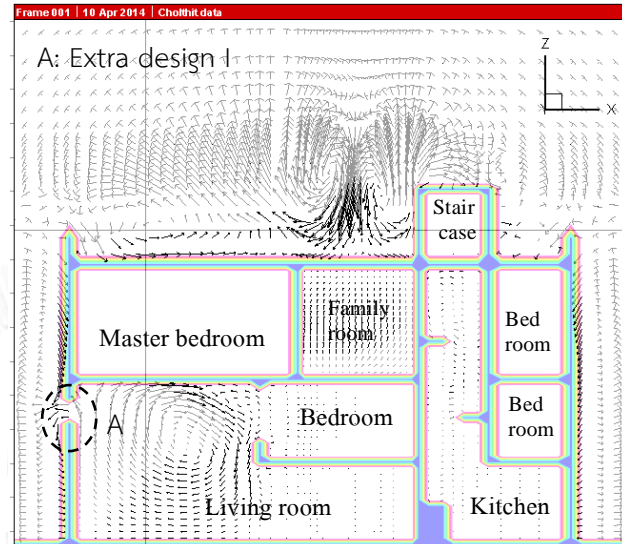


Figure 81 A vector plot of the section of the extra design I

According to the Fig. 81 showed that the outside fresh air channels down to the family room and spread its flow to the ground floor and created a wind turbulence in the living room. Then, it flowed out through an aperture positioned at the façade of the house. This flow circulation could increases wind velocity not only in the family room but also in the living room. However, it did not provide any significant effect to the kitchen.

c. Extra design II

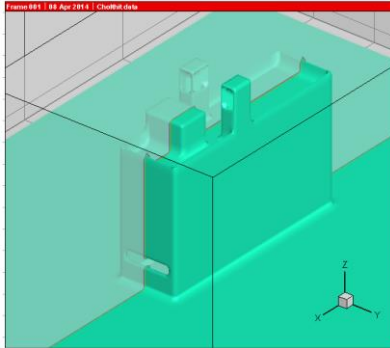


Figure 82 A section position of the extra design II

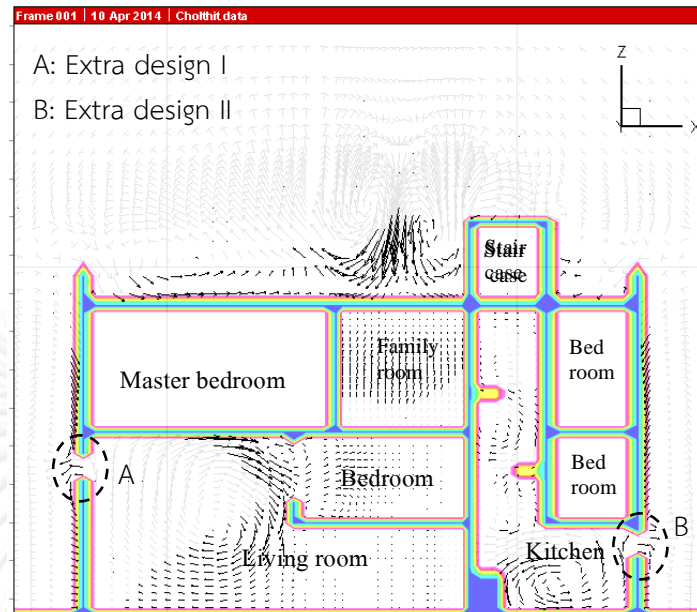


Figure 83 A vector plot of the section of the extra design II

According to the Fig. 83 showed that the K-type wind-catcher captured the outside fresh air and channeled it downward to the living room. Then, the air continued to flow down to the ground flow and separated its flow into two paths, one flowed to the living room and escaped through an opening positioned at the façade of the house while another one flowed to the kitchen and escaped through an aperture positioned at the rear wall of the house. These patterns of airflow could increase the average wind velocity for the family room, the living room, and the kitchen.

4.1.2.2.2 Contour Plots

a. Comparison of the results of the base case, the Twin K-type wind-catcher II, the extra design I and II with wind speed 4m/s

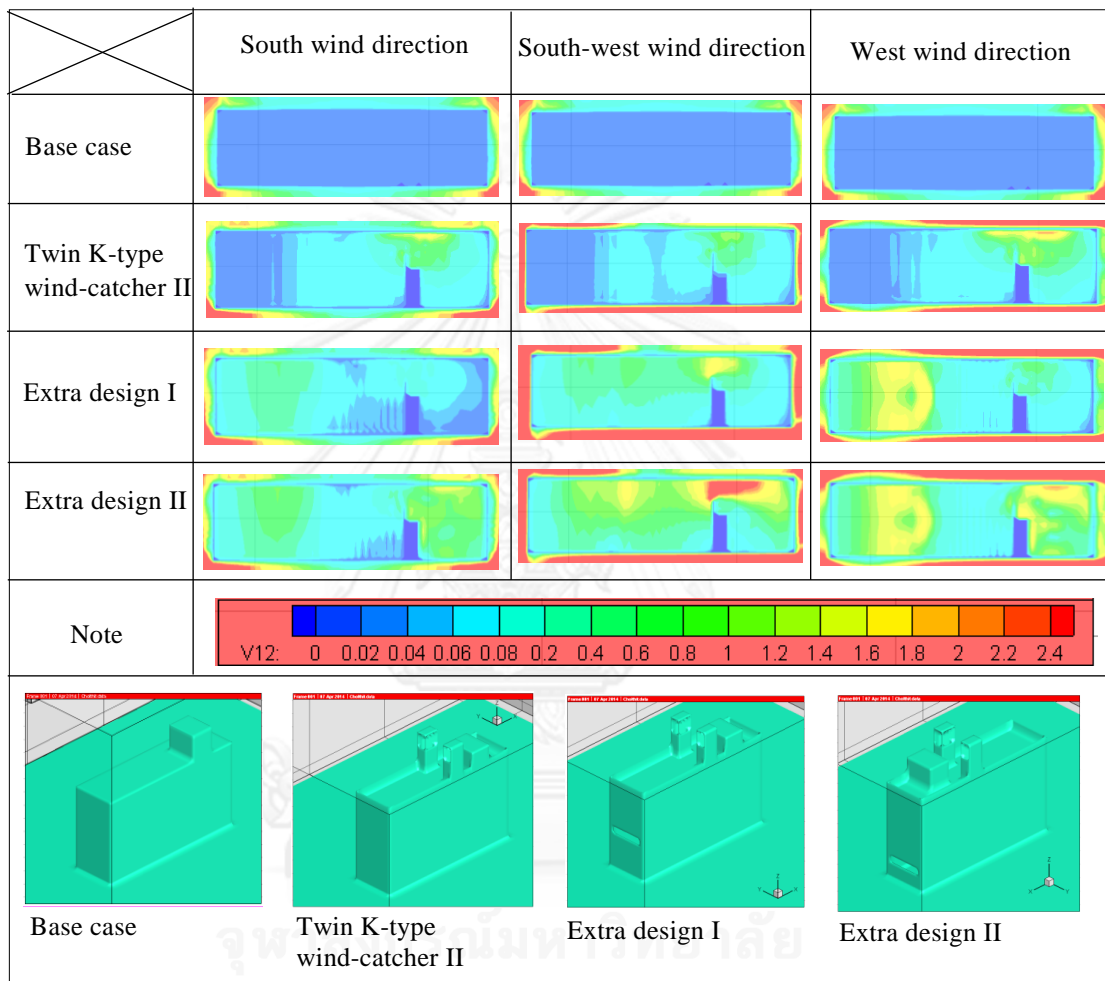


Figure 84 The results as the contour plots before and after applying the proposed designs in the living room and the kitchen with a wind speed 4m/s

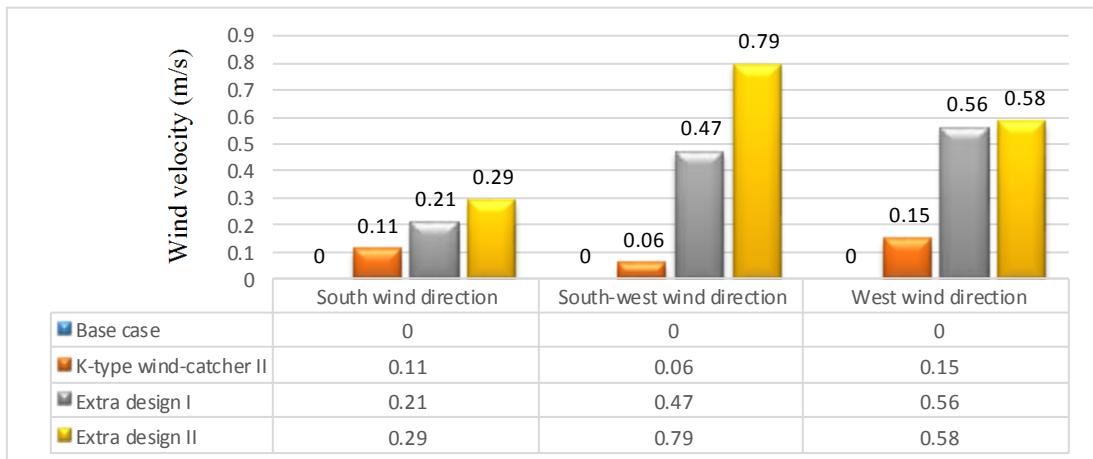


Figure 85 the average wind speed in the living room before and after applying the proposed designs with wind speed 4m/s

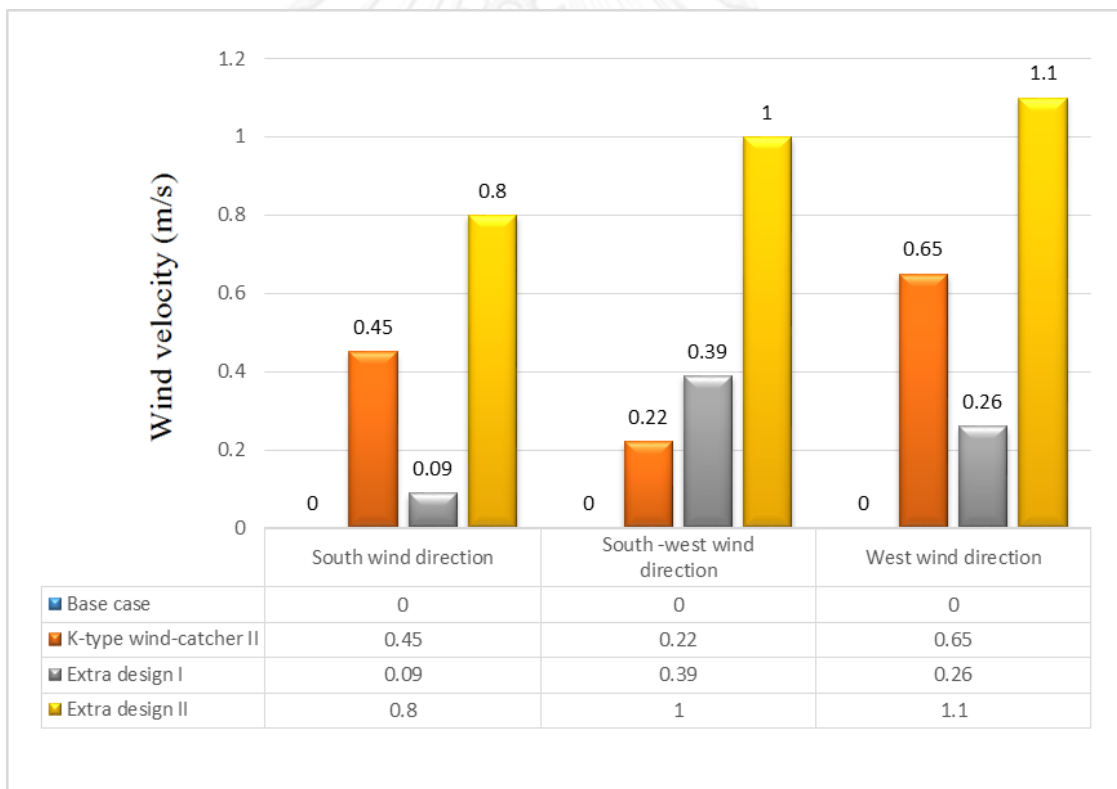


Figure 86 The average wind speed in the kitchen before and after applying the proposed designs with wind speed 4m/s

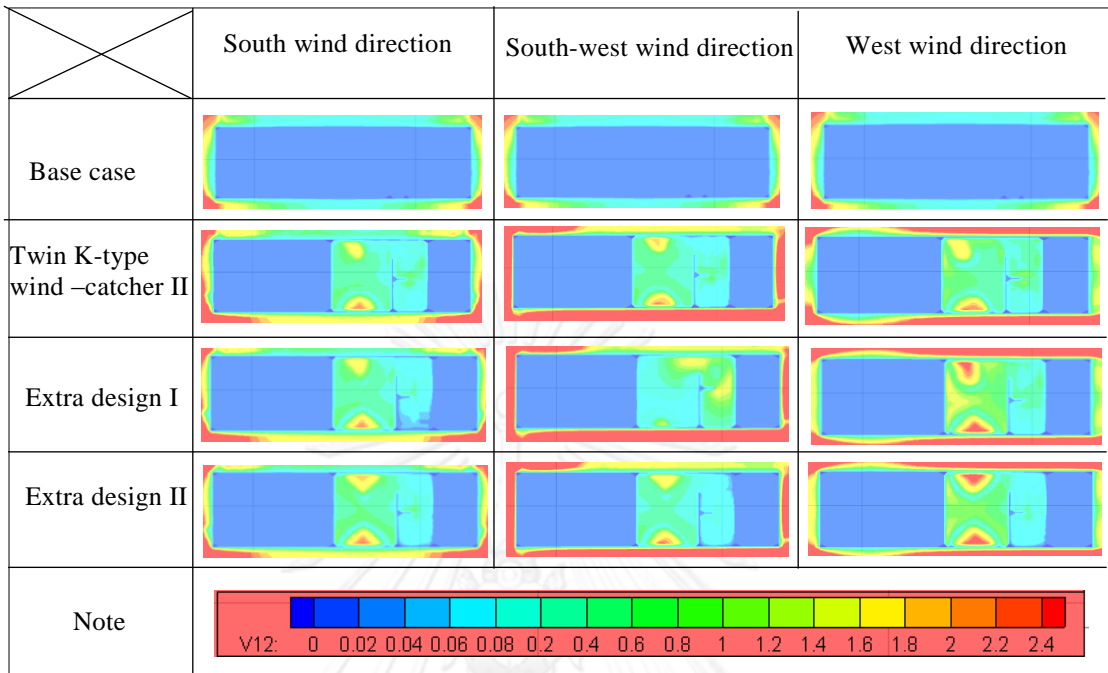


Figure 87 The results as the contour plots before and after applying the proposed designs in the family room with a wind speed 4m/s

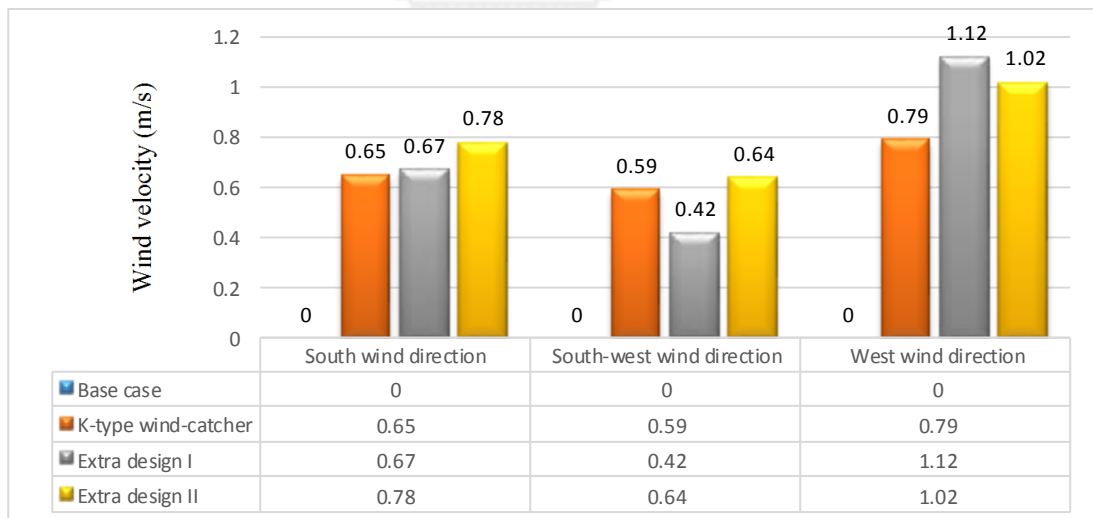


Figure 88 The average wind speed in the family room before and after applying the proposed designs with a wind speed 4m/s

The results above showed that when all the apertures of the house were closed, the airflow seemed inactive as wind speed average was 0.00 m/s according to the CFD simulation. However, the airflow was improved after applying the proposed designs. Additionally, the extra design II provided the best results amongst others designs as it integrated the twin K-type wind-catcher with two openings (one aperture was positioned at the façade of the house and another one was positioned at the rear wall of the house). It could increase average wind speed about 0.55 m/s in the living room, about 0.97 m/s in the kitchen, and about 0.81 m/s in the family room.

b. Comparison of the results between the base case and the extra design II with wind speed 2m/s

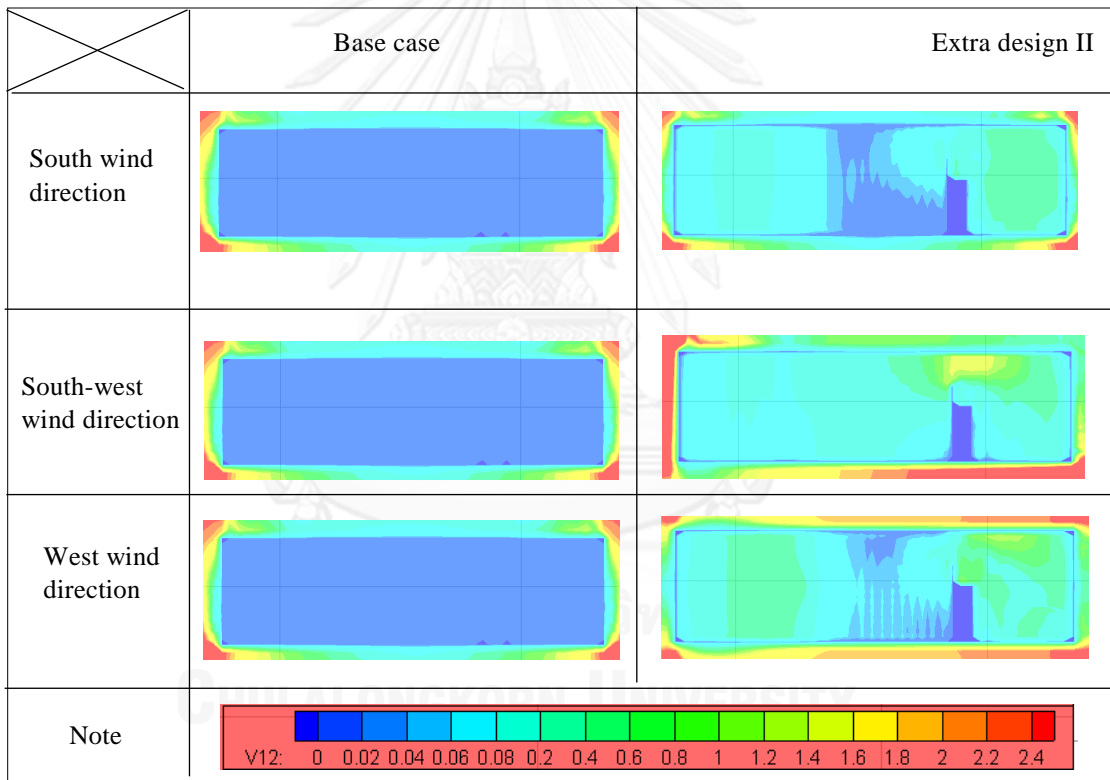


Figure 89 The results as the contour plots before and after applying the extra design II in the family room and the kitchen with a wind speed 2m/s

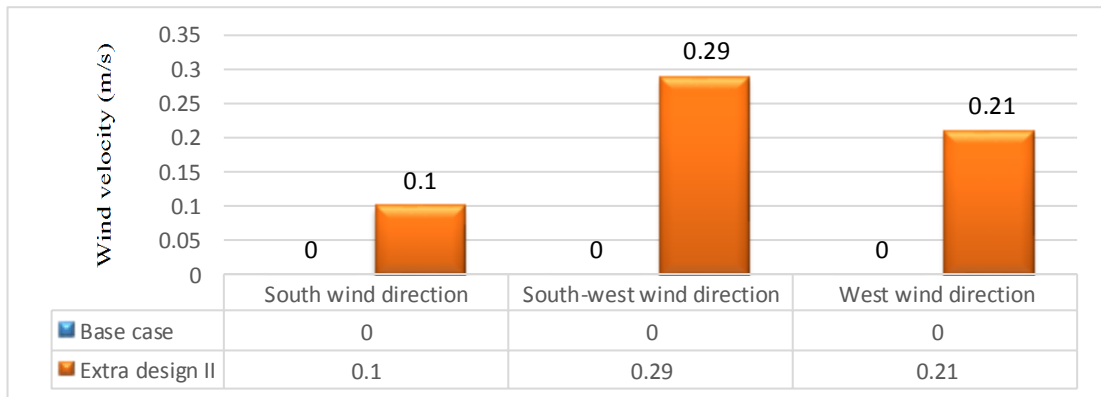


Figure 90 the average wind speed in the living room before and after applying the extra design II with a wind speed 2m/s

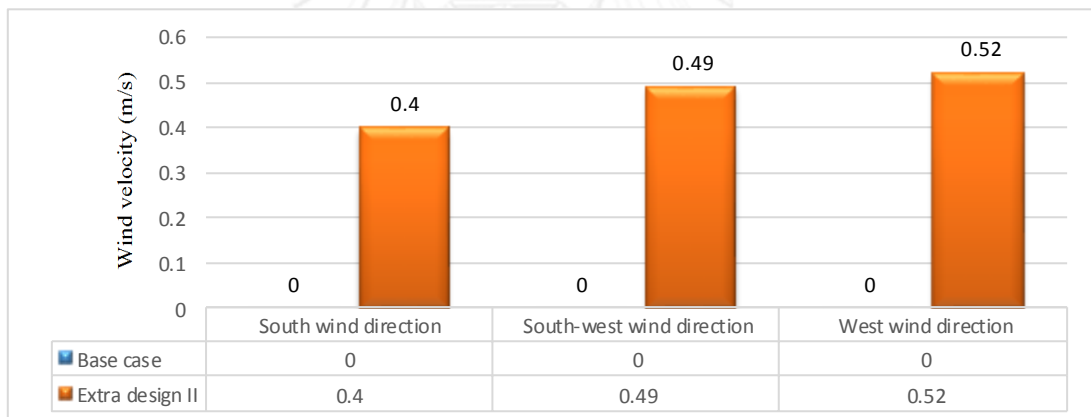


Figure 91 The average wind speed in the kitchen before and after applying the extra design II with a wind speed 2m/s

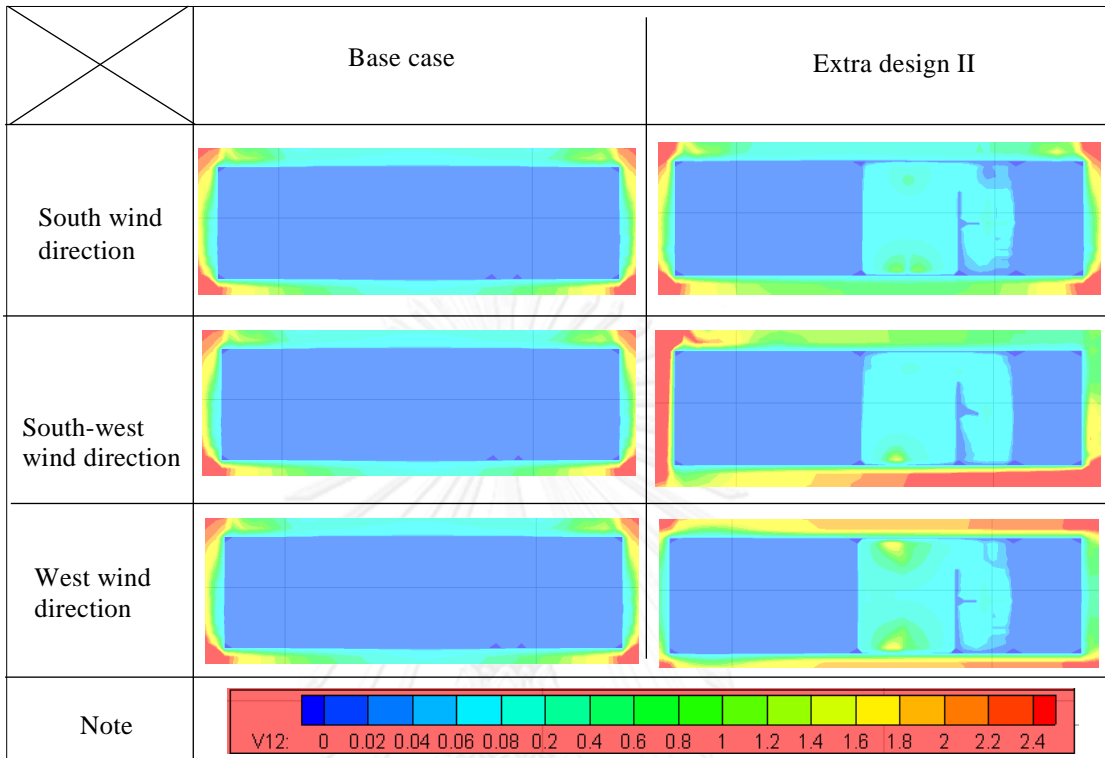


Figure 92 The results as the contour plots before and after applying the extra design II in the family room with a wind speed 2m/s

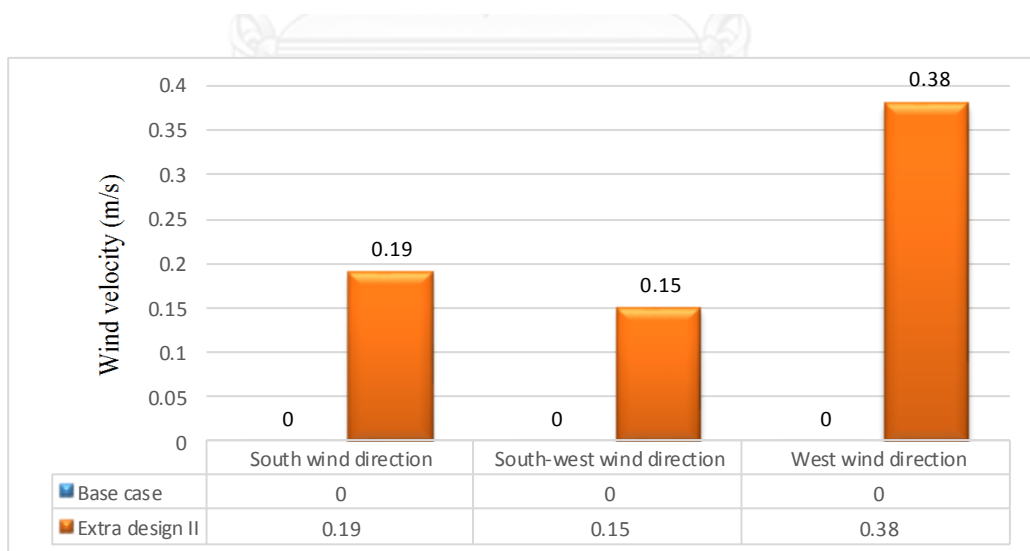


Figure 93 The average wind speed in the family room before and after applying the extra design II with a wind speed 2m/s

The results above showed that the average wind speed in the house was 0.00 m/s when all the apertures of the house were closed; however, the average wind speed in the house increased after applying designs. Additionally, the extra design II provided the most effective results. It could increase the average wind speed about 0.2 m/s in the living room, about 0.47 m/s in the kitchen, and about 0.24 m/s in the family room.

4.2 Discussion

As the results of the first category after the designs, there was no any significant effect to the living room and the kitchen although all designs were carried out. However, there was a significant effect to the family room as the airflow was improved and the average wind speed in the room increased. When the 2m/s wind speed was inputted into the simulation, the result showed that the average wind speed in the family room increased 0.31 m/s approximately. Moreover, the average wind speed in the family room increased 0.92 m/s approximately while the 4m/s wind velocity was inputted into the simulation. As Dr. Sunthorn Boonyatithan (2000) demonstrated that if the temperature between 23 to 33 °C and the humidity between 37 % to 75 %, the temperature will decrease 1 °C while the wind velocity increases 0.7 m/s. Therefore, the temperature decreased from 0.44 °C to 1.31 °C approximately in the family room if the average wind speed increased from 0.31 m/s to 0.92 m/s.

The results of the second category after the designs showed as follow: The wind speed in the living room increased 0.2 m/s approximately if 2m/s wind speed was input to simulation. Additionally, when the wind velocity 4m/s was input to simulation, the average wind speed in the living room increased 0.55 m/s approximately. Therefore, the temperature in the living room decreased from 0.29 °C to 0.79 °C approximately.

The average wind velocity in the kitchen raised up about 0.47 m/s while the wind speed 2m/s was input to simulate and the wind speed in this room increased 0.97 m/s while the 4m/s wind speed was input to simulate. So, the temperature in the kitchen decreased from 0.67 °C to 1.39 °C after applying the proposed designs.

If the wind speed 2m/s was used for simulation, the average wind speed in the family room increased 0.24 m/s. Moreover, the average wind speed in the room raised up 0.81 m/s while 4m/s wind speed was input for simulation. So, the temperature in the family room decreased from 0.34 °C to 1.16 °C approximately.



Chapter V

Epilogue

This chapter describes the conclusion of the whole process of research study. Then, the recommendations were provided for future researches. Finally some parts missed in this research were illustrated in order to ask for future researches.

5.1 Conclusion

This research study aims to investigate the effects of various types of wind-catcher to induce airflow into a two-story row-house (a ground floor and a first floor) in order to increase thermal comfort to the row-house occupants and to find out the most proper wind-catcher to use for a row-house in a tropical monsoon climate.

A questionnaire related to thermal comfort was carried out and an actual measurement to investigate the wind velocity in the house was conducted. The results from the questionnaire showed that the main problem of thermal, stuffiness, and lacking air movement in row houses occurred more often at night-time than day-time as 36.66% feeling hot, 26.66% feeling stuffy, and 43.33% feeling airless at day time; 39.99% feeling hot, 29.99% feeling stuffy, and 63.33% feeling airless at night time. As the results from the actual measurement conducted on 17 October 2013, the average outside wind velocity is about 1.57 m/s, the average outside temperature is about 29.54 °C, and the average relative humidity is about 84.15%. Moreover, the average wind velocity in the living room is about 0.03 m/s, the average wind velocity in the kitchen is about 0.044 m/s, and the average wind velocity in the family room is about 0.006 m/s. The average temperature in the living room is about 29.31 °C, the average temperature in the kitchen is about 26.77 °C, and the average temperature in the family room is about 28.46 °C. The average relative humidity in the living room is about 84.23%, the average relative humidity in the kitchen is about 84.23% and the average relative humidity is about 85.31%.

According to the CFD program (Heat X) the air movement as well as the indoor wind velocity were improved after applying the proposed designs. By increasing the wind velocity in the house, the thermal comfort level of the building occupants increased. According to Dr. Sunthorn Boonyatithan (2000) demonstrated that if the temperature between 23 to 33 °C and the humidity between 37 % to 75 %, the temperature will decrease 1 °C while the wind velocity increases 0.7 m/s. As The results from this research showed that after inputting wind 2m/s and 4m/s, during the day-time the use of wind-catcher provided a significant effect to the family room as air movement improved, wind velocity increased from 0.31 m/s to 0.92 m/s approximately which directly led to a decrease in temperature from 0.44 °C to 1.31 °C. However, the use of wind-catchers did not provide any significant effect to the living and the kitchen. Additionally, after inputting wind speed 2m/s and 4m/s, during the night-time the use of wind-catchers is very important to improve air movement in the house. It provided a significant effects as the airflow improved, the average wind speed increased, and the thermal discomfort people feel minimized. The average wind speed in the living room increased from 0.2m/s to 0.55 m/s leading to a reduction in the temperature from 0.29 °C to 0.79 °C approximately. Moreover, the average wind speed in the kitchen increased from 0.47 m/s to 0.97 m/s led to a decrease in the temperature from 0.67 °C to 1.39 °C approximately. Furthermore, the average wind speed in the family room increased from 0.24 m/s to 0.81 m/s which led to a reduction in the temperature from 0.34 °C to 1.16 °C approximately.

As the results from this research study indicates, the twin K-type wind-catcher II is the most appropriate one amongst all the proposed designs. Moreover, this research also indicates that the wind-catchers can be used properly in a tropical monsoon climate such as Phnom Penh, Cambodia in order to enhance indoor air movement and to increase thermal comfort for row-houses' occupant. As a bioclimatic version of the psychometrics chart (Nugroho 2006) showed that when relative humidity between 80% to 90% and air temperatures between 26 °C to 33 °C wind velocity from 0.6m/s to 1m/s can be used to provide thermal comfort to occupants (Agung Murti Nugroho 2007).

5.2 Application

As the results from this research study for both a completed close and a completed open showed that the use of wind-catcher alone was capable of improving air movement in the first floor of the house because the wind came from an inlet of the wind-catcher and escaped through other outlets of the wind-catcher significantly. However, the results also showed that for both the completed close and the completed open, the use of wind-catcher alone was not capable of improving airflow in the ground floor of the house because there was no any opening at the ground floor of the house allowed the stale air to flow out. Nonetheless, after adding an Extra design I (an aperture positioned at the façade of the ground floor) and an Extra design II (an aperture positioned at the rear wall of the ground floor), the air movement in the ground floor of the house improved significantly.

According to the results above indicated that the climate as tropical monsoon which is hot and humid, the use of wind-catcher can provide the significant effect when one system of the wind-catcher responds for one ventilated room. Additionally, the results from the simulations showed that the effect of the X-type wind-catcher I and the twin K-type wind-catcher II provided the similar results, but the twin K-type wind-catcher was recommended because it was easy for construction in terms of connecting beams for supporting the wind-catcher.

5.3 Recommendation

There are many types of wind-catcher; therefore in order to choose the appropriate wind-catchers to enhance air movement in the buildings, wind direction and wind speed are the main factors that need to be considered. As in Cambodia, there are eight wind directions, so the use of twin K-type wind-catcher or X-type wind-catcher is the proper choice as they can capture the wind from all directions. Moreover, the size of wind-catcher directly affects the capability of wind-catcher to capture the outside fresh air. In the hot and humid area as Cambodia, the larger and shorter wind-catcher is recommended as it is capable of capturing the wind better than a small and tall one, because in the hot and humid area the wind speeds at a higher altitude is not too different from the wind speeds of a lower altitude. Furthermore, the design method in this research study is not limited to use with the row-house, but it can be applied to other buildings that are limited in openings such as an underground building. On the other hand, before applying the wind-catchers, the building's apertures need

to be considered as it can impact to the wind-catcher system because the wind channels down from the wind-catcher can crash against the wind flow coming into the building from other apertures of the house.

5.4 Future researches

1. In this study, the effects of louvers to the performance of the wind-catcher as well as the airflow rate haven't been studied as of yet. A future research should study the effects of louvers to the performance of the wind-catchers.
2. According to this research study, it is indicated that the use of a stair case as a wind-catcher did not provide any significant effect to enhance airflow into the row-house. A future research should study the effects of the stair case while it was used as a stack ventilation or a solar induced ventilation to enhance airflow in a row-house.
3. This research had studied only the common spaces in the row-house, a future research should study about the improvement of airflow in the bed rooms of the house.
4. In this study, in order to improve natural ventilation in the row-house, only one natural ventilation device was used, a wind-catcher. A future research study should conduct a research about the effect of airflow in a row-house by integrating a wind-catcher and a stack ventilation.
5. In this study, the size of the wind-catcher was limited because of the narrow size of the row-house. Therefore, we were not able to study the various sizes of the wind-catcher neither the enlargement of the wind-catcher's size. A future research should study the effects of the wind-catchers from their various sizes.

REFERENCES

- A'ZAMI, A. (2005). Badgir in Traditional Iranian Architecture. International Conference of Passive and Low Energy Cooling for the Built Environment. Santorini, Greece.
- A.R. Mohammadi, M. M. T., I.M.S. Usman, N.A.G. Abdullah, A.I. Che-Ani, N. Utaberta (2010). The Effect of Balcony to Enhance the Natural Ventilation of Terrace houses in the Tropical Climate of Malaysia. Architecture, *Kebangsaan Malaysia*: 179, 281-283.
- Angung Murti Nugroho, M. H. A. a. D. R. O. (2007). "A Preliminary Study of Thermal Comfort in Malaysia's Single Storey Terraced House." Journal of Asian Architecture and Building Engineering **6**: 181.
- Al-Shaali, R. K. (2002). Maximizing Natural Ventilation by Design in Low Rise Residential Buildings Using Wind Catchers in the Hot Arid Climate of UAE, Southern California. **Master of Building Science**: 28.
- Allard, F. (1998). Natural Ventilation in Building: A Design Handbook. London, James & James.
- Angung Murti Nugroho, M. H. A. a. D. R. O. (2007). "A Preliminary Study of Thermal Comfort in Malaysia's Single Storey Terraced House." Journal of Asian Architecture and Building Engineering: 175-181.
- Encyclopedia, E. (2011). "Buoyancy."
- Fanger, O. P. (1967). Thermal Comfort. New York, McGraw_Hill.
- Fathy, H. (1986). Natural Energy and Vernacular Architecture: Principles and Examples with Reference to Hot Arid Climates. Chicago, University of Chicago press.
- Ghaemmaghami, P. S. M., M. (2005). Wind Tower a Natural Cooling System in Iranian Traditional Architecture. International Conference of Passive and Low Energy Cooling for the Built Environment. Santorini, Greece.

- Ghobadian, V. (2006). *Climatical investigation of Traditional Iranian Buildings*. Tehran, Tehran.
- Givoni, B. (1994). Passive and Low Energy Cooling of Buildings. United States of America, Van Nostrand Reinhold.
- Haslinda Mohamed Kamar, N., Nazri Kamsah, Masine Md. Tap, and Khairul Amry Mohd Salimin (2012). Assessment of Thermal Comfort in a Naturally Ventilated Residential Terrace House. Mechanical Engineering, Teknologi Malaysia. **Master**: 1-7.
- Khatami, N. (2009). THE WIND-CATCHER, A TRADITIONAL SOLUTION FOR A MODERN PROBLEM, Glamorgan/Prifysgol Morgannwg: 19-20.
- Lim, Y.-W. (2013). "INDOOR ENVIRONMENTAL COMFORT IN MALAYSIAN URBAN HOUSING." American Journal of Environmental Science: 431-438.
- M.M. Tahir, A. I. C.-A., N.A.G. Abdullah, N.M. Tawil, M. Surat, A. Ramly (2010). "The Concept of Raised Floor Innovation for Terrace housing in Tropical Climate." Journal of Surveying, Construction and Property 1(1): 59.
- maleki, B. A. (2011). "Wind Catcher: Passive and Low Energy Cooling System in Iranian Vernacular Architecture." International Journal on "Technical and Physical Problems of Engineering" 3(8): 132-134.
- Mohamad Mohd Faizal, M. A., Tanimoto Jun, Ikegaya Naoki and Omar Abdul Rahman (2013). WIND-INDUCED NATURAL VENTILATION IN TYPICAL SINGLE STOREY TERRACED HOUSES IN MALAYSIA. 13 th Conference of International Building Performance Simulation Association. France: 587-593.
- Nasibeh Sadafi, E. S., Lim Chin haw and Mohd. Fakri Zaky jaafar (2007). Potential Design Parameters for Enhancing Thermal Comfort in Tropical Terrace House. Architecture, Putra Malaysia, Malaysia: 15-23.
- Nugroho, A. M. The Impact of Solar Chimney Geometry for Stack Ventilation in Malaysia's Single Storey Terraced House, Universiti Teknologi Malaysia Institutional Repository.

- Nugroho, A. M. a. H., M. (2006). Evaluation of Parametrics for the Development of Vertical Solar Chimney Ventilation in Hot and Humid Climate. The 2nd International Network For Tropical Architecture Conference. Christian Wacana University, Jogjakarta.
- Olgay, V. (1961). Design With Climate: Bioclimatic Approach to Architectural Regionalism. New Jersey, Printon University Press.
- Penh, M. d. P. (2009). PHNOM PENH Croissance et Transformation.
- Rajeh, M. (1989). Natural Ventilation in Terrace Housing of Malaysia: Effect of Air Well on Air Flow and Air Velocity, University of Queensland.
- Roaf, S. (2005). Air-Conditioning Avoidance: Lessons from the Wind-catchers of Iran. International Conferecne of Passive and Low Energy Cooling for the Built Environment.
- Tabriz, H. A. a. M. B. (2011). Using Wind Catchers as a Passive Cooling System for Residential Buildings in Cyprus. Architecture, Sheffield.
- TALIB, N. B. M. T. M. (2007). The Impact of Wider Frontage Design of Low-Cost Double Storey Terrace House (LCDSTH) to Airflow and Natural Ventilation in Malaysia, Universiti Islam Antarabangsa Malaysia.
- Tavakolinia, F. (2011). Integrating the Principles of a Wind-Catcher and a Solar-Chimney to Provide Natural Ventilation, California Polytechnic State University, San Luis Obispo. **Master of Science in Architecture: 5-10.**
- Wardah Fatimah Mohammad Yusoff, E. S., Nor Mariah Adam, Abdul Razak Sapian, Zabidi hamzah (2012). "Investigation of Potential Solar Induced Ventilation Strategy in Hot and Humid Climate." Alam Cipta 5: 43.
- บุญญาธิการ, ส. (2000). เทคนิคการ ออกแบบ บ้านประหยัดพลังงาน เพื่อคุณภาพชีวิตที่ดีกว่า.



APPENDICES

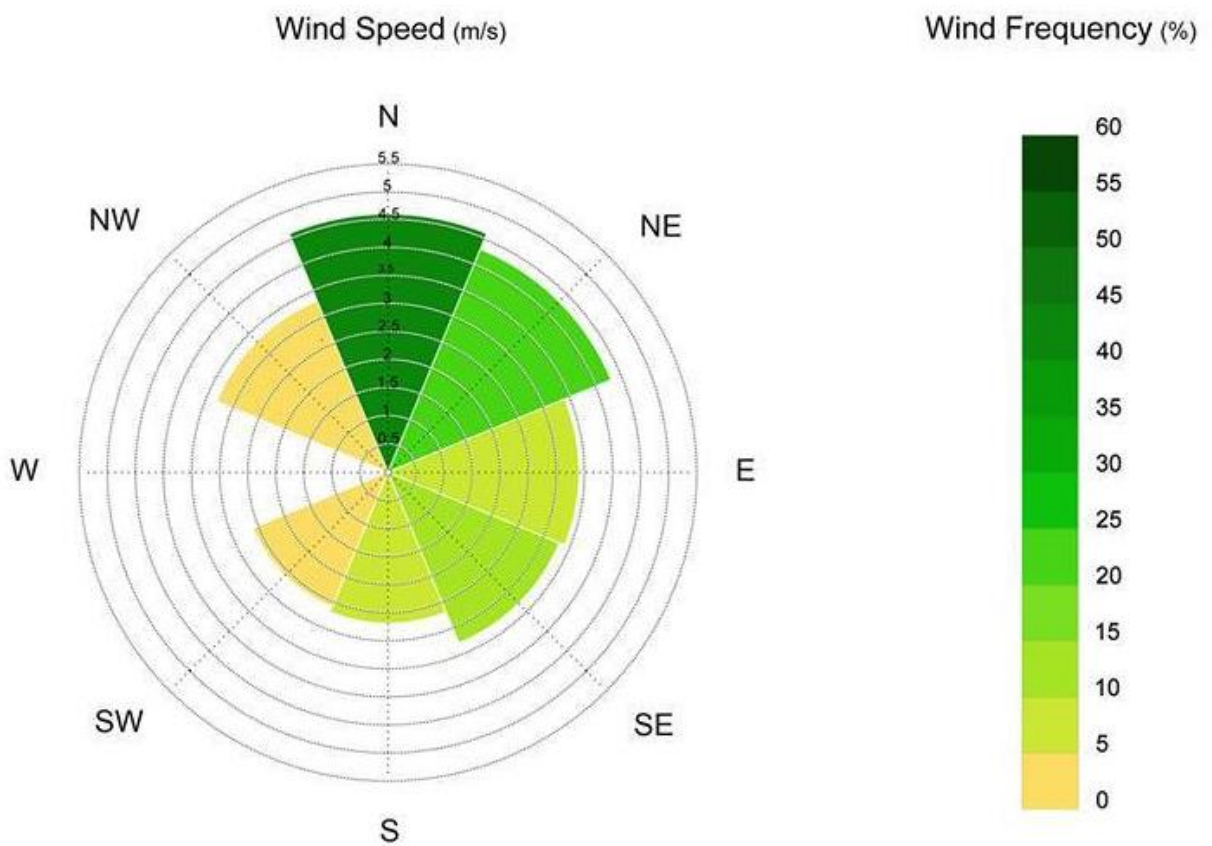
จุฬาลงกรณ์มหาวิทยาลัย
CHULALONGKORN UNIVERSITY

Appendix A: Cambodia Wind Rose

Source: Phnom Penh International Airport (Pochentong International) weather station from 2003-2012

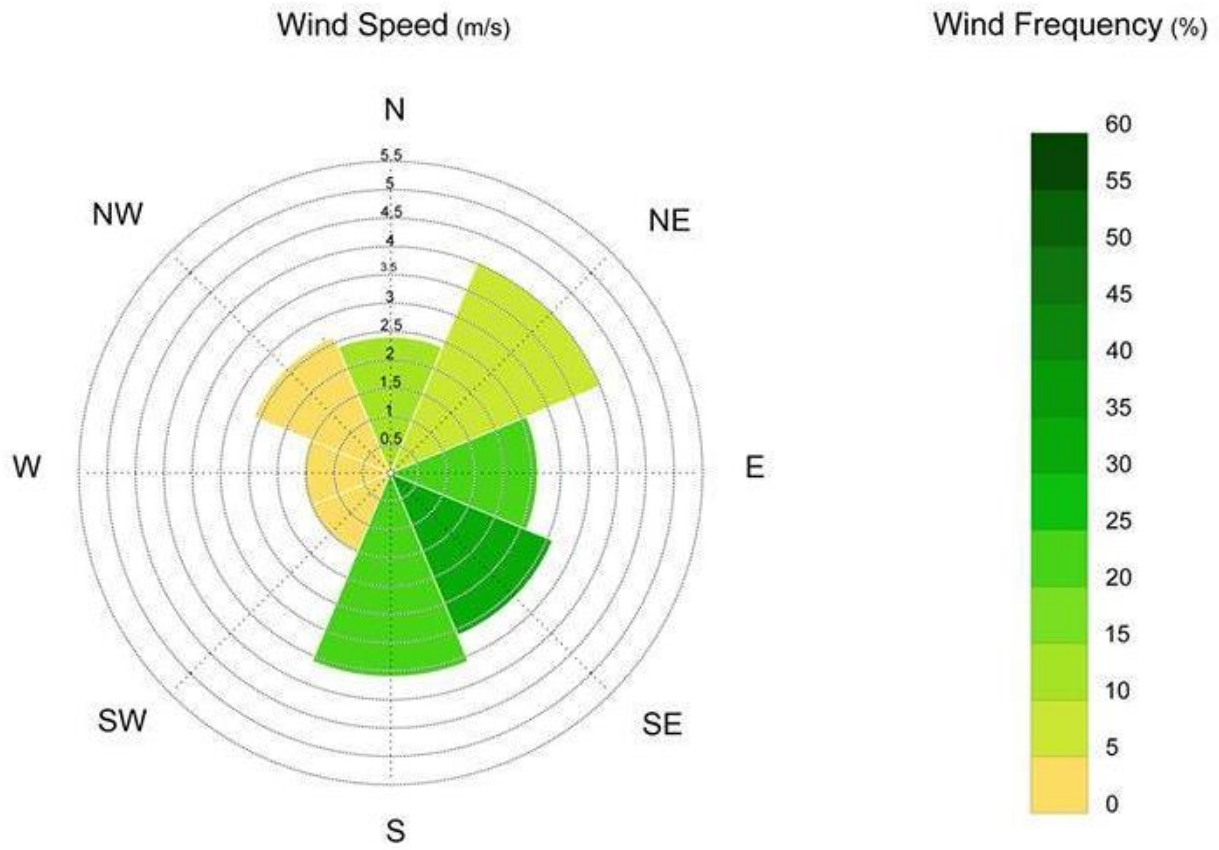
CAMBODIA WIND RECORD FROM 2010-2012

JANUARY

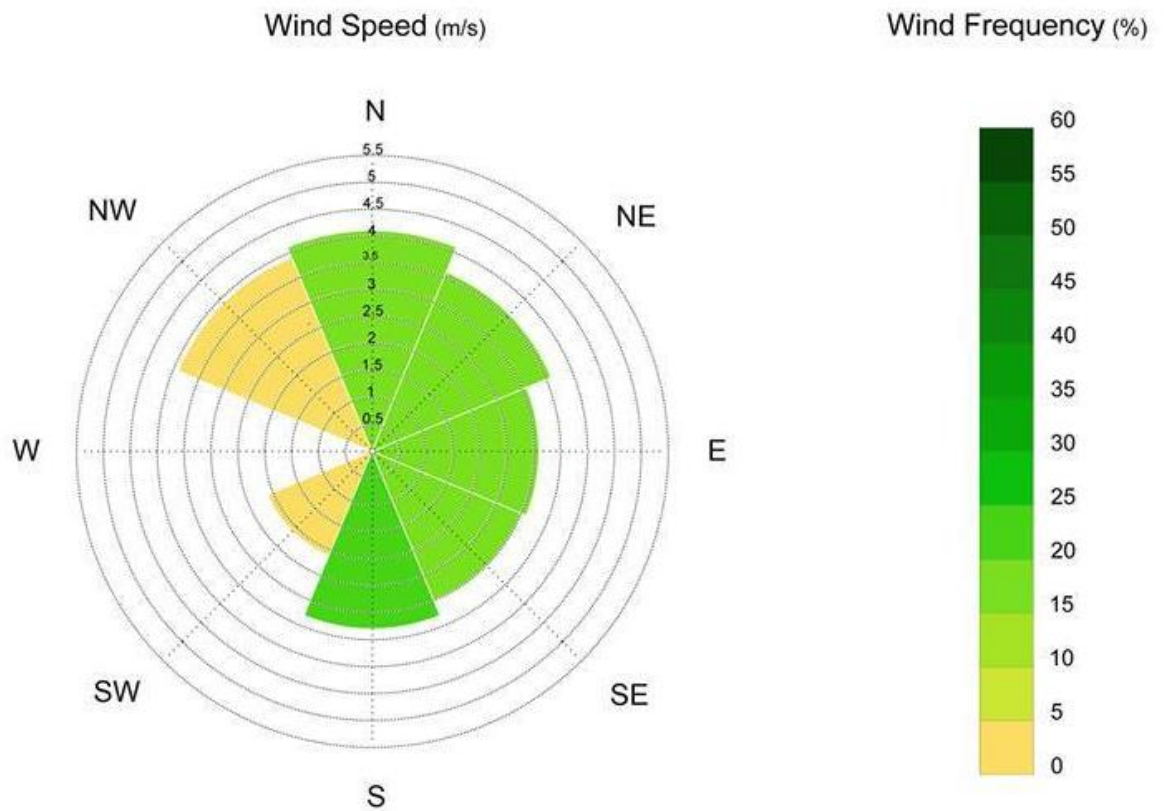


CAMBODIA WIND RECORD FROM 2010-2012

FEBRUARY

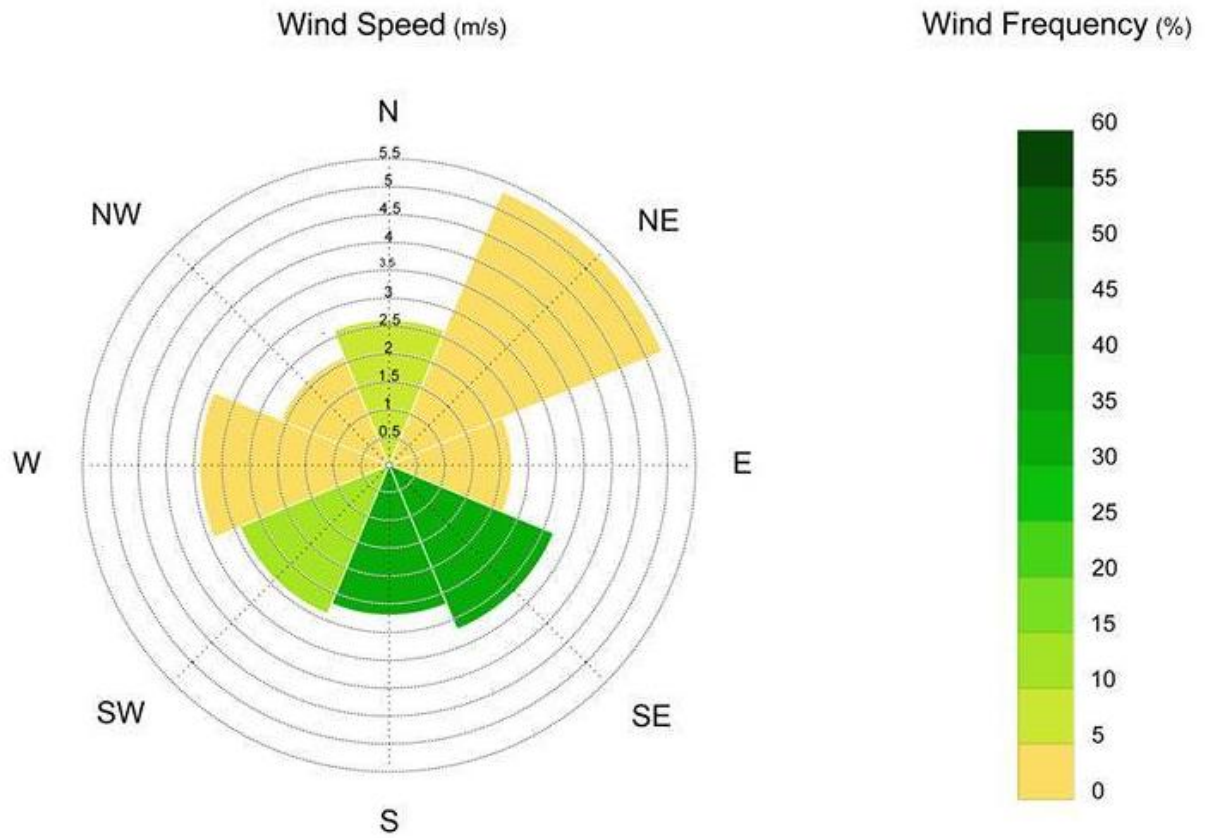


CAMBODIA WIND RECORD FROM 2010-2012 MARCH



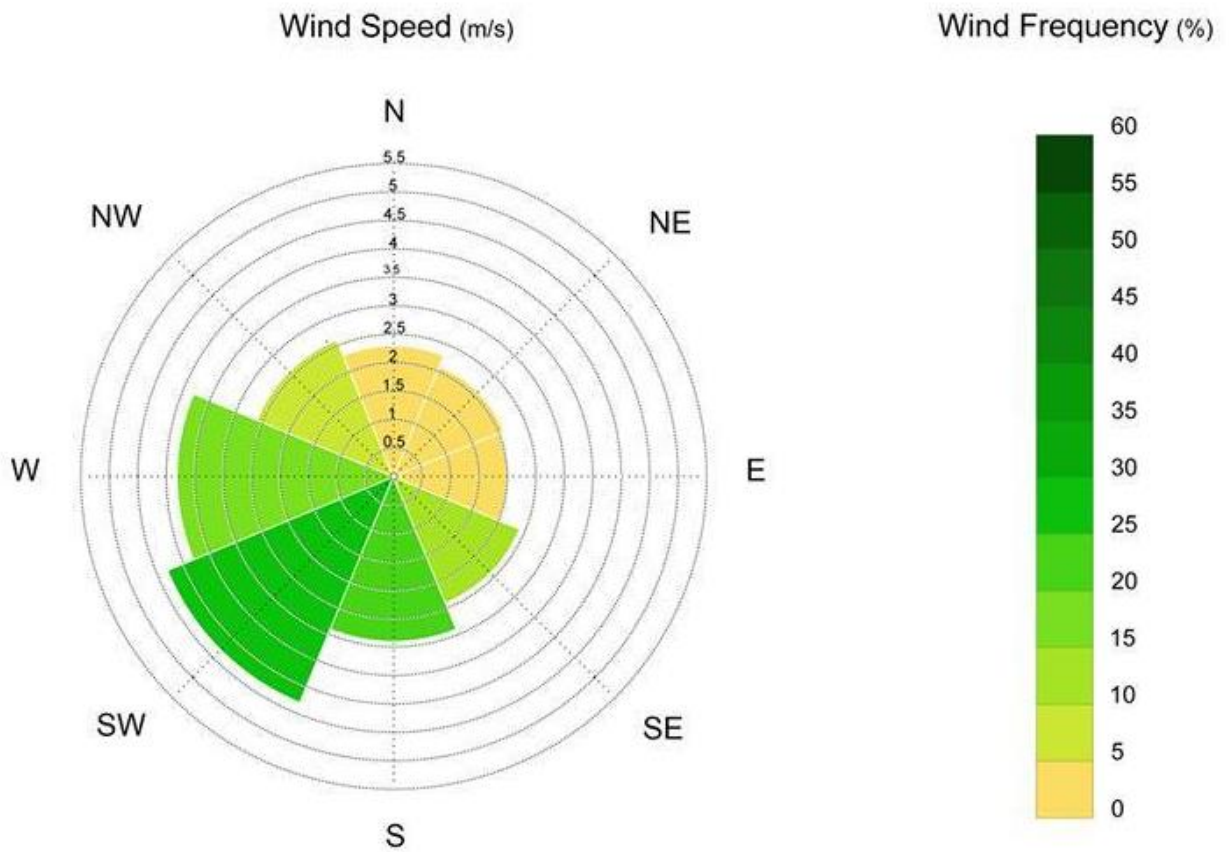
CAMBODIA WIND RECORD FROM 2010-2012

APRIL



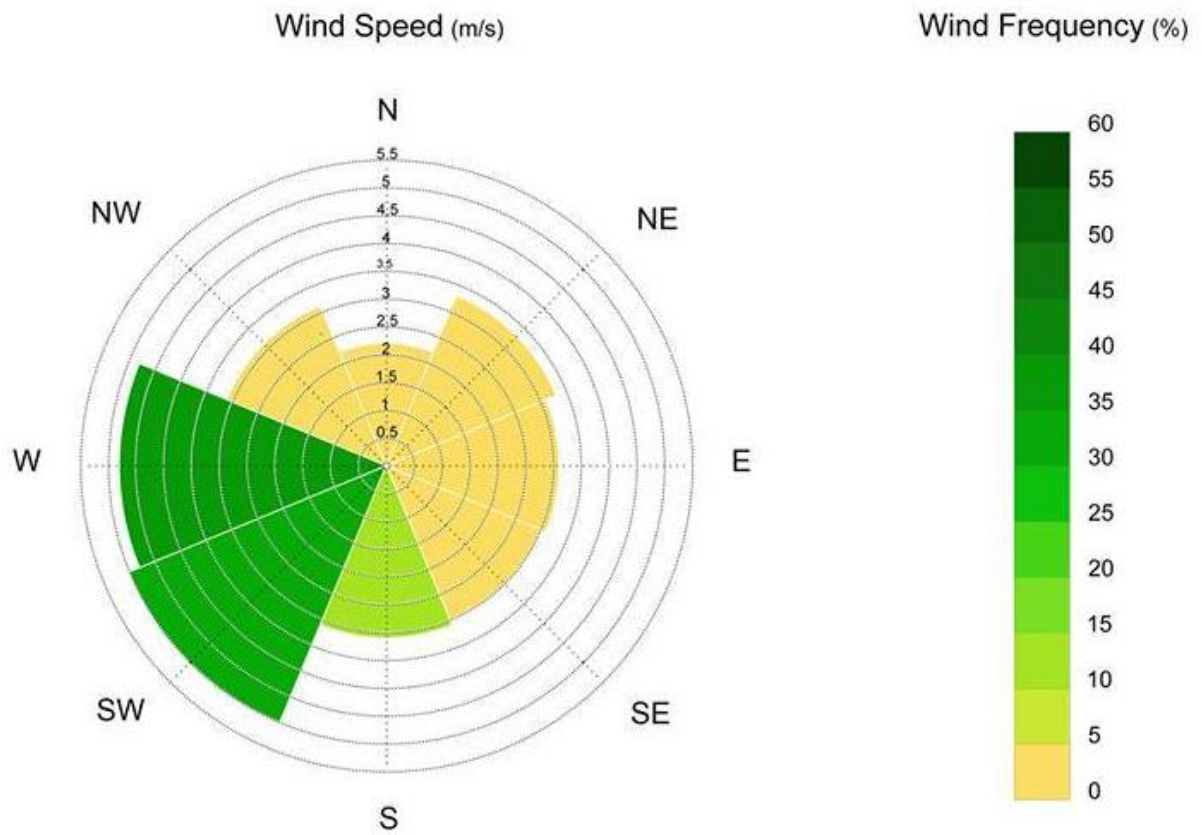
CAMBODIA WIND RECORD FROM 2010-2012

MAY



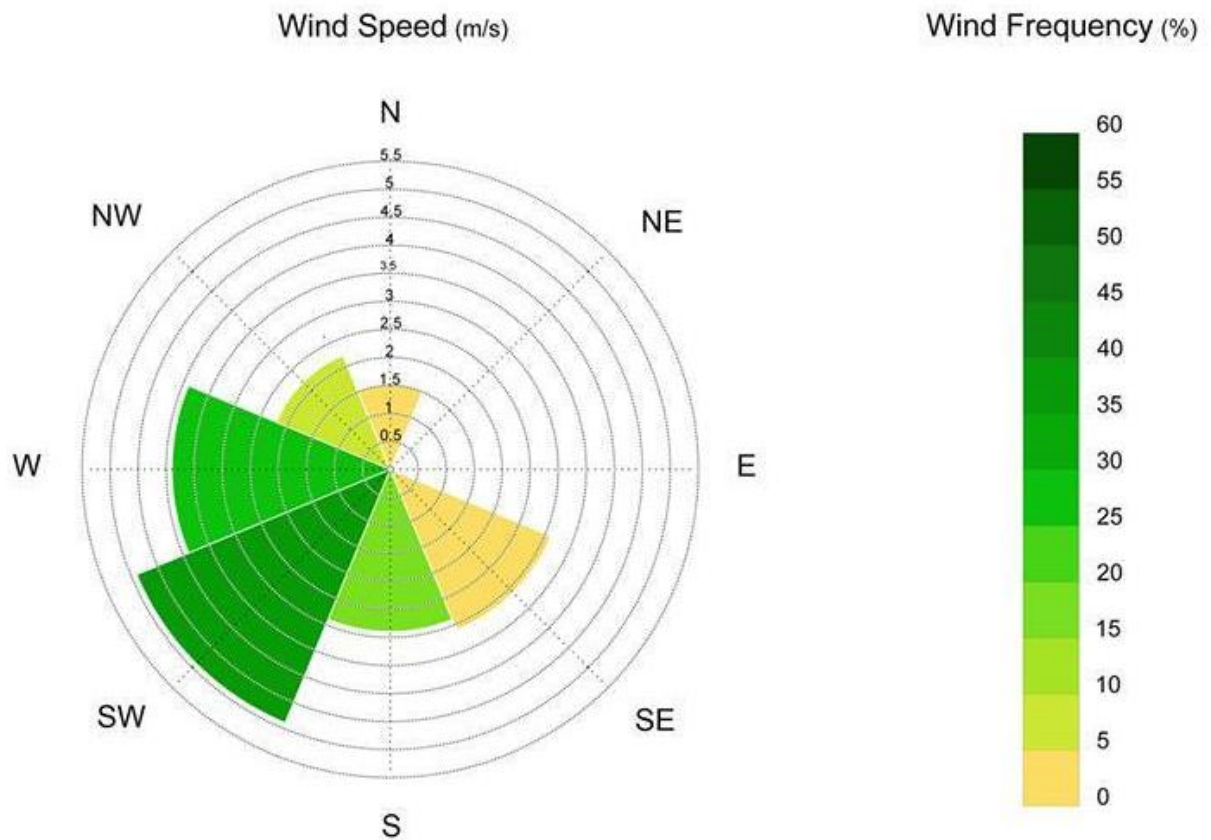
CAMBODIA WIND RECORD FROM 2010-2012

JUNE

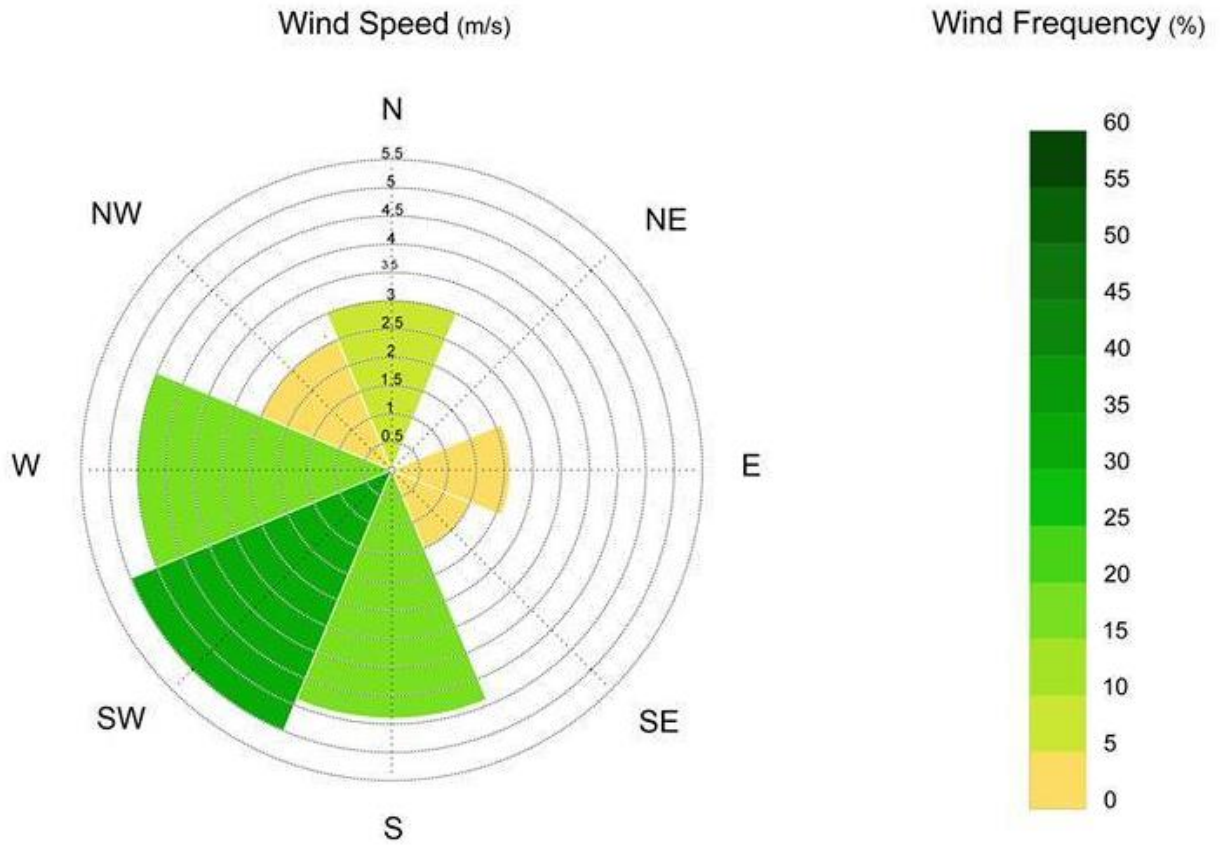


CAMBODIA WIND RECORD FROM 2010-2012

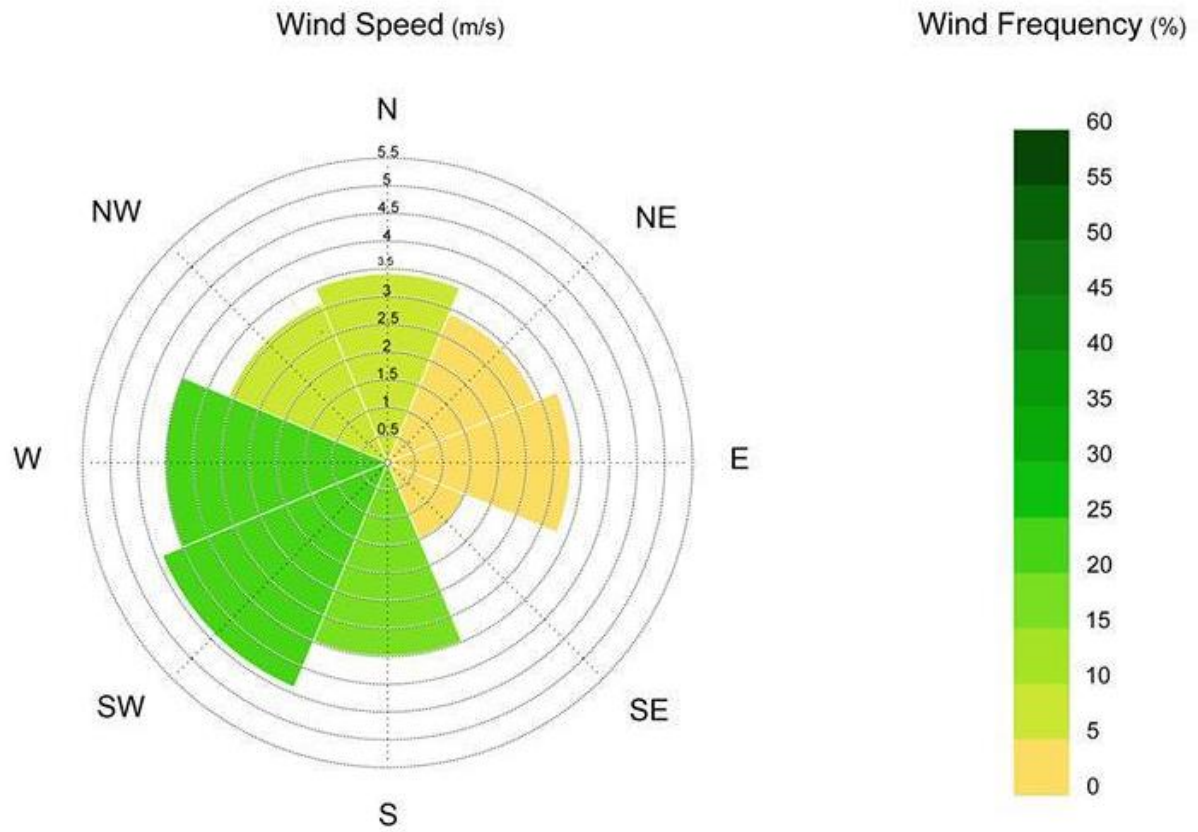
JULY



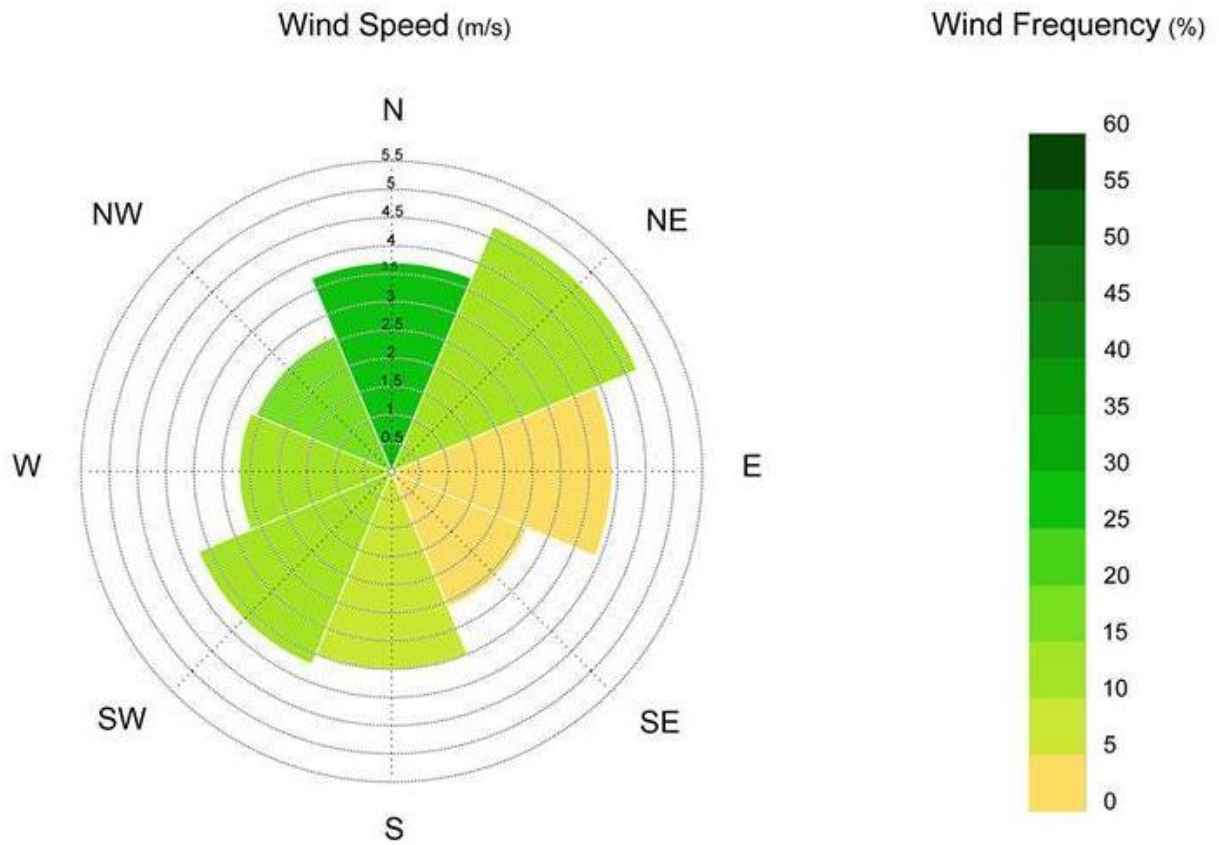
CAMBODIA WIND RECORD FROM 2010-2012 AUGUST



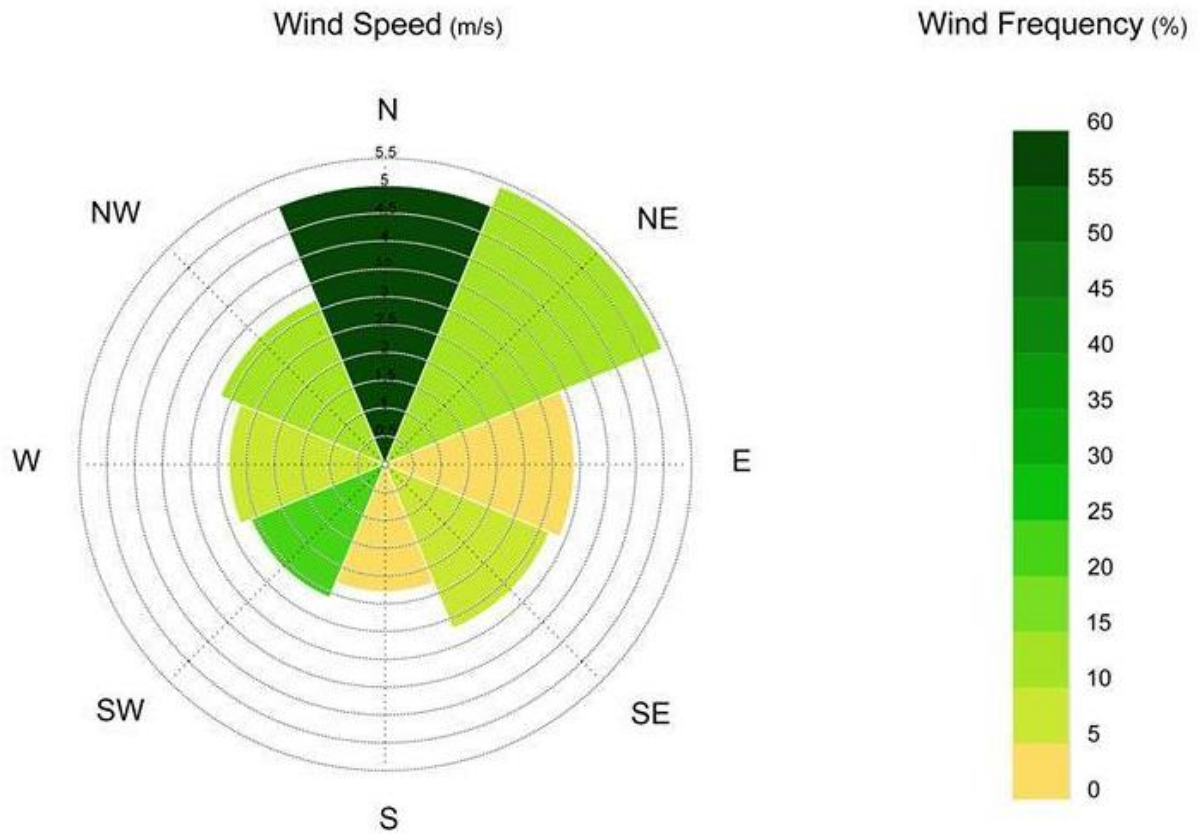
CAMBODIA WIND RECORD FROM 2010-2012 SEPTEMBER



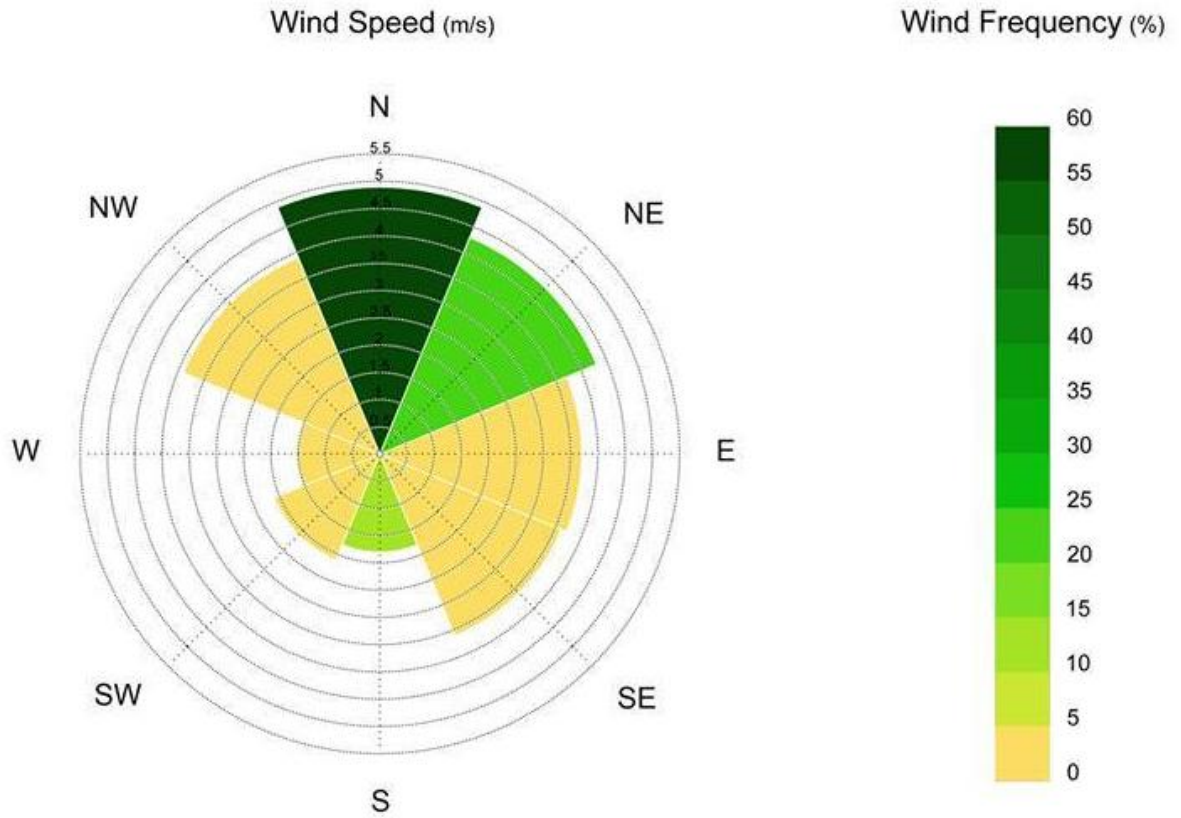
CAMBODIA WIND RECORD FROM 2010-2012 OCTOBER



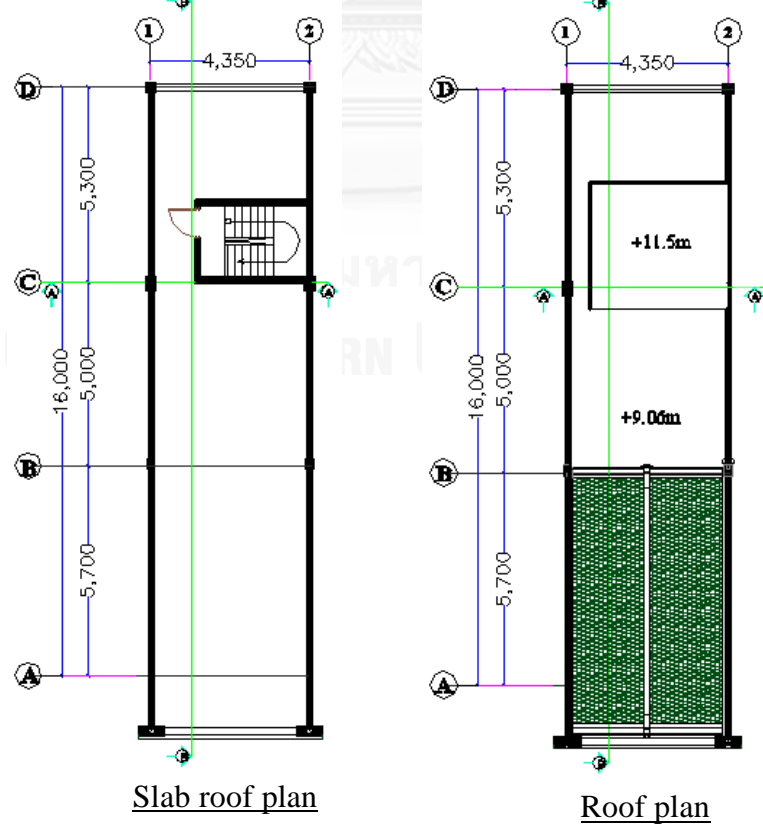
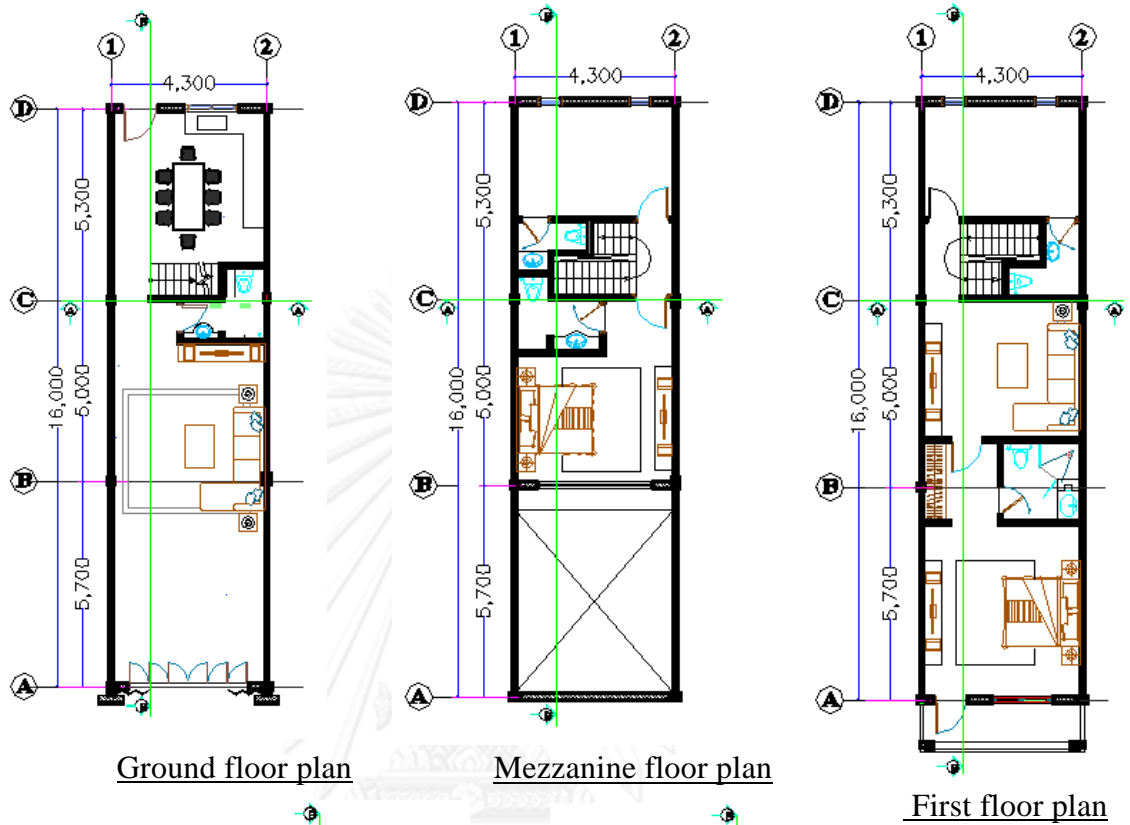
CAMBODIA WIND RECORD FROM 2010-2012 NOVEMBER

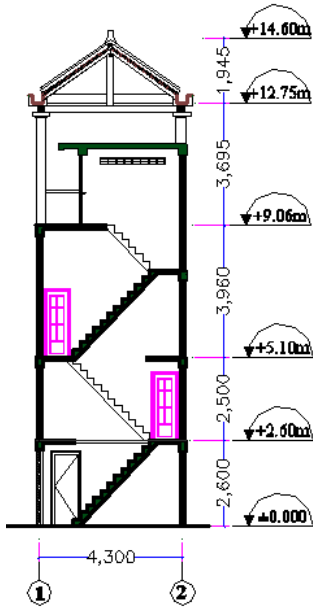


CAMBODIA WIND RECORD FROM 2010-2012 DECEMBER

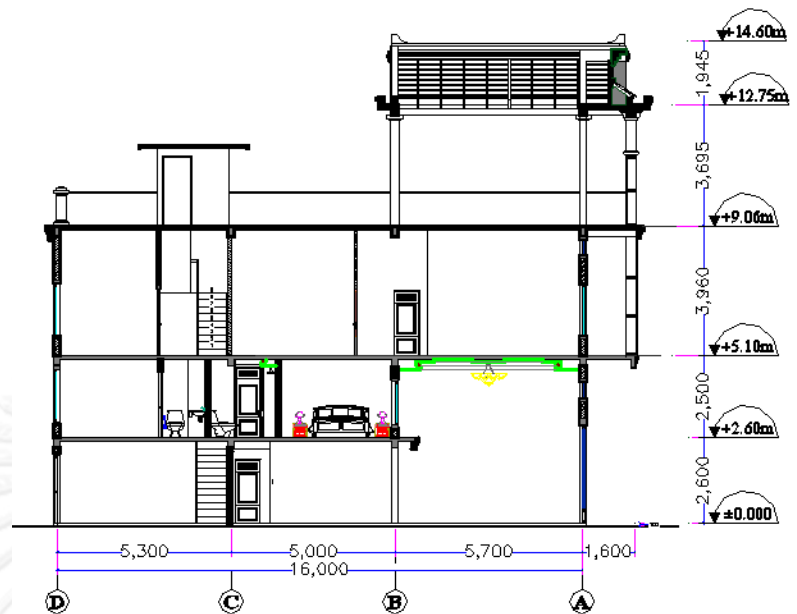


Appendix B: Architecture Plans of Case study row-house

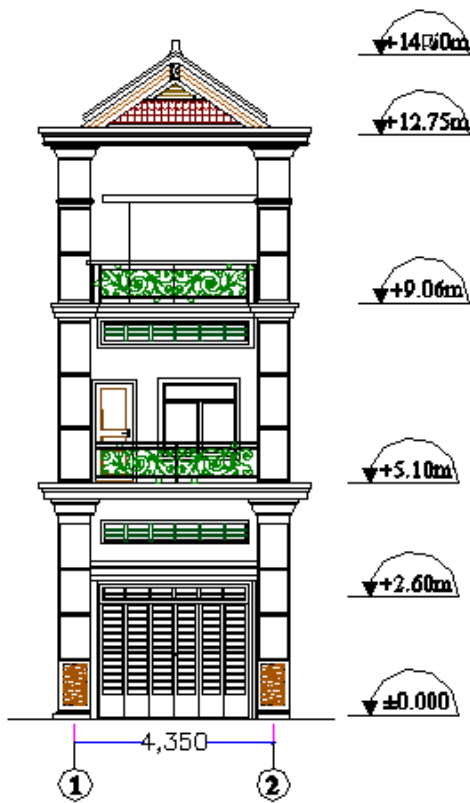




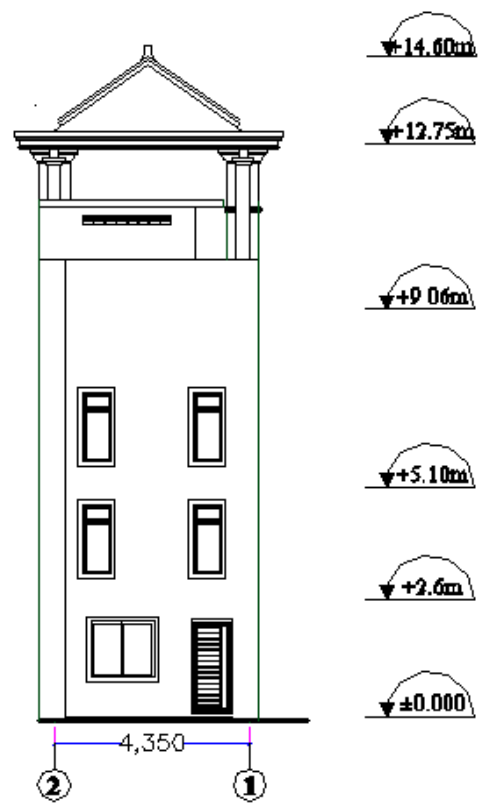
Section A-A



Section B-B



Front elevation



Rear elevation

Appendix C: Law and Regulations of construction

THE ROYAL GOVERNMENT OF CAMBODIA

Anukret 86 ANK/BK/December 19, 1997

CHAPTER 2: LOCATION AND SIZE OF CONSTRUCTIONS

ARTICLE 8. LOCATION ADJACENT TO NEIGHBORING LOTS

For adjacent lots, constructions shall be erected either as a joint wall or a minimum distance of 2m from the boundaries of the lot. This 2 m space shall be left free from all constructions. Windows or doors in joint walls shall be prohibited. For construction adjacent to lot boundaries or joint wall shall be determined in the instruction of the National Committee of Land Management, Urban Planning and Construction, upon the proposal of the province and municipalities. Living quarters shall be defined as all rooms with the exception of kitchens, sanitary, services facilities and corridors. This rule shall also apply to hotels. In this case, all bedrooms and living units considered as living quarters. This rule shall apply equally to working premises. In this case, all rooms use as offices or regulars and daily workshops shall be considered as living quarters with the exception of rooms necessitating by their specific function of the absence of nature light, such that: computer hall, laboratory, cinema studios etc. The provincial and municipality halls shall reserve the right to close all windows openings which do not comply with the above-mentioned distance. For existent buildings which do not comply with the above-mentioned rules, the Municipality or the Province can require the construction of structures to prevent direct views on the neighboring building. These structure decorated-walls, panels made from wood or others materials shall in no event prevent the proper ventilation of living quarters. Shall be considered as window, all openings allowing a direct view of the neighbor. Shall be authorized in all event, woods or concrete of claustras wood or unpolished glass, moving shutters and fixed shutters.

ARTICLE 35. BUILDING TO GROUND RATIO

The constructions ratio as compared to the surface of the lot shall not in any event exceed 75% for the” apartments “and collective living quarters. For residential houses, the constructions to ground ratio shall not exceed 50% of the surface of there are of a lot. The unbuilt area of the lot shall be used for garden with a water absorbed ground on at least half of its area. For building of at least 15 living units, hotels, offices buildings and factories, the construction to ground ratio shall be not exceed 50% of the area of the lot. The Khmer version is the official version of this document.

The unbuilt area of the lot shall be used for garden with a water absorbed ground on at least half of its area. The Municipality and Provincial administrative shall define the urban zones in which this rule shall apply and shall determine special rules for actual situation. The Khmer version is the official version of this document.

CHAPTER 3: CONSTRUCTION SPECIFICATIONS

ARTICLE 39

The construction permits shall be denied if the public health is not insured. Every living or working quarters shall be ventilated and have at least one window. The natural lighting area per living quarters shall be at least 1, 5 square meters.



Appendix D: List of Questionnaire



Questionnaire:

- a). House's address:
- b). Purpose of using the house:
- c). The period of time which the occupant has been living in the house so far:
- d). Sex: Male Female
- e). Age:

1. Do you feel hot of living in row-house?

a). In the day-time

- 3 — Very hot
- 2 — Hot
- 1 — A bit hot
- 0 — Normal
- 1 — A bit cool
- 2 — Cool
- 3 — Very cool

* In case that the doors : Close Open

* In case that the windows: Close Open

b). In the night-time

- 3 — Very hot
- 2 — Hot
- 1 — A bit hot
- 0 — Normal
- 1 — A bit cool
- 2 — Cool
- 3 — Very cool

* In case that the doors : Close Open

* In case that the windows: Close Open

2. Do you feel stuffy of living in row-house?

a). In the day-time

- 1 — Breathe easily
 0 — Breathe normally
 -1 — A bit stuffy
 -2 — Stuffy
 -3 — Very stuffy

* In case that the doors : Close Open

* In case that the windows: Close Open

b). In the night-time

- 1 — Breathe easily
 0 — Breathe normally
 -1 — A bit stuffy
 -2 — Stuffy
 -3 — Very stuffy

* In case that the doors : Close Open

* In case that the windows: Close Open

3. Do you feel the wind blow across inside the house?

a). In the day-time

- 3 — Strongly blowing
 2 — Adequate blowing
 1 — A bit blowing
 0 — Normal (No sensation)
 -1 — No blowing

* In case that the doors : Close Open

* In case that the windows: Close Open

b). In the night-time

- 3 — Strongly blowing
 2 — Adequate blowing
 1 — A bit blowing
 0 — Normal (No sensation)
 -1 — No blowing

* In case that the doors : Close Open

* In case that the windows: Close Open

4. How many story of the house?

1.

2.

3.

4.

5.

5. Does the house consist of mezzanine?

Does

Does not

5.1. What type of mezzanine?

Twin

Front side

Back side

6. What is the house's size?

- Width:.....
- Length:.....
- Height:.....

Others:.....

.....

.....

.....



จุฬาลงกรณ์มหาวิทยาลัย
CHULALONGKORN UNIVERSITY

VITA

Lay Ngeab Heang

#11Eo, St. Sothearos, Chamka Mon, Tonle Basak, Phnom Penh.

Phone Number 017 411 506

Email: layngeabheang@yahoo.com

Personal Data

Sex: Male Nationality: Cambodian

Date of birth: 20/05/1986

Place of birth: Kompong Cham Province

Marital status: Single

Educational and Trainings

Education

2006-2011 : BA in Architecture at Norton University

Phnom Penh, Cambodia

2003-2006 : Senior High School Diploma

: Boeng Kang Kong High School

: Phnom Penh, Cambodia

2000-2003 : Junior High School Diploma

: Boeng Kang Kong High School

: Phnom Penh, Cambodia