

Pharmacognostic Specification and Kaempferol Content of  
*Nelumbo nucifera* Stamens

Miss Naruemon Witheethummasak



บทคัดย่อและแฟ้มข้อมูลฉบับเต็มของวิทยานิพนธ์ตั้งแต่ปีการศึกษา 2554 ที่ให้บริการในคลังปัญญาจุฬาฯ (CUIR)  
เป็นแฟ้มข้อมูลของนิสิตเจ้าของวิทยานิพนธ์ ที่ส่งผ่านทางบัณฑิตวิทยาลัย

The abstract and full text of theses from the academic year 2011 in Chulalongkorn University Intellectual Repository (CUIR)  
are the thesis authors' files submitted through the University Graduate School.

A Thesis Submitted in Partial Fulfillment of the Requirements  
for the Degree of Master of Science Program in Public Health Sciences  
College of Public Health Sciences  
Chulalongkorn University  
Academic Year 2015  
Copyright of Chulalongkorn University

ข้อกำหนดทางเภสัชเวชและปริมาณวิเคราะห์สารเคมีเฟอรอลในเกสรบัวหลวง



วิทยานิพนธ์นี้เป็นส่วนหนึ่งของการศึกษาตามหลักสูตรปริญญาวิทยาศาสตรมหาบัณฑิต

สาขาวิชาวิทยาศาสตร์สาธารณสุข

วิทยาลัยวิทยาศาสตร์สาธารณสุข จุฬาลงกรณ์มหาวิทยาลัย

ปีการศึกษา 2558

ลิขสิทธิ์ของจุฬาลงกรณ์มหาวิทยาลัย

Thesis Title	Pharmacognostic Specification and Kaempferol Content of <i>Nelumbo nucifera</i> Stamens
By	Miss Naruemon Witheethummasak
Field of Study	Public Health Sciences
Thesis Advisor	Assistant Professor Chanida Palanuvej, Ph.D.
Thesis Co-Advisor	Associate Professor Nijisiri Ruangrunsi, Ph.D.

---

Accepted by the College of Public Health Sciences, Chulalongkorn  
University in Partial Fulfillment of the Requirements for the Master's Degree

.....Dean of the College of Public Health Sciences  
(Associate Professor Sathirakorn Pongpanich, Ph.D.)

THESIS COMMITTEE

.....Chairman  
(Assistant Professor Naowarat Kanchanakhan, Ph.D.)

.....Thesis Advisor  
(Assistant Professor Chanida Palanuvej, Ph.D.)

.....Thesis Co-Advisor  
(Associate Professor Nijisiri Ruangrunsi, Ph.D.)

.....External Examiner  
(Chaisak Chansrinियom, Ph.D.)

นฤมล วิธีธรรมศักดิ์ : ข้อกำหนดทางเภสัชเวทและปริมาณวิเคราะห์สารเคมเฟอรอลในเกสรบัวหลวง (Pharmacognostic Specification and Kaempferol Content of *Nelumbo nucifera* Stamens) อ.ที่ปรึกษาวิทยานิพนธ์หลัก: ผศ. ดร. ชนิตา พลาณุเวช, อ.ที่ปรึกษาวิทยานิพนธ์ร่วม: รศ. ดร. นิจศิริ เรืองรังษี, หน้า.

เกสรบัวหลวงเป็นเครื่องยาสมุนไพรที่ใช้ในการแพทย์แผนไทยมาเป็นเวลาช้านาน การศึกษาครั้งนี้มีจุดประสงค์เพื่อจัดทำข้อกำหนดทางเภสัชเวทและวิเคราะห์หาปริมาณสารเคมเฟอรอลของเกสรบัวหลวง 15 จังหวัดในประเทศไทย ประเมินลักษณะทางมหรรณและจุลทรรศน์ของเครื่องยาสมุนไพร ศึกษาคุณสมบัติทางกายภาพเคมีพบว่าเกสรบัวหลวงมีปริมาณที่หายไปเมื่อทำให้แห้ง ปริมาณเถ้ารวม เถ้าที่ไม่ละลายในกรด ปริมาณสารสกัดด้วยน้ำ ปริมาณสารสกัดด้วยเอทานอล และปริมาณน้ำเท่ากับร้อยละ  $8.93 \pm 0.24$ ,  $5.23 \pm 0.12$ ,  $0.91 \pm 0.17$ ,  $10.91 \pm 0.37$ ,  $10.31 \pm 0.31$  และ  $9.89 \pm 0.22$  โดยน้ำหนัก ตามลำดับ วิเคราะห์สารเคมเฟอรอลในสารสกัดเอทานอลของเกสรบัวหลวง ด้วยเทคนิคทินเลเยอร์โครมาโทกราฟีโดยมีแผ่นซิลิกาเจล 60 GF<sub>254</sub> เป็นวัฏภาคคงที่ ใช้ตัวทำละลายโทลูอีน เอทิลอะซิเตต คลอโรฟอร์ม กรดฟอร์มิก (5:4:1:1) วิเคราะห์ปริมาณสารเคมเฟอรอลโดยวิธีทินเลเยอร์โครมาโทกราฟี – เดนซิโตเมตรีโดยใช้เครื่อง CAMAG TLC Scanner3 ร่วมกับโปรแกรม winCATS และวิธีการวิเคราะห์เชิงภาพทางทินเลเยอร์โครมาโทกราฟี โดยใช้โปรแกรม ImageJ สารเคมเฟอรอลในเครื่องยาเกสรบัวหลวงมีปริมาณ  $0.041 \pm 0.013$  และ  $0.045 \pm 0.016$  กรัม/100กรัม โดยวิธีทั้งสองตามลำดับ การเปรียบเทียบปริมาณสารเคมเฟอรอลระหว่างวิธีทั้งสอง โดยใช้สถิติ paired t-test พบว่า ไม่แตกต่างกัน ( $p > 0.05$ ) ค่าตัวแปรของการตรวจสอบความใช้ได้ของวิธีการทดสอบประเมินโดยใช้แนวทางของ ICH guideline จากการตรวจสอบความใช้ได้ของวิธีการทดสอบพบว่าวิธีทินเลเยอร์โครมาโทกราฟี – เดนซิโตเมตรี และการวิเคราะห์เชิงภาพโดยใช้โปรแกรม ImageJ ที่ใช้มีความถูกต้องและมีความน่าเชื่อถือในการวิเคราะห์หาปริมาณสารเคมเฟอรอลในเครื่องยานี้ การศึกษาฤทธิ์ต้านออกซิเดชันด้วยวิธีการต้านอนุมูลอิสระดีพีพีเอชพบว่าสารสกัดจากเกสรบัวหลวงที่สกัดด้วยเอทานอลมีฤทธิ์ที่ดี ( $IC_{50} = 27.31$  ไมโครกรัมต่อมิลลิลิตร) ในการทดสอบของฤทธิ์ต้านไนตริกออกไซด์ พบว่าเกสรบัวหลวงที่สกัดด้วยเอทานอลให้ฤทธิ์ที่ดี ( $IC_{50} = 28.37$  มิลลิกรัมต่อมิลลิลิตร) จากการศึกษาสามารถจัดทำเป็นข้อกำหนดทางเภสัชเวทของสมุนไพรเกสรบัวหลวง ซึ่งจะประโยชน์ต่อการควบคุมคุณภาพวัตถุดิบและสมุนไพรและการศึกษาวิจัยพัฒนาเครื่องยานี้ต่อไป

สาขาวิชา วิทยาศาสตร์สาธารณสุข

ปีการศึกษา 2558

ลายมือชื่อนิสิต .....

ลายมือชื่อ อ.ที่ปรึกษาหลัก .....

ลายมือชื่อ อ.ที่ปรึกษาร่วม .....

# # 5678957553 : MAJOR PUBLIC HEALTH SCIENCES

KEYWORDS: NELUMBO NUCIFERA STAMEN, KAEMPFEROL, NYMPHAEACEAE, TLC-DENSITOMETRY, TLC-IMAGE ANALYSIS, DPPH, NITRIC OXIDE

NARUEMON WITHEETHUMMASAK: Pharmacognostic Specification and Kaempferol Content of *Nelumbo nucifera* Stamens. ADVISOR: ASST. PROF. CHANIDA PALANUVEJ, Ph.D., CO-ADVISOR: ASSOC. PROF. NIJSIRI RUANGRUNGSI, Ph.D., pp.

*Nelumbo nucifera* stamens have been used in traditional Thai medicine for a long time. This study was carried out to develop the pharmacognostic specifications by qualitative and quantitative analyses as well as kaempferol contents of *Nelumbo nucifera* stamens. The samples were collected from 15 different sources throughout Thailand. Macroscopic and microscopic characteristics of crude drug were illustrated. The physicochemical parameters of *Nelumbo nucifera* stamens including loss on drying, total ash, acid-insoluble ash, water soluble extractives, ethanol soluble extractives and moisture were found to be  $8.93\pm 0.24$ ,  $5.23\pm 0.12$ ,  $0.91\pm 0.17$ ,  $10.91\pm 0.37$ ,  $10.31\pm 0.31$  and  $9.89\pm 0.22$  % by weight, respectively. Kaempferol in ethanolic extract of *Nelumbo nucifera* stamens were analyzed by thin layer chromatography (TLC) using silica gel 60 GF<sub>254</sub> as stationary phase. Toluene, ethyl acetate, chloroform and formic acid (5:4:1:1) were used as mobile phase. The kaempferol contents were evaluated by TLC-densitometry with winCATS software and TLC-image analysis using imageJ software. The kaempferol contents in *Nelumbo nucifera* stamen crude drugs were found to be  $0.041\pm 0.013$  and  $0.045\pm 0.016$  g/100 g by those methods respectively. It was found that kaempferol contents by both methods were not statistically significant different by paired t-test ( $p>0.05$ ). The method validations were investigated according to ICH guideline. The free radical scavenging potentials of the ethanolic extract of *Nelumbo nucifera* stamens were demonstrated with the IC<sub>50</sub> of 27.31 µg/ml for DPPH and 28.37 mg/ml for nitric oxide. This study provided scientific evidences for identification, authentication and quality control of *Nelumbo nucifera* stamens crude drug.

Field of Study: Public Health Sciences

Academic Year: 2015

Student's Signature .....

Advisor's Signature .....

Co-Advisor's Signature .....

## ACKNOWLEDGEMENTS

The author wishes to express her heartily gratitude and appreciation to her thesis advisor, Assistant Professor Dr. Chanida Palanuvej, for her guidance, suggestion, and support throughout the course of this study.

The author is sincerely grateful to her thesis co-advisor, Associate Professor Dr. Nijsiri Ruangrunsi, for his kindness and valuable suggestion to complete the study.

Gratitude is grateful to the thesis committee members, Dr. Chaisak Chansriniyom and Assistant Professor Dr. Naowarat Kanchanakhan for their important and constructive suggestion in finalizing this thesis.

Appreciation is also extended to College of Public Health Sciences, Chulalongkorn University and all staff members for necessary assistance and instrumental support.

The author also wishes to express her special thanks to Mr. Worathat Thitikornpong from Drugs and Health Product Innovation Promotion Center, Faculty of Pharmaceutical Sciences, Chulalongkorn University for providing research facilities and his kind assistance in techniques of TLC-densitometry throughout this study.

The author's final thank you to my family, especially her dear parents for their love, encourage, and support me to concentrate on me study.

## CONTENTS

	Page
THAI ABSTRACT .....	iv
ENGLISH ABSTRACT .....	v
ACKNOWLEDGEMENTS .....	vi
CONTENTS .....	vii
LIST OF TABLES .....	xi
LIST OF FIGURES.....	xiii
LIST OF ABBREVIATIONS .....	xvi
CHAPTER I INTRODUCTION.....	1
Background and rationale .....	1
Research gaps .....	3
Objectives.....	4
CHAPTER II LITERATURE REVIEWS.....	6
Taxonomy.....	6
Description of <i>Nelumbo nucifera</i> Gaertn.....	7
Medicinal uses .....	8
Biological activities of <i>N. nucifera</i> .....	9
Antioxidant activity .....	9
Antipyretic activity .....	9
Aldose reductase inhibitory activity.....	10
Antimicrobial activity.....	10
Diuretic activity.....	11
Anti-inflammatory activity.....	11

	Page
Anti-ischemic activity .....	11
Kaempferol.....	13
Kaempferol and distribution.....	14
Biological activities of kaempferol .....	14
Anti-oxidant and anti-inflammatory effects .....	14
Anti-cancer effect .....	15
Quality control method for herbal materials .....	16
Macroscopic and microscopic examinations.....	16
Determination of water content.....	17
Determination of loss on drying .....	19
Determination of total ash and acid insoluble ash.....	19
Determination of volatile oil.....	19
Determination of solvent extractive values.....	21
Thin layer chromatographic identification (TLC) .....	21
Retention factor .....	22
Quantitative analysis of kaempferol in <i>N. nucifera stamen</i> .....	22
TLC densitometry .....	23
Image analysis.....	23
Efficacy evaluation: Antioxidant activities testing.....	24
Free radicals.....	24
Free radicals in oxygen atom's group.....	26
Free radicals in nitrogen atom's group.....	28
Antioxidants .....	29



	Page
DPPH radical scavenging assay.....	30
Nitric oxide radical scavenging assay.....	31
CHAPTER III MATERIALS AND METHODOLOGY .....	32
Chemicals .....	32
Materials.....	32
Instrument and equipments.....	33
Materials and methods.....	35
Plants Material.....	35
Standardization of <i>N. nucifera</i> stamens.....	35
Macroscopic evaluation.....	35
Microscopic evaluation.....	35
Determination of loss on drying .....	36
Determination of total ash .....	36
Determination of alcohol soluble extractive value.....	37
Thin layer chromatographic fingerprint.....	38
Quantitative analysis of kaempferol contents by TLC-densitometry .....	38
Preparation of kaempferol solutions.....	38
Preparation of ethanol extracts of <i>N. nucifera</i> stamens .....	38
TLC densitometry .....	39
TLC image analysis by ImageJ software .....	39
Method validation.....	39
Specificity.....	39
Linearity .....	40

	Page
Limit of detection .....	40
Limit of quantitation .....	40
Accuracy .....	41
Precision.....	41
Robustness.....	42
Antioxidant activities .....	42
DPPH radical scavenging assay.....	42
Nitric oxide radical scavenging assay .....	43
Data analysis .....	43
Benefits and applications .....	44
CHAPTER IV RESULTS .....	45
<i>Nelumbo nucifera</i> stamens .....	45
Macroscopic examination.....	45
Microscopic examination.....	47
Physicochemical evaluation .....	49
Quantitative analysis of kaempferol contents of <i>N. nucifera</i> stamens by TLC densitometry .....	53
Method validation .....	53
Quantitative analysis of kaempferol contents of <i>N. nucifera</i> stamens by TLC image analysis .....	61
Method validation .....	61
The comparison of kaempferol contents between TLC densitometry and TLC image analysis.....	66
Antioxidant activities .....	67

	Page
DPPH radical scavenging assay.....	67
Nitric oxide radical scavenging assay .....	70
CHAPTER V DISCUSSION AND CONCLUSION.....	72
APPENDIX A .....	78
APPENDIX B .....	91
APPENDIX C .....	103
.....	108
REFERENCES .....	108
VITA.....	114



## LIST OF TABLES

<b>Table 1</b> Free radicals .....	25
<b>Table 2</b> Physicochemical specifications of <i>N. nucifera</i> stamens .....	49
<b>Table 3</b> $R_f$ values of chemical components in the ethanolic extract of <i>N. nucifera</i> stamens developed by chloroform: methanol.....	51
<b>Table 4</b> The percent yields of ethanolic extract of <i>N. nucifera</i> stamen crude drug from 15 sources in Thailand.....	52
<b>Table 5</b> Kaempferol contents in <i>N. nucifera</i> stamens from 15 different sources throughout Thailand by TLC densitometry .....	54
<b>Table 6</b> Accuracy of quantitation of kaempferol in <i>N. nucifera</i> stamens by TLC densitometry (n=3).....	56
<b>Table 7</b> Repeatability and intermediate precision of kaempferol in <i>N. nucifera</i> stamens by TLC densitometry (n=3) .....	57
<b>Table 8</b> Robustness investigation of kaempferol in <i>N. nucifera</i> stamens by TLC densitometry .....	60
<b>Table 9</b> Kaempferol contents in <i>N. nucifera</i> stamen from 15 different sources throughout Thailand by TLC image analysis.....	62
<b>Table 10</b> Accuracy of quantitation of kaempferol in <i>N. nucifera</i> stamens by TLC image analysis (n=3).....	63
<b>Table 11</b> Repeatability and intermediate precision of kaempferol in <i>N. nucifera</i> stamens by TLC image analysis method (n=3) .....	64
<b>Table 12</b> Robustness investigation of kaempferol in <i>N. nucifera</i> stamens by TLC image analysis.....	65
<b>Table 13</b> The comparison of kaempferol contents between TLC densitometry and TLC image analysis .....	66

<b>Table 14</b> Determination of water content of <i>N. nucifera</i> stamens from 15 different sources .....	79
<b>Table 15</b> Determination of loss on drying of <i>N. nucifera</i> stamens from 15 different sources .....	81
<b>Table 16</b> Determination of total ash of <i>N. nucifera</i> stamens from 15 different sources .....	83
<b>Table 17</b> Determination of acid insoluble ash of <i>N. nucifera</i> stamens from 15 different sources .....	85
<b>Table 18</b> Determination of ethanol-soluble extractive (% by weight) of <i>N. nucifera</i> stamens from 15 different sources.....	87
<b>Table 19</b> Determination of water-soluble extractive (% by weight) of <i>N. nucifera</i> stamens from 15 different sources .....	89
<b>Table 20</b> DPPH scavenging activity of ethanolic extract of <i>N. nucifera</i> stamen.....	104
<b>Table 21</b> DPPH scavenging activity of positive control (quercetin).....	104
<b>Table 22</b> DPPH scavenging activity of positive control (ascorbic acid) .....	105
<b>Table 23</b> DPPH scavenging activity of positive control (BHT).....	105
<b>Table 24</b> DPPH scavenging activity of positive control (kaempferol) .....	106
<b>Table 25</b> Nitric oxide radical inhibition activity of ethanolic extract of <i>N. nucifera</i> stamen .....	106
<b>Table 26</b> Nitric oxide radical inhibition activity of positive control (quercetin).....	107
<b>Table 27</b> Nitric oxide radical inhibition activity of positive control (kaempferol) .....	107

## LIST OF FIGURES

<b>Figure 1</b> <i>Nelumbo nucifera</i> Gaertn.....	7
<b>Figure 2</b> Structure of kaempferol .....	13
<b>Figure 3</b> Dried leaves of <i>N. nucifera</i> .....	16
<b>Figure 4</b> Transverse section of <i>Nelumbo nucifera</i> leaf.....	17
<b>Figure 5</b> Azeotropic apparatus for determination of water content (dimensions in mm), (A) a glass flask, (B) a cylindrical tube, (C) a reflux condenser, (D) a receiving tube, (E) a graduated receiving tube .....	18
<b>Figure 6</b> Cleverger apparatus for determination of volatile oil content (dimensions in mm), (AC) a vertical tube, (CDE) a bent tube, (FG) a bulb-condenser, (GH) a tube, (HK) a side-arm tube, (K) a tube and (K') a vented ground-glass stopper, (J) a pear-shaped bulb with a volume of 3 ml, (JL) a tube with a volume of 1 ml, (L) a bulb-like swelling with a volume of about 2 ml, (M) a three-way tap, (BM) a connecting tube (N) a security tube.....	20
<b>Figure 7</b> The formation of free radicals.....	29
<b>Figure 8</b> DPPH and antioxidant reaction .....	30
<b>Figure 9</b> The Griess test reaction .....	31
<b>Figure 10</b> <i>Nelumbo nucifera</i> stamen crude drug.....	45
<b>Figure 11</b> <i>Nelumbo nucifera</i> Gaertn. ....	46
<b>Figure 12</b> Histological characters of the stamen of <i>Nelumbo nucifera</i> Gaertn. ....	47
<b>Figure 13</b> Transverse section of the stamen of <i>Nelumbo nucifera</i> Gaertn. ....	48
<b>Figure 14</b> TLC fingerprint of <i>N. nucifera</i> stamen ethanolic extract.....	50
<b>Figure 15</b> The calibration curve of kaempferol by TLC densitometric method.....	55
<b>Figure 16</b> Absorbance spectra of 6 kaempferol standards and 15 ethanolic extracts of <i>N. nucifera</i> stamens.....	58
<b>Figure 17</b> Absorbance spectra of kaempferol standard in ethanolic extract using up-slope, apex and down-slope of the peak.....	59
<b>Figure 18</b> The calibration curve of kaempferol by TLC image analysis.....	61
<b>Figure 19</b> Percent DPPH inhibition of <i>N. nucifera</i> stamens.....	67

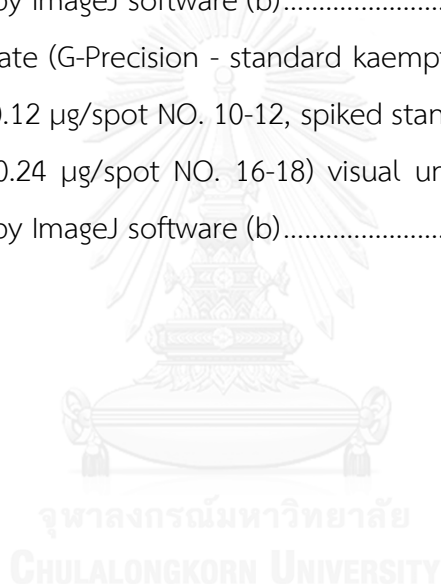
<b>Figure 20</b> Percent DPPH inhibition of quercetin.....	68
<b>Figure 21</b> Percent DPPH inhibition of ascorbic acid.....	68
<b>Figure 22</b> Percent DPPH inhibition of BHT.....	69
<b>Figure 23</b> Percent DPPH inhibition of kaempferol.....	69
<b>Figure 24</b> Percent nitric oxide inhibition of <i>N. nucifera</i> stamens.....	70
<b>Figure 25</b> Percent nitric oxide inhibition of quercetin.....	71
<b>Figure 26</b> Percent nitric oxide inhibition of kaempferol.....	71
<b>Figure 27</b> 3D TLC- densitometry chromatogram.....	92
<b>Figure 28</b> 3D TLC- densitometry chromatogram.....	92
<b>Figure 29</b> 3D TLC- densitometry chromatogram.....	93
<b>Figure 30</b> 3D TLC-densitometry chromatogram (Plate D-Accuracy - standard kaempferol NO. 1-6, sample NO. 7-9, spiked standard 0.12 µg/spot NO. 10-12, spiked standard 0.18 µg/spot NO. 13-15, spiked standard 0.24 µg/spot NO. 16-18)....	93
<b>Figure 31</b> 3D TLC- densitometry chromatogram (Plate E-Precision NO.1 - standard kaempferol NO. 1-6, sample NO. 7-9, spiked standard 0.12 µg/spot NO. 10-12, spiked standard 0.18 µg/spot NO. 13-15, spiked standard 0.24 µg/spot NO. 16-18)....	94
<b>Figure 32</b> 3D TLC- densitometry chromatogram (Plate F-Precision NO. 2 - standard kaempferol NO. 1-6, sample NO. 7-9, spiked standard 0.12 µg/spot NO. 10-12, spiked standard 0.18 µg/spot NO. 13-15, spiked standard 0.24 µg/spot NO. 16-18)....	94
<b>Figure 33</b> 3D TLC- densitometry chromatogram (Plate G-Precision NO. 3 - standard kaempferol NO. 1-6, sample NO. 7-9, spiked standard 0.12 µg/spot NO. 10-12, spiked standard 0.18 µg/spot NO. 13-15, spiked standard 0.24 µg/spot NO. 16-18).....	95
<b>Figure 34</b> The TLC Plate (A- standard kaempferol NO. 1-6, sample NO. 7-21) visual under UV 254 nm (a), with subtract background by ImageJ software (b).....	96
<b>Figure 35</b> The TLC Plate (B- standard kaempferol NO. 1-6, sample NO. 7-21) visual under UV 254 nm (a), with subtract background by ImageJ software (b).....	97
<b>Figure 36</b> The TLC Plate (C- standard kaempferol NO. 1-6, sample NO. 7-15) visual under UV 254 nm (a), with subtract background by ImageJ software (b).....	98
<b>Figure 37</b> The TLC Plate (D-Accuracy - standard kaempferol NO. 1-6, sample NO. 7-9, spiked standard 0.12 µg/spot NO. 10-12, spiked standard 0.18 µg/spot NO. 13-	

15, spiked standard 0.24  $\mu\text{g}/\text{spot}$  NO. 16-18) visual under UV 254 nm (a), with subtract background by ImageJ software (b)..... 99

**Figure 38** The TLC Plate (E-Precision - standard kaempferol NO. 1-6, sample NO. 7-9, spiked standard 0.12  $\mu\text{g}/\text{spot}$  NO. 10-12, spiked standard 0.18  $\mu\text{g}/\text{spot}$  NO. 13-15, spiked standard 0.24  $\mu\text{g}/\text{spot}$  NO. 16-18) visual under UV 254 nm (a), with subtract background by ImageJ software (b)..... 100

**Figure 39** The TLC Plate (F-Precision - standard kaempferol NO. 1-6, sample NO. 7-9, spiked standard 0.12  $\mu\text{g}/\text{spot}$  NO. 10-12, spiked standard 0.18  $\mu\text{g}/\text{spot}$  NO. 13-15, spiked standard 0.24  $\mu\text{g}/\text{spot}$  NO. 16-18) visual under UV 254 nm (a), with subtract background by ImageJ software (b)..... 101

**Figure 40** The TLC Plate (G-Precision - standard kaempferol NO. 1-6, sample NO. 7-9, spiked standard 0.12  $\mu\text{g}/\text{spot}$  NO. 10-12, spiked standard 0.18  $\mu\text{g}/\text{spot}$  NO. 13-15, spiked standard 0.24  $\mu\text{g}/\text{spot}$  NO. 16-18) visual under UV 254 nm (a), with subtract background by ImageJ software (b)..... 102





## LIST OF ABBREVIATIONS

%	=	Percent
°C	=	Degree Celsius
cm	=	Centimeter
EC <sub>50</sub>	=	Fifty percent effective concentration
g	=	Gram
g/mol	=	Gram per mole
GC	=	Gas chromatography
HPLC	=	High performance liquid chromatography
ICH	=	The international conference on Harmonization of Technical Requirements for Registration of Pharmaceuticals for Human Use
Kg	=	Kilogram
LOD	=	Limit of detection
LOQ	=	Limit of quantification
M	=	Meter
mg	=	Milligram

mg/kg	=	Milligram per kilogram
mg/ml	=	Milligram per milliliter
min	=	Minute
ml	=	Milliliter
ml/kg	=	Milliliter per kilogram
mm	=	Millimeter
mm <sup>2</sup>	=	Square Millimeter
nm	=	Nanometer
Rf	=	Retention factor
RSD	=	Relative standard deviation
TLC	=	Thin layer chromatography
UV	=	Ultraviolet
WHO	=	World Health Organization
µg/ml	=	Microliter
σ	=	Sigma

# CHAPTER I

## INTRODUCTION

### Background and rationale

Herbal medicines have been used for a long time in Thai culture for prevention and treatment of diseases. All parts of plants can be used in traditional medicine for treatment of human illnesses e.g. fever, cough, dysentery, smallpox, epistaxis, haematemesis, cholera, hepatopathy, leucoderma and other diseases [1]. Several years ago, human interested in a healthy and using herbal medicine to treat the disease as well. Treatment and interruption of the disease occurred or chronic illnesses that herbal medicines are famous and recognized in Thailand. Assessment and determination of quality, efficacy and safety become significant for herbal products. The quality control refers to all procedures method under taken to endorse the purity and identity of a reliable herbal pharmaceutical products. The World Health Organization (WHO) promotes standardization and quality control of herbal materials with analytical techniques [2].

*Nelumbo nucifera* Gaertn., normally known as sacred lotus or lotus, is an aquatic perennial plant in Nelumbonaceae family. The genus *Nelumbo* is illustrated by two species, *Nelumbo lutea* and *Nelumbo nucifera*. *N. nucifera* is widely distributed in South-East Asia, China, Japan, India and Australia [3]. In Thailand, common name of *N. nucifera* is Bua-Luang. All parts of this plant have many medicinal uses. In Ayurveda, this plant is used as an anthelmintics, antipyretics, a remedy for skin diseases, cancer, hypotensive and stomachic. The flower of *N. nucifera* is large 10-25 cm in diameter, pinkish white, pink, white, peduncles and fragrant have arising from the nodes for the rhizome, and 1-2 cm deep sheathing on the base. The stamens, petals and sepals are spirally organized, passing constantly one into others [4]. Lotus flowers are traditionally used to treat cholera, fever, hepatopathy, bleeding and hyperdipsia. The stalks of flower have been used for the treatment of bleeding gastric ulcers, excessive menstruation and post-partum haemorrhage. The honey of lotus is used for the cure of eye infections [5]. The leaves can be effective against skin inflammation, weakness, hemoptysis and hematuria. *N. nucifera* leaves have been reported for anti-obesity and hypocholesterolemic activity. Lotus seed powders in traditional medicine are used as cold remedy and spleen tonic. The seed extract have been reported for anti-fibrosis, astringent and free radical scavenging [6].

Flavonoids are a large family of polyphenolic compounds synthesized in plants. They can be found in vegetables, tea, legumes and in many dietary supplements or herbal remedies and as Milk Thistle and *Ginkgo Biloba*. The flavonoids have six classes including chalcones, flavones, flavonols, flavanones, flavanols, anthocyanins [7].

Kaempferol, a flavonoids is also a polyphenol antioxidant substance found in vegetables and fruits for example, onions, berries, cocoa, green tea and other herbs [8].

Pharmacological study indicates that kaempferol has many benefits for example, antiallergic, antimicrobial, antidiabetic, analgesic, anxiolytic, antiosteoporotic, anticancer, cardioprotective and antioxidation activities [7, 9].

Medicinal plant materials can be adulterated with other plant parts or matters resulting in low quality. There are no pharmacognostic specifications accessible for the standardization of this medicinal plant. The quality of herbal medicine is significant, then the study implicate the qualitative and quantitative analyses of *N. nucifera* to the unique allusion and reference to kaempferol marker.

### **Research gaps**

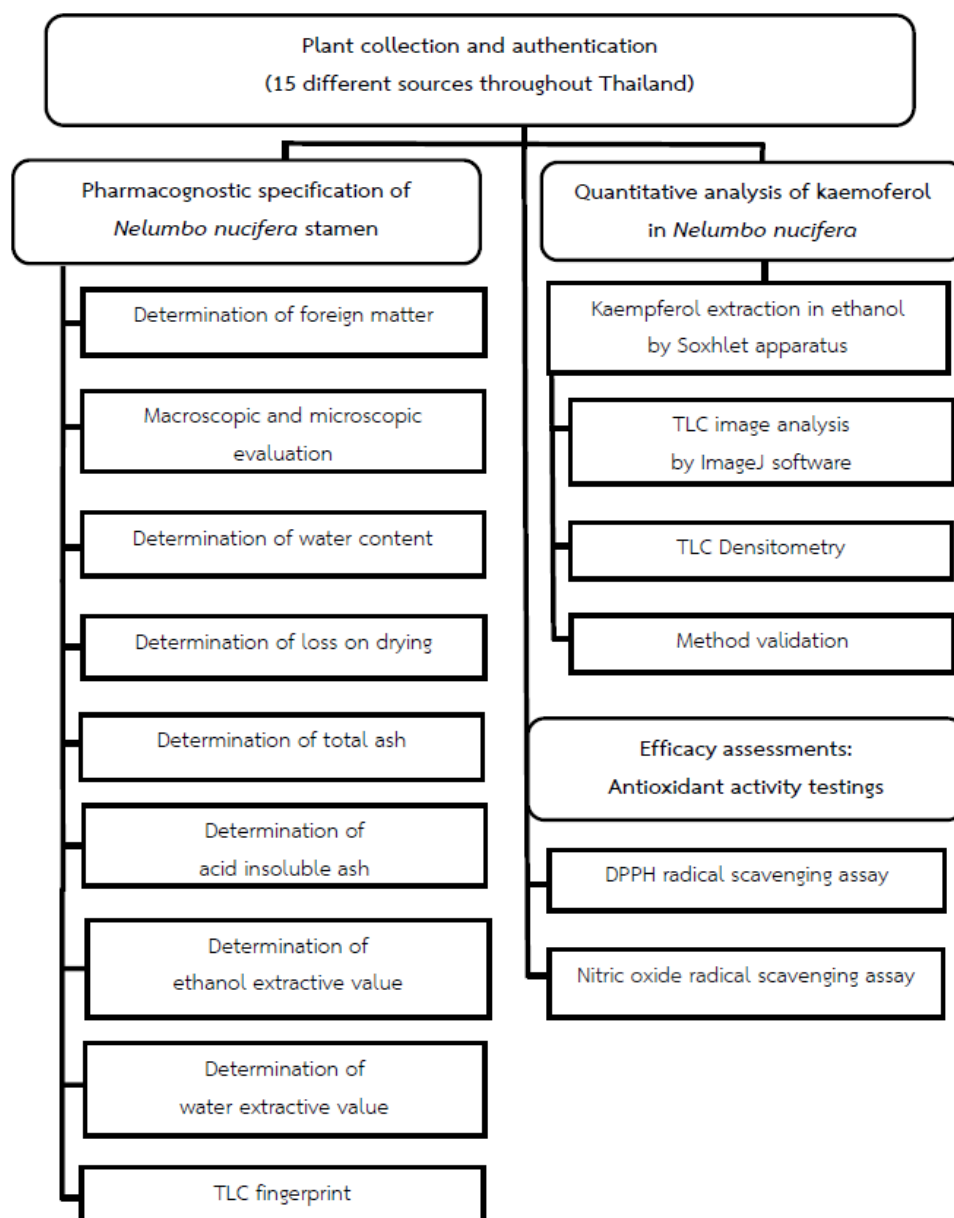
The quality parameters and kaempferol content of *N. nucifera* stamen crude drug in Thailand have never been determined and the scientific documentation of antioxidant activity of *N. nucifera* stamens has less been examined also.

## Objectives

1. To develop the standardization parameters of *N. nucifera* stamen crude drug.
2. To investigate the content of kaempferol in *N. nucifera* stamens by TLC image analysis using ImageJ free software compared to TLC densitometry.
3. To evaluate the antioxidant activities of *N. nucifera* stamens.



## Conceptual framework



## CHAPTER II

### LITERATURE REVIEWS

#### Taxonomy [10]

Kingdom: Plantae

Division: Tracheophyta

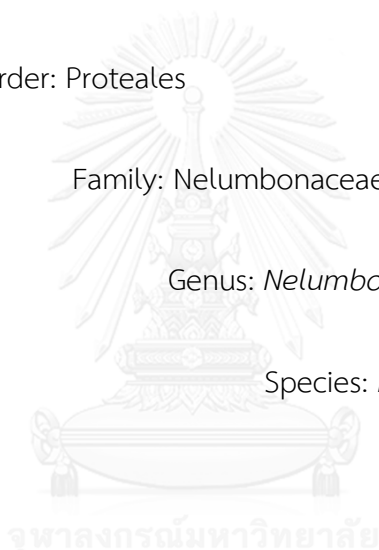
Class: Magnoliopsida

Order: Proteales

Family: Nelumbonaceae

Genus: *Nelumbo*

Species: *Nelumbo nucifera* Gaertn.



**Common names:** Sacred lotus, Lotus, Indian lotus, Bua-Luang (Thailand)

**Family:** Nelumbonaceae

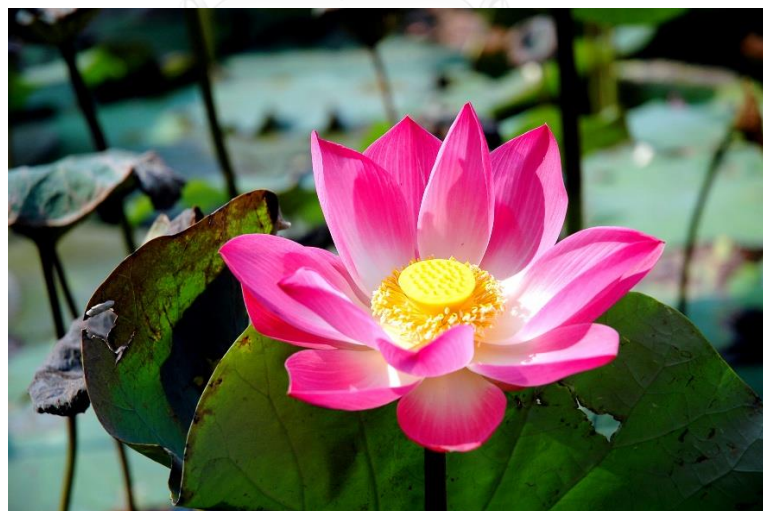
**Synonyms:** *Nelumbium nelumbo* (Linn.) Druce, *Nelumbium speciosum* Willd., *Nelumbo speciose* Willd.

**Distribution:** *N. nucifera* is native to eastern Asia. This species has been cultivated since ancient times therefore its native distribution, prior to human influence, is difficult to be determined. [11, 12].



### Description of *Nelumbo nucifera* Gaertn.

*Petiole 1-2 m, terete, fistulous, glabrous or papillae hard and scattered; leaf blade abaxially blue-green, orbicular, 25-90 cm in diam., papery, glabrous, glaucous, water-repellent, margin entire. Flowers 10-23 cm in diam.; peduncles longer than petioles, glabrous or sparsely spinulate. Tepals caducous, pink or white, oblong-elliptic to obovate, 5-10 × 3-5 cm. Stamens slightly longer than receptacle; filament slender; anther linear, 1-2 mm; connective appendage clavate, to 7 mm, incurved. Receptacle accrescent, turbinate, 5-10 cm in diam. Fruit oblong to ovoid, 1.0-2.0 × 7-15 cm, glabrous; pericarp thick, hardened [11].*



**Figure 1** *Nelumbo nucifera* Gaertn.

### Medicinal uses

The sacred of lotus has been used indigenous system with medicine. A decoction of the flowers was used in the remedy of premature ejaculation. A decoction of the floral receptacle was used in the remedy of bloody discharges and abdominal cramps [13]. Antioxidant activity of many parts of *N. nucifera* was well found including leaf, rhizomes and stamens [14]. All parts of *N. nucifera* were used to treat many diseases. The rhizomes and leaves were used for fever, dizziness, vomiting of blood, sunstroke and hemorrhoids. Seeds were used to cure diarrhea, indigestion, cholera (Chinese) and insomnia. Flowers were used for syphilis, cosmetic unguents, the flower stalk with other herb to treat bleeding from the uterus and post-partum hemorrhage [15]. The honey in lotus was used to treat eye infections [16].

In India, *N. nucifera* stamens have been used in fever, hyperdipsia, diarrhea, bleeding disorders and cholera treatment [17]. In Chinese and Singapore, they have been used for treating syphilis and as cosmetics. In Thailand, *N. nucifera* stamens have been used in Ya-Hom remedies such as Inthajak, Nawakot, Teppajit and Tiposod [18]. Thai people use them as heart tonic and drink stamen tea to treat fever, stomach ulcers, bleeding gastric ulcer and use as diuretics [19-23]. Antioxidant activity of many parts of *N. nucifera* were found such as leaves [24], rhizomes and stamens [14].

### **Biological activities of *N. nucifera***

*N. nucifera* has been reported for many chemical components for example, flavonoids and alkaloids.

#### **Antioxidant activity**

Jung *et al.*, 2003 reported the potential of *N. nucifera* stamens on the scavenging of peroxynitrites (ONOO<sup>-</sup>) and DPPH free radicals, inhibition of total ROS generation by kidney homogenates using 2', 7' dichlorodihydrofluorescein diacetate. The potential of *N. nucifera* stamen methanolic extract demonstrated marginal activity in the DPPH and strong antioxidant activity in the ONOO<sup>-</sup> system and total ROS systems. *N. nucifera* has been reported to have antioxidant activity [25].

Yang and coworkers reported antioxidant activity of *N. nucifera* rhizome methanolic extract and *acetonic* extract by the  $\beta$ -carotene bleaching assay and DPPH assay. The results showed that *N. nucifera* rhizome had highest DPPH scavenging activity [26].

#### **Antipyretic activity**

*N. nucifera* stalk extracts were examined for the antipyretic potential on normal body temperature and yeast-induced pyrexia in rats. The stalk extracts showed important activity in both models at oral doses of 200 and 400 mg/kg. For yeast-provoked pyrexia, the extracts demonstrated dose-dependent lowering of body temperature up to 4 hr. The results were commensurate to those with paracetamol [27].

The methanolic extract of *N. nucifera* rhizome demonstrated antipyretic activity in rats by yeast-induced pyrexia. The extract at 200, 300 and 400 mg/kg demonstrated significant dose-dependent lowering of normal body temperature. The result was commensurate to that of the standard antipyretic drug, paracetamol (150 mg/kg) to the injection of a substance into the peritoneum or IP injection [3].

#### **Aldose reductase inhibitory activity**

Isorhamnetin 3-O- $\alpha$ -L-rhamnopyranosyl-(1 $\rightarrow$ 6)- $\beta$ -D-glucopyranoside and kaempferol 3-O- $\alpha$ -L-rhamnopyranosyl-(1 $\rightarrow$ 6)- $\beta$ -D-glucopyranoside, separated from the methanol extract of *N. nucifera* stamens showed a high grade of inhibitory activity with rat lens aldose reductase *in vitro*, with IC<sub>50</sub> values of 5.6 and 9.0  $\mu$ M respectively [28].

#### **Antimicrobial activity**

*N. nucifera* rhizome extract by chloroform exhibited significant antibacterial effects against *Bacillus subtilis*, *Escherichia coli*, *Staphylococcus aureus*, *Pseudomonas aeruginosa* and *Bacillus pumilus* [29]. Anti-yeast and anti-fungal activities of the rhizome extract were appraised against 4 different strains of yeast and fungi, including *Trichophytum mentagopyhtes*, *Aspergillus fumigatus*, *Aspergillus niger* and *Candida albicans*; the extract demonstrated potential activity in all strains tested [30].

### **Diuretic activity**

Mukherjee and co-workers reported diuretic activity of methanolic extract from *N. nucifera* rhizome. The methanolic extract showed the dose dependence at the concentration of 300, 400 and 500 mg/kg.

There was a dose-dependent increase in the volume of urine, with  $\text{Cl}^-$  excretion and  $\text{Na}^+$  excretion, accompanied with an important excretion of  $\text{K}^+$ . The increase in amount of urine was fewer than with the standard diuretic, Furosemide (20 mg/kg) [31].

### **Anti-inflammatory activity**

Mukherjee and co-workers presented anti-inflammatory activity using *in vitro* model of methanolic extract from *N. nucifera* rhizome which showed the effective doses of 200 and 400 mg/kg when compared to the standard drugs dexamethasone and phenylbutazone [32].

### **Anti-ischemic activity**

*N. nucifera* seed extract showed potent anti-ischemic effect in the isolated rat heart. The effect of seed extract on ischemia induced isolated rat heart was estimated by measuring cardiac output; amounts of 0.1–30 mg/ml were tested. A dose of maximal recovery was 10 mg/ml, while cardiac output was similar after treatment with 3 or 10 mg/ml doses ( $63.5 \pm 3.2$  and  $65.8 \pm 4.0$  ml/min, respectively).

Consequently, the 3 mg/ml dose was resolved to be the optimum dose *versus* anti-ischemic effects in the rat [33].



## Kaempferol

**IUPAC Name:** 3, 5, 7-trihydroxy-2-(4-hydroxyphenyl)-4H-1-benzopyran-4-one

**Synonyms:** Nimbecetin, NSC 407289, NSC 656277, Pelargidenon, Rhamnolutein, Swartziol, Trifolitin

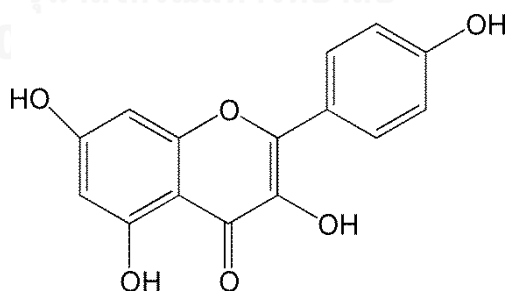
**Molecular Formular:** C<sub>15</sub>H<sub>10</sub>O<sub>6</sub>

**Molecular weight:** 286.2

**UV/VIS:**  $\lambda_{\text{max}}$ : 204, 267, 368 nm.

**Description:** Yellow powder

**Solubility:** soluble in organic solvents such as, ethanol, DMSO and dimethylformamide, which should be purged with an inert gas.



**Figure 2** Structure of kaempferol

## **Kaempferol and distribution**

Kaempferol or nimbecetin is a flavonoid which is various in an individuality of fruits and vegetables. Kaempferol is also a polyphenol antioxidant. Kaempferol is found in many natural sources including leeks, apple, citrus, ginkgo biloba, red wines and grapes [34]. Kaempferol can be isolated from broccoli, grapefruit and is a naturally in a variety of vegetables and fruits [35]. In plants, kaempferol is commonly found as glycoside form, which determines their pharmacokinetic properties and it has been estimated in small amount from flowers, seeds and leaf [8].

## **Biological activities of kaempferol**

### **Anti-oxidant and anti-inflammatory effects**

Numerous studies have presented that extensive oxidative stress can direct to chronic inflammation, results in diseases for example cancer, neurological disorders and cardiovascular [36]. Chronic inflammatory conditions for example, *Helicobacter pylori* infection and Hepatitis B viruses have been correlated to hepatocellular carcinoma and gastric cancer respectively [37].

Kaempferol has been described to decrease the brain damage induced by ischemia and reperfusion in rats [38]. In a previous study, the authors demonstrated that kaempferol decreased ROS levels induced by lipopolysaccharide in RAW264.7 rat macrophages, and palliated the bladder hyperactivity induced by potassium chloride after protamine sulfate-induced bladder risk [39].



### Anti-cancer effect

Many *in vitro* and *in vivo* studies reported that kaempferol could prevent carcinogenesis and inhibit tumor through disparate molecular mechanisms. Kaempferol has been demonstrated its inhibition activity on cancer cell growth by *in vitro* study using Caco-2 cell line (human colorectal adenocarcinoma) [40].

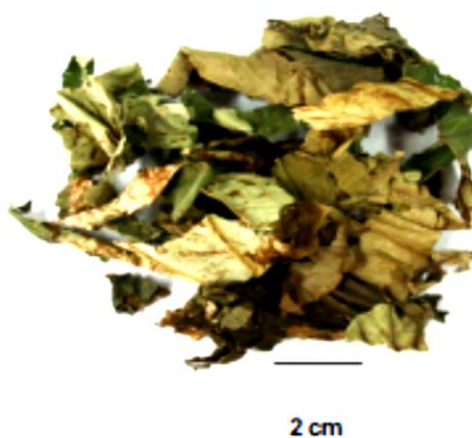


## Quality control method for herbal materials [2]

Pharmacognostic parameters are following World Health Organization (WHO) guideline that describes much information of analytical tests with evaluation of the quality of plant materials. The following methods aim to investigate the quality of herbal materials with analytical techniques.

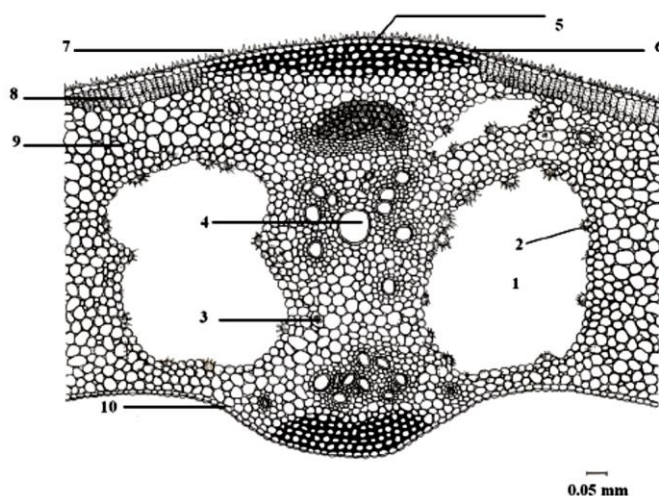
### Macroscopic and microscopic examinations

Macroscopic examination of herbal materials is the assessment of herbal materials by size, shape, color, teste, odor etc. The evaluation process is simple and quick means to determine the identity and purity of sample.



**Figure 3** Dried leaves of *N. nucifera* [41]

Microscopic examination is the observation of tissue and cell structures of herbs which is based on the knowledge in plant histology and anatomy to ensure or authenticate plants and plant parts.

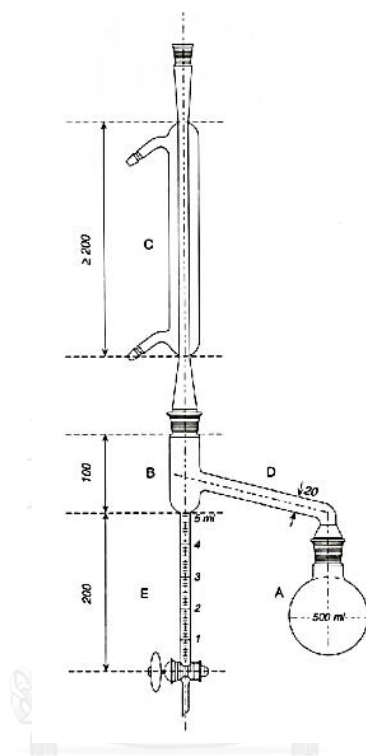


**Figure 4** Transverse section of *Nelumbo nucifera* leaf: 1. air chamber 2. trichosclereid 3. calcium oxalate 4. xylem vessel 5. collenchyma 6. upper epidermis 7. Trichome 8. palisade cell 9. parenchyma 10. lower epidermis [41]

#### Determination of water content

This constant parameter is significant for plant material specification. An excess of water in herbal materials will encourage microbial growth, the presence of insects and fungi and measurement following hydrolysis. The azeotropic method provides a direct assessment of the water present in the material being investigated. The sample is distilled with a water immiscible solvent for example toluene or

xylene, the water and solvent are distilled at the same time and separated in the obtaining tube on cooling. The solvent ought to be saturated with water before use to evade water absorption in solvent.



**Figure 5** Azeotropic apparatus for determination of water content (dimensions in mm), (A) a glass flask, (B) a cylindrical tube, (C) a reflux condenser, (D) a receiving tube, (E) a graduated receiving tube [2]

### **Determination of loss on drying**

The loss on drying determines both water and volatile matters. Drying can be carried out each by heating to 100-105 °C or in desiccator. The desiccation method is particularly convenient for materials that crumble to cohesive mass at elevated temperatures.

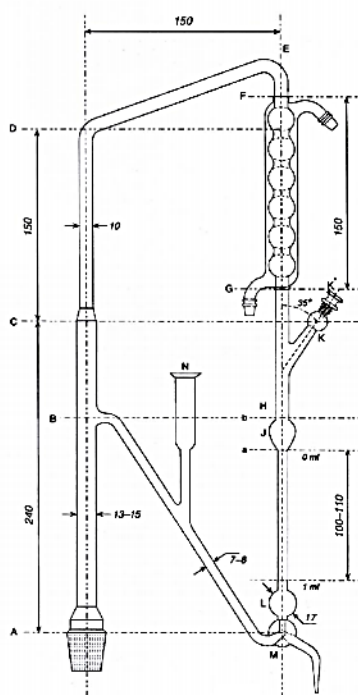
### **Determination of total ash and acid insoluble ash**

Ash values are helpful in determination of the purity and quality of plant materials. Total ash is determined to measure the total amount of inorganic components in remaining herbal materials after complete incineration at about 500 °C. Contamination or adulteration with adhering materials to the plant such as soil and sand affect total ash increasing. Acid-insoluble ash is the residue obtained after boiling the total ash with 70 g/l hydrochloric acid, and incinerating the remaining insoluble matters. This measures the amount of acid insoluble element such as silica.

### **Determination of volatile oil**

Volatile oils are characterized by their odor, oil like appearance and ability to volatilize at room temperature. They are composed of various chemical components. Aromatic compounds are predominated in certain volatile oils. In order to determine the amount of oil, the plant materials are distilled with water and distillates are collected. The aqueous portion separates automatically. If the volatile

oil depends on a mass density higher than or near to that of water, or are difficult to separate from the aqueous phase, a low mass density solvent and a suitable boiling point can be added to the measuring tube. The dissolved volatile oils will then float on top of the aqueous phase.



**Figure 6** Clevenger apparatus for determination of volatile oil content (dimensions in mm), (AC) a vertical tube, (CDE) a bent tube, (FG) a bulb-condenser, (GH) a tube, (HK) a side-arm tube, (K) a tube and (K') a vented ground-glass stopper, (J) a pear-shaped bulb with a volume of 3 ml, (L) a tube with a volume of 1 ml, (L) a bulb-like swelling with a volume of about 2 ml, (M) a three-way tap, (BM) a connecting tube (N) a security tube [2]

### **Determination of solvent extractive values**

This method determines amount of active constituents extracted from a given amount of medicinal plant material by a specific solvent. The determination of water soluble and alcohol soluble extractives can provide preliminary information on the quality of particular crude drug sample.

### **Thin layer chromatographic identification (TLC)**

Chromatography is technique used to separate mixtures of substances into their components. All forms of chromatography work on the same principle. The stationary phase is solid or liquid and mobile phase is liquid. The mobile phase flows through the stationary phase and carries the components of the mixture. Thin layer chromatography is used to identify compound by comparison with known samples, to check the purity of a compound, or to monitor the progress of a reaction, an extraction, or a purification procedure.

### Retention factor

The retention factor or  $R_f$  is calculated by dividing the distance the compound traveled from the original position by the distance the solvent travelled from the original position (the solvent front).

$$R_f = \frac{\text{Distance of center of spot from starting point}}{\text{Distance of solvent from starting point}}$$

The  $R_f$  value is a stable with each component only under identical experimental condition. TLC fingerprint is a method for the quality control of herbal materials. The  $R_f$  can be provided to identity of a compound. It is applicable for adulteration detection and plant examination and has been accepted by WHO.

### Quantitative analysis of kaempferol in *N. nucifera stamen*

Quantitative analysis is a modern analysis technique can be performed by data with scanning and analysis scan from densitometry. The amount of components separated on TLC plate can be measured by densitometer based on the intensity of UV/Vis absorption or fluorescence or by image analysis band on the pixel intensity of the image.



### **TLC densitometry**

Densitometry is the quantitative measurement of optical density of each component. It can measure the amount of a substance that is on the TLC plate based on the intensity of the light absorption or fluorescence and then converts the signal into densitogram or peak area by chromatography. Densitometry can be used to scan wavelength ranging 190-800 nm. The analysis is accurate and available for quantitative analysis [42].

### **Image analysis**

The pixel of sample bands and background on developed TLC plate photographed under ultra violet light at 254 nm or 366 nm can be transformed to peak chromatogram by image analysis software for example ImageJ software [43].

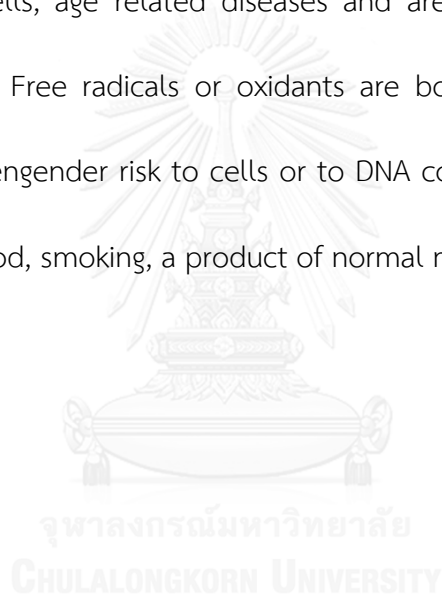
ImageJ is a public domain Java image processing and analytic program provided with NIH. It runs, either as an online or a downloadable application. It can be calculate area and pixel value statistics of user-defined selections. It can measure distances and angles. Programs create density histograms and line profile plots. It supports standard image processing function such as contrast manipulation, smoothing, edge detection, sharpening and median filtering. It dose geometric transformations such as scaling, rotation and flips. ImageJ can be downloaded from <http://imagej.nih.gov/ij/download.html>.

### **Efficacy evaluation: Antioxidant activities testing**

#### **Free radicals [39, 44, 45]**

Free radicals are groups of atoms or atoms with an odd (unpaired) electron that are unstable and highly reactive. It can be formed while oxygen interacts with some molecules.

Consequently, they have to bond with other molecules and are responsible for aging, damage cells, age related diseases and are concluded to expedite the formation of cancer. Free radicals or oxidants are bond to molecules within the body's tissues, they engender risk to cells or to DNA contained within the cells. It is derived from fried food, smoking, a product of normal metabolism and poisons [45].

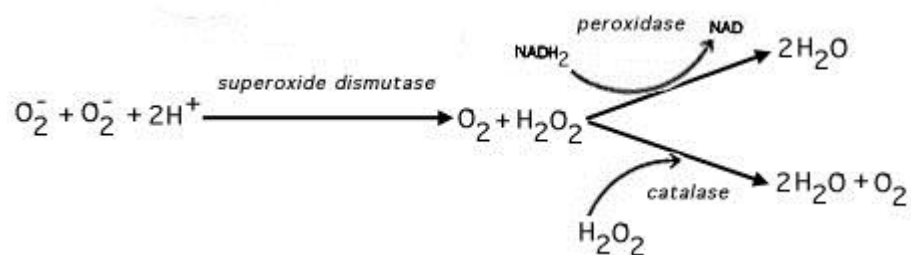


**Table 1** Free radicals [45]

Free radicals	Description
$O_2^{\bullet-}$ , superoxide anion	One-electron reduction state of $O_2^{\bullet-}$ , formed in many autoxidation reactions and by the electron transport chain. Rather unreactive but can release $Fe^{2+}$ from iron-sulfur proteins and ferritin. Undergoes dismutation to form $H_2O_2$ spontaneously or by enzymatic catalysis and is a precursor for metal-catalyzed OH formation.
$H_2O_2$ , hydrogen peroxide	Two-electron reduction state, formed by dismutation of $O_2^-$ or by direct reduction of $O_2$ . Lipid soluble and thus able to diffuse across membranes.
OH, hydroxyl radical	Three-electron reduction state, formed by Fenton reaction and decomposition of peroxynitrite. Extremely reactive, will attack most cellular components.
ROOH, organic hydro peroxide	Formed by radical reactions with cellular component such as lipids and nucleobases.
RO, alkoxy and ROO, Peroxy radicals	Oxygen centered organic radicals. Lipid forms participate in lipid peroxidation reactions. Produced in the presence of oxygen by radical addition to double bonds or hydrogen abstraction.
HOCl, hypochlorous acid	Formed from $H_2O_2$ by myeloperoxidase. Lipid soluble and highly reactive. Will readily oxidize protein constituents, including thiol groups, amino groups and methionine.
ONOO-, peroxynitrite	Formed in a rapid reaction between $O_2^-$ and NO. Lipid soluble and similar in reactivity to hypochlorous acid. Protonation forms peroxynitrous acid, which can undergo hemolytic cleavage to form hydroxyl radical and nitrogen dioxide.

### Free radicals in oxygen atom's group

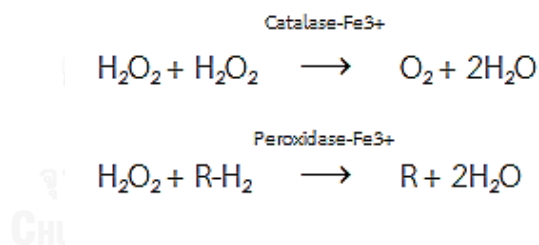
**Superoxide group:** Superoxide free radical group is the primary reactive oxygen species (ROS) as to germinated in electron transfer of cellular system [46]. Superoxide is the oxygen molecule which receive one oxygen atom ( $O_2^{\cdot-}$ ) and also has potentiality to break itself. It can be able to decompose to be secondary ROS for example hydrogen peroxide. Superoxide reacts with hydrogen peroxide to be hydroxyl radical [47]. Superoxide radical was produced as hydrogen peroxide receives ultraviolet ray whether or oxidation reaction of flavin polyphenol and quinone such as benzene or naphthalene which illustrated super radical reaction.



CHULALONGKORN UNIVERSITY

**Hydrogen group:** Hydrogen group is the most aggressive radical because its structure includes oxygen and hydrogen atom ( $OH^{\cdot}$ ). Hydroxyls group have the ability to pull electrons from other molecules. This radical can cause enzyme, lipid, vitamin c, encapsulated cells and deoxyribonucleic acid damage. In living life, hydroxyl radical is manufactured by dissolution incorporation of hydrogen peroxide by radiation or heat. Hydroxyl radical can be able to respond with organic compound (RH) for example carbohydrate, lipid, protein and nucleic acid.

Hydrogen peroxide group: In living organism, occurring peroxide was established like hydrogen peroxide.  $H_2O_2$  commonly hydrogen peroxide in organism is the stable and active to poison molecule interior the cells. Hydrogen peroxide with low concentrations do not motive cell decease however when merges with heavy metal or superoxide, that will motive the free radicals. All radicals, hydrogen peroxide is the only one stable compound it can be determined to easy. However hydrogen peroxide is not effective when arranged *in vitro*. Anaerobic organism has been mechanism with disrupt hydrogen peroxide over aerobic cells to apply catalase and peroxidase enzyme. This following formula shows Hydrogen peroxide deactivation by catalase and peroxidase enzyme.



**Peroxide group:** Peroxide is formed within human and animal like abbreviate lived result in biochemical processes and toxic to the cell. The toxicity is expects to oxidation with membrane lipids, proteins and DNA by means of the peroxide ions. The level of biological enzymes called superoxide dismutase or SOD is expanded in approximately some-living cells like a significant antioxidant agent. That encourage the disproportionate of superoxide enter the oxygen, that is therefore speedily decomposed with the enzyme catalase to the oxygen and water.

**Peroxyl group:** Peroxyl radicals ( $\text{ROO}^\bullet$ ) is the formed out of alive organism tissue, that is the effect of the production of hydroxyl radicals ( $\text{OH}^\bullet$ ). In addition to evidence twin direct and indirect present that hydroxyl radical can be innovate lipid peroxidation reaction responding hydroperoxyl or per hydroxyl radicals ( $\text{HOO}^\bullet$ ) [48].

**Hypochlorus acid:** Hypochlorus acid ( $\text{HOCl}$ ) is created in the autoimmune form for break virus and bacteria. It appears by incorporation of hydrogen peroxide and chloride, that effect on disruption of amino, protein and deoxyribonucleic acid.

#### **Free radicals in nitrogen atom's group**

Free radical in nitrogen atom's group for example nitric oxide ( $\text{NO}$ ) consists of antibonding electron in orbital. Nitric oxide is found in living organism, protect of cell adhesion, killing cancer cells host defense from parasite and vasodilator [49].

In macrophage nitric oxide can be produce is for destroying bacteria, cancer cell and virus cell. Nitric oxide synthase is related enzyme in generating nitric oxide.

Furthermore, nitric oxide synthase that created in platelet cell and endothelial cell in the neuron. Further from the benefits referred above, nitric oxide radical has disadvantage, that free radical that has oxidative stress and disrupts antioxidant system in the body.

## Antioxidants

An antioxidant is a molecule stable sufficient to donate an electron to a free radical and neutralize it, therefore reducing its capacity to disadvantage or damage. The antioxidants delay or prevent cellular damage generally through free radical scavenging property [50].

Antioxidants are also portion of the minerals, vitamins and nutrients present in foods. They are major common in plant foods for example, orange carrots, red cherries and purple blueberries. The antioxidants are beta carotene, vitamins A, C and E [26, 50, 51].

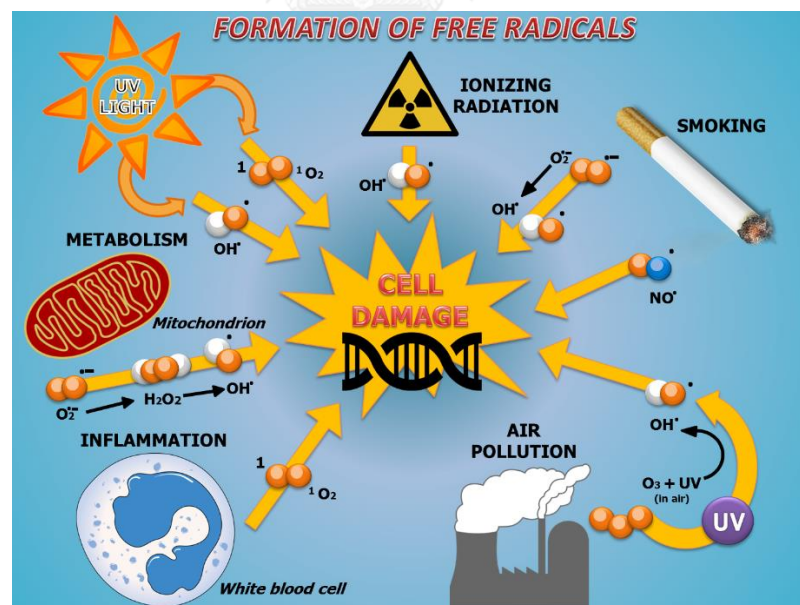


Figure 7 The formation of free radicals

## Antioxidation activity testing

### DPPH radical scavenging assay

Brand-Williams *et al.* reported that antioxidant activity of the extracts could be determined on the basis of the scavenging activity against the stable 1, 1-diphenyl 2-picrylhydrazyl (DPPH) free radical [52].

The delocalization of the spare electron within DPPH molecule makes the stability of this free radical and gives characteristics of dark violet color with a maximum absorbance for 517 nm. The color changes from violet to yellow when receives hydrogen from antioxidant as demonstrated in Figure 5 [53].

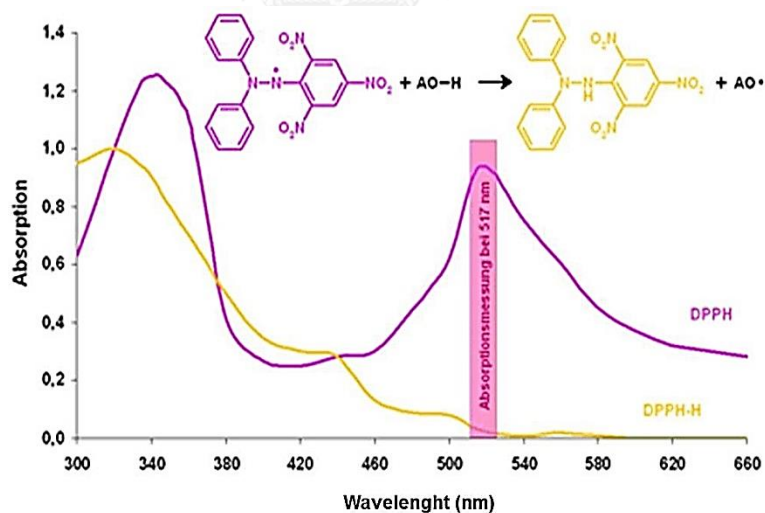
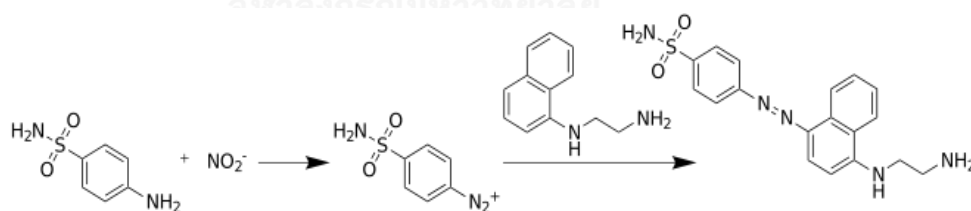


Figure 8 DPPH and antioxidant reaction



### Nitric oxide radical scavenging assay

Nitric oxide is a molecular compound with the chemical formula of NO. It is a free radical due to an unpaired electron of nitrogen. The procedure is based on the method that, sodium nitroprusside in aqueous solution at physiological pH inherently creates nitric oxide that interacts with oxygen to produce nitrite ions which can be estimated using Griess reagent based on the chemical reaction of sulfanilamide and N-1-naphthylethylenediamine di-hydrochloride (NED) under acidic conditions (phosphoric acid). This system detects NO<sub>2</sub> in a variety of biological and experimental liquid matrices for example plasma, serum and tissue culture medium [54]. Nitric oxide scavengers compete with O<sub>2</sub> leading to the decrease of nitrite ions. The absorbance was determined by observing blue color at wavelength of 560 nm [39, 52, 55].



**Figure 9** The Griess test reaction

### CHAPTER III

#### MATERIALS AND METHODOLOGY

##### Chemicals

Chloroform	J.T Baker Chemical Co., Phillipsburg, USA
Ethyl acetate	Mallinckrodt, Inc, USA
Ethanol	RCI Labscan Limited, Bangkok, Thailand
Methanol	RCI Labscan Limited, Bangkok, Thailand
Toluene	RCI Labscan Limited, Bangkok, Thailand
Formic acid	RCI Labscan Limited, Bangkok, Thailand
Dimethyl sulfoxide	Sigma-Aldrich, St. Louis, USA
Kaempferol	Sigma-Aldrich, St. Louis, USA
Ascorbic acid	Sigma-Aldrich, St. Louis, U.S.A
Quercetin	Sigma-Aldrich, St. Louis, U.S.A
Sodium nitroprusside	Sigma-Aldrich, St, Louis, U.S.A
Griess reagent	Sigma-Aldrich, St, Louis, U.S.A
2, 2- diphenyl-1-picrylhydrazyl	Sigma-Aldrich, St, Louis, U.S.A

##### Materials

Fitter paper No4.	Whatman™ Paper, UK
-------------------	--------------------

Fitter paper No40.	Whatman™ Paper, UK
Microscope Slide	Sail Brand, China
Cover glasses	Menzel-Glaser, Germany
TLC silica gel 60 GF <sub>254</sub>	MERCH, LTD, USA-20 × 10 cm. 0.2 mm thickness

### Instrument and equipments

Ashing Furnance	Carbolite, UK
Balance readability 0.01 g	Ohaus Corp. Pine Brook,NJ, USA (Pioneer™, PA2102)
CAMAG Linomat 5	CAMAG, Switzerland
CAMAG TLC Chamber	CAMAG, Switzerland
CAMAG TLC Scanner 3	CAMAG, Switzerland
CAMAG TLC Visualizer	CAMAG, Switzerland
Digital Camera	Canon Marketing (Thailand) Co.,LTD  (Canon PowerShot A650), Bangkok
Hot air oven	WTC Binder tuttlingen, Germany
Image J software	Nation Institutes of Health, USA (Version: 1.48)
Incinerator	Carbolite, UK
Microscope	Zeiss Axioskop, Germany

Rotary vacuum evaporator	Büchi, Switzerland
TLC syringe	Hamilton Company, USA
Ultrasonic bath	Analytical Lab Science Co., LTD, Bangkok
Cabinet (Model CC-80)	Spectronics Corporation Westbury, USA
Water bath	Brinkmann, USA
winCATS software	CAMAG, Switzerland (Version: 1.4.6.2002)



## Materials and methods

### Plants Material

Stamen of *N. nucifera* was collected from 15 various places throughout Thailand and then was authenticated by Associate Professor Dr.Nijsiri Ruangrunsi, PhD. Chulalongkorn University, Thailand. Voucher specimens are deposited at College of Public Health Sciences, Chulalongkorn University. Each authentic sample was air dried and pulverized to coarse powders after completed part of foreign matter. The standard kaempferol was purchased from Sigma-Aldrich, USA. The chemical was used of analytical grade.

### Standardization of *N. nucifera* stamens

#### Macroscopic evaluation

Macroscopic characteristics for example real size, surface, texture, odor, color of plant and was observed.

#### Microscopic evaluation

Microscopic examination of *N. nucifera* stamen was evaluated for cell structures. The stamen was sectioned and mounted to the slide with water for investigation of anatomical character. The pulverized stamen was examined for histological character. Transverse section and powders were observed under objective lens with 10X, 20X, and 40X and eyepieces lens with 10X magnifications.

### **Determination of water content (Azeotropic method)**

Fifty grams of sample was distilled with 200 ml of water-saturated toluene. The water content was calculated in percentage. The tests were performed in triplicate.

### **Determination of loss on drying**

Three grams of sample was weighted in a pre-weighed crucible and heated at 105 °C for 6 hours in an oven until constant weight. Loss on drying was calculated in percentage. The tests were performed in triplicate.

### **Determination of total ash**

Three grams of sample was pre-weighed crucible and burned to ash for at 500 °C for 5 hours until white or gray color was obtained. After that crucible to cool in a desiccator. The total ash was calculated in percentage. The tests were performed in triplicate.

### **Determination of acid insoluble ash**

The above crucible of total ash was added with 25 ml of hydrochloric acid (70 g/l), covered by a watch-glass, boiled gently for 5 minutes and filtered. The insoluble matters were accumulated on an ashless filter-paper No.40, washed, dried on hot-plate and burn at 500 °C for 5 hours to get a stable weight of ash. The acid insoluble ash was calculated in percentage. The tests were performed in triplicate.

#### **Determination of alcohol soluble extractive value**

Five grams of sample was weighed and macerated with 70 ml of 95% ethanol in a closed conical flask under shaking for 6 hours and standing for 18 hours. The extract was filtered, rinsed and adjusted the volume to 100 ml with ethanol.

Twenty millilitres of the filtrate was transferred to a pre-weighed beaker and evaporated to dryness at 105 °C to constant weight. The alcohol soluble extractive value was calculated in percentage. The tests were performed in triplicate.

#### **Determination of water soluble extractive value**

Five grams of sample was weighed and macerated with 70 ml of water in a closed conical flask under shaking for 6 hours and standing for 18 hours. The extract was filtered, rinsed and adjusted the volume to 100 ml with ethanol.

Twenty millilitres of the filtrate was transferred to a pre-weighed beaker and evaporated to dryness at 105 °C to constant weight. The water soluble extractive value was calculated in percentage. The tests were performed in triplicate.

### Thin layer chromatographic fingerprint

Twenty millilitres of the filtrate from extractive test was evaporated to dryness and re-dissolved 1 ml of ethanol. Three microlitres was spotted on TLC silica gel 60 GF254 plate and developed in a mixture of chloroform and methanol (9:1) as mobile phase. Visualization was performed under daylight and ultraviolet light (254 and 365 nm). TLC plate was also sprayed with anisaldehyde reagent and heated at 110 °C for 10 minutes.

Quantitative analysis of kaempferol contents by TLC-densitometry

### Preparation of kaempferol solutions

Two milligrams of kaempferol standard was dissolved in 10 ml of 95% ethanol in volumetric flask and diluted to obtain the series of standard with concentration of 0.02, 0.04, 0.08, 0.10 and 0.12 mg/ml

### Preparation of ethanol extracts of *N. nucifera* stamens

Twenty grams of *N. nucifera* stamen powders was exhaustively extracted with 95% ethanol by Soxhlet apparatus. The ethanolic extract was filtered to dryness by rotary evaporator. The extract was dissolved in 95% ethanol to the concentration of 20 mg/ml for TLC densitometry and TLC image analyses.



### **TLC densitometry**

Three microliters of the ethanolic extract solution and kaempferol standard solution was tested onto silica gel 60 F 254 TLC plate. 3  $\mu$ l of extract and standard solution were applied on the TLC plates (5 mm width) by CAMAG Linomat 5. The plate was developed in toluene: ethyl acetate: chloroform: formic acid (5: 4: 1: 1). The plate was scanned by CAMAG TLC scanner under wavelength of maximum absorbance for quantitative analysis. The intensity of band was performed to the chromatographic peak by WinCATS software. The calibration curve of kaempferol was shown by plotting peak area *versus* concentration of kaempferol in  $\mu$ g/spot.

### **TLC image analysis by ImageJ software**

Developed TLC plate was photographed under UV 254 nm. The images were saved .Tiff file and analyzed by ImageJ software. Peak area corresponded to kaempferol concentration ( $\mu$ g/spot) was determined.

### **Method validation**

#### **Specificity**

The TLC plates were scanned for absorption spectra under the range of 200-700 nm by TLC scanner 3. Specificity was appraised by comparison of the absorption the standard kaempferol and each sample (peak identity) as well as comparison of the absorption between spectra at up-slope, apex and down-slope of the peak (peak purity).

### Linearity

Peak area estimated by densitometer or ImageJ software was plotted *versus* standard kaempferol concentration ( $\mu\text{g}/\text{spot}$ ). The regression equation was determined using Excel 2003.

### Limit of detection

The limit of the detection (LOD) is the lowest concentration that can be detected but not precisely quantitated. LOD was determined from the calibration curve using following formula.

$$\text{LOD} = 3.3 \sigma/S$$

Where,  $\sigma$  = standard deviation of regression line

S = the slope of regression line

### Limit of quantitation

The limit of quantitation (LOQ) is the lowest concentration that can be precisely quantitated. LOQ was determined from the calibration curve using following formula.

$$\text{LOQ} = 10 \sigma/S$$

Where,  $\sigma$  = the standard deviation of regression line

S = the slope of regression line

### Accuracy

The accuracy of method was investigated as % recovery of known kaempferol amount spiked to the sample. Three level concentrations (low, medium, high) of kaempferol was determined in triplicate. The accuracy was calculated by following formula.

$$\% \text{ Recovery} = [C1 / (C2+C3)] \times 100$$

C1 = the amount of kaempferol tested in spiked sample extract

C2 = the amount of kaempferol tested in un-spiked sample extract

C3 = the amount of kaempferol standard added to the sample

### Precision

Repeatability was evaluated by analyzing sample extracts with three level concentrations of kaempferol on the same day. Intermediate precision was evaluated by analyzing sample extracts with three level concentrations of kaempferol on 3 different day. The tests was performed in triplicate. The % relative standard deviation (% RSD) was calculated by following formula.

$$\% \text{ RSD} = SD \times 100 / \text{Mean}$$

### Robustness

A few differentiation in a mix volume of mobile phase including using toluene: ethyl acetate: chloroform: formic acid (4.8: 3.8: 0.8: 0.8), (4.9: 3.9: 0.9: 0.9), (5: 4: 1: 1), (5.1: 4.1: 1.1: 1.1), (5.2: 4.2: 1.2: 1.2). The robustness was showed by %RSD of peak area and calculated with %RSD.

### Antioxidant activities

#### DPPH radical scavenging assay

The DPPH radical scavenging assay was performed in 96 well microplate. One hundred microliters of various concentrations of the extract or positive controls (quercetin, ascorbic acid, BHT, kaempferol) in ethanol was added with 100  $\mu$ l of DPPH radical ethanolic solution (120  $\mu$ M), incubated at room temperature for 30 minutes in the dark and absorbance was measured under the wavelength of 517 nm. Each sample was done in triplicate. The radical scavenging activity was calculated using following formula;

$$\% \text{ Inhibition} = \frac{[\text{Absorbance control} - \text{Absorbance sample}]}{\text{Absorbance control}} \times 100$$

### Nitric oxide radical scavenging assay

Two hundred microliters of various concentrations of extract or positive control (quercetin, kaempferol) in cuvette was added with 200  $\mu$ l of sodium nitroprusside (4 mM) in phosphate buffer (pH 7.5) and was incubated at 25 °C for 120 minute. Griess reagent (400  $\mu$ l) was added and the absorbance was measured under the wavelength of 560 nm. Each sample was done in triplicate. The percentage of nitric oxide radical inhibitory activity was calculated as equation below and IC<sub>50</sub> that indicated the concentration of sample required to scavenge 50% of nitric oxide radical inhibition activity was calculated.

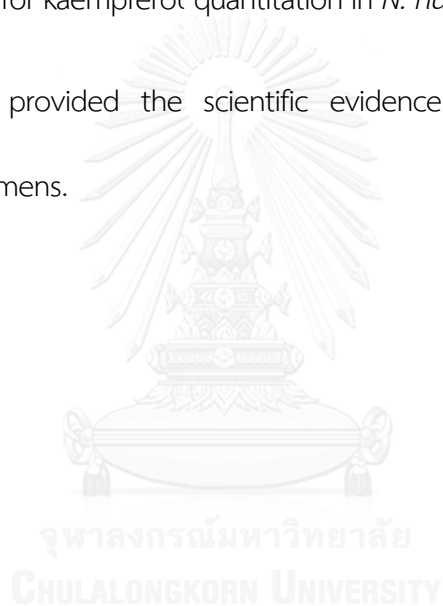
$$\% \text{ Inhibition} = \frac{[\text{Absorbance control} - \text{Absorbance sample}]}{\text{Absorbance control}} \times 100$$

### Data analysis

The parameters due to standardization were presented as grand mean  $\pm$  pooled standard deviation (SD). The kaempferol contents by TLC-densitometry and TLC image analysis were compared by paired *t*-test statistical analysis.

### Benefits and applications

1. This research provided the standardization parameters of *N. nucifera* stamens.
2. This research provided the content of kaempferol in *N. nucifera* stamens.
3. This research provided the simple, less expensive and valid method of TLC image analysis for kaempferol quantitation in *N. nucifera* stamen crude drug.
4. The research provided the scientific evidences in antioxidant activities of *N. nucifera* stamens.



## CHAPTER IV

## RESULTS

*Nelumbo nucifera* stamens

## Macroscopic examination

*Nelumbo nucifera* stamens (Figure 10) were pale-yellow or brownish-yellow thin line with 0.6-2 cm length and 0.1 cm diameter. The stamen filaments were dark purple cylindrical shaped with 1.5-1.8 cm length. The stamens had aromatic odor and astringent taste. The *Nelumbo nucifera* Gaertn. was illustrated in Figure 11.



Figure 10 *Nelumbo nucifera* stamen crude drug

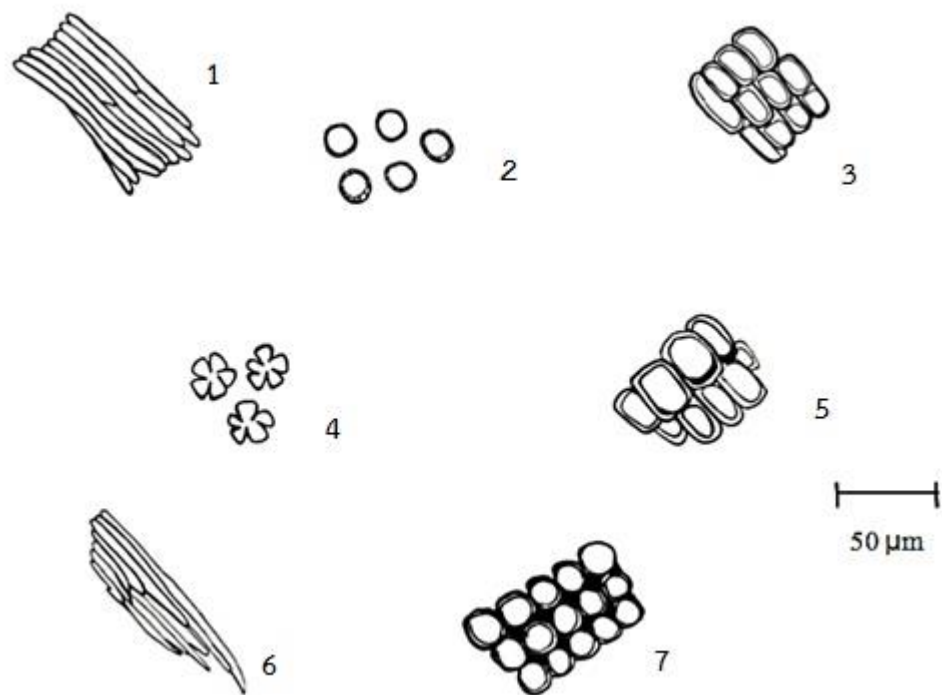


Figure 11 *Nelumbo nucifera* Gaertn.



### Microscopic examination

The histological investigation of *N. nucifera* stamen powders revealed the characteristics including fragment of parenchyma, pollens, epidermal cell, calcium oxalate, fragment of fibers and collenchymas as shown in Figure 12. The anatomical characteristics of *N. nucifera* stamen was illustrated in Figure 13.



**Figure 12** Histological characters of the stamen of *Nelumbo nucifera* Gaertn.

1. parenchyma 2. pollen grains 3. epidermal cell 4. calcium oxalate crystals
5. fragment of parenchyma 6. fiber 7. collenchyma

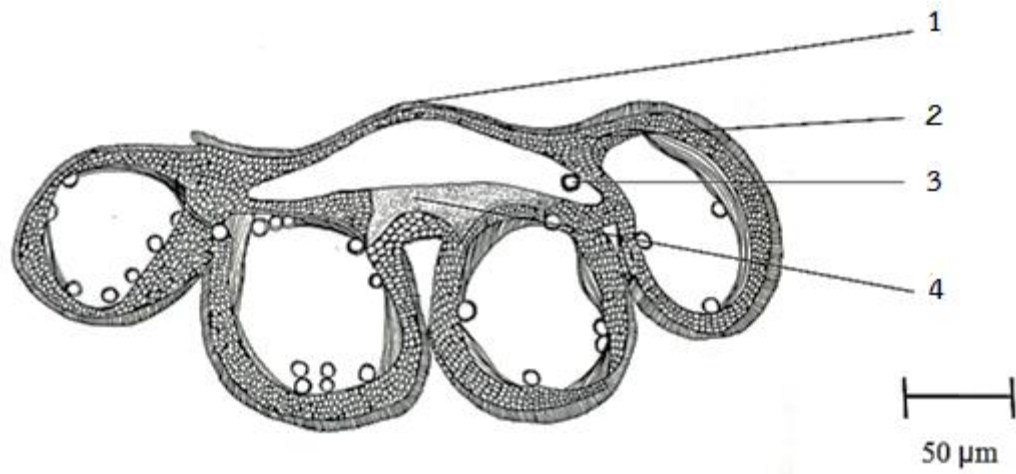


Figure 13 Transverse section of the stamen of *Nelumbo nucifera* Gaertn.

1. epidermis
2. parenchyma
3. pollen grain
4. collenchyma

## Physicochemical evaluation

Physicochemical properties of *N. nucifera* stamens from 15 different sources throughout Thailand including total ash, acid insoluble ash, loss on drying, moisture, volatile oil and extractive matter contents were evaluated for the pharmacognostic specifications of *N. nucifera* stamens as presented in Table 2.

**Table 2** Physicochemical specifications of *N. nucifera* stamens

Content (% by weight)	Mean $\pm$ SD <sup>*</sup>	Range <sup>**</sup>
Total ash	5.23 $\pm$ 0.12	4.88 – 5.58
Acid insoluble ash	0.91 $\pm$ 0.17	0.60 – 1.51
Loss on drying	8.93 $\pm$ 0.24	8.20 – 9.66
Moisture	9.89 $\pm$ 0.22	9.22 – 10.56
Ethanol soluble extractive	10.30 $\pm$ 0.31	9.36 – 11.24
Water soluble extractive	10.91 $\pm$ 0.37	9.81 – 12.02
Volatile oil	-	-

\*Grand mean  $\pm$  pooled SD. \*\*mean  $\pm$  3SD, sample were from 15 different sources throughout Thailand. Each sample was performed in triplicate.

### Thin layer chromatographic identification

TLC fingerprint of *N. nucifera* stamen ethanolic extract was shown in Figure 14.

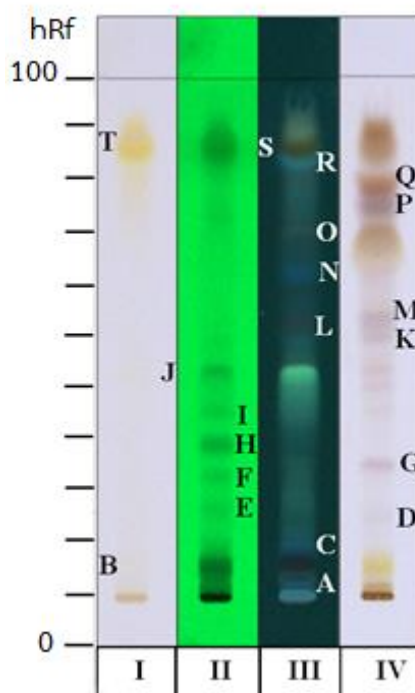


Figure 14 TLC fingerprint of *N. nucifera* stamen ethanolic extract

**Solvent system** chloroform: methanol (9:1)

**Detection** I = detection under daylight

II = detection under UV 254 nm

III = detection under UV 365 nm

IV = detection with anisaldehyde reagent

The  $R_f$  values of *N. nucifera* stamen component were illustrated in Table 3.

TLC fingerprint of *N. nucifera* stamens revealed at least 20 chemical components.

**Table 3**  $R_f$  values of chemical components in the ethanolic extract of *N. nucifera* stamens developed by chloroform: methanol (9:1)

Spot	$hR_f$	Detection			
		Visible light	UV 254 nm	UV 365 nm	Anisaldehyde
A	0.08	-	Quenching	Pale Green	Brown
B	0.15	Pale Yellow		-	-
C	0.20	-		Pale Green	-
D	0.28	-		-	Pink Purple
E	0.39	-	Quenching	-	-
F	0.40	-	Quenching	-	Reddish Pink
G	0.50	-	-	-	Reddish Pink
H	0.53	-	Quenching	-	-
I	0.54	-	Quenching	-	-
J	0.47	Pale Yellow	Quenching	Pale Blue	-
K	0.50	-	-	-	Pale purple
L	0.52	-	Quenching	Pale Blue	
M	0.53	-	-	-	Pale purple
N	0.61	-	-	Pale Blue	-
O	0.72	-	-	Pale Blue	-
P	0.78	-	-	-	Brown
Q	0.80	-	-	-	Brown
R	0.84	-	Quenching	Emerald Green	-
S	0.93	-	Quenching	-	-
T	0.94	Yellow	-	-	-

### Ethanolic extraction of *N. nucifera* stamens

The dried powders of *N. nucifera* stamens from 15 sources were extracted with 95% ethanol by soxhlet apparatus. The percent yields of crude extracts were demonstrated in Table 4. The average percent yield of *N. nucifera* stamen ethanolic extract was  $18.5 \pm 4.8$  g/100g

**Table 4** The percent yields of ethanolic extract of *N. nucifera* stamen crude drug from 15 sources in Thailand

Source	Weight of sample	Weight of extractive value	% yield
1	3.0057	0.5098	16.9611
2	3.0026	0.5966	19.8684
3	3.0050	0.6383	21.2413
4	3.0013	0.4914	16.3729
5	3.0089	0.1184	3.9350
6	3.0049	0.6764	22.5099
7	3.0071	0.5460	18.1570
8	3.0050	0.7714	25.6705
9	3.0082	0.5931	19.7161
10	3.0046	0.5160	17.1737
11	3.0010	0.5429	18.0906
12	3.0069	0.6637	22.0726
13	3.0072	0.4952	16.4671
14	3.0032	0.6269	20.8744
15	3.0027	0.5385	17.9339
<b>Average</b>			<b>18.470 ± 4.798</b>

## Quantitative analysis of kaempferol contents of *N. nucifera* stamens by TLC densitometry

Standard kaempferol and the ethanolic extracts were developed in toluene: ethyl acetate: chloroform: formic acid (5: 4: 1: 1). TLC plate was scanned by CAMAG TLC scanner under 375 nm. The peak areas were computed by WinCATS software. The amounts of kaempferol were found to be  $0.225 \pm 0.057$  grams in 100 grams of the ethanolic extract and  $0.041 \pm 0.013$  grams in 100 grams of *N. nucifera* stamen crude drug (Table 5).

### Method validation

The calibration range, specificity, accuracy, precision, LOD, LOQ and robustness were examined for the validation of an analytical method followed by ICH guideline.

The calibration curves of standard kaempferol were linear in the range of 0.06-0.36  $\mu\text{g}/\text{spot}$  with the equation of  $y = 33786x + 264.92$  (Figure 15).

The LOD and LOQ were calculated based on the standard deviation of regression line and slope of the calibration curve. The LOD value, considered as the lowest concentration for analyte in a sample that could be detected was found to be 0.02  $\mu\text{g}/\text{spot}$ . The LOQ value, the lowest concentration of analyte in a sample that could be quantitatively defined was 0.05  $\mu\text{g}/\text{spot}$ .

**Table 5** Kaempferol contents in *N. nucifera* stamens from 15 different sources throughout Thailand by TLC densitometry

Source	Kaempferol in the ethanolic extract (g/100g)		The ethanolic extract yield (g/100 g of dried crude drug)	Kaempferol in <i>N. nucifera</i> stamens (g/100 g)	
	mean	SD		mean	SD
1	0.215	0.0043	16.961	0.036	0.0014
2	0.206	0.0012	19.868	0.041	0.0004
3	0.318	0.0047	21.241	0.068	0.0016
4	0.275	0.0039	16.373	0.045	0.0013
5	0.267	0.0057	3.935	0.010	0.0019
6	0.185	0.0021	22.510	0.042	0.0007
7	0.298	0.0056	18.157	0.054	0.0019
8	0.184	0.0044	25.671	0.047	0.0014
9	0.193	0.0015	19.716	0.038	0.0005
10	0.292	0.0076	17.174	0.050	0.0026
11	0.196	0.0017	18.091	0.036	0.0006
12	0.143	0.0028	22.073	0.032	0.0009
13	0.179	0.0030	16.467	0.029	0.0010
14	0.147	0.0032	20.874	0.031	0.0011
15	0.280	0.0117	17.934	0.050	0.0039
<b>Average</b>	<b>0.225 ± 0.057</b>			<b>0.041 ± 0.013</b>	



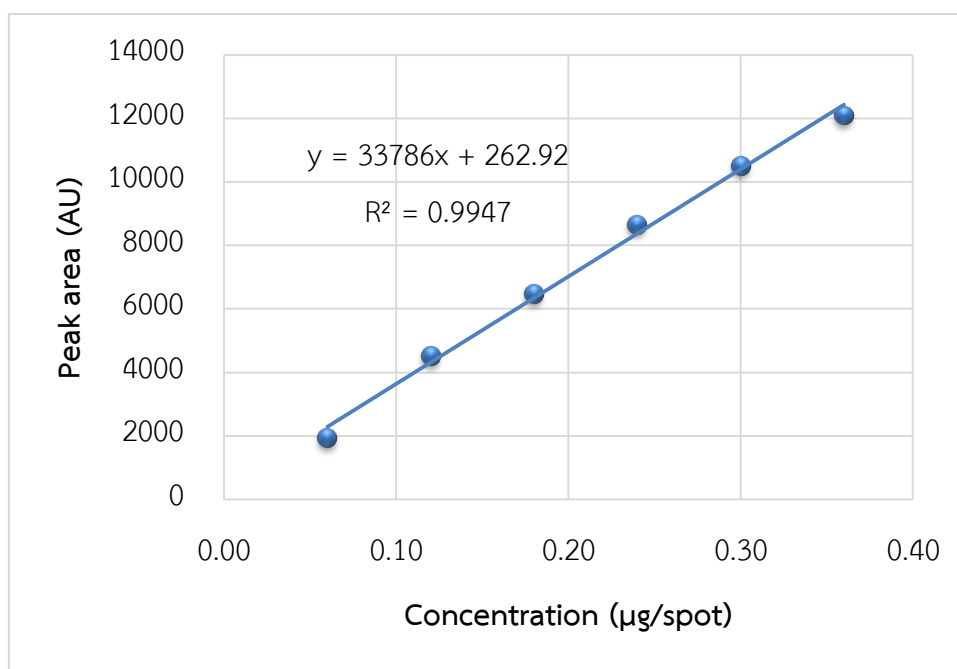


Figure 15 The calibration curve of kaempferol by TLC densitometric method



The recovery analysis was applied to validate the accuracy of kaempferol quantitation in the ethanolic extract of *N. nucifera* stamens. Three amounts of standard kaempferol were spiked into the sample. The recovery values were 94.0 – 109.7 % as demonstrated in Table 6.

**Table 6** Accuracy of quantitation of kaempferol in *N. nucifera* stamens by TLC densitometry (n=3)

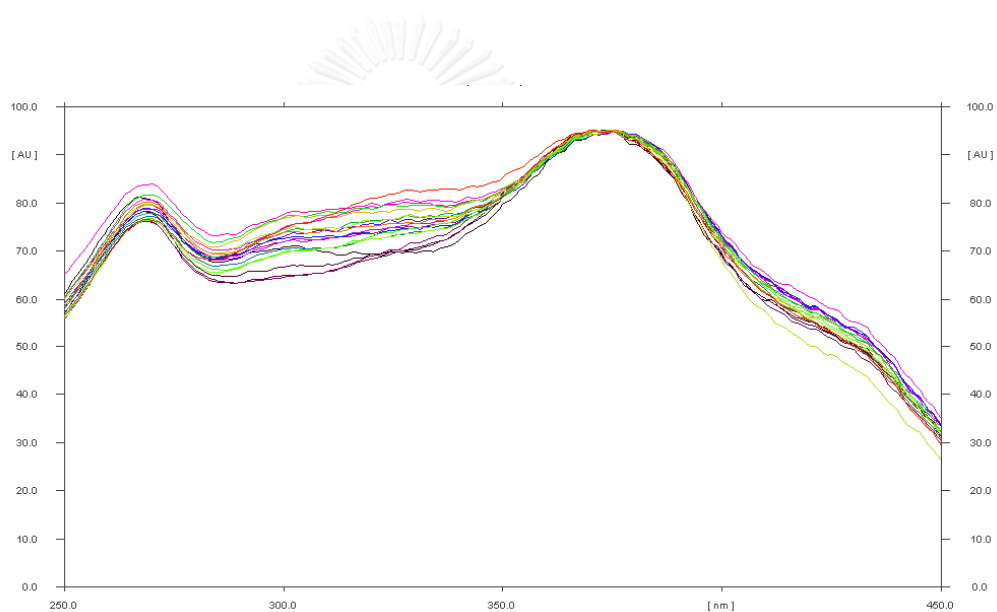
Kaempferol added ( $\mu\text{g}/\text{spot}$ )	Kaempferol found ( $\mu\text{g}/\text{spot}$ )	% Recovery
0	$0.1107 \pm 0.0009$	-
0.12	$0.2424 \pm 0.0011$	109.7
0.18	$0.2838 \pm 0.0021$	96.2
0.24	$0.3363 \pm 0.0005$	94.0

The precision (repeatability and intermediate precision) by TLC densitometric method was represented as % RSD at three levels of kaempferol in the ethanolic extracts performed in the same day and 3 different days. The repeatability and intermediate precision were in range of 0.26 - 2.41 % and 2.39 - 4.32 % RSD, respectively (Table 7).

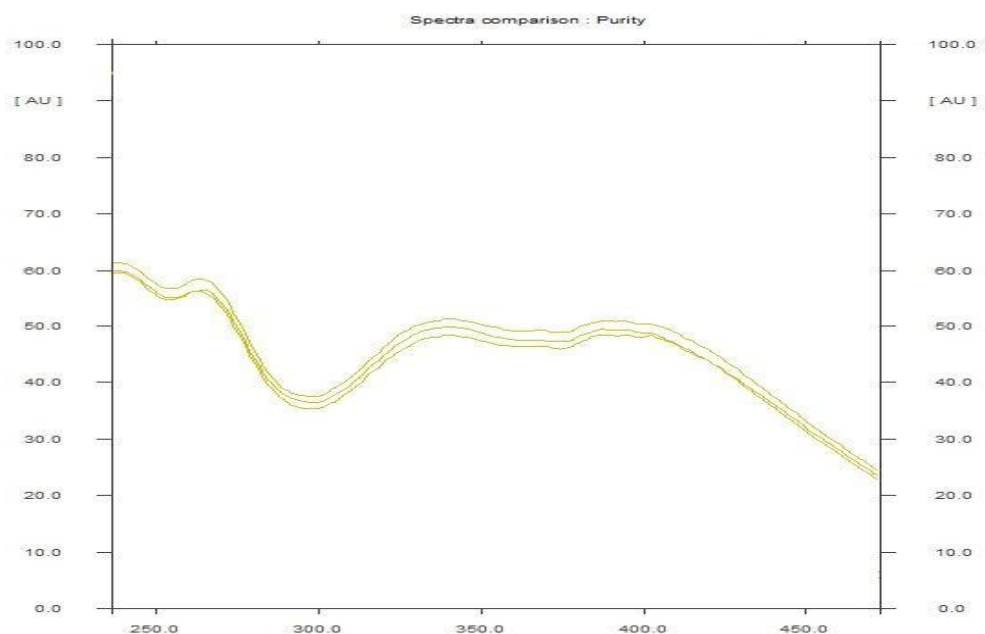
**Table 7** Repeatability and intermediate precision of kaempferol in *N. nucifera* stamens by TLC densitometry (n=3)

Kaempferol ( $\mu\text{g}/\text{spot}$ )	% RSD	
	Repeatability precision	Intermediate precision
0.242	1.41	4.32
0.284	2.41	4.27
0.336	0.26	2.39

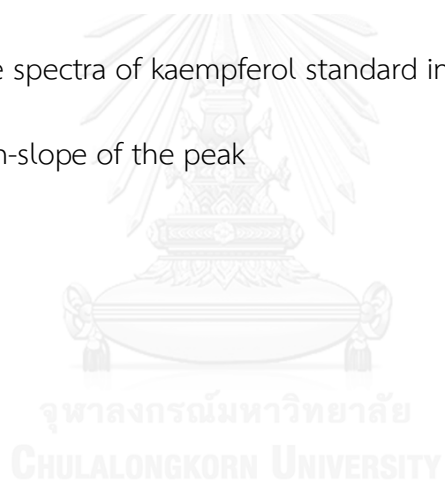
The specificity was executed by peak identity and peak purity checking. The identity in absorbance spectra determined at the peak apex among kaempferol standards and samples was illustrated in Figure 16 and the identity in absorbance spectra determined at up-slope, apex and down-slope of the sample peak was shown in Figure 17.



**Figure 16** Absorbance spectra of 6 kaempferol standards and 15 ethanolic extracts of *N. nucifera* stamens



**Figure 17** Absorbance spectra of kaempferol standard in ethanolic extract using up-slope, apex and down-slope of the peak



The robustness of kaempferol quantitation in *N. nucifera* stamens by TLC densitometric analysis was determined among five mobile phase ratios. The result of robustness was 2.5 % RSD of peak area (Table 8).

**Table 8** Robustness investigation of kaempferol in *N. nucifera* stamens by TLC densitometry

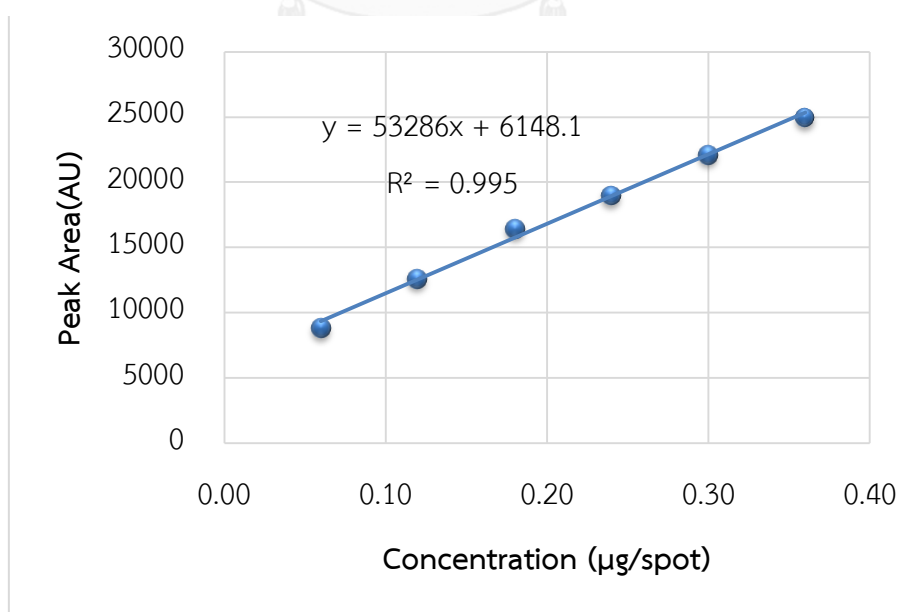
Mobile phase ratio (v/v)				kaempferol peak area n=3	Mean	SD	%RSD
toluene	ethyl acetate	chloroform	formic acid				
4.8	3.8	0.8	0.8	7361.1, 7333.3, 7373.8 (7356.1)	7340.6	26.8	2.5
4.9	3.9	0.9	0.9	7392.6, 7313.3, 7379.8 (7356.1)			
5	4	1	1	7204.9, 7304.3, 7386.6 (7298.6)			
5.1	4.1	1.1	1.1	7330.1, 7348.9, 7340.0 (7339.7)			
5.2	4.2	1.2	1.2	7382.5, 7339.7, 7364.8 (7362.3)			

### Quantitative analysis of kaempferol contents of *N. nucifera* stamens by TLC image analysis

The image of TLC plates photographed under UV 254 nm were analyzed for kaempferol of peak areas by ImageJ software. The amounts of kaempferol were found to be  $0.242 \pm 0.065$  g in 100 grams of the ethanolic extract and  $0.045 \pm 0.16$  grams in 100 grams of *N. nucifera* stamens crude drug (Table 9).

### Method validation

The calibration curve of kaempferol ranged from 0.06 – 0.36  $\mu\text{g}/\text{spot}$  with the equation of  $y = 53286x + 6148.1$  was shown in Figure 18. LOD and LOQ were calculated based on the standard deviation of a regression line and the slope of the calibration curve. The LOD was found to be 0.02  $\mu\text{g}/\text{spot}$ . The LOQ value was 0.06  $\mu\text{g}/\text{spot}$



**Figure 18** The calibration curve of kaempferol by TLC image analysis

**Table 9** Kaempferol contents in *N. nucifera* stamen from 15 different sources throughout Thailand by TLC image analysis

Source	Kaempferol in the ethanolic extract (g/100g)		The ethanolic extract yield (g/100 g of dried crude drug)	Kaempferol in <i>N. nucifera</i> stamen (g/100 g)	
	mean	SD		mean	SD
1	0.174	0.0063	16.961	0.029	0.0021
2	0.236	0.0007	19.868	0.047	0.0002
3	0.261	0.0077	21.241	0.055	0.0026
4	0.217	0.0104	16.373	0.036	0.0035
5	0.189	0.0115	3.935	0.007	0.0038
6	0.270	0.0077	22.510	0.061	0.0026
7	0.271	0.0117	18.157	0.049	0.0039
8	0.206	0.0085	25.671	0.053	0.0028
9	0.280	0.0081	19.716	0.055	0.0027
10	0.291	0.0200	17.174	0.050	0.0067
11	0.205	0.0091	18.091	0.037	0.0030
12	0.176	0.0120	22.073	0.039	0.0040
13	0.196	0.0120	16.467	0.032	0.0040
14	0.233	0.0059	20.874	0.049	0.0020
15	0.432	0.0084	17.934	0.077	0.0028
<b>Average</b>	<b>0.242 ± 0.065</b>			<b>0.045 ± 0.016</b>	



The accuracy of kaempferol quantitation using image analysis evaluated by the recovery of spiked known amounts of kaempferol were 99.96 – 111.98 % as demonstrated in table 10.

**Table 10** Accuracy of quantitation of kaempferol in *N. nucifera* stamens by TLC image analysis (n=3)

Kaempferol added ( $\mu\text{g}/\text{spot}$ )	Kaempferol found ( $\mu\text{g}/\text{spot}$ )	% Recovery
0.00	$0.1184 \pm 0.0005$	-
0.12	$0.2484 \pm 0.00009$	112.0
0.18	$0.2940 \pm 0.0003$	104.2
0.24	$0.3412 \pm 0.0001$	100.0

The repeatability and intermediate precision of kaempferol quantitative analysis by imageJ software were in range of 2.07 – 6.70 % - 4.32 and 7.18 % RSD respectively (Table 11).

**Table 11** Repeatability and intermediate precision of kaempferol in *N. nucifera* stamens by TLC image analysis method (n=3)

Kaempferol ( $\mu\text{g}/\text{spot}$ )	% RSD	
	Repeatability precision	Intermediate precision
0.248	2.07	7.18
0.294	3.17	4.47
0.341	6.70	4.32

The robustness of kaempferol quantitation in *N. nucifera* stamens by TLC image analysis was determined in five mobile phase ratios. The result of robustness was 0.41 % RSD of peak area (Table 12).

**Table 12** Robustness investigation of kaempferol in *N. nucifera* stamens by TLC image analysis

Mobile phase ratio (v/v)				kaempferol peak area n=3	Mean	SD	%RSD
toluene	ethyl acetate	chloroform	formic acid				
4.8	3.8	0.8	0.8	18496.5, 18230.5, 18732.7 (18486.6)	18517.2	33.12	0.41
4.9	3.9	0.9	0.9	18361.6, 18372, 18469.4 (18553.5)			
5	4	1	1	18508.4, 18419.4, 18728.8 (18490.5)			
5.1	4.1	1.1	1.1	18353.2, 18441.6, 18263.8 (18552.2)			
5.2	4.2	1.2	1.2	18396, 18200.4, 18300.4 (18503.2)			

### The comparison of kaempferol contents between TLC densitometry and TLC image analysis

The comparison of kaempferol contents between TLC densitometry and TLC image analysis were analyzed by paired *t*-test (Table 13). The result presented that the kaempferol contents from two methods were not significantly different ( $p=0.08$ ).

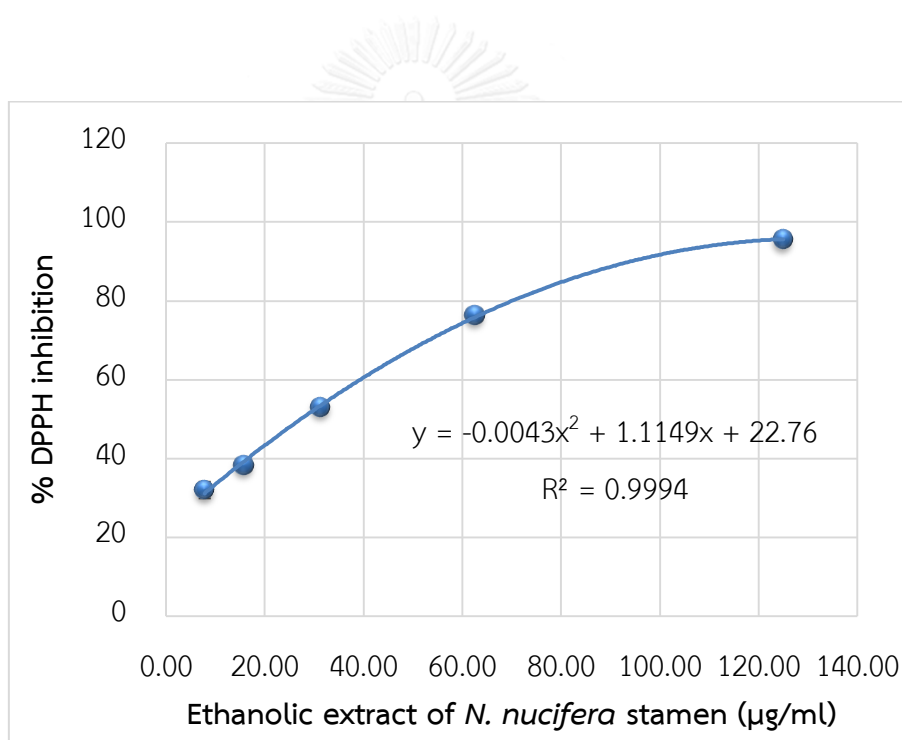
**Table 13** The comparison of kaempferol contents between TLC densitometry and TLC image analysis

Source	Kaempferol content ( g/100g of dried crude drug)	
	TLC densitometry	TLC Image analysis
1	0.036	0.029
2	0.041	0.047
3	0.067	0.055
4	0.045	0.036
5	0.011	0.007
6	0.042	0.061
7	0.054	0.049
8	0.047	0.053
9	0.038	0.055
10	0.050	0.050
11	0.035	0.037
12	0.031	0.039
13	0.029	0.032
14	0.031	0.049
15	0.050	0.077
<b>Average</b>	<b>0.041 ± 0.013</b>	<b>0.045 ± 0.016</b>

## Antioxidant activities

### DPPH radical scavenging assay

The ethanolic extract of the *N. nucifera* stamens showed the DPPH radical scavenging activity with  $IC_{50}$  of 27.31  $\mu\text{g/ml}$  (Figure 19). Quercetin, Ascorbic acid, BHT and kaempferol were used as positive control which showed  $IC_{50}$  of 3.67  $\mu\text{g/ml}$ , 68.21  $\mu\text{g/ml}$ , 24.59  $\mu\text{g/ml}$  and 25.72  $\mu\text{g/ml}$ , respectively (Figure 20-23).



**Figure 19** Percent DPPH inhibition of *N. nucifera* stamens

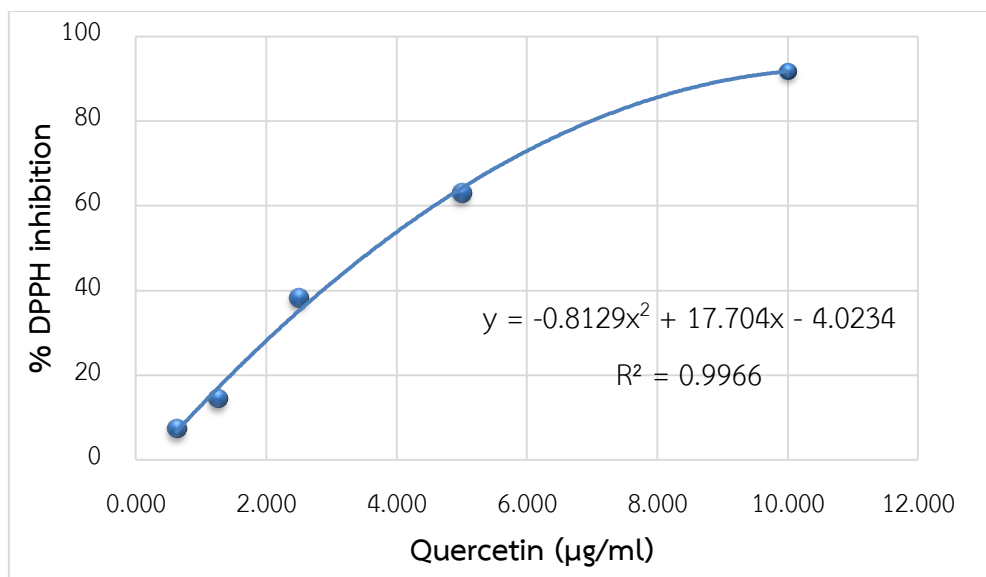


Figure 20 Percent DPPH inhibition of quercetin

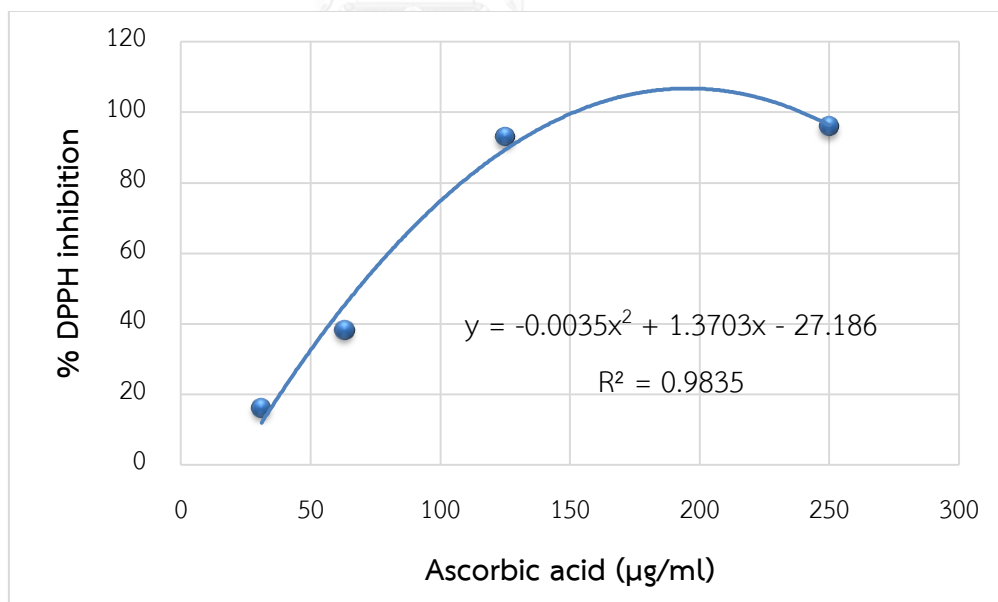


Figure 21 Percent DPPH inhibition of ascorbic acid

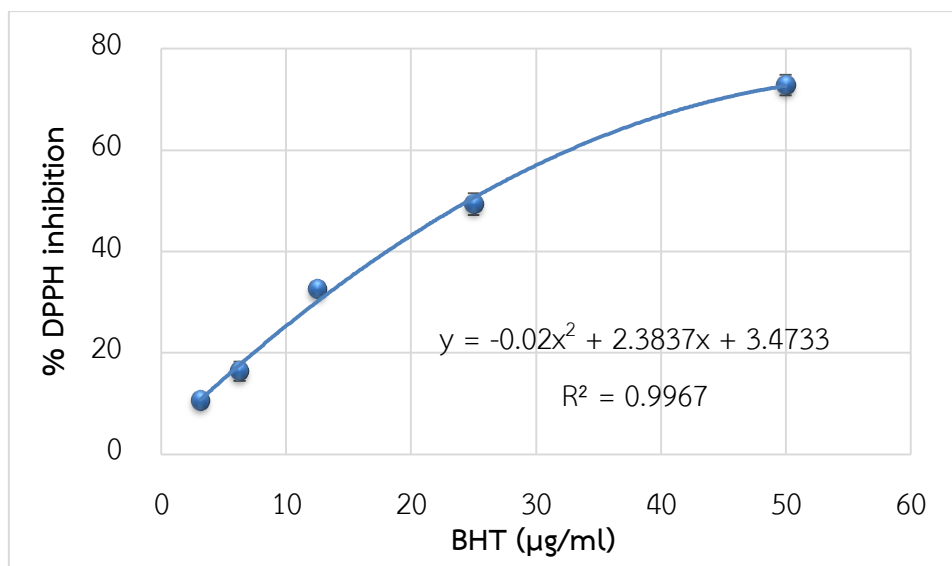


Figure 22 Percent DPPH inhibition of BHT

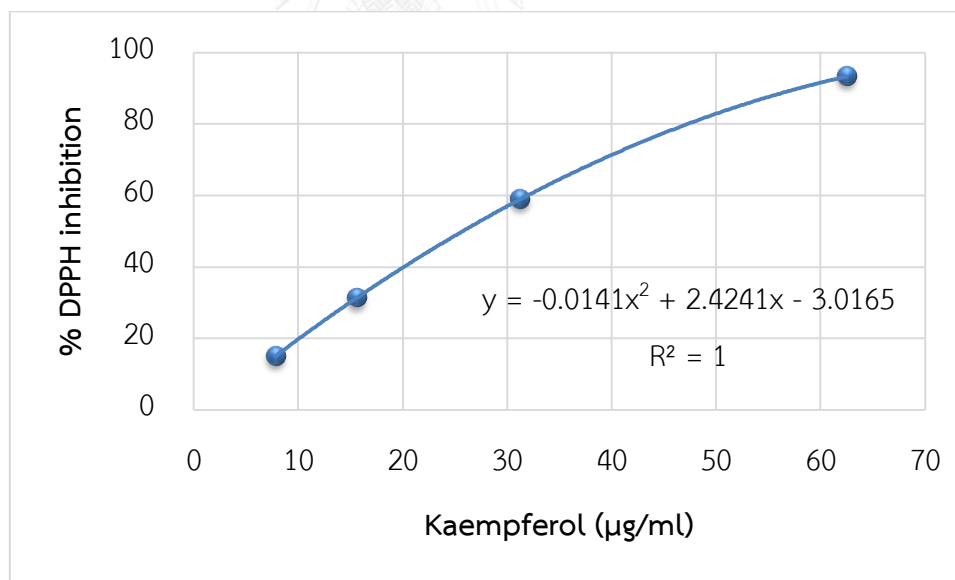
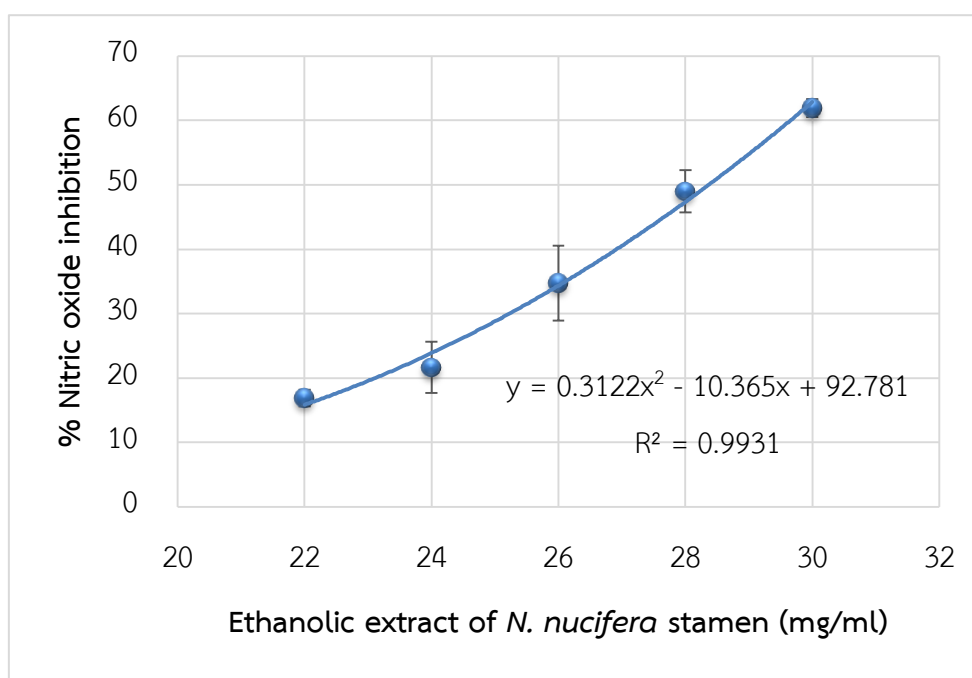


Figure 23 Percent DPPH inhibition of kaempferol

### Nitric oxide radical scavenging assay

The ethanolic extract of the *N. nucifera* stamens showed the nitric oxide radicals scavenging activity with IC<sub>50</sub> of 28.37 mg/ml, positive control; quercetin and kaempferol showed IC<sub>50</sub> of 0.65 and 0.11 mg/ml, respectively (Figure 24-26).



**Figure 24** Percent nitric oxide inhibition of *N. nucifera* stamens



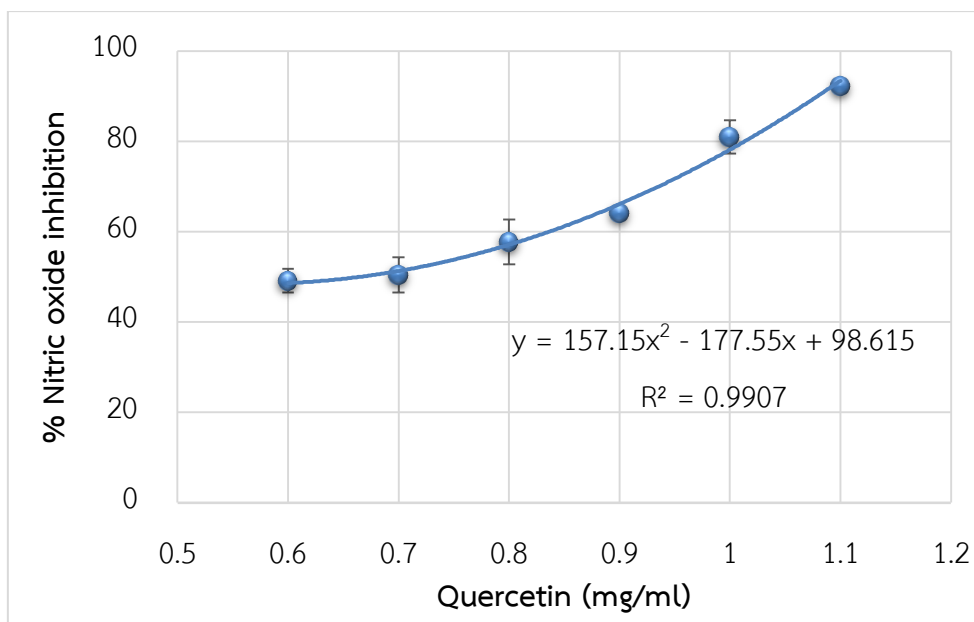


Figure 25 Percent nitric oxide inhibition of quercetin

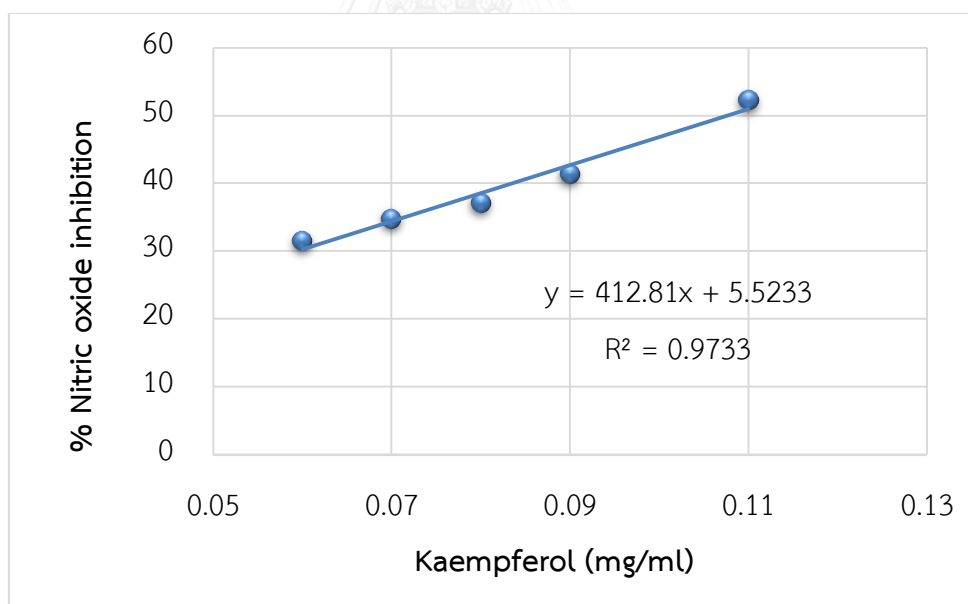


Figure 26 Percent nitric oxide inhibition of kaempferol

## CHAPTER V

### DISCUSSION AND CONCLUSION

Generally, the quality control is used to maintain safety and efficacy of the herbal medicine. One of the most important process of the quality control is standardization which set the specifications of macroscopic, microscopic, physicochemical parameters, chromatographic fingerprint and quantification of chemical marker to ensure the purity and quality of the crude drug.

*N. nucifera* is one of the medicinal plants used in many countries. In Thailand, the common name is Bua-Luang. Its stamens have been traditionally used alone or in combination with other aromatic plant stamens namely Kae-sorn-thang-ha (the total 5 types stamens), Kae-sorn-thang-Jed (the total 7 types stamens) and Kae-sorn-thang-Kao (the total 9 types stamens). These stamens are the ingredients of Inthajak, Nawakot, Teppajit, Tiposod and other Ya-hom remedies. Thai people use Ya-hom as heart tonic and drink stamen tea to treat fever, stomach ulcers, bleeding gastric ulcer and use as diuretics. This study provided the information of pharmacognostic specifications, kaempferol content of *N. nucifera* stamen crude drug and its antioxidant potential.

The characteristic specifications are the primary stage that can be benefit to authenticate and qualify plant material. *N. nucifera* stamen was demonstrated for its macroscopic structures as its shape, color, size and odor. The stamen's transverse section and powders were inspected under microscope for cellular structures. This stage was essential for the purity and identification of plant material in powder form.

The physico-chemical parameters are significant to confirm the purity, identity and quality of plant materials. *N. nucifera* stamen crude drug were quantitatively determined for ethanolic extractives, water extractives, water content, loss on drying and ash values. The ethanol and water extractive values represented the amounts of active components solubilizable in the specified solvents. The choice of solvent depended on the properties of chemical components of the crude drug. The ethanol extractive value was 10.3%, whereas the water extractive value was 10.9%.

Total ash and acid-insoluble ash typically represent the non-volatile inorganic matters or minerals remaining after incineration of plant materials and are the important quality parameters. These specifications are beneficial to control crude drug adulteration or contamination in crude drug preparation. The total ash represents mineral compounds such as phosphates, carbonates, oxides, or silicates in plant tissues whereas acid insoluble ash represents some mineral compounds that are not hydrolyzed by hydrochloric acid such as silicates. Total ash and acid

insoluble ash contents higher than the specifications indicate the adulteration from sand and siliceous earth. [2].

Thin layer chromatography is a simple technique to obtain a fingerprint profile and illustrated pattern of many components in medicinal plants. Each compound can be separated and presented at different  $R_f$  value which can be used as marker for quality control. This study demonstrated TLC fingerprint of *N. nucifera* stamen crude drug using toluene, ethyl acetate, chloroform and formic acid (5 : 4 : 1 : 1) as mobile phase. Visualization was achieved under daylight, ultraviolet light (254 nm, 366 nm) and staining with anisaldehyde reagent.

From the purpose of kaempferol content in *N. nucifera* stamens crude drug, TLC densitometry and TLC image analysis by ImageJ software were used for quantitative analysis. The methods were validated in terms of linearity, specificity, accuracy, precision, LOD, LOQ and robustness.

Specificity of the method was validated through absorbance spectra under the range of 200 nm - 450 nm among standard kaempferol and the extracts. In addition, the result also revealed the identical spectra obtained at up-slope, apex and down-slope of the peak which represented chromatographic peak purity of kaempferol. The maximum absorption of kaempferol was at 375 nm in acceptance with the previous study of 370 nm [8, 56]. The calibration curves were linearity in both TLC image analysis and TLC-densitometry with the range of 0.02 - 0.36  $\mu\text{g}/\text{spot}$ .

The accuracy of TLC-densitometry and TLC image analysis were 94.0 - 109.7% and 100.0 - 112.0 % respectively, therefore both methods were accurate with % recovery between 80 - 120%. The precisions were in the acceptable value (< 5 % RSD for TLC densitometry and <10% RSD for TLC image analysis). The LOD and LOQ values of TLC- densitometry were 0.02 µg/spot and 0.05 µg/spot respectively and the LOD and LOQ values of TLC- image analysis were 0.02 µg/spot and 0.06 µg/spot respectively. For the robustness, this study designed by varying the little amounts of mobile phase ratio. In this study, the robustness of TLC densitometry and TLC image analysis were 2.5 %RSD and 0.41 %RSD of peak area respectively.

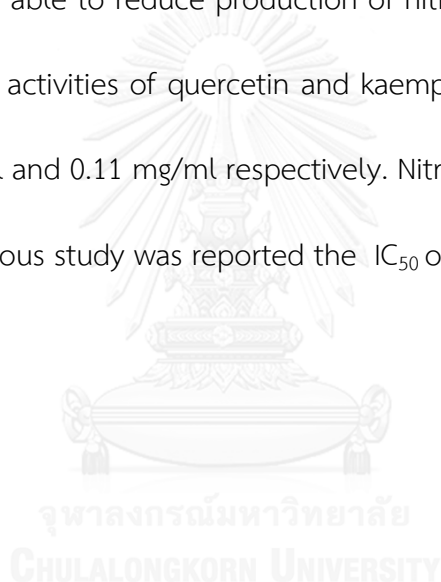
*N. nucifera* stamen exhaustively extracted in 95% ethanol using soxhlet apparatus yielded  $18.5 \pm 4.8$  grams per 100 grams of dried crude drugs which was higher than the previous report of  $10.2 \pm 0.34$  grams per 100 grams of dried crude drugs extracted in 70% acetone by soxhlet apparatus [57].

Kaempferol quantitation of the ethanolic extracts by TLC densitometry demonstrated the amount of  $0.041 \pm 0.013$  grams per 100 grams dried stamen crude drugs. The previous study in China reported the same amount of 0.042 g by HPLC [57]. The results of TLC image analysis demonstrated the amount of  $0.045 \pm 0.016$  grams per 100 grams of dried stamen crude drugs. TLC image analysis could be used instead of the TLC densitometry, as both results were insignificantly different.

Antioxidant compounds are important in medicinal part. It is a health protective factor along with the scientific evidences that antioxidant can be the diseases reducing factor particularly cancer [58]. Several antioxidant activity evaluating methods have been used to monitor and compare the antioxidant activities of natural products. Various types of reactive oxygen species have been used to estimate the capacity of herbs to scavenge or reduce free radicals *in vitro*. The antioxidant activities of *N. nucifera* stamen ethanolic extract were assessed based on characteristic radical reduction including DPPH and nitric oxide.

DPPH, the stable and well-characterized free radical is popularly used for evaluation of radical scavenging potential of the natural substances. The reduction of DPPH is used as an indicator of radical scavenger property. DPPH radical has a dark violet color in methanolic solution with the absorbance range between 515-520 nm and it becomes colorless or yellow when neutralized by hydrogen atom donated from the antioxidant [59]. The discoloration degree indicates the scavenging potential of plant extract. The color changing is monitored by spectrophotometry. In this study, the ethanolic extract of *N. nucifera* stamens was able to decolorized DPPH free radical in methanolic solution with  $IC_{50}$  of 27.31  $\mu\text{g/ml}$  compared to quercetin, ascorbic acid, BHT and kaempferol (positive control) with the  $IC_{50}$  of 3.67  $\mu\text{g/ml}$ , 68.21  $\mu\text{g/ml}$ , 24.59  $\mu\text{g/ml}$  and 25.72  $\mu\text{g/ml}$ , respectively.

Nitric oxide is significant for the body and affects physiological processes. It is a free radical that causing the oxidative stress, the tissue damage and destroys antioxidant system in the body. The procedure is based on the principle that sodium nitroprusside in aqueous solution at physiological pH automatically generates nitric oxide that produces nitrite ions when reacts with oxygen. The nitric oxide can be estimated by using Griess reagent, which give blue color [54]. In this study, *N. nucifera* stamens was able to reduce production of nitrite ions with the  $IC_{50}$  of 28.37 mg/ml. However, the activities of quercetin and kaempferol were more potent with the  $IC_{50}$  of 0.65 mg/ml and 0.11 mg/ml respectively. Nitric oxide scavenging activity of quercetin in the previous study was reported the  $IC_{50}$  of 0.2 mg/ml [60].



**APPENDIX A**

Data of physicochemical parameters of *N. nucifera* stamen





**Table 14** Determination of water content of *N. nucifera* stamens from 15 different sources

Source	No.	Amount (% by weight)	Mean	SD
1	1	11.33	11.22	0.19
	2	11.33		
	3	11.00		
2	1	11.00	10.89	0.19
	2	10.67		
	3	11.00		
3	1	9.00	8.89	0.19
	2	8.67		
	3	9.00		
4	1	8.33	8.56	0.19
	2	8.67		
	3	8.67		
5	1	8.33	8.22	0.19
	2	8.00		
	3	8.33		
6	1	9.67	9.56	0.19
	2	9.33		
	3	9.67		
7	1	13.33	13.22	0.19
	2	13.33		
	3	13.00		
8	1	10.67	10.78	0.19
	2	11.00		
	3	10.67		
9	1	10.33	10.44	0.51
	2	10.00		
	3	11.00		

**Table 14** Determination of water content of *N. nucifera* stamens from 15 different sources (Cont.)

Source	No.	Amount (% by weight)	Mean	SD
10	1	11.00	11.22	0.19
	2	11.00		
	3	10.67		
11	1	6.67	6.56	0.19
	2	6.33		
	3	6.67		
12	1	10.00	10.00	0.00
	2	10.00		
	3	10.00		
13	1	9.33	9.44	0.19
	2	9.33		
	3	9.67		
14	1	10.00	9.89	0.19
	2	9.67		
	3	10.00		
15	1	10.00	9.78	0.19
	2	9.67		
	3	9.67		
Grand mean			<b>9.89</b>	
Pooled SD			<b>0.22</b>	

**Table 15** Determination of loss on drying of *N. nucifera* stamens from 15 different sources

Source	No.	Amount (% by weight)	Mean	SD
1	1	10.71	10.76	0.05
	2	10.80		
	3	10.77		
2	1	11.47	11.44	0.08
	2	11.35		
	3	11.50		
3	1	10.64	10.55	0.12
	2	10.41		
	3	10.60		
4	1	8.06	7.80	7.80
	2	7.46		
	3	7.89		
5	1	8.19	8.21	0.02
	2	8.22		
	3	8.22		
6	1	7.92	7.21	0.62
	2	6.82		
	3	6.88		
7	1	8.77	8.17	0.11
	2	8.58		
	3	8.78		
8	1	8.05	8.02	0.03
	2	8.00		
	3	7.99		
9	1	8.10	8.20	0.09
	2	8.25		
	3	8.27		

**Table 15** Determination of loss on drying of *N. nucifera* stamens from 15 different sources (Cont.)

Source	No.	Amount (% by weight)	Mean	SD
10	1	9.17	9.16	0.04
	2	9.11		
	3	9.20		
11	1	9.63	9.69	0.14
	2	9.59		
	3	9.84		
12	1	6.06	6.38	0.57
	2	7.04		
	3	6.04		
13	1	8.28	8.34	0.08
	2	8.43		
	3	8.31		
14	1	9.72	9.17	0.09
	2	9.62		
	3	9.79		
15	1	9.82	9.82	0.03
	2	9.85		
	3	9.79		
<b>Grand mean</b>			<b>8.93</b>	
<b>Pooled SD</b>				<b>0.24</b>

**Table 16** Determination of total ash of *N. nucifera* stamens from 15 different sources

Source	No.	Amount (% by weight)	Mean	SD
1	1	5.10	5.14	0.05
	2	5.13		
	3	5.20		
2	1	4.58	4.85	0.23
	2	4.97		
	3	4.99		
3	1	4.48	4.54	0.07
	2	4.53		
	3	4.62		
4	1	5.59	5.29	0.28
	2	5.03		
	3	5.24		
5	1	4.72	4.71	0.02
	2	4.73		
	3	4.69		
6	1	4.94	5.02	0.08
	2	5.01		
	3	5.10		
7	1	5.46	5.45	0.02
	2	5.45		
	3	5.43		
8	1	4.56	4.59	0.05
	2	4.65		
	3	4.55		
9	1	5.13	5.09	0.03
	2	5.07		
	3	5.08		

**Table 16** Determination of total ash of *N. nucifera* stamens from 15 different sources (Cont.)

Source	No.	Amount (% by weight)	Mean	SD
10	1	5.15	5.13	0.02
	2	5.12		
	3	5.13		
11	1	5.63	5.63	0.02
	2	5.64		
	3	5.61		
12	1	6.29	6.44	0.02
	2	6.68		
	3	6.35		
13	1	6.05	6.07	0.21
	2	6.03		
	3	6.14		
14	1	5.27	5.28	0.01
	2	5.29		
	3	5.29		
15	1	5.22	5.21	0.01
	2	5.20		
	3	5.21		
Grand mean			5.23	
Pooled SD			0.16	

**Table 17** Determination of acid insoluble ash of *N. nucifera* stamens from 15 different sources

Source	No.	Amount (% by weight)	Mean	SD
1	1	0.70	0.72	0.02
	2	0.71		
	3	0.73		
2	1	0.91	0.94	0.02
	2	0.91		
	3	0.95		
3	1	0.71	0.73	0.02
	2	0.73		
	3	0.75		
4	1	0.70	0.82	0.12
	2	0.83		
	3	0.94		
5	1	0.74	0.70	0.12
	2	0.57		
	3	0.80		
6	1	0.71	0.75	0.09
	2	0.68		
	3	0.84		
7	1	1.18	1.19	0.04
	2	1.16		
	3	1.23		
8	1	0.54	0.60	0.06
	2	0.60		
	3	0.66		
9	1	0.94	0.93	0.03
	2	0.90		
	3	0.95		

**Table 17** Determination of acid insoluble ash of *N. nucifera* stamens from 15 different sources (Cont.)

Source	No.	Amount (% by weight)	Mean	SD
10	1	0.76	0.74	0.04
	2	0.76		
	3	0.69		
11	1	0.86	1.04	0.17
	2	1.06		
	3	1.21		
12	1	1.93	1.50	0.50
	2	0.95		
	3	1.63		
13	1	1.11	1.33	0.25
	2	1.61		
	3	1.26		
14	1	0.96	0.90	0.05
	2	0.88		
	3	0.86		
15	1	0.72	0.76	0.03
	2	0.79		
	3	0.77		
Grand mean			<b>0.91</b>	
Pooled SD			<b>0.17</b>	



**Table 18** Determination of ethanol-soluble extractive (% by weight) of *N. nucifera* stamens from 15 different sources

Source	No.	Amount (% by weight)	Mean	SD
1	1	10.04	10.22	0.25
	2	10.11		
	3	10.50		
2	1	11.21	10.30	0.60
	2	11.94		
	3	10.76		
3	1	10.68	10.18	0.51
	2	10.18		
	3	9.67		
4	1	8.93	9.12	0.37
	2	9.55		
	3	8.90		
5	1	5.93	5.97	0.11
	2	6.10		
	3	5.89		
6	1	10.06	10.01	0.07
	2	10.05		
	3	9.93		
7	1	8.60	8.26	0.45
	2	8.41		
	3	7.75		
8	1	9.07	9.20	0.21
	2	9.43		
	3	9.08		
9	1	9.48	9.58	0.10
	2	9.68		
	3	9.57		

**Table 18** Determination of ethanol-soluble extractive (% by weight) of *N. nucifera* stamens from 15 different sources (Cont.)

Source	No.	Amount (% by weight)	Mean	SD
10	1	10.74	10.80	0.16
	2	10.68		
	3	10.98		
11	1	10.53	11.0	0.37
	2	11.05		
	3	11.25		
12	1	12.88	13.18	0.27
	2	13.36		
	3	13.31		
13	1	8.67	8.55	0.11
	2	8.51		
	3	8.46		
14	1	13.98	14.06	0.24
	2	13.86		
	3	14.33		
15	1	12.78	13.14	0.31
	2	13.28		
	3	13.35		
Grand mean			10.30	
Pooled SD			0.31	

**Table 19** Determination of water-soluble extractive (% by weight) of *N. nucifera* stamens from 15 different sources

Source	No.	Amount (% by weight)	Mean	SD
1	1	11.37	10.84	0.60
	2	10.96		
	3	10.19		
2	1	14.53	14.78	0.30
	2	15.12		
	3	14.68		
3	1	9.88	9.98	0.20
	2	10.21		
	3	9.85		
4	1	8.97	8.68	0.40
	2	8.84		
	3	8.23		
5	1	8.66	8.49	0.38
	2	8.00		
	3	8.65		
6	1	8.58	8.95	0.48
	2	9.50		
	3	8.77		
7	1	11.63	11.28	0.37
	2	10.90		
	3	11.18		
8	1	12.10	11.88	0.29
	2	11.98		
	3	11.56		
9	1	10.80	10.63	0.16
	2	10.61		
	3	10.47		

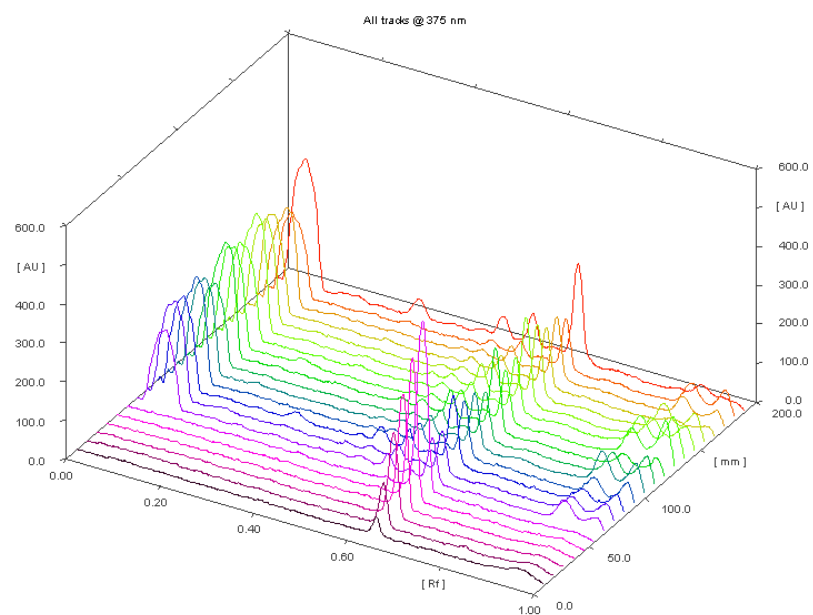
**Table 19** Determination of water-soluble extractive (% by weight) of *N. nucifera* stamens from 15 different sources (Cont.)

Source	No.	Amount (% by weight)	Mean	SD
10	1	11.04	11.07	0.08
	2	11.16		
	3	11.00		
11	1	11.60	12.04	0.47
	2	12.50		
	3	12.01		
12	1	13.88	13.71	0.15
	2	13.62		
	3	13.63		
13	1	8.97	9.03	0.60
	2	8.68		
	3	9.45		
14	1	10.63	10.72	0.17
	2	10.61		
	3	10.92		
15	1	11.35	11.73	0.60
	2	11.43		
	3	12.41		
Grand mean			10.91	
Pooled SD			0.37	

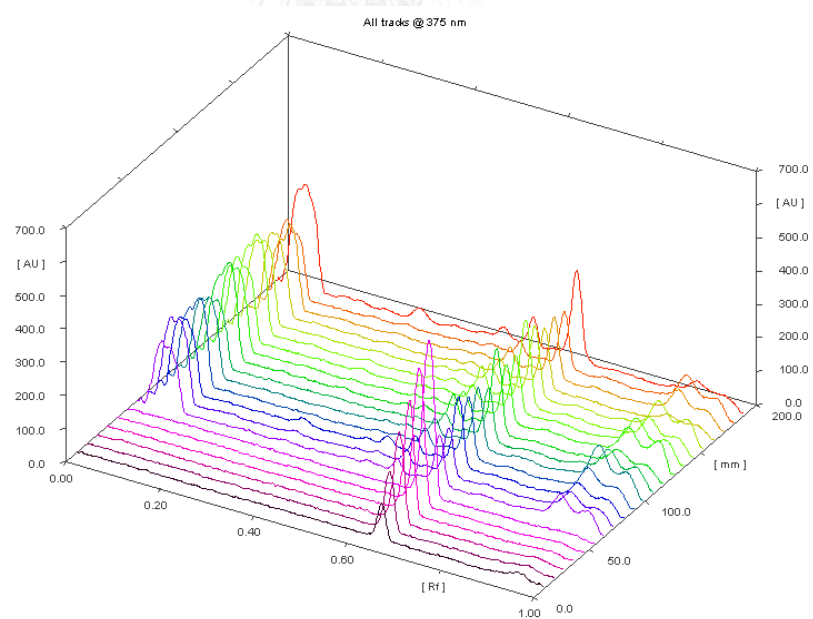
**APPENDIX B**

Data of quantitative analysis of kaempferol content of *N. nucifera* stamen

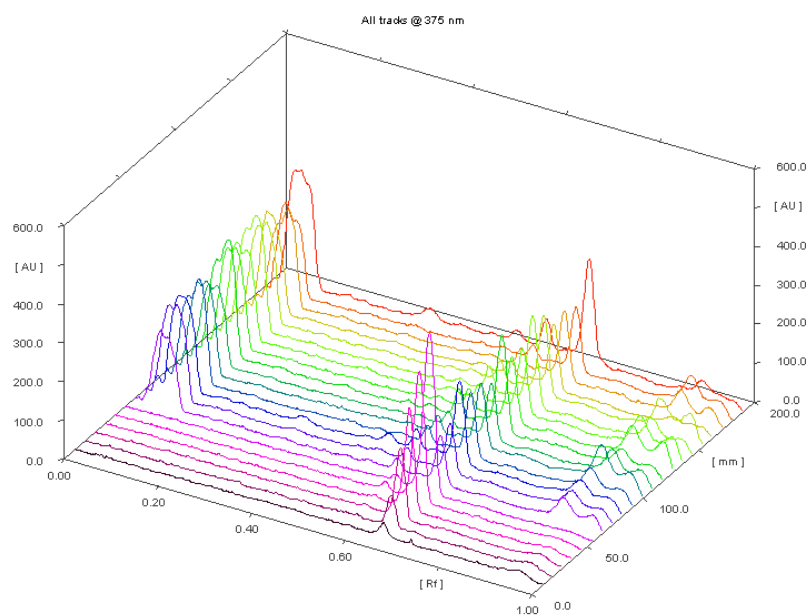




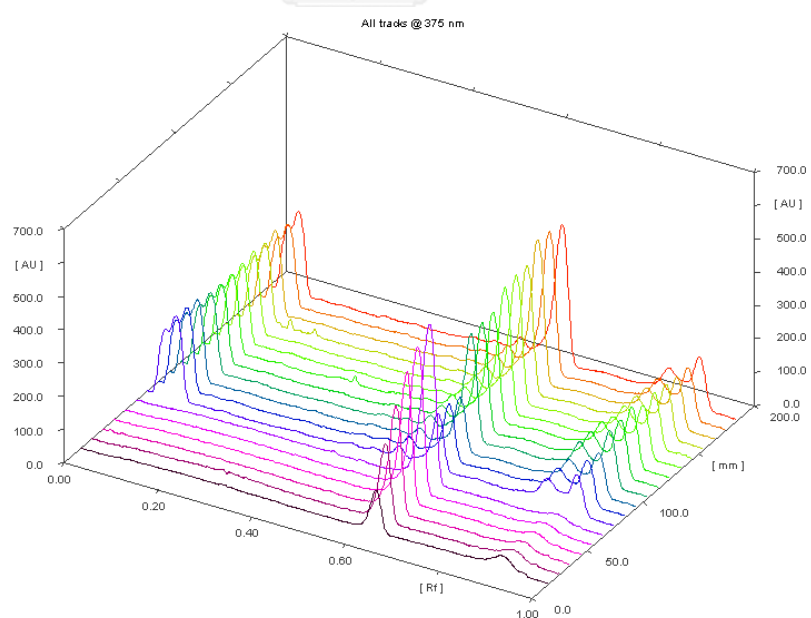
**Figure 27** 3D TLC- densitometry chromatogram  
(Plate A – standard kaempferol NO. 1-6, sample NO.7-21)



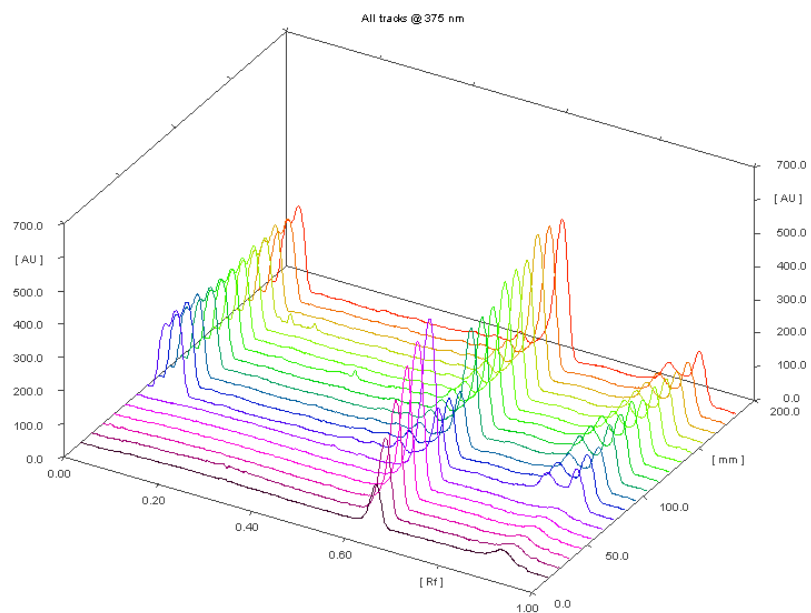
**Figure 28** 3D TLC- densitometry chromatogram  
(Plate B- standard kaempferol NO. 1-6, sample NO.7-21)



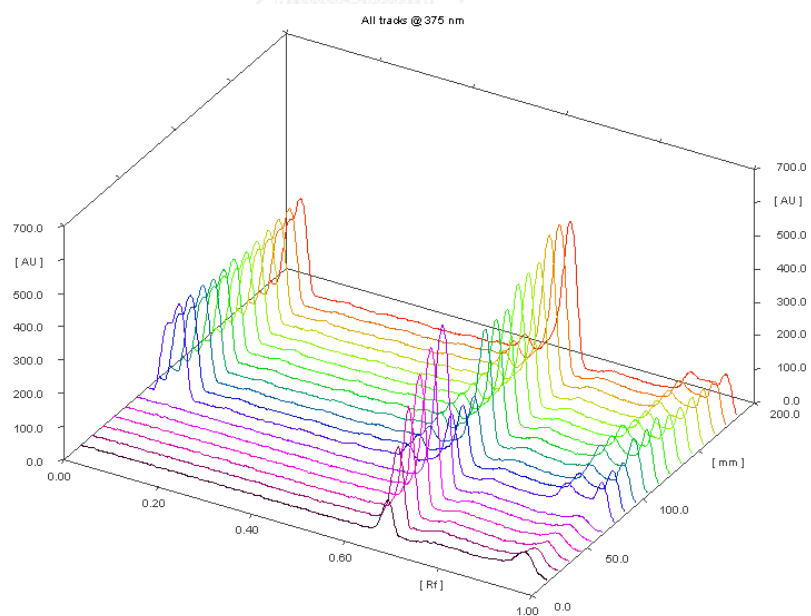
**Figure 29** 3D TLC- densitometry chromatogram  
(Plate C- standard kaempferol NO. 1-6, sample NO.7-21)



**Figure 30** 3D TLC-densitometry chromatogram (Plate D-Accuracy - standard kaempferol NO. 1-6, sample NO. 7-9, spiked standard 0.12  $\mu\text{g}/\text{spot}$  NO. 10-12, spiked standard 0.18  $\mu\text{g}/\text{spot}$  NO. 13-15, spiked standard 0.24  $\mu\text{g}/\text{spot}$  NO. 16-18)

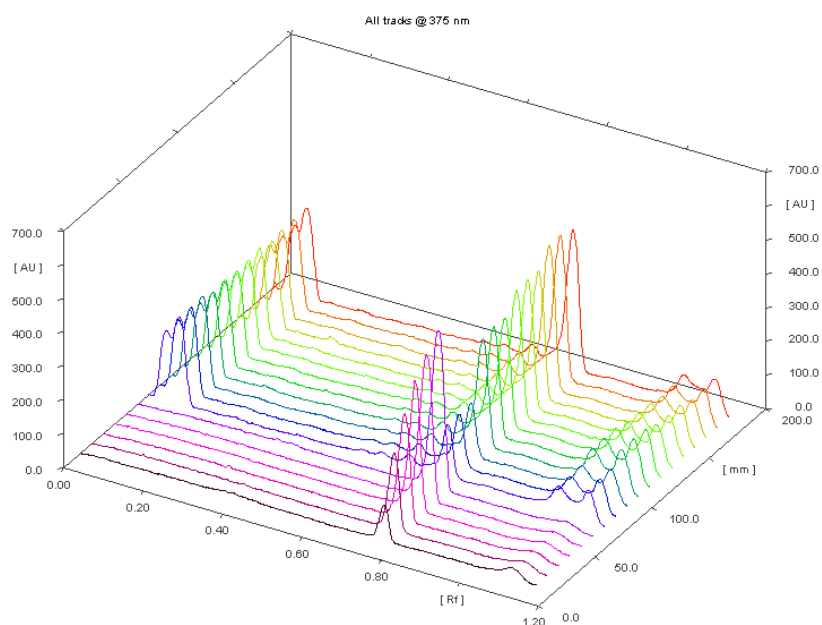


**Figure 31** 3D TLC- densitometry chromatogram (Plate E-Precision NO.1 - standard kaempferol NO. 1-6, sample NO. 7-9, spiked standard 0.12  $\mu\text{g}/\text{spot}$  NO. 10-12, spiked standard 0.18  $\mu\text{g}/\text{spot}$  NO. 13-15, spiked standard 0.24  $\mu\text{g}/\text{spot}$  NO. 16-18)

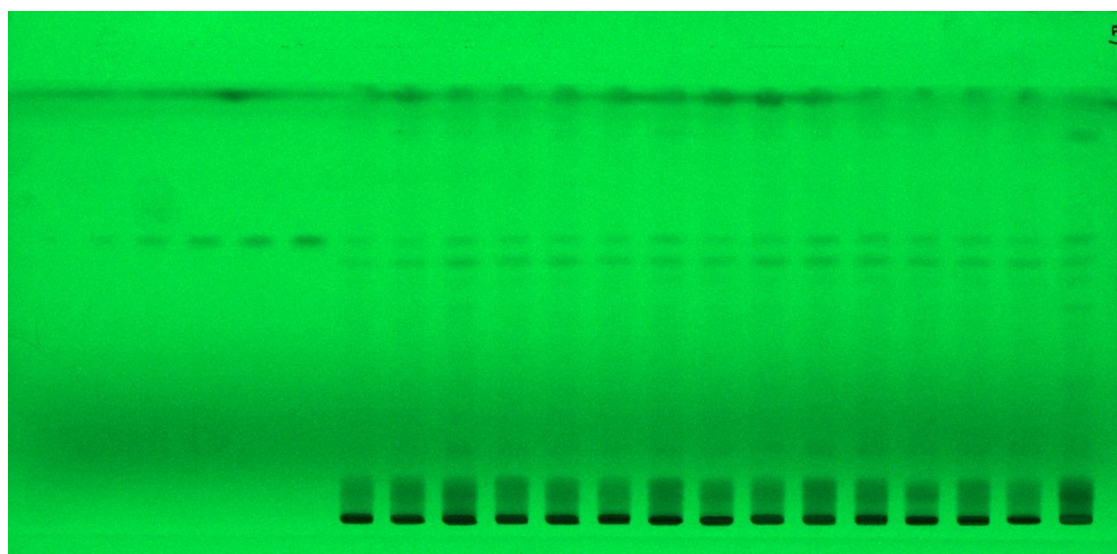


**Figure 32** 3D TLC- densitometry chromatogram (Plate F-Precision NO. 2 - standard kaempferol NO. 1-6, sample NO. 7-9, spiked standard 0.12  $\mu\text{g}/\text{spot}$  NO. 10-12, spiked standard 0.18  $\mu\text{g}/\text{spot}$  NO. 13-15, spiked standard 0.24  $\mu\text{g}/\text{spot}$  NO. 16-18)

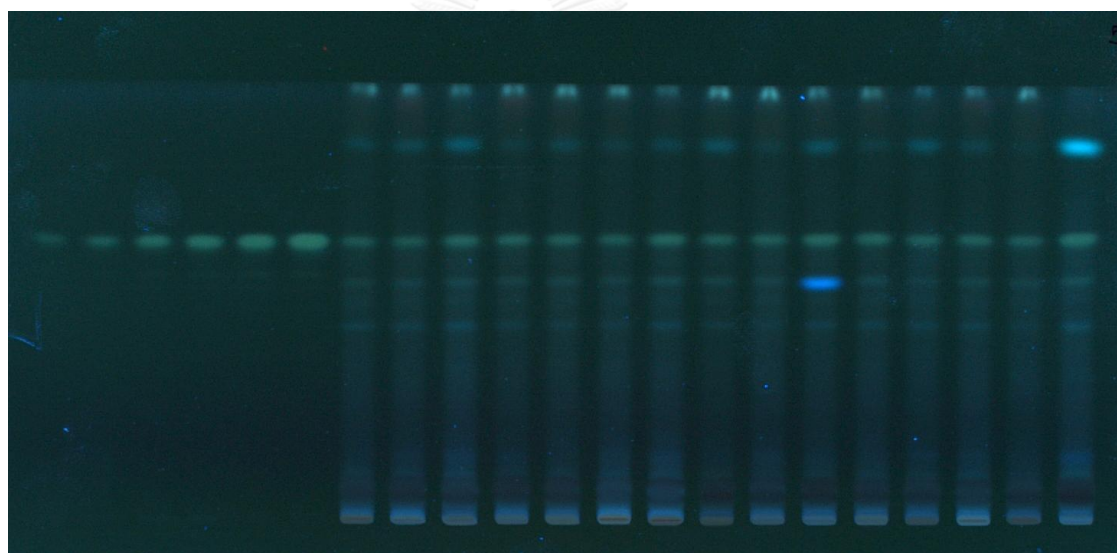




**Figure 33** 3D TLC- densitometry chromatogram (Plate G-Precision NO. 3 - standard kaempferol NO. 1-6, sample NO. 7-9, spiked standard 0.12  $\mu\text{g}/\text{spot}$  NO. 10-12, spiked standard 0.18  $\mu\text{g}/\text{spot}$  NO. 13-15, spiked standard 0.24  $\mu\text{g}/\text{spot}$  NO. 16-18)

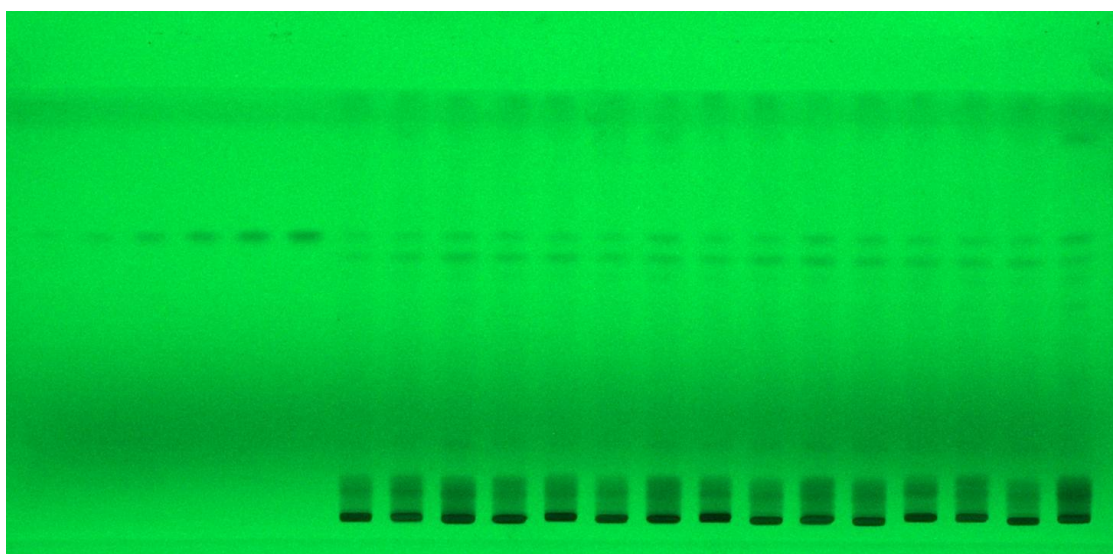


(a)

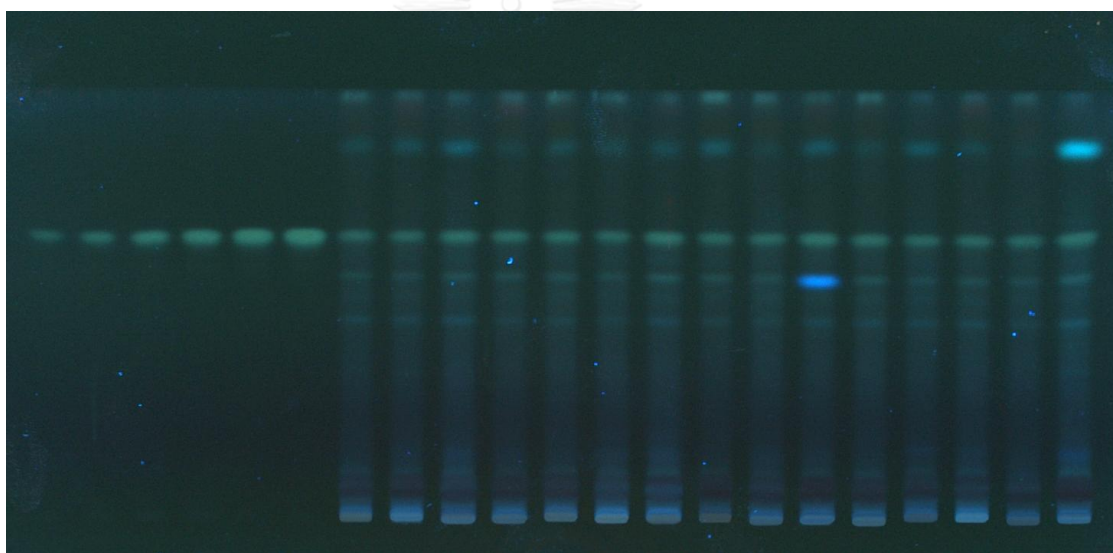


(b)

**Figure 34** The TLC Plate (A- standard kaempferol NO. 1-6, sample NO. 7-21) visual under UV 254 nm (a), with subtract background by ImageJ software (b)

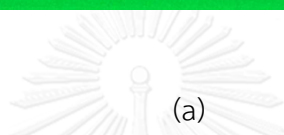
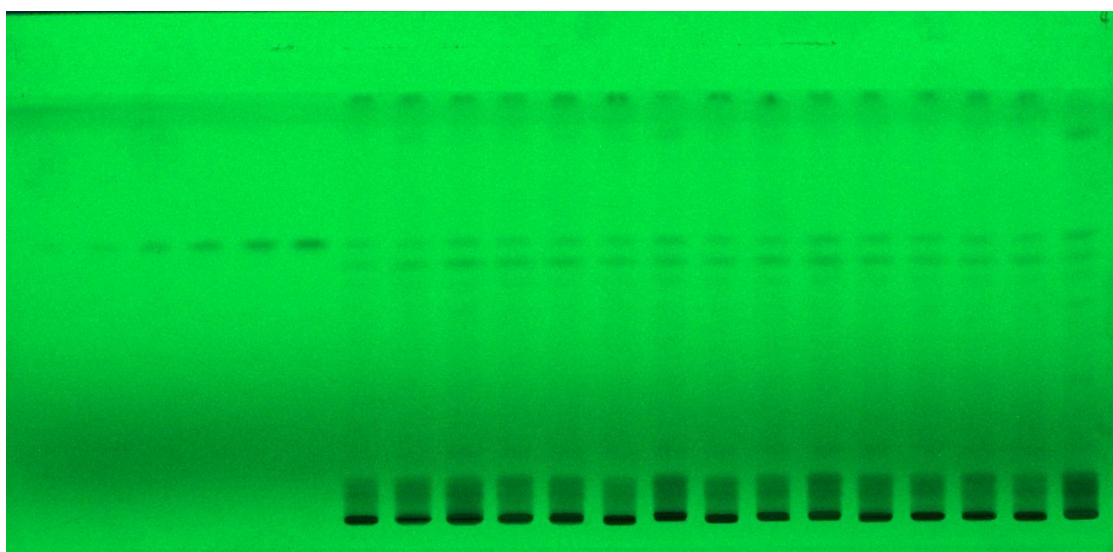


(a)

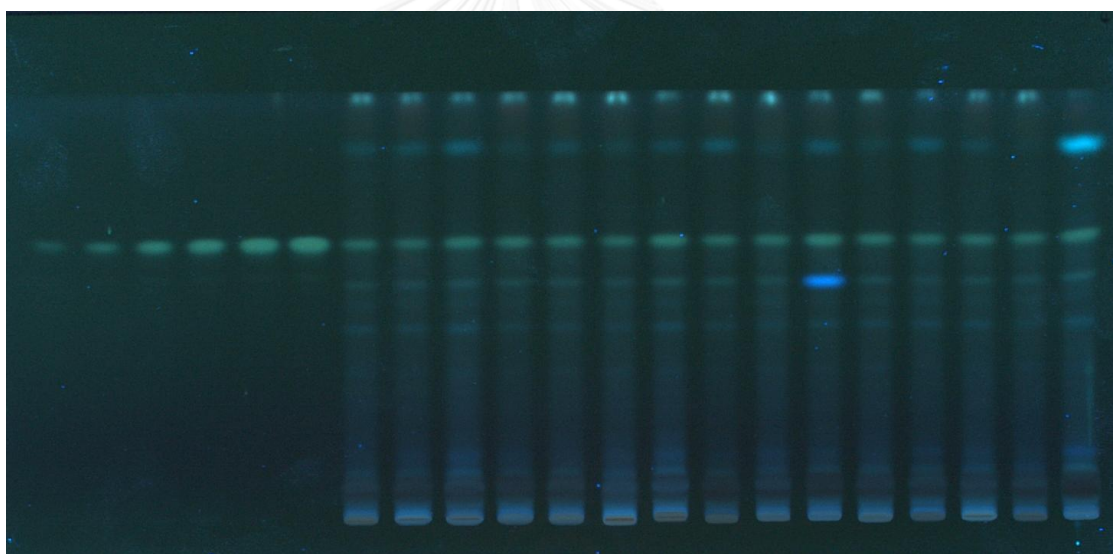


(b)

**Figure 35** The TLC Plate (B- standard kaempferol NO. 1-6, sample NO. 7-21) visual under UV 254 nm (a), with subtract background by ImageJ software (b)

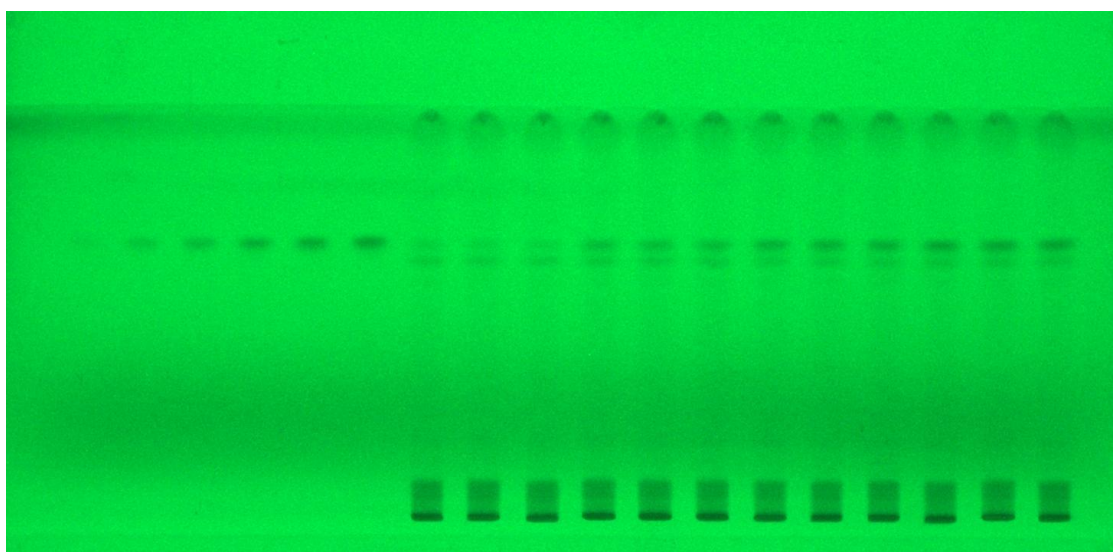


(a)

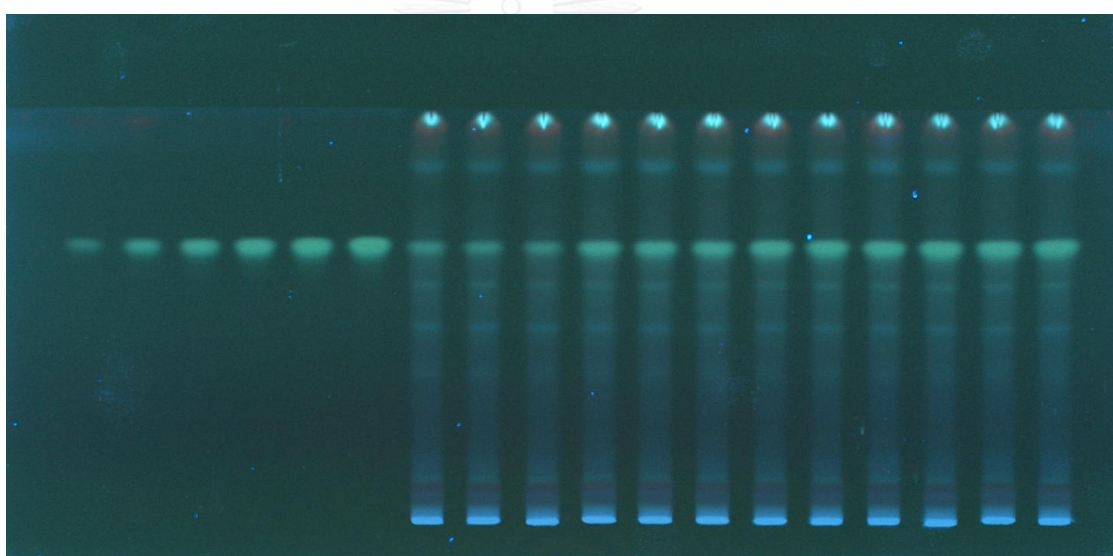


(b)

**Figure 36** The TLC Plate (C- standard kaempferol NO. 1-6, sample NO. 7-15) visual under UV 254 nm (a), with subtract background by ImageJ software (b)

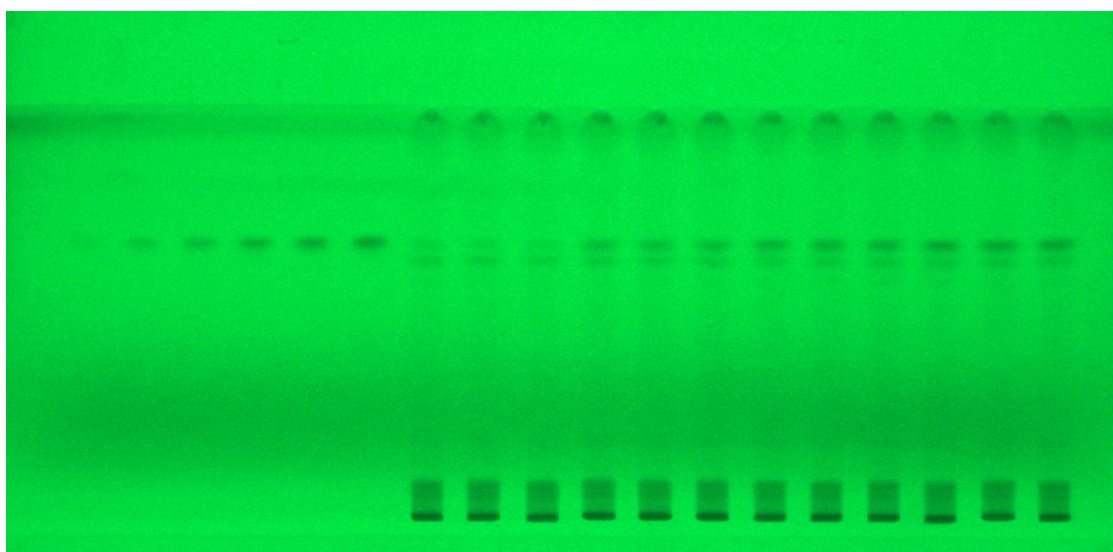


(a)

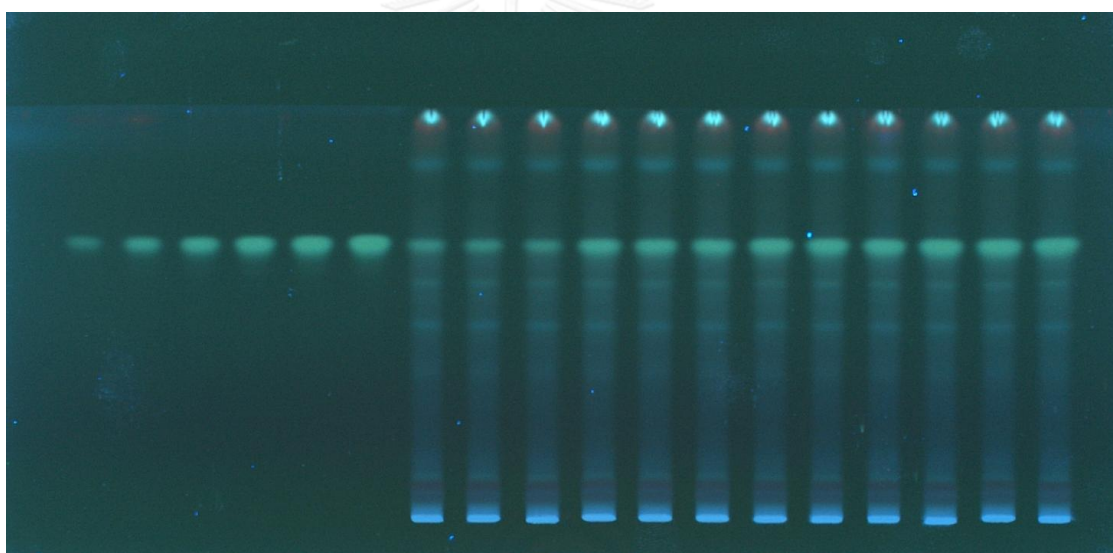


(b)

**Figure 37** The TLC Plate (D-Accuracy - standard kaempferol NO. 1-6, sample NO. 7-9, spiked standard 0.12  $\mu\text{g}/\text{spot}$  NO. 10-12, spiked standard 0.18  $\mu\text{g}/\text{spot}$  NO. 13-15, spiked standard 0.24  $\mu\text{g}/\text{spot}$  NO. 16-18) visual under UV 254 nm (a), with subtract background by ImageJ software (b)

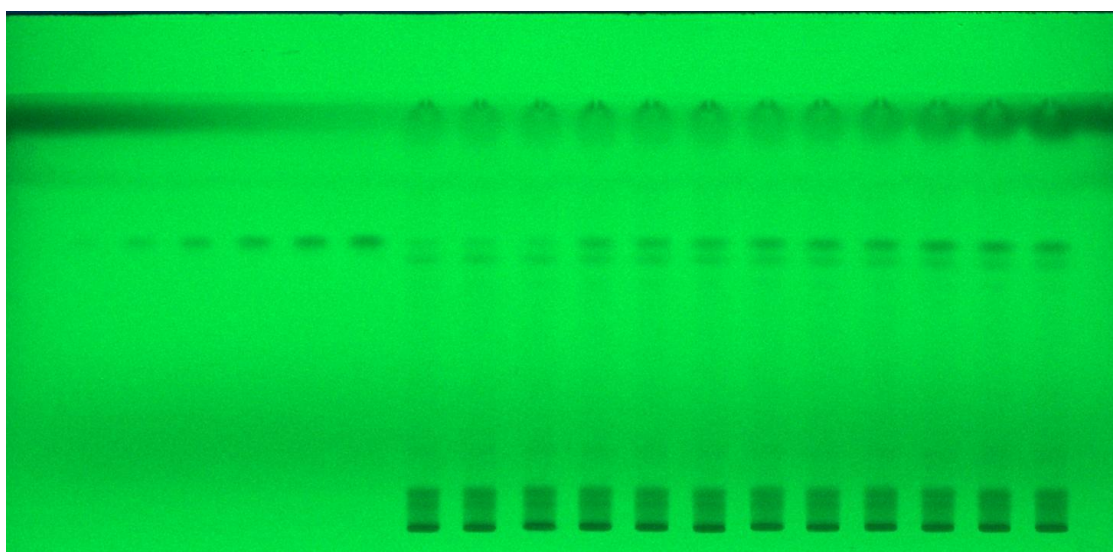


(a)

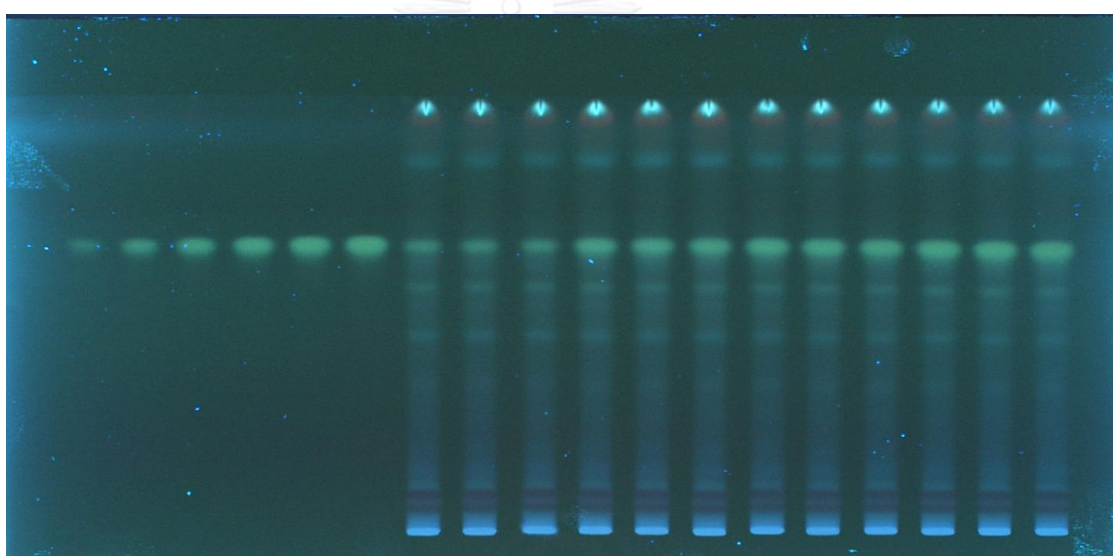


(b)

**Figure 38** The TLC Plate (E-Precision - standard kaempferol NO. 1-6, sample NO. 7-9, spiked standard 0.12  $\mu\text{g}/\text{spot}$  NO. 10-12, spiked standard 0.18  $\mu\text{g}/\text{spot}$  NO. 13-15, spiked standard 0.24  $\mu\text{g}/\text{spot}$  NO. 16-18) visual under UV 254 nm (a), with subtract background by ImageJ software (b)

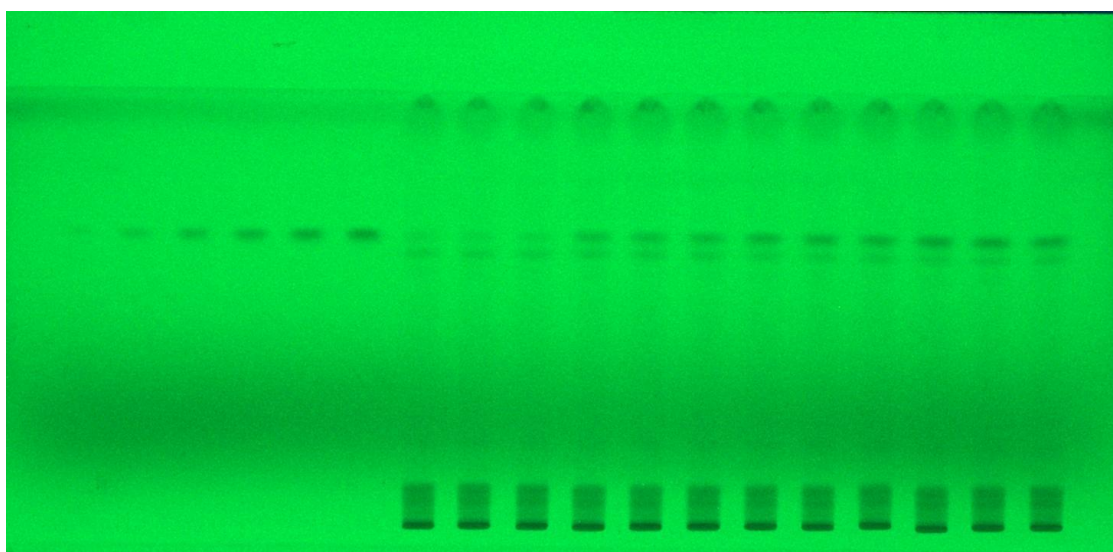


(a)

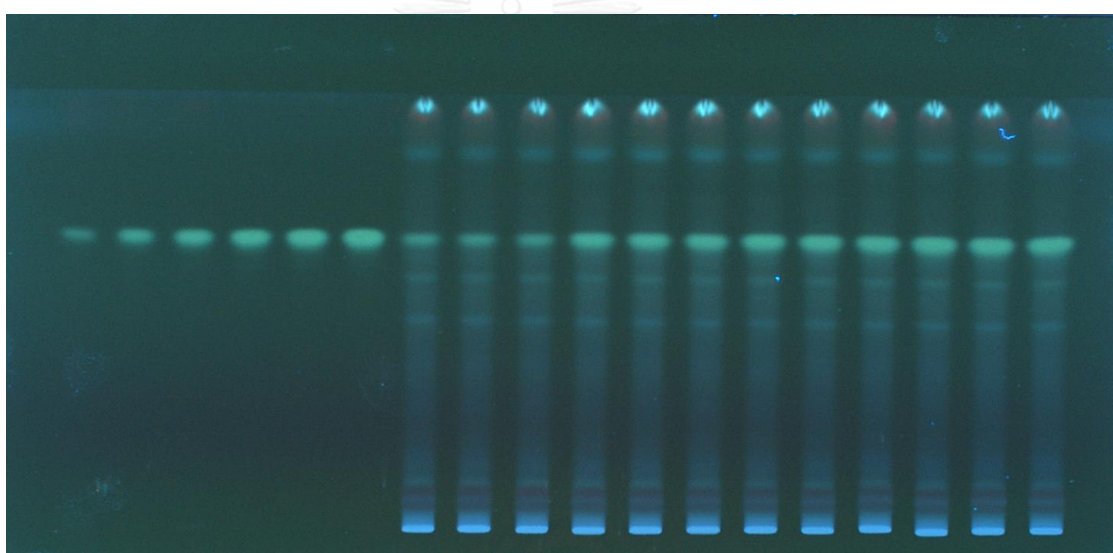


(b)

**Figure 39** The TLC Plate (F-Precision - standard kaempferol NO. 1-6, sample NO. 7-9, spiked standard 0.12  $\mu\text{g}/\text{spot}$  NO. 10-12, spiked standard 0.18  $\mu\text{g}/\text{spot}$  NO. 13-15, spiked standard 0.24  $\mu\text{g}/\text{spot}$  NO. 16-18) visual under UV 254 nm (a), with subtract background by ImageJ software (b)



(a)



(b)

**Figure 40** The TLC Plate (G-Precision - standard kaempferol NO. 1-6, sample NO. 7-9, spiked standard 0.12  $\mu\text{g}/\text{spot}$  NO. 10-12, spiked standard 0.18  $\mu\text{g}/\text{spot}$  NO. 13-15, spiked standard 0.24  $\mu\text{g}/\text{spot}$  NO. 16-18) visual under UV 254 nm (a), with subtract background by ImageJ software (b)



**APPENDIX C**

Data of antioxidant activities of *N. nucifera* stamen



**Table 20** DPPH scavenging activity of ethanolic extract of *N. nucifera* stamen

Ethanolic extracts of <i>N. nucifera</i> stamen ( $\mu\text{g/ml}$ )	OD <sub>517</sub> (reaction mixture)			DPPH scavenging (%)				
	exp 1	exp 2	exp 3	exp 1	exp 2	exp 3	Mean	SD
0.00	0.269	0.269	0.265					
7.80	0.176	0.186	0.185	34.459	30.500	31.060	32.006	2.142
15.60	0.166	0.163	0.167	38.006	39.314	37.782	38.368	0.827
31.25	0.124	0.129	0.124	53.617	51.675	53.692	52.994	1.143
62.50	0.066	0.065	0.060	75.539	75.763	77.630	76.311	1.148
125.00	0.013	0.013	0.010	95.033	95.294	96.452	95.593	0.755

**Table 21** DPPH scavenging activity of positive control (quercetin)

Quercetin ( $\mu\text{g/ml}$ )	OD <sub>517</sub> (reaction mixture)			DPPH scavenging (%)				
	exp 1	exp 2	exp 3	exp 1	exp 2	exp 3	Mean	SD
0.00	0.232	0.232	0.232					
0.63	0.200	0.199	0.218	7.429	7.857	6.571	7.286	0.655
1.25	0.200	0.199	0.200	14.286	14.714	14.286	14.429	0.247
2.50	0.143	0.145	0.145	38.714	37.857	37.857	38.143	0.495
5.00	0.087	0.090	0.083	62.714	61.429	64.429	62.857	1.505
10.00	0.019	0.018	0.019	91.857	91.857	92.000	91.905	0.083

**Table 22** DPPH scavenging activity of positive control (ascorbic acid)

Ascorbic acid ( $\mu\text{g/ml}$ )	OD <sub>517</sub> (reaction mixture)			DPPH scavenging (%)				
	exp 1	exp 2	exp 3	exp 1	exp 2	exp 3	Mean	SD
0.00	0.184	0.185	0.184					
16	0.178	0.180	0.176	3.4341	2.349	4.5191	3.434	1.085
31	0.155	0.155	0.155	15.912	15.912	15.912	15.912	0.000
63	0.111	0.115	0.116	39.782	37.612	37.069	38.154	1.435
125	0.012	0.015	0.012	93.490	91.862	93.490	92.947	0.940
250	0.008	0.009	0.006	95.660	95.117	96.745	95.841	0.829

**Table 23** DPPH scavenging activity of positive control (BHT)

BHT( $\mu\text{g/ml}$ )	OD <sub>517</sub> (reaction mixture)			DPPH scavenging (%)				
	exp 1	exp 2	exp 3	exp 1	exp 2	exp 3	Mean	SD
0.00	0.232	0.232	0.232					
3.13	0.204	0.205	0.207	11.177	10.741	9.8707	10.596	0.665
6.25	0.189	0.190	0.197	17.708	17.273	14.225	16.402	1.898
12.50	0.154	0.154	0.157	32.947	32.947	31.641	32.512	0.754
25.00	0.117	0.111	0.121	49.057	51.670	47.316	49.348	2.192
50.00	0.064	0.057	0.066	72.134	75.182	71.263	72.860	2.058

**Table 24** DPPH scavenging activity of positive control (kaempferol)

Kaempferol ( $\mu\text{g/ml}$ )	OD <sub>517</sub> (reaction mixture)			DPPH scavenging (%)				
	exp 1	exp 2	exp 3	exp 1	exp 2	exp 3	Mean	SD
0.00	0.535	0.534	0.544					
0.01	0.453	0.459	0.458	15.721	14.605	14.791	15.039	0.598
0.02	0.379	0.362	0.366	29.488	32.651	31.907	31.349	1.654
0.03	0.220	0.221	0.221	59.070	58.884	58.884	58.946	0.107
0.06	0.036	0.036	0.036	93.302	93.302	93.302	93.302	0.000
0.13	0.035	0.036	0.035	93.488	93.302	93.488	93.426	0.107

**Table 25** Nitric oxide radical inhibition activity of ethanolic extract of *N. nucifera* stamen

Ethanolic extracts of <i>N. nucifera</i> stamen (mg/ml)	OD <sub>560</sub> (reaction mixture)			NO scavenging (%)				
	exp 1	exp 2	exp 3	exp 1	exp 2	exp 3	Mean	SD
0.00	0.275	0.285	0.267					
22	0.233	0.229	0.226	15.575	16.953	18.185	16.904	1.306
24	0.228	0.206	0.215	17.424	25.399	22.173	21.665	4.012
26	0.165	0.197	0.178	40.080	28.552	35.585	34.739	5.810
28	0.131	0.141	0.149	52.441	48.780	45.880	49.033	3.288
30	0.108	0.107	0.101	60.959	61.286	63.533	61.926	1.401

**Table 26** Nitric oxide radical inhibition activity of positive control (quercetin)

Quercetin (mg/ml)	OD <sub>560</sub> (reaction mixture)			NO scavenging (%)				
	exp 1	exp 2	exp 3	exp 1	exp 2	exp 3	Mean	SD
0.00	0.275	0.285	0.267					
0.6	0.144	0.132	0.144	47.728	52.187	47.656	49.190	2.595
0.7	0.125	0.145	0.140	54.870	47.366	49.106	50.447	3.928
0.8	0.108	0.132	0.110	60.923	52.115	60.271	57.769	4.908
0.9	0.100	0.098	0.098	63.642	64.584	64.439	64.222	0.507
1	0.064	0.047	0.047	76.764	83.108	83.108	80.993	3.663
1.1	0.023	0.024	0.017	91.590	91.264	94.019	92.291	1.505

**Table 27** Nitric oxide radical inhibition activity of positive control (kaempferol)

Kaempferol (mg/ml)	OD <sub>560</sub> (reaction mixture)			NO scavenging (%)				
	exp 1	exp 2	exp 3	exp 1	exp 2	exp 3	Mean	SD
0.00	2.023	2.061	2.082					
0.06	1.398	1.394	1.436	31.982	32.176	30.133	31.430	1.128
0.07	1.313	1.390	1.321	36.117	32.371	35.728	34.739	2.060
0.08	1.284	1.313	1.281	37.528	36.117	37.674	37.107	0.860
0.09	1.201	1.206	1.209	41.567	41.323	41.177	41.356	0.197
0.1	1.269	1.073	1.004	38.258	47.794	51.151	45.735	6.689
0.11	1.011	0.979	0.955	50.811	52.368	53.536	52.238	1.367

## REFERENCES

1. Mehta, N.R., et al., *Nelumbo Nucifera (Lotus): A Review on Ethanobotany, Phytochemistry and Pharmacology*. Indian Journal of Pharmaceutical and Biological Research (IJPBR), 2013: p. 152-167.
2. World Health Organization, W.H., *Quality control methods for medicinal plant materials*. 2001.
3. Mukherjee, P.K., et al., *A review of Nelumbo nucifera Gaertn*. Ancient Sci Life, 1996. **15**: p. 268-276.
4. Gupta, S. and Ahluwalia, R., *The anther and ovule of Nelumbo nucifera a re-investigation*. Ind Bot Soc, 1979. **58**: p. 247.
5. Subramanian, S., Joseph, K.J, and A. Nair, *Flavonoids of nelumbium speciosum*. Phytochemistry, 1969. **8**(3): p. 674.
6. Ono, Y., et al., *Anti-obesity effect of Nelumbo nucifera leaves extract in mice and rats*. Ethnopharmacology, 2006. **106**(2): p. 238-244.
7. Moon, Y., Wang X., and. Morris, M., *Dietary flavonoids: Effects on xenobiotic and carcinogen metabolism*. Toxicol In Vitro, 2006. **20**(2): p. 187–210.
8. Chen, A.Y. and Chen, Y.C., *A review of the dietary flavonoid, kaempferol on human health and cancer chemoprevention*. Food Chemistry, 2013. **138**(4): p. 2099-2107.
9. Tripoli, E., et al., *Citrus flavonoids: Molecular structure, biological activity and nutritional properties: A review*. Food Chemistry, 2007. **104**(2): p. 466-479.
10. Report, I., *Nelumbo nucifera* Flora of North America 2007-2010.
11. Fruct, S., *Nelumbo nucifera Gaertner*. Flora of China. **6**: p. 114.
12. George, W.S. and Herbst, D.R., *A Tropical Garden Flora: Plants cultivated in the Hawaiian Islands and other tropical places*. The encyclopedia of Malaysia. Singapore: Archipelago Press, 2005.
13. Santosusso, T. and Swern, D., *Acid-catalysed reactions of epoxides with dimethyl sulfoxide*. J Org Chem 1985. **40**: p. 2764-2769.

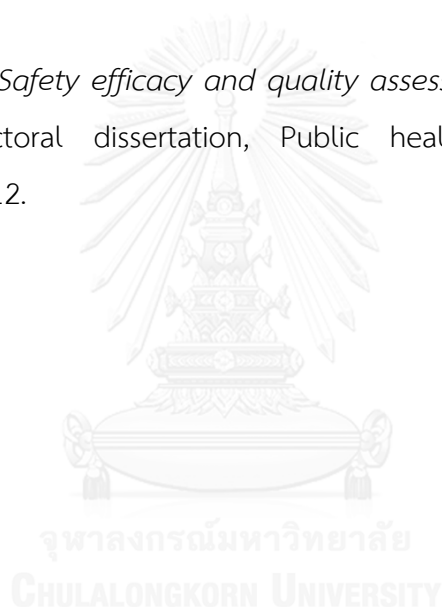
14. Hu, M. and Skibsted, L. *Antioxidative capacity of rhizome extract and rhizome knot extract of edible lotus*. Food Chemistry, 2002. **76**(3): p. 327-333.
15. Khare, C., *Indian herbal remedies: rational Western therapy, ayurvedic, and other traditional usage, Botany*. Springer, 2004: p. 326-327.
16. Nagarajan, S., *Flavonoids of the flowers of N speciosum*. Ind J Phamacol, 1965. **89**: p. 27.
17. Kunanusorna, P., et al., *Acute and subchronic oral toxicity studies of Nelumbo nucifera stamens extract in rats*. Journal of Ethnopharmacology, 2011. **134**(3): p. 789-795.
18. รุ่งระวี เต็มศิริฤกษ์กุล. และ พินิจ ชินสร้อย., ยาหอม ยาลม. เอกสารวิชาการในมหกรรมสมุนไพรแห่งชาติ ครั้งที่ 7 เรื่อง หอมกรุ่นทั่วไทย หอมไกลทั่วโลก 2553.
19. Chin, W., *A Guide to Medicinal Plants*. Singapore Science Centre, 1992: p. 108.
20. Polunin, I., *Plants and Flowers of Singapore*. Times Editions, 1987: p. 68.
21. Soepadmo, E., *The Encyclopedia of Malaysia: Plants*. Editions Didier Millet, 1998: p. 72-73.
22. Talalaj, S., *The Strangest Plants in the World*. Hill of Conten, 1991: p. 120-121.
23. ประเสริฐ พรหมมณี. และ ปริญญา อุทิศลานนท์., ตำราเภสัชกรรมไทยแผนโบราณ สำหรับผู้อบรมศึกษาวิชาแพทย์แผนโบราณ และผู้ประกอบการโรคศิลปะแผนโบราณ. กองวิชาการแพทย์โบราณ วัดมหาธาตุฯ ท่าพระจันทร์ กรุงเทพฯ, 2515.
24. Wu, M., et al., *Antioxidant activity of methanol extract of the lotus leaf (Nelumbo nucifera Gertn.)*. Am J Chin Med 2003. **31**: p. 687-698.
25. Jung, H., et al., *Antioxidant principles of Nelumbo nucifera a stamens*. Arch Pharm Res 2003. **26**(4): p. 279-285.
26. Yang, D., et al., *Antioxidant activities of various extracts of lotus (Nelumbo nucifera Gaertn) rhizome*. Asia Pacific J Clin Nutr, 2007. **16**: p. 58-163.
27. Sinha, S., et al., *Evaluation of Antipyretic Potential of Nelumbo nucifera Stalk Extract*. Phytother. Res, 2000. **14**(4): p. 272-274.
28. Lim, S., et al., *Rat lens aldose reductase inhibitory constituents of Nelumbo nucifera stamens*. Phytother Res, 2006. **20**(10): p. 825-830.
29. Mukherjee, P.K., et al., *Antibacterial efficiency of Nelumbo nucifera (Nymphaeaceae) rhizome extract*. Ind Drugs, 1995. **32**: p. 274-276.

30. Mukherjee, P.K., et al., *Antifungal screening of Nelumbo nucifera (Nymphaeaceae) rhizome extract*. Ind J Microbiol, 1995. **35**: p. 327–330.
31. Mukherjee, P.K., et al., *Diuretic activity of the rhizomes of Nelumbo nucifera Gaertn (Fam. Nymphaeaceae)*. Phytother Res., 1996. **10**: p. 424–425.
32. Mukherjee, P., et al., *Studies on the anti-inflammatory activity of rhizomes of Nelumbo nucifera*. Planta Med, 1997. **63**: p. 367-369.
33. Kim, J., et al., *Effects of Nelumbinis Semen on contractile dysfunction in ischemic and reperfused rat heart*. Arch Pharm Res, 2006. **29**(9): p. 777-785.
34. Calderón-Montaña, J., et al., *A review on the dietary flavonoid kaempferol*. Mini Rev Med Chem., 2011. **4**: p. 298-344.
35. Chen, D. and Dou, Q.P., *Tea polyphenols and their roles in cancer prevention and chemotherapy*. Int. J. Mol. Sci, 2008. **9**: p. 1196-1206.
36. Casagrande, F. and Darbon, J., *Effects of structurally related flavonoids on cell cycle progression of human melanoma cells: regulation of cyclin-dependent kinases CDK2 and CDK11*. Biochemical Pharmacology, 2001. **61**(10): p. 1205-1215.
37. Grivennikov, S., Greten, F., and Karin, M., *Immunity, Inflammation, and Cancer*. Cell, 2010. **140**(6): p. 883-899.
38. López-Sánchez, C., et al., *Blood micromolar concentrations of kaempferol afford protection against ischemia/reperfusion-induced damage in rat brain*. Brain Research, 2007. **1182**(0): p. 123-137.
39. Huang, Y., et al., *Anti-oxidant activity and attenuation of bladder hyperactivity by the flavonoid compound kaempferol*. International Journal of Urology, 2014. **21**(1): p. 94-98.
40. Niestroy, J., et al., *Single and concerted effects of benzo[a]pyrene and flavonoids on the AhR and Nrf2-pathway in the human colon carcinoma cell line Caco-2*. Toxicology in Vitro, 2011. **25**(3): p. 671-683.
41. Mongkolrat, S., Palanuvej C., and Ruangrunsi N., *Quality assessment and liriodenine quantification of Nelumbo nucifera dried leaf in Thailand*. Phcog J, 2012. **4**(32): p. 24-28.
42. Mille, M.J., *Chromatogram: concept and contrasts*. Wiley-Interscience, 2005.



43. Ferrero-Miliani, R.W., *imageJ User Guide*. IJ1.46r, 2012.
44. Rice-Evans, C. and Gopinathan V., *Oxygen toxicity, free radicals and antioxidants in human disease: Biochemical implications in atherosclerosis and the problems of premature neonates*. *Essays Biochem*, 1995. **29**: p. 39–63.
45. Lobo, V., et al., *Free radicals, antioxidants and functional foods: Impact on human health*. *Pharmacogn Rev*, 2010. **4**(8): p. 118–126.
46. Valko, M., Morris, H., and Cronin, M., *Metals, Toxicity and Oxidative Stress*. *Current Medicinal Chemistry*, 2005. **12**(10): p. 1161-1208.
47. Aruoma, O.I., et al., *The antioxidant action of N-acetylcysteine: Its reaction with hydrogen peroxide, hydroxyl radical, superoxide, and hypochlorous acid*. *Free Radical Biology and Medicine*, 1989. **6**: p. 593–597.
48. Valko, M., et al., *Free radicals and antioxidants in normal physiological functions and human disease*. *The International Journal of Biochemistry & Cell Biology*, 2007. **39**(1): p. 44–84.
49. Sharma, N., *Free Radicals, Antioxidants and Disease*. *Biology and Medicine*, 2014. **6**(4).
50. Halliwell, B., *How to characterize an antioxidant- An update*. *Biochem Soc Symp*, 1995. **61**: p. 73–101.
51. Jung, H., *Antioxidant principles of Nelumbo nucifera stamens*. *Arch Pharm Res*, 2003. **26**: p. 279–285.
52. Brand-Williams, W., Cuvelier, M., and Berset, C., *Use of free radical method to evaluate antioxidant activity*. *Lebensmittel Wissenschaft and Technologie* 1995. **1**(28): p. 25-30.
53. Jorge, A.M.P. and Tomás, A.F.A, *Chemistry of Natural Antioxidants and Studies Performed with Different Plants Collected in Mexico*. *Agricultural and Biological Sciences*, 2013: p. 978-953.
54. Brecht, D. and Snyder, S., *Nitric Oxide: A Physiologic Messenger Molecule*. *Annu.Rev.Biochem*, 1994. **63**(1): p. 175-195.
55. Valko, M., et al., *Free radicals and antioxidants in normal physiological functions and human disease*. *Int J Biochem Cell Biol*, 2007. **1**: p. 44-84.

56. Barrington, R., et al., *Absorption, conjugation and efflux of the flavonoids, kaempferol and galangin, using the intestinal CaCo-2/TC7 cell* Journal of Functional Foods, 2009. **1**(1): p. 74-87.
57. Liu, J., et al., *Systematic chemical analysis of flavonoids in the Nelumbinis stamen* Phytomedicine, 2014 **21**(13): p. 1753-1758.
58. Borek, C., *Dietary Antioxidants and Human Cancer*. Integrative Cancer Therapies, 2004. **3**(4): p. 333-341.
59. Hinneburg, I., Damien, H.J., and Hiltunen, R., *Antioxidant activities of extracts from selected culinary herbs and spices*. Food Chemistry, 2006. **97**(1): p. 122-129.
60. Manohan, R., *Safety efficacy and quality assessment of BEN-CHA-MOON-YAI remedy*. Doctoral dissertation, Public health sciences Chulalongkorn University, 2012.





## VITA

Miss Naruemon Witheethummasak was born on January 21, 1991 in Bangkok, Thailand. She got a Bachelor's degree of Applied Thai Traditional Medicine from Suan Sunandha Rajabhat University (SSRU), Thailand in 2013.

### Publication

Witheethummasak, N., Thitikornpong W., Palanuvej, C., and Ruangrunsi, N. Pharmacognostic specification and kaempferol content of *Nelumbo nucifera* stamens. Proceedings of The 2nd International Conference on Advanced Pharmaceutical Research Strategies and Innovation in Pharmaceutical Research: Safety, Efficacy and Quality, Pathumthani, 2015.

