

# CHAPTER 1

## INTRODUCTION



Pentachlorophenol (PCP) is one of the most biocide used throughout the world. PCP is corrosive and toxic but it is readily degraded by sunlight, animals, plants, and soil microorganism. PCP was introduced in the 1930s as a preservative for timber and lumber. It is also employed as a biocide in agriculture and various industries. Major registered uses of PCP in the United States of America (U.S.A.) and the United Kingdom are listed in Table1.1 and Table 1.2. Among its various applications, it had been used extensively in water systems as a molluscicide for bilharzia control (particularly in the Far East), as a fungicide for wicker products such as baskets (Hong Kong), and as a disinfectant for cleaning floors (U.S.A.). However, in the past, the major use of PCP was for wood preservation (Crosby et al., 1981).

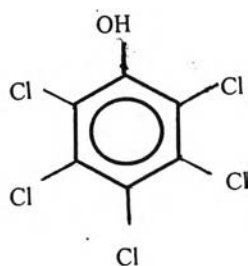

Figure 1.1 Chemical structure of pentachlorophenol.

Table 1.1 Major registered uses of pentachlorophenol in United State of America

(Crosby et al., 1981).

Use	Form
Herbicide and desiccant for forage seed crops	PCP <sup>a</sup>
Insecticides for beehives, seed plots, greenhouse use	PCP <sup>a</sup>
Microbiostat for commercial and industrial water cooling	NaPCP <sup>b</sup>
Postharvest wash for fruit	NaPC <sup>b</sup>
Microbiocide for burlap, canvas, cotton, rope and twine	PCP <sup>a</sup>
Microbiocide for leather	KPCP <sup>c</sup> , PCP <sup>a</sup>
Microbiocide and insecticide for wood treatment	NaPCP <sup>b</sup> , PCP <sup>a</sup>
Preservative for oil and water-based paint	PCP <sup>a</sup>
Slime control for pulp and paper	PCP <sup>a</sup>
Microbiocide for petroleum drilling mud and flood water	PCP <sup>a</sup>
Fumigant for shipping-van interiors	PCP <sup>a</sup>
Preservative for hardboard and particle-board	PCP <sup>a</sup>
Herbicide for non-food vegetation control	PCP <sup>a</sup>

Table 1.2 Non-agricultural uses of pentachlorophenol in Great Britain (Crosby et al., 1981).

Use	Form
Anti-mildew agent in the wool textile industry	LPCP <sup>d</sup> , NaPCP <sup>b</sup>
Mothproofing carried out by dyers and cleaners	LPCP <sup>d</sup>
Wood preservation	LPCP <sup>d</sup> , NaPCP <sup>b</sup> , PCP <sup>a</sup>
Paint additives	PCP <sup>a</sup>
Antimicrobial (slimicide) agents in paper and board	PCP <sup>a</sup>
Antifungal agent in textiles other than wool (cotton, flax and jute fabrics, ropes, cordage and tentage)	LPCP <sup>d</sup>
Cable impregnation	LPCP <sup>d</sup>
Fungicide in adhesive	NaPCP <sup>b</sup>

<sup>a</sup> pentachlorophenol; <sup>b</sup> sodium pentachlorophenol; <sup>c</sup> potassium pentachlorophenol;<sup>d</sup> laundry pentachlorophenate

Today, production of PCP has decreased, since highly toxic chlorinated dioxin formed in the PCP production process and environmental pollution by PCP are concerned. PCP is also recalcitrant in natural environment; soil, water and sewage. Although PCP production is now limited, but the uses of PCP worldwide results in widespread contamination of PCP in the environment especially in soil and ground water. Decontamination of PCP by several approaches have been investigated and examined. Traditional cleanup method for PCP, such as physical cleanup using activated charcoal, was evaluated and found to be costly. Biological cleanup using microorganism capable of mineralizing PCP has been a potent solution for decontamination of PCP in environment. This has advantages over the traditional method in terms of cost effectiveness. Study of microorganism metabolic processes of PCP degradation let us understand the fate of PCP intermediates that are crucial for effective technical design for PCP bioremediation.

### **1.1 Nature of pentachlorophenol**

PCP is a polychlorinated aromatic compound which acts as an uncoupler of oxidative phosphorylation (Saber and Crawford, 1985). It is corrosive and absorbed by skin causing burns and blisters. It is highly irritating to the nose and throat. Acute exposure to PCP leads to elevated body temperature and blood pressure, increased respiratory rate and bowel action, hyperglycemia, cardiovascular distress, urinary output, fever, motor weakness, collapse with convulsions, lung, liver and kidney damage, contact dermatitis and death. (Crosby et al., 1981; Patnaik, 1992 Lange and Orser, 1994).

## 1.2 Methods of manufacture of pentachlorophenol

PCP is chemically synthesized either by the chlorination of phenol or by hydrolysis of hexachlorobenzene. In the classical process, chlorophenol are produced from the respective higher chlorinated benzenes by hydrolysis in 10-15% solutions of sodium hydroxide or sodium carbonate at temperature of 360°C and pressure of 280-300 bar. The Raschig-Hooker process uses catalytic hydrolysis with catalysts, such as calcium phosphate or silicates and temperature of 450°C (Crosby et al., 1981). Both processes have been used in chemical industries for production of PCP throughout the world. Chemical synthesis of technical-grade PCP provides a main source of PCP and contaminants unwanted by the production, such as neutral and phenolic polychlorination reaction products. The phenolic compounds including trichlorophenol, tetrachlorophenols, perioxins and isoperioxins (Jensen and Renberg, 1972) are formed by the condensation of two PCP molecules (Fig 1.2). The neutral contaminations include polychlorodibenzo-dioxins such as compound IV formed by ring-closure of perioxins (II); polychloro-dibenzofurans such as compound VII formed by the reaction of PCP with hexachloro-benzene by loss of HCl; polychlorodiphenyl ethers such as compound V formed by free-radical condensations of PCP; chlorinated cyclohexenones and cyclohexadienones, notably 2,3,4,4,5,6-hexachlorocyclohexa-2,5-dien-1-one (hexachlorophenol, VIII) formed by radical chlorination of chlorophenol, and (compound V), hexachlorobenzene (HCB, compound VI) (Crosby et al., 1981).

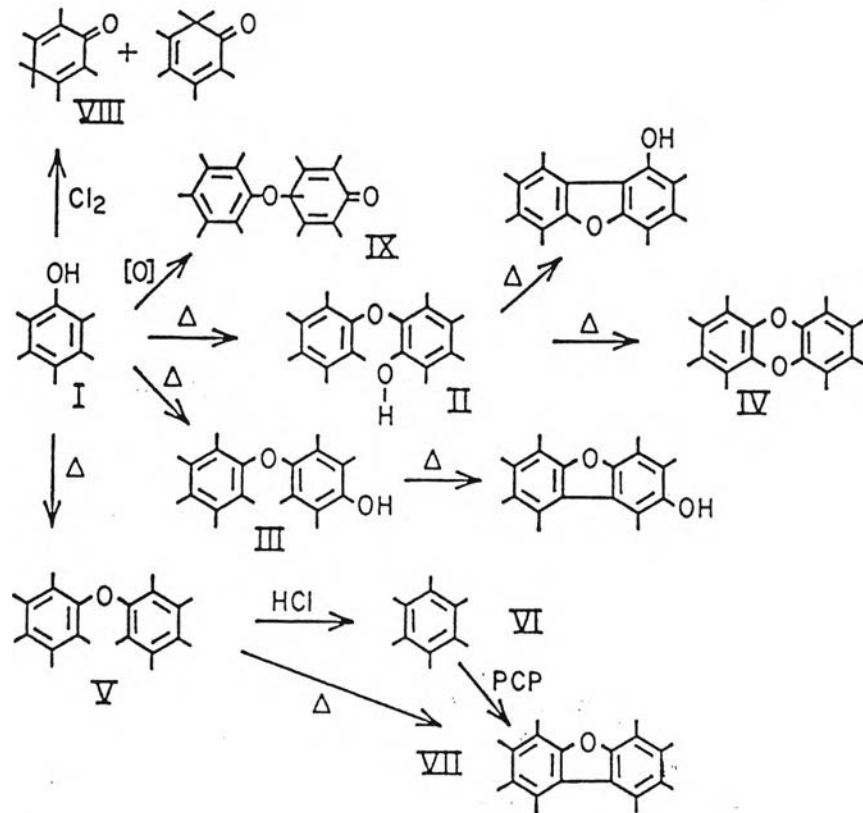

Figure 1.2 Formation of pentachlorophenol and its impurities in pentachlorophenol production processes (Crosby et al., 1981).

[O]: oxidation reaction;  $\Delta$ : heat; I: Pentachlorophenol; II: Peridioxin; III: Iso-perdioxin; IV: Dioxin; V: Decachlorodiphenyl ether; VI: Hexachlorobenzene; VII: Octachlorodibenzofuran; VIII: Hexachlorophenol IX: 2,3,4,5,6-pentachloro-4-pentachlorophenoxy-2,5-cyclohexadienone.

### 1.3 Chemical properties of pentachlorophenol

Similarly to other phenolic compounds, hydroxyl group of PCP takes part in nucleophilic reactions (e.g. it forms esters with organic and inorganic acids, and esters with alkylating agents such as methyl iodide or diazomethane). Electron withdrawal by chlorine causes PCP to be unusually acidic ( $pK_a$  4.70 in water) and be relatively weak nucleophile. To stabilize intact PCP, PCP is often prepared in commercial form of sodium salt, such as sodium pentachlorophenate. Although the high degree of chlorination makes the aromatic ring sufficiently electropositive to form stable charge-transfer complexes with electron donors, the ring chlorines are as resistant to nucleophilic displacement under normal conditions as those of the chlorinated aromatic hydrocarbons (Crosby et al., 1981).

Oxidation of PCP produces pentachlorophenol radicals, which react reversibly to form a dimer. For example, in the presence of fuming nitric acid or nitronium fluoborate, PCP is oxidized to give 2,3,4,5,6-pentachloro-4-pentachlorophenoxy-2,5-cyclohexadienone (IX) (Crosby et al., 1981).

The absorption of light energy allowed PCP to undergo a number of reactions under very mild conditions. The maximal absorption wavelength is near 300 nm in organic solvents or aqueous solution with pH below 5. In water or organic solvents, PCP undergoes photochemical reduction to isomeric trichlorophenols and tetrachlorophenols (Fig 1.3). Nucleophiles, such as bromide ion, can displace chloride of the sunlight excited PCP ring in dilute aqueous solution. PCP or its salts undergo the replacement of ring chlorines by hydroxyl groups. The resulting tetrachlorohydroquinone (X), tetrachlorocatechol (XI) and tetrachlororesorcinol (XII) are readily oxidized by air to quinones such as chloranil (XIII) which are subsequently dechlorinated. The tetrachlorodiols react with the quinones to give a variety of non-toxic minor products; under most circumstances, then the quinone is rapidly degraded

to dichloromaleic acid (XIV), which is converted to small fragments,  $\text{CO}_2$ , and  $\text{HCl}$  (Crosby et al., 1981).

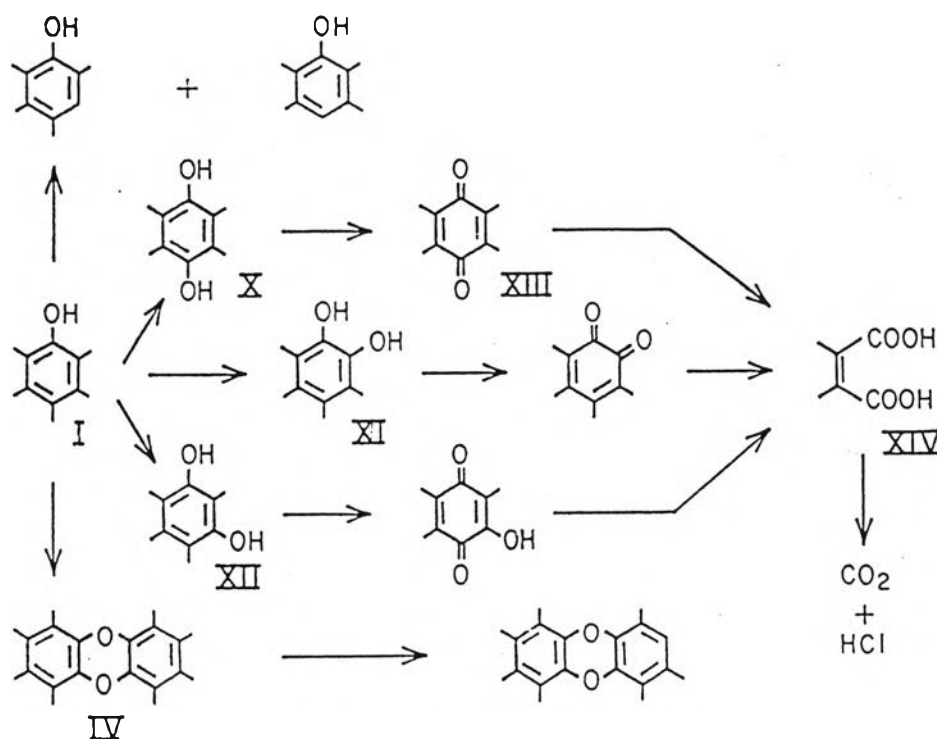

Figure 1.3 Photolysis of pentachlorophenol(Crosby et al., 1981).

I: Pentachlorophenol; IV: Octachlorodibenzodioxin;

X: Tetrachlorohydroquinone; XI: Tetrachlorocatechol;

XII: Tetrachlororesorcinol; XIII: Chloranil; XIV: Dichloromaleic acid.

#### 1.4 Physical properties of pentachlorophenol

PCP ( $\text{C}_6\text{HCl}_5\text{O}$ ) is composed of 27.05% C, 0.38% H, 66.56% Cl and 6.01% O. The molecular weight is 266.35. Pure PCP is white crystalline solid, while the commercial grade of PCP is generally tan or gray flakes. Melting temperature of pure anhydrous PCP is ca.  $190^\circ\text{C}$  whereas the technical PCP is ca.  $187\text{-}189^\circ\text{C}$ . PCP salts have higher melting temperatures. PCP is soluble in most organic solvent but only

slightly soluble in water. However, its solubility, volatility, and partitioning must be considered in relation to its ionization. At pH 2.7, PCP is only 1% ionized, while at pH 6.7 it is 99% ionized. The UV absorption spectra also depend upon pH of solution. PCP showed an absorption maximum at 303 nm at alkaline pH. Some general physical properties of PCP are summarized in table 1.3 (Crosby et al., 1981).

Table 1.3 Some selected physical properties of pentachlorophenol (Crosby et al., 1981).

Property	
Mp (°C)	190.2
Bp (°C)	300.6
Vp Torr (mm Hg)	
0 °C	$1.7 \times 10^{-5}$
20 °C	$1.7 \times 10^{-4}$
50 °C	$3.1 \times 10^{-3}$
100 °C	0.14
200 °C	25.6
300 °C	758.4
Solubility in water (g/l)	
0 °C	0.005
20 °C	0.014
30 °C	0.020
50 °C	0.035
70 °C	0.085
Solubility in organic solvent (g/l, 25°C)	
Methanol	180
Acetone	50
Benzene	15
pK <sub>a</sub> (25°C)	4.70



## 1.5 Biological uptake and transformation of pentachlorophenol

PCP is apparently absorbed and degraded readily by most living things at non-toxic levels (Fig 1.4). Under aerobic conditions, the principal detoxification products are tetrachlorohydroquinone (and tetrachlorocatechol), water-soluble conjugates, and in microorganism at least pentachloroanisole. Although PCP is absorbed strongly to acidic soil, it could be biodegraded in a few weeks. Under anaerobic (flooded) conditions, breakdown of PCP and the principal products of degradation are tetra-, tri- and dichlorophenols. There is no evidence of biological conversion of PCP to dioxins or dibenzofurans (Crosby et al., 1981).

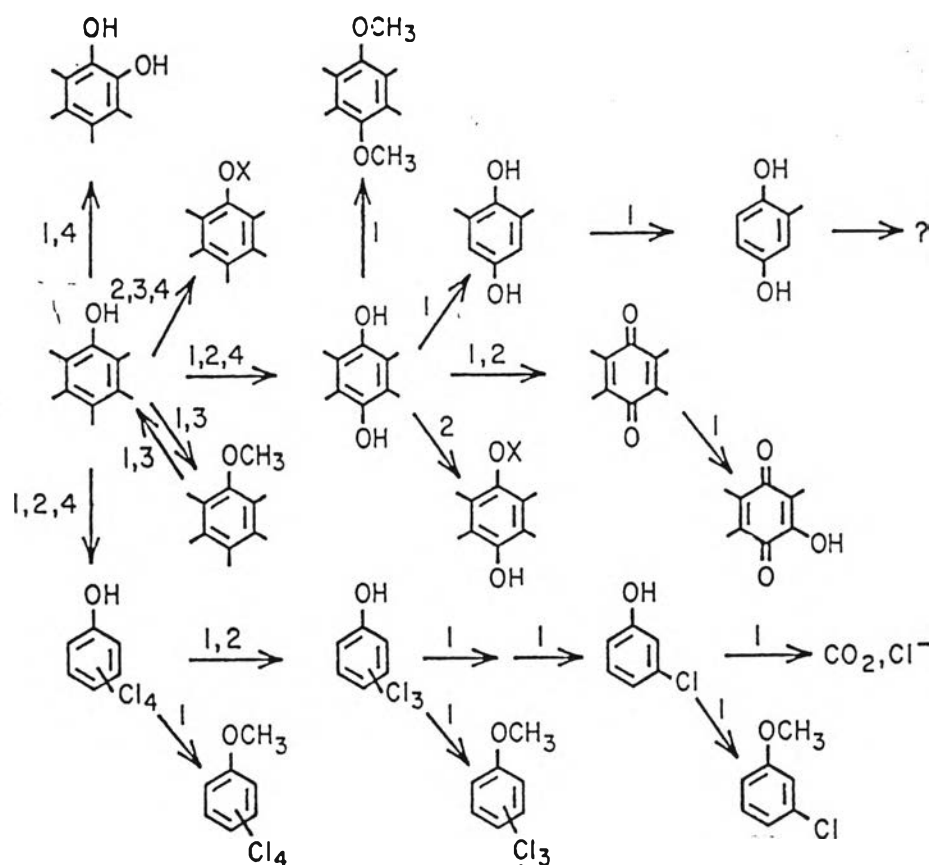

Fig 1.4 Biodegradation of pentachlorophenol (Crosby et al., 1981).

- 1: Microorganisms; 2: Mammals; 3: Fish and aquatic invertebrates;  
4: Green plants.

Several PCP-degrading aerobic soil bacteria and anaerobic consortia from acclimated sewage sludge have been identified. Even though definite anaerobic microbial degradation of PCP in anaerobic condition is not obvious, several intermediates, CO<sub>2</sub> and NH<sub>4</sub> could be detected as products of reductive dechlorination of PCP. On the other hand, several aerobic PCP-degrading soil bacteria show ability to degrade and mineralize PCP at high concentrations (100-200 mg/l). PCP-degrading bacteria: *Arthrobacter* sp. strain ATCC 33790, *Flavobacterium* sp. strain ATCC 39723, *Pseudomonas* sp. strain SR3, and *Sphingomonas* sp. strain RA2 were isolated from different geographical locations. Southern blot analyses determined that all of them harbour similar PCP degradation genes and 16S rRNA analyses together with fatty acid (sphingolipid) analyses strongly suggest that they are a member of the genus *Sphingomonas* (Ederer et al., 1997).

#### **1.6 Pentachlorophenol degradation by *Sphingomonas chlorophenolica* ATCC 39723**

*Sphingomonas chlorophenolica* ATCC 39723 (family *Flavobacterium* sp. ATCC 39723) was isolated from PCP contaminated soils in Minnesota, U.S.A. (Saber and Crawford, 1985). *Sphingomonas* utilizes PCP as a sole carbon source at concentrations of 100-200 mg/l. It also degrades PCP in the presence of glutamate as a cosubstrate (Gonzalez and Hu, 1991).

Molecular biology study of PCP degradation by *Sphingomonas* has revealed that many proteins are induced in the presence of PCP (Xun and Orser, 1991a). One protein was purified and identified as a 30 kilodalton (kDa) PCP-induced periplasmic protein (PcpA). A gene corresponding to PcpA was identified. Chanama and Crawford (1997) supported the evidence that *pcpA* is essential for degradation of PCP. They had identified an intermediate 2, 6-dichloro-*p*-hydroquinone (DiCH) as a substrate for PcpA.

Xun and Orser, 1991b also purified a 63 kDa PCP-induced protein and identified it as a PCP 4-monooxygenase. The enzyme generates tetrachloro-*p*-hydroquinone from PCP in the presence of O<sub>2</sub> and NADPH (Xun et al., 1992a). PCP 4-monooxygenase has a diverse substrate specificity with ability to catalyze the para hydroxylation of numerous substituted phenols which removes hydrogen, halogen, cyano, and amino groups from aromatic ring at para position (Xun et al., 1992b).

Multiple sequence alignment of *pcpB* (a gene corresponding to PCP 4-monooxygenase) with some of the highest scoring monooxygenases from the National Center for Biotechnology Information (NCBI), using the Genetic Computer Group (GCG) program PILEUP (Deveraux et al., 1984), revealed two highly conserved domains predicted to be involved in the binding of the flavin adenine dinucleotide (FAD) (Lange and Orser, 1994). The first domain fits the consensus sequence of an ADP-binding  $\beta\alpha\beta$ -fold observed in many FAD-binding proteins (Bennett, 1974; Eggink et al., 1990; Rossmann et al., 1974; Wierenga et al., 1986). The second domain is also involved in the binding of FAD, as predicted by a second conserved amino acid fingerprint (Bennett, 1974). No observable NADPH-binding domain could be identified in the sequence base on the conserved  $\beta\alpha\beta$ -fold amino acid motif (Lange and Orser, 1994).

Sequence information from the region downstream of *pcpB* shows two open reading frames (ORF). The first ORF, *pcpD*, is directly downstream of *pcpB* and reads in the same direction as *pcpB*. It exhibits high amino acid sequence similarity to the oxygenase reductases. Should the sequence analysis be reliable *pcpD* would be predicted to encode a PCP 4-monooxygenase reductase, protein involved in transferring electrons from NADPH, through the redox center of PcpD, then to the flavin adenine dinucleotide (FAD) prosthetic group of PCP 4-monooxygenase (Lange and Orser, 1994). The oxygenase reductases are characteristic iron-sulfur protein containing two domains involved in binding the prosthetic groups flavin mononucleotide (FMN) and the [2Fe-2S] center, and a third domain involved in

binding nicotinamide adenine dinucleotide (NAD) cofactors. The oxygenase reductases are electron transport proteins involved in the transfer of electrons from reduced NAD to the FMN prosthetic group, then to the [2Fe-2S] center, and finally to the oxygenase component. The second ORF, *pcpR*, was found downstream from *pcpD* with the same direction as *pcpB* and *pcpD*. PcpR is predicted by sequence analysis to be a Lys R type transcriptional activator protein similar to that from the naphthalene of *Pseudomonas putida*, Nah R (Schell and Sukordhaman, 1989) and the activators for nodulation in *Rhizobium*, *Bradyrhizobium* and *Azorhizobium* species, Nod D and Syr M (Barnett and Long, 1990) (Lange and Orser, 1994).

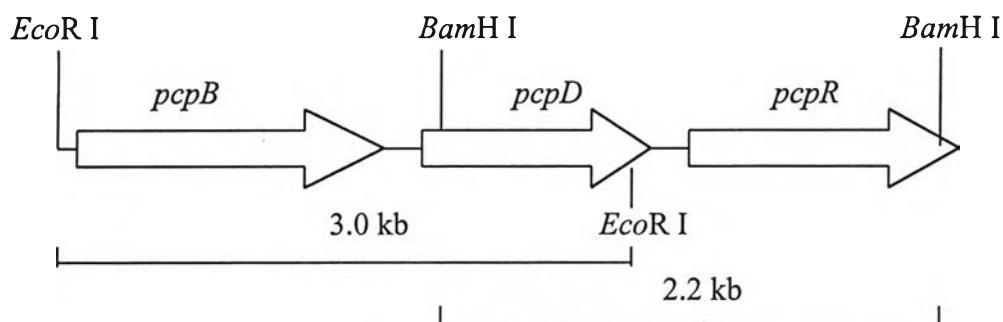

Figure 1.5 The organization of pentachlorophenol degradation.

Orser et al. (1993) reported the purification of an enzyme which reduces tetrachloro-*p*-hydroquinone (TeCH) to trichloro-*p*-hydroquinone (TrCH) and then to dichloro-*p*-hydroquinone (DiCH) and monochlorophenol with glutathione (GSH) as the reducing agent. The enzyme (TeCH reductive dehalogenase, PcpC) should be classified as a glutathione *S*-transferase (GST). The *Sphingomonas* GST protein is a dimer as eucaryotic GSTs (Jakoby and Habig, 1980). However, unlike typical eucaryotic GSTs, the *Sphingomonas* GST does not utilize the common GST substrate,

1-chloro-2,4-dinitrobenzene (Chasseaud, 1979). The identified PCP degradation pathway found in PCP-degrading *Sphingomonas* is depicted in Fig 1.6.

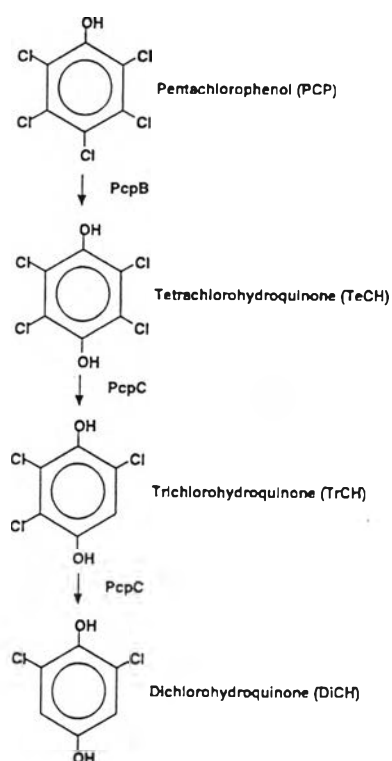

Figure 1.6 Degradation pathway for bacterial catabolism of pentachlorophenol as determined from the identification of pathway intermediates.

PcpB: PCP 4-monooxygenase; PcpC: tetrachloro-*p*-hydroquinone reductive dehalogenase.

### 1.7 Gene replacement mediated by homologous recombination

Gene replacement at specific site in the genome is a gene knockout tool for genomic analysis. This method relies on the introduction of a recombinant plasmid which carries a mutation in a genomic locus into the cells. Recombinant plasmid is constructed, which contains region of genome with an antibiotic-resistance gene either inserted into or replacing a segment of the genomic DNA fragment. The resistance marker is cloned into either a known coding region or into the 5' or 3' flanking DNA. In all cases, the inserted antibiotic resistance marker is different from the marker present in the vector portion of the recombinant plasmid. This recombinant plasmid is introduced into the cells. The transformants are then tested for the presence of the vector-encoded antibiotic resistance. Absence of a recombination event or a single crossover event, will produce transformants exhibiting the vector-encoded antibiotic resistance as well as the resistance in the cloned genomic DNA, whereas a double crossover event (coupled with plasmid loss) will produce transformants in which only the resistance found in the genomic segment has integrated (Fig 1.7).

The aim of our research is to study PCP-degradation by mutant strain of *S. chlorophenolica* ATCC 39723 that containing mutated *pcpD* gene.

(a)

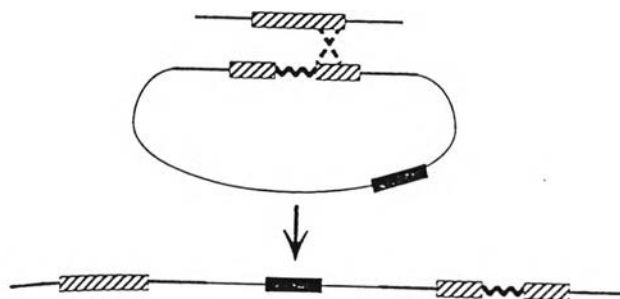

(b)

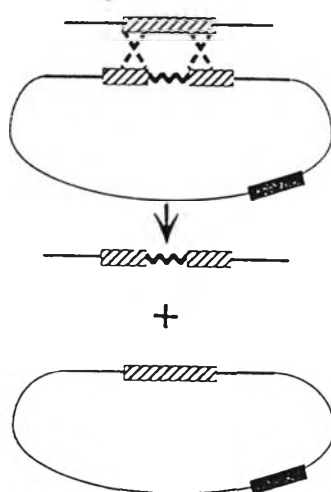

Figure 1.7 Depiction of possible crossover events between plasmid and genome.

(a) Single crossover event and integration of plasmid into genome.

(b) Double crossover event with replacement of wild type DNA by mutated DNA and resolution of plasmid.

Thin lines: vector sequence; heavier lines: genomic sequence; hatched box: a cloned gene; blackened box: vector antibiotic-resistance gene; zig-zag line: second antibiotic-resistance gene.