



CHAPTER III EXPERIMENTAL

3.1 Materials

Four different molecular weights of poly(ethylene oxide) (PEO) were purchased from Polysciences Inc. (Catalog no. 18198-6, 18202-8, 18945-6, 18946-4). The molecular weights provided by the supplier are 1×10^5 , 6×10^5 , 9×10^5 , and 4×10^6 g/mol. Hydroxypropyl cellulose (HPC) was purchased from Aldrich Chemical Co. Inc.. The reported molecular weight is 1×10^5 g/mol.

The commercial grade hexadecyltrimethylammonium chloride (HTAC) was used as a cationic surfactant and provided by Unilever Thai Holding Co. Ltd.. The molecular weight of HTAC is 319 g/mol. HTAC solution contains 50% pure HTAC, 36% isopropyl alcohol (IPA), and 14% water reported by the supplier. Cocamidopropyl dimethyl glycine (CADG) was used as an amphoteric surfactant and supported by Rhone-Poulenc Co.. The molecular weight of CADG is about 342 g/mol. Both surfactants were used without further purification.

Sodium hydroxide (NaOH) and hydrochloric acid (HCl) were used to adjust pH of amphoteric surfactant solution. NaOH was obtained from P&N Co., and HCl was purchased from J. T. Baker Inc..

Reagent grade potassium nitrate (KNO_3), purchased from Ajax Chemicals, was used in the preparation of polymer-surfactant complex in salt solution.

Analytical grade toluene, purchased from J. T. Baker Inc., was used as the Rayleigh ratio calibration standard for measurements of the molecular weight.

Deionized distilled water, purchased from the Thai Pharmaceutical Organization, was used as a solvent, after it was purified by filtration through a Millipore membrane filter with a pore size of 0.2 μm .

3.2 Apparatus

3.2.1 Capillary Viscometer

3.2.1.1 *Cannon-Ubbelohde Viscometer*

Cannon-Ubbelohde viscometers, capillary sizes no. 50 and no.100, were used to determine the dilute solution viscosities of polymer, surfactant, and polymer-surfactant complex solutions. Both viscometers were purchased from Curtis Matheson Scientific Inc., and the reported uncertainty of these viscometers is $\pm 0.3\%$. The sizes were chosen to cover a suitable range of efflux times for each solution. The specifications of the viscometers are shown below:

1. Size 50, no. B-505, $K = 0.003735 \text{ mm}^2/\text{s}^2$ (cSt/s)
Kinematic viscosity range: 0.8 to $4 \text{ mm}^2/\text{s}^2$ (cSt/s)
2. Size 100, no. B-941, $K = 0.015 \text{ mm}^2/\text{s}^2$ (cSt/s)
Kinematic viscosity range: 3 to $15 \text{ mm}^2/\text{s}^2$ (cSt/s)

3.2.1.2 *Thermostatic Water Bath*

A digital thermostat (model DT-2 from Heto, Denmark) attached to a home - made water bath was used to control the temperature with a resolution of $\pm 0.01^\circ\text{C}$.

3.2.1.3 *Timing Device*

A stopwatch timer from Casio was used to provide the flow time of sample solutions with a resolution of ± 0.01 second.

3.2.2 Filtering Accessories

A Millipore sintered glass filter with 47 mm diameter was used to remove dust and any extraneous particles from the solvent. Sample solutions were filtered using an Acrodisc syringe filter from Gelman Sciences prior to light scattering and viscosity measurements.

3.2.3 Centrifuge

A high-speed refrigerated centrifuge was used to precipitate dust and other extraneous particles from the sample solutions. The centrifuge was provided by

the ALC International Co. Ltd., model PM 180R which has a maximum speed of 12,000.

3.2.4 Conductivity Meter

A conductivity meter (model 160, Orion Co.) was used to determine the cmc of pure surfactants and the cac of the polymer-surfactant complex systems.

3.2.5 Du-Nouy Ring Tensiometer

A tensiometer with Pt-ring, RI 10 probe (Kruss, model: K 10T) was used to determine the surface tension of pure surfactant solutions.

3.2.6 pH Meter

A pH meter (model: 920 A, Orion Co.) was used to adjust pH of pure CADG amphoteric surfactant and HPC-CADG solutions.

3.2.7 Dialysis Membrane

A regenerated cellulose molecular pore membrane with a molecular weight cutoff of 8000, from Spectrum Medical Industries, Inc. was used as a semi-permeable membrane. The specifications of the dialysis membrane are:

Flat width: 40 mm

Diameter: 25.5 mm

Volume/Length: 5.1 mL/cm

3.2.8 Refractometer

An Optilab DSP interferometric refractometer from Wyatt Technology Corporation was used to perform the refractive index increment (dn/dc) measurements of pure polymer and polymer-surfactant complex solutions.

3.2.9 Light Scattering Instrument

Light Scattering measurements were performed using a model series 4700 instrument from Malvern Instrument Ltd., and Brookhaven BI 2020 instrument from Brookhaven Instrument (BI) Corporation. The Malvern instrument consists of

several associated units: a goniometer, an Ar-ion laser source emitting vertically polarized light at $\lambda = 514.5$ nm, a photomultiplier tube, a correlator, and a filter pump to remove dust particles from water circulated as temperature control fluid around the light scattering unit. The data were analyzed by using the Malvern software package provided by the supplier. The Brookhaven instrument has the same components, except that it is equipped with a 15 mW He-Ne laser emitting vertically polarized light at wavelength $\lambda = 632.8$ nm.

3.2.10 Rheometer

A controlled-strain fluids rheometer, model RFS-8400, is from Rheometric Scientific Inc., equipped with a 100 g.cm transducer was used to measure the rheological properties of concentrated PEO, HTAC, and PEO-HTAC solutions in dynamic shear mode. The rheometric instrument consists of a test station, power chassis, and temperature-controlled chamber to maintain 100% humidity. The sample temperature was controlled by a circulating thermal bath with temperature control accurate to within 0.1°C . Further viscoelastic measurements were carried out using a Carrimed 50 controlled-stress rheometer equipped with an attachment, which permits application of a D.C. electric field across the gap, i.e. in the direction perpendicular to the direction of shear. Using the conductance of the cone and plate, the gap can be set very precisely.

3.3 Sample Preparation

3.3.1 Preparation of Polymer Solutions

Stock solutions of PEO and HPC were prepared by dissolving each in doubly filtered deionized distilled water. The solutions were stirred slowly at room temperature for periods of 3 days to 10 days depending on the molecular weight until complete dissolution. The PEO stock solutions were stored at room temperature and the HPC stock solution was stored in a refrigerator to prevent precipitation. In the case of PEO in salt solution, the PEO was dissolved in 0.1 M KNO_3 .

3.3.2 Preparation of Surfactant Solutions

Stock solutions of HTAC and CADG were prepared by dissolving the surfactants in filtered water. The solutions were then stirred for at least 1 day and stored at room temperature.

3.3.3 Preparation of Polymer-Surfactant Complex Solutions

The required amount of polymer stock solution was added to diluted surfactant stock solution in weight by volume. Polymer-surfactant solutions were stirred gently at room temperature for 1 day, and then allowed to stand overnight to obtain an equilibrium condition. Prior to each measurement, the solutions were centrifuged with a speed of 8,000 rpm for 1 hr and then purified by filtering through 0.22 μm or 0.45 μm Millipore membrane, depending on the polymer molecular weight. The flow chart diagrams for the preparation of dilute and concentrated polymer-surfactant solutions are shown in Figures 3.1 and 3.2.

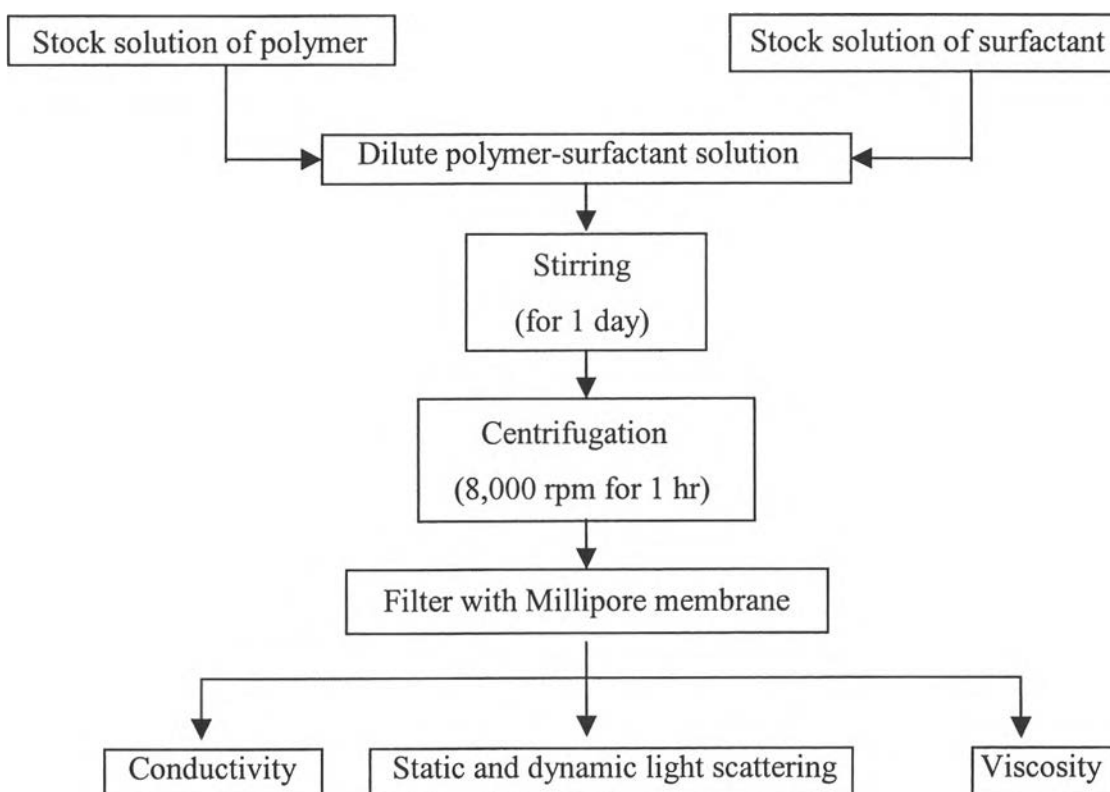

Figure 3.1 Flow chart diagram for dilute polymer-surfactant solution preparation.

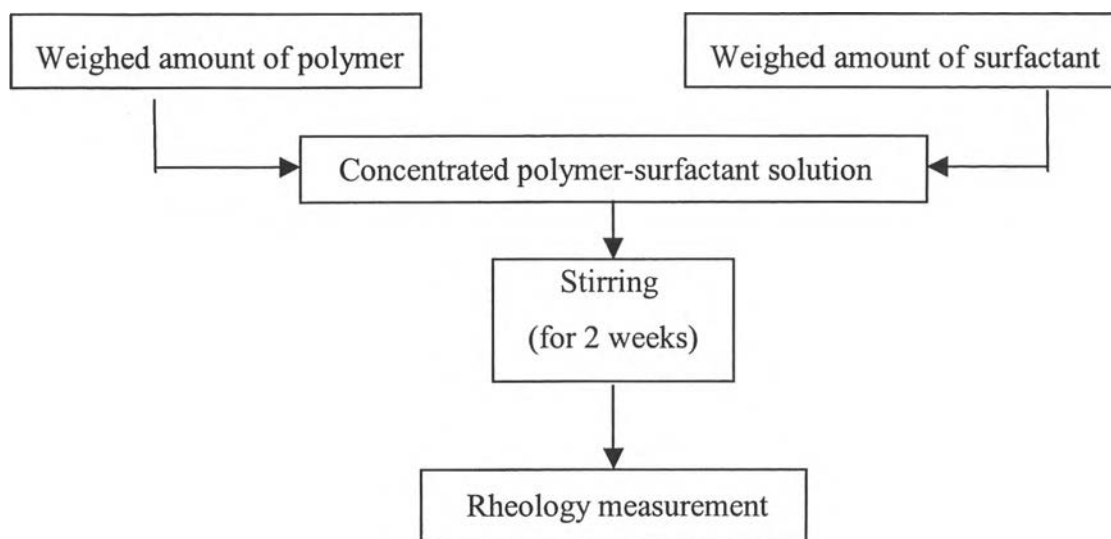

Figure 3.2 Diagram for concentrated polymer-surfactant solution preparation.

3.4 Methodology

3.4.1 Measurements of cmc and cac

Surface tension is the minimum amount of work required to create a unit area of surface of a fluid, and is expressed in units of mN/m. The effect of addition of surfactant on the surface tension of water is illustrated in Figure 3.3, in which the full line represents the variation in surface tension versus concentration of pure surfactant. As schematically shown in Figure 3.3, the surface tension of a surfactant solution dramatically decreases until the concentration reaches the value known as the critical micelle concentration (cmc), where self-association of surfactant molecules into micelles occurs, and then remains unchanged above the cmc. A similar effect occurs at the critical association concentration (cac) where formation of micelles bound of a polymer chain occurs.

In the present work, the surface tension measurement was performed using a Du Nouy ring tensiometer for pure HTAC solution. The measurement temperature was controlled at 30°C using a thermostatted water bath. The cmc and cac can also be determined via conductivity measurements, as schematically shown in Figure 3.4. Addition of surfactant increases the conductivity of water rapidly up to the cmc or cac, where a break is observed, above which the conductivity increases more slowly.

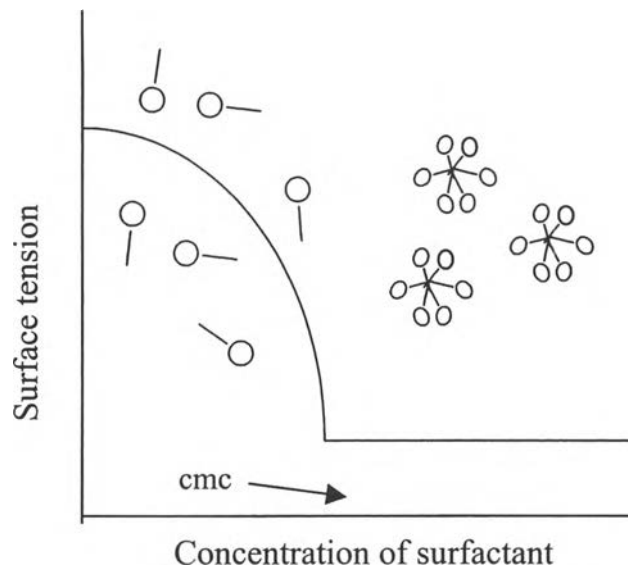

Figure 3.3 Effect of micelle formation on surface tension of a surfactant solution.

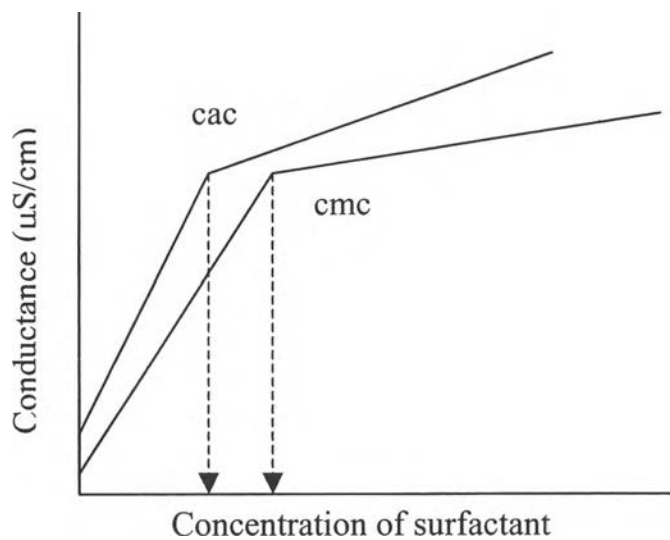

Figure 3.4 Schematic diagram for the determination of critical micelle concentration (cmc) and critical aggregation concentration (cac).

3.4.2 Viscosity Measurement

Viscosity measurement is a straightforward tool to study the hydrodynamic volume of polymers in the solution. The viscosity of a polymer solution is dependent both on concentration and on the average molecular size of the sample. Generally, capillary viscometer is used to measure fluid viscosity. In a

capillary viscometer, a specified quantity of the fluid is forced through the capillary. The basis for viscosity determination is Poiseuille's equation for steady state laminar flow:

$$\eta = \frac{\pi r^4 P t}{8 V L} \quad (3.1)$$

where r and L are the radius and length of the capillary, P is the pressure drop, V is the volume of fluid which passes through the capillary, and t is the flow time. The relative viscosity, η_r , is determined by the ratio of flow times of solution and solvent. From Poiseuille's law:

$$\eta_r = \rho t / \rho_s t_s \quad (3.2)$$

where ρ is the density and the subscript, s , represents the solvent. By extrapolation to zero concentration, the small density correction can be neglected and therefore:

$$\eta_r = t/t_s \quad (3.3)$$

To avoid a kinetic energy correction to compensate for acceleration of the fluid during the measurement, the flow times should be long ($t > 200$ sec). The specific viscosity, η_{sp} , is the relative increment in viscosity of the solution over that of the solvent;

$$\eta_{sp} = (\eta - \eta_s) / \eta_s = \eta_r - 1 \quad (3.4)$$

where η and η_s are the viscosity of solution and solvent respectively. The intrinsic viscosity is determined by extrapolation of the reduced viscosity, η_{red} , to zero concentration by the Huggins equation (Huggins, 1942),

$$\eta_{red} = \eta_{sp}/c = [\eta] + k_H [\eta]^2 c + \dots \quad (3.5)$$

The intrinsic viscosity, $[\eta]$, is related to the size of the macromolecule and k_H is the Huggins coefficient which is an indication of the interactions between the polymer chains. $[\eta]$ correlates with molecular weight of polymer through the Mark-Houwink-Sakurada equation (Flory, 1953),

$$[\eta] = KM^a \quad (3.6)$$

where K and a are constants for a particular polymer. The value of a can vary between 0.5 to 0.8, depending on the polymer-solvent interaction (Painter and Coleman, 1994).

In this work, the K and a values for PEO were obtained from a text on the properties of Poly(ethylene oxide), published by Union Carbide (Bailey and Koleske, 1976),

$$[\eta] = 1.25 \times 10^{-4} M_w^{0.78}. \quad (3.7)$$

In case of ternary system (polymer/surfactant/ water), the specific viscosity was reported instead of the reduced viscosity (η_{red}) since the reduced viscosity for the ternary system cannot be quantitatively determined because the amount of the surfactant bound to polymer as complex is not known.

The viscosity measurements were performed using a Cannon-Ubbelohde capillary viscometer. Before measurement, the viscometer is placed in a thermostatted water bath for 15 min. to achieve thermal equilibrium.

3.4.3 Dialysis Experiment

The procedure of solution dialysis is one technique for purification of a solute or to enrich the solution in a component, which preferentially binds to a polymer. The method consists of enclosing the solution in a bag, which is made of a semi-permeable membrane. The sealed bag is then placed in a large quantity of the solvent as shown in Figure 3.5. The membrane must be permeable to the solvent and to any low molecular weight molecules which are present, but impermeable to the

polymer. As a result of the semi-permeability of the bag, the outer portion is changed regularly, so the low molecular weight molecules are gradually flushed away (Hiemenz, 1986). If the solvent contains multiple components, some of which preferentially bind to the polymer, then those species will become enriched in the solution in the bag, by an amount which is determined by chemical potential equilibrium.

Dialysis equilibrium measurements were performed to be able to determine the refractive index increment (dn/dc) at constant chemical potential of the added surfactant. In this case, the multicomponent system can be considered as a two-component system, and the molecular weight of polymer in the complex can be determined. In this work, the polymer-surfactant complex solutions with different concentration ratios were dialyzed with surfactant solution using regenerated cellulose membranes to obtain chemical potential equilibrium. A dialysis bag, which is wetted by the solvent, filled with polymer-surfactant solution was immersed in a beaker containing surfactant solution of the same concentration as inside the bag. The duration of dialysis was at least 1 week with 2-3 exchanges of surfactant solution.

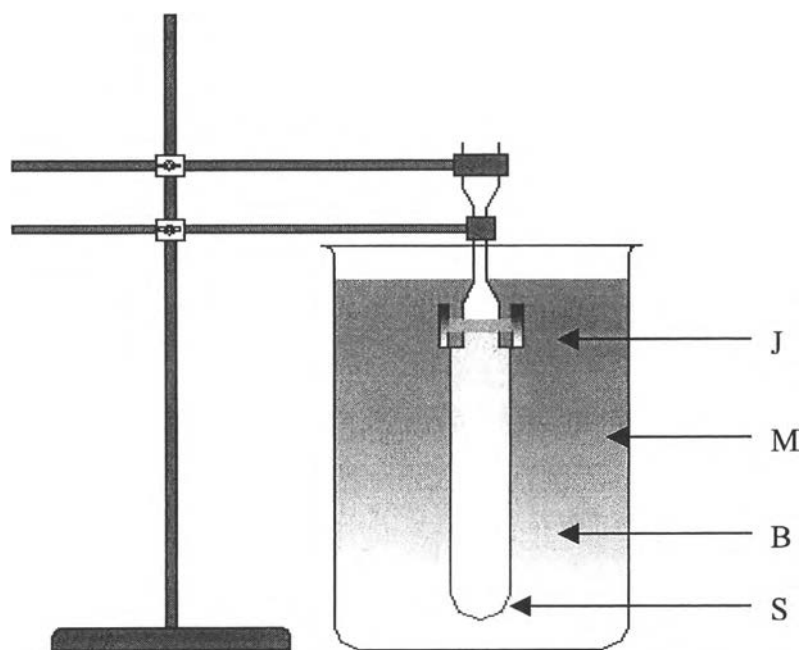

Figure 3.5 Schematic diagram of simple dialysis experiment. J = joint, M = surfactant solution, B = dialysis bag, S = polymer-surfactant solution.

3.4.4 Refractive Index Measurement

The differential refractometer measures the difference in refractive index between the liquid sample and a reference. Any difference in refractive index between the two liquids results in a phase shift of one beam relative to the other. This phase shift is directly proportional to the refractive index difference. When the refractive index differs between each cell, displacement of the fringe pattern occurs by an amount proportional to the difference in refractive index (Δn), which can be calculated as,

$$\left(\frac{dn}{dc}\right) = \frac{n_{\text{polymer}} - n_{\text{solvent}}}{c} \quad (3.8)$$

where n is the refractive index. The diagram in Figure 3.6 illustrates the deflection of a light ray by a refractive index difference between the reference and the sample solutions.

The refractive index increment (dn/dc) of a polymer solution is a necessary prerequisite for the determination of molecular weight by light scattering. The dn/dc of pure polymer and polymer-surfactant complex were measured using a Dawn Optilab interferometric refractometer at 30°C. Before measurement, both sample and reference cells were flushed with distilled water for at least 24 hr to stabilize the instrument with a new solvent. Measurements were performed on both dialyzed and undialyzed solutions at various surfactant to polymer concentration ratios. We also determined the change in refractive index of

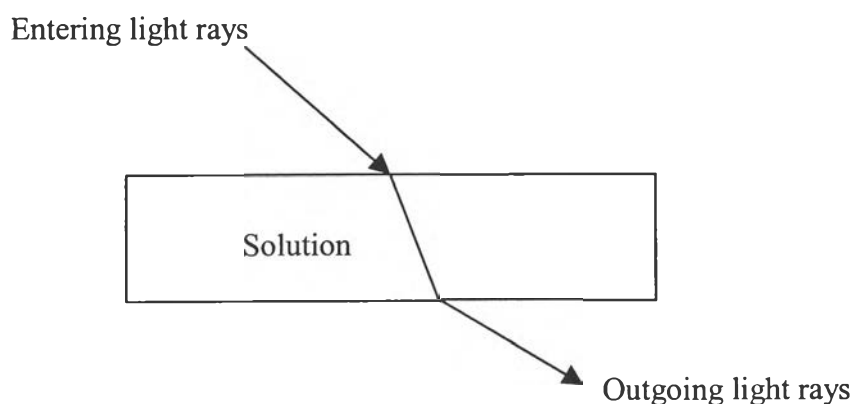

Figure 3.6 Diagram describing the bending of light rays by refractive index gradient.

the ternary solution when varying polymer concentration at fixed surfactant concentration, viz.,

$$\left[\frac{dn}{dc_p}\right]_{c_s} = \left[\frac{n(\text{ternary})_{c_s} - n(H_2O + HTAC)}{c_p}\right] \quad (3.9)$$

In addition, the change in refractive index when varying the HTAC concentration, keeping the PEO concentration constant, was obtained,

$$\left[\frac{dn}{dc_s}\right]_{c_p} = \left[\frac{n(\text{ternary}) - n(H_2O + \text{polymer})}{c_s}\right] \quad (3.10)$$

For a ternary system of polymer-surfactant complex, the amount of preferential binding of surfactant to polymer was calculated from the following equation and the derivation of this equation is shown in the following section (Section 3.4.5.1);

$$D' = \left[\left(\frac{dn}{dc_p}\right)_{T,P,\mu_s} - \left(\frac{dn}{dc_p}\right)_{T,P,c_s}\right] / \left(\frac{dn}{dc_s}\right)_{T,P,c_p} \quad (3.11)$$

where $(dn/dc_p)_{T,P,\mu_s}$ is the refractive index increment of polymer at fixed temperature, pressure, and surfactant concentration after dialysis, i.e., the differential refractometry experiments were performed under conditions where the chemical potential of the solvent components is identical in the solution and in the reference solvent, $(dn/dc_p)_{T,P,c_s}$ is the refractive index increment of polymer at constant temperature, pressure, and surfactant concentration without dialysis, and $(dn/dc_s)_{T,P,c_p}$ being the binary solvent refractive index increment, keeping constant the polymer concentration.

3.4.5 Light Scattering Measurements

Various methods can be used to study the physical properties of macromolecules in solution. One of these methods, light scattering (Brown, 1996) is an especially useful and powerful tool as it provides a non-invasive method for studying polymer solutions, using static and dynamic light scattering to give the

information on the structure of polymer chain. A schematic diagram of a light scattering instrument is shown in Figure 3.7.

3.4.5.1 Static Light Scattering

The phenomenon of light scattering is caused by fluctuations in the refractive index of the medium on the molecular scale. The electric field strength, E_s , of the radiation scattered as a results of these fluctuations is given by,

$$E_s = \frac{4\pi^2 v^2 E_0 \sin \theta}{\tilde{c}^2 r} \cos 2\pi(vt - \chi / \lambda) \quad (3.12)$$

where v is the frequency, E_0 is the maximum amplitude, θ is the angle, c is the velocity of incident light, r is the distance from the source to the observer, t is time, χ is the location along the line of polarization, λ is the wavelength of light. The intensity of scattered light, $I(\theta)$, is proportional to the square of electric field strength, E^2 . The time-averaged intensity of scattered radiation is converted into the following quantity (Brown, 1996),

$$R_\theta = \frac{I(\theta)r^2}{I_0}, \quad (3.13)$$

where R_θ is referred to as the Rayleigh ratio, I_0 is the intensity of incident light. $\Delta R_\theta = R_\theta(\text{solution}) - R_\theta(\text{solvent})$ is related to the osmotic pressure of the solute at constant temperature, $(\delta\pi/\delta c)_T$, by the following expression,

$$\Delta R_\theta = \frac{KRTC}{(\delta\pi / \delta c)_T}. \quad (3.14)$$

The optical constant, K , is given by,

$$K = \frac{4\pi^2 n_0^2 (\delta n / \delta c)^2}{N_A \lambda^4}, \quad (3.15)$$

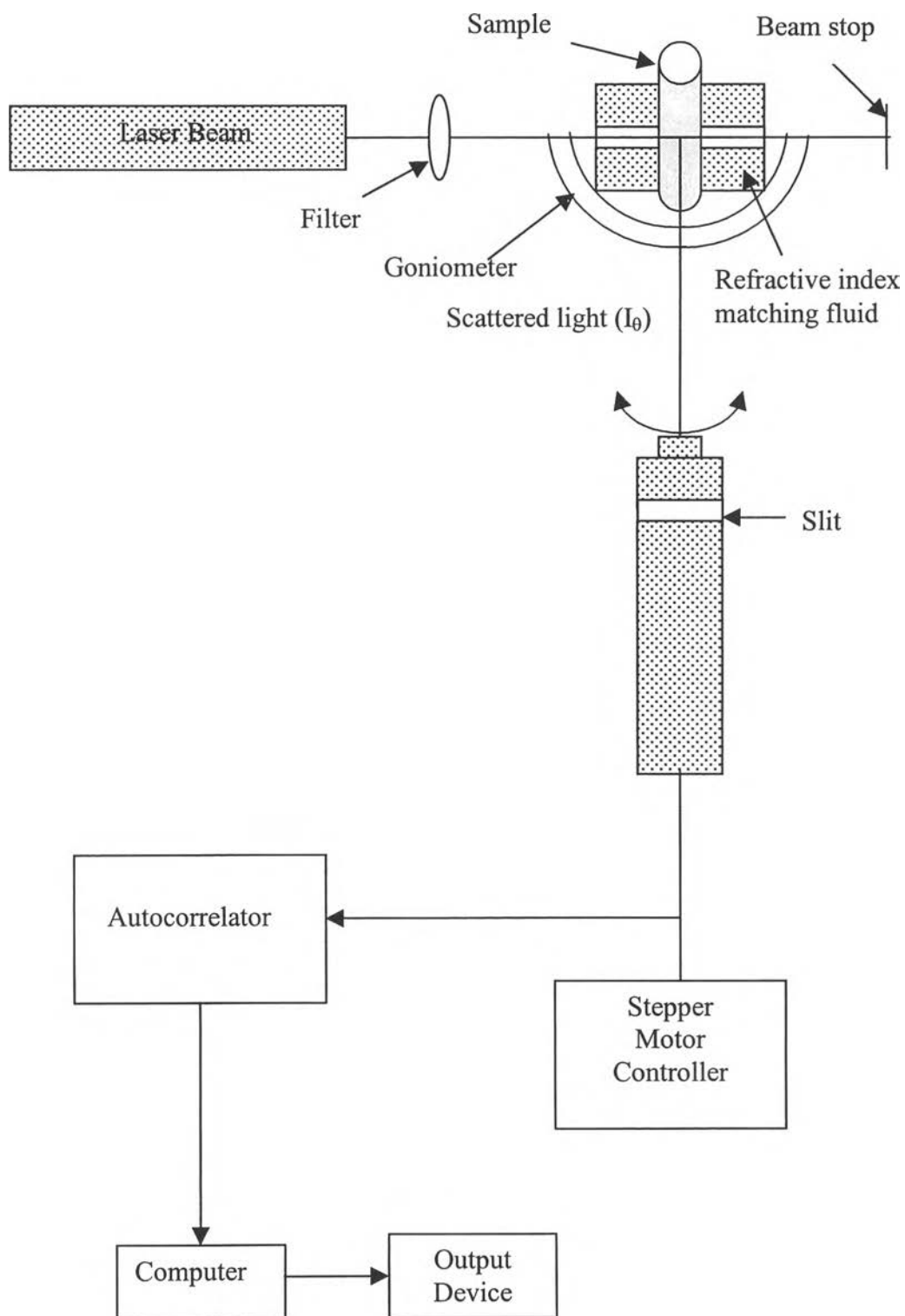

Figure 3.7 The schematic diagram of light scattering instrument.

and n_0 is the refractive index of the solvent, $(\delta n/\delta c)$ is the refractive index increment of the solution, N_A is Avogadro's number. The osmotic pressure of the solute is related to its weight-average molecular weight, M_w ,

$$(\delta\pi/\delta c)_T = RT\left(\frac{1}{M_w} + 2A_2c + \dots\right) \quad (3.16)$$

By combining equations (3.14) and (3.16), we obtain,

$$\frac{Kc}{\Delta R_\theta} = \frac{1}{M_w} + 2A_2c + \dots \quad (3.17)$$

(i) *Light Scattering by Large Molecules in Binary Solution*

In the static light scattering measurements of polydisperse dilute polymer solutions, the concentration and angle dependence of Kc/R_θ may be written as,

$$\frac{Kc}{\Delta R_\theta} = \frac{1}{P(\theta)} \left[\frac{1}{M_w} + 2A_2c + \dots \right] \quad (3.18)$$

The function $P(\theta)$ is directly related to the radius of gyration (R_g) according to the following equation,

$$P(\theta) = 1 - \frac{q^2 R_g^2}{3} \quad (3.19)$$

where q is the scattering wave vector which is physically defined as,

$$q = \frac{4\pi n}{\lambda} (\sin \theta / 2) \quad (3.20)$$

and therefore,

$$\frac{Kc}{\Delta R_\theta} = \frac{1}{M_w} \frac{(1 + 16\pi^2 \langle R_g^2 \rangle_z \sin^2 \theta / 2)}{3\lambda^2} + 2A_2c + \dots \quad (3.21)$$

The above equation is the basis for the determination of the molecular weight of polymer molecules. A_2 is the second virial coefficient, which is determined from the slope of the zero angle extrapolated line. The z-average of the mean square radius of gyration is determined by the limiting slope of the data extrapolated to zero concentration.

(ii) *Light Scattering in Ternary System*

The light scattering for a polymer in a mixed solvent system was first developed by Kirkwood and Goldberg (1950) and Stockmayer (1950) to account for preferential binding of one solvent species to the polymer. In such a system, the preferential interaction between the polymer and the mixed solvent components must be considered. Therefore, light scattering equation for multicomponent theory is expressed in the small angle limit, $\theta \rightarrow 0$, as,

$$\left[\frac{K'c_p}{\Delta R_\theta} \left(\frac{\partial n}{\partial c_p} \right)_{T,P,c_s}^2 \right] = \frac{1}{(1+D)^2} \left[\frac{1}{M_w} \left\{ \left(1 + \frac{q^2 R_g^2}{3} \right) + 2B^0 c_p \right\} \right] \quad (3.22)$$

Here,

$$K' = \frac{4\pi^2 n^2}{N_A \lambda^4} \quad (3.23)$$

and

$$D = \left[\frac{(dn/dc_s)_{T,P,c_p}}{(dn/dc_p)_{T,P,c_s}} \right] D' \quad (3.24)$$

where $D' = (dc_s/dc_p)_{T,P,\mu_s}$ is taken at a constant chemical potential of the binary solvent and defined as the grams of surfactant per gram of polymer as in equation (3.24). In such a system, the extrapolation of $Kc/\Delta R_\theta$ towards zero concentration plot is not a true molecular weight of the polymer. It may be the apparent molecular weight, $M_{w,app}$ which is a function of the interaction with the solvent components,

$$M_{w,app} = M_w (1 + D)^2 \quad (3.25)$$

where M_w is the true molecular weight of the polymer. The extent of the preferential interaction was measured by the determination of the deviation of apparent molecular weight ($M_{w,app}$) from M_w . Inserting equation (3.24) into equation (3.22), the light scattering equation for multicomponent system can be written in the limit of $\theta = 0$ and $c_p = 0$ as:

$$\lim_{c_p \rightarrow 0} \left[\frac{K'c_p}{\Delta R_\theta} \left\{ \left(\frac{\partial n}{\partial c_p} \right)_{T,P,c_s} + D' \left(\frac{\partial n}{\partial c_s} \right)_{T,P,c_p} \right\}^2 \right] = \frac{1}{M_w}. \quad (3.26)$$

If the differential refractometry experiment is treated under a constant chemical potential by performing an equilibrium dialysis, and the refractive index increment between the dialyzed solution and the dialyzate is measured, the system can behave as a pseudo-two component system. Therefore, equation (3.22) becomes:

$$\lim_{c_p \rightarrow 0} \left[\frac{K'c_p}{\Delta R_\theta} \left(\frac{\partial n}{\partial c_p} \right)_{T,P,\mu_s} \right] = \frac{1}{M_w} \quad (3.27)$$

where M_w is the molecular weight of polymer in the complex. The intercept of the light scattering plot gave directly the true molecular weight. Combining the molecular weight of polymer in ternary system and the amount of preferential binding between polymer and the solvent, obtaining from refractive index increments by using equation (3.11), we find that the molecular weight of the polymer-surfactant complex, $M_{w,com}$ can be calculated from the following equation.

$$M_{w,com} = M_w (1 + D') \quad (3.28)$$

(iii) Experimental Conditions

Molecular weights of polymer and polymer-surfactant complexes were determined using Zimm plot analysis. Measurements were performed at 30°C, using toluene as a reference standard solution. In Zimm plot, $Kc/\Delta R_\theta$ is plotted against $\sin^2(\theta/2) + kc$, where k is the arbitrary value which was selected by fitting the

graph. The Rayleigh ratio ($R_{\theta}(\text{solution})$) of the scattered light from the solution is calculated from the expression:

$$R_{\theta}(\text{solution}) = \frac{I(\theta)(\text{solution})}{I(\theta)(\text{reference})} \frac{\bar{n}^2(\text{solution})}{\bar{n}^2(\text{reference})} R_{\theta}(\text{reference}) \quad (3.29)$$

where the ratio of squares of refractive indices is a correction for a change in scattering volume, and as reference fluid, we used toluene, for which $R_{\theta} = 3.2 \times 10^{-5} \text{ cm}^{-1}$ at the wavelength $\lambda = 514.5 \text{ nm}$ in the Malvern instrument, and $R_{\theta} = 1.4 \times 10^{-5} \text{ cm}^{-1}$ of toluene at 632.8 nm wavelength in the Brookhaven instrument, as reported by Kaye and Daniel (1974). Both instruments yield acceptably consistent data within $\pm 5\%$ deviation. The light scattering intensities were investigated over the angular range of 30° - 120° . Sample cells in both instruments are mounted at the center of a temperature controlled, refractive index matched bath.

3.4.5.2 Dynamic Light Scattering

(i) Principle and Data Analysis

Dynamic light scattering (DLS) is a useful technique to investigate the molecular mobility and diffusion coefficients of macromolecules. It also provides independent information on the size and configuration of the polymer molecules. DLS measures the time fluctuation in the intensity of the scattered light due to the Brownian motion of the particles by photon counting method. The time-dependent fluctuation intensity is characterized by measuring the correlation function of the scattered light. The general features of the autocorrelation function is shown in Figure 3.8.

The intensity autocorrelation function of photon counting fluctuations is related to the time averaged intensity autocorrelation function: $\langle n(t)n(t+\Delta t) \rangle = \langle I(t)I(t+\Delta t) \rangle$; where $n(t)$ and $n(t+\Delta t)$ are the photon count rates at time t and at later time $t+\Delta t$. $I(t)$ and $I(t+\Delta t)$ are the corresponding average intensities of scattered light.

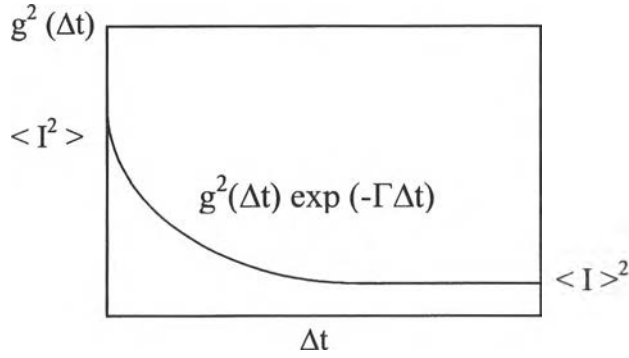

Figure 3.8 The general features of time intensity autocorrelation function.

Alternatively, the intensity autocorrelation function is related to the electric field autocorrelation function in terms of the following equation (Chu, 1991),

$$\langle I(t)I(t+\Delta t) \rangle = \langle E^*(t) E(t) \rangle^2 + \langle E^*(t) E(t+\Delta t) \rangle^2 \quad (3.30)$$

where the symbol $\langle \rangle$ denotes the time average value. E is the scattered electric field, or, we can divide both sides by $\langle E^*(t) E(t) \rangle^2$, and write:

$$g^2(t) = 1 + \beta |g^1(t)|^2, \quad (3.31)$$

where β is an instrumental constant, called the coherence factor, which depends on the degree of optical phase matching at the detector, $0 < \beta < 1.0$. $g^1(t)$ and $g^2(t)$ are the normalized electric field and intensity-intensity autocorrelation functions. Equation (3.30) is the Siegert relation (Brown, 1996) and $g^1(t)$ is given by,

$$g^1(t) = \frac{\langle E_s^*(t) E_s(t+\tau) \rangle}{\langle E_s^*(t) E_s(t) \rangle}. \quad (3.32)$$

The relationship between $g^1(t)$ and the dynamic scattering function, $S(q,t)$, is given by,

$$g^1(t) = S(q,t)/S(q,0). \quad (3.33)$$

ต้นฉบับ หน้าขาดหาย

where f_c is the dimensionless parameter which characterizes internal configurational motions, and depends on the macromolecular architecture such as homogenous sphere, random coil or rigid rod. The concentration dependence of D_{cm} is given by,

$$D_{cm} = D_0 (1 + k_D c + \dots). \quad (3.38)$$

Here, D_0 is the diffusion coefficient at infinite dilution. The concentration dependence coefficient, k_D can be written as;

$$k_D = 2A_2 M - k_f - 2v. \quad (3.39)$$

The hydrodynamic radius (R_h) of the isolated macromolecule can be calculated by Stokes-Einstein relation in the infinitely dilute solution which is;

$$R_h = \frac{k_B T}{6\pi\eta_s D_0}, \quad (3.40)$$

where η_s is the viscosity of the solvent.

(ii) Experimental Conditions

Dynamic light scattering (DLS) measurements were carried out with a Malvern 4700 spectrometer operating at a wavelength of 514.5 nm with a output laser power of 100 mW. The intensity autocorrelation function was measured between 70° – 130° scattering angle with a 128 channel series 7032 multi-8 correlator. The aperture before the photomultiplier was set at 200 μm . The autocorrelation functions of the scattered light intensity were analyzed in using monomodal analysis. 10 mm round glass cells were used in DLS measurements and the instrument was controlled at the desired temperature to within $\pm 0.1^\circ\text{C}$.

3.4.6 Rheological Measurements

3.4.6.1 *Viscoelastic Properties of Polymeric Materials*

Analysis of the rheological properties of a material provides useful information about the configurational rearrangements of polymer and also the long and short-range intermolecular interactions. The properties of viscoelastic polymer can be measured by three different methods. In creep measurement, the sample is subjected to a constant stress and the deformation is measured as a function of time. The second type of viscoelastic measurement is stress relaxation. In this experiment, the polymer is subjected to a certain value of strain, and the stress relaxation measured as a function of time. The most useful method for determining viscoelastic properties is the dynamic oscillatory measurement, which gives molecular motions of polymer chain over a wide range of time scales and provides the storage and dissipation of energy in the material.

Dynamic oscillatory techniques measure the stress response of a material to applied strain. If the viscoelastic behavior is linear, the stress will alternate sinusoidally out of phase with the strain.

$$\gamma = \gamma_0 \sin(\omega t) \quad (3.41)$$

where γ_0 is the maximum amplitude of the strain. The stress can be expressed in terms of in phase and out of phase components as,

$$\sigma = \gamma_0 (G' \sin \omega t + G'' \cos \omega t) \quad (3.42)$$

where G' and G'' are the frequency dependence of storage modulus and the loss modulus. The storage and loss moduli can be written in terms of the phase angle, δ , as;

$$\tan \delta = G''(\omega)/G'(\omega). \quad (3.43)$$

The complex modulus, G^* , is used to describe the combined behavior of storage and loss modulus which is given by,

$$G^*(\omega) = [\{G'(\omega)\}^2 + \{G''(\omega)\}^2]^{1/2} \quad (3.44)$$

The complex viscosity, η^* , can be computed from the complex modulus as;

$$\eta^*(\omega) = [\eta'(\omega)^2 + \eta''(\omega)^2]^{1/2} = G^*(\omega)/\omega \quad (3.45)$$

The frequency dependence of the storage modulus (G') and loss modulus (G'') of a polymeric fluid is shown schematically in Figure 3.9, and can be separated into three different regimes of viscoelastic behavior. The low frequency terminal regime corresponds to viscous flow, and provides information about the longest relaxation times of molecules. It is influenced by the configurational motions and exhibits predominantly dissipative behavior, i.e. $G'' > G'$, with G' proportional to ω^2 and G'' proportional to ω . At intermediate frequencies, if the molecular weight is high enough, the polymer solution exhibits a plateau modulus (entanglement regime), where G' and G'' cross each other which reflects the elasticity due to entanglement interactions between neighboring chains. This plateau modulus depends on the density of entanglements between macromolecules. The existence of a plateau regime in the pure polymer melt requires a molecular weight above a certain value, known as the entanglement molecular weight, M_e . At higher frequency, a transition from viscous fluid to elastic solid behavior occurs. This region is referred to as the transition regime, determined by the high-frequency motions of chain segments.

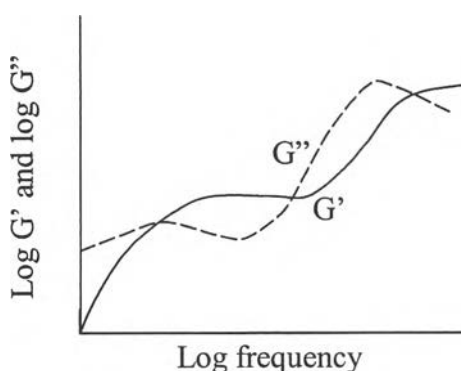

Figure 3.9 Linear viscoelastic spectrum of the shear storage modulus, G' and loss modulus, G'' for an entangled polymer solution. The solid line represents G' and the dashed line represents G'' .

(i) *Time-Temperature Superposition*

Time-temperature superposition is a method to study the full range of rheological properties by varying temperature. This procedure basically depends on the principle that all the relaxation times in a spectrum have the same temperature dependence within the temperature range considered. Therefore,

$$\tau_T = a_T \tau_0 \quad (3.46)$$

where τ is the relaxation time, the subscript T refers to the experimental temperature (T), subscript 0 corresponds to the reference temperature (T_0), a_T is the shift factor, which is defined as,

$$\ln a_T = \frac{-c_1(T - T_0)}{(c_2 + T - T_0)}, \quad (3.47)$$

where c_1 , c_2 are constants. In the case of a given polymer solution at varying concentration and temperature, it is possible to construct a master curve by plotting η/η_0 against $\eta_0\gamma$, where η_0 is the zero shear viscosity (Ferry, 1970).

In this work, the reduced parameters were calculated using the following relationships for the construction of the master curve (Tam and Tiu, 1989).

$$G'_R = G' M / cRT, \quad (3.48)$$

$$(G'' - \omega\eta_s)_R = (G'' - \omega\eta_s) M / cRT, \quad (3.49)$$

$$\omega_R = \omega(\eta_0 - \eta_s) M / cRT. \quad (3.50)$$

Here, η_s is the viscosity of the solvent (cPs), η_0 is the zero-shear viscosity (cPs), M is the molecular weight (g/mol), c is the concentration (g/mL), R is the gas constant, and T is the absolute temperature. G'_R and G''_R represent the reduced dynamic storage and loss moduli.

(ii) *Experimental Conditions*

Dynamic properties of PEO and PEO-HTAC solutions were measured with a Rheometric Fluid Scientific (RFS) rheometer, equipped with a stainless steel cone and plate geometry (cone angle: 0.02 rad, diameter: 25 mm, and gap size: 0.05 mm), which consists of 2 circular disks, a stationary upper plate and an oscillating lower plate (see Figure 3.10). The lower plate is driven by a servo motor and the torque response on the upper plate is recorded by an air-driven transducer. The sample solutions were placed in a gap between these plates. Two modes of dynamic measurements were performed in this work; (a) the strain sweep mode and (b) the frequency sweep mode.

(a) *Dynamic Strain Sweep*: Rheological properties of viscoelastic materials are independent of strain up to a critical value which is known as the linear viscoelastic regime. Beyond this level, the materials behave as a nonlinear viscoelastic behavior. The dynamic strain sweep measurements were performed in order to ensure that all measurements were carried out in the linear viscoelastic regime. The experimental frequency was fixed at 10 rad/sec and the strain was varied from 1% to 500%, for each temperature. The measurements were performed within a temperature range of 10° to 50° C.

(b) *Dynamic Frequency Sweep*: In dynamic frequency sweep mode, the storage modulus (G'), the loss modulus (G''), and the complex viscosity (η^*) were determined as a function of angular frequency (ω). The measurements were carried out varying the frequency range between 0.01 – 100 rad/sec at a fixed strain 10%.

To explore the creep behavior, the PEO-HTAC complex solutions were made up at the maximum binding ratio of $c_s/c_p = 1.75$. Stainless steel cone and plate geometry with a cone diameter of 6 cm, and cone angle of 1.5° was utilized in the Carrimed 50 controlled-stress rheometer. Silicone oil was used to prevent solution evaporation.

3.4.6.2 Viscoelastic Properties of Surfactant Solutions

Viscoelastic properties of HTAC solutions were measured by controlled-strain fluid rheometer, operating with a dynamic frequency sweep mode in linear viscoelastic regime. The couette fixture, cup radius: 17 mm, bob radius: 16 mm, and bob length: 32 mm, and a low transducer (10 g.cm) were used in this measurement. The concentrated solution of HTAC (16% w/v, or 0.5 mM) was measured to determine whether the surfactant solution exhibits viscoelastic behavior. The temperature was varied from $10^{\circ} - 50^{\circ}\text{C}$. The measurements were carried out by varying the frequency range between 1.0 – 100 rad/sec at a fixed strain 500%.

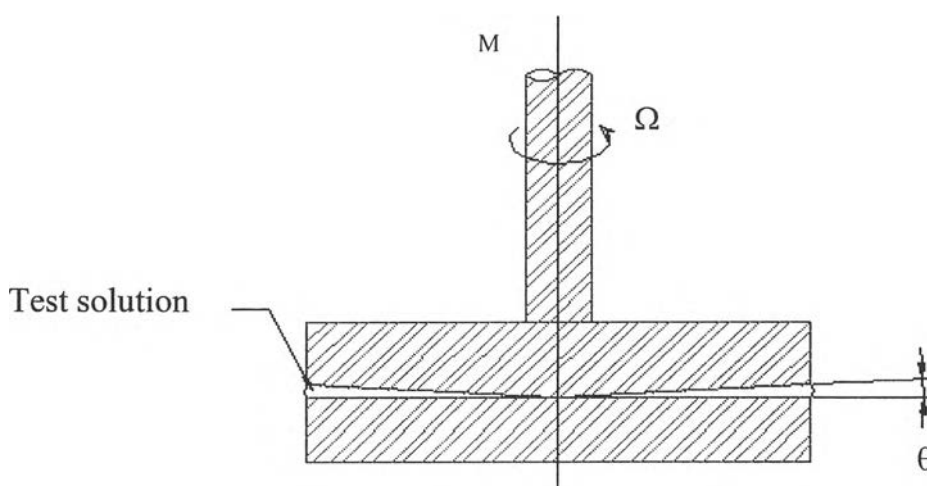

Figure 3.10 Schematic of cone and plate geometry utilized in fluid rheometry. M = torque, Ω = angular velocity, θ = cone angle.