

CHAPTER IV

SELECTIVITY IMPROVEMENT OF A SENSOR BASED ON α - NAPHTHALENE SULFONATE DOPED POLYPYRROLE TOWARD FLAMMABLE CHEMICALS IN LACQUER

Selectivity Improvement of a Sensor Based on α -Naphthalene Sulfonate Doped Polypyrrole toward Flammable Chemicals in Lacquer

Abstract

In order to improve the selectivity of polypyrrole toward acetone and toluene, which are flammable components in lacquer over the non-flammable components acetic acid and water, polypyrrole doped with α -naphthalene sulfonate (PPy/ α -NS⁻) has been blended with several insulating polymers. PEO, PMMA, HDPE, PS and ABS were added to PPy by three different methods: dry mixing, solution mixing, and coating. The specific conductivity values of these blends were reduced by 1-4 orders of magnitude relative to that of pure PPy/ α -NS⁻, depending on the polymer added and the method of mixing employed. The surface composition and wetting ability of the samples were investigated by XPS and optical microscope techniques, respectively. For the electrical conductivity response towards liquid of water, acetone, acetic acid, or toluene, the blends from solution mixing of PPy/ α -NS⁻/PMMA, PPy/ α -NS⁻/PS and PPy/ α -NS⁻/ABS were found to be more sensitive towards acetone and toluene but less sensitive towards water, relative to pure PPy/ α -NS⁻. However, the sensitivity towards acetic acid was not significantly altered from that of pure PPy/ α -NS⁻.

Keywords: conductive polypyrrole, sensor for flammable chemicals, polymer blends, PEO, PMMA, HDPE, PS, ABS

1. Introduction

Conductive polymers, such as doped polypyrroles (PPy), have potential applications as chemical sensors. Polymeric materials composed of conducting PPy and insulating polymers have recently been prepared for a variety of applications. PPy has been electrochemically polymerized onto the matrix of poly(urethane) [1] or poly(vinyl alcohol) [2]. It has also been chemically synthesized in the presence of PE, PP, or PMMA microbeads [3]. At 8.9 wt.% of PPy, PP particles were totally covered with a 60 nm thick PPy layer. The specific conductivity values of the composites were found to be as high as 10^{-2} S/cm. The potential applications for these materials are anti-static packaging and electromagnetic radiation shielding. PPy-polyamide composite was first reported as a gas sensor by Selampinar *et al.* [4]. Upon an exposure to CO₂, the resistance decreased and reached a steady value within 50 min, 5 times faster than that of pristine PPy. For a NH₃ exposure [4], both temporal response and sensitivity were significantly improved.

The question of how to improve the selectivity of PPy-based chemical sensors has not yet been systematically addressed in the literature. This work reports an attempt in tailoring PPy-based sensing materials to improve the sensitivity toward flammable chemicals in lacquer; i.e. acetone and toluene, and to reduce the sensitivity toward acetic acid and water, including moisture present in ambient air. Acetic acid is the other major ingredient in lacquer: it normally exists in lacquer up to 20 vol.% but is not highly flammable. Water has been reported to alter the specific conductivity values of PPys [5], and has been known to induce a bending of PPy films [6]. Simultaneous exposure to water and ammonia caused an irreversible response of PPy [7]. PPy doped with α -naphthalene sulfonate (PPy/ α -NS⁻), one of the most promising sensing elements for acetone as reported elsewhere [8], was blended with some common insulating polymers, e.g. PMMA. The difference in solubility of these insulating polymers in acetone, toluene, acetic acid, and water, as shown in Table 1 [9], was expected to change sensitivity via the degree in swelling of the PPy matrix.

Table 1 Solubility parameter, δ in $[\text{MPa}]^{1/2}$ of chemicals (shown in parentheses) and some insulating polymers (Gulke, 1989)

Polymer	Solvent Hydrogen Bonding		
	Poor Toluene (18.2)	Moderate Acetone (20.3)	Strong Water (47.9) Acetic Acid (21.3)
PEO	18.2 - 26.0	17.4 - 30.1	19.4 - 29.7
Polymethacrylic acid	0	20.3	20.6 - 29.7
PMMA	18.2 - 26.0	17.4 - 27.2	0
PS (Koppers KTPL-A)	16.4 - 21.7	16.6 - 20.3	0
ABS		16.5 - 21.0	
85%styrene/15%acrylonitrile	18.2 - 22.7	19.0 - 24.8	0

2. Experimental

2.1 The Polymerization Procedure of PPy/ α -NS⁻ and Blends Preparations

The PPy/ α -NS⁻ was chemically synthesized according to the method of Shen *et al.* [10]. Pyrrole monomer (AR grade, Fluka) was polymerized using ammonium persulphate (AR grade, Aldrich) as an oxidant under the presence of the dopant, α -naphthalene sulfonic acid, sodium salt (AR grade, Fluka). The dopant to pyrrole monomer molar ratio used was 1/5. This PPy was aged in dry air (40-50 % relative humidity) at the atmospheric pressure for more than 1 year before the experiments. During this duration, PPy/ α -NS⁻ became non-aging: its specific conductivity reached a steady state value. 0.01 g of PPy was pressed into a pellet by a hydraulic press. The pressure used for pelletization was 60 kN. The thickness of a pellet was measured by a thickness gauge (Peacock: model PDN 12N) having a resolution of 0.001 mm. The thickness values of these pressed pellets were ca. 60 μ m. The insulating polymers used for blendings proposed were: poly(ethylene oxide) (PEO, Aldrich); high density polyethylene (HDPE, Aldrich); polystyrene (PS, Polysciences, INC.); poly(acrylonitrile-co-butadiene-co-styrene) (ABS, HBC-OA060); poly(methyl methacrylate) (PMMA, Polysciences, INC.); and poly(methacrylic acid) (PMA, Scientific Polymer Products, INC). Introducing these polymers into the matrix of PPy/ α -NS⁻ was carried out by three methods: *dry mixing*, *solution mixing*, and *coating*. The first two methods had the same weight to volume ratio between PPy/ α -NS⁻ and insulating polymers (1 g:1 cm³). The attempt to cover PPy surface with insulating polymer was carried out by the coating method where the weight ratio between PPy/ α -NS⁻ and insulating polymer was 2.2.

2.1.1 Dry mixing

Dry mixing was carried out by grinding 0.2 g of PPy/ α -NS⁻ with 0.2 cm³ of PEO, PMMA, or HDPE in a mortar. 0.01 g of the mixture was then pressed into a

pellet by a hydraulic press at 60 kN. The thickness values of the pressed pellets were 60 - 70 μm .

2.1.2 Solution mixing

Solution mixing was done by first dissolving 0.2 cm^3 of PEO, PMMA, PS, or ABS in 4.0 cm^3 toluene (HPLC grade, J.T. Baker) using an ultrasonic bath. When the polymer was completely dissolved, 0.2 g of PPy/ $\alpha\text{-NS}^-$ was added. The ultrasonification was further carried out for 2 min. Finally, the film of this mixture was cast on the 2.2 x 2.2 cm^2 cover glass slide. The solution of PMA was prepared in ethanol, others by toluene. The thickness values of the free-standing films were 100 – 110 μm .

2.1.3 Coating

Coating or encapsulating PPy with a polymer film was carried out using PMMA only. 0.04 g of 5% wt/vol PMMA solution in toluene was dropped onto a PMMA sheet (1.4 x 1.4 x 0.1 cm^3). At 10 sec later, a pellet of PPy with a thickness of ca. 60 μm was immersed into this solution, on top of the PMMA sheet. Ignoring the thickness of coating PMMA, the thickness value used in conductivity calculation was the thickness value of the PPy pellet.

2.2 Physical and Electrical Properties of PPy/ $\alpha\text{-NS}^-$ and Its Blends

The morphologies of the PPy/ $\alpha\text{-NS}^-$ and its blends were studied by using a scanning electron microscope (SEM, JOEL model JOEL 520), with the acceleration voltage of 25 kV. The surface composition of PPy/PMMA blends from all three methods were extracted from the C 1s region of X-ray photoelectron spectra obtained from the X-ray photoelectron spectrometer (XPS, Perkin Elmer model PHI 5400). The non-monochromatic Mg $K\alpha$ with photon energy of 1253.6 eV was selected as the X-ray source with a power of 300 W (15 kV x 20 mA). The pass energy and the

take-off angle were 17.90 eV and 45°, respectively. The relative intensity and FWHM of C components in PMMA were fixed at the values reported by Wagner [11].

The specific conductivity values of the samples were measured by a custom-built four-point probe conductivity meter designed for liquid exposure (square array): its profile is shown in Figure 1. This probe was previously calibrated using Si and SiO₂ sheets with known resistivity values. The current, which was applied to two adjacent terminals of the probe, and the voltage drop between the other two adjacent terminals of the probe were monitored by a data acquisition system (Data Translation board model DT2801) interfaced with a personal computer. The applied current was set at a level so that the samples obeyed Ohmic behavior without the Joule heating effect.

2.3 The Electrical Response of PPy/ α -NS⁻ and Its Blends toward Chemicals and Interaction Mechanism

For chemical detection experiments, 3.0 ml of chemical: deionized water; acetone (AR grade, Lab-Scan); acetic acid glacial (AR grade, Lab-Scan); or toluene was dropped onto a sample, which was previously set in the probe. The change in the specific conductivity was monitored until the saturation signal was reached. The experiment was carried out at 26 °C (± 1 °C) and at 65 % relative humidity (± 5 %RH).

The proportions of neutral nitrogen (-NH-), polaron species (-NH⁺-), bipolaron species (=NH⁺-), and imine-like nitrogen (=N-) were deconvoluted from the N 1s region of X-ray photoelectron spectra of the fresh PPy samples and the ones exposed to the vapors of water, acetone, acetic acid, or toluene in N₂ for 24 hours. Because XPS is a highly surface-sensitive technique and works under a high evacuation system, only irreversible changes in composition of PPy at the surface caused by these chemicals could be detected. The observed changes will be discussed

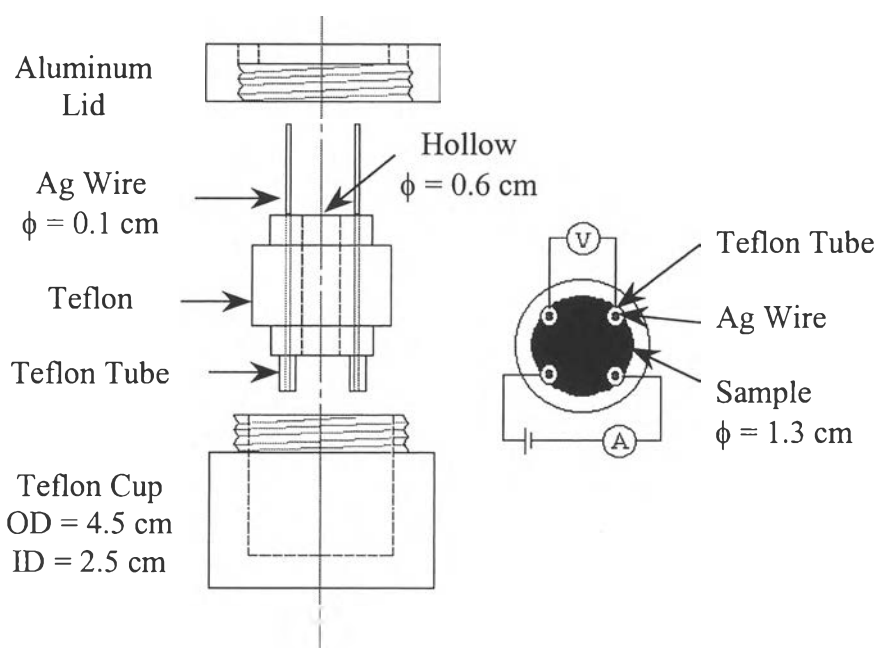

Figure 1 The schematic draw of the custom-built four-point probe for liquid exposure: a) side view; and b) the view that shows probe terminals arrangement.

here in the section of electrical response of PPy/ α -NS⁻ toward chemicals. Additional mechanistic information was obtained from the microscopic observation of the change in contact angle during exposures to certain chemicals, using a microscope (Leica model Wild M10) and a color video camera (Sony model DXC-107A/107AP). 5.00 μ L of chemical was dropped onto a sample surface by an Eppendorf[®] positive displacement pipette model 4830 with polypropylene tip.

3. Results and Discussion

3.1 Physical Properties of PPy/ α -NS⁻ and Its Blends

3.1.1 Pure PPy/ α -NS⁻

The synthesized PPy/ α -NS⁻ was a black powder with globular morphology. When it was pressed, it became a smooth and shiny pellet. The electron micrographs of PPy powder and pellet are shown in Figures 2a and 2b, respectively. The characterization of PPy/ α -NS⁻ was described elsewhere [12].

3.1.2 Blends from Dry Mixing

Because all the insulating polymers used were white, PPy/ α -NS⁻ blends from dry mixing were gray. They had good processing properties, i.e. they could easily be pressed into pellets. The electron micrographs of PPy/ α -NS⁻/HDPE pellets, as representatives of blends from dry mixing, are shown in Figures 2c. Because PPy was present in a form of very fine particles, less than 5 μ m as seen from SEM, the HDPE granules were mostly covered. The surface of the blend appeared smooth and only some of the HDPE granules could be seen even though the percentage of HDPE was as high as 50 %(vol./wt.).

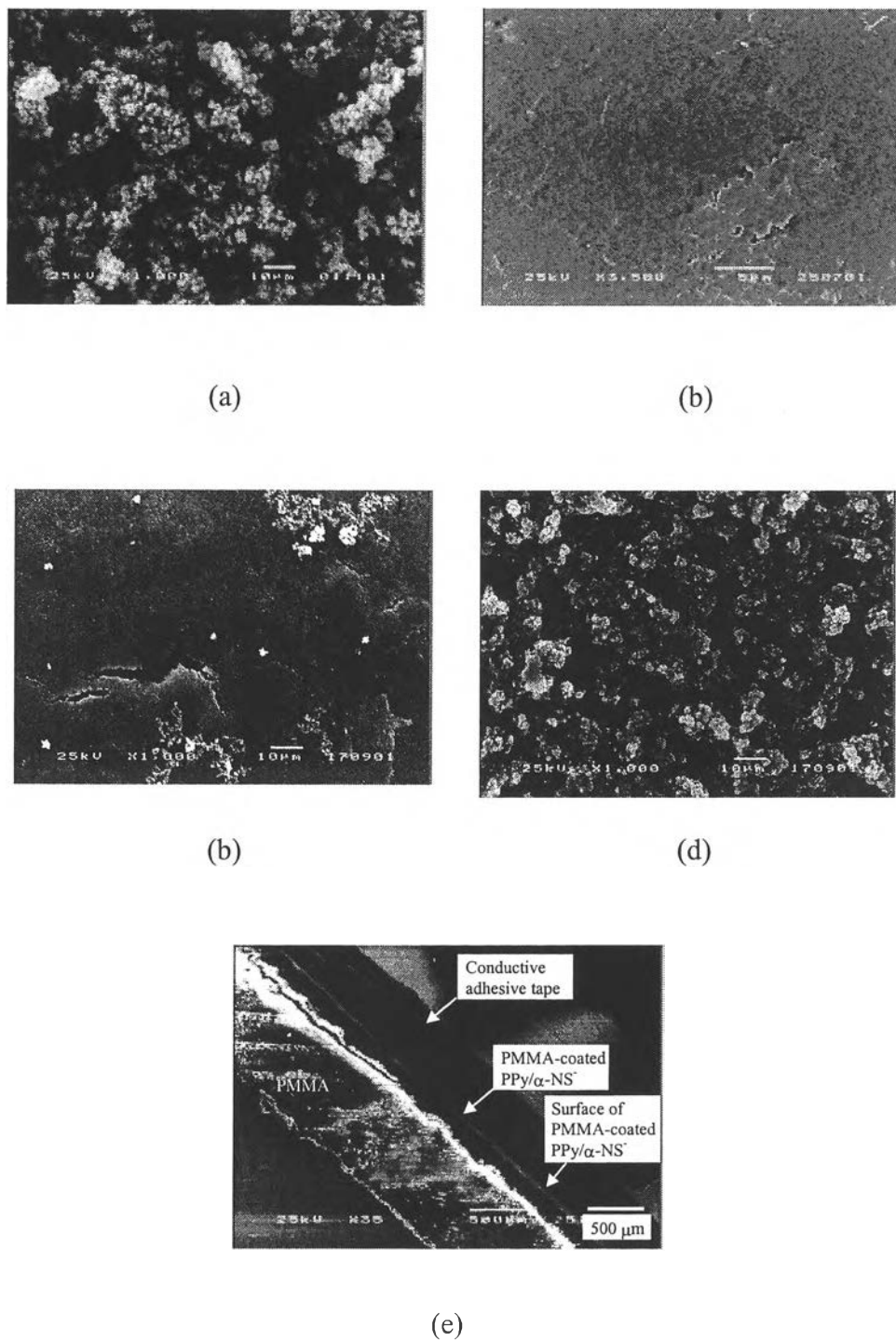

Figure 2 The electron micrographs of: a) PPy/ α -NS⁻ powder at 1000x; b) PPy/ α -NS⁻ pellet at 3500x; c) PPy/ α -NS⁻/HDPE pellet from dry mixing at 1000x; d) PPy/ α -NS⁻/PMMA film from solution mixing at 1000x; and e) cross sectional view of PMMA coated PPy/ α -NS⁻ at 35x.

3.1.3 Blends from Solution Mixing

By visual inspection, PPy/ α -NS⁻/PEO from solution blending showed significant inhomogeneity. Nevertheless, it had moderately good processing properties. The films of PPy/ α -NS⁻/PMA were brittle and suddenly disintegrated under an electric field during conductivity measurements. PPy/ α -NS⁻ blended with PS, ABS, or PMMA provided films with good appearances and better processing properties as compared with the pure PPy/ α -NS⁻. These films could be easily detached from glass slides. The electron micrographs of PPy/ α -NS⁻/PMMA, as the representative of blends from solution mixing, are shown in Figures 2d. For this film, PPy/ α -NS⁻ showed the usual globular morphology, but with the inter-globular linkages made of PMMA.

3.1.4 Polymer-Coated PPy/ α -NS⁻

When PPy/ α -NS⁻ was encapsulated with the PMMA film covering its upper surface, and a PMMA sheet supporting it from underneath, this sensing material became very robust. Figure 2e shows the electron micrograph of a cross-sectional view of PMMA-coated PPy/ α -NS⁻. As seen by SEM, the thickness of the PMMA film coating onto PMMA, without PPy pellet, was 15 μ m (SD = 3 μ m). The thickness of PMMA-coated PPy/ α -NS⁻ was 112 μ m (SD = 3 μ m), higher than the expected value: 60+15 = 75 μ m. This is due to the penetration of the PMMA solution into the porous PPy/ α -NS⁻ matrix. This thickness was also comparable to that obtained from the thickness gauge: 104 μ m (SD = 16 μ m).

3.2 X-Ray Photoelectron Spectra of PPy/ α -NS⁻ and Its Blends

The C 1s X-ray photoelectron spectrum of PPy/ α -NS⁻/PMMA film from solution mixing is shown in Figure 3 with the deconvoluted results. The peaks labeled a-c belong to C components in PPy/ α -NS⁻: a) 283.3 eV, C of pyrrole rings; b) 285.4 eV,

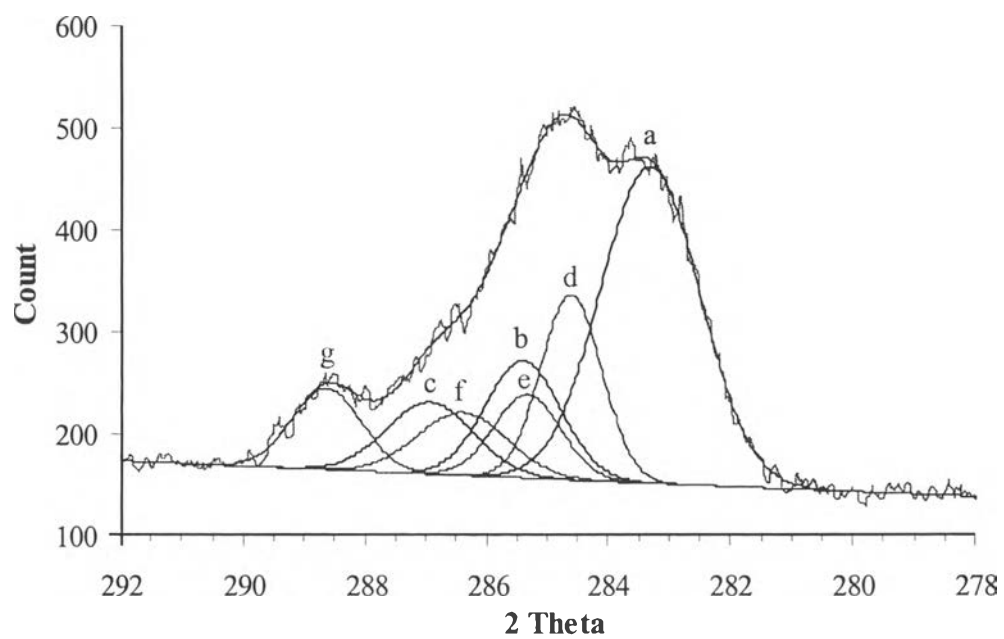

Figure 3 The C 1s XPS envelope of PPy/ α -NS/PMMA film from solution mixing with the deconvoluted results underneath.

C-O and branching C; and c) 286.8 eV, C=O. The peaks labeled d-g belong to C components in PMMA: d) 284.6 eV, $-\underline{\text{C}}\text{H}_2-\underline{\text{C}}\text{<}$ and $\text{C}-\underline{\text{C}}\text{H}_3$; e) 285.3 eV, $-\text{C}\underline{\text{H}}_2-\underline{\text{C}}\text{<}$; f) 286.4 eV, $-\text{O}-\underline{\text{C}}\text{H}_3$; and g) 288.6 eV, >C=O [11]. The fractions of PMMA (derived from the XPS peak area ratios) of the surfaces of PPy/ α -NS⁻/PMMA obtained from dry mixing, of PPy/ α -NS⁻/PMMA films obtained from solution mixing, and of PMMA-coated PPy were 0.21, 0.36 (SD = 0.03), and 0.68, respectively.

3.3 Electrical Properties of PPy/ α -NS⁻ and Its Blends

The specific conductivity values of PPy/ α -NS⁻ (7.5 S/cm, SD = 7.1×10^{-3} S/cm) and its blends are plotted and shown in Figure 4. The 50 %(vol./wt.) of PEO, PMMA, and HDPE in PPy/ α -NS⁻ dry blends caused a decrease in the specific conductivity by one order of magnitude. This decrease became larger for solution mixing of PMMA, PS and ABS; it was three orders of magnitudes for the same blend ratio. It can be noticed that PPy/ α -NS⁻ blended with PEO from solution mixing had four orders of magnitude lower specific conductivity than that pure PPy/ α -NS⁻. The PMMA-coated PPy/ α -NS⁻ obtained from the coating method had the lowest specific conductivity.

The conductivity results were consistent with the observations made by electron microscopy and XPS. For dry mixing, these insulating polymers were effectively coated with PPy. Consequently, PPy particles were inter-connected to each other. The decrease in the specific conductivity was small and could be directly attributed to the introduction of the insulating polymers.

As compared with the PPy/ α -NS⁻/PMMA from dry mixing, the PPy/ α -NS⁻/PMMA from solution mixing had a lower specific conductivity, due to the penetration of PMMA solution into the PPy matrix destroying the continuity of conductive particles. The polymeric bridges, as seen in Figure 2f, improved the processing properties of PPy. The larger decrement in specific conductivity of PPy/ α -NS⁻/PEO resulted from its non-homogeneity as can be observed by bare eyes.

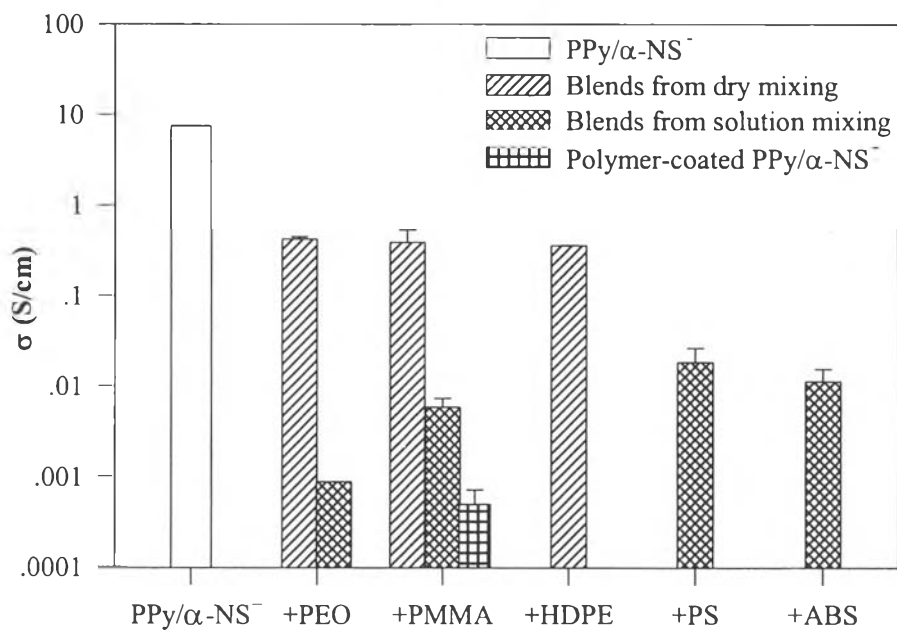

Figure 4 The specific conductivity of: pristine PPy/ α -NS⁻ pellets; pellets of its blends form dry mixing; films of its blends from solution mixing; and polymer-coated PPy/ α -NS⁻, measured at 26 ± 1 °C and at 65 ± 5 % RH.

In the case of the coating method, XPS data showed that there was more PMMA present at the surface, as compared to the blends which were obtained from dry and solution mixing. Apparently, the thin insulating layer of PMMA significantly reduced the specific conductivity.

3.4 The Contact Angle of PPy/ α -NS⁻ and Its Blends during Chemical Exposures

When 5.0 μ L (SD = 0.4 μ L) of water was dropped onto the surface of samples, its volume remaining on the sample surface and contact angle were recorded as a function of the contact time, as shown in Figures 5a and 5b, respectively. Both volume and contact angle decreased with increasing time, but at different rates depending on samples. The rate of volume decrease was in this order: PPy/ α -NS⁻/PMMA pellet obtained from dry mixing > pure PPy/ α -NS⁻ pellet > PMMA sheet ~ PMMA-coated PPy/ α -NS⁻ > PPy/ α -NS⁻/PMMA film obtained from solution mixing. The order of increase in the initial contact angle was: PPy/ α -NS⁻/PMMA pellet obtained from dry mixing < PMMA sheet ~ PMMA-coated PPy/ α -NS⁻ < pure PPy/ α -NS⁻ pellet < PPy/ α -NS⁻/PMMA film obtained from solution mixing. The other dry blends showed comparable results to those of PMMA, except those of PEO. PPy/ α -NS⁻/PEO pellet obtained from dry mixing had an initial contact angle with water of 40°, with the same adsorption rate as other dry blends.

Different decreases in water volume remaining on the surfaces of the samples can be explained in terms of porosity and density of polymer particles, and void space between particles in sample pellet. PPy, with its globular structure, is known to be porous [13]. With the introduction of other polymer microbeads, e.g. PMMA, the additional void spaces created by the particles of two immiscible polymers enhanced the water adsorption. The low contact angle of PPy/ α -NS⁻/PEO pellet obtained from dry mixing revealed a good compatibility with water. The long time needed for water absorption of the PPy/ α -NS⁻/PMMA film from solution mixing was due to its high film density, three times higher than that of the pure PPy/ α -NS⁻ pellet. Its unusual high contact angle with water probably reflected unusual surface properties. The

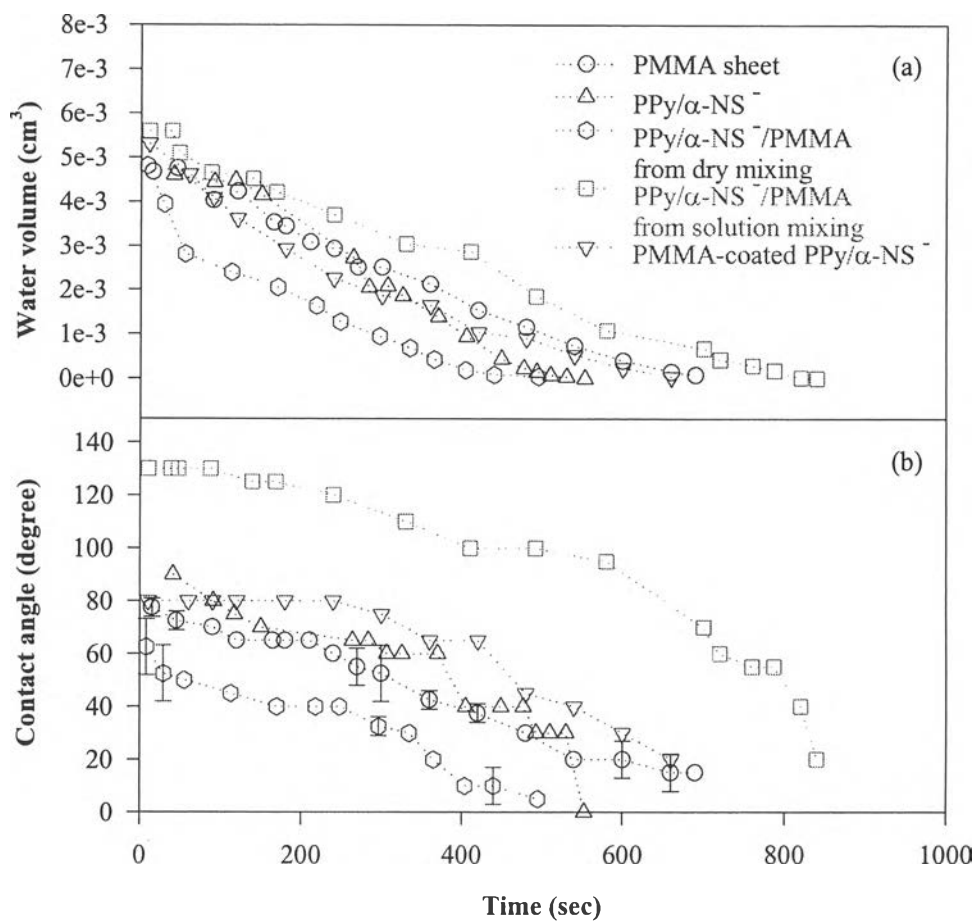

Figure 5 a) The water volume, and b) the contact angle between water and five different samples: PMMA sheet, pure PPy/ α -NS⁻ pellet, PPy/ α -NS⁻/PMMA pellet obtained from dry mixing, PPy/ α -NS⁻/PMMA film obtained from solution mixing, and PMMA-coated PPy/ α -NS⁻, as a function of the contact time.

PMMA-coated PPy/ α -NS⁻ showed behavior similar to that of the PMMA sheet. This, again, confirms the appearance of PMMA-rich surface of the PMMA-coated PPy/ α -NS⁻.

When 5.00 μ l of acetone, acetic acid, or toluene was dropped onto the surface of PPy/ α -NS⁻ and its blends, the droplet immediately penetrated into the sample matrices, making contact angle measurements impossible.

3.6 Electrical Response of PPy/ α -NS⁻ and Its Blends toward Chemicals

Some of electrical responses of pure PPy/ α -NS⁻ and its blends toward chemicals are shown in Figures 6 and 7, as examples. The changes in specific conductivity values of these PPys are quantitatively tabulated in Table 2, along with the response times (t_{response}) and the times required to reach equilibrium (t_{eqb}). These results are described and interpreted as follows:

3.6.1 Deionized Water

The conductivity of pure PPy/ α -NS⁻ suddenly dropped down when it was exposed to liquid water at room temperature, but finally it gradually increased and reached, after more than 1500 sec, a value 32.3 % (SD = 10.3 %) which was higher than its initial value. Blends of PPy/ α -NS⁻/PMMA and PPy/ α -NS⁻/HDPE from dry mixing, showed a similar response as the pure PPy/ α -NS⁻ with comparable response times. In contrast to this, the specific conductivity of PPy/ α -NS⁻/PEO blend from dry mixing decreased by 8% within the first 100 sec, and then remained constant. For the blends from solution mixing, PPy/ α -NS⁻/PEO showed an immediate, large decrement in specific conductivity whereas the other blends obtained from solution mixing were insensitive to water, relative to the pure PPy/ α -NS⁻. The PMMA-coated PPy/ α -NS⁻ was completely insensitive to water.

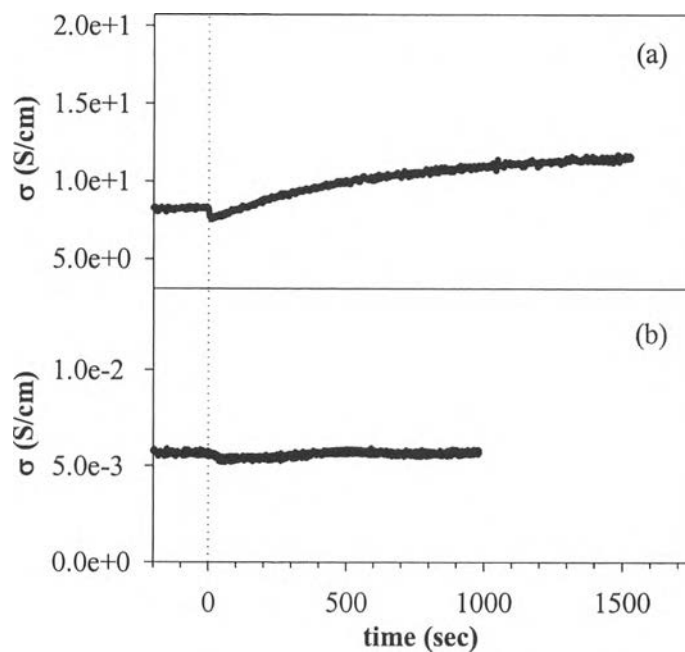

Figure 6 The electrical conductivity responses toward deionized water of: a) PPy/ α -NS⁻; and b) PPy/ α -NS⁻/PMMA from solution blending, measured at 25 °C and at 59 % RH. The y-axes are between - 60% and +160% of the initial specific conductivity values.

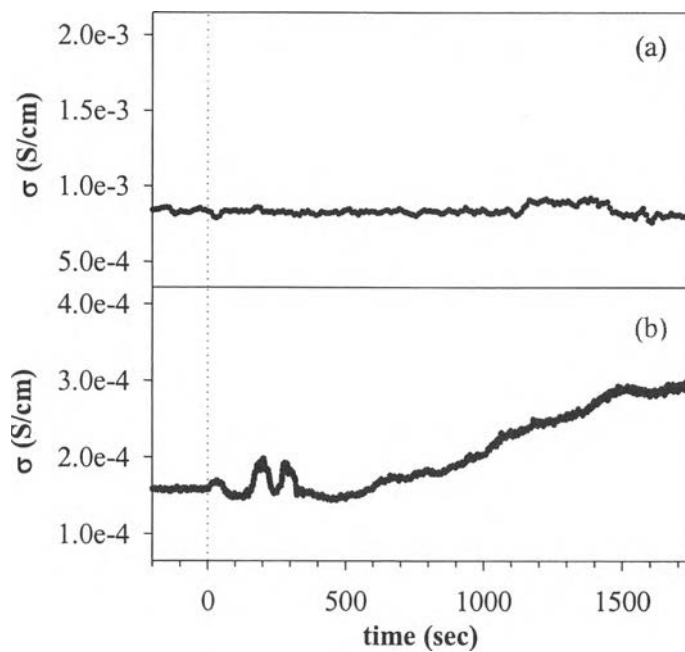

Figure 7 The electrical conductivity responses of PMMA-coated PPy/ α -NS⁻ toward: a) acetone; and b) toluene, measured at 26 °C, 70 % RH and at 25 °C, 69 % RH, respectively. The y-axes are between - 60% and +160% of the initial specific conductivity values.

From the N 1s XPS study, after a prolonged exposure of PPy/ α -NS⁻ to water, the proportion of the bipolaron species decreased whereas that of the imine-like nitrogen (-N=) increased. This suggests the abstraction of H from the bipolaron species caused by water molecules. The decrease in the concentration of conducting bipolaron species caused the sudden decrease in specific conductivity of the pure PPy/ α -NS⁻. A by-product in this reaction is H₃O⁺ some of which may have been vaporized under the electric field at the beginning. But eventually, some of these H₃O⁺ species induced ionic conductivity within the matrix. This agrees with the gradual increase in the specific conductivity of the sample, as shown Figure 6a.

For PPy/ α -NS⁻/PEO obtained from dry mixing, PEO, a water-soluble polymer swelled in the presence of water. This swelling caused a longer distance between conducting PPy particles, thus reducing the blend's conductivity. Other blends from dry mixing containing insulating polymers, which did not swell or dissolve in water (PMMA and HDPE), behaved as if they were pure PPy because their surfaces were rich with PPy. Since there was no benefit for a selectivity improvement, those dry blends were not further studied.

In PPy/ α -NS⁻/PEO from solution mixing, PEO induced the same phenomena as in the case of dry blend but with a larger magnitude because it was better mixed with PPy. The introduction of other insulating polymers, which did not swell or dissolve in water (PMMA, PS, and ABS) (see Table 1) into the PPy matrix by means of solution mixing, enhanced the incompatibility of PPy with water, thereby obstructing possible interactions.

For PMMA-coated PPy/ α -NS⁻, it can be seen from Figure 6a that there was an absorption of water into the sample. The function of the thin insulating layer of PMMA on the PMMA-coated PPy/ α -NS⁻ was evidently not to protect PPy from water but to screen out the H₃O⁺ which could induce ionic conductivity from the probe.

Table 2 The processing property, the response time (t_r), the change in σ ($\Delta\sigma_{eqb}/\sigma_i \times 100\%$), and the time required to reach an equilibrium response (t_{eqb}) toward water, acetone, acetic acid, and toluene of PPy/ α -NS⁻ and its blends

Material	Processing property	Toward DI water			Toward acetone			Toward acetic acid			Toward toluene		
		t_r (sec)	$\Delta\sigma_{eqb}/\sigma_i$ x 100 %	t_{eqb} (sec)	t_r (sec)	$\Delta\sigma_{eqb}/\sigma_i$ x 100 %	t_{eqb} (sec)	t_r (sec)	$\Delta\sigma_{eqb}/\sigma_i$ x 100 %	t_{eqb} (sec)	t_r (sec)	$\Delta\sigma_{eqb}/\sigma_i$ x 100 %	t_{eqb} (sec)
PPy/ α -NS ⁻	Good	<1	32.3 (10.2)	>1000	<1	-28.4 (6.8)	150	<1	-28.9 (4.15)	120-150	unclear	1.2	unclear
<u>Blends from dry mixing</u>													
PPy/ α -NS ⁻ /PEO	Poor	<1	-7.9	300	N/A	N/A	N/A	N/A	N/A	N/A	N/A	N/A	N/A
PPy/ α -NS ⁻ /PMMA	Good	<1	32.4 (3.0)	>1000	N/A	N/A	N/A	N/A	N/A	N/A	N/A	N/A	N/A
PPy/ α -NS ⁻ /HDPE	Good	<1	33.2 (13.0)	>1000	N/A	N/A	N/A	N/A	N/A	N/A	N/A	N/A	N/A
<u>Blends from solution mixing</u>													
PPy/ α -NS ⁻ /PEO	Poor	<1	-61.06	100	N/A	N/A	N/A	N/A	N/A	N/A	N/A	N/A	N/A
PPy/ α -NS ⁻ /PMA	Poor	N/A	N/A	N/A	N/A	N/A	N/A	N/A	N/A	N/A	N/A	N/A	N/A
PPy/ α -NS ⁻ /PMMA	Good	unclear	0.29	unclear	<1	-98.2 (0.1)	30	<1	-55.3 (4.7)	>500	<1	-74	<40
PPy/ α -NS ⁻ /PS	Good	unclear	0.75 (3.2)	unclear	<1	-99.5 (0.0)	30	<1	-57.0 (2.8)	>500	<1	-64	<40
PPy/ α -NS ⁻ /ABS	Good	800	-7.8 (0.8)	2500	<1	-98.0 (1.2)	30	<1	-44.6 (8.3)	>500	<1	-65	<40
<u>Polymer-coated PPy/α-NS⁻</u> PMMA-coated PPy/ α -NS ⁻	Good	-	0	-	-	0	-	-	0	-	2	>150	>3000

3.6.2 Acetone

Upon exposure to liquid acetone, the conductivity of pure PPy/ α -NS⁻ suddenly decreased and reached a saturated value at -28.4 % (SD = 6.8 %) within 100 sec. The responses of the blends of PS, ABS and PMMA from solution mixing were enhanced with faster response times (<50 sec). The response of encapsulated PPy/ α -NS⁻ was retarded giving poorly reproducible changes in conductivity with a general pattern showing a slow increase in specific conductivity, going to a maximum after about 1000 second of exposure, followed by a decrease. Due to this very slow response, the PMMA-coated PPy/ α -NS⁻ was considered as an acetone insensitive material.

The interaction between acetone and PPy/ α -NS⁻ has been described elsewhere [8]. The decrease in specific conductivity was caused by the H-bonding, the disordering, and the swelling effect.

PMMA, PS, and ABS have solubility parameters comparable to acetone [9]. When they were introduced into PPy matrix, they became swollen or dissolved under acetone exposure thereby separating the conducting PPy particles. This in turn caused a further specific conductivity decrease, in addition to the effects caused on PPy itself.

In the case of PMMA-coated PPy/ α -NS⁻, the increase in specific conductivity after an induction period probably resulted from the swelling and the eventual dissolving of the thin insulating PMMA layer on the PPy/ α -NS⁻ pellet. Hence the surface of conducting PPy/ α -NS⁻ was exposed to the probe terminals and the specific conductivity increased. This event was immediately followed by the interaction between PPy/ α -NS⁻ and acetone which decreased the specific conductivity of the sample.

3.6.3 Acetic Acid

The specific conductivity of pure PPy/ α -NS⁻ decreased suddenly after an acetic acid exposure and became saturated within 75-100 sec at -31.6 % (SD = 6.2 %). It decreased by 40 – 60 % in the cases of PPy/ α -NS⁻/PS, PPy/ α -NS⁻/PMMA, and PPy/ α -NS⁻/ABS blends from solution mixing. The conductivity response of encapsulated PPy/ α -NS⁻ was retarded and became non-reproducible. At exposure times greater than 4000 sec, the specific conductivity of PMMA-coated PPy/ α -NS⁻ would start to increase. Due to such a slow response, the PMMA-coated PPy/ α -NS⁻ was considered to be acetic acid insensitive.

As revealed by the XPS experiment, for the PPy/ α -NS⁻ that was treated with acetic acid for 24 hours, the -NH- species increased whereas the =N- species decreased. This simply suggests the protonation reaction of acetic acid onto the =N- species, the most nucleophilic site in PPy, leading to a change in electron density of the PPy chain.

Even though PS, ABS, and PMMA were reported as insoluble in a strong H-bonding solvent such as acetic acid [9], we found in our laboratory that they dissolved well in the glacial acetic acid. However, as compared with acetone, the solubility was smaller. This surprising solubility may explain why there was a decrease in the specific conductivity of the blends from solution mixing when exposed to the glacial acetic acid.

Though PPy/ α -NS⁻ was coated with PMMA by the coating method, the thin PMMA layer disintegrated under a long-term acetic acid exposure and electric field. Therefore, more of the PPy surface would be able to make contact with the probe terminals, thus the specific conductivity would be expected to increase. Based on our experience with acetone, we expect that the conductivity may, after extremely long exposure time (beyond the practical experimental observation time), eventually start to decrease due to the direct interaction between acetic acid and PPy.

3.6.4 Toluene

Among the probe chemicals studied, the smallest response of pure PPy/ α -NS⁻ was obtained for toluene exposure. The decrease in the specific conductivity was only 1.2 %. However, the blends of PS, ABS or PMMA from solution mixing gave significant negative responses with specific conductivity decreases up to 60 – 70 % within only 40 sec. The specific conductivity of PMMA-coated PPy/ α -NS⁻, on the other hand, gradually increased without ever reaching saturation within the experimental observation time (Figure 7b).

In the case of a prolonged exposure to toluene, there was no significant change observed from XPS. This corresponds to the small change in the specific conductivity of PPy/ α -NS⁻ upon an exposure to toluene. Even though this non-polar chemical effectively swelled many types of insulating polymers, e.g. PMMA, PS and ABS, it did not swell PPy/ α -NS⁻ nor alter its specific conductivity.

By solution mixing with PS, ABS or PMMA, the sensitivity and the response time of PPy/ α -NS⁻ were improved, due to the swelling effect.

The increase in specific conductivity of PMMA-coated PPy/ α -NS⁻ was induced by the dissolving of the thin insulating PMMA layer which provided a protective coating on PPy/ α -NS⁻ pellet in toluene. This again exposed the fresh conducting PPy/ α -NS⁻ to the probe terminals as in the case of acetone exposure. However, the response time was faster because PMMA was easily dissolved in toluene.

4. Conclusion

Blends of PPy/ α -NS⁻ and common insulating polymers have been successfully prepared as highly selective sensors. The blends of PPy/ α -NS⁻ and PS, ABS, or PMMA from solution mixing showed a significant improvement in sensitivity and temporal response toward acetone and toluene, primarily due to the swelling effect. Moreover, the response toward water, a serious interference problem for on-line sensors, was successfully diminished. The PMMA-coated PPy/ α -NS⁻ is an ideal water-insensitive sensing material; however, it had an induction period and poorly reproducible responses toward the target chemicals.

5. Acknowledgements

The authors are grateful to all financial supports: the Rajadapisek Fund of Chulalongkorn University Thailand; a RGJ grant from Thailand Research Fund, no. PHD/4/2541; and a BGJ award, no. BGJ/5/2543. We are indebted to Ms. Jutharat Amornlertrattanatada, C.P.O. Poon Arjpru, and staffs of the Petroleum and Petrochemical College, Chulalongkorn University, Thailand and Dr. Corinna Wauchope, the XPS staff of the Electron Microscope Analysis Laboratory, the University of Michigan, USA.

6. References

- [1] H.-T Chiu, S.-J. Lin, C.-M., Huang, J. Appl. Electrochem. 22 (1992) 358.
- [2] S. E. Lindsey, G. B. Street, Synth. Met. 10 (1984) 67.
- [3] M. Omastova, S. Kosina, J. Pionteck, J. Andreas, J. Pavlinec, Synth. Met. 81 (1996) 49.
- [4] F. Selampinar, L. Toppare, U. Akbulut, T. Yalcin, S. Suzer, Synth. Met. 68 (1995) 109.
- [5] C. Cassignol, P. Olivier, A. Ricard, J. Appl. Polym. Sci. 70 (1998) 1567.
- [6] H. Okuzaki, T. Kuwabara, T. Kunugi, Polym. 38 (1997) 5491.

- [7] G. Gustafsson, I. Lundström, *Synth. Met.* 21 (1987) 203.
- [8] L. Ruangchuay, Development of Polypyrrole-Based Sensors for Vapors of Flammable Chemicals, Ph.D. Thesis, Chapter III, Petroleum and Petrochemical College, Chulalongkorn University, 2003.
- [9] E. A. Grulke (1989). Solubility Parameter Values. In J. Brandrup, E. H. Immergut (Eds.), Polymer Handbook, 3rd ed. USA: John Wiley & Sons. pp. VII/519 – 559.
- [10] Y. Shen, M. Wan, *Synth. Met.* 96 (1998) 127.
- [11] C.D. Wagner (1989) NIST X-Ray Photoelectron Spectroscopy Database 1.0, National Institute of Standards and Technology, USA.
- [12] L. Ruangchuay, Development of Polypyrrole-Based Sensors for Vapors of Flammable Chemicals, Ph.D. Thesis, Chapter II, Petroleum and Petrochemical College, Chulalongkorn University, 2003.
- [13] S. Kosina, S. Baluch, J. Annus, M. Omastova, J. Kristin, *J. Mat. Sci.* 29 (1994) 3403.