

RERERENCES

- 1 Sanberg, A. 1998. Toner Jet tandem color has reached prototype stage. IS&T's NIP14: International Conference on Digital Printing Technologies Springfield: IS&T, pp 180-183.
- 2 Tompson, B. 1998. Printing Materials: Science and Technology. Surrey: Pira International, Chapter 19.
- 3 Sturge, J.; Walworth, V. and Shepp, A. 1989. Imaging processes and Materials. Neblette's 8th ed. New York: Van Nosteand Reinhold, Chapter 1-2.
- 4 Erickson, B. and Romano, F. 1999. Professional digital photography. Upper Saddle River, N.J.: Prentice Hall PTR, pp 176-200.
- 5 Birch, P. 1996. Managing change in the printing and publishing industry-strategic approaches. Surrey: Pira International, Chapter 1.
- 6 Palmqvist, B. A. and Akesson, J. 1999. Tool for simulation of toner particle motion. IS&T's NIP15: International Conference on Digital Printing Technologies. Springfield: IS&T, pp 276-279.
- 7 Hoshino, Y. and Hirayama, H. 1999. Dot formation by toner beam from toner cloud. IS&T's NIP 15: International Conference on Digital Printing Technologies Springfield: IS&T, pp 598-600.
- 8 Hoshino, Y.; Kutsuwada, N.; Watanabe, Y. and Izawa, H. 1996. Measurement of van der Waals force of toner adhesion employing a linearly increasing electric field and determining the toner jumping voltage. Particulate Science and Technology 14 (1996): 267-277.

- 9 Kiatkamjornwong, S.; Noppakundilokrat, S.; Ando, Y; and Hoshino, Y. 1997. Toner adhesion force estimation by electric field activated toner jumping. Journal of Imaging Science and Technology vol. 41 no. 1 (January 1997): 54-58.
- 10 Fukuchi, Y. and Takeuchi, M. 1998. A comparative study on toner adhesion force measurement by toner jumping and centrifugal methods. IS&T's NIP 14: International Conference on Digital Printing Technologies Springfield: IS&T, pp 390-393.
- 11 Hoshino, Y; Muta, T. and Kamata, M. 1997. Toner jumping characteristic in electric field using dented electrode. Recent Progress in Toner Technologies (1997): 21-23.
- 12 Speirs, M. H. 1998. Introduction to printing and finishing. London : British Printing Industries Federation; Pira International, pp 44-50, 62-63.
- 13 ปราโมทย์ เดชะอำไพ. 2542. ระเบียบวิธีเชิงตัวเลขในงานวิศวกรรม. กรุงเทพฯ: สำนักพิมพ์แห่งจุฬาลงกรณ์มหาวิทยาลัย, หน้า 423-481.
- 14 Giordano, J. N. 1997. Computational physics. New Jersey: Prentice Hall, pp 113-135.

ศูนย์วิทยทรัพยากร
จุฬาลงกรณ์มหาวิทยาลัย



APPENDICES

ศูนย์วิทยทรัพยากร
จุฬาลงกรณ์มหาวิทยาลัย

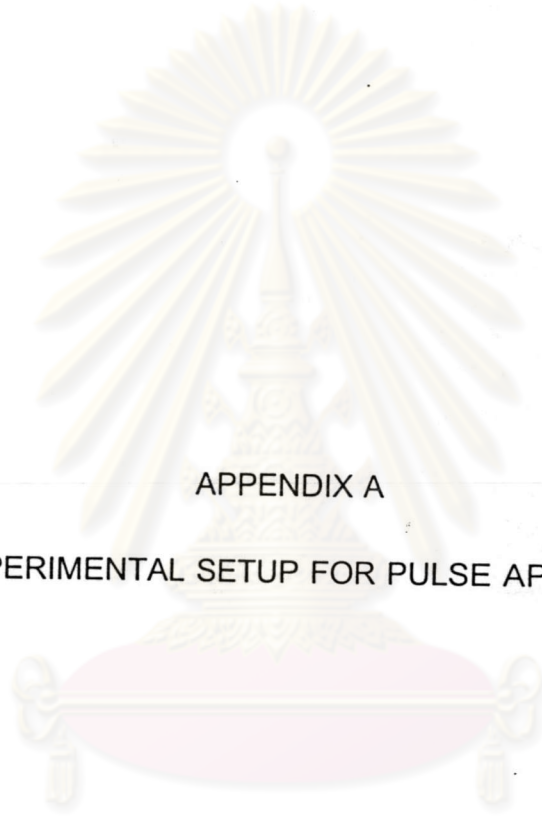

APPENDIX A

THE EXPERIMENTAL SETUP FOR PULSE APPLICATION

ศูนย์วิทยทรัพยากร
จุฬาลงกรณ์มหาวิทยาลัย

The Experimental setup for pulse application

The TCB experiment was setup using the schematic diagram as shown in Figure 1. From this schematic diagram, the system consists of four DC voltage sources which generate the voltages applied to the electrodes. The voltages applied to the electrodes are adjusted by changing the output voltage of these sources.

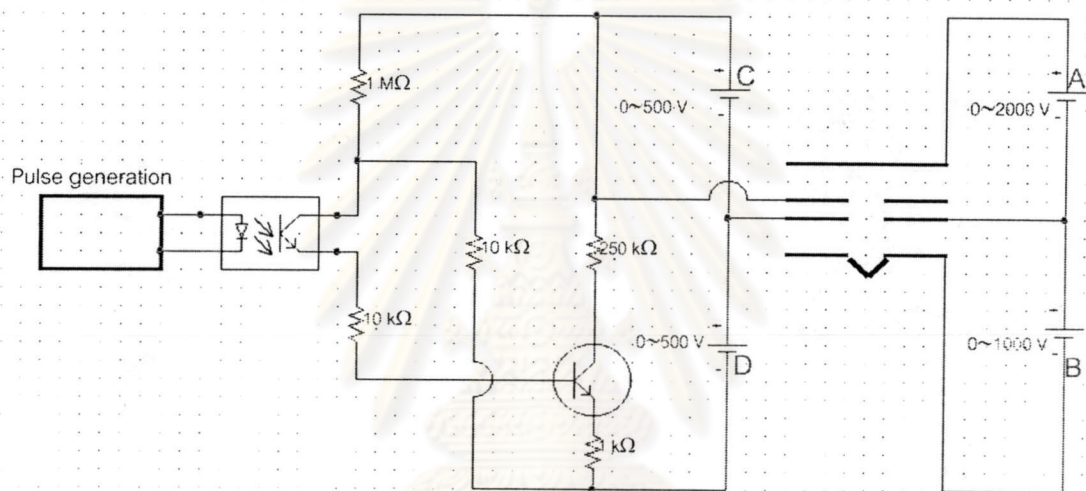

Figure 1 Schematic diagram of pulse voltage application

In order to generate the voltages applied to the electrodes, four ultra small size High Voltage DC-DC converters manufactured by Bellnix Co.,Ltd are used. These DC-DC converters are designed for the applications as shown in Table 1. The DC-DC converter model SHV12-0.5K6000P and SHV12-2.0K1000P are referred by C and A in Figure 3-8. They provide +500 VDC and +2000 VDC for applying to the electrodes, respectively. D and B refer to the converter model SHV12-0.5K6000N and SHV12-1.0K1000N, which provide -500 VDC and -1000 VDC for applying to the electrodes. The

four models of DC-DC converters are similar in size and shape. An example of the DC-DC converters used in the experiment (model SHV12-2.0K1000P) is shown in Figure 2. All four models as mentioned above have the configuration of SHV series is shown in Figure 3. Each one has seven junctions presented by number one to seven.

Table 1 Ultra small size High Voltage Output DC-DC Converters

Sign in the Circuit	Model	Input V Vdc	Input I mA	Output V Vdc	Output I mA	Load K Ω (min)
C	SHV12-0.5K6000P	10.8~13.2	390	0~+500	0~6.0	83.3
D	SHV12-0.5K6000N	10.8~13.2	390	0~-500	0~6.0	83.3
A	SHV12-1.0K2000N	10.8~16.5	290	0~-1000	0~2.0	500
B	SHV12-2.0K1000P	10.8~16.5	3400	0~+2000	0~1.0	2000



Figure 2 The DC-DC converter model SHV12-2.0K1000P

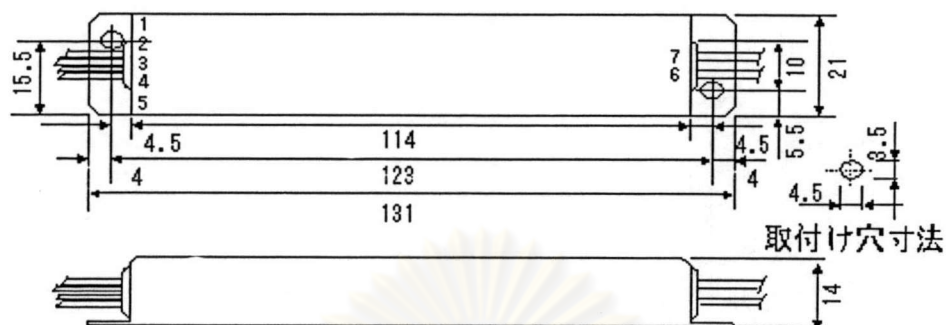

Figure 3 Configuration of SHV DC-DC converters

The input/output configurations of SHV series are shown in Figure 4. The input voltage source must connect to junction number one and two and the output voltage come across the junction number six and seven. Since the output of the SHV DC-DC converters is directly proportional to the input voltage. When replace R1 and R2 with the variable resistor, and then we can adjust the output voltage from 0 V to the maximum voltage as shown in Table 1.

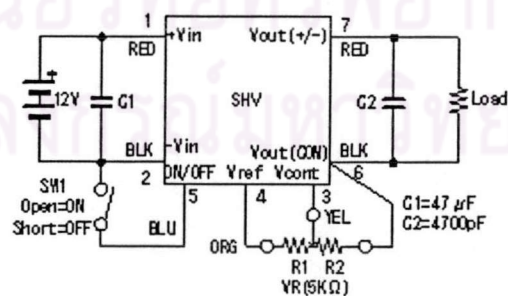

Figure 4 Input/output configurations of SHV DC-DC converters



Figure 5 AC-DC switching power supply of KENWOOD

Four AC-DC power supplies of KENWOOD as shown in Figure 5 is utilized to convert the AC current into DC and supplies the DC voltage to the SHV DC-DC converters. In this case, the output voltage of AC-DC power supplies is set at 12 VDC.

The pulling electrode, upper control electrode, lower control electrode and dented electrode are setup as same as described in Section 3.3.1. In this part, the aperture of the control electrodes is setup about 0.5 and 0.8 mm in diameter, which is smaller than in Section 3.3.1. The useful of smaller aperture size is that it gives a sharp toner dot and the size of dot is smaller distribution. The experimental setup of TCB is shown in Figure 6.

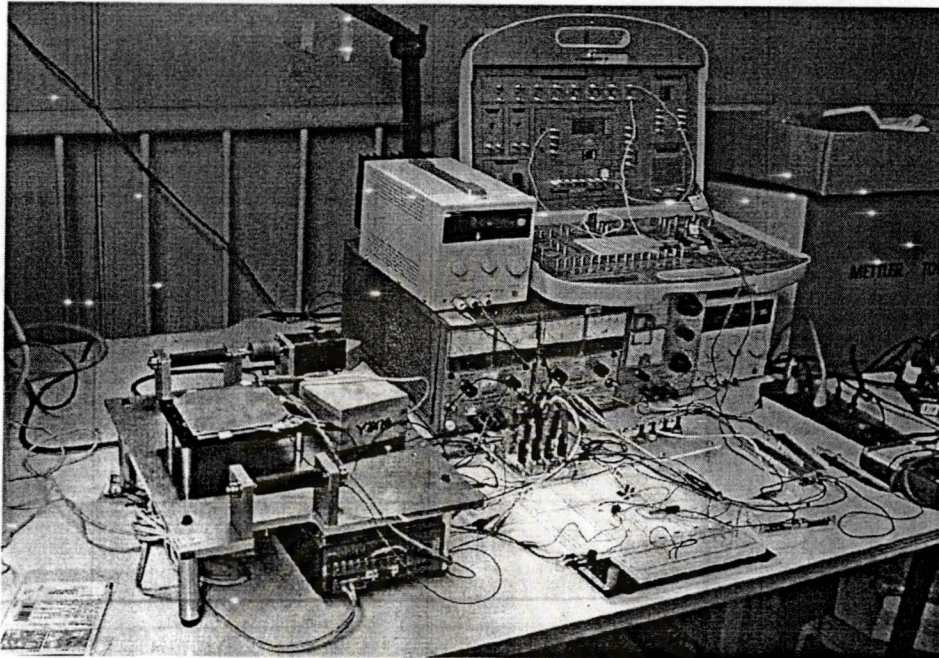

Figure 6 The TCB experiment setup for pulse application

The experimental setup as shown in Figure 6 has the advantages in that the applied voltages to the electrodes is designable and give range of applied voltage wider than in Section 3.3.1. Moreover this circuit is convenient for pulse voltage applications.

The experiment procedures to generate the toner dots of this experiment are similar in Section 3.3.2 but difference in that the adjustment of applied voltage is processed by adjusting the resistances of variable resistors connected with SHV DC-DC converters.



APPENDIX B
ELFIN BASICS

ศูนย์วิทยทรัพยากร
จุฬาลงกรณ์มหาวิทยาลัย

ELFIN BASICS

Features of ELFIN

ELFIN is a powerful tool to simulate the 3D electric phenomena. It is strong in evaluating the physical quantities, such as the electric moment in material, electric field in space, electric force and Maxwell's stress. ELFIN is based on a new method developed by ELF Corporation

- Integral Element Method (IEM)
- and prepares the routine
- The Nonlinear Calculation

for considering the nonlinear properties of materials. As a result, even if the system to be analyzed contains nonlinear materials, ELFIN completes calculation without difficulty. Thanks to these features, ELFIN can widely apply for designing the capacitors, electron guns, electron microscopes, particle accelerators, power transmission systems, etc. Moreover, you can analyze the models in various sizes from the microscopic scale to the celestial scale.

Integral Element Method (IEM)

IEM is a method based on Maxwell's equations in integral form, and does not require the space mesh, boundary condition and gauge condition. It enables to obtain without ambiguity the electric field and force at any point in space including infinity from the fundamental laws in electromagnetics, such as Coulomb's law and the Biot-Savart law. IEM is a hybrid method of the following conventional methods:

- Moment method
- Surface charge method
- Surface current method
- Equivalent network method

Although each method has some faults, IEM succeeded in overcoming their weak points by combining them with one another and by appending original improvements. Consequently, IEM achieves the fast and accurate calculation that any conventional method has not been able to accomplish up to now. Especially, it is remarkable that the reliability of results is sufficiently high even for a simplified model composed of a small number of elements.

I/O Files

During calculation, ELFIN handles many I/O files classified as follows:

- Input Files (*.meg, *.mai)
- Output Files (*.mao, *.mag)
- Preservation Files (*.mat, *.maf)

Input Files

Input files are the files that contain the data on the analysis model. Basically, ELFIN requires 2 input files to obtain the information about the analysis model.

Geometry Files (*.meg)

Geometry files are the files that contain the data on model's geometry, or the data-lines for defining nodes and elements.

Control Files (*.mai)

Control files are the files that contain the commands to control the analytical process, the data on material properties and the additional data on model's geometry.

Mesh Files (*.mai)

Mesh files are the files that contain the commands to generate the elements and nodes of material and space. MEI is the input file of ELF/MESH.

Output Files

Output files are the files that contain calculation results. To confirm and visualize the results, refer them.

Output List Files (*.mao)

Output list files are the files that contain the progress report on analysis and the calculation results. By checking those contents, you can find whether the analysis has been completed successfully or terminated abnormally.

Output Data Files (*.mag)

Output data files are the files that contain the data on model's geometry and the calculation results in fixed format. You can visualize those contents using a post-processor.

Preservation Files

Preservation files are the files that contain the data used in analytical process. They are the 2-way files, which you can use as input files and output files simultaneously. Namely, ELFIN treats them as input files in shortcut calculations, and as output files for preserving the binary data.

Matrix Files (*.mat)

Matrix files are the files that contain the elements of the coefficient matrix in the determination equation in matrix form. You need a matrix file to execute PASS GENE Calculation.

Moment Files (*.maf)

Moment files are the files that contain the input data (node-coordinates, D-E data, symmetry conditions, etc.), the data for determining the configuration of electric moments, and the quantities related to the electric moments. You need a moment file to execute PASS SOLV Calculation.

Elements and Nodes

A geometry model is composed of 1 or more elements; an element consists of 1 or more nodes. The elements in ELFIN are grouped into 2 types:

- Material elements

The elements with the source of electric field such as the electric moment and surface charge

- Space elements

The elements at which the electric field is evaluated

Every element is identified by the index named Element ID (EID), and its material property is fixed through the index named Material ID (MID). You can specify an element by either of EID or MID, and any 2 elements with different EIDs are definitely distinguished from each other. Corresponding to the above classification of elements, the nodes also are categorized as follows:

- Material nodes

The nodes able to become vertexes of material elements

- Space nodes

The nodes able to become vertexes of space elements

Every node is identified by the index named Node ID (NID), and any 2 nodes with different NIDs are definitely distinguished from each other. Material nodes and space nodes are quite different in the role, so that you should use them properly according to the purpose. Namely, you have to use only material nodes for creating material elements, and only space nodes for creating space elements. Also, even if they happen to have the same NID, a material node and a space node are never confused owing to the strict distinction between them.

Notes on Creating Nodes and Elements

In creating nodes and elements, note the following points:

- You can create more than 1 node or element on the same location (multi-creation).
- You can use NID, EID, MID discontinuously.
- You can create a node not belonging to any element (the isolated node).
- You can create a node that is a vertex of a particular element but is not a vertex of another neighboring element (the mid-node).
- It is not always necessary that neighboring elements share the nodes on boundaries.

Axial Symmetry

A system has axial symmetry if all of the following conditions are kept under the rotation through an arbitrary angle θ about the z-axis:

- Geometry is invariant in a cross section including the z-axis.
- The electric field has no components perpendicular to the cross section.
- The pattern of field lines is invariant in the cross section.

For an axisymmetric system, its cross section in an arbitrary plane including the z-axis (let this plane be the xz-plane) is the principal part. In creating the axisymmetric model, note that:

- You have to use only axisymmetric elements.
- You have to build the model in the xz-plane.
- The dielectric body, electrets and potential elements cannot have their edges just on the z-axis.
- Only the z-directional mirror symmetry can apply to axisymmetric models.

Note that an axisymmetric element is treated as a 2D element in designing geometry but it actually represents a body or surface of revolution.



APPENDIX C

ELFIN INPUT FILES

ศูนย์วิทยทรัพยากร
จุฬาลงกรณ์มหาวิทยาลัย

Elfin Input Files

Etest.mei file

* PARALLEL PLATES

* ELEMENTS

G30 1 0 0 0

G30 10 0 0 0

G30 20 50 0 0

G30 30 0 0 1.98

G30 40 50 0 1.98

FLO 10 20 1 1

FLO 30 40 1 1

E2 10 1 10 20

E2 30 2 30 40

OG 1 10000 EGR1

OE 1 10000 ESR

CG 1 10000

CE 1 10000



ศูนย์วิทยทรัพยากร
จุฬาลงกรณ์มหาวิทยาลัย

R(2)

G30 1(10) 0.0(1.0) 0 0.0

R

R(2)

G30 2901(10) 0.0(1.0) 0 1.98

R

FB0 1 11 2911 2901 1 100

R(10/29)

E40 4 1(1/100) 2= 102= 101=

R

OG 1 10000 EGR2

OE 1 10000 ECO

* DENTED PLATES

* ELEMENTS

G30 1 0 0 0

G30 10 5 0 0.2

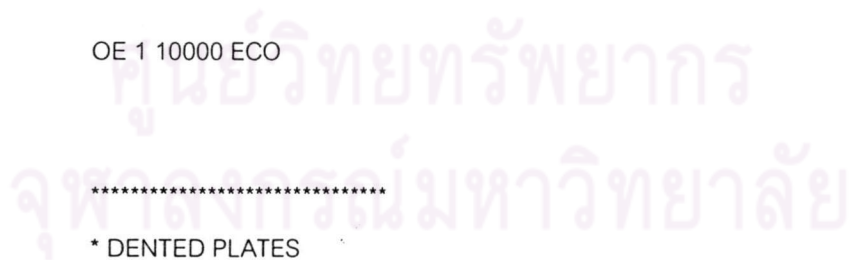

G30 12 50 0 0.2

FL0 1 10 1 1

FL0 10 12 1 1

R(11)

E2 1(1) 1 1(1) 2(1)

R

G30 40 0 0 1.98

G30 45 50 0 1.98

FL0 40 45 2 1

E2 40 2 40 45

OG 1 10000 EGR1

OE 1 10000 ESR

CG 1 10000

CE 1 10000

R(2)

G30 1(10) 0.0(1.0) 0 0.0

R

R(2)

G30 2901(10) 0.0(1.0) 0 1.98

R

FB0 1 11 2911 2901 1 100

R(10/29)

E40 4 1(1/100) 2= 102= 101=

R

OG 1 10000 EGR2

OE 1 10000 ECO

* TCB

* ELEMENTS

ศูนย์วิทยทรัพยากร
จุฬาลงกรณ์มหาวิทยาลัย

G30 1 0 0 0

G30 10 5 0 0.2

G30 12 50 0 0.2

FL0 1 10 1 1

FL0 10 12 1 1

R(11)

E2 1(1) 1 1(1) 2(1)

R

G30 30 0.4 0 0.7

G30 35 1.5 0 0.7

FLO 30 35 1 1

G30 60 0.4 0 0.74

G30 65 1.5 0 0.74

FLO 60 65 1 1

R(4)

E2 30 2 30 35

E2 60 2 60 65

R

GM0 30 30 270 0 0 0

GM0 60 60 244 0 0 0

FLO 300 304 1 1

GM0 35 35 275 0 0 0

GM0 65 65 249 0 0 0

ศูนย์วิทยทรัพยากร
จุฬาลงกรณ์มหาวิทยาลัย

FL0 310 314 1 1

E2 300 2 300 304

E2 310 2 310 314

G30 90 0.4 0 1.44

G30 95 1.5 0 1.44

FL0 90 95 1 1

G30 120 0.4 0 1.48

G30 125 1.5 0 1.48

FL0 120 125 1 1

E2 90 3 90 95

E2 120 3 120 125

GM0 90 90 230 0 0 0

GM0 120 120 204 0 0 0

GM0 95 95 235 0 0 0

GM0 125 125 209 0 0 0

FL0 320 324 1 1

FL0 330 334 1 1

E2 320 3 320 324

E2 330 3 330 334

G30 150 0 0 1.98

G30 155 50 0 1.98

FL0 150 155 1 1

E2 150 4 150 155

OG 1 10000 EGR1

OE 1 10000 ESR

CG 1 10000

CE 1 10000

R(2)

G30 1(10) 0.0(1.0) 0 0.0

R

R(2)

G30 2901(10) 0.0(1.0) 0 1.98

R

ศูนย์วิทยทรัพยากร
จุฬาลงกรณ์มหาวิทยาลัย

FB0 1 11 2911 2901 1 100

R(10/29)

E40 4 1(1/100) 2= 102= 101=

R

OG 1 10000 EGR2

OE 1 10000 ECO



ศูนย์วิทยทรัพยากร
จุฬาลงกรณ์มหาวิทยาลัย

Etest.mai file

* ELECTRIC FIELD CALCULATION

* PARALLEL PLATES (DENTED PLATE)

SOL MOME

GSCA 0.001

* NOGO

* PASS GENE

* PASS SOLV

* NONL 0 0 0.0

VOLT 1 0

VOLT 2 300

ECHO OFF

DMEG

END

SOL MAJ

END

SOL FIEL

GSCA 0.001

ECHO OFF

DMEG

END

ศูนย์วิทยทรัพยากร
จุฬาลงกรณ์มหาวิทยาลัย

* ELECTRIC FIELD CALCULATION

* TCB (CONDITION 0, 100, 200, 300 V)

SOL MOME

GSCA 0.001

* NOGO

* PASS GENE

* PASS SOLV

* NONL 0 0 0.0

VOLT 1 0

VOLT 2 100

VOLT 3 200

VOLT 4 300

ECHO OFF

DMEG

END

SOL MAJ

END

SOL FIEL

GSCA 0.001

ECHO OFF

DMEG



Btest.mei file

* INITIAL CONDITION OF PARTICLE

* TCB

R(5)

G30 1(1) 0(0.08) 0 0.0(0.0032)

R

OG 1 20 BGR1

R(5)

G30 1(1) 0 0 1

R

OG 1 20 BGR2

ศูนย์วิทยทรัพยากร
จุฬาลงกรณ์มหาวิทยาลัย

Btest.mai file

* ELECTRIC GUN

* ELF/BEAM

SOL BEAM

FILE ELFIN ETEST

* RELA

VOLT 1 20 1 0.00001

TIME 1 20 1 0.0001

STEP 1 20 1 300

CHAR -3.5E-15

MASS 1.42E-12

RUBA 1.92E-9

STOP 1 20 1 -20 -20 -1 0.5 20 2.0

GSCAL 0.001

ECHO OFF

DMEG

EN

ศูนย์วิทยทรัพยากร
จุฬาลงกรณ์มหาวิทยาลัย

Function in ELFIN/MESH

G30 NP x y z

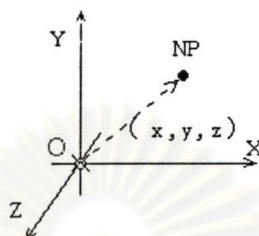

NP: Node ID.x, y, z: Coordinates of the node.

G30 creates a node on the coordinates (x,y,z).

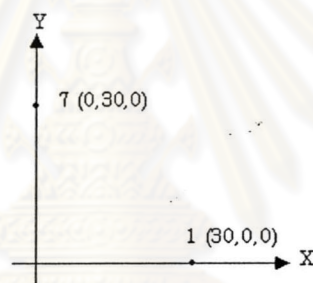

Example

G30 1 30. 0. 0.

G30 7 0. 30. 0.

Node 1 is created on (30, 0, 0).

Node 7 is created on (0, 30, 0).

FL0 N1 N2 N r

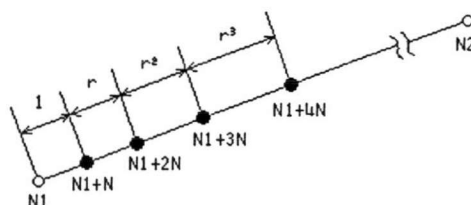

N1, N2: Node ID of the already defined node.

N: Absolute value of increment of Node ID.

r: Ratio of division.

FL0 creates a series of nodes between two already defined nodes (NID=N1,N2).

FL0 can subdivide the line segment N1-N2 in geometric series. The number of created nodes (n) is the maximum integer which satisfies the following inequality.

$$n < \frac{|N2 - N1|}{N}$$

E20 MID N1 N2

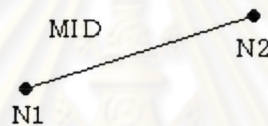

MID: Material ID.

N1,N2: Node ID of the already defined node.

E20 defines a line element for a 3-D model and a surface element for a axisymmetric model.

FB0 N1 N2 N3 N4 N12 N14 r12 r14

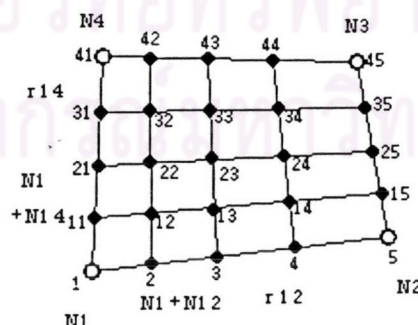

FB0 1 5 45 41 1 10 1.2 1

N1,N2,N3,N4: Node ID of the already defined node.

N12: Increment of Node ID in the direction from node N1 to node N2.

N14: Increment of Node ID in the direction from node N1 to node N4.

r12: Ratio of division in the direction from node N1 to node N2.

r14: Ratio of division in the direction from node N1 to node N4.

FB0 creates a 2-D array of nodes on the quadrangle composed of four already defined nodes (NID=N1,N2,N3,N4).

The node ID of the node on the corner must satisfy the following equations:

$$N2 = N1 + (m-1) * N12,$$

$$N4 = N1 * (n-1) * N14,$$

$$N3 = N1 + (m-1) * N12 + (n-1) * N14.$$

(m: Number of nodes on the line segment N1-N2)

(n: Number of nodes on the line segment N1-N4)

GM0 N1 N2 N x y z

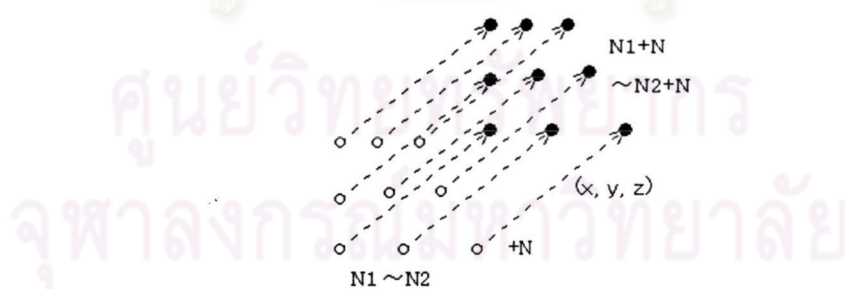

N1: Minimum Node ID.

N2: Maximum Node ID.

N: Increment of Node ID.

x, y, z: Displacement.

GM0 duplicates the already defined nodes (NID=N1~N2).

NID of a newly created node is $N0+N$ ($N0$: NID of the original node).

The quantity (x, y, z) gives the displacement of a created node from an original one.

Example

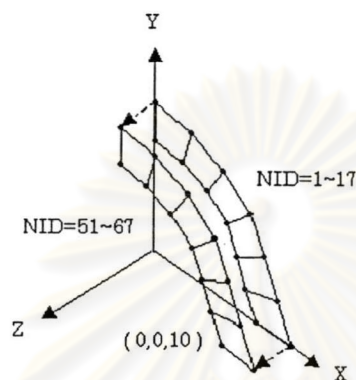

```
GM0 1 17 50 0. 0. 10. X Y Z
```

GM0 duplicates the already defined nodes (NID=1~17).

NID of a newly created node is $N0+50$ ($N0$: NID of the original node).

The displacement is $(0. 0. 10.)$.

R function

R line makes the mode of ELF/MESH either of the following:

R: Non-loop mode,

R(N1): Single-loop mode,

R(N1/N2): Double-loop mode,

R(N1/N2/N3): Triple-loop mode.

ELF/MESH repeatedly executes the data lines following the R line.

Write the iteration counts in the argument of R line.

Write the increment of each parameter in the data lines.

```
OG NS NE MF
```

NS: Minimum Node ID.

NE: Maximum Node ID.

MF: Either "MGR1" or "MGR2" (for ELF/MAGIC).

OG defines the type of nodes and outputs the node data into MEG or MEO.

Only MGR1 or MGR2 is available as the header for a line defining a node.

OG outputs the node data into MEO when you omit MF.

Example 1

OG 1 3000 MGR1

OG outputs the material node data into MEG file with header "MGR1".

BOOK MEP 1.32000000000000

MGR1	1	0	3.00000000000000E+01	0.00000000000000E+00	.00000000000000E+00
MGR1	2	0	2.7071067811865E+01	0.00000000000000E+00	.0710678118655E+00
MGR1	3	0	2.4142135623731E+01	0.00000000000000E+00	.4142135623731E+01
MGR1	4	0	2.1213203435596E+01	0.00000000000000E+00	.1213203435596E+01

CG NS NE

NS: Minimum Node ID.

NE: Maximum Node ID.

CG clears the data concerning the nodes (NID=NS~NE) in memory.

Use CG after making the material nodes, and you can reuse NIDs for space nodes.

OE NS NE NAME

NS: Minimum Element ID.

NE: Maximum Element ID.

NAME: Element name.

OE defines the type of elements and outputs the element data into MEG or MEO.

Specify the first three characters (without the number of nodes) of the element header for NAME.

The number of nodes which belongs to the element is automatically given.

OE outputs the element data into MEO when you omit NAME.

Example

OE 1 3000 MMB

OE outputs the material element data into MEG file with header "MMB?". OE gives each data line the fourth character of the header (the number of nodes which compose the element).

MMB8	11	1	1	11	12	2	51	61	62	52
MMB8	12	1	2	12	13	3	52	62	63	53
MMB8	13	1	3	13	14	4	53	63	64	54
MMB8	14	1	4	14	15	5	54	64	65	55
MMB8	15	1	5	15	16	6	55	65	66	56
MMB8	16	1	6	16	17	7	56	66	67	57

.....

CE NS NE

NS: Minimum Element ID of the element.

NE: Maximum Element ID of the element.

CE clears the data concerning the elements (EID=NS~NE) in memory.

Use CE after making the material elements, and you can reuse EIDs for space elements.

Comment line

The character '*' at the head of line indicates comment line.

ELF/MESH ignores the comment lines.

Nodes

<i>Header</i>	<i>Application</i>
EGR1	Material node
EGR2	Space node

In ELFIN, you can use 2 kinds of nodes, the material node and the space node. These nodes are quite different in the role, and it is necessary to use them properly according to the purpose. That is, you have to use only material nodes in creating material elements, and only space nodes in creating space elements.

EGR1

A material node, or a vertex of a material element with the sources of electric phenomena such as electric moments and surface charges.

Definition in MEG

EGR1 NID GID X Y Z

Remarks

- GID is fixed to 0 at present.
- The vector (X, Y, Z) is the coordinates of the node.
- A material node is not allowed to become a material element alone.
- A material node is able to have the same NID as that of a space node.

EGR2

A space node, or a vertex of a space element on which the electric field is evaluated.

Definition in MEG

EGR2 NID GID X Y Z

Remarks

- GID is fixed to 0 at present.
- The vector (X, Y, Z) is the coordinates of the node.
- A space node is allowed to become a space element alone.
- A space node is able to have the same NID as that of a material node.

ศูนย์วิทยทรัพยากร
จุฬาลงกรณ์มหาวิทยาลัย

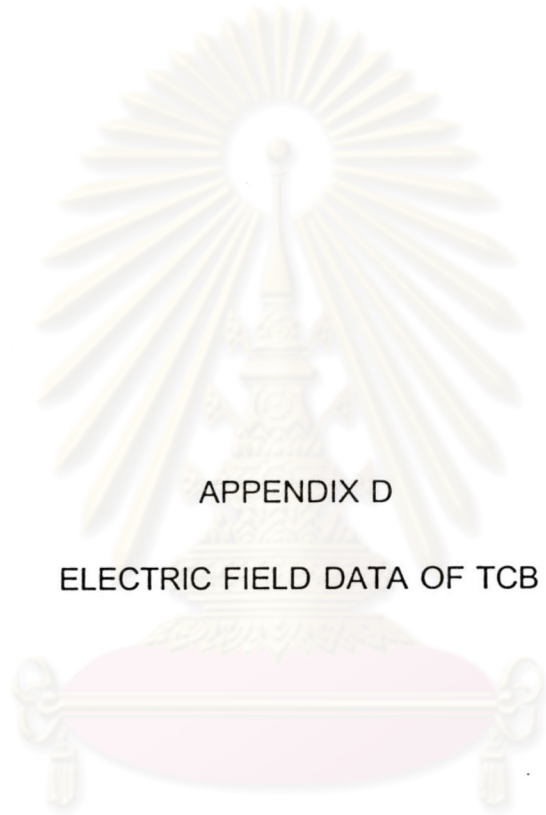

APPENDIX D

ELECTRIC FIELD DATA OF TCB

ศูนย์วิทยทรัพยากร
จุฬาลงกรณ์มหาวิทยาลัย

Electric field data of TCB for condition 0, 100, 200, 300 V

-EX-	-EY-	-EZ-	E(V/M)	PHI-(V)	-X-	-Y-	-Z-
7.25E-09	9.93E-10	5.70E+04	5.70E+04	-6.15E-01	0.00E+00	0.00E+00	0.00E+00
-2.43E+03	3.95E-09	4.13E+03	4.80E+03	-3.53E-01	1.00E-04	0.00E+00	0.00E+00
-2.02E+03	2.82E-09	2.11E+03	2.92E+03	-1.30E-01	2.00E-04	0.00E+00	0.00E+00
-1.47E+03	3.21E-09	8.42E+02	1.69E+03	4.59E-02	3.00E-04	0.00E+00	0.00E+00
-6.72E+02	3.12E-09	-6.94E+01	6.75E+02	1.56E-01	4.00E-04	0.00E+00	0.00E+00
7.97E+02	3.02E-09	-5.13E+02	9.48E+02	1.60E-01	5.00E-04	0.00E+00	0.00E+00
1.01E+03	2.94E-09	2.06E+03	2.29E+03	1.13E-03	6.00E-04	0.00E+00	0.00E+00
-2.41E+02	3.15E-09	1.79E+03	1.81E+03	-2.25E-02	7.00E-04	0.00E+00	0.00E+00
-5.23E+02	2.95E-09	1.31E+03	1.41E+03	1.98E-02	8.00E-04	0.00E+00	0.00E+00
-4.50E+02	2.81E-09	8.82E+02	9.90E+02	7.07E-02	9.00E-04	0.00E+00	0.00E+00
-1.19E+02	3.19E-09	5.88E+02	6.00E+02	1.01E-01	1.00E-03	0.00E+00	0.00E+00
4.40E-10	2.65E-10	-1.37E+05	1.37E+05	8.52E+00	0.00E+00	0.00E+00	6.83E-05
1.77E+03	2.75E-10	-1.38E+05	1.38E+05	8.42E+00	1.00E-04	0.00E+00	6.83E-05
2.65E+03	2.38E-10	-1.39E+05	1.39E+05	8.19E+00	2.00E-04	0.00E+00	6.83E-05
3.38E+03	9.60E-10	-1.40E+05	1.40E+05	7.89E+00	3.00E-04	0.00E+00	6.83E-05
4.27E+03	1.28E-09	-1.41E+05	1.41E+05	7.51E+00	4.00E-04	0.00E+00	6.83E-05
5.64E+03	1.83E-09	-1.43E+05	1.43E+05	7.02E+00	5.00E-04	0.00E+00	6.83E-05
6.06E+03	2.23E-09	-1.46E+05	1.46E+05	6.40E+00	6.00E-04	0.00E+00	6.83E-05
5.23E+03	2.89E-09	-1.47E+05	1.47E+05	5.85E+00	7.00E-04	0.00E+00	6.83E-05
5.05E+03	3.00E-09	-1.48E+05	1.48E+05	5.34E+00	8.00E-04	0.00E+00	6.83E-05
5.19E+03	3.02E-09	-1.48E+05	1.48E+05	4.83E+00	9.00E-04	0.00E+00	6.83E-05
5.61E+03	3.37E-09	-1.49E+05	1.49E+05	4.29E+00	1.00E-03	0.00E+00	6.83E-05
4.62E-10	1.06E-10	-1.39E+05	1.39E+05	1.79E+01	0.00E+00	0.00E+00	1.37E-04
1.10E+03	2.63E-10	-1.39E+05	1.39E+05	1.79E+01	1.00E-04	0.00E+00	1.37E-04
1.92E+03	1.13E-10	-1.40E+05	1.40E+05	1.77E+01	2.00E-04	0.00E+00	1.37E-04
2.64E+03	4.33E-10	-1.41E+05	1.41E+05	1.75E+01	3.00E-04	0.00E+00	1.37E-04
3.43E+03	3.96E-10	-1.42E+05	1.43E+05	1.72E+01	4.00E-04	0.00E+00	1.37E-04
4.30E+03	6.24E-10	-1.44E+05	1.44E+05	1.68E+01	5.00E-04	0.00E+00	1.37E-04
4.68E+03	9.26E-10	-1.46E+05	1.46E+05	1.64E+01	6.00E-04	0.00E+00	1.37E-04
4.55E+03	1.02E-09	-1.47E+05	1.47E+05	1.59E+01	7.00E-04	0.00E+00	1.37E-04
4.57E+03	1.19E-09	-1.48E+05	1.48E+05	1.54E+01	8.00E-04	0.00E+00	1.37E-04
4.79E+03	1.54E-09	-1.49E+05	1.49E+05	1.50E+01	9.00E-04	0.00E+00	1.37E-04
5.18E+03	1.92E-09	-1.50E+05	1.50E+05	1.45E+01	1.00E-03	0.00E+00	1.37E-04
1.88E-10	6.69E-11	-1.40E+05	1.40E+05	2.75E+01	0.00E+00	0.00E+00	2.05E-04
6.87E+02	1.69E-10	-1.41E+05	1.41E+05	2.74E+01	1.00E-04	0.00E+00	2.05E-04

1.29E+03	-5.89E-11	-1.41E+05	1.41E+05	2.73E+01	2.00E-04	0.00E+00	2.05E-04
1.87E+03	2.51E-10	-1.42E+05	1.42E+05	2.72E+01	3.00E-04	0.00E+00	2.05E-04
2.52E+03	3.19E-10	-1.44E+05	1.44E+05	2.70E+01	4.00E-04	0.00E+00	2.05E-04
3.18E+03	5.28E-10	-1.45E+05	1.45E+05	2.67E+01	5.00E-04	0.00E+00	2.05E-04
3.61E+03	3.48E-10	-1.46E+05	1.47E+05	2.63E+01	6.00E-04	0.00E+00	2.05E-04
3.82E+03	6.31E-10	-1.48E+05	1.48E+05	2.60E+01	7.00E-04	0.00E+00	2.05E-04
4.02E+03	6.92E-10	-1.49E+05	1.49E+05	2.56E+01	8.00E-04	0.00E+00	2.05E-04
4.32E+03	7.11E-10	-1.49E+05	1.49E+05	2.52E+01	9.00E-04	0.00E+00	2.05E-04
4.69E+03	1.04E-09	-1.50E+05	1.50E+05	2.47E+01	1.00E-03	0.00E+00	2.05E-04
2.54E-10	1.18E-10	-1.41E+05	1.41E+05	3.71E+01	0.00E+00	0.00E+00	2.73E-04
3.48E+02	1.26E-10	-1.41E+05	1.41E+05	3.71E+01	1.00E-04	0.00E+00	2.73E-04
6.87E+02	1.34E-10	-1.42E+05	1.42E+05	3.70E+01	2.00E-04	0.00E+00	2.73E-04
1.08E+03	2.32E-10	-1.43E+05	1.43E+05	3.69E+01	3.00E-04	0.00E+00	2.73E-04
1.58E+03	-5.23E-11	-1.44E+05	1.44E+05	3.68E+01	4.00E-04	0.00E+00	2.73E-04
2.17E+03	4.13E-10	-1.46E+05	1.46E+05	3.66E+01	5.00E-04	0.00E+00	2.73E-04
2.70E+03	8.13E-11	-1.47E+05	1.47E+05	3.64E+01	6.00E-04	0.00E+00	2.73E-04
3.10E+03	2.54E-10	-1.48E+05	1.48E+05	3.61E+01	7.00E-04	0.00E+00	2.73E-04
3.45E+03	3.73E-10	-1.49E+05	1.49E+05	3.57E+01	8.00E-04	0.00E+00	2.73E-04
3.81E+03	4.30E-10	-1.50E+05	1.50E+05	3.54E+01	9.00E-04	0.00E+00	2.73E-04
4.20E+03	5.83E-10	-1.51E+05	1.51E+05	3.50E+01	1.00E-03	0.00E+00	2.73E-04
9.86E-11	-1.20E-11	-1.41E+05	1.41E+05	4.67E+01	0.00E+00	0.00E+00	3.41E-04
2.36E+01	9.02E-11	-1.41E+05	1.41E+05	4.67E+01	1.00E-04	0.00E+00	3.41E-04
6.14E+01	4.40E-11	-1.42E+05	1.42E+05	4.67E+01	2.00E-04	0.00E+00	3.41E-04
2.04E+02	2.93E-10	-1.43E+05	1.43E+05	4.67E+01	3.00E-04	0.00E+00	3.41E-04
5.81E+02	-6.09E-11	-1.45E+05	1.45E+05	4.67E+01	4.00E-04	0.00E+00	3.41E-04
1.19E+03	4.05E-10	-1.46E+05	1.46E+05	4.66E+01	5.00E-04	0.00E+00	3.41E-04
1.85E+03	-1.12E-11	-1.48E+05	1.48E+05	4.64E+01	6.00E-04	0.00E+00	3.41E-04
2.41E+03	1.55E-10	-1.49E+05	1.49E+05	4.62E+01	7.00E-04	0.00E+00	3.41E-04
2.87E+03	3.22E-10	-1.50E+05	1.50E+05	4.59E+01	8.00E-04	0.00E+00	3.41E-04
3.29E+03	2.79E-10	-1.51E+05	1.51E+05	4.56E+01	9.00E-04	0.00E+00	3.41E-04
3.70E+03	5.35E-10	-1.51E+05	1.51E+05	4.53E+01	1.00E-03	0.00E+00	3.41E-04
2.71E-10	7.26E-11	-1.41E+05	1.41E+05	5.64E+01	0.00E+00	0.00E+00	4.10E-04
-3.01E+02	-4.58E-11	-1.41E+05	1.41E+05	5.64E+01	1.00E-04	0.00E+00	4.10E-04
-6.16E+02	3.07E-11	-1.42E+05	1.42E+05	5.64E+01	2.00E-04	0.00E+00	4.10E-04
-8.14E+02	1.74E-10	-1.43E+05	1.43E+05	5.65E+01	3.00E-04	0.00E+00	4.10E-04
-5.89E+02	2.02E-10	-1.45E+05	1.45E+05	5.66E+01	4.00E-04	0.00E+00	4.10E-04
1.48E+02	2.14E-10	-1.47E+05	1.47E+05	5.66E+01	5.00E-04	0.00E+00	4.10E-04
1.04E+03	2.55E-11	-1.48E+05	1.48E+05	5.65E+01	6.00E-04	0.00E+00	4.10E-04
1.77E+03	7.23E-11	-1.49E+05	1.49E+05	5.64E+01	7.00E-04	0.00E+00	4.10E-04
2.32E+03	1.55E-10	-1.50E+05	1.50E+05	5.62E+01	8.00E-04	0.00E+00	4.10E-04

2.76E+03	2.40E-10	-1.51E+05	1.51E+05	5.59E+01	9.00E-04	0.00E+00	4.10E-04
3.19E+03	3.32E-10	-1.52E+05	1.52E+05	5.56E+01	1.00E-03	0.00E+00	4.10E-04
9.77E-11	-4.16E-11	-1.40E+05	1.40E+05	6.60E+01	0.00E+00	0.00E+00	4.78E-04
-6.03E+02	2.00E-10	-1.41E+05	1.41E+05	6.60E+01	1.00E-04	0.00E+00	4.78E-04
-1.33E+03	-4.66E-11	-1.41E+05	1.41E+05	6.61E+01	2.00E-04	0.00E+00	4.78E-04
-2.07E+03	-1.22E-10	-1.43E+05	1.43E+05	6.63E+01	3.00E-04	0.00E+00	4.78E-04
-2.12E+03	1.18E-10	-1.45E+05	1.45E+05	6.65E+01	4.00E-04	0.00E+00	4.78E-04
-1.04E+03	3.79E-10	-1.48E+05	1.48E+05	6.66E+01	5.00E-04	0.00E+00	4.78E-04
2.59E+02	2.13E-10	-1.49E+05	1.49E+05	6.67E+01	6.00E-04	0.00E+00	4.78E-04
1.18E+03	1.44E-10	-1.50E+05	1.50E+05	6.66E+01	7.00E-04	0.00E+00	4.78E-04
1.79E+03	-3.18E-11	-1.51E+05	1.51E+05	6.65E+01	8.00E-04	0.00E+00	4.78E-04
2.24E+03	8.96E-12	-1.52E+05	1.52E+05	6.63E+01	9.00E-04	0.00E+00	4.78E-04
2.66E+03	9.39E-11	-1.52E+05	1.52E+05	6.60E+01	1.00E-03	0.00E+00	4.78E-04
1.64E-10	4.99E-11	-1.40E+05	1.40E+05	7.55E+01	0.00E+00	0.00E+00	5.46E-04
-8.12E+02	-3.94E-11	-1.40E+05	1.40E+05	7.56E+01	1.00E-04	0.00E+00	5.46E-04
-1.96E+03	-3.95E-11	-1.40E+05	1.40E+05	7.57E+01	2.00E-04	0.00E+00	5.46E-04
-3.66E+03	9.62E-11	-1.41E+05	1.42E+05	7.60E+01	3.00E-04	0.00E+00	5.46E-04
-4.45E+03	-1.06E-11	-1.45E+05	1.45E+05	7.64E+01	4.00E-04	0.00E+00	5.46E-04
-2.42E+03	1.71E-10	-1.49E+05	1.49E+05	7.68E+01	5.00E-04	0.00E+00	5.46E-04
-3.92E+02	-2.57E-10	-1.50E+05	1.50E+05	7.69E+01	6.00E-04	0.00E+00	5.46E-04
7.12E+02	7.28E-11	-1.51E+05	1.51E+05	7.69E+01	7.00E-04	0.00E+00	5.46E-04
1.32E+03	-4.78E-10	-1.51E+05	1.51E+05	7.68E+01	8.00E-04	0.00E+00	5.46E-04
1.73E+03	-2.49E-10	-1.52E+05	1.52E+05	7.66E+01	9.00E-04	0.00E+00	5.46E-04
2.09E+03	-1.35E-10	-1.53E+05	1.53E+05	7.64E+01	1.00E-03	0.00E+00	5.46E-04
2.41E-10	1.34E-10	-1.38E+05	1.38E+05	8.50E+01	0.00E+00	0.00E+00	6.14E-04
-8.13E+02	3.12E-10	-1.38E+05	1.38E+05	8.51E+01	1.00E-04	0.00E+00	6.14E-04
-2.16E+03	-1.22E-10	-1.38E+05	1.38E+05	8.52E+01	2.00E-04	0.00E+00	6.14E-04
-5.29E+03	2.84E-10	-1.38E+05	1.38E+05	8.55E+01	3.00E-04	0.00E+00	6.14E-04
-9.11E+03	-1.78E-10	-1.45E+05	1.45E+05	8.63E+01	4.00E-04	0.00E+00	6.14E-04
-3.74E+03	-5.11E-11	-1.51E+05	1.51E+05	8.70E+01	5.00E-04	0.00E+00	6.14E-04
-6.98E+02	-6.30E-10	-1.51E+05	1.51E+05	8.72E+01	6.00E-04	0.00E+00	6.14E-04
4.11E+02	-5.48E-10	-1.51E+05	1.51E+05	8.72E+01	7.00E-04	0.00E+00	6.14E-04
9.28E+02	-6.91E-10	-1.52E+05	1.52E+05	8.71E+01	8.00E-04	0.00E+00	6.14E-04
1.24E+03	-1.08E-09	-1.52E+05	1.52E+05	8.70E+01	9.00E-04	0.00E+00	6.14E-04
1.49E+03	-6.21E-10	-1.53E+05	1.53E+05	8.69E+01	1.00E-03	0.00E+00	6.14E-04
6.11E-11	7.10E-11	-1.38E+05	1.38E+05	9.44E+01	0.00E+00	0.00E+00	6.83E-04
-5.34E+02	4.31E-10	-1.37E+05	1.37E+05	9.45E+01	1.00E-04	0.00E+00	6.83E-04
-1.46E+03	-1.05E-11	-1.36E+05	1.36E+05	9.46E+01	2.00E-04	0.00E+00	6.83E-04
-4.45E+03	6.25E-11	-1.33E+05	1.33E+05	9.48E+01	3.00E-04	0.00E+00	6.83E-04
-3.05E+04	-1.18E-09	-1.44E+05	1.47E+05	9.62E+01	4.00E-04	0.00E+00	6.83E-04

-2.97E+03	-1.32E-09	-1.54E+05	1.54E+05	9.74E+01	5.00E-04	0.00E+00	6.83E-04
-3.87E+02	-1.37E-09	-1.52E+05	1.52E+05	9.75E+01	6.00E-04	0.00E+00	6.83E-04
3.05E+02	-1.02E-09	-1.52E+05	1.52E+05	9.75E+01	7.00E-04	0.00E+00	6.83E-04
6.04E+02	-1.23E-09	-1.52E+05	1.52E+05	9.75E+01	8.00E-04	0.00E+00	6.83E-04
7.60E+02	-1.12E-09	-1.52E+05	1.52E+05	9.74E+01	9.00E-04	0.00E+00	6.83E-04
-2.07E+03	-1.22E-10	-1.43E+05	1.43E+05	6.63E+01	3.00E-04	0.00E+00	4.78E-04
-2.12E+03	1.18E-10	-1.45E+05	1.45E+05	6.65E+01	4.00E-04	0.00E+00	4.78E-04
-1.04E+03	3.79E-10	-1.48E+05	1.48E+05	6.66E+01	5.00E-04	0.00E+00	4.78E-04
2.59E+02	2.13E-10	-1.49E+05	1.49E+05	6.67E+01	6.00E-04	0.00E+00	4.78E-04
1.18E+03	1.44E-10	-1.50E+05	1.50E+05	6.66E+01	7.00E-04	0.00E+00	4.78E-04
1.79E+03	-3.18E-11	-1.51E+05	1.51E+05	6.65E+01	8.00E-04	0.00E+00	4.78E-04
2.24E+03	8.96E-12	-1.52E+05	1.52E+05	6.63E+01	9.00E-04	0.00E+00	4.78E-04
2.66E+03	9.39E-11	-1.52E+05	1.52E+05	6.60E+01	1.00E-03	0.00E+00	4.78E-04
1.64E-10	4.99E-11	-1.40E+05	1.40E+05	7.55E+01	0.00E+00	0.00E+00	5.46E-04
-8.12E+02	-3.94E-11	-1.40E+05	1.40E+05	7.56E+01	1.00E-04	0.00E+00	5.46E-04
8.61E+02	-6.64E-10	-1.53E+05	1.53E+05	9.73E+01	1.00E-03	0.00E+00	6.83E-04
-4.63E-11	4.65E-11	-1.37E+05	1.37E+05	1.04E+02	0.00E+00	0.00E+00	7.51E-04
-6.68E+01	3.99E-10	-1.37E+05	1.37E+05	1.04E+02	1.00E-04	0.00E+00	7.51E-04
-1.44E+01	-2.21E-10	-1.36E+05	1.36E+05	1.04E+02	2.00E-04	0.00E+00	7.51E-04
1.22E+03	2.51E-10	-1.31E+05	1.31E+05	1.04E+02	3.00E-04	0.00E+00	7.51E-04
3.32E+04	1.55E-09	-1.38E+05	1.42E+05	1.03E+02	4.00E-04	0.00E+00	7.51E-04
1.53E+03	1.88E-09	-1.47E+05	1.47E+05	1.02E+02	5.00E-04	0.00E+00	7.51E-04
3.82E+02	1.40E-09	-1.44E+05	1.44E+05	1.02E+02	6.00E-04	0.00E+00	7.51E-04
3.27E+02	1.03E-09	-1.44E+05	1.44E+05	1.02E+02	7.00E-04	0.00E+00	7.51E-04
3.33E+02	5.10E-10	-1.44E+05	1.44E+05	1.02E+02	8.00E-04	0.00E+00	7.51E-04
3.05E+02	6.46E-10	-1.45E+05	1.45E+05	1.02E+02	9.00E-04	0.00E+00	7.51E-04
2.35E+02	6.83E-10	-1.45E+05	1.45E+05	1.02E+02	1.00E-03	0.00E+00	7.51E-04
-4.03E-11	-1.15E-10	-1.37E+05	1.37E+05	1.13E+02	0.00E+00	0.00E+00	8.19E-04
3.59E+02	3.63E-10	-1.37E+05	1.37E+05	1.13E+02	1.00E-04	0.00E+00	8.19E-04
1.12E+03	1.08E-10	-1.36E+05	1.36E+05	1.13E+02	2.00E-04	0.00E+00	8.19E-04
3.55E+03	5.43E-10	-1.35E+05	1.35E+05	1.13E+02	3.00E-04	0.00E+00	8.19E-04
7.78E+03	2.46E-10	-1.40E+05	1.40E+05	1.12E+02	4.00E-04	0.00E+00	8.19E-04
3.13E+03	6.83E-10	-1.44E+05	1.44E+05	1.12E+02	5.00E-04	0.00E+00	8.19E-04
9.40E+02	6.71E-10	-1.44E+05	1.44E+05	1.12E+02	6.00E-04	0.00E+00	8.19E-04
3.43E+02	5.78E-10	-1.44E+05	1.44E+05	1.11E+02	7.00E-04	0.00E+00	8.19E-04
8.28E+01	9.42E-10	-1.44E+05	1.44E+05	1.11E+02	8.00E-04	0.00E+00	8.19E-04
-1.25E+02	6.94E-10	-1.44E+05	1.44E+05	1.11E+02	9.00E-04	0.00E+00	8.19E-04
-3.65E+02	6.78E-10	-1.45E+05	1.45E+05	1.12E+02	1.00E-03	0.00E+00	8.19E-04
-6.85E-11	1.67E-11	-1.38E+05	1.38E+05	1.23E+02	0.00E+00	0.00E+00	8.88E-04
5.95E+02	2.17E-10	-1.38E+05	1.38E+05	1.23E+02	1.00E-04	0.00E+00	8.88E-04

1.49E+03	-1.24E-10	-1.38E+05	1.38E+05	1.22E+02	2.00E-04	0.00E+00	8.88E-04
3.02E+03	2.28E-10	-1.38E+05	1.38E+05	1.22E+02	3.00E-04	0.00E+00	8.88E-04
4.05E+03	2.54E-11	-1.40E+05	1.41E+05	1.22E+02	4.00E-04	0.00E+00	8.88E-04
2.52E+03	3.86E-10	-1.43E+05	1.43E+05	1.22E+02	5.00E-04	0.00E+00	8.88E-04
1.01E+03	1.13E-10	-1.43E+05	1.43E+05	1.21E+02	6.00E-04	0.00E+00	8.88E-04
2.65E+02	2.76E-10	-1.43E+05	1.43E+05	1.21E+02	7.00E-04	0.00E+00	8.88E-04
-1.71E+02	1.29E-10	-1.44E+05	1.44E+05	1.21E+02	8.00E-04	0.00E+00	8.88E-04
-5.30E+02	6.04E-10	-1.44E+05	1.44E+05	1.21E+02	9.00E-04	0.00E+00	8.88E-04
-9.16E+02	7.13E-10	-1.45E+05	1.45E+05	1.21E+02	1.00E-03	0.00E+00	8.88E-04
4.37E-11	7.78E-11	-1.39E+05	1.39E+05	1.32E+02	0.00E+00	0.00E+00	9.56E-04
6.61E+02	3.17E-10	-1.39E+05	1.39E+05	1.32E+02	1.00E-04	0.00E+00	9.56E-04
1.43E+03	1.62E-10	-1.39E+05	1.39E+05	1.32E+02	2.00E-04	0.00E+00	9.56E-04
2.24E+03	2.17E-10	-1.39E+05	1.39E+05	1.32E+02	3.00E-04	0.00E+00	9.56E-04
2.52E+03	1.20E-10	-1.41E+05	1.41E+05	1.31E+02	4.00E-04	0.00E+00	9.56E-04
1.78E+03	4.51E-10	-1.42E+05	1.42E+05	1.31E+02	5.00E-04	0.00E+00	9.56E-04
8.06E+02	-2.28E-10	-1.43E+05	1.43E+05	1.31E+02	6.00E-04	0.00E+00	9.56E-04
9.44E+01	4.49E-10	-1.43E+05	1.43E+05	1.31E+02	7.00E-04	0.00E+00	9.56E-04
-4.34E+02	1.45E-10	-1.43E+05	1.43E+05	1.31E+02	8.00E-04	0.00E+00	9.56E-04
-9.05E+02	-2.81E-10	-1.44E+05	1.44E+05	1.31E+02	9.00E-04	0.00E+00	9.56E-04
-1.41E+03	2.28E-10	-1.44E+05	1.44E+05	1.31E+02	1.00E-03	0.00E+00	9.56E-04
7.54E-11	-9.89E-11	-1.40E+05	1.40E+05	1.42E+02	0.00E+00	0.00E+00	1.02E-03
6.57E+02	5.16E-10	-1.40E+05	1.40E+05	1.42E+02	1.00E-04	0.00E+00	1.02E-03
1.27E+03	-3.22E-11	-1.40E+05	1.40E+05	1.41E+02	2.00E-04	0.00E+00	1.02E-03
1.70E+03	1.52E-10	-1.40E+05	1.40E+05	1.41E+02	3.00E-04	0.00E+00	1.02E-03
1.22E+03	5.21E-10	-1.42E+05	1.42E+05	1.41E+02	5.00E-04	0.00E+00	1.02E-03
5.24E+02	1.20E-10	-1.42E+05	1.42E+05	1.41E+02	6.00E-04	0.00E+00	1.02E-03
-1.21E+02	3.24E-10	-1.43E+05	1.43E+05	1.41E+02	7.00E-04	0.00E+00	1.02E-03
-6.95E+02	7.41E-10	-1.43E+05	1.43E+05	1.41E+02	8.00E-04	0.00E+00	1.02E-03
-1.25E+03	1.47E-10	-1.43E+05	1.43E+05	1.41E+02	9.00E-04	0.00E+00	1.02E-03
-1.83E+03	1.36E-10	-1.44E+05	1.44E+05	1.41E+02	1.00E-03	0.00E+00	1.02E-03
2.27E-11	3.64E-10	-1.41E+05	1.41E+05	1.51E+02	0.00E+00	0.00E+00	1.09E-03
6.75E+02	4.88E-10	-1.41E+05	1.41E+05	1.51E+02	1.00E-04	0.00E+00	1.09E-03
1.19E+03	5.94E-11	-1.41E+05	1.41E+05	1.51E+02	2.00E-04	0.00E+00	1.09E-03
1.41E+03	9.04E-10	-1.41E+05	1.41E+05	1.51E+02	3.00E-04	0.00E+00	1.09E-03
1.26E+03	3.45E-10	-1.41E+05	1.41E+05	1.51E+02	4.00E-04	0.00E+00	1.09E-03
8.26E+02	1.91E-10	-1.42E+05	1.42E+05	1.51E+02	5.00E-04	0.00E+00	1.09E-03
2.64E+02	6.71E-10	-1.42E+05	1.42E+05	1.51E+02	6.00E-04	0.00E+00	1.09E-03
-3.34E+02	1.54E-10	-1.42E+05	1.42E+05	1.51E+02	7.00E-04	0.00E+00	1.09E-03
-9.40E+02	9.63E-11	-1.43E+05	1.43E+05	1.51E+02	8.00E-04	0.00E+00	1.09E-03
-1.56E+03	-2.42E-10	-1.43E+05	1.43E+05	1.51E+02	9.00E-04	0.00E+00	1.09E-03

-2.20E+03	3.93E-10	-1.43E+05	1.43E+05	1.51E+02	1.00E-03	0.00E+00	1.09E-03
-5.71E-11	1.91E-10	-1.42E+05	1.42E+05	1.61E+02	0.00E+00	0.00E+00	1.16E-03
7.91E+02	5.39E-10	-1.42E+05	1.42E+05	1.61E+02	1.00E-04	0.00E+00	1.16E-03
1.32E+03	3.19E-11	-1.41E+05	1.41E+05	1.61E+02	2.00E-04	0.00E+00	1.16E-03
1.37E+03	2.73E-10	-1.41E+05	1.41E+05	1.60E+02	3.00E-04	0.00E+00	1.16E-03
1.01E+03	2.28E-10	-1.41E+05	1.41E+05	1.60E+02	4.00E-04	0.00E+00	1.16E-03
5.55E+02	-9.99E-11	-1.41E+05	1.41E+05	1.60E+02	5.00E-04	0.00E+00	1.16E-03
6.78E+01	2.90E-11	-1.42E+05	1.42E+05	1.60E+02	6.00E-04	0.00E+00	1.16E-03
-5.07E+02	3.02E-11	-1.42E+05	1.42E+05	1.60E+02	7.00E-04	0.00E+00	1.16E-03
-1.15E+03	4.58E-10	-1.42E+05	1.42E+05	1.60E+02	8.00E-04	0.00E+00	1.16E-03
-1.83E+03	-2.83E-10	-1.42E+05	1.42E+05	1.60E+02	9.00E-04	0.00E+00	1.16E-03
-2.52E+03	-7.70E-11	-1.43E+05	1.43E+05	1.61E+02	1.00E-03	0.00E+00	1.16E-03
-2.74E-11	4.22E-10	-1.43E+05	1.43E+05	1.70E+02	0.00E+00	0.00E+00	1.23E-03
1.07E+03	6.31E-10	-1.43E+05	1.43E+05	1.70E+02	1.00E-04	0.00E+00	1.23E-03
1.76E+03	6.70E-11	-1.42E+05	1.42E+05	1.70E+02	2.00E-04	0.00E+00	1.23E-03
1.65E+03	5.15E-10	-1.41E+05	1.41E+05	1.70E+02	3.00E-04	0.00E+00	1.23E-03
8.76E+02	4.76E-10	-1.41E+05	1.41E+05	1.70E+02	4.00E-04	0.00E+00	1.23E-03
3.45E+02	6.80E-10	-1.41E+05	1.41E+05	1.70E+02	5.00E-04	0.00E+00	1.23E-03
-3.90E+01	2.06E-11	-1.41E+05	1.41E+05	1.70E+02	6.00E-04	0.00E+00	1.23E-03
-6.12E+02	3.97E-10	-1.41E+05	1.41E+05	1.70E+02	7.00E-04	0.00E+00	1.23E-03
-1.32E+03	-1.19E-10	-1.41E+05	1.41E+05	1.70E+02	8.00E-04	0.00E+00	1.23E-03
-2.07E+03	2.87E-12	-1.42E+05	1.42E+05	1.70E+02	9.00E-04	0.00E+00	1.23E-03
-2.81E+03	4.76E-10	-1.42E+05	1.42E+05	1.70E+02	1.00E-03	0.00E+00	1.23E-03
-3.14E-10	2.28E-10	-1.45E+05	1.45E+05	1.80E+02	0.00E+00	0.00E+00	1.30E-03
1.58E+03	4.21E-10	-1.44E+05	1.44E+05	1.80E+02	1.00E-04	0.00E+00	1.30E-03
2.73E+03	7.30E-10	-1.43E+05	1.43E+05	1.80E+02	2.00E-04	0.00E+00	1.30E-03
2.51E+03	6.35E-10	-1.41E+05	1.41E+05	1.80E+02	3.00E-04	0.00E+00	1.30E-03
6.20E+02	3.62E-10	-1.40E+05	1.40E+05	1.80E+02	4.00E-04	0.00E+00	1.30E-03
1.16E+02	4.08E-10	-1.41E+05	1.41E+05	1.80E+02	5.00E-04	0.00E+00	1.30E-03
3.71E+00	-2.82E-10	-1.41E+05	1.41E+05	1.80E+02	6.00E-04	0.00E+00	1.30E-03
-6.16E+02	3.20E-10	-1.41E+05	1.41E+05	1.80E+02	7.00E-04	0.00E+00	1.30E-03
-1.44E+03	-8.70E-10	-1.41E+05	1.41E+05	1.80E+02	8.00E-04	0.00E+00	1.30E-03
-2.28E+03	1.79E-10	-1.41E+05	1.41E+05	1.80E+02	9.00E-04	0.00E+00	1.30E-03
-3.10E+03	-9.58E-11	-1.41E+05	1.41E+05	1.80E+02	1.00E-03	0.00E+00	1.30E-03
-5.20E-11	5.42E-10	-1.48E+05	1.48E+05	1.90E+02	0.00E+00	0.00E+00	1.37E-03
2.30E+03	3.54E-10	-1.47E+05	1.47E+05	1.90E+02	1.00E-04	0.00E+00	1.37E-03
4.44E+03	1.11E-10	-1.45E+05	1.45E+05	1.90E+02	2.00E-04	0.00E+00	1.37E-03
4.97E+03	2.26E-10	-1.40E+05	1.41E+05	1.89E+02	3.00E-04	0.00E+00	1.37E-03
-9.12E+02	3.70E-10	-1.38E+05	1.38E+05	1.89E+02	4.00E-04	0.00E+00	1.37E-03
-3.06E+01	4.57E-10	-1.42E+05	1.42E+05	1.89E+02	5.00E-04	0.00E+00	1.37E-03

3.48E+02	-2.28E-10	-1.41E+05	1.41E+05	1.89E+02	6.00E-04	0.00E+00	1.37E-03
-4.96E+02	-6.48E-11	-1.40E+05	1.40E+05	1.89E+02	7.00E-04	0.00E+00	1.37E-03
-1.51E+03	-4.14E-10	-1.40E+05	1.40E+05	1.89E+02	8.00E-04	0.00E+00	1.37E-03
-2.49E+03	-1.19E-09	-1.40E+05	1.40E+05	1.89E+02	9.00E-04	0.00E+00	1.37E-03
-3.40E+03	-2.35E-10	-1.41E+05	1.41E+05	1.90E+02	1.00E-03	0.00E+00	1.37E-03
-1.41E-10	3.15E-11	-1.51E+05	1.51E+05	2.00E+02	0.00E+00	0.00E+00	1.43E-03
3.07E+03	3.36E-10	-1.51E+05	1.51E+05	2.00E+02	1.00E-04	0.00E+00	1.43E-03
6.66E+03	5.76E-10	-1.49E+05	1.49E+05	2.00E+02	2.00E-04	0.00E+00	1.43E-03
1.15E+04	5.36E-10	-1.43E+05	1.43E+05	1.99E+02	3.00E-04	0.00E+00	1.43E-03
-3.00E+04	-1.40E-10	-1.19E+05	1.23E+05	1.98E+02	4.00E-04	0.00E+00	1.43E-03
1.82E+03	-8.05E-10	-1.43E+05	1.43E+05	1.99E+02	5.00E-04	0.00E+00	1.43E-03
1.16E+03	-5.12E-10	-1.40E+05	1.40E+05	1.99E+02	6.00E-04	0.00E+00	1.43E-03
-2.71E+02	-8.18E-12	-1.39E+05	1.39E+05	1.99E+02	7.00E-04	0.00E+00	1.43E-03
-1.55E+03	-1.22E-09	-1.39E+05	1.39E+05	1.99E+02	8.00E-04	0.00E+00	1.43E-03
-2.68E+03	-1.05E-10	-1.39E+05	1.39E+05	1.99E+02	9.00E-04	0.00E+00	1.43E-03
-3.72E+03	3.33E-10	-1.40E+05	1.40E+05	1.99E+02	1.00E-03	0.00E+00	1.43E-03
-1.09E-10	2.73E-10	-1.56E+05	1.56E+05	2.11E+02	0.00E+00	0.00E+00	1.50E-03
3.54E+03	1.23E-10	-1.55E+05	1.55E+05	2.11E+02	1.00E-04	0.00E+00	1.50E-03
8.10E+03	1.05E-10	-1.55E+05	1.55E+05	2.10E+02	2.00E-04	0.00E+00	1.50E-03
1.70E+04	7.46E-10	-1.54E+05	1.55E+05	2.09E+02	3.00E-04	0.00E+00	1.50E-03
4.26E+04	2.83E-09	-1.83E+05	1.88E+05	2.06E+02	4.00E-04	0.00E+00	1.50E-03
6.92E+03	4.03E-09	-1.91E+05	1.91E+05	2.04E+02	5.00E-04	0.00E+00	1.50E-03
2.15E+03	2.88E-09	-1.88E+05	1.88E+05	2.04E+02	6.00E-04	0.00E+00	1.50E-03
-4.97E+01	2.30E-09	-1.88E+05	1.88E+05	2.04E+02	7.00E-04	0.00E+00	1.50E-03
-1.60E+03	5.55E-10	-1.88E+05	1.88E+05	2.04E+02	8.00E-04	0.00E+00	1.50E-03
-2.88E+03	6.91E-10	-1.88E+05	1.88E+05	2.04E+02	9.00E-04	0.00E+00	1.50E-03
-4.05E+03	2.00E-09	-1.88E+05	1.88E+05	2.04E+02	1.00E-03	0.00E+00	1.50E-03
-1.13E-10	1.37E-10	-1.60E+05	1.60E+05	2.22E+02	0.00E+00	0.00E+00	1.57E-03
3.49E+03	1.17E-09	-1.60E+05	1.61E+05	2.22E+02	1.00E-04	0.00E+00	1.57E-03
7.76E+03	-4.28E-10	-1.61E+05	1.62E+05	2.21E+02	2.00E-04	0.00E+00	1.57E-03
1.39E+04	1.02E-09	-1.65E+05	1.66E+05	2.20E+02	3.00E-04	0.00E+00	1.57E-03
1.70E+04	1.38E-09	-1.78E+05	1.79E+05	2.18E+02	4.00E-04	0.00E+00	1.57E-03
7.75E+03	1.03E-09	-1.86E+05	1.86E+05	2.17E+02	5.00E-04	0.00E+00	1.57E-03
2.58E+03	1.64E-09	-1.86E+05	1.86E+05	2.17E+02	6.00E-04	0.00E+00	1.57E-03
2.16E+01	1.52E-09	-1.86E+05	1.86E+05	2.16E+02	7.00E-04	0.00E+00	1.57E-03
-1.69E+03	1.17E-09	-1.86E+05	1.86E+05	2.17E+02	8.00E-04	0.00E+00	1.57E-03
-3.08E+03	3.61E-10	-1.87E+05	1.87E+05	2.17E+02	9.00E-04	0.00E+00	1.57E-03
-4.37E+03	1.43E-09	-1.87E+05	1.87E+05	2.17E+02	1.00E-03	0.00E+00	1.57E-03
-1.49E-10	5.70E-10	-1.65E+05	1.65E+05	2.33E+02	0.00E+00	0.00E+00	1.64E-03
3.01E+03	3.83E-10	-1.65E+05	1.65E+05	2.33E+02	1.00E-04	0.00E+00	1.64E-03

6.27E+03	-4.04E-10	-1.67E+05	1.67E+05	2.32E+02	2.00E-04	0.00E+00	1.64E-03
9.46E+03	-8.35E-10	-1.71E+05	1.71E+05	2.31E+02	3.00E-04	0.00E+00	1.64E-03
9.81E+03	9.73E-10	-1.78E+05	1.78E+05	2.30E+02	4.00E-04	0.00E+00	1.64E-03
5.92E+03	1.18E-09	-1.83E+05	1.83E+05	2.30E+02	5.00E-04	0.00E+00	1.64E-03
2.26E+03	2.83E-10	-1.84E+05	1.84E+05	2.29E+02	6.00E-04	0.00E+00	1.64E-03
-1.20E+02	1.33E-09	-1.85E+05	1.85E+05	2.29E+02	7.00E-04	0.00E+00	1.64E-03
-1.84E+03	-1.25E-10	-1.85E+05	1.85E+05	2.29E+02	8.00E-04	0.00E+00	1.64E-03
-3.28E+03	-1.15E-10	-1.85E+05	1.85E+05	2.29E+02	9.00E-04	0.00E+00	1.64E-03
-4.64E+03	8.40E-10	-1.86E+05	1.86E+05	2.30E+02	1.00E-03	0.00E+00	1.64E-03
-8.67E-10	3.27E-10	-1.68E+05	1.68E+05	2.44E+02	0.00E+00	0.00E+00	1.71E-03
2.34E+03	1.10E-09	-1.69E+05	1.69E+05	2.44E+02	1.00E-04	0.00E+00	1.71E-03
4.59E+03	-1.85E-10	-1.70E+05	1.70E+05	2.44E+02	2.00E-04	0.00E+00	1.71E-03
6.23E+03	2.42E-09	-1.73E+05	1.74E+05	2.43E+02	3.00E-04	0.00E+00	1.71E-03
6.10E+03	2.60E-09	-1.78E+05	1.78E+05	2.43E+02	4.00E-04	0.00E+00	1.71E-03
4.02E+03	1.55E-09	-1.81E+05	1.81E+05	2.42E+02	5.00E-04	0.00E+00	1.71E-03
1.57E+03	6.23E-10	-1.83E+05	1.83E+05	2.42E+02	6.00E-04	0.00E+00	1.71E-03
-4.26E+02	1.99E-09	-1.84E+05	1.84E+05	2.42E+02	7.00E-04	0.00E+00	1.71E-03
-2.03E+03	-2.42E-09	-1.84E+05	1.84E+05	2.42E+02	8.00E-04	0.00E+00	1.71E-03
-3.45E+03	-1.93E-09	-1.84E+05	1.84E+05	2.42E+02	9.00E-04	0.00E+00	1.71E-03
-4.83E+03	3.92E-09	-1.84E+05	1.85E+05	2.43E+02	1.00E-03	0.00E+00	1.71E-03
-1.70E-10	2.74E-10	-1.71E+05	1.71E+05	2.56E+02	0.00E+00	0.00E+00	1.78E-03
1.69E+03	1.85E-09	-1.71E+05	1.71E+05	2.56E+02	1.00E-04	0.00E+00	1.78E-03
3.17E+03	-7.82E-10	-1.73E+05	1.73E+05	2.55E+02	2.00E-04	0.00E+00	1.78E-03
4.05E+03	4.48E-09	-1.75E+05	1.75E+05	2.55E+02	3.00E-04	0.00E+00	1.78E-03
3.82E+03	1.49E-09	-1.78E+05	1.78E+05	2.55E+02	4.00E-04	0.00E+00	1.78E-03
2.52E+03	2.48E-09	-1.80E+05	1.80E+05	2.54E+02	5.00E-04	0.00E+00	1.78E-03
8.19E+02	7.85E-10	-1.82E+05	1.82E+05	2.54E+02	6.00E-04	0.00E+00	1.78E-03
-8.02E+02	2.33E-09	-1.82E+05	1.82E+05	2.54E+02	7.00E-04	0.00E+00	1.78E-03
-2.25E+03	4.00E-09	-1.83E+05	1.83E+05	2.54E+02	8.00E-04	0.00E+00	1.78E-03
-3.59E+03	3.96E-09	-1.83E+05	1.83E+05	2.55E+02	9.00E-04	0.00E+00	1.78E-03
-4.93E+03	2.61E-09	-1.83E+05	1.83E+05	2.55E+02	1.00E-03	0.00E+00	1.78E-03
-1.55E-10	5.37E-10	-1.73E+05	1.73E+05	2.68E+02	0.00E+00	0.00E+00	1.84E-03
1.15E+03	4.76E-09	-1.73E+05	1.73E+05	2.67E+02	1.00E-04	0.00E+00	1.84E-03
2.10E+03	-6.99E-10	-1.74E+05	1.74E+05	2.67E+02	2.00E-04	0.00E+00	1.84E-03
2.56E+03	5.46E-09	-1.76E+05	1.76E+05	2.67E+02	3.00E-04	0.00E+00	1.84E-03
2.31E+03	5.51E-09	-1.78E+05	1.78E+05	2.67E+02	4.00E-04	0.00E+00	1.84E-03
1.40E+03	5.28E-09	-1.79E+05	1.79E+05	2.67E+02	5.00E-04	0.00E+00	1.84E-03
1.43E+02	4.33E-09	-1.81E+05	1.81E+05	2.67E+02	6.00E-04	0.00E+00	1.84E-03
-1.17E+03	3.58E-09	-1.81E+05	1.81E+05	2.67E+02	7.00E-04	0.00E+00	1.84E-03
-2.45E+03	6.78E-09	-1.82E+05	1.82E+05	2.67E+02	8.00E-04	0.00E+00	1.84E-03



APPENDIX E

THE EXPERIMENTAL RESULTS

ศูนย์วิทยทรัพยากร
จุฬาลงกรณ์มหาวิทยาลัย

The experimental results: aperture diameter of 0.5 mm, $V_4-V_3=200$ V

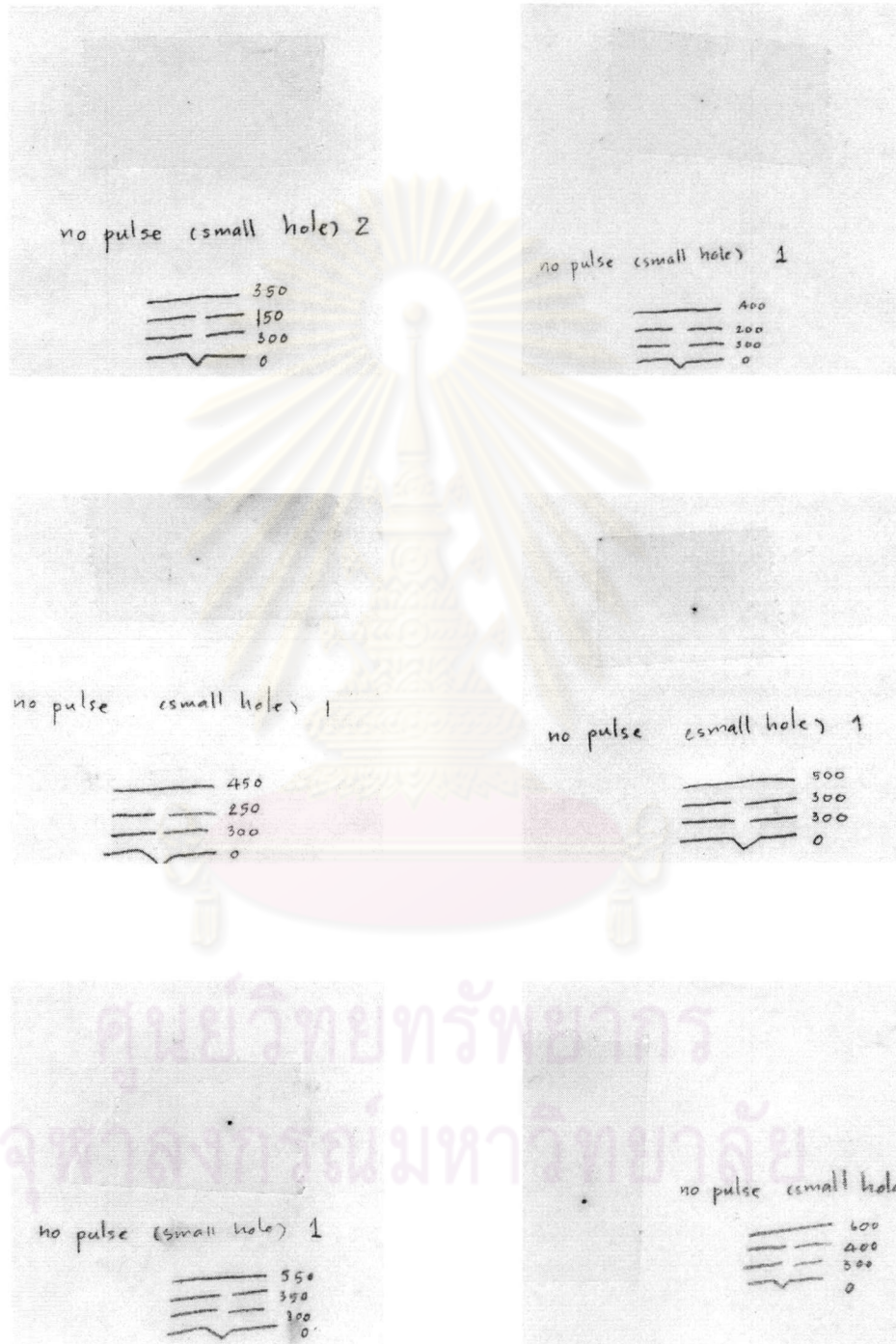

The experimental results: aperture diameter of 0.8 mm, V4-V3=200 V

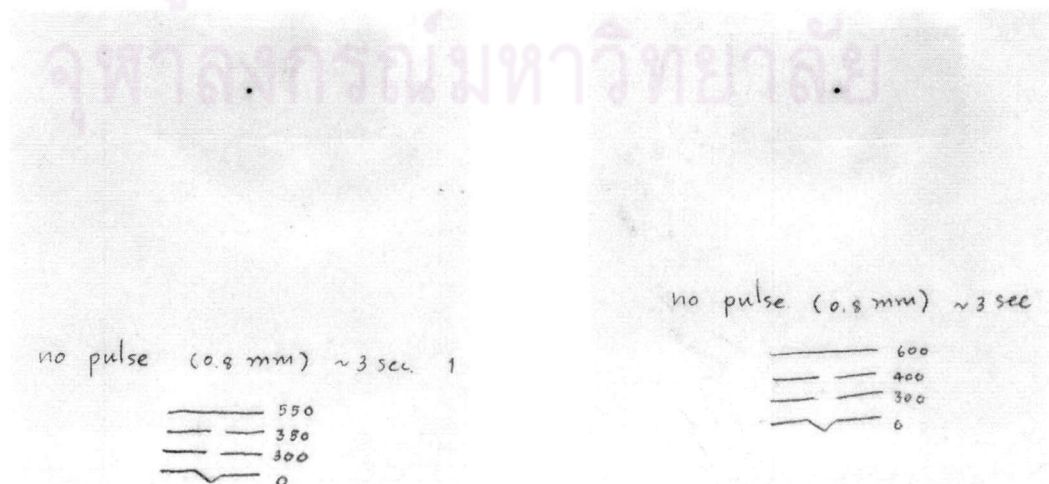
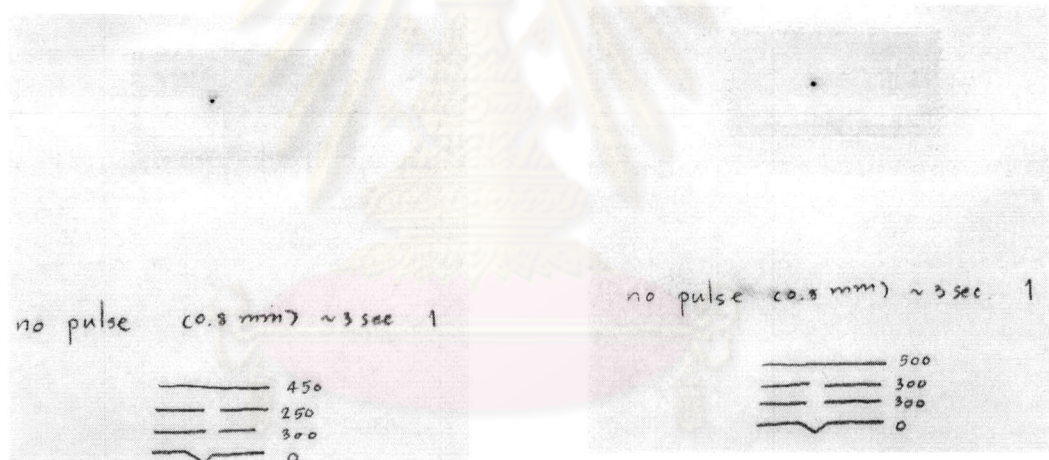
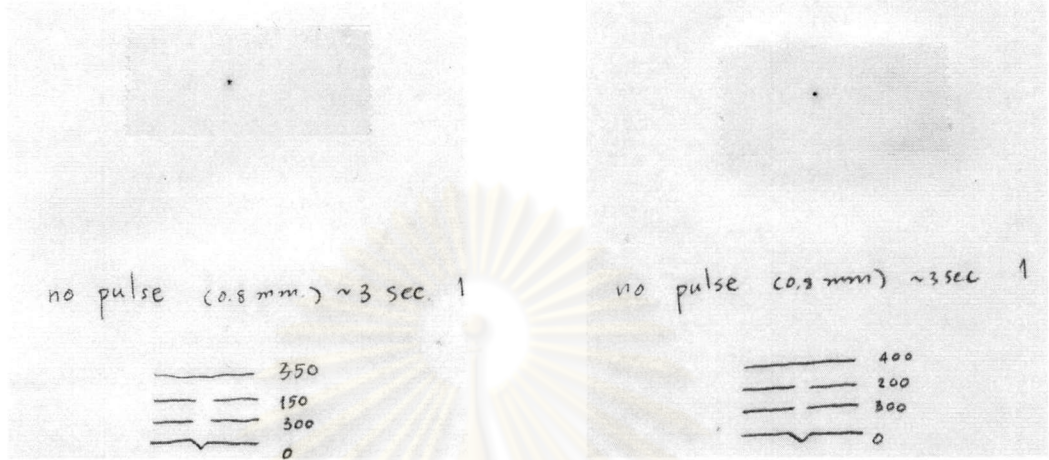

ศูนย์วิทยทรัพยากร

จุฬาลงกรณ์มหาวิทยาลัย

VITA

Miss Nuanwan Tanyong was born on September 20, 1977 in Rayong province, Thailand. She became a Physics course student at Chulalongkorn University in 1995 and received her Bachelor's Degree of Science in 1998. The title of senior project is "Simulation of diffusion of cosmic rays particles" She has been a master course student in Imaging Technology at Photographic Science and Printing Technology Department, Faculty of Science, Chulalongkorn University since 2000.



ศูนย์วิทยทรัพยากร
จุฬาลงกรณ์มหาวิทยาลัย