

## CHAPTER II

### SEISMIC WAVE AND REFLECTION



The seismic wave is defined by Dobrin (1976) as the basic measuring used in seismic prospecting. They are generally referred to as elastic waves because they cause deformation of the material in which they propagate like that in an elastic band when it is stretched. The deformation and dilatations as the particles in the material move closer together and farther apart in response to forces associated with the traveling waves.

#### Seismic Sources and Receivers for Shallow Reflection

Seismic sources to be used in shallow seismic reflection survey shall produce a fairly short signal signature and also have an energy output that is in accordance with the target structure depth. The example of these seismic sources are ignition caps, small caliber blank, small weight drops, 8-14 pounds sledge hammer, small dynamite charge etc.

Since the objective is to detect the structure in detail, high frequency data is needed to be collected. Hence, the used of high frequency geophones with a natural frequency of about 100 Hertz is necessarily. It is also noted that the useful frequency range of any

geophone is limited by internal resonance to about 10-15 times the natural frequency. Above this frequency the received signals will be distorted by the resonances (Pullen, 1986).

### Seismic Resolution

When a series of interfaces separating individual formations having different velocities and the distances between the interfaces are large compared with the seismic wavelengths employed, a separate reflection should theoretically be observed from each interface. However, the basic seismic signal traveling through the earth is a pulse with a breadth that increases with distance traveled. Figure 2-1, modified after Widness (1973) shows that the reflective signals from a high speed bed of finite thickness underlain and overlain by very thick section of lower speed material can not be resolved into two elements when the thickness of bed is about three-eighths of a wavelength or less. The relationship between the resolution and pulse length of seismic source is a linear one and depends on the velocity of wave within the transmitting medium and is non-linear with a source frequency (Ringis, 1986). Therefore, in order to achieve a high resolution, it is necessary to use seismic source which produce short pulse length.

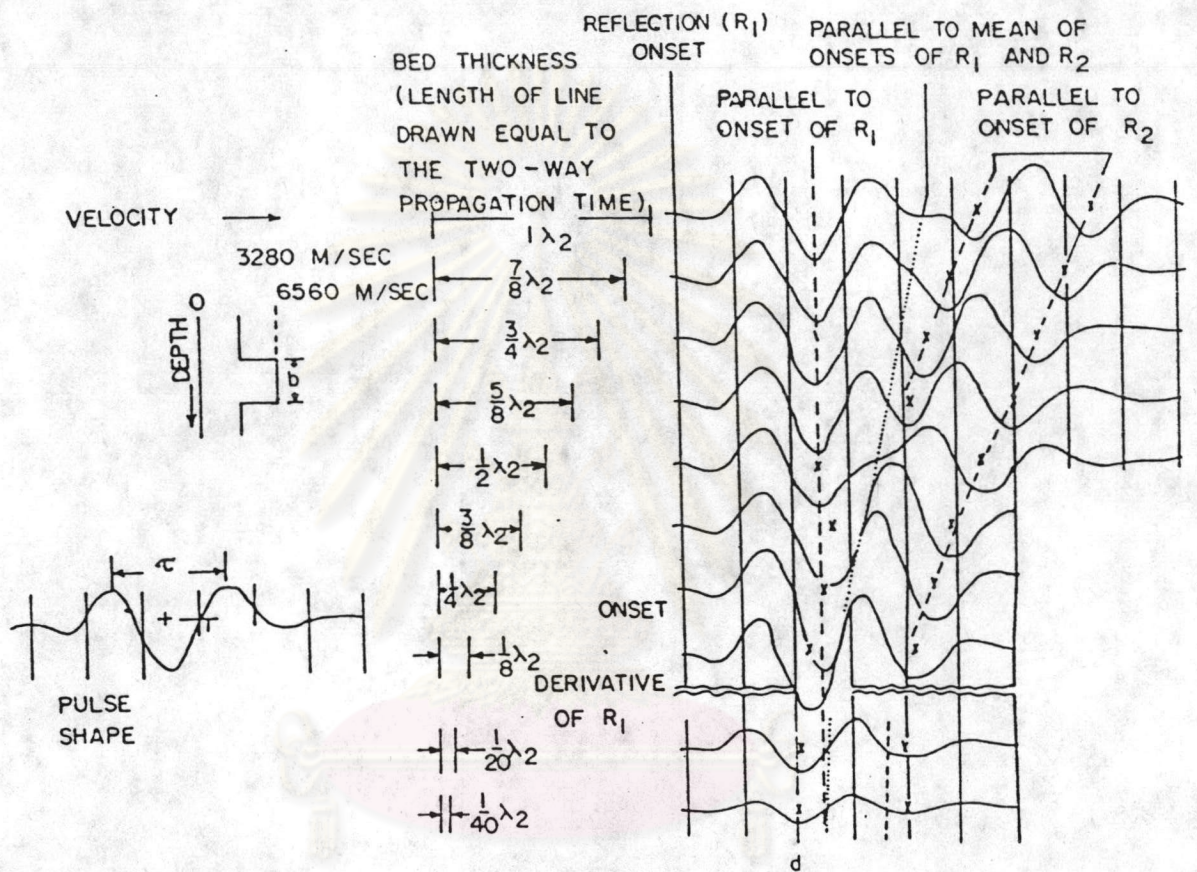

Figure 2-1 Effect of varying bed thickness on reflection wave  $R_1$  is reflection from top  $R_2$  from bottom of bed. High-speed layer is sandwiched between beds of much lower speed as shown on left. When thickness of high-speed layer reaches three-eighths of a wavelength it is no longer possible to resolve reflections. (Modify after Widness, 1973)

### Reflection Geometry

For plane reflectors in Figure 2-2,

where  $X_s$  = shot coordinate  
 $X_r$  = receiver coordinate  
 $Z'$  = vertical depth point below mid point(X)

The travel time equation of reflected wave travelling in a medium with velocity V can be written as

$$t = \left[ t_0^2 + \frac{X^2}{V_s^2} \right]^{1/2}$$

Where  $t_0 = \frac{2Z' \cos \theta}{V}$   
 and  $V_s = \frac{V}{\cos \theta}$

### Seismic Data Acquisition

Basic goal of data acquisition is to produce seismograms with adequate seismic reflections at low noise level, ie. high S/N. For two dimensional shooting, there are three commonly use methods namely conventional shooting, common mid point shooting and optimum window shooting with optimum offset.

Conventional Shooting It is the simplest method in which geophone locations are spread evenly along a line and shot points locate off the end, at the end, or in the middle of the spread. To suppress the effect of ground roll, a group of geophones in a designed pattern is used ; the middle position of a geophone group

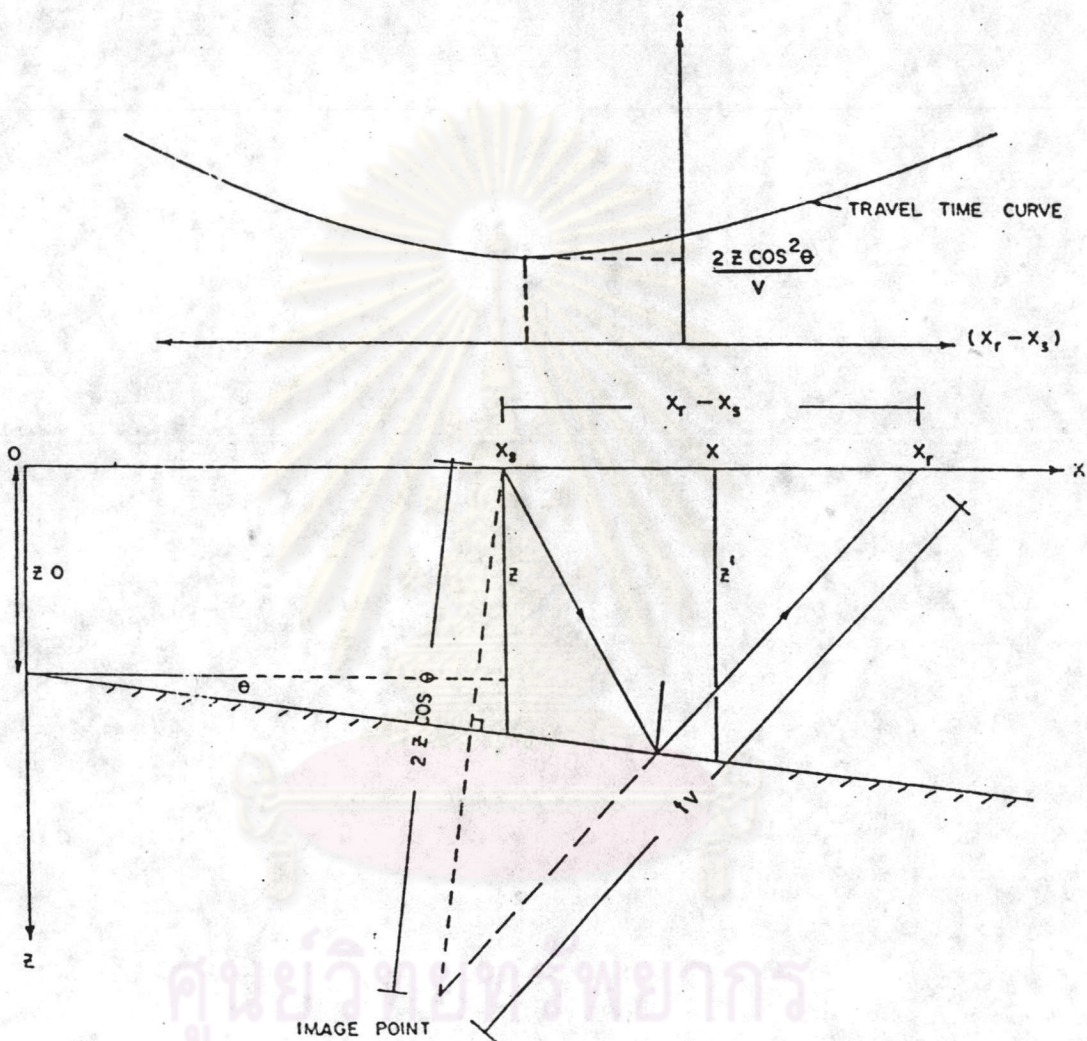

Figure 2-2 Reflection path geometry

represent geophone location. An example is illustrated in Figure 2-3. Each subsurface point is recorded only once. S/N will be determined by seismic source strength and noise condition at the time of recording.

Common Depth Point Shooting It is the commonly use technique. Which was improved from previous method. Each subsurface point (CDP), presently called CMP, is recorded more than one time (Figure 2-4). A simple field procedure for 600% coverage is illustrated in Figure 2-5. By algebraically combining CMP trace after applying appropriate time correction, alias CMP stacking, the amount of random noise as well as the effect of multiple reflections are largely suppressed. The theoretical improvement of S/N is proportional to the square root of number of CDP traces combined.

Optimum Window Shooting This technique was developed by Hunter, et.al.(1982) for shallow reflection works using engineering seismograph with single geophone for each channel. The shooting pattern is an off-end conventional shooting where geophone are located within the optimum window-the distance of which the desired reflections are visible and situated between the refracted wavelet and the ground-roll (Figure 2-6). Since no stacking of traces is done, consequently there will be no improvement on S/N ratio.

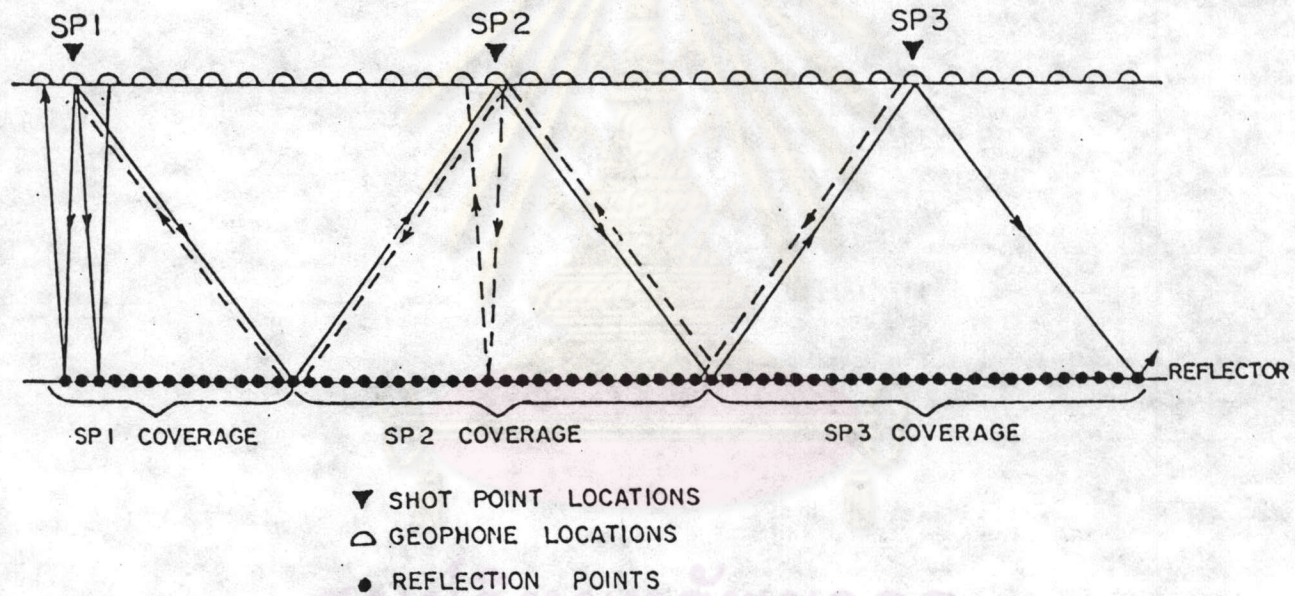

Figure 2-3 Conventional 100 % subsurface Coverage

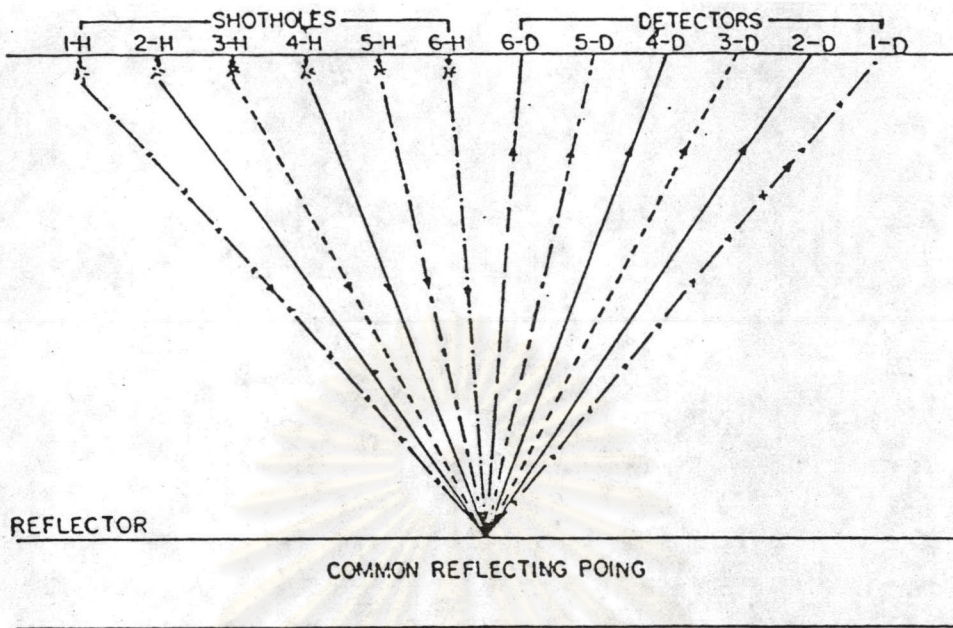

Figure 2-4 6-fold arrangement of CMP shots.

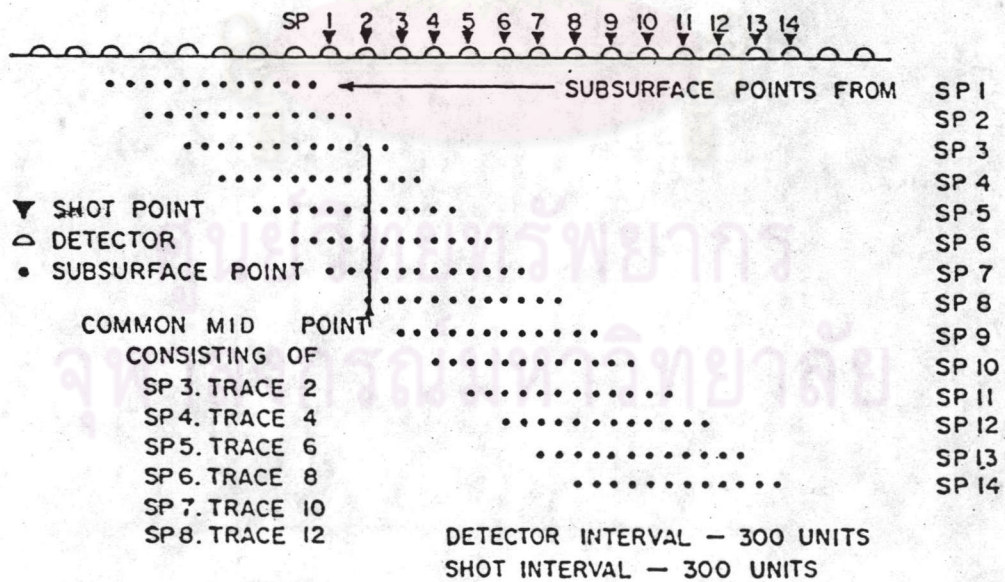

Figure 2-5 Field procedure for 12 detectors, 6 fold survey.



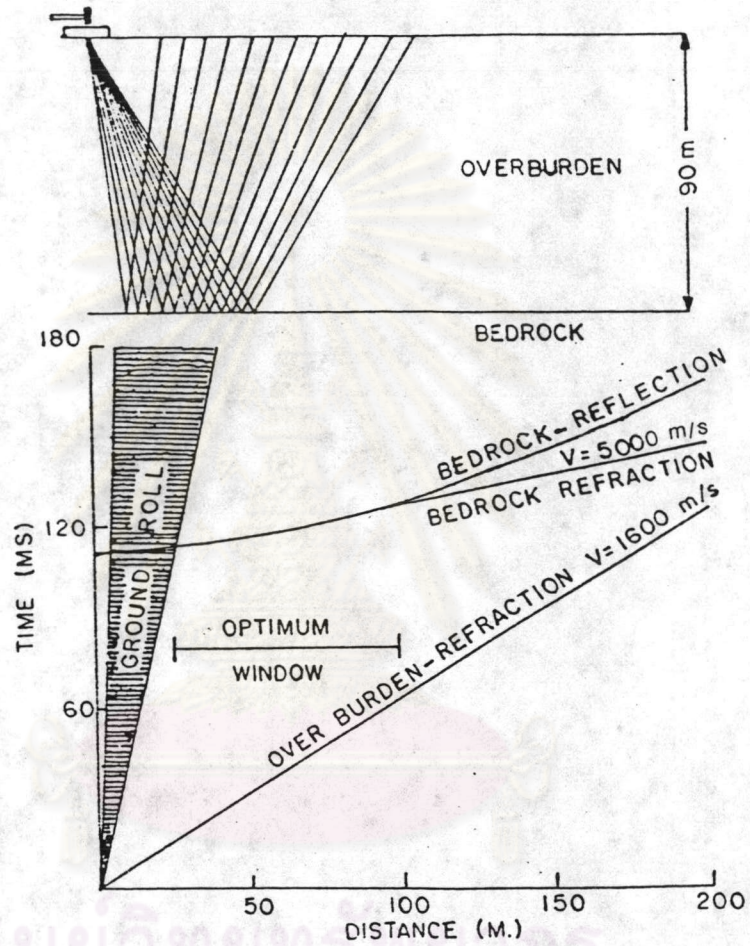

Figure 2-6 Two layer reflection model and travel-time curve with an overburden thickness of 90 meters overburden velocity of 1600 meters/second and bedrock velocity of 5000 meters/second.

(After Hunter, et. al. (1984))

Common offset recording is a special technique of optimum window shooting. The offset distance between shot location and receiver location is kept constant along the profile. In effect, only one channel is used for each shot. The offset distance is selected within the optimum window such that it is best map the reflector of interest.

### Seismic Data Processing

The objective of the data processing is to improved the data quality. Data processing usually splits into several steps which can be describe as follow.

Gain Adjustment Modern engineering seismograph use various gain ranging techniques to increase their dynamic range. They can be devided into 3 type : fixed gain, automatic gain (AGC), and programmed gain (PGC). For data that are recorded with fixed gain or programmed gain, true amplitude of reflecting signals can be recovered by applying appropriate gain function to the data.

Geometric Correction A proper seismic section should represent vertical reflection times in which the source and receiver represent identical location for each trace. Due to the fact that source and receivers are located at different elevations and at different distance apart during shooting, the reflecting horizons presented

on the data traces are misaligned. These horizons must be properly aligned prior to stacking. There are two types of corrections : static correction and normal moveout correction.

Static Correction is a vertical correction to place sources and receivers on the same horizontal plane. The basic technique is to correct data to a "datum elevation " by removing the calculated travel time from the source to the datum and from the receiver to the datum. The correction shall take into account of the differences in the thickness and velocity of weathered layer. The simplest case is which only elevation differences are considered is shown in Figure 2-7.

Normal Moveout Correction is a horizontal correction to place sources and receivers on the same vertical plane. NMO varies as a function of offset distance, normal incidence reflection time, and average velocity according to Figure 2-8. Offset distance is known from shooting parameters. Normal incidence reflection time and average velocity can be obtained from statistical procedures in which portions of data are gathered or stacked at different velocities. This procedure is generally called velocity analysis.

CDP Sorting The ultimate goal in this step is to prepare the data for common mid point stacking. Before

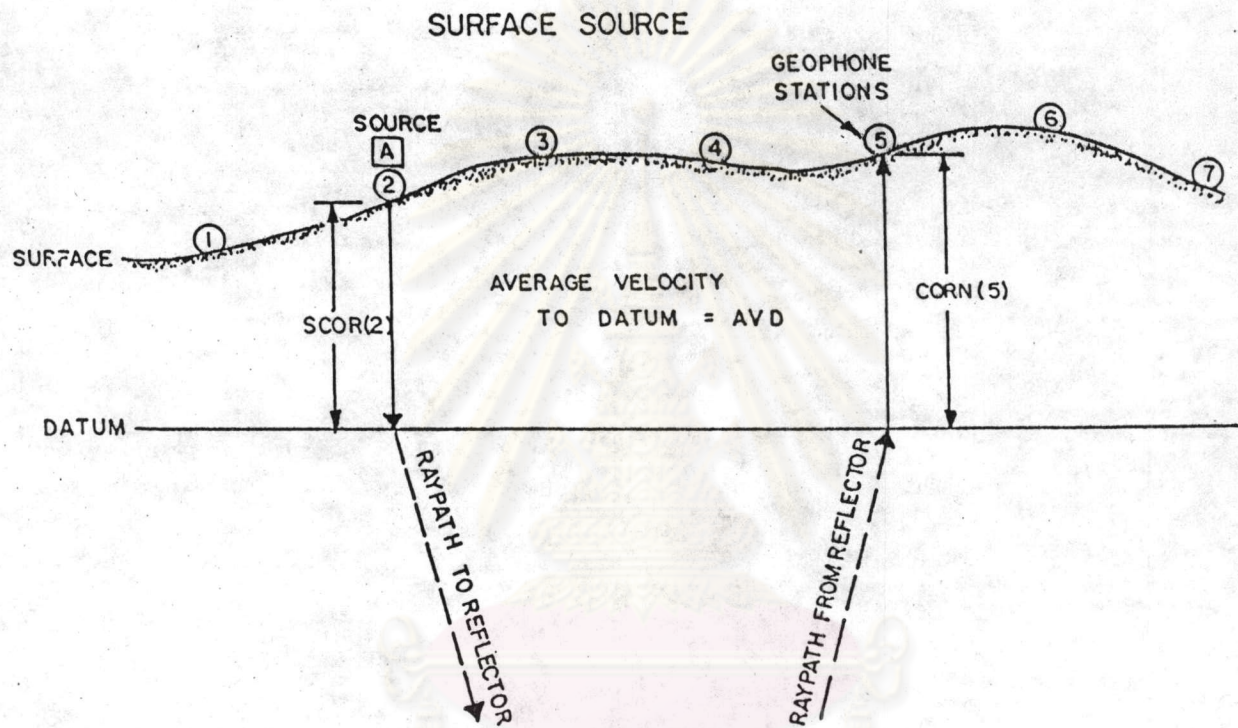

$$SCOR(2) = \frac{\text{Datum Elev.} - \text{Geophone Elev. (at 2)}}{AVD}$$

$$CORN(5) = \frac{\text{Datum Elev.} - \text{Geophone Elev. (at 5)}}{AVD}$$

Figure 2-7 The simplest case of static correction.

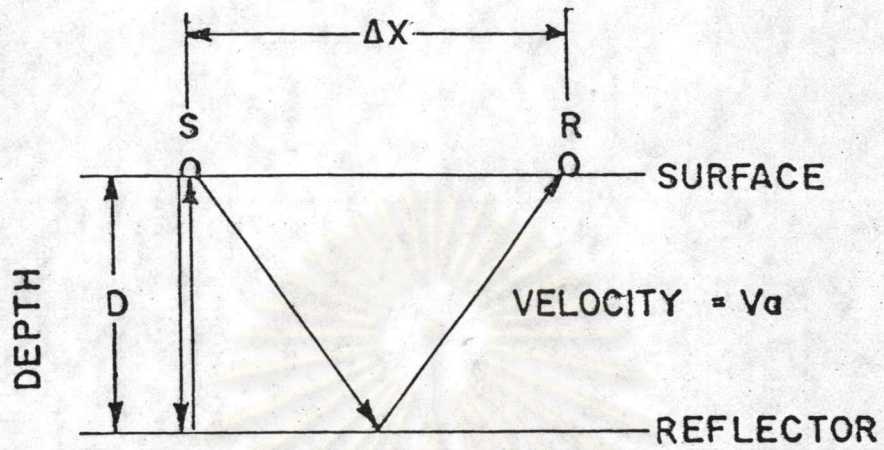

SEISMIC RECORD

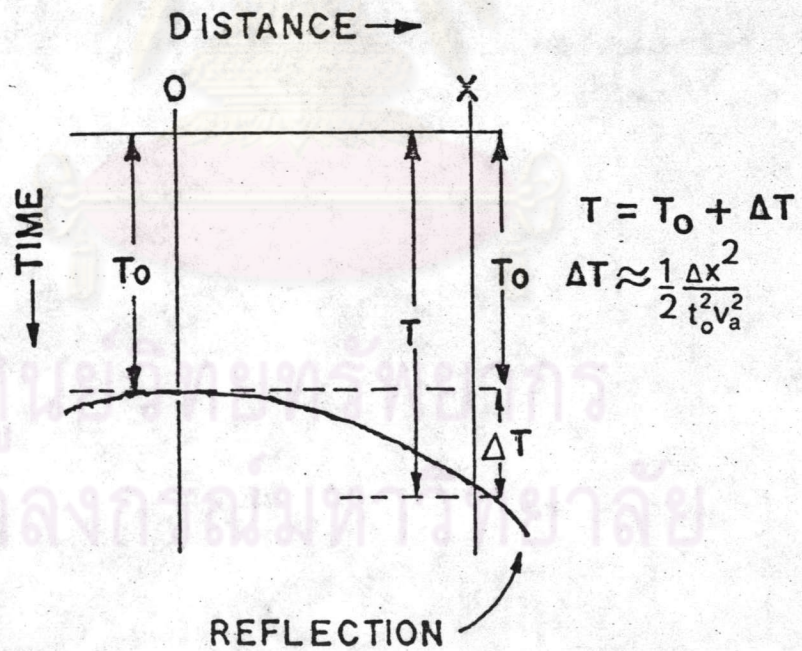

Figure 2-8 Normal moveout correction ( $\Delta T$ ).

the traces are stacked they are sorted or gathered into depth point order; all traces of the first depth point followed by all traces of the second depth point and so on.

Stacking is basically the process in which the traces in each CMP gather are summed into one trace to attenuate ambient random noise and some forms of long period multiple reflections and coherent noise. Stacking will improve S/N by the square root of number of traces summed.

Filtering is a process to extract desired frequency components from a trace and attenuate all others. If the spectrum of noise is different from the spectrum of signal, S/N will be improved. Filter can be designed and applied either in time domain or in frequency domain. To avoid having "ringy" filter, the pass band should be at least one octave wide. Also the taper zones on the low frequency side should be about one octave wide and on the high frequency side should be about half octave wide.

Velocity Analysis is a process to determine velocity function that will be used in Normal Moveout correction. As mentioned earlier, NMO is a function of offset distance, average velocity, and normal reflection time. This velocity function can be determined by solving equation :

$$V_a = \frac{x^2}{(T^2 - T_o^2)}$$

where X = offset distance

T = actual arrival time =  $T_o + \Delta T$

$T_o$  = normal incident arrival time

$\Delta T$  = normal moveout correction time

One approach - a constant velocity scan (CVS) is to select a portion of a line then make NMO correction and stack it repeatedly using an ordered sequence of constant velocities. To pick a velocity function from CVS, the good reflections are located and recorded the time at which they occur and the velocity at which they appear to stack best.

ศูนย์วิทยทรัพยากร  
จุฬาลงกรณ์มหาวิทยาลัย