

## หนังสืออ้างอิง

1. P G Simpson, Induction Heating. (McGraw-Hill Book Company, 1960.)
2. John D. Harnden, Jr. and Forset B. Golden, Power semiconductor Application Volume 2, (IEEE, 1972).
3. D.R. Grafham and J.C., SCR Manual fifth edition. (General Electric Company., 1972.)
4. B.D. Bedford and R.G. Hoft, Principle of Inverter Circuit, (John Wiley & Sons, Inc., 1964.)
5. Jacob Millman and Herbert Taub, Pulse Digital and Switching Waveform, (McGraw-Hill Kogakusha, Ltd. 1965.)
6. A.E. Fitzgerald and Charles Kingsley, Jr. and Alexander, L Kusko, Electric Machinery, (McGraw-Hill Book Company, Tokyo, 1971.)
7. Phillip E. Thlbodeau, "The switcher transformer: Designing it in one try for switching power supplies" Electronic Design. September 1 1980, Vol.28 No.12.



# Industrial/Automotive/Functional Blocks

LM555/LM555C

## LM555/LM555C timer

### general description

The LM555 is a highly stable device for generating accurate time delays or oscillation. Additional terminals are provided for triggering or resetting if desired. In the time delay mode of operation, the time is precisely controlled by one external resistor and capacitor. For astable operation as an oscillator, the free running frequency and duty cycle are accurately controlled with two external resistors and one capacitor. The circuit may be triggered and reset on falling waveforms, and the output circuit can source or sink up to 200 mA or drive TTL circuits.

- Adjustable duty cycle
- Output can source or sink 200 mA
- Output and supply TTL compatible
- Temperature stability better than 0.005% per °C
- Normally on and normally off output

### applications

- Precision timing
- Pulse generation
- Sequential timing
- Time delay generation
- Pulse width modulation
- Pulse position modulation
- Linear ramp generator

### features

- Direct replacement for SE555/NE555
- Timing from microseconds through hours
- Operates in both astable and monostable modes

### schematic diagram

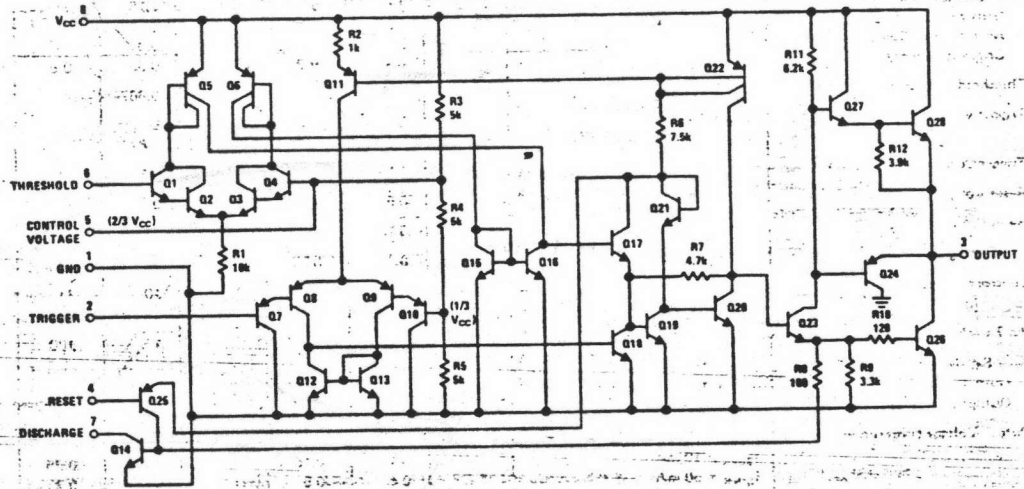

### connection diagrams

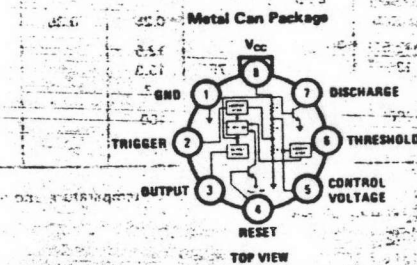

Order Number LM555H or LM555CH  
See Package 11

### Dual-In-Line Package

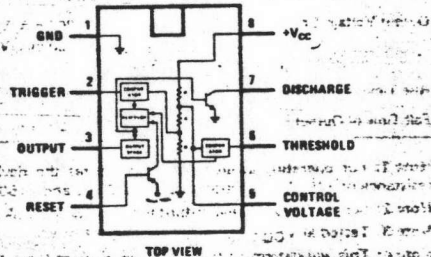

Order Number LM555CN  
See Package 20

9

LM555/LM555C

**absolute maximum ratings**

Supply Voltage	+18V
Power Dissipation (Note 1)	600 mW
Operating Temperature Ranges	
LM555C	0°C to +70°C
LM555	-55°C to +125°C
Storage Temperature Range	-65°C to +150°C
Lead Temperature (Soldering, 10 seconds)	300°C

**electrical characteristics** ( $T_A = 25^\circ\text{C}$ ,  $V_{CC} = +5\text{V to } +15\text{V}$ , unless otherwise specified)

PARAMETER	CONDITIONS	LIMITS						UNITS
		LM555			LM555C			
		MIN	TYP	MAX	MIN	TYP	MAX	
Supply Voltage		4.5		18	4.5		16	V
Supply Current	$V_{CC} = 5\text{V}, R_L = \infty$ $V_{CC} = 15\text{V}, R_L = \infty$ (Low State) (Note 2)		3 10	5 12		3 10	6 15	mA mA
Timing Error, Monostable								%
Initial Accuracy			0.5	2		1		%
Drift with Temperature	$R_A, R_B = 1\text{k to } 100\text{k}$ $C = 0.1\mu\text{F}$ , (Note 3)		30			50		ppm/°C
Accuracy over Temperature			1.5	3.0		1.5		%
Drift with Supply			0.05	0.2		0.1		%/V
Timing Error, Astable								%
Initial Accuracy			1.5	5		2.25	7	%
Drift with Temperature			90			150		ppm/°C
Accuracy over Temperature			2.5			3.0		%
Drift with Supply			0.15	0.2		0.30	0.5	%/V
Threshold Voltage				0.667			0.667	$\times V_{CC}$
Trigger Voltage	$V_{CC} = 15\text{V}$ $V_{CC} = 5\text{V}$	4.8 1.45	5 1.67	5.2 1.9		5 1.67		V V
Trigger Current			0.01	0.5		0.5	0.9	$\mu\text{A}$
Reset Voltage		0.4	0.5	1	0.4	0.5	1	V
Reset Current			0.1	0.4		0.1	0.4	mA
Threshold Current	(Note 4)		0.1	0.25		0.1	0.25	$\mu\text{A}$
Control Voltage Level	$V_{CC} = 15\text{V}$ $V_{CC} = 5\text{V}$	9.6 2.9	10 3.33	10.4 3.8	9 2.6	10 3.33	11 4	V V
Pin 7 Leakage Output High			1	100		1	100	nA
Pin 7 Sat (Note 5)								mV
Output Low	$V_{CC} = 15\text{V}, I_T = 15\text{ mA}$		150			180		mV
Output Low	$V_{CC} = 4.5\text{V}, I_T = 4.5\text{ mA}$		70	100		80	200	mV
Output Voltage Drop (Low)	$V_{CC} = 15\text{V}$ $I_{SINK} = 10\text{ mA}$ $I_{SINK} = 50\text{ mA}$ $I_{SINK} = 100\text{ mA}$ $I_{SINK} = 200\text{ mA}$ $V_{CC} = 5\text{V}$ $I_{SINK} = 8\text{ mA}$ $I_{SINK} = 5\text{ mA}$		0.1 0.4 2 2.5	0.15 0.5 2.2 2.5		0.1 0.4 2 2.5	0.25 0.75 2.5	V V V V
Output Voltage Drop (High)	$I_{SOURCE} = 200\text{ mA}, V_{CC} = 15\text{V}$ $I_{SOURCE} = 100\text{ mA}, V_{CC} = 15\text{V}$ $V_{CC} = 5\text{V}$		13 3	12.5 13.3 3.3		12.75 13.3 3.3	12.5 13.3	V V V
Rise Time of Output			100			100		ns
Fall Time of Output			100			100		ns

Note 1: For operating at elevated temperatures the device must be derated based on a +150°C maximum junction temperature and a thermal resistance of +45°C/W junction to case for TO-5 and +150°C/W junction to ambient for both packages.

Note 2: Supply current when output high typically 7 mA less at  $V_{CC} = 5\text{V}$ .

Note 3: Tested at  $V_{CC} = 5\text{V}$  and  $V_{CC} = 15\text{V}$ .

Note 4: This will determine the maximum value of  $R_A + R_B$  for 15V operation. The maximum total ( $R_A + R_B$ ) is 20 M $\Omega$ .

Note 5: No protection against excessive pin 7 current is necessary providing the package dissipation rating will not be exceeded.

**applications information (con't)**

The frequency of oscillation is:

$$f = \frac{1}{T} = \frac{1.44}{(R_A + 2R_B)C}$$

Figure 6 may be used for quick determination of these RC values.

The duty cycle is:  $D = \frac{R_B}{R_A + 2R_B}$

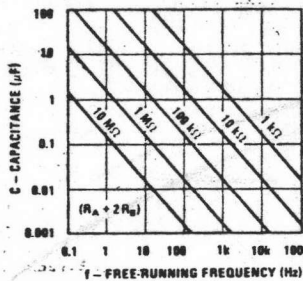

FIGURE 6. Free Running Frequency

**FREQUENCY DIVIDER**

The monostable circuit of Figure 1 can be used as a frequency divider by adjusting the length of the timing cycle. Figure 7 shows the waveforms generated in a divide by three circuit.

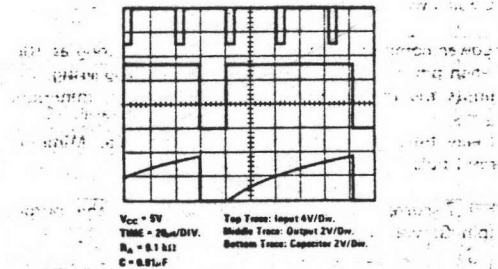

FIGURE 7. Frequency Divider

**PULSE WIDTH MODULATOR**

When the timer is connected in the monostable mode and triggered with a continuous pulse train, the output pulse width can be modulated by a signal applied to pin 5. Figure 8 shows the circuit, and in Figure 9 are some waveform examples.

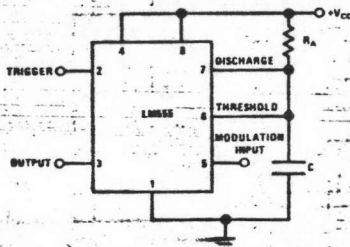
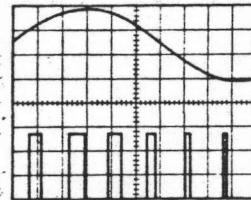

FIGURE 8. Pulse Width Modulator



V<sub>CC</sub> = 5V  
TIME = 0.2 μs/DIV.  
R<sub>A</sub> = 0.1 kΩ  
C = 0.01 μF

FIGURE 9. Pulse Width Modulator

**PULSE POSITION MODULATOR**

This application uses the timer connected for astable operation, as in Figure 10, with a modulating signal again applied to the control voltage terminal. The pulse position varies with the modulating signal, since the threshold voltage and hence the time delay is varied. Figure 11 shows the waveforms generated for a triangle wave modulation signal.

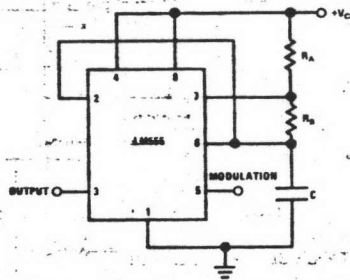
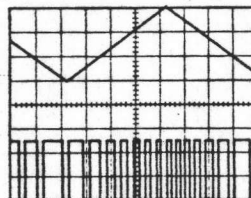

FIGURE 10. Pulse Position Modulator



V<sub>CC</sub> = 5V  
TIME = 0.1 μs/DIV.  
R<sub>A</sub> = 3.9 kΩ  
R<sub>B</sub> = 3 kΩ  
C = 0.01 μF

FIGURE 11. Pulse Position Modulator

**LINEAR RAMP**

When the pullup resistor, R<sub>A</sub>, in the monostable circuit is replaced by a constant current source, a linear ramp is

MM54C73/MM74C73, MM54C76/MM74C76, MM54C107/MM74C107



## MM54C73/MM74C73 Dual J-K Flip-Flops with Clear MM54C76/MM74C76 Dual J-K Flip-Flops with Clear and Preset MM54C107/MM74C107 Dual J-K Flip-Flops with Clear

### general description

These dual J-K flip-flops are monolithic complementary MOS (CMOS) integrated circuits constructed with N- and P-channel enhancement transistors. Each flip-flop has independent J, K, clock and clear inputs and Q and  $\bar{Q}$  outputs. The MM54C76/MM74C76 flip flops also include preset inputs and are supplied in 16 pin packages. These flip flops are edge sensitive to the clock input and change state on the negative going transition of the clock pulses. Clear or preset is independent of the clock and is accomplished by a low level on the respective input.

### features

- Supply voltage range 3V to 15V
- Tenth power TTL compatible drive 2 LPTTL loads

- High noise immunity
- Low power 0.45 V<sub>CC</sub> (typ) 50 nW (typ)
- Medium speed operation 10 MHz (typ) with 10V supply

### applications

- Automotive
- Data terminals
- Instrumentation
- Medical electronics
- Alarm systems
- Industrial electronics
- Remote metering
- Computers

### logic and connection diagrams

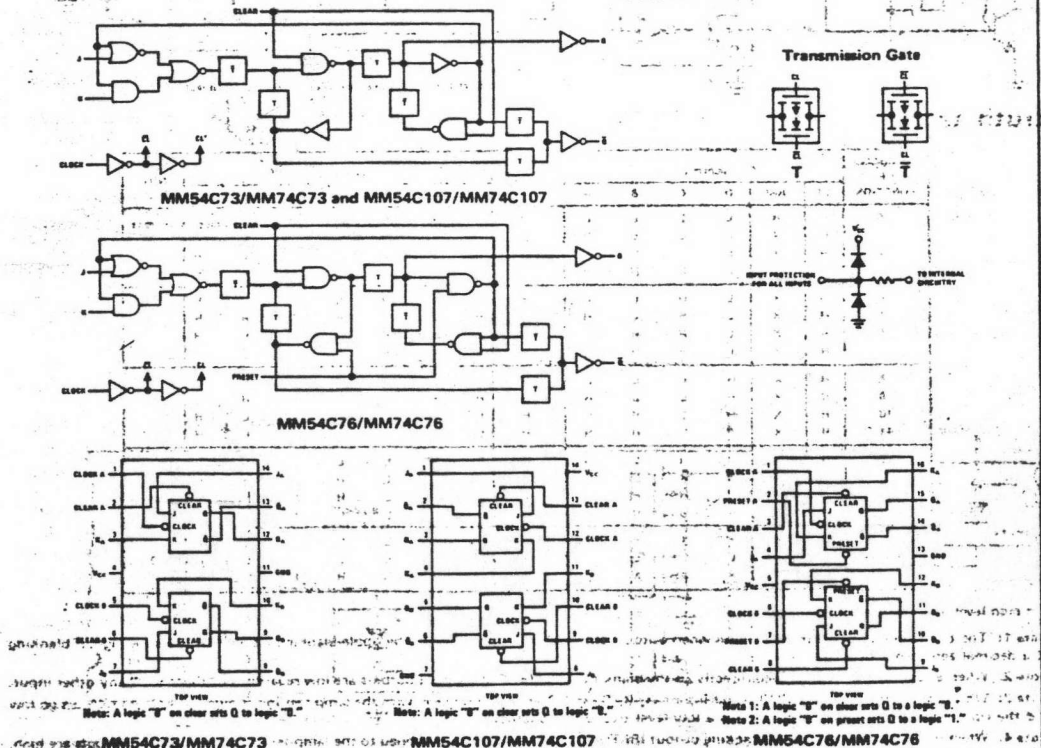

MM54C73/MM74C73, MM54C76/MM74C76, MM54C107/MM74C107

**absolute maximum ratings**

Voltage at any pin (Note 1)	-0.3V to $V_{CC} + 0.3V$
Operating Temperature MM54CXX	-55°C to 125°C
MM74CXX	-40°C to +85°C
Storage Temperature	-65°C to 150°C
Maximum $V_{CC}$ Voltage	18V
Package Dissipation	500 mW
Lead Temperature (Soldering, 10 sec)	300°C
Operating $V_{CC}$ Range	+3V to 15V

**electrical characteristics**

PARAMETERS	CONDITIONS	MIN	TYP	MAX	UNITS
<b>CMOS TO CMOS</b>					
Logical "1" Input Voltage $V_{IN(1)}$	$V_{CC} = 5.0V$ $V_{CC} = 10.0V$	3.5 8			V V
Logical "0" Input Voltage $V_{IN(0)}$	$V_{CC} = 5.0V$ $V_{CC} = 10.0V$			1.5 2.0	V V
Logical "1" Output Voltage $V_{OUT(1)}$	$V_{CC} = 5.0V$ $V_{CC} = 10.0V$	4.5 9.0			V V
Logical "0" Output Voltage $V_{OUT(0)}$	$V_{CC} = 5.0V$ $V_{CC} = 10.0V$			0.5 1.0	V V
Logical "1" Input Current $I_{IN(1)}$	$V_{CC} = 15.0V$			1.0	$\mu A$
Logical "0" Input Current $I_{IN(0)}$	$V_{CC} = 15.0V$			1.0	$\mu A$
Supply Current $I_{CC}$	$V_{CC} = 15.0V$		0.050	60	$\mu A$
Input Capacitance	Any Input		5		pF
Propagation Delay Time to a Logical "0" $t_{pd0}$ or Logical "1" $t_{pd1}$ From Clock to Q or $\bar{Q}$	$V_{CC} = 5.0V, C_L = 50 pF, T_A = 25^\circ C$ $V_{CC} = 10.0V, C_L = 50 pF, T_A = 25^\circ C$		180 70	300 110	ns ns
Propagation Delay Time to a Logical "0" From Preset or Clear	$V_{CC} = 5.0V, C_L = 50 pF, T_A = 25^\circ C$ $V_{CC} = 10.0V, C_L = 50 pF, T_A = 25^\circ C$		200 80	300 130	ns ns
Propagation Delay Time to a Logical "1" From Preset or Clear	$V_{CC} = 5.0V, C_L = 50 pF, T_A = 25^\circ C$ $V_{CC} = 10.0V, C_L = 50 pF, T_A = 25^\circ C$		200 80	300 130	ns ns
Time Prior to Clock Pulse That Data Must be Present, $t_{SETUP}$	$V_{CC} = 5.0V, C_L = 50 pF, T_A = 25^\circ C$ $V_{CC} = 10.0V, C_L = 50 pF, T_A = 25^\circ C$		110 45	175 70	ns ns
Time After Clock Pulse That J and K Must be Held	$V_{CC} = 5.0V, C_L = 50 pF, T_A = 25^\circ C$ $V_{CC} = 10.0V, C_L = 50 pF, T_A = 25^\circ C$		-40 -20	0 0	ns ns
Minimum Clock Pulse Width $t_{WL} = t_{WH}$	$V_{CC} = 5.0V, C_L = 50 pF, T_A = 25^\circ C$ $V_{CC} = 10.0V, C_L = 50 pF, T_A = 25^\circ C$		120 50	190 80	ns ns
Minimum Preset and Clear Pulse Width	$V_{CC} = 5.0V, C_L = 50 pF, T_A = 25^\circ C$ $V_{CC} = 10.0V, C_L = 50 pF, T_A = 25^\circ C$		90 40	130 60	ns ns
Maximum Toggle Frequency	$V_{CC} = 5.0V, C_L = 50 pF, T_A = 25^\circ C$ $V_{CC} = 10.0V, C_L = 50 pF, T_A = 25^\circ C$	2.5 7.0	4.0 11.0		MHz MHz
Clock Pulse Rise and Fall Time	$V_{CC} = 5.0V, C_L = 50 pF, T_A = 25^\circ C$ $V_{CC} = 10.0V, C_L = 50 pF, T_A = 25^\circ C$			15	$\mu s$ $\mu s$
<b>LOW POWER TTL TO CMOS INTERFACE</b>					
Logical "1" Input Voltage $V_{IN(1)}$	54C, $V_{CC} = 4.5V$ 74C, $V_{CC} = 4.75V$		$V_{CC} - 1.5$		V
Logical "0" Input Voltage $V_{IN(0)}$	54C, $V_{CC} = 4.5V$ 74C, $V_{CC} = 4.75V$			0.8	V
Logical "1" Output Voltage $V_{OUT(1)}$	54C, $V_{CC} = 4.5V, I_O = -360\mu A$ 74C, $V_{CC} = 4.75V, I_O = -360\mu A$		2.4		V
Logical "0" Output Voltage $V_{OUT(0)}$	54C, $V_{CC} = 4.5V, I_O = 360\mu A$ 74C, $V_{CC} = 4.75V, I_O = 360\mu A$			0.4	V
<b>OUTPUT DRIVE (See 54C/74C Family Characteristics Data Sheet)</b>					
Output Source Current ( $I_{SOURCE}$ )	$V_{CC} = 5.0V, V_{IN(0)} = 0V$ $T_A = 25^\circ C, V_{OUT} = 0V$		-1.75		mA
Output Source Current ( $I_{SOURCE}$ )	$V_{CC} = 10V, V_{IN(0)} = 0V$ $T_A = 25^\circ C, V_{OUT} = 0V$		-8.0		mA
Output Sink Current ( $I_{SINK}$ )	$V_{CC} = 5.0V, V_{IN(1)} = 5.0V$ $T_A = 25^\circ C, V_{OUT} = V_{CC}$		1.75		mA
Output Sink Current ( $I_{SINK}$ )	$V_{CC} = 10V, V_{IN(1)} = 10V$ $T_A = 25^\circ C, V_{OUT} = V_{CC}$		8.0		mA
<p>Note 1: This device should not be connected to circuits with the power on because high transient voltages may cause permanent damage.</p>					

MM54C73/MM74C73, MM54C76/MM74C76, MM54C107/MM74C107

ac test circuit

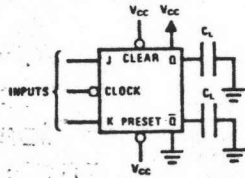

truth table

$t_n$		$t_{n+1}$
J	K	Q
0	0	$Q_n$
0	1	0
1	0	1
1	1	$\bar{Q}_n$

Preset	Clear	$Q_n$	$\bar{Q}_n$
0	0	0	0
0	1	1	0
1	0	0	1
1	1	* $Q_n$	* $\bar{Q}_n$

$t_n$  = bit time before clock pulse,  
 $t_{n+1}$  = bit time after clock pulse.

\* No change in output from previous state.

typical applications

Ripple Binary Counters

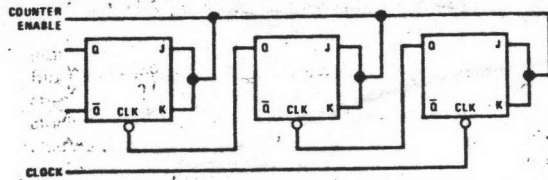

74C Compatibility

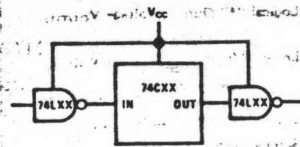

Shift Registers

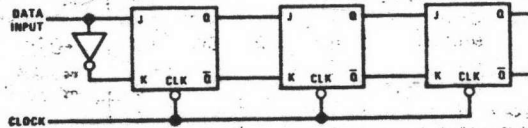

Guaranteed Noise Margin as a Function of  $V_{CC}$

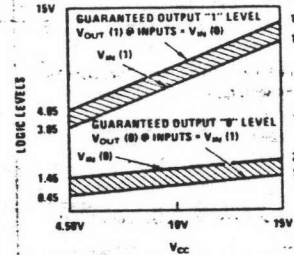

switching time waveforms

CMOS to CMOS

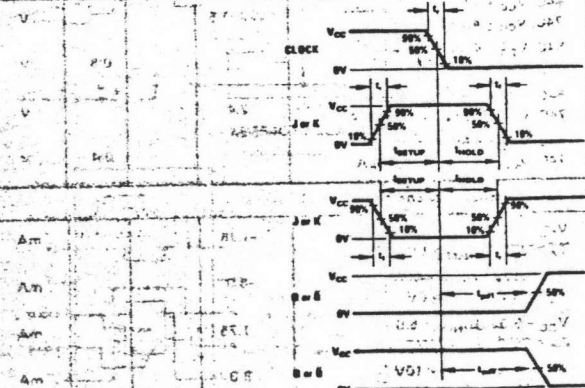

litronix

ภาคผนวก ค.

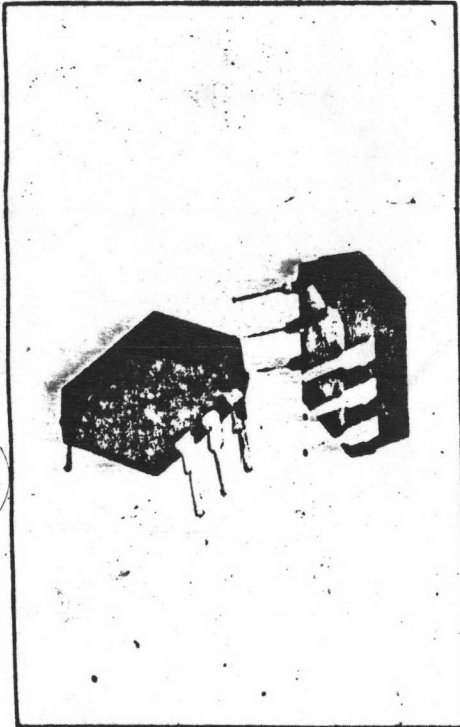
Iso-Lit 15  
Iso-Lit 16PHOTOTRANSISTOR  
OPTO-ISOLATOR

## FEATURES

- 1500 Volt Breakdown Voltage
- 14% Typical Current Transfer Ratio
- IL-16 Maximum 30% Transfer Ratio (Equivalent to MCT-26)
- .5 pF Typical Coupling Capacitance
- Standard Dual-In-Line Package

## DESCRIPTION

IL-15/IL-16 is an optically coupled pair employing a Gallium Arsenide infrared LED and a silicon NPN phototransistor. Signal information, including a DC level, can be transmitted by the device while maintaining a high degree of electrical isolation between input and output. The IL-15/IL-16 can be used to replace relays and transformers in many digital interface applications, as well as analog applications such as CRT modulation.

## Package Dimensions (in inches)

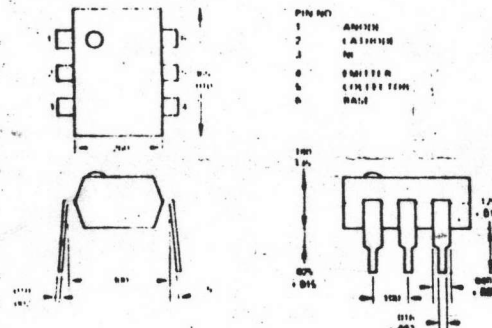

## Maximum Ratings

## Gallium Arsenide LED

Power Dissipation @ 25°C	200 mW
Derate Linearly from 25°C	2.8 mW/°C
Continuous Forward Current	60 mA
Peak Inverse Voltage	30V

## Detector (Silicon Phototransistor)

Power Dissipation at 25°C	200 mW
Derate Linearly from 25°C	2.8 mW/°C
Collector-Emitter Breakdown Voltage (BVCEO)	30V
Emitter-Collector Breakdown Voltage (BVECO)	7V
Collector-Base Breakdown Voltage (BV CBO)	30V

## Package

Total Package Dissipation at 25°C Ambient (LED Plus Detector)	260 mW
Derate Linearly From 25°C	3.3 mW/°C
Storage Temperature	-55°C to +150°C
Operating Temperature	-55°C to +100°C
Lead Soldering Time @ 260°C	7.0 sec

## Electrical Characteristics (at 25°C Ambient)

Parameter	Min	Typ	Max	Unit	Test Condition
<b>Gallium Arsenide LED</b>					
Forward Voltage		1.25	1.5	V	$I_F = 60 \text{ mA}$
Reverse Current		.15	10	$\mu\text{A}$	$V_R = 3.0$
Capacitance		100		pF	$V_R = 0$
<b>Phototransistor Detector</b>					
hFE		150			$V_{CE} = 5.0 \text{ V}$ $I_C = 100 \mu\text{A}$
BVCEO	30	75		V	$I_C = 1 \text{ mA}$
BVECO	7	12		V	$I_E = 100 \mu\text{A}$
$I_{CEO}$ (dark)		5	100	nA	$V_{CE} = 5 \text{ V}$ $I_F = 0$
Collector-Emitter Capacitance		2		pF	$V_{CE} = 0$
<b>Coupled Characteristics</b>					
DC Current Transfer Ratio	IL 15	.06	.20		$I_F = 10 \text{ mA}$ $V_{CE} = 10 \text{ V}$
	IL 16	.06	.14	0.3	$I_F = 10 \text{ mA}$ $V_{CE} = 10 \text{ V}$
Capacitance, Input to Output		.5	2.0	pF	
Breakdown Voltage		1500		V	D.C.
Resistance, Input to Output		100		GΩ	
Output Rise and Fall Times		2		$\mu\text{s}$	$I_F = 10 \text{ mA}$ $V_{CE} = 10 \text{ V}$
Collector-Emitter Saturation Voltage $V_{CE(sat)}$			0.5V		$I_F = 50 \text{ mA}$ $I_C = 2 \text{ mA}$



ג. תכונות סטנדרטיות.

STANDARD CHARACTERISTICS

MATERIAL		2 C 3
$\mu_{iac}$		2000 $\pm 20\%$
$\tan \delta / \mu_{iac}$ 0.01MHz	$10^{-4}$	6
$\Delta \mu_{iac} / \mu_{iac} / ^\circ C$ (-30°C ~ -20 ~ +60°C)	$10^{-4}$	1 -5
$T_c$	°C	110
FREQUENCY	MHz	< 0.2
D. F. (1 ~ 10min.)	$10^{-4}$	< 4
d	g/cm <sup>3</sup>	4.9
B 15	G	3.700
Hcms	O <sub>0</sub>	0.2
$\rho$	$\Omega_{cm}$	130

EXAMPLE OF DIMENSIONS

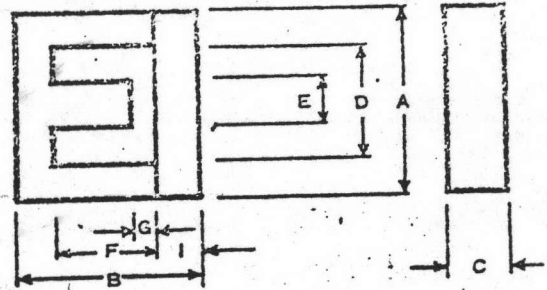

UNIT mm

Name	A		B		C, E		D		F		I	
	Size	Tolerance	Size	Tolerance	Size	Tolerance	Size	Tolerance	Size	Tolerance	Size	Tolerance
E I 1-60	60.0	$\pm 0.6$	44.0	$\pm 0.6$	16.0	0 -0.6	44.5	$\pm 0.5$	23.0	$\pm 0.5$	8.0	$\pm 0.1$
E I 2-60		$\pm 0.9$		$\pm 0.6$		0 -0.8		$\pm 0.7$		$\pm 0.5$		$\pm 0.3$
E I 1-50	50.0	$\pm 0.5$	42.0	$\pm 0.4$	14.0	0 -0.6	35.0	$\pm 0.4$	25.0	$\pm 0.4$	8.5	$\pm 0.1$
E I 2-50		$\pm 0.8$		$\pm 0.6$		0 -0.6		$\pm 0.6$		$\pm 0.4$		$\pm 0.3$
E I 1-40	40.0	$\pm 0.4$	34.0	$\pm 0.4$	11.0	0 -0.4	28.0	$\pm 0.3$	21.0	$\pm 0.4$	6.5	$\pm 0.1$
E I 2-40		$\pm 0.6$		$\pm 0.6$		0 -0.6		$\pm 0.5$		$\pm 0.4$		$\pm 0.3$
E I 1-30	30.0	$\pm 0.3$	26.0	$\pm 0.4$	10.0	0 -0.4	20.0	$\pm 0.3$	16.0	$\pm 0.3$	5.5	$\pm 0.1$
E I 2-30		$\pm 0.5$		$\pm 0.4$		0 -0.6		$\pm 0.4$		$\pm 0.3$		$\pm 0.2$
E I 1-22	22.0	$\pm 0.3$	18.6	$\pm 0.3$	6.0	0 -0.4	14.0	$\pm 0.2$	10.6	$\pm 0.2$	4.0	$\pm 0.1$
E I 2-22		$\pm 0.4$		$\pm 0.4$		0 -0.5		$\pm 0.3$		$\pm 0.3$		$\pm 0.2$
E I 1-19	19.0	$\pm 0.2$	15.8	$\pm 0.3$	4.7	0 -0.4	14.5	$\pm 0.2$	11.0	$\pm 0.2$	2.4	$\pm 0.1$
E I 2-19		$\pm 0.3$		$\pm 0.4$		0 -0.3		$\pm 0.3$		$\pm 0.3$		$\pm 0.2$
E I 1-16	16.0	$\pm 0.2$	14.0	$\pm 0.3$	4.0	0 -0.3	12.0	$\pm 0.2$	10.0	$\pm 0.2$	2.0	$\pm 0.1$
E I 2-16		$\pm 0.3$		$\pm 0.4$		0 -0.4		$\pm 0.3$		$\pm 0.3$		$\pm 0.2$
E I 1-12	12.0	$\pm 0.2$	9.6	$\pm 0.2$	3.0	0 -0.2	8.0	$\pm 0.2$	5.6	$\pm 0.2$	2.0	$\pm 0.1$
E I 2-12		$\pm 0.3$		$\pm 0.3$		0 -0.4		$\pm 0.3$		$\pm 0.3$		$\pm 0.2$

ભાગ ૧ ની કાગળ

Gauge				Diameter		Sectional area			Copper wire weight	
B.W.G.	A.W.G.	S.W.G.	mm.G.	mil	mm	cir. mil	in <sup>2</sup>	mm <sup>2</sup>	lb/1,000ft	kg/km
11	-	-	-	120	3.048	14,400	.01131	7.297	43.59	64.87
-	-	11	-	116	2.946	13,456	.01057	6.818	40.74	60.61
-	9	-	-	114.4	2.906	13,087	.01028	6.632	39.62	59.96
-	-	-	2.9	114.2	2.900	13,042	.01024	6.605	39.47	58.72
12	-	-	-	109	2.769	11,880	.009331	6.020	35.96	53.52
-	-	12	-	104	2.642	10,816	.008495	5.481	32.74	48.73
-	-	-	2.6	102.4	2.600	10,486	.008246	5.309	31.78	47.29
-	10	-	-	101.9	2.588	10,384	.008156	5.262	31.43	46.78
-	-	-	-	95	2.413	9,025	.007088	4.573	27.32	40.65
13	-	13	-	92	2.337	8,464	.006648	4.289	25.62	38.13
-	11	-	-	90.75	2.305	8,234	.006467	4.172	24.92	37.09
-	-	-	2.3	90.54	2.300	8,199	.0063439	4.155	24.82	36.94
-	-	-	-	83	2.108	6,889	.005411	3.491	20.85	31.04
14	-	-	-	80.81	2.053	6,530	.005129	3.309	19.77	29.42
-	12	-	-	80	2.032	6,400	.005027	3.243	19.37	28.83
-	-	14	-	-	-	-	-	-	-	-
-	-	-	2.0	78.74	2.000	6,200	.004869	3.142	18.77	27.93
15	-	15	-	72	1.829	5,184	.004072	2.627	18.77	27.93
-	13	-	-	71.96	1.828	5,178	.004067	2.624	15.67	23.33
-	-	-	1.8	70.87	1.800	5,023	.003945	2.545	15.20	22.63
16	-	-	-	65	1.651	4,225	.003318	2.141	12.79	19.03
-	14	-	-	64.08	1.628	4,106	.003225	2.091	12.43	18.50
-	-	16	-	64	1.626	4,096	.003217	2.075	12.40	18.45
-	-	-	1.6	62.99	1.600	3,968	.003116	2.011	12.01	17.83
17	-	-	-	58	1.473	3,364	.002642	1.705	10.18	15.16
-	15	-	-	57.07	1.450	3,257	.002558	1.650	9.859	14.67
-	-	17	-	56	1.422	3,136	.002463	1.589	9.493	14.13
-	-	-	1.4	55.12	1.400	3,038	.002386	1.539	9.196	13.68
-	16	-	-	50.82	1.291	2,593	.002029	1.309	7.820	11.64
18	-	-	-	49	1.245	2,401	.001856	1.217	7.269	10.82
-	-	18	-	48	1.219	2,304	.001810	1.167	6.976	10.38
-	-	-	1.2	47.24	1.200	2,232	.001753	1.131	6.756	10.05
-	17	-	-	45.26	1.150	2,048	.001608	1.037	6.197	9.219
19	-	-	-	42	1.067	1,764	.001385	0.8938	5.388	7.946
-	18	-	-	40.30	1.024	1,624	.001275	0.8226	4.914	7.313
-	-	19	-	40	1.016	1,600	.001257	0.8107	4.845	7.207
-	-	-	1.0	39.37	1.000	1,550	.001217	0.7854	4.690	6.982
-	-	20	-	36	0.9144	1,296	.001018	0.6576	3.923	5.838
-	19	-	-	35.89	0.9116	1,288	.001012	0.6529	3.900	5.804
-	-	-	9.0	35.43	0.9000	1,255	.0009857	0.6362	3.799	5.656
20	-	-	-	35	0.8890	1,225	.0009621	0.6207	3.708	5.518
-	-	21	-	32	0.8128	1,024	.0008042	0.5189	3.099	4.613
-	20	-	-	31.96	0.8118	1,021	.0008019	0.5174	3.091	4.600
-	-	-	8.0	31.50	0.8000	992.3	.0007794	0.5027	3.004	4.489
-	21	-	-	28.46	0.7229	810	.0006362	0.4105	2.452	3.649
22	-	22	-	28	0.7112	784	.0006158	0.3973	2.373	3.532
-	-	-	7.0	27.56	0.7000	759.6	.0005966	0.3848	2.299	3.421
-	-	-	6.5	25.59	0.6500	654.8	.0005143	0.3318	1.982	2.950
-	22	-	-	25.35	0.6438	642.6	.0005047	0.3256	1.945	2.895
-	-	-	-	25	0.6350	625	.0004909	0.3167	1.892	2.816
23	-	23	-	24	0.6096	576	.0004524	0.2919	1.744	2.595
-	-	-	6.0	23.62	0.6000	557.9	.0004382	0.2827	1.689	2.513
-	23	-	-	22.57	0.5733	509.4	.0004001	0.2581	1.542	2.295
24	-	24	-	22	0.5583	484	.0003801	0.2452	1.465	2.180
-	-	-	5.5	21.65	0.5500	468.7	.0003681	0.2376	1.419	2.112
-	24	-	-	20.10	0.5105	404	.0003173	0.2047	1.223	1.820



ประวัติผู้ทำการวิจัย

นาย มานะ ภัทรกุลพงษ์ เกิดวันที่ 17 เมษายน พ.ศ. 2494  
 อำเภอ เมือง จังหวัด สงขลา วุฒิการศึกษา วิศวกรรมศาสตรบัณฑิต สาขา  
 วิศวกรรมไฟฟ้า จากจุฬาลงกรณ์มหาวิทยาลัย ปี พ.ศ. 2517 มีประสบการณ์ทำ  
 งานที่การไฟฟ้าส่วนภูมิภาค 2ปี และเป็นอาจารย์ตรีแผนกวิชาการสื่อสารมวลชน  
 คณะนิเทศศาสตร์ จุฬาลงกรณ์มหาวิทยาลัย เป็นเวลา 3 ปี