

MICROSCOPIC, MOLECULAR AND CROCINS CONTENT EVALUATIONS OF SELECTED  
*GARDENIA* SPECIES IN THAILAND



บทคัดย่อและแฟ้มข้อมูลฉบับเต็มของวิทยานิพนธ์ตั้งแต่ปีการศึกษา 2554 ที่ให้บริการในคลังปัญญาจุฬาฯ (CUIR)  
เป็นแฟ้มข้อมูลของนิสิตเจ้าของวิทยานิพนธ์ ที่ส่งผ่านทางบัณฑิตวิทยาลัย

The abstract and full text of theses from the academic year 2011 in Chulalongkorn University Intellectual Repository (CUIR)  
are the thesis authors' files submitted through the University Graduate School.

A Dissertation Submitted in Partial Fulfillment of the Requirements  
for the Degree of Doctor of Philosophy Program in Public Health Sciences

College of Public Health Sciences

Chulalongkorn University

Academic Year 2015

Copyright of Chulalongkorn University

การประเมินลักษณะทางจุลทรรศน์ อณูโมเลกุลและปริมาณสารโครซินของพืชสกุลพุทบางชนิดใน  
ประเทศไทย



วิทยานิพนธ์นี้เป็นส่วนหนึ่งของการศึกษาตามหลักสูตรปริญญาวิทยาศาสตรดุษฎีบัณฑิต

สาขาวิชาวิทยาศาสตร์สาธารณสุข

วิทยาลัยวิทยาศาสตร์สาธารณสุข จุฬาลงกรณ์มหาวิทยาลัย

ปีการศึกษา 2558

ลิขสิทธิ์ของจุฬาลงกรณ์มหาวิทยาลัย

Thesis Title	MICROSCOPIC, MOLECULAR AND CROCINS CONTENT EVALUATIONS OF SELECTED <i>GARDENIA</i> SPECIES IN THAILAND
By	Miss Onuma Zongrum
Field of Study	Public Health Sciences
Thesis Advisor	Assistant Professor Kanchana Rungsihirunrat, Ph.D.
Thesis Co-Advisor	Associate Professor Nijsiri Ruangrunsi, Ph.D.

---

Accepted by the College of Public Health Sciences, Chulalongkorn  
University in Partial Fulfillment of the Requirements for the Doctoral Degree

.....Dean of the College of Public Health Sciences  
(Professor Sathirakorn Pongpanich, Ph.D.)

THESIS COMMITTEE

.....Chairman  
(Professor Surasak Taneepanichskul, M.D.)

.....Thesis Advisor  
(Assistant Professor Kanchana Rungsihirunrat, Ph.D.)

.....Thesis Co-Advisor  
(Associate Professor Nijsiri Ruangrunsi, Ph.D.)

.....Examiner  
(Assistant Professor Chanida Palanuvej, Ph.D.)

.....Examiner  
(Tepanata Pumpaibool, Ph.D.)

.....External Examiner  
(Piyarat Parinyapong Chareonsap, Ph.D.)

อรอุมา ของรัมย์ : การประเมินลักษณะทางจุลทรรศน์ อนุโมเลกุลและปริมาณสารโครซินของพืชสกุลพุดบางชนิดในประเทศไทย (MICROSCOPIC, MOLECULAR AND CROCINS CONTENT EVALUATIONS OF SELECTED *GARDENIA* SPECIES IN THAILAND) อ.ที่ปรึกษาวิทยานิพนธ์หลัก: ผศ. ดร. กาญจนา รังษีหิรัญรัตน์, อ.ที่ปรึกษาวิทยานิพนธ์ร่วม: รศ. ดร. นิจศิริ เรืองรังษี, 190 หน้า.

พืชสกุลพุด (*Gardenia*) มีการใช้แพร่หลายทั้งเป็นไม้ประดับและใช้ในทางการแพทย์ นอกจากนี้มีการนำผลพุดซ้อน (*G. jasminoides*) มาใช้ในระบบสุขภาพแบบดั้งเดิม โดยโครซินเป็นสารสำคัญหลักที่พบในผลพุดซ้อน เนื่องจากยังไม่มีรายงานข้อมูลทางวิทยาศาสตร์ทั้งทางด้านลักษณะทางจุลทรรศน์ อนุโมเลกุล รวมทั้งการวิเคราะห์ปริมาณสารโครซินในพืชชนิดนี้ ดังนั้นการศึกษานี้มีวัตถุประสงค์เพื่อที่จะประเมินลักษณะทางจุลทรรศน์ อนุโมเลกุล และปริมาณสารโครซินของพืชสกุลพุดบางชนิดในประเทศไทย ทำการประเมินภาคตัดขวางเส้นกลางใบและค่าคงที่ของใบ (จำนวนปากใบ ค่าดัชนีปากใบ ค่าอัตราส่วนเซลล์รั้ว ค่าพื้นที่เซลล์ผิว และจำนวนขน) ในพืชสกุลพุดจำนวน 11 ชนิด ภายใต้กล้องจุลทรรศน์ การประเมินลักษณะทางอนุโมเลกุลโดยใช้ลายพิมพ์ดีเอ็นเอชนิดอาร์เอพีดีและการประเมินเอกลักษณ์ทางเภสัชเวชและการหาปริมาณสารโครซินด้วยวิธียูวี/วิสิเบิล สเปกโตรโฟโตเมทรีของผลพุดซ้อน ผลการศึกษาพบว่า ค่าคงที่ของใบแสดงเอกลักษณ์ของลักษณะทางจุลทรรศน์ของพืชสกุลพุดแต่ละชนิด ลายพิมพ์ดีเอ็นเอชนิดอาร์เอพีดีที่พัฒนาจากไพรเมอร์ จำนวน 20 ชนิด ให้แถบดีเอ็นเอ จำนวน 573 แถบ ซึ่งในจำนวนนี้เป็นแถบดีเอ็นเอที่มีลักษณะแตกต่างกันถึงร้อยละ 99.5 ค่าสัมประสิทธิ์ความเหมือนทางพันธุกรรม มีค่าอยู่ในช่วงระหว่าง 0.089 ถึง 0.332 และสามารถจัดกลุ่มทางพันธุกรรมได้เป็น 2 กลุ่มใหญ่ ด้วยวิธี UPGMA นอกจากนี้ลายพิมพ์ดีเอ็นเอชนิดอาร์เอพีดีนี้สามารถใช้ในการประเมินเอกลักษณ์ของพืชสกุลพุดทั้ง 11 ชนิดได้ ผลการศึกษาเอกลักษณ์ทางเภสัชเวชของผลพุดซ้อน พบว่า มีปริมาณเถ้ารวม ปริมาณเถ้าที่ไม่ละลายในกรด น้ำหนักที่หายไปเมื่อทำให้แห้ง และปริมาณน้ำ ไม่ควรเกินร้อยละ 4.9, 0.7, 8.8 และ 10.0 ของน้ำหนักแห้งตามลำดับ ปริมาณสารสกัดด้วยน้ำและเอทานอล ไม่ควรน้อยกว่าร้อยละ 26.9 และ 22.5 ของน้ำหนักแห้งตามลำดับ ในการวิเคราะห์หาปริมาณสารโครซินด้วยวิธียูวี/วิสิเบิล สเปกโตรโฟโตเมทรี ได้มีการทดสอบความถูกต้องของวิธีวิเคราะห์ตามข้อกำหนดแนวทาง ICH ผลการทดสอบค่าความเป็นเส้นตรง ความถูกต้อง ความเที่ยงตรง และความคงทนของวิธีวิเคราะห์ ได้กราฟมาตรฐานในช่วงความเป็นเส้นตรงของความเข้มข้นระหว่าง 5-100 ไมโครกรัมต่อมิลลิกรัม และปริมาณสารโครซินที่พบในผลพุดซ้อนมีค่าเฉลี่ย เท่ากับ 7.55 มิลลิกรัมต่อกรัมของน้ำหนักแห้ง โดยสรุปผลที่ได้จากการศึกษาลักษณะทางจุลทรรศน์ อนุโมเลกุล และปริมาณสารโครซินของพืชสกุลพุด สามารถที่จะนำไปประยุกต์ใช้สำหรับการพิสูจน์เอกลักษณ์และการกำหนดมาตรฐานของพืชสกุลพุดและผลพุดซ้อนได้

สาขาวิชา วิทยาศาสตร์สาธารณสุข

ปีการศึกษา 2558

ลายมือชื่อนิสิต .....

ลายมือชื่อ อ.ที่ปรึกษาหลัก .....

ลายมือชื่อ อ.ที่ปรึกษาร่วม .....

# # 5379403053 : MAJOR PUBLIC HEALTH SCIENCES

KEYWORDS: GARDENIA / CROCIN / RAPD / UV SPECTROPHOTOMETRY / PHARMACOGNOSTIC

ONUMA ZONGRUM: MICROSCOPIC, MOLECULAR AND CROCINS CONTENT EVALUATIONS OF SELECTED *GARDENIA* SPECIES IN THAILAND. ADVISOR: ASST. PROF. KANCHANA RUNGSIHIRUNRAT, Ph.D., CO-ADVISOR: ASSOC. PROF. NIJSIRI RUANGRUNGSI, Ph.D., 190 pp.

*Gardenia* species have been used worldwide for ornamentation and medicinal purpose. Additionally, the fruit of *Gardenia jasminoides* is also used in traditional health systems. Crocin is the major constituent found in the fruit of *G. jasminoides*. Due to the scientific data of microscopic, molecular characteristics including the crocin content have never been reported, this study aimed to evaluate microscopic, molecular characteristics as well as the crocin content of selected *Gardenia* species in Thailand. Midrib transverse section and the constant values of leaves (stomatal number, stomatal index, palisade ratio, epidermal cell area and trichome number) from eleven *Gardenia* species were evaluated under microscope. RAPD fingerprint was also performed for their genetic assessment. Pharmacognostic parameters and crocin content were evaluated from *G. jasminoides* fruits. The results indicated that leaf measurement showed individual microscopic characteristics. RAPD fingerprint obtained from 20 primers generated 573 reproducible bands of which 99.5% were polymorphism bands. Similarity index ranged from 0.089 to 0.332. A dendrogram was constructed using the unweighted pair-group method with arithmetic averages (UPGMA) and can be divided into 2 distinct clusters. Moreover, RAPD fingerprint developed by selected primers can be used to identify eleven *Gardenia* species. Pharmacognostic parameters of *G. jasminoides* fruit revealed that the total ash, acid insoluble ash, loss on drying and moisture content should be not more than 4.9, 0.7, 8.8 and 10.0 % while water and ethanol soluble extractive values should be not less than 26.9 and 22.5 % of dry weight respectively. UV/Visible spectrophotometric method was developed and validated for determination of crocin content based on International Conference of Harmonization (ICH) guideline. This method was linear in the range between 5 and 100 µg/ml and exhibited suitable accuracy, precision and robustness. The crocin content in *G. jasminoides* fruits was 7.55 mg/g of dried crude drug. In conclusion, microscopic, molecular characteristics including the crocin content evaluation from this study could be applied for assessing the identification and standardization of *Gardenia* species and *G. jasminoides* fruits as well.

Field of Study: Public Health Sciences

Academic Year: 2015

Student's Signature .....

Advisor's Signature .....

Co-Advisor's Signature .....

## ACKNOWLEDGEMENTS

I wish to express my grateful thanks to my thesis advisor, Assist. Prof. Dr. Kanchana Rungsihirunrat and the thesis co-advisor, Assoc. Prof. Dr. Nijisiri Ruangrungsi for all useful guidance, valuable suggestion and encouragement throughout the study.

I would like to thank the chairman of thesis committee, Prof. Dr. Surasak Taneepanichskul, and the thesis committee, Asst. Prof. Dr. Chanida Palanuvej and Dr. Tepanata Pumpaibool and Dr. Piyarat Parinyapong Chareonsap for their critical perusal and value advice.

I would like to acknowledge the 90th anniversary of Chulalongkorn University fund (Ratchadaphiseksomphot Endowment Fund) and College of Public Sciences, Chulalongkorn University, for financial support.

I would like to thank all staff members in College of Public Sciences, Chulalongkorn University for kindness and friendship.

Finally which is the most important, I would like to express all my love and gratitude to my family for their understanding, encouragement and supporting for concentration my study.

## CONTENTS

	Page
THAI ABSTRACT .....	iv
ENGLISH ABSTRACT .....	v
ACKNOWLEDGEMENTS .....	vi
CONTENTS .....	vii
LIST OF TABLES .....	xi
LIST OF FIGURES .....	xiii
LIST OF ABBREVIATIONS .....	xvii
CHAPTER I INTRODUCTION .....	1
1.1 Background and rationale.....	1
1.2 Research questions.....	5
1.3 Objectives .....	5
1.4 Benefits and applications .....	6
1.5 Scope of study.....	7
CHAPTER II RELATED LITERATURE REVIEW .....	8
2.1 <i>Gardenia</i> species .....	8
2.1.1 Scientific classification of <i>Gardenia</i> spp.....	9
2.1.2 Eleven species of <i>Gardenia</i> under examination .....	10
2.2 Fruit of <i>G. jasminoides</i> .....	18
2.2.1 Plant description of <i>G. jasminoides</i> fruit.....	18
2.2.2 Traditional uses of <i>G. jasminoides</i> fruit.....	19
2.2.3 Crocin .....	20
2.3 Pharmacognostic study.....	22

	Page
2.3.1 Macroscopic study.....	22
2.3.2 Microscopic study.....	23
2.3.3 Physicochemical analysis.....	30
2.3.4 Thin layer chromatographic fingerprint.....	36
2.4 Molecular analysis.....	38
2.4.1 DNA extraction method.....	38
2.4.2 Random amplified polymorphic DNA analysis.....	39
2.5 Extraction methods of chemical constituents from plants.....	44
2.5.1 Soxhlet extraction.....	44
2.6 UV spectrophotometric measurement.....	45
2.7 Method validation.....	49
2.8 Previous studies of <i>Gardenia</i> species.....	52
CHAPTER III MATERIALS AND METHODS.....	54
3.1 Materials.....	54
3.2 Chemicals and reagents.....	54
3.3 Equipments and instruments.....	55
3.4 Plant samples.....	56
3.5 Macroscopical studies.....	58
3.6 Microscopical studies.....	58
3.7 Physicochemical studies.....	63
3.7.1 Determination of ash values.....	63
3.7.2 Determination of extractable matters.....	64
3.7.3 Determination of water and volatile matter.....	65



	Page
3.8 Thin layer chromatographic fingerprint .....	66
3.9 Crocin content analysis.....	67
3.9.1 Extraction of <i>G. jasminoides</i> fruits powder.....	67
3.9.2 Crocin content determination by using UV-Visible spectrophometric method.....	67
3.9.3 Method validation of UV/VIS spectrophometric method .....	68
3.10 Crocin component analysis.....	69
3.11 Molecular analysis .....	70
3.11.1 DNA isolation .....	70
3.11.2 RAPD analysis.....	72
3.11.3 RAPD data analysis .....	73
3.12 Data analysis .....	73
CHAPTER IV RESULTS.....	74
4.1 <i>Gardenia</i> species examination .....	74
4.1.1 Macroscopic evaluation.....	74
4.1.2 Microscopic evaluation.....	86
4.1.3 Molecular analysis .....	106
4.1.4 Specific band for <i>Gardenia</i> species by RAPD analysis .....	111
4.1.5 Genetic relationship of 11 <i>Gardenia</i> species based on RAPD analysis....	112
4.2 <i>Gardenia jasminoides</i> fruit examination .....	115
4.2.1 Standardization.....	116
4.2.2 Crocin content analysis using spectrophotometric method.....	120
CHAPTER V DISCUSSION AND CONCLUSION.....	124

	Page
REFERENCES .....	133
APPENDICES.....	145
APPENDIX A Leaf constant of eleven <i>Gardenia</i> species.....	146
APPENDIX B RAPD fingerprint of eleven <i>Gardenia</i> species .....	169
APPENDIX C Physicochemical parameters of <i>Gardenia jasminoides</i> fruits.....	180
APPENDIX D Method validation of UV <i>Gardenia jasminoides</i> fruits .....	183
VITA.....	190



## LIST OF TABLES

<b>Table 1</b> Pharmacological activities of examined <i>Gardenia</i> species.....	16
<b>Table 2</b> The most common types of leaf stomata.....	25
<b>Table 3</b> Leaf measurement parameters [58-60].....	26
<b>Table 4</b> Comparison of the five most widely used DNA markers in plants [83].....	42
<b>Table 5</b> Source of <i>Gardenia</i> species collection.....	57
<b>Table 6</b> Stomatal number and stomatal index of <i>Gardenia</i> species.....	101
<b>Table 7</b> Epidermal cell number and epidermal cell area of <i>Gardenia</i> species.....	102
<b>Table 8</b> Palisade ratio and trichome number of <i>Gardenia</i> species.....	104
<b>Table 9</b> The list of 20 RAPD primers and the number of amplified bands, size range and percentage of polymorphic bands in 11 <i>Gardenia</i> species .....	109
<b>Table 10</b> Specific band for <i>Gardenia</i> species by RAPD analysis.....	111
<b>Table 11</b> Nei and Li's genetic similarity index among eleven <i>Gardenia</i> species based on the RAPD markers.....	113
<b>Table 12</b> Physicochemical parameters analysis of <i>G. jasminoides</i> fruit.....	118
<b>Table 13</b> Yield of ethanolic extract by soxhlet extraction and crocin content by UV/visible spectrophotometry of <i>G. jasminoides</i> fruits.....	120
<b>Table 14</b> The validities of quantitative analysis of crocin in <i>G. jasminoides</i> fruits using spectrophotometric method.....	121
<b>Table 15</b> Crocin components of 12 <i>G. jasminoides</i> fruit extracts using TLC densitometry .....	123
<b>Table 16</b> Leaf constant of <i>Gardenia carinata</i> .....	147
<b>Table 17</b> Leaf constant of <i>Gardenia tubifera</i> .....	149
<b>Table 18</b> Leaf constant of <i>Gardenia lineata</i> .....	151

<b>Table 19</b>	Leaf constant of <i>Gardenia taitensis</i> .....	153
<b>Table 20</b>	Leaf constant of <i>Gardenia thailandica</i> .....	155
<b>Table 21</b>	Leaf constant of <i>Gardenia griffithii</i> .....	157
<b>Table 22</b>	Leaf constant of <i>Gardenia collinsae</i> .....	159
<b>Table 23</b>	Leaf constant of <i>Gardenia obtusifolia</i> .....	161
<b>Table 24</b>	Leaf constant of <i>Gardenia jasminoides</i> .....	163
<b>Table 25</b>	Leaf constant of <i>Gardenia vietnamensis</i> .....	165
<b>Table 26</b>	Leaf constant of <i>Gardenia sootepensis</i> .....	167
<b>Table 27</b>	Physicochemical parameters of <i>Gardenia jasminoides</i> fruits.....	181
<b>Table 28</b>	Calibration curve data for crocin.....	185
<b>Table 29</b>	Results of recovery studies.....	186
<b>Table 30</b>	Results of repeatability study.....	187
<b>Table 31</b>	Results of intermediate precision.....	188
<b>Table 32</b>	Result of robustness study.....	189

## LIST OF FIGURES

<b>Figure 1</b> Conceptual framework of the study.....	7
<b>Figure 2</b> Picture of <i>Gardenia jasminoides</i> : flower (a); ripened fruit (b); dried fruits (c) and seeds (d) .....	19
<b>Figure 3</b> Chemical structure of crocin .....	21
<b>Figure 4</b> Chemical structure of crocin-1, crocin-2, crocin-3, crocin-4, and crocin-5.....	21
<b>Figure 5</b> Four types of stomata based on arrangement of subsidiary cells in plant: anomocytic type (a), anisocytic type (b), diacytic type (c), paracytic type (d) ..	25
<b>Figure 6</b> Four upper continuous epidermal cells with underlying palisade cells in surface view .....	28
<b>Figure 7</b> Apparatus for azeotropic distillation used for water content determination (dimensions in mm) .....	35
<b>Figure 8</b> Clevenger apparatus used for volatile oil content determination (dimensions in mm).....	36
<b>Figure 9</b> The principle of RAPD-PCR technique [80]. Arrows indicate primer annealing sites.....	40
<b>Figure 10</b> Schematic diagram of Soxhlet extraction apparatus .....	45
<b>Figure 11</b> Beer's law-absorption of radiation.....	47
<b>Figure 12</b> Schematic view of a spectrophotometer .....	48
<b>Figure 13</b> Branch of <i>Gardenia carinata</i> Wall. Ex Roxb. ....	75
<b>Figure 14</b> Branch of <i>Gardenia collinsae</i> Craib .....	76
<b>Figure 15</b> Branch of <i>Gardenia griffithii</i> Hook. f.....	77
<b>Figure 16</b> Branch of <i>Gardenia jasminoides</i> Ellis (a); fruit (b) .....	78
<b>Figure 17</b> Branch of <i>Gardenia lineata</i> (Craib) Tirveng.....	79
<b>Figure 18</b> Branch of <i>Gardenia obtusifolia</i> Roxb. ex Hook. f. ....	80

<b>Figure 19</b> Branch of <i>Gardenia sootepensis</i> Hutch. ....	81
<b>Figure 20</b> Branch of <i>Gardenia thailandica</i> Tirveng.....	82
<b>Figure 21</b> Branch of <i>Gardenia taitensis</i> DC. ....	83
<b>Figure 22</b> Branch of <i>Gardenia tubifera</i> Wall. ....	84
<b>Figure 23</b> Branch of <i>Gardenia vietnamensis</i> .....	85
<b>Figure 24</b> Transverse section of leaf midrib of <i>Gardenia carinata</i> .....	86
<b>Figure 25</b> Transverse section of leaf midrib of <i>Gardenia collinsae</i> .....	87
<b>Figure 26</b> Transverse section of leaf midrib of <i>Gardenia griffithii</i> .....	88
<b>Figure 27</b> Transverse section of leaf midrib of <i>Gardenia jasminoides</i> .....	89
<b>Figure 28</b> Transverse section of leaf midrib of <i>Gardenia lineata</i> .....	90
<b>Figure 29</b> Transverse section of leaf midrib of <i>Gardenia obtusifolia</i> .....	91
<b>Figure 30</b> Transverse section of leaf midrib of <i>Gardenia sootepensis</i> .....	92
<b>Figure 31</b> Transverse section of leaf midrib of <i>Gardenia thailandica</i> .....	93
<b>Figure 32</b> Transverse section of leaf midrib of <i>Gardenia taitensis</i> .....	94
<b>Figure 33</b> Transverse section of leaf midrib of <i>Gardenia tubifera</i> .....	95
<b>Figure 34</b> Transverse section of leaf midrib of <i>Gardenia vietnamensis</i> .....	96
<b>Figure 35</b> Photographs of leaf epidermal cells of eleven <i>Gardenia</i> species.....	98
<b>Figure 36</b> Scanning electron microscope of trichome of <i>Gardenia sootepensis</i> .....	100
<b>Figure 37</b> Photographs of upper epidermal cells of eleven <i>Gardenia</i> species.....	103
<b>Figure 38</b> Photographs of palisade cells of eleven <i>Gardenia</i> species .....	105
<b>Figure 39</b> Genomic DNA of 11 <i>Gardenia</i> species in 1.0% agarose gel electrophoresis.....	107
<b>Figure 40</b> RAPD fingerprints of 11 <i>Gardenia</i> species obtained from (a) OPD-07, (b) OPF-04, (c) OPM-07, (d) OPB-10, and (e) F-25 primers.....	110

<b>Figure 41</b> The genetic relationship based on UPGMA between eleven <i>Gardenia</i> species. The scale indicates the genetic similarities between individual.....	114
<b>Figure 42</b> Crude drug of <i>Gardenia jasminoides</i> Ellis fruits.....	115
<b>Figure 43</b> Transverse section of the dried fruit of <i>Gardenia jasminoides</i> Ellis; seed (a), pericarp (b).....	115
<b>Figure 44</b> Microscopic characters of powdered <i>Gardenia jasminoides</i> fruit.....	117
<b>Figure 45</b> TLC fingerprint profile of <i>G. jasminoides</i> fruit under UV light 366 nm (a), under UV light 254 nm (b), under daylight after spray with p-anisaldehyde reagent (c), under daylight (d).....	119
<b>Figure 46</b> TLC chromatogram of crocin components from <i>G. jasminoides</i> fruit extracts .....	123
<b>Figure 47</b> RAPD fingerprints of 11 <i>Gardenia</i> species obtained from OPB-04 (a), and A-29 primers (b).....	170
<b>Figure 48</b> RAPD fingerprints of 11 <i>Gardenia</i> species obtained from OPB-10 (a), and OPC-04 primers (b). .....	171
<b>Figure 49</b> RAPD fingerprints of 11 <i>Gardenia</i> species obtained from OPC-06 (a), and OPC-08 primers (b). .....	172
<b>Figure 50</b> RAPD fingerprints of 11 <i>Gardenia</i> species obtained from OPC-12 (a), and OPC-20 primers (b).. .....	173
<b>Figure 51</b> RAPD fingerprints of 11 <i>Gardenia</i> species obtained from OPF-07 (a), and OPF-25 primers (b).....	174
<b>Figure 52</b> RAPD fingerprints of 11 <i>Gardenia</i> species obtained from OPF-29 (a), and OPF-04 primers (b). .....	175
<b>Figure 53</b> RAPD fingerprints of 11 <i>Gardenia</i> species obtained from OPL-05 (a), and OPM-07 primers (b). .....	176
<b>Figure 54</b> RAPD fingerprints of 11 <i>Gardenia</i> species obtained from OPL-01 (a), and OPA-04 primers (b). .....	177

<b>Figure 55</b> RAPD fingerprints of 11 <i>Gardenia</i> species obtained from OPD-07 (a), and OPN-16 primers (b).....	178
<b>Figure 56</b> RAPD fingerprints of 11 <i>Gardenia</i> species obtained from RAPD-02 (a), and RAPD-07 primers (b)..	179
<b>Figure 57</b> UV Spectrum of standard crocin in methanol .....	184
<b>Figure 58</b> Calibration curve of standard crocin in methanol at 434 nm (5-100 µg/ml).....	185





## LIST OF ABBREVIATIONS

A, T, C, G	nucleotide containing the base adenine, thymine, cytosine, and guanine, respectively
bp	base pair
°C	degree Celsius
CTAB	cetyl trimethyl ammonium bromide
cm	centimeter
DNA	deoxyribonucleic acid
dNTP	deoxyribonucleotide triphosphates (dATP, dTTP, dGTP, dCTP)
EDTA	ethylenediaminetetraacetic acid
g	gram
ICH	International Conference on Harmonization
kg	kilogram
L	Liter
LOD	Limit of detection
LOQ	Limit of quantification
M	molar
mg	milligram
MgCl <sub>2</sub>	magnesium chloride
ml	milliliter
mm	millimeter
mM	millimolar

mm <sup>2</sup>	square millimeter
μl	microlitre
μm	micrometer
μM	micromolar
μg	microgram
ng	nanogram
nm	nanometer
OD	optical density
PCR	polymerase chain reaction
rpm	round per minute
RAPD	random amplified polymorphic DNA
SD	standard deviation
SI	similarity index
sp./spp.	Species
<i>Taq</i>	<i>Thermus aquaticus</i>
TBE buffer	Tris-boric and EDTA buffer
TE	Tris-EDTA buffer
TLC	Thin-layer chromatography
Tris	Tris (hydroxymethyl) aminomethane
Tris-HCl	Tris-hydrochloride buffer
UPGMG	Unweighted pair group method with arithmetic average
UV	Ultraviolet
v/v	Volume by volum

## CHAPTER I

### INTRODUCTION

#### 1.1 Background and rationale

Plants have long been used in many traditional health systems to maintain and increase health physically, health mentally and health spiritually as well as to treat specific conditions and diseases in human throughout the world. It is estimated that about 35,000 species of higher plants (1 in 6 of all 240,000 species) have been used for medicinal purposes [1] but most of them have not been scientifically investigated [2].

Medicinal plant is defined as a plant that contain properties or compounds that can be used for therapeutic purposes or metabolites synthesis to produce useful drugs [3]. Medicinal plants have been the important source of medicinal substances for primary health care [4]. World Health Organization (WHO) recommends, encourages, promotes and supports the use of traditional medicines because of their availability and affordability [5, 6]. The use of medicinal plants is increasing in both of developing and developed countries, related to the persistence and sometimes expansion of traditional medicine and a growing interest in herbal treatments. Therefore, standardization of medicinal plants is necessary for quality control and quality assurance [4].

Plant in the genus *Gardenia* is one of the important medicinal plants. It has high medicinal value and commercial importance which has been used as alternative medicine in various parts of the world for thousand years for the treatment of various ailments such as fever, hypertension, jaundice and ulcer of skin [7, 8]. *Gardenia* is a genus of flowering plant in the family Rubiaceae containing about 250 species, indigenous to the tropical and subtropical regions of Africa, Asia, Madagascar and Pacific islands [9, 10]. In Thailand, twenty-two species of *Gardenia* have been recorded which of these thirteen species are native to Thailand [11, 12]. The *Gardenia* species have been reported for a wide range of their pharmacological activities such as anti-inflammatory, anti-cancer, anti-HIV, anti-apoptotic, anti-topoisomerase II $\alpha$ , antiangiogenic, and thrombolytic activity [7, 13-20].

Because of medicinal importance of *Gardenia* species, the identity, purity, safety and quality of these plant materials should be established. Standardization is an important tool, one of the simplest and the economical methods is microscopic investigation [21]. Microscopic study of the leaf of many plant species can identify the plant materials [21]. Leaf constants such as stomatal number, stomatal index and palisade ratio are also obtained from microscopic studies that values are equally important in the identification of crude drugs as well as in the evaluation of purity of drugs [21]. Until now, no previous studies have been reported on the leaf constants of any *Gardenia* species.

The other important tools for the investigation of plant materials is DNA-based markers. The DNA-based markers are widely used for authentication and quality assurance of medicinal plant species due to the genetic information of each species is unique and not dependent on age, physiological conditions and environmental factors [22]. Various DNA markers have been applied for studying the genetic relationship of medicinal plant including restriction fragment length polymorphism (RFLP), amplified fragment length polymorphism (AFLP), random amplified polymorphic DNA (RAPD), simple sequence repeat (SSR), inter-simple sequence repeat (ISSR), single nucleotide polymorphisms (SNPs) which each technique has their advantages and drawbacks. RAPD is one of the most frequently used method in the studies of many organisms including medicinal plants due to its rapidity, simplicity and absence of any needs for prior genetic information of the plant [23, 24]. RAPD markers have been used for evaluation of genetic diversity, molecular characterization as well as authentication of plant species such as *Urtica parviflora* Roxb. [24], *Piper nigrum* (L.) [25], *Terminalia bellirica* (Roxb.) [26], *Phyllanthus* species [27]. At present, the study on genetic characteristics of *Gardenia species* are limited.

Besides the *Gardenia* species, the fruit of *Gardenia jasminoides* Ellis is also used in traditional medicine which exhibited various biological activities for the treatment of inflammation, jaundice, headache, edema, fever, hepatitis and hypertension [28]. The gardenia fruit contain crocin (crocetin di-gentiobiose ester)

which is a water soluble carotenoid, yellow pigment and used as food colorants in oriental countries in products such as noodles and confectioneries [28, 29]. Moreover, the major constitutions such as gardenoside, genipin, geniposide, chlorogenic acid, gentiobioside, crocetin, gardenin, mannitol and beta-sitosterol were also found in *G. jasminoides* fruit [30].

Various analytical methods such as, UV/visible spectrophotometry, TLC, GC-MS, LC-MS and HPLC have been developed for quantitative analysis of crocin content from saffron stigmas [31, 32]. but crocin content analysis from *G. jasminoides* fruits using UV/visible spectrophotometry which is a rapid, simple, economic, accurate and reproducible method has not been established [31].

Despite the medicinal and scientific importance of *Gardenia* species and *G. jasminoides* fruit, genetic information of this genus is still limited and basic information on the standardization parameters of this plant is unavailable. Therefore, eleven *Gardenia* species in Thailand namely *Gardenia carinata* Wall. Ex Roxb., *Gardenia collinsae* Craib, *Gardenia griffithii* Hook. f., *Gardenia jasminoides* Ellis, *Gardenia lineata* (Craib) Triveng., *Gardenia obtusifolia* Roxb. ex Hook. f., *Gardenia sootepensis* Hutch., *Gardenia taitensis* DC., *Gardenia thailandica* Tirveng., *Gardenia tubifera* Wall., *Gardenia vietnamensis* were selected for studying on macroscopic, microscopic evaluation and molecular analysis. Furthermore, pharmacognostic parameters and crocin content in *Gardenia jasminoides* fruit were also determined.

## 1.2 Research questions

1.2.1 Can microscopic evaluation be used for identification of eleven selected *Gardenia* species in Thailand?

1.2.2 Can RAPD technique be used for identification of eleven selected *Gardenia* species in Thailand?

1.2.3 Can UV/Visible spectrophotometry method used to evaluate crocin content in *Gardenia jasminoides* fruits?

## 1.3 Objectives

1.3.1 To evaluate microscopic characteristics of eleven selected *Gardenia* species in Thailand and *Gardenia jasminoides* fruits.

1.3.2 To evaluate molecular characteristics of eleven selected *Gardenia* species in Thailand using random amplified polymorphic DNA techniques.

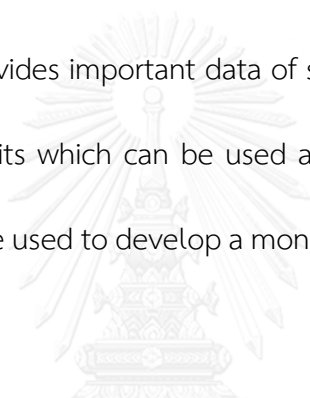
1.3.3 To evaluate crocin content in *Gardenia jasminoides* fruit by UV/Visible spectrophotometric method.

## 1.4 Benefits and applications

1.4.1 This study provides an important scientific data of microscopic and molecular characteristics of eleven selected *Gardenia* species in Thailand.

1.4.2 The scientific information of microscopic and molecular characteristics of eleven selected *Gardenia* species from this study can be applied for the identification and authentication of these plant species for herbal usage.

1.4.3 The study provides important data of standardization and crocin content of the *G. jasminoides* fruits which can be used as a tool for the quality control of crude drugs and also can be used to develop a monograph for the proper identification of the plant materials.





## 1.5 Scope of study

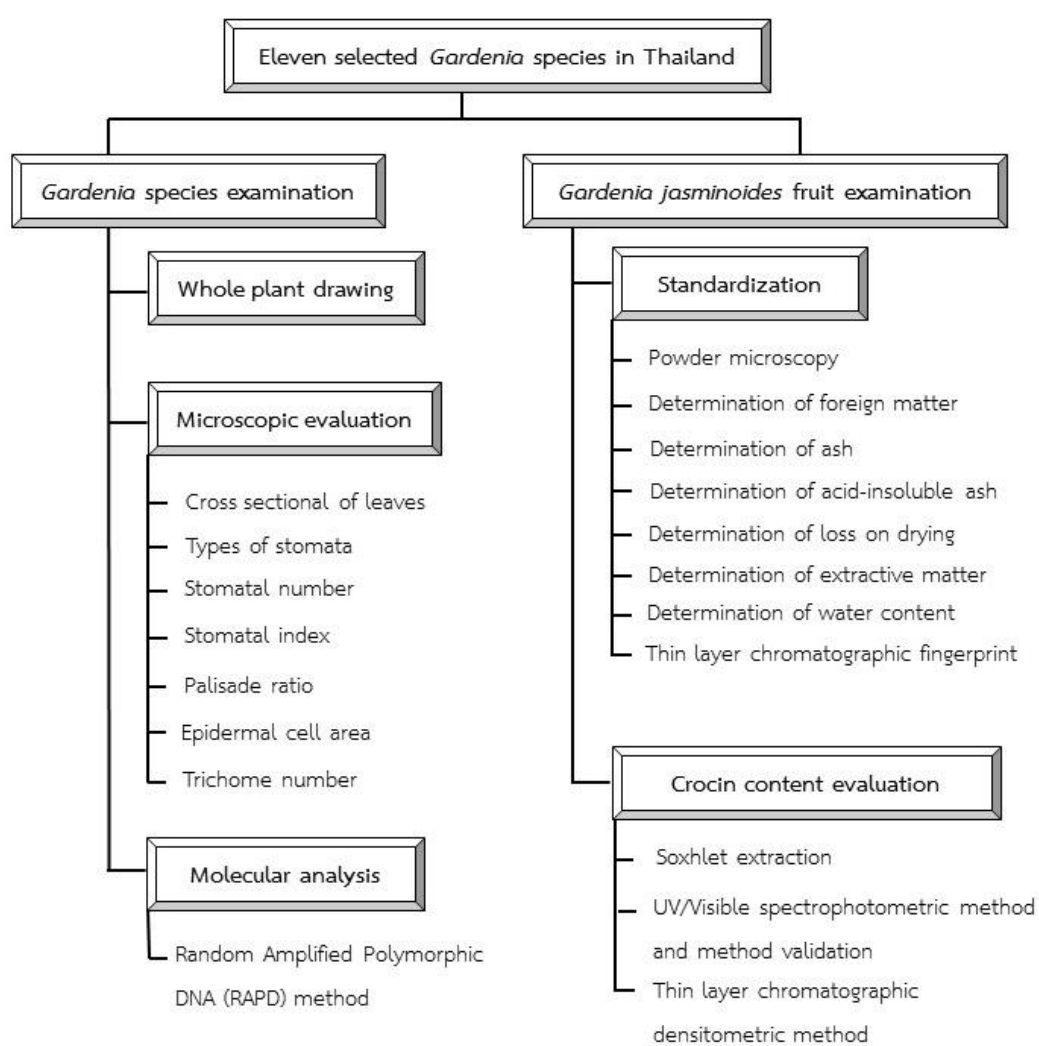


Figure 1 Conceptual framework of the study

## CHAPTER II

### RELATED LITTERATURE REVIEW

This chapter presents the related literature which covers the scope of this study including eleven species of *Gardenia*, *Gardenia jasminoides* fruit, crocin, pharmacognostic study of medicinal plants, RAPD analysis, soxhlet extraction, UV spectrophotometric method, and method validation in order to fully understand and for better comprehension of the study.

#### 2.1 *Gardenia* species

The genus *Gardenia* is a member of Rubiaceae family consisting of approximately 250 flowering plant species, native to the tropical and subtropical regions of Africa, Asia, Madagascar and Pacific islands [9, 10]. Twenty-two species of *Gardenia* have been found in Thailand, of these thirteen species are native including *Gardenia carinata* Wall. Ex Roxb., *Gardenia collinsiae* Craib, *Gardenia coronaria* Buch. Ham., *Gardenia elata* Ridl., *Gardenia griffithii* Hook. f., *Gardenia magnifica* Geddes, *Gardenia obtusifolia* Roxb. ex Hook. f., *Gardenia philastrei* Pierre ex Pit., *Gardenia saxatilis* Geddes, *Gardenia sootepensis* Hutch, *Gardenia thailandica* Triveng, *Gardenia truncata* Craib, *Gardenia tubifera* wall. ex Roxb [11, 12].

*Gardenia* species have been used in traditional medicine for treatment of various ailments primarily for the purposes of contraceptive (*G. jasminoides*, *G. jovis-*

*tonantis*, *G. turgida*), and abortifacient (*G. griffithii*) [33] and other uses for the treatment of insomnia (*G. erubescens*) [34], and asthma (*G. ternifolia*) [35]. Some studies have revealed that active ingredients isolated or extracted from these plant species have been shown effective against inflammation, renal failure, metabolic and histological abnormalities in fatty liver disease, fibrosis, thrombosis, acute injuries of lungs, and some types of cancer, viral infections, depressions, and amyloid beta peptide cytotoxicity in Alzheimer's disease as well as anti-implantation, antibacterial, antiulcer, analgesic, diuretic, hypotensive and larvicidal activity [33, 36].

### 2.1.1 Scientific classification of *Gardenia* spp.

Kingdom	Plantae
Subkingdom	Tracheobionta
Superdivision	Spermatophyta
Division	Magnoliophyta
Class	Magnoliopsida
Subclass	Asteridae
Order	Rubiales
Family	Rubiaceae
Genus	<i>Gardenia</i> Ellis

## 2.1.2 Eleven species of *Gardenia* under examination

### 2.1.2.1 Botanical description

#### 2.1.2.1.1 *Gardenia carinata* Wall. Ex Roxb.

Small tree to 7 m tall; leaves thin-leathery obovate or oblanceolate, 10-40 cm long; flowers solitary, in upper axils; calyx tube 1.5 cm long, 5-6 ribbed; corolla golden yellow, the tube 2.5 cm long, the limb 6-7 cm across, 6-9 lobed; fruit ellipsoid, 3-4 cm long, ribbed, crowned with the calyx lobes [37].

#### 2.1.2.1.2 *Gardenia collinsae* Craib

Deciduous tree 7 m, dbh 14 cm; bark thin, outer bark thin, very finely roughened, sparsely lenticellate, brown; flaking and exposing greenish inner bark; calyx and corolla buds green; mature corolla: base of tube light green, tube otherwise and both sides of lobes bright white; anthers cream; stigma pale light orangish; fragrant; leaves new; blades bright green above, light green underneath [38].

#### 2.1.2.1.3 *Gardenia griffithii* Hook. f.

Shrub or small tree, to 7 m tall; leaves obovate, thick-leathery, narrowed at base, 12-20 cm long, nerves 12-13 pairs; flowers solitary, terminal; calyx tubular, 6-8 cm long, the mouth expanded; fruit globose, woody, 4-5 cm across, crowned by the calyx-lobes [37].

#### 2.1.2.1.4 *Gardenia jasminoides* Ellis

Shrubs, 0.3-3 m tall; branches terete to flattened, with internodes developed to shortened, glabrescent or usually densely puberulent to pilosulous, becoming gray to grayish white, with buds resinous and distalmost internodes often covered with resin. Leaves opposite or rarely ternate, subsessile to petiolate; petiole to 0.5(-1) cm, densely puberulent or shortly pilosulous to glabrous; blade drying thinly leathery to stiffly papery, oblong-lanceolate, obovate-oblong, obovate, oblanceolate, or elliptic, 3-25 × 1.5-8 cm, adaxially shiny and glabrous or sometimes puberulent on principal veins, abaxially puberulent or pilosulous to glabrous, base cuneate to acute, apex acute to acuminate or obtuse then abruptly long acuminate; secondary veins 8-15 pairs, in abaxial axils often with pilosulous domatia; stipules calyptrate, cylindrical, 4-13 mm, splitting for ca. 3/4 their length, densely puberulent to glabrous. Flower solitary, terminal; peduncle 1-10 mm, puberulent or pilosulous to glabrous. Calyx puberulent or pilosulous to glabrous; ovary portion obconic or obovoid, 5-8 mm, with (5 or)6(-8) weak to developed longitudinal ridges; limb with basal tubular portion 3-5 mm; lobes (5 or)6(-8), lanceolate or linear-lanceolate to spatulate, 10-30 × 1-4 mm, often strongly keeled, acute. Corolla white to pale yellow, simple or in cultivation sometimes doubled, outside glabrous; tube 30-50 × 4-6 mm, cylindrical, in throat pilose; lobes (5 or)6(-8) or numerous when doubled, obovate or obovate-oblong, 15-40 × 6-28 mm, obtuse to rounded. Fruiting peduncles

apparently not much elongating. Berry yellow or orange-yellow, ovoid, subglobose, or ellipsoid, 1.5-7 × 1.2-2 cm, with 5-9 longitudinal ridges, with persistent calyx lobes to 40 × 6 mm; seeds suborbicular, weakly angled, ca. 3.5 × 3 mm [39].

#### 2.1.2.1.5 *Gardenia lineata* (Craib) Tirveng.

Shrub or dwarf shrub, mostly rheophytic spreading shrub; branches often pseudodichotomous; bark brownish. Leaves simple, opposite decussate or whorled, lanceolate, oblanceolate or elliptic, 7–17 by 2.4–4.5 cm, base attenuate or cuneate, apex acuminate, margin entire, coriaceous, upper surface green, glabrous, lower surface greenish, glabrous; secondary veins 8–11-paired; petioles 6–20 mm long, glabrous. Interpetiolar stipules connate and forming a long sheath, 9–16 mm long, apex acuminate. Inflorescences terminal, consisting of several to few-flowered cymes or uniflorous. Flowers large, ca. 8 cm diam., white. Calyx: tube ca. 10 mm long; lobes 6, lanceolate, 1–1.5 cm long. Corolla: tube 3.5–5.6 cm long; lobes 6, obovate, elliptic or obovate elliptic, 3.2–4 by 1.4–1.8 cm. Stamens 6, inserted in throat, subsessile; anthers linear, ca. 18 mm long. Ovary with 1 locule and numerous ovules; style 40–60 mm long; stigma big, ca. 11 mm long. Fruits globose to ellipsoid, sometimes ridged, berry-like, 2.5–3.5 by 1.2–1.5 cm, with persistent calyx lobes, lanceolate, 10–15 mm long, orange. Seeds numerous [40].

#### 2.1.2.1.6 *Gardenia obtusifolia* Roxb. ex Hook. f.

Deciduous tree, 2.5 m tall, basal diameter 6 cm; bark thin, nearly smooth to sparsely cracked and slightly roughened, grey; branches dark grey; calyx light green; corolla buds pale light green; mature corolla tube light green, turning cream; lobes initially white, rapidly becoming light orange on both sides; anthers tan; stigma/style pale light green; fragrant; old fruits light brown; leaves very immature; blades green above, light green below; old leaves dry, on the ground [38].

#### 2.1.2.1.7 *Gardenia sootepensis* Hutch.

Trees, 7-10 m tall, often with gelatinous secretions; branches with both developed and shortened internodes, somewhat compressed to angled or subterete, densely puberulent, pilosulous, or tomentulose, becoming glabrescent; leaves opposite; petiole 0.6-1.2 cm, puberulent or tomentulose; blade drying papery or thinly leathery, obovate, obovate-elliptic, broadly elliptic, or elliptic-oblong, 7-29 × 3-16 cm, adaxially puberulent or pilosulous to glabrous, abaxially densely tomentose, base rounded to obtuse or cuneate, apex shortly acuminate with tip acute or obtuse; secondary veins 12-20 pairs, in abaxial axils often with densely pilosulous domatia; stipules calyptrate, conical, 0.5-1 cm, sericeous outside, densely puberulent or tomentulose inside, apical portion triangular and caducous, basal portion truncate to broadly rounded and usually persisting with leaves and sometimes becoming hardened. Flowers pseudoaxillary usually near branch apices, solitary;

peduncle 1-1.5 cm, puberulent. Calyx densely puberulent to pilosulous externally; ovary portion ellipsoid, smooth, 5-6 mm; limb spathaceous, 13-15 mm, splitting along one side for 2/3-3/4 of its length, inside sericeous, often viscid or mucilaginous. Corolla yellow or white, salverform; tube 50-70 × 3-5 mm, cylindrical, outside sparsely puberulent, inside glabrous; lobes 5, broadly obovate, 40-50 × 20-30 mm, glabrous on both surfaces, obtuse to acute. Berry ellipsoid or ellipsoid-oblong, 2.5-5.5 × 1.5-3.5 cm, puberulent, smooth or with 5 or 6 longitudinal lines or very weak ridges, leathery to hard; seeds suborbicular, flattened, 3-4 mm in diam., foveolate [39].

#### **2.1.2.1.8 *Gardenia taitensis* DC.**

Shrub or small tree, 6 m high with conspicuous stipules; leaves opposite, petiolate, broadly elliptical, up to 15 cm long; flowers showy, white, fragrant, borne singly on stems arising from upper leaf axils; fruit yellowish-green subglobose-to-ellipsoid capsule up to 5 cm long containing numerous whitish seeds surrounded by an orangish pulp [41].

#### **2.1.2.1.9 *Gardenia thailandica* Tirveng**

Tree, 5-10 m tall; leaves opposite, oval in shape, wide 5-10 cm, long 14-38 cm. The light green leaves have conspicuous venation with the secondary veins running almost perpendicular from the midvein to the outer leaf margin. Solitary star-shaped flowers are borne in the leaf axils and are white when they first open then mature to a dark, golden yellow. The calyx forms a sheath around



the base of the long tubular flower, which has five widely spreading petal lobes that are narrow at the base and widen towards the tips. The anthers (pollen producing structures) are inserted into the floral tube and barely extend beyond it. The round fruit contains many seeds that are immersed in a fleshy pulp [38].

#### **2.1.2.1.10 *Gardenia tubifera* Wall.**

Shrub or a small tree, 20 m tall; leaves oblanceolate, much narrowed at the base, 8-24 cm long, nerves 15-18 pairs; flowers terminal; calyx tubular, 1.5-2 cm long; corolla 12-14 cm long, creamy white turning orange yellow, fragrant; fruit globose, 3-5 cm across [12].

#### **2.1.2.1.11 *Gardenia vietnamensis***

Medium-size, woody shrub, 2 m tall; foliage semi-glossy; leaves elliptic with entire leaf margin (10 cm long, 5 cm wide); flower large, white. Flowers have about 6 paddle-shape petals that are arranged radially, like the spokes of a bicycle wheel (6.5-7.5 cm wide), turns to yellowish-white upon aging. Flowers have a strong and sweet fragrance.

#### **2.1.2.2 Pharmacological activities of examined *Gardenia* species**

Several pharmacological activities of examined *Gardenia* species in this study have been reported such as anti-HIV, anti-cancer and anti-inflammatory (Table 1).

**Table 1** Pharmacological activities of examined *Gardenia* species

<i>Gardenia</i> species	Local name	Pharmacological activity	Reference
<i>G. carinata</i>	Phut nam but, Rak na, Ra-no, Ra nai, Rattana, Ta-bue-ko, Ba-yae-ma-do	antibacterial, anti-HIV, antioxidant, anti-tyrosinase, antitopoisomerase II $\alpha$	[15]
<i>G. collinsae</i>	Phut pha, khoi dan, Khoi hin, Phut	anti-HIV 1, anti-inflammatory, anti-herpes simplex virus, anti-proliferation, cytotoxic	[42]
<i>G. griffithii</i>	Sida, Ta kiang, Pa-li-to	No reported	
<i>G. jasminoides</i>	Phut son, Phut yai, Khet thawa, Phut chin, Khae thawa, Phuttha raksa	anti-cancer, anti-viral, effect on osteoporosis, anti-inflammatory, anti-microbial, anti-protozoal, anti-depressant, melanogenesis inhibitory, anti-oxidant, neuroprotective effect on Alzheimer's disease, hypnotic, anti-seizure, immunosuppressive	[43-48]
<i>G. lineata</i>	Phut burapha, Phut na, Inthawa noi	No reported	

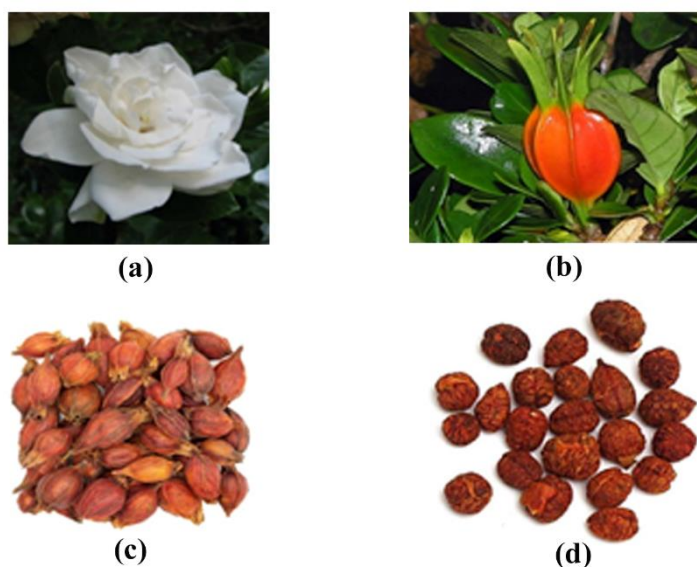
**Table 1** Pharmacological activities of examined *Gardenia* species (cont.)

<i>Gardenia</i> species	Local name	Pharmacological activity	Reference
<i>G. obtusifolia</i>	Khammok noi, Krabok, Kramop, Khai nao, Khom kwan, Phaya pha dam, Phut na, Farang khok, Mok, Sida khok	anti-HIV, anti-cancer, antiangiogenic, cytotoxic	[14, 16]
<i>G. sootepensis</i>	Khammok luang, Khammok chang, Pha dam, Khai nao, Yang mok yai, Salang homkai, Homkai	anti-tumor, antiangiogenic, cytotoxic	[16]
<i>G. taitensis</i>	Phut sang u-sa, Phut two in one	anti-inflammatory, anti-diabetic	[41]
<i>G. thailandica</i>	Phut phuket, Khammok songkhla, Phut pa, Rak na	anti-HIV-1	[17]
<i>G. tubifera</i>	Phut pa, Phut si, Ko- no-bu-ke	anti-HIV-1, cytotoxic	[20]
<i>G. vietnamensis</i>	Phut vietnam	No reported	

## 2.2 Fruit of *G. jasminoides*

### 2.2.1 Plant description of *G. jasminoides* fruit

The *G. jasminoides* fruit (**Figure 2**), is prolate-ovoid or ellipsoid 1.5-3.5 cm long, 1-1.5 cm in diameter; outer surface reddish-yellow or brownish-red, with 6 longitudinal winged ribs and a conspicuous longitudinal and branched vein between two ribs; summit bearing remains of sepals, base somewhat tapering and having a remain of fruit stalk; pericarp thin and brittle, somewhat lustrous; the inner surface relatively pale in color, lustrous, with 2-3 raised false septa; seeds numerous, flattened ovoid, aggregated into a mass, deep red or reddish yellow, with fine and dense warts on the surface; odor slight, slightly sour and bitter. This fruit contains mainly gardenoside, genipin, geniposide, crocin, chlorgenic acid, gentiobioside, crocetin , gardenin, mannitol and beta-sitosterol [30].



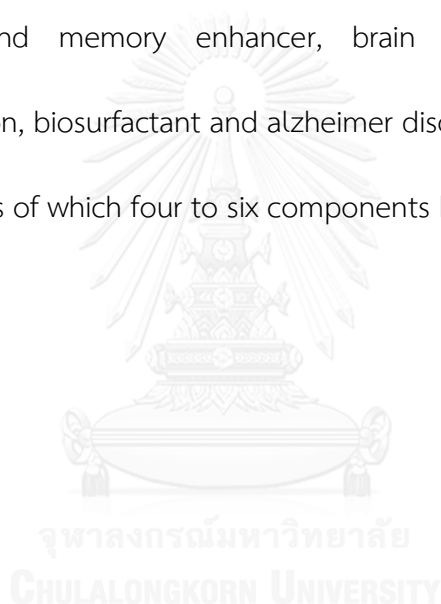
**Figure 2** Picture of *Gardenia jasminoides*: flower (a); ripened fruit (b); dried fruits (c) and seeds (d)

### 2.2.2 Traditional uses of *G. jasminoides* fruit

The fruit of *G. jasminoides* is also used in traditional medicine which exhibited various biological activities for the treatment of inflammation, jaundice, headache, edema, fever, hepatitis and hypertension [28]. The extracts of *Gardenia* fruit give yellow, red and blue colors, and has been used as food colorants in oriental countries in products such as noodles and confectioneries [28, 29]. Moreover, the major constitutions such as gardenoside, genipin, geniposide, chlorogenic acid, gentiobioside, crocetin, gardenin, mannitol and beta-sitosterol were also found in *G. jasminoides* fruit [30].

### 2.2.3 Crocin

Crocin (Crocetin di-gentiobiose ester) (**Figure 3**) is a water soluble carotenoid, yellow pigment, isolated from the Saffron (the dried stigmas of *Crocus sativus* L.) and the fruits of *Gardenia jasminoides* Ellis. It is used as a food colorant in oriental countries in products such as noodles and confectioneries [28, 29, 49, 50] and found to be effective as antiproliferative, anti-inflammatory, hepatoprotective, antioxidant, learning and memory enhancer, brain neurodegenerative disorder, spermcryoconservation, biosurfactant and alzheimer disorder [30, 51]. Crocin includes various glycosyl esters of which four to six components have been detected in saffron (**Figure 4**) [52].



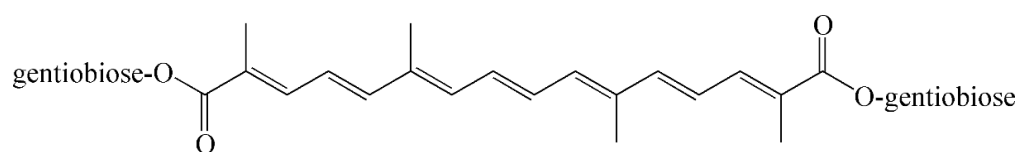


Figure 3 Chemical structure of crocin

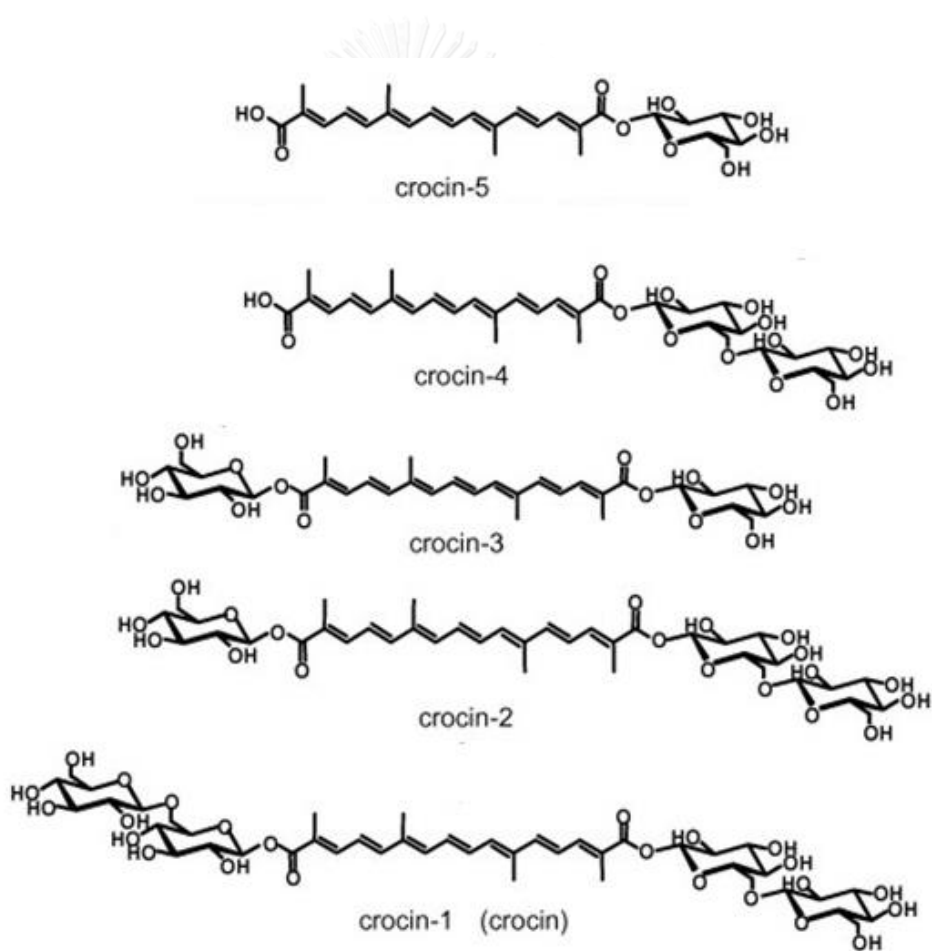


Figure 4 Chemical structure of crocin-1, crocin-2, crocin-3, crocin-4, and crocin-5

## 2.3 Pharmacognostic study

Therapeutic efficacy of medicinal plants depends on the quality and quantity of their active constituents. The misuse of plant materials with wrong identification and unqualified plant materials are serious problems as well as adulteration or substitution and contamination of plant materials which can affect the therapeutic efficacy of medicinal plants [53]. Therefore, quality control and standardization of plant materials should be concerned. Pharmacognosy is the study of materials used as medicine that derived from natural sources, mainly from plants. It basically deals with standardization, identification and authentication of plant materials. The pharmacognostic standardization parameters including macroscopic study, microscopic study, physicochemical analysis and thin layer chromatographic fingerprint analysis are generally done on plant materials [54].

### 2.3.1 Macroscopic study

The macroscopic study is the study of morphological characteristics of whole plant or individual plant parts that are visible with the naked eyes or magnification glass. Macroscopic study is also evaluated on the sensory characteristics like shape, size, color, odor, taste and texture of plants. Morphological characteristics are useful in the identification/authentication and classification of plant as well as determination of the presence of foreign matter or adulterant [55].



### 2.3.2 Microscopic study

Microscopic study is the study of anatomical structures or histological features in plant materials that are visible only with the help of microscope. Qualitative microscopy can be evaluated the histological or anatomical characteristics by taking appropriate section of the plant parts under study or powder form also. Another important histological aspect is quantitative microscopy that can be evaluated of various parameters such as stomatal number, stomatal index, palisade ratio and vein-islet number [56]. Microscopic study also covers the study of constituents in plant materials such as lignin, mucilage and starch by application of chemical methods to histological section or to small quantity of plant material in powdered form [57]. Histological characteristics of plant materials are not only essential to the plant identification but also indispensable to the study of adulterants.

#### 2.3.2.1 Qualitative microscopy

The arrangement of the tissues in the transverse and longitudinal sections and types of cells are the main criterion for evaluation of qualitative microscopic study of plant materials [57]. Several microscopic structures including stomata can be used as diagnostic characters of medicinal plants.

##### 2.3.2.1.1 Stomata

The stomata are epidermal opening that perform two important functions of gas exchange and water balance in plant body. Each stoma consists of

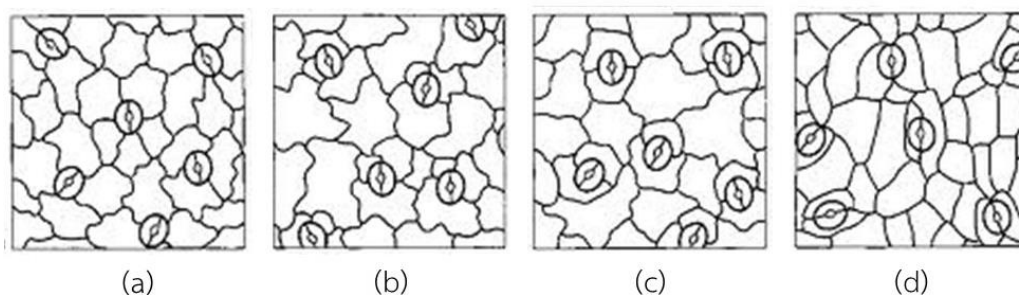
two guard cells that regulate stomatal opening and closing. The stomatal cell is protected by epidermal cells called subsidiary cells which adjacent to the guard cells and differ in shape or size from other epidermal cells. Stomata are present in green part of plant, mostly in leaves but absent in roots. They are also present in stems, flowers and fruits. The stomata may present on both surfaces of a leaf or on only one surface, in which case it is generally the lower surface [57, 58].

#### 2.3.2.1.2 Type of stomata

Stomatal types are distinguished based on the arrangement of their surrounding epidermal or subsidiary cells. Four common types of stomata are founded in mature leaf of plant including anomocytic type, anisocytic type, diacytic type and paracytic type (**Table 2** and **Figure 5**) [58-60]. Stomatal type can be helpful in identification of plant materials.

**Table 2** The most common types of leaf stomata

Stomata type	Characteristics
Anomocytic or <i>Ranunculaceous</i> type (irregular-celled)	The stomata are surrounded by a varying number of epidermal cells, not different in size or shape from other epidermal cells.
Anisocytic stomata or <i>Cruciferous</i> type (unequal-celled)	The stomata are surrounded by three or four subsidiary cells, one of them is considerably smaller than the others.
Diacytic stomata or <i>Caryophyllaceous</i> type (cross-celled)	The stomata are surrounded by two subsidiary cells and their long axes are crosswise to the axis of the stomata.
Paracytic stomata or <i>Rubiaceous</i> type (parallel-celled)	The stomata are surrounded by two subsidiary cells and their long axes are parallel to the axis of stomata.



**Figure 5** Four types of stomata based on arrangement of subsidiary cells in plant: anomocytic type (a), anisocytic type (b), diacytic type (c), paracytic type (d)

### 2.3.2.2 Quantitative microscopy

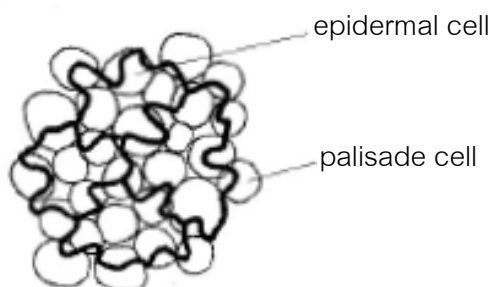
Leaf measurement is one of the important quantitative microscopic evaluations which can be used to identify and distinguish between some closely related species not easily characterized by qualitative microscopic evaluations [60]. Various parameters of leaf measurements are generally determined in plant materials including stomatal number, stomatal index, palisade ratio, vein-islet number, vein-termination number, epidermal cell area, epidermal cell number and trichome number (**Table 3**).

**Table 3** Leaf measurement parameters [58-60]

Leaf measurement parameter	Definition
Stomatal number	The average number of stomata per square millimeter of epidermis of the leaf. This value should be recorded for both of upper and lower surfaces of the leaf and the ratio of values for the two surfaces.
Stomatal index	The percentage number of stomata as compared to all the epidermal cells including trichome in a same unit area of leaf. Stomatal index can be calculated by using following equation:  $\text{Stomatal index} = (S/S+E) \times 100$ <p>S= The number of stomata per square millimeter in a given area of leaf</p> <p>E= The number of epidermal cells per square millimeter in the same area of leaf</p>

**Table 3** Leaf measurement parameters (cont.)

Leaf measurement parameter	Definition
Palisade ratio	The average number of palisade cells present beneath each upper epidermal cell. It can be determined on fine powders.
Vein-islet number	Vein-islet is the small area of photosynthetic tissue encircled by the ultimate division of the conducting strands. Vein-islet number is the number of vein-islets per square millimeter of leaf surface.
Vein-termination number	The average number of an ultimate free end or termination of a vein-islet per square millimeter of leaf surface.
Epidermal cell number	The average number of epidermal per square millimeter of leaf surface.
Epidermal cell area	The average area of epidermal cell present in square millimeter.
Trichome number	The average number of trichome per square millimeter of epidermis of the leaf.



**Figure 6** Four upper continuous epidermal cells with underlying palisade cells in surface view

The stomatal number varies depend on species, leaf age, environmental condition and geographical sources where the plants grows [61]. Therefore, this value may varies for leaves of the same plant grown in different environmental conditions [57]. The early study of stomatal number by Timmerman in 1927 showed that this value is usually useless for distinguishing between closely species, but the ratio between the numbers of stomata on the two surfaces may be used for distinguishing in some cases [62]. However, stomatal number is relatively a constant for particular species of same age and hence, it is taken into consideration as a diagnostic character for identification of leaf drug as well as the adulteration can also be detected by stomatal number [57]. While, stomatal number varies considerably with the age of leaf and due to changes in climatic conditions, stomatal index is highly constant for a given species [60]. Stomatal index is useful in differentiation of closely related species

and also for detection of adulterants. A vein islet number per unit area of leaf is also constant for a given species of the plants [57, 58] because it does not alter with the age of plant and is independent of the size of the leaf [57]. It can be easily used as a distinguishing characteristics to differentiate between different species of the same plant or between different plants. The other important leaf constant parameters is palisade ratio, it can be determined on fine powders but cannot applicable to determine on monocot leaves, as the differentiation in mesophyll cell is not possible in monocot plants. This value does not alter based on geographical variation and differs from species to species. Therefore, this value remains constant for a given plant species and is also useful diagnostic feature for characterization and identification of different plant species [57]. Epidermal cell areas are relatively constant within a narrow range for each species that allows a correct identification even though some degree of overlapping with closely related species. These values were used as a taxonomic tool for the identification of plant materials such as *Stanhopea* species (Orchidaceae) [63]. Trichomes have been defined as epidermal protuberances that founded on the leaves, stems, flowers, fruits, seeds, petals, stalks and peduncles of plants [60, 64]. The morphological characters of trichomes and their density are taxonomic important for identification of plant samples [65, 66]. Trichomes number was induced variation by seasonal and environmental factors [67].

Leaf measurement parameters are suitable as a primary means of identification of a sample and can provide very useful supportive evidence. These parameters can make a positive evaluation and identification when taken together with other factors. Additionally, these parameters may be useful as quality control standards.

### **2.3.3 Physicochemical analysis**

The evaluation of physicochemical parameters are helpful in determining the quality and purity of a crude drug, especially in the powdered form. The physicochemical values of plant materials may be affected by several factors such as different geographical conditions, edaphic factors, environmental conditions, period of cultivation and harvesting, method of collection, source of irrigation and fertilizers, age of the plant, powdering method, and extraction method [68]. These parameters including moisture content, loss on drying, extractive value, ash value and volatile oil should be determined for quality control and standardization of crude drug.

#### **2.3.3.1 Ash value**

The ash value of any organic materials such as herbal drugs and pharmaceutical substances usually represents the non-volatile inorganic components remaining after incineration [58, 59]. This value can detect not only an unwanted parts of drugs such as the sclerides in the unwanted pericarp of colocynth but also more direct contamination such as sand or earth [58]. The ash content can be determined



by four different methods to measure the total ash, the acid insoluble ash, the sulphated ash, and the water soluble ash.

#### **2.3.3.1.1 Total ash**

The total ash usually consists mainly of inorganic salts e.g., carbonates, phosphates, silicates and silica, which includes inorganic components occurring naturally in crude drug and inorganic matter derived from external sources e.g., sand and soil [60, 69]. A high value of total ash is indicative of contamination, substitution, adulteration or carelessness in preparation of crude drug [58]. This value is important in determination of the purity of powdered drugs which can be used to detect adulteration with exhausted drugs, to detect absence of other parts of the plant, to detect adulteration with material containing either starch or stone cells and to ensure the absence of an abnormal proportion of extraneous mineral matter incorporated accidentally or due to follow up treatment or due to method of operation at the time of collection e.g., soil and sand [70]. If more quantity of calcium oxalate is present in crude drug, then the value for the acid insoluble ash is a better criterion of purity [69].

#### **2.3.3.1.2 Acid insoluble ash**

The acid insoluble ash is a measurement of the amount of silica present in crude drug, especially as sand and siliceous earth [59]. Crude drugs containing larger quantity of calcium oxalate, can give variable results depending upon

the conditions of ignition. The treatment of total ash with dilute hydrochloric acid virtually leaves silica only. Therefore, acid insoluble ash is a suitable test to detect and limit excess of soil present as an impurity in the crude drug [69]. If no figure is stated in the individual monograph, the acid insoluble ash value should not exceed 2% [58].

#### **2.3.3.1.3 Sulphated ash**

The sulphated ash is a measurement of the amount of non-volatile inorganic substances in crude drug. The treatment of the crude drug with sulphuric acid before ignition, all oxides and carbonates are converted to sulphates [60]. This value is usually used to indicate the level of non-volatile inorganic substances in an organic material. This value is consistent and reproducible, due to the higher stability of metal sulphates [60, 69].

#### **2.3.3.1.4 Water soluble ash**

The water soluble ash is a measurement of water soluble inorganic substances in crude drug or raw material [69]. This value is the difference in weight between the total ash and the residue obtained after treatment of total ash with water. This value is a good indicator of either previous extraction of water-soluble salts in the drug or incorrect preparation [58]. Therefore, water-soluble ash is specifically useful in detecting such samples which have been extracted with water [70].

### 2.3.3.2 Extractive value

The extractive value is the amount of chemical constituents present in crude drug obtained from the extraction with a particular solvents. The composition of chemical constituents in that particular solvent depend upon the nature of crude drug and solvent used. This determination can be employed for that material for which no chemical or biological assay method exist. The determination of water soluble and alcohol soluble extractives, is used as a means of evaluating crude drugs which are not readily estimated by other means [58, 60]. This value is useful in the evaluation of crude drugs and also help to indicate the nature of chemical constituents present in crude drug as well as can helps in the identification of adulterants. Beside these water and alcohol soluble extractive values, other solvents extractive values are prescribes such as hexane soluble extractive value, volatile ether soluble extractive value and nonvolatile ether soluble extractive value [58].

### 2.3.3.3 Water and volatile matter

Moisture is one of the important factors responsible for the deterioration of crude drug and formulations either due to chemical change or microbial growth or the presence of fungi or insects [59]. Therefore, the moisture content should be determined and set for every given plant material and also should be controlled. This is especially significant for plant materials that absorb moisture easily or deteriorate quickly in the presence of water [59]. Low moisture content is

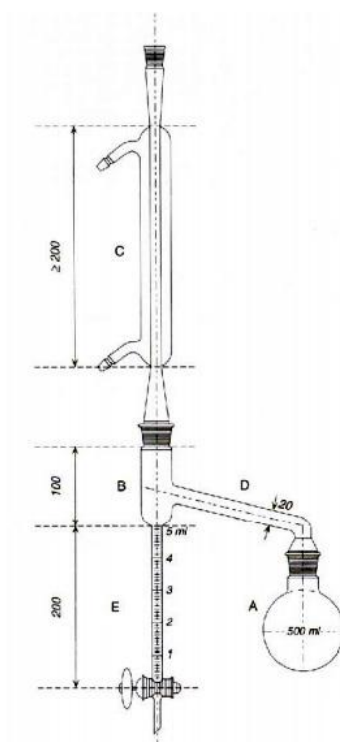
always desirable for higher stability of drugs [71]. Loss on drying and azeotropic distillation method are commonly used for determination of moisture content in plant material.

#### **2.3.3.3.1 Loss on drying**

Loss on drying is a measurement of amount of both water and volatile matters in crude drug when the crude drug is dried under specified conditions [58-60]. This test can be done either by heating at 105°C or in a desiccator over phosphorus pentoxide at atmospheric pressure and at room temperature for specific period of time [58, 59].

#### **2.3.3.3.2 Azeotropic distillation method**

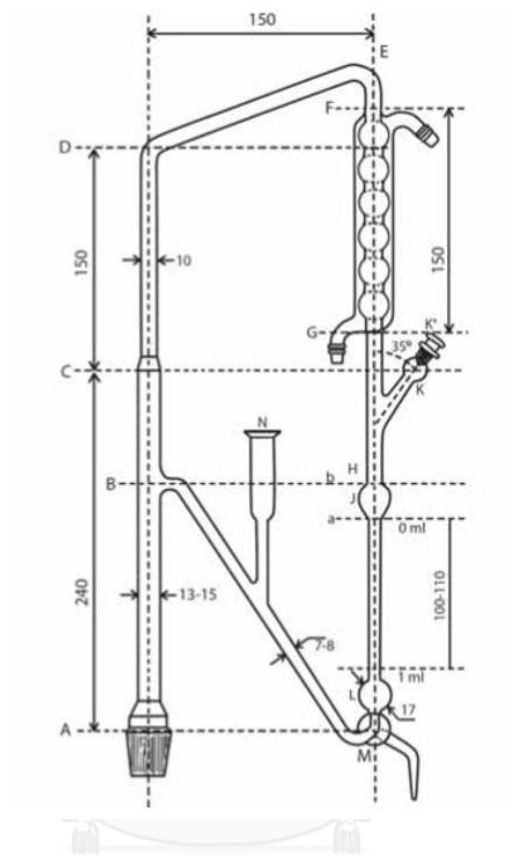
The azeotropic distillation method determines only the water present in the crude drug when the crude drug is distilled together with water saturated toluene and separated in the receiving tube on cooling [59].



**Figure 7** Apparatus for azeotropic distillation used for water content determination (dimensions in mm): a glass flask (A); a cylindrical tube (B); a reflux condenser (C); a receiving tube (D); a graduated receiving tube (E) [59]

#### 2.3.3.4 Volatile oil content

The volatile oils are also known as essential oils which responsible for the fragrance of flowers and the characteristic aromas of other parts of many plants [58]. Pharmaceutical significance of several medicinal plants is due to their odorous principle that is volatile oils. Such crude drugs are standardized on the basis of their volatile oil contents [57, 72]. The volatile oil content is determined using Clevenger apparatus [59].



**Figure 8** Clevenger apparatus used for volatile oil content determination (dimensions in mm) [59]

### 2.3.4 Thin layer chromatographic fingerprint

Chromatographic fingerprint has become an important tool for the quality control of herbal drugs [73, 74]. Fingerprint analysis has been accepted by WHO as a methodology for the quality control of herbal samples [74]. The chromatographic

fingerprint of an herbal drug is a chromatographic pattern of its extract of some chemical constituents which may be pharmacologically active or have some chemical characteristics [75]. The chromatographic fingerprint can exhibit both sameness and differences among various samples and can be performed even if the amount and/or concentration of the various samples are different [73, 75]. Therefore, this technique can be used for identification and authentication as well as for determination of adulterants and contaminants and for standardization purpose of herbal drug. Several chromatographic methods have been applied for fingerprint construction such as thin layer chromatography (TLC), high performance thin layer chromatography (HPTLC), high-performance liquid chromatography (HPLC) and gas chromatography (GC). Among these various methods, TLC is the most popular and simple chromatographic technique used for separation of compounds.

TLC is a planar chromatography and based on a distribution process. This process requires a suitable adsorbent or the stationary phase (solid), suitable solvents or solvent mixtures of the mobile phase or eluent (liquid), and the sample preparation. In TLC, the adsorbent is coated as a thin layer onto a suitable support (e.g. glass plate, polyester or aluminium sheet). On this layer, the sample is separated by elution with a suitable solvent [59]. The advantages of this technique are effective, easy to perform, rapid analysis, inexpensive equipment, high sample throughput in a short time, require fewer amount of sample and provides qualitative and semi-quantitative information

of the resolved compounds [58, 59, 73, 75]. This technique is frequently used for evaluating medicinal plant materials and their preparations [59].

## **2.4 Molecular analysis**

Molecular analysis of plant materials requires high purity of genomic DNA extraction. Modified CTAB method is one of the best methods for the isolation of plant genomic DNA which provides purity of DNA extraction suitable for DNA analysis through molecular techniques [76, 77].

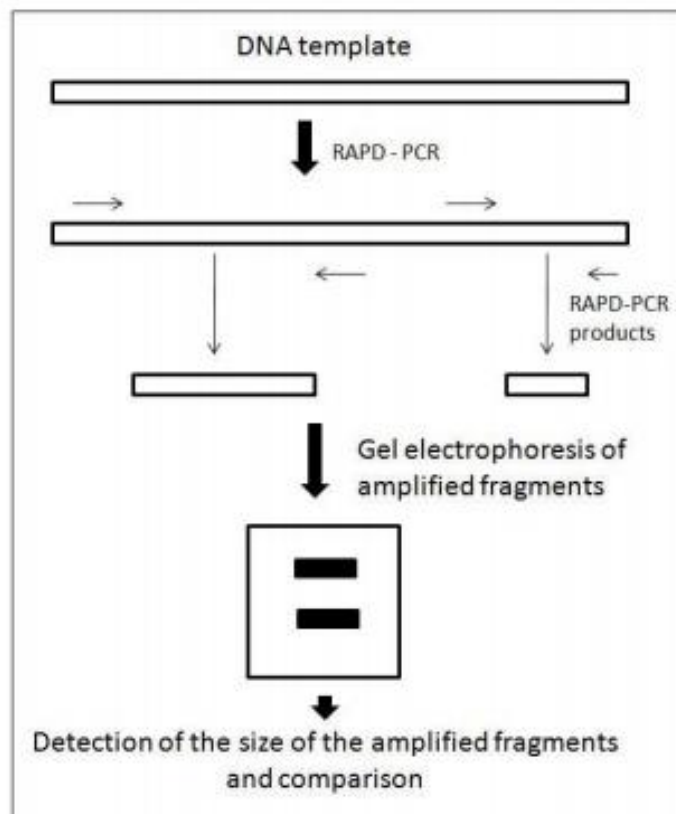
### **2.4.1 DNA extraction method**

The isolation of genomic DNA from plant materials requires lysis of cell membrane, inactivation of cellular nucleases and separation of the genomic DNA. The cetyltrimethylammonium bromide (CTAB) method is appropriate for the extraction of DNA from plants and suitable for the elimination of polysaccharides and polyphenolic compounds. Cell membrane of plant cells can be lysed with the ionic detergent CTAB which forms an insoluble complex with polysaccharides in a high-salt condition. Under this condition, proteins, phenolic compounds and other contaminations can be washed away. Genomic DNA isolation of some medicinal plant materials by modified CTAB method was reported on good yield and pure of DNA [77].



#### 2.4.2 Random amplified polymorphic DNA analysis

The random amplified polymorphic DNA (RAPD) method is based on the polymerase chain reaction (PCR) using single, 10-12 bases random sequence oligonucleotides as primers to amplify small amounts of total genomic DNA under low annealing temperature. Amplification products are generally separated on agarose gels and stained with ethidium bromide. Polymorphism of amplified fragments are caused by base substitutions or deletions in the priming sites, insertions that render priming sites too distant to support amplification, and insertions or deletions that change the size of the amplified fragment [78]. The advantages of this method are as following: It requires no DNA information for primer design; it is quick, simple and efficient because of no blotting or hybridization steps; it requires only small amounts of DNA and the procedure can be automated; it gives high number of fragments; primers are easily purchased; low of unit cost per assay. The limitations of this method are dominant inheritance, problems with reproducibility and problems of co-migration [79].



**Figure 9** The principle of RAPD-PCR technique [80]. Arrows indicate primer annealing sites



#### 2.4.2.1 Methods of analysing RAPD data

The first step in RAPD data analysis is product scoring of either scoring product presence/absence or accounting for product intensity. Mostly, RAPD data is often scored on the bases of product presence/absence because of the difficulty of identifying on the bases of intensity differences. Next step is similarity measuring. The most widely used approach to analysing the similarity of RAPD data is

one of three techniques including (i) the simple matching coefficient, which measures the proportion of shared product presences and absences between two RAPD profiles; (ii) the Jaccard's coefficient, which measures the proportion of shared product presences; (iii) the Nei and Li coefficient, which measures the probability of a product amplified in one sample also being amplified in another sample [81]. And the final step is tree construction. The UPGMA is the simplest method of tree construction based on the distance or the amount of dissimilarity. This method joins tree branches based on the criterion of greatest similarity among pairs and averages of joined pairs [82].

#### **2.4.2.2 Molecular marker properties**

There are many types of molecular markers that have been used for different purposes in plants. The five most widely used molecular markers in plants including RFLP, microsatellite, RAPD, AFLP and ISSR have been reported on their important properties (Table 4).

**Table 4** Comparison of the five most widely used DNA markers in plants [83]

	RFLP	Microsatellite	RAPD	AFLP	ISSR
Genomic abundance	high	medium	very high	very high	medium
Part of genome surveyed	low copy coding regions	whole genome	whole genome	whole genome	whole genome
Amount of DNA required	high	low	low	medium	low
Type of polymorphism	single base changes, insertion, deletion	changes in length of repeats	single base changes, insertion, deletion	single base changes, insertion, deletion	single base changes, insertion, deletion
Level of polymorphism	medium	high	high	very high	high
Inheritance	codominant	codominant	dominant	dominant	dominant
Detection of alleles	yes	yes	no	no	no

**Table 4** Comparison of the five most widely used DNA markers in plants (cont.)

	RFLP	Microsatellite	RAPD	AFLP	ISSR
Ease of use	labor intensive	easy	easy	difficult initially	easy
Automation	low	high	medium	medium	medium
Reproducibility	high	high	intermediate	high	medium to high
Type of probes/primers	low copy genomic DNA or cDNA clones	specific repeat DNA sequence	usually 10 bp random nucleotides	specific sequence	specific repeat DNA sequence
Cloning and/or sequencing	yes	yes	no	no	no
Radioactive detection	usually yes	no	no	yes/no	no
Development/start-up costs	high	high	low	medium	medium

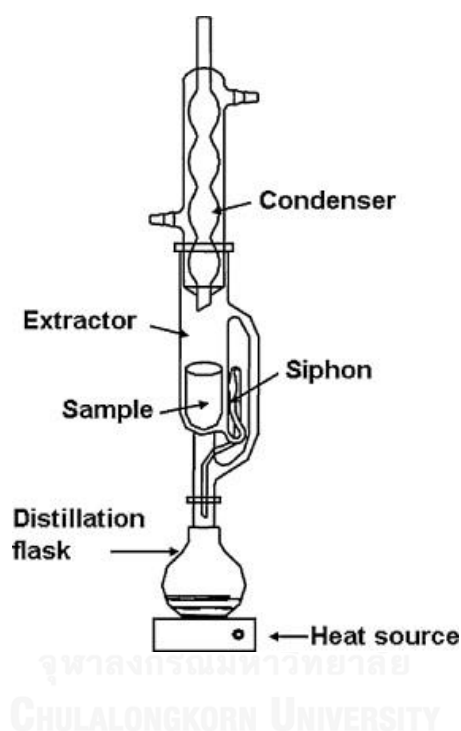
## 2.5 Extraction methods of chemical constituents from plants

There are a number of methods for extraction of chemical constituents from plant materials including conventional methods like maceration, infusion, percolation, decoction and Soxhlet extraction, and novel extraction techniques like microwave assisted extraction (MAE), supercritical fluid extraction (SFE), ultrasound-assisted extraction (UAE) and accelerated solvent extraction (ASE). In this study, Soxhlet extraction was used to prepare crude extract from *G. jasminoides* fruits.

### 2.5.1 Soxhlet extraction

Soxhlet extraction or continuous extraction is a standard technique and support as the main reference for other extraction methods [84, 85]. In this method, finely ground plant materials are placed within a thimble-holder (Figure 10). Extraction solvents is heated in the distillation flask, vaporizes into the sample thimble, condenses in the condenser and drip back. When the liquid content reaches the siphon arm, the liquid contents emptied into the distillation flask again and the process is continued [86]. The main advantages of conventional Soxhlet extraction include (i) continuous process, (ii) maintaining a relatively high extraction temperature with heat from the distillation flask, (iii) basic, simple and cheap, (iv) no filtration requirement after extraction. The disadvantages of this method include (i) time consuming, (ii) uses large amount of solvent, (iii) the Soxhlet apparatus cannot provide agitation to accelerate the process, (iv) not suitable for thermolabile compounds as long time

heating may lead to degradation of compounds, (v) exposure to hazardous and flammable liquid organic solvents with potential toxic emissions during extraction [58, 84-87]. This method was used to extract pigments from saffron including crocin, carotene, anthocyanin and lycopene [88].



**Figure 10** Schematic diagram of Soxhlet extraction apparatus

## 2.6 UV spectrophotometric measurement

Spectrophotometry is a measurement of how much a chemical substance absorbs or transmits of the electromagnetic radiation over a certain range of wavelength. Spectrophotometer is an instrument that measures the amount of the

intensity of light absorbed after it passes through sample solution. The concentrations of a substance can also be determined by measuring the intensity of light detected.

UV-visible spectrophotometer uses light over the ultraviolet range (185-400 nm) and visible range (400-700 nm) of electromagnetic radiation spectrum. The electromagnetic spectrum consists of all the different wavelengths of electromagnetic radiation including UV, visible light, radio waves and X-rays.

When monochromatic electromagnetic radiation (radiation with only one wavelength) with the intensity of  $I_0$  passes through a solution of an analyte, some of the radiation is absorbed by the analyte while the rest passes right through. When the intensity of the transmitted monochromatic radiation, which is measured at the backside of the solution, is  $I$  (Figure 11), the absorbance of radiation ( $A$ ) is defined as Beer-Lambert law:

$$A = \log (I_0/I) = \log (1/T) = \epsilon cb$$

Where,  $A$  is the absorbance

$T$  is the transmittance ( $I/I_0$ )

$I_0$  is the intensity of light incident upon sample cell

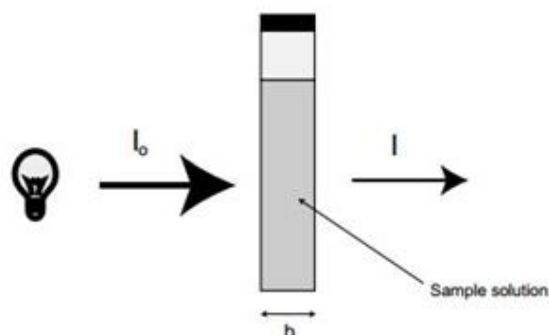
$I$  is the transmitted intensity of light leaving sample cell

$c$  is the concentration of the substance in the solution

$b$  is the length of sample cell (cm.)

$\epsilon$  is a constant of proportionality, called the absorptivity

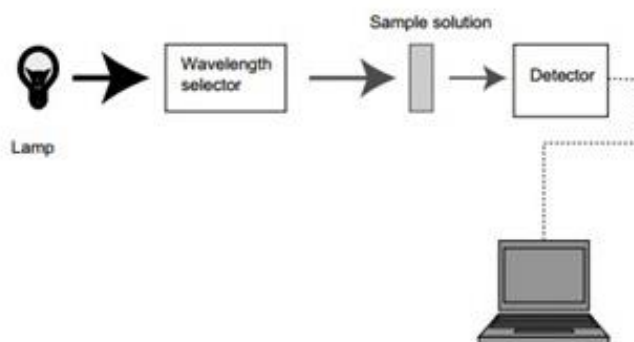




**Figure 11** Beer's law-absorption of radiation

From the Beer-Lambert law, it is clear that greater the number of molecules capable of absorbing light of a given wavelength, the greater the extent of light absorption. This is the basic principle of spectrophotometry.

The absorption spectra of substances are characterized by two parameters, first is the position of the maximum of the absorption band called  $\lambda_{\max}$ , and second is intensity of the bands. The  $\lambda_{\max}$  refers to the wavelength of the most absorbed radiation and is a measure of the difference in the electronic energy levels involved in the transition. It is also is a measure of the concentration of the absorbing species.



**Figure 12** Schematic view of a spectrophotometer

The UV-VIS spectrometry is one of the oldest instrumental techniques of analysis and is the basis for a number of ideal methods for the determination of micro and semi-micro quantities of analytes in a sample. The advantages of this method include simple, rapid, reproducible, non-destructive, can provide very high precision and accuracy, can be used both quantitatively and qualitatively on pure substances and also it requires minimum solvent/reagent system and less analysis time [89]. The disadvantages include limited use in analyzing mixtures, due to the addition of absorbance, requires special equipment (a light sources and transparent sample holders), and it is not selective for compounds if they absorb at the same wavelength. This technique is widely used for the assay of the therapeutic compounds used as medications.

## 2.7 Method validation [90]

Method validation is the process used to confirm that the analytical procedure developed for a specific test is suitable for its intended purpose. The results obtained from method validation can be used to judge the quality, reliability and consistency of analytical results. The validation of a method follows a standardized set of experimental tests which produce data relating to specificity, accuracy, precision, detection limit.

### 2.7.1 Specificity

Specificity is the ability to assess unequivocally the analyte in the presence of components which may be expected to be present. Typically these might include impurities, degradants, matrix, etc.

### 2.7.2 Accuracy

The accuracy or trueness of an analytical procedure expresses the closeness of agreement between the value which is accepted either as a conventional true value or an accepted reference value and the value found.

### 2.7.3 Precision

The precision of an analytical procedure expresses the closeness of agreement between a series of measurements obtained from multiple sampling of the same homogeneous sample under the prescribed conditions. Precision may be

considered at three levels including repeatability, intermediate precision and reproducibility.

#### **2.7.3.1 Repeatability**

Repeatability expresses the precision under the same operating conditions over a short interval of time. Repeatability is also termed intra-assay precision.

#### **2.7.3.2 Intermediate precision**

Intermediate precision expresses within-laboratories variations such as different days, different analysts, different equipment, etc.

#### **2.7.3.3 Reproducibility**

Reproducibility expresses the precision between laboratories such as collaborative studies, usually applied to standardization of methodology.

#### **2.7.4 Detection limit**

The detection limit of an individual analytical procedure is the lowest amount of analyte in a sample which can be detected but not necessarily quantitated as an exact value.

### **2.7.5 Quantitation Limit**

The quantitation limit of an individual analytical procedure is the lowest amount of analyte in a sample which can be quantitatively determined with suitable precision and accuracy.

### **2.7.6 Linearity**

The linearity of an analytical procedure is its ability (within a given range) to obtain test results which are directly proportional to the concentration (amount) of analyte in the sample.

### **2.7.7 Range**

The range of an analytical procedure is the interval between the upper and lower concentration (amounts) of analyte in the sample (including these concentrations) for which it has been demonstrated that the analytical procedure has a suitable level of precision, accuracy and linearity.

### **2.7.8 Robustness**

The robustness of an analytical procedure is a measure of its capacity to remain unaffected by small, but deliberate variations in method parameters and provides an indication of its reliability during normal usage.

## 2.8 Previous studies of *Gardenia* species

Most studies of *Gardenia* species have been accumulated with respect to the efficacy and toxicity or their constituents. According to Chin, oral administration of the extract from gardenia fruit to rat (33-50 g/kg) caused death and change of liver color to darkly gray [91], and Tetsuo Yamano *et.al.* [92], reported that one of the commercial preparations of gardenia yellow color extracted from gardenia fruit cause injury of rat liver after oral doses of more than 5 g/kg. Moreover, A. Ozaki *et.al.* in the year 2002 [93], evaluated the genotoxicity of gardenia fruit extract by Ames test and found that gardenia yellow and genipin damage of DNA. Other studies focus on *Gardenia* efficacy, Koo *et.al.* [94], demonstrated that gardenia extract fruit, geniposide and genipin exhibited an anti-inflammatory activity by the results with carrageenan-induced rat paw edema, carrageenan-induced air pouch formation, and measurement of NO content in the exudates. Jun-Sheng Tian *et.al.*[95], investigated the antidepressant potential of genipin in mice by using mouse models of depression including the forced swimming test and the tail suspension test and the results showed that intra-gastric administration of genipin at 50, 100, 200 mg/kg for 7 days significantly reduced the duration of immobility in both tests. Kafua *et.al.* [96], investigated the antifungal activity of *G. brighamii* leaf extracts against five fumonism producing *Fusarium* species by using the microtitre dilution method and direct bioassay and the results from these

two methods confirm the antifungal properties of this plant. Additional, Han *et.al.*[28], studies on genetic diversity of *Gardenia jasminoides* based on AFLP marker.

In Thailand, studies of *Gardenia* species are limited and most of them still mainly focus on the pharmacological activities. Patoomratana Tuchinda *et.al.* [97] reported on cytotoxic and anti-HIV-1 constituents of *Gardenia obtusifolia* and their modified compounds. Similar studied on cytotoxicity of two compounds from *Gardenia sootepensis* exudate was reported by Khanitha Pudhom *et al.* [98]. The studied on anti-cancer of a dihydroxy-pentamethoxyflavone from *Gardenia obtusifolia* was reported by Kanokkarn Phromnoi *et al.* [99]. In the aspect of genetic characteristic, Suwannakud *et al.* studied on the genetic relations related to chemical containing and the efficient barcodes by psbA-trnH spacer and its combinations with rbcL and matK on *Gardenia* species [42]. The previous studies have shown that the information on the microscopic evaluation and molecular analysis of *Gardenia* species and *G. jasminoides* fruit in Thailand have still limited.

## CHAPTER III

### MATERIALS AND METHODS

Scope of the study included macroscopic and microscopic evaluation, molecular analysis of eleven selected *Gardenia* species, pharmacognostic evaluation, crocin content analysis of *Gardenia jasminoides* fruit using UV spectrophotometry method and also crocin component analysis using TLC-densitometric methods. Details of materials and methods were described below.

#### 3.1 Materials

Filter paper grade No.4	Whatman, England
Filter paper grade No. 40, Ashless	Whatman, England
TLC silica gel 60 GF <sub>254</sub> (0.2 mm thickness, 20 x 10 cm)	Merck, Germany

#### 3.2 Chemicals and reagents

Acetic acid	BDH Chemicals Ltd., England
Crocin	Sigma-Aldrich., St. Louis, USA
EDTA	Sigma-Aldrich., Germany
Ethanol (Analytical grade)	Thailand
Ethyl acetate (Analytical grade)	RCI Labscan, Thailand



GoTaq Green Master Mix	Promega, USA
Toluene (Analytical grade)	RCI Labscan, Thailand
Ultrapure water	Thailand

All of chemicals and reagents were analytical grade.

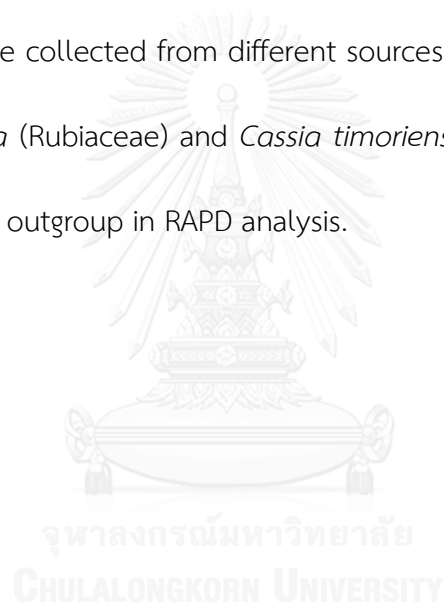
### 3.3 Equipments and instruments

Ashing Furnance	Carbolite, England
CAMAG Visualizer	CAMAG, Switzerland
Digital camera (Canon Power Shot A650 IS)	Canon Marketing Co. Ltd., Thailand
Gel documentation	INGENIUS3, SYNGENE, USA
Hot air oven	WTC Binder, Germany
Microscope	Zeiss, Germany
PCR thermal cycler	ProFlex PCR System, United Kingdom
Rotary evaporation instrument	Buchi Glas Uster, Switzerland
Spectrophotometer	SPECORD/210plus, Germany
Spectrophotometer	UV-1800, SHIMADZU, Japan
Ultraviolet fluorescence analysis cabinet	Spectronics Corporation, USA
winCAT software (version: 1.4.6.2002)	CAMAG, Switzerland

### 3.4 Plant samples

#### 3.4.1 *Gardenia* species samples

Eleven species of *Gardenia* namely *G. jasminoides*, *G. carinata*, *G. collinsiae*, *G. griffithii*, *G. lineata*, *G. obtusifolia*, *G. sootepensis*, *G. thailandica*, *G. taitensis*, *G. tubifera* and *G. vietnamensis* were explored and collected from various sources throughout Thailand. Additionally, three individual plant samples of each *Gardenia* species were collected from different sources (Table 5). Two plant species of *Ixora finlaysoniana* (Rubiaceae) and *Cassia timoriensis* (Caesalpiniaceae) were also collected for using as outgroup in RAPD analysis.



**Table 5** Source of *Gardenia* species collection

<i>Gardenia</i> species	Source no.1	Source no.2	Source no.3
1. <i>G. carinata</i>	Bangkok	Chiang Mai	Pathum Thani
2. <i>G. collinsae</i>	Nakhon Ratchasima	Chaiyaphum	Phitsanulok
3. <i>G. griffithii</i>	Bangkok	Chachoengsao	Prachin Buri
4. <i>G. jasminoides</i>	Bangkok	Saraburi	Buri Ram
5. <i>G. lineata</i>	Bangkok	Prachin Buri	Nonthaburi
6. <i>G. obtusifolia</i>	Kamphaeng Phet	Nakhon Ratchasima	Nakhon Sawan
7. <i>G. sootepensis</i>	Bangkok	Chiang Mai	Chiang Rai
8. <i>G. taitensis</i>	Bangkok	Prachin Buri	Nonthaburi
9. <i>G. thailandica</i>	Bangkok	Phuket	Prachin Buri
10. <i>G. tubifera</i>	Bangkok	Pathum Thani	Nakorn Sawan
11. <i>G. vietnamensis</i>	Bangkok	Saraburi	Pathum Thani

### 3.4.2 Fruit of *G. jasminoides* sample

Dried fruits of *Gardenia jasminoides* were collected from twelve different locations in various provinces throughout four parts of Thailand as follows: Bangkok (3 stores), Chiang Mai, Nakhon Pathom, Surat Thanee, Ubon Ratchathani, Rayong, Uthai Thanee, Lampang, Chumporn and Nakhon Phanom.

### 3.4.3 Authentication of plant samples

All plant samples were authenticated by Associate Professor Dr. Nijsiri Ruangrungsi, College of Public Health Sciences, Chulalongkorn University, Bangkok, Thailand; Faculty of Pharmacy, Rangsit University, Pathumthani, Thailand. Voucher specimens were deposited at College of Public Health Sciences, Chulalongkorn University, Bangkok, Thailand.

## 3.5 Macroscopical studies

### 3.5.1 Macroscopical study of *Gardenia* species and *G. jasminoides* fruit

Macroscopic characteristics of all plant samples under study were illustrated by hand drawing of whole plant in proportional scale related to their original size.

## 3.6 Microscopical studies

### 3.6.1 Microscopical studies of *Gardenia* species

Both of qualitative and quantitative microscopic evaluations of eleven selected *Gardenia* species were carried out on transverse section of leaf and leaf measurement.

#### 3.6.1.1 Transverse section of leaf

Fresh mature leave of plant samples were washed and cut into suitable piece from the midrib region with small portion of lamina. Piece of leaf was

hold in one hand and cut the section rapidly and smoothly through the midrib with a sharp razor blade held in the other hand. The section was placed in a dish of water. Thin section was selected and mount in water on glass slide without any staining reagent used. Cover slip was placed over the slide. The slide was examined under the microscope with 100x, 200x, and 400x total magnifications and the photograph was taken. The hand drawing of transverse section of each *Gardenia* species was done.

### 3.6.1.2 Leaf measurement

Quantitative microscopy to determine stomatal number, stomatal index, palisade ratio, epidermal cell number, epidermal cell area and trichome number were carried out using the methods as described by Evans [60] with some modifications.

#### 3.6.1.2.1 Preparation of leaf sample

Fresh mature leaves of plant samples were washed. The leaf portion between midrib and margin from the middle region was cut into small piece (10 mm X 10 mm). Pieces of leaf sample were soaked in Haiter bleach solution (3% Sodium hypochlorite) until chlorophyll was removed and then gentry boiled in choral hydrate solution (8 g/ml in water) until the fragments were transparent. The cleared fragment was rinsed with water and mounted in 50% glycerin on glass slide for further examination of leaf measurement.

### 3.6.1.2.2 Method for stomatal types identification

The transparent leaf fragment was mounted in 50% glycerin on glass slide and examined under a microscope with 400x total magnification. The photograph of stomatal cell was captured and record of stomatal type.

### 3.6.1.2.3 Method for stomatal number and stomatal index

#### determination

The transparent leaf fragment was mounted and examined under a microscope with 200x total magnification. The photograph was captured and scale of 500 sq.  $\mu\text{m}$ . was applied to the image. All stomata and epidermal cell present in the same area of 500 sq.  $\mu\text{m}$ . were separately counted. The stomata or epidermal cell which at least some of its area lies within the square was also counted as 0.5 unit. From the average number of stomata or epidermal cell per 500 sq.  $\mu\text{m}$ ., the number of stomata or epidermal cell per sq. mm. was calculated by multiplying by 4. The stomatal number in lower surface of leaf and the stomatal index were calculated in 30 fields for 1 individual plant sample. The stomatal index was calculated as follows:

$$\text{Stomatal Index} = \frac{S}{E+S} \times 100$$

Where S= the number of stomata per 1 sq. mm area of leaf

E= the number of epidermal cells in the same unit area of leaf

#### 3.6.1.2.4 Method for palisade ratio determination

The transparent leaf fragment was mounted and examined under a microscope with 400x total magnification. Group of four epidermal cells was traced and photograph was captured. The palisade cells lying under the four epidermal cells were counted. The palisade cell which at least some of its area lies within the area of four epidermal cell was also count as 0.5 unit. The number of palisade cells obtained in each group divided by 4 gave the palisade ratio of that group. The palisade ratio was calculated in 30 groups of four epidermal cells for 1 individual plant sample.

#### 3.6.1.2.5 Method for epidermal cell number and epidermal cell area determination

The transparent leaf fragment was mounted and examined under a microscope with 200x total magnification. The photograph was captured and scale of 500 sq.  $\mu\text{m}$ . was applied to the image. All epidermal cells present in the area of 500 sq.  $\mu\text{m}$ . were counted. The epidermal cell which at least some of its area lies within the square was also counted as 0.5 unit. From the average number of epidermal cell per 500 sq.  $\mu\text{m}$ ., the number of stomata per sq. mm. was calculated by multiplying by 4. The epidermal cell number in upper surface of leaf and epidermal cell area were counted in 30 fields for 1 individual plant sample. The epidermal cell area was calculated as follows:

$$\text{Epidermal cell area} = \frac{1 \text{ mm}^2}{E}$$

Where E= the number of upper epidermal cells per 1 sq. mm area of leaf

#### 3.6.1.2.7 Method for trichome number determination

The transparent leaf fragment was mounted and examined under a microscope with 200x total magnification. The photograph was captured and scale of 500 sq.  $\mu\text{m}$ . was applied to the image. All trichome present in the area of 500 sq.  $\mu\text{m}$ . were counted. The trichome cell which at least some of its area base lies within the square was also counted as 0.5 unit. From the average number of trichome per 500 sq.  $\mu\text{m}$ ., the number of trichome per sq. mm. was calculated by multiplying by 4. The trichome number in lower surface of leaf was counted in 30 fields for 1 individual plant sample.

#### 3.6.2 Histological study of *G. jasminoides* fruit powder

Dried fruits of *G. jasminoides* were powdered with the help of blender and sieved through a No.250 sieve. A small quantity of the *G. jasminoides* fruits powder was heated with chloral hydrate (8 g/ml in water) for 10 min and then mounted in 50% glycerine on glass slide. The slide was covered with a cover slip and examined for histological characteristics under microscope with 100x, 200x, and 400x



total magnifications and photograph was taken. The hand drawing of histological characteristics of *G. jasminoides* fruit was done.

### **3.7 Physicochemical studies**

Various physicochemical parameters including loss on drying, ash values, extractable matters and moisture content of the *G. jasminoides* fruit powdered samples from 12 sources were determined in triplicate according to standard procedure mentioned in the WHO guideline on quality control method for medicinal plants materials with some modifications [59, 100].

#### **3.7.1 Determination of ash values**

##### **3.7.1.1 Determination of total ash**

Three grams of powdered *G. jasminoides* fruit were accurately weighed in a crucible. The sample was spread uniformly, preheated on gas oven to remove carbon and incinerated at 500°C in muffle furnace until a white ash was obtained. The ash in crucible was allowed to cool in desiccator and weighed. The total ash was calculated in terms of percentage with reference to the air-dried sample.

##### **3.7.1.2 Determination of acid insoluble ash**

Twenty-five ml of 2 N HCl was added into the crucible containing the total ash, covered by a watch-glass and gently boiled for 5 minutes. The watch-glass was rinsed with 5 ml of hot water into the crucible. The solution was

filtered through ashless filter-paper (Whatman No.40). The filter-paper containing acid insoluble ash was transferred into the original crucible and incinerated at 500°C until free from carbon (If ash is white or grey in color then the ash is free of carbon). The acid insoluble ash in crucible was allowed to cool in desiccator and weighed. The acid insoluble ash was calculated in terms of percentage with reference to the air-dried sample.

### **3.7.2 Determination of extractable matters**

#### **3.7.2.1 Determination of water soluble extractive value**

Five grams of powdered *G. jasminoides* fruit were accurately weighed into 250 ml stoppered conical flask and macerated with 70 ml of distilled water under shaking for 6 hours and standing for 18 hours. The extract was filtered rapidly through filter paper (Whatman No.4) and adjusted to 100 ml by washing the residue with distilled water. Twenty milliliters of the filtrate was transferred to a preweighed beaker, evaporated to dryness on a water bath and then dried in an oven at 105°C until weight constant. The water soluble extractive value was calculated in terms of percentage with reference to the air-dried sample.

#### **3.7.2.2 Determination of alcohol soluble extractive value**

Five grams of powdered *G. jasminoides* fruit were accurately weighed into 250 ml stoppered conical flask and macerated with 70 ml of 95% ethanol under shaking for 6 hours and standing for 18 hours. The extract was filtered rapidly

through filter paper (Whatman No.4) and adjusted to 100 ml by washing the residue with 95% ethanol. Twenty milliliters of the filtrate was transferred to a preweighed beaker, evaporated to dryness on a water bath and then dried in an oven at 105°C until weight constant. The alcohol soluble extractive value was calculated in terms of percentage with reference to the air-dried sample.

### **3.7.3 Determination of water and volatile matter**

#### **3.7.3.1 Determination of loss on drying**

Three grams of powdered *G. jasminoides* fruit were accurately weighed in a crucible. The sample was dried in an oven at 105°C for 8 hours to constant weight. The sample in crucible was allowed to cool in desiccator and weighed without delay. The loss on drying was calculated in terms of percentage with reference to the air-dried sample.

#### **3.7.3.2 Determination of water content (moisture content)**

The water content was determined by azeotropic method. Fifty grams of powdered *G. jasminoides* fruit were accurately weighed and added with 200 ml of water-saturated toluene in flask. The flask was heated until the water has been distilled completely. The inside of the condenser tube was rinsed with toluene and continue the distillation for 5 more minutes. The receiving tube was allowed to cool to room temperature. The toluene and water in receiving tube were separated and

the volume of water was read. The water content was calculated in terms of percentage with reference to the air-dried sample.

### 3.8 Thin layer chromatographic fingerprint

One gram of each of the twelve samples of *G. jasminoides* fruit powder was macerated in 20 ml of 95% ethanol for 24 hours. The extract was filtered, evaporated to dryness and redissolved in 1 ml of ethanol. Three microliters of the ethanolic extract was applied on the silica gel 60 GF<sub>254</sub> TLC plate (0.2 mm thickness, 10 cm x 20 cm). The plate was developed in glass TLC chamber with freshly made up solvents allowed to equilibrate within the tank for 1 hour. The composition of the solvent systems finally used were ethyl acetate: isopropyl alcohol: water (65:25:10). The TLC plate was investigated under daylight, UV light at 254 nm (short-wave) and 365 nm (long-wave) before spraying with p-anisaldehyde reagent (0.5 ml of p-anisaldehyde in 10 ml of glacial acetic acid, 85 ml of methanol and 5 ml of sulfuric acid). Spraying reagent for visualizing components was also made up freshly. TLC chromatograms were carefully heated at 105°C until optimal color development.

### 3.9 Crocin content analysis

#### 3.9.1 Extraction of *G. jasminoides* fruits powder

Ten grams of *G. jasminoides* fruit powders from 12 samples were extracted in Soxhlet apparatus with 300 ml of 90% ethanol until it was exhausted. The extracts were filtered, evaporated to dryness in vacuum. The extract yields were calculated and then stored in a refrigerator and protected from light for further analysis of crocin content and components.

#### 3.9.2 Crocin content determination by using UV-Visible spectrophotometric method

##### 3.9.2.1 Preparation of standard stock solution and calibration curve

Standard crocin was dissolved in methanol to make a final concentration of 1 mg/ml. A SHIMADZU UV/VIS spectrophotometer (UV1800) was used for scanning the absorption spectrum of standard crocin solution and the  $\lambda_{\max}$  was recorded. A series of five different concentrations of standard crocin ranging from 5-100  $\mu\text{g/ml}$  (5, 25, 50, 75, 100  $\mu\text{g/ml}$ ) were prepared and the calibration curve was obtained by plotting the absorbance at  $\lambda_{\max}$  versus five different concentrations of standard crocin.

### 3.9.2.2 Crocin content determination

The extracts of *G. jasminoides* fruit powder from 12 sources were prepared in methanol to obtain a concentration of 1 mg/ml and determined for their total crocin content using UV/VIS spectrophotometry. The experiment was performed in triplicate.

### 3.9.3 Method validation of UV/VIS spectrophotometric method

Spectrophotometric method proposed for quantitative analysis of crocin in *G. jasminoides* fruit was validated with respect to linearity, range, accuracy, precision, limit of detection (LOD), limit of quantitation (LOQ) and robustness according to the ICH guideline [90].

#### 3.9.3.1 Linearity, range, LOD and LOQ

The series of five different concentrations of standard crocin solution (5, 25, 50, 75, 100  $\mu\text{g/ml}$ ) were prepared from the stock solution and were measured for absorbance at  $\lambda_{\text{max}}$  of 434 nm. Least square regression analysis was performed from the obtained data. The LOD and LOQ were determined using calibration curve. LOD and LOQ were calculated as  $3.3\sigma/S$  and  $10\sigma/S$ , respectively, where  $\sigma$  is the standard deviation of y-intercept of regression equation and S is the slope of the calibration curve.

### 3.9.3.2 Accuracy

Accuracy was determined by spiking method. Three concentrations of standard crocin (20, 40, 60 µg/ml) were added to the extract sample and the total crocin content was determined. The accuracy was determined as percentage recovery of the spiked standard crocin in the sample. Percentage recovery (% Recovery) =  $[(C_s - C_u) / C_a] \times 100$ , where  $C_s$  is the total crocin concentration measured after standard addition;  $C_u$  is crocin concentration in the sample and  $C_a$  is standard crocin concentration added to the sample. Each test was done in triplicate.

### 3.9.3.3 Precision

The precision of the method was determined by repeatability and intermediate precision and reported as percent relative standard deviation (%RSD) of 3 concentrations of sample and 3 replicate each.

### 3.9.3.4 Robustness

Robustness was determined by analyzing an absorbance of crocin in the extract sample added with 30 µg/ml of standard crocin at slightly different wavelengths (433, 434, 435 nm) and 6 replicates of each wavelength were determined.

## 3.10 Crocin component analysis

Crocin components of *G. jasminoides* fruit from 12 sources were determined by using TLC-densitometry method. The extracts of *G. jasminoides* fruits and standard

crocin were separated by TLC. Three  $\mu\text{l}$  of 3 concentration levels of standard crocin (7.5, 10, 12.5  $\mu\text{g}/\text{spot}$ ) and extracted sample solutions (100 mg/ml) were applied on silica gel 60 GF<sub>254</sub> TLC plate (0.2 mm thickness, 10 cm x 20 cm) as 7 mm band with a Linomat V automatic sample spotter (Camag, Switzerland). The mobile phase ratio of n-butanol: acetic acid: water was 4:1:1 [101]. Densitometric analysis was carried out at 434 nm using a TLC Scanner 3 (Camag, Switzerland) with winCATS software.

### 3.11 Molecular analysis

Eleven *Gardenia* species were identified and evaluated of genetic relationship based on RAPD method.

#### 3.11.1 DNA isolation

Genomic DNA was individually extracted from the fresh young leaves of *Gardenia* species and out-group samples using CTAB modified method and DNeasy Plant Mini Kit (QIAGEN). The obtained DNA was run on 1 % agarose gel, stained with ethidium bromide (0.5  $\mu\text{g}/\text{ml}$ ) and photographed under UV light (INGENIUS3, SYNGENE). The DNA quality and quantity was estimated by measuring the absorbance at 260 nm and 280 nm using spectrophotometer (SPECORD210/PLUS, Germany). The extracted genomic DNA were diluted with 1 x TE (Tris-EDTA) buffer to make the final concentration of 10 ng/ $\mu\text{l}$  and stored at -20°C for DNA template in RAPD analysis.



### 3.11.1.1 CTAB modified method [77]

Ten grams of young fresh leaves were grounded in liquid nitrogen using mortar and pestle prior to the addition of 500  $\mu$ l of CTAB buffer (2% w/v CTAB, 100 mM Tris-HCl, 20 mM EDTA, 1.4 M NaCl, pH 8.0) and incubated at 65°C for 1 hour. The homogenate was then extracted with an equal volume of phenol and centrifuged at 12000 rpm for 10 minutes. The upper aqueous phase was then extracted with one volume of chloroform: isoamyl alcohol (24:1). The mixture was centrifuged for 10 minutes at 12000 rpm and the supernatant was removed. Add 1:10 volume of 5M sodium acetate, invert tube and followed by ethanol precipitation of the DNA. The DNA pellet was washed with 70% ethanol, dried and resuspended in 100  $\mu$ l of TE buffer (1 mM EDTA, pH 8, 10 mM Tris-HCl) by gentle mixing.

### 3.11.1.2 DNeasy Plant Mini Kit

DNeasy Plant Mini Kit was used to extract DNA from some plant samples which has problem of no DNA yield extraction by CTAB modified method. According to the manufacturer's instructions, 100 milligrams of young fresh leaves were grounded in liquid nitrogen using mortar and pestle prior to the addition of 400  $\mu$ l buffer AP1 and 4  $\mu$ l RNase A and then vortexed, incubated for 10 minutes at 65°C. During incubation, the tube was inverted 2-3 times. Add 130  $\mu$ l Buffer P3, mix and incubate for 5 minutes on ice. The mixture was centrifuged for 5 minutes at 14000 rpm and the supernatant was pipetted into a QIAshredder spin column, centrifuge for

2 minutes at 14000 rpm. The flow-through was transferred into a new tube without disturbing the pellet if present. Add 1.5 volumes of Buffer AW1, mix by pipetting. The mixture was transferred into a DNeasy Mini spin column and centrifuged for 1 minute at 8000 rpm. The flow-through was discarded. The spin column was placed into a new collection tube and then add 500 µl buffer AW2, and centrifuge for 1 minute at 8000 rpm, discard the flow-through. Add another 500 µl Buffer AW2, centrifuge for 2 minutes at 14000 rpm. The spin column was transferred to a new microcentrifuge tube and then add 100 µl buffer AE for elution. Incubate for 5 minutes at room temperature and then centrifuge for 1 minute at 8000 rpm.

### 3.11.2 RAPD analysis

The optimum RAPD reaction conditions were selected by varying several parameters of DNA concentration, MgCl<sub>2</sub> concentration, primer concentration, *Taq* DNA polymerase concentration and dNTP concentration.

Best RAPD cycling conditions was modified from standard RAPD cycles [102] and was used for RAPD analysis.

RAPD analysis was initially screened using 90 commercial primers (Operon Technology). The amplification reaction was carried out in 20 µl reaction and optimized PCR solution contained of 1x *GoTaq* Green Master Mix (Promega), 5.0 mM Mg<sup>2+</sup>, 2 ng DNA template and 0.8 µM primer. The PCR cycle was carried out with the initial denaturation at 94°C for 2 minutes followed by 45 cycles of 94°C for 30 s, 36°C

for 2 minutes, 72°C for 2 minutes and a final extension of 72°C for 7 minutes using thermal cycler (ProFlex PCR System). A negative control without template DNA was included in each set of reactions to avoid misinterpretation of data associated with DNA contamination. The amplified fragments were separated on 1.5% agarose gel electrophoresis along with 100 bp DNA ladder and 1Kb (BioRad) as DNA markers. Gels were stained with ethidium bromide (0.5 µg/ml), visualized and photographed under UV light (INGENIUS3, SYNGENE).

### 3.11.3 RAPD data analysis

RAPD bands were scored as either present (1) or absent (0) to create a binary data set and entered into a binary data matrix as discrete variable. Nei & Li similarity coefficient was calculated for all pair-wise species. A dendrogram was constructed using the unweighted pair-group method with arithmetic averages (UPGMA) clustering by GeneTools and GeneDirectory software (SYNGENE).

### 3.12 Data analysis

All experiments were performed at least in triplicate and the results expressed as mean  $\pm$  standard deviation (SD). The data analysis of physicochemical parameters were finally calculated as grand mean  $\pm$  pooled standard deviation (SD).

## CHAPTER IV

### RESULTS

The present study was performed on 3 aspects including 1. macroscopic and microscopic evaluation and RAPD characterization of eleven selected *Gardenia* species, 2. pharmacognostic evaluation of *G. jasminoides* fruit, and 3. crocin content analysis of *G. jasminoides* fruit using spectrophotometric method and crocin component analysis using TLC-densitometric methods. All of the results are described below.

#### 4.1 *Gardenia* species examination

Eleven species of *Gardenia* namely *G. carinata*, *G. collinsae*, *G. griffithii*, *G. jasminoides*, *G. lineata*, *G. obtusifolia*, *G. sootepensis*, *G. thailandica*, *G. taitensis*, *G. tubifera* and *G. vietnamensis* were examined based on macroscopic, microscopic and molecular evaluations.

##### 4.1.1 Macroscopic evaluation

Macroscopic evaluation of 11 *Gardenia* species were demonstrated and branch drawing were shown in **Figure 13-23**.

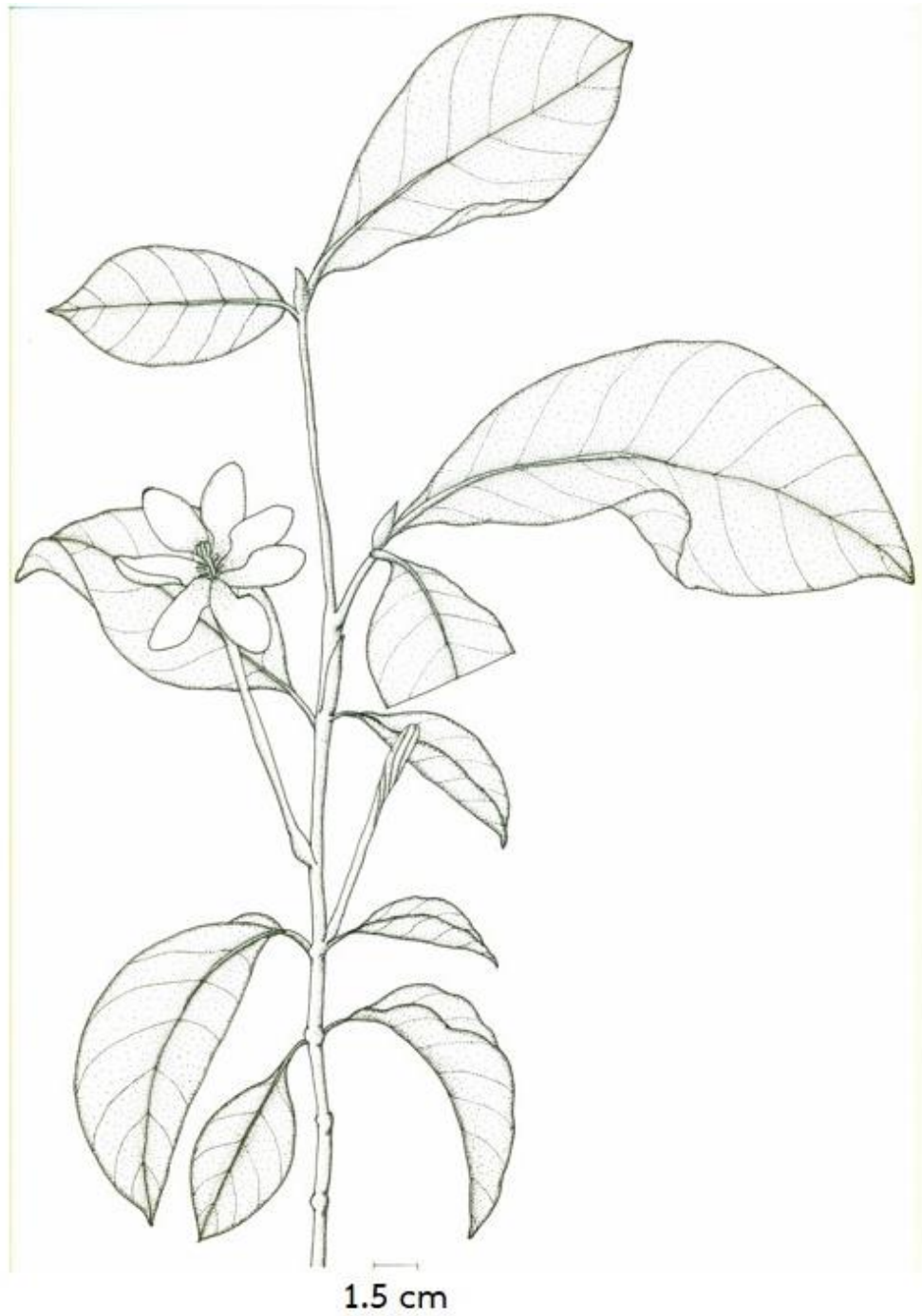


Figure 13 Branch of *Gardenia carinata* Wall. Ex Roxb.

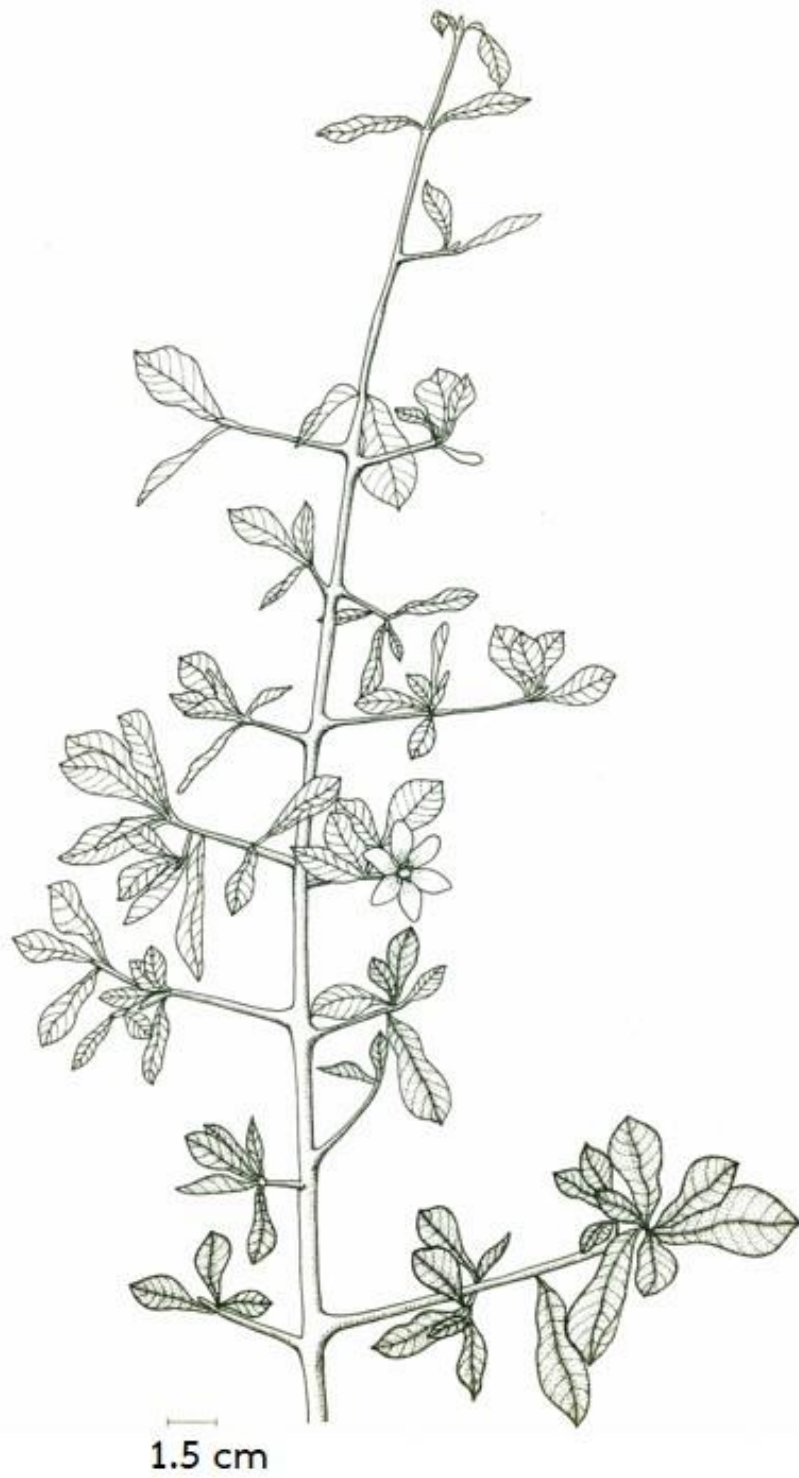


Figure 14 Branch of *Gardenia collinsae* Craib

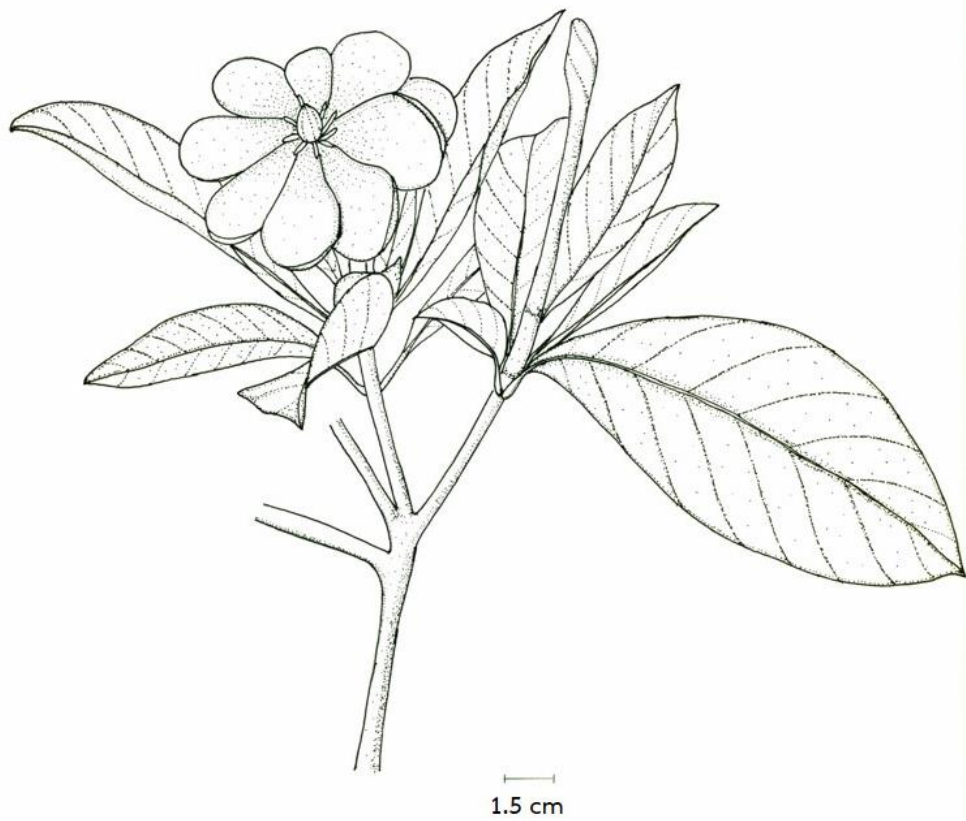


Figure 15 Branch of *Gardenia griffithii* Hook. f.



Figure 16 Branch of *Gardenia jasminoides* Ellis (a); fruit (b)





Figure 17 Branch of *Gardenia lineata* (Craib) Tirveng.

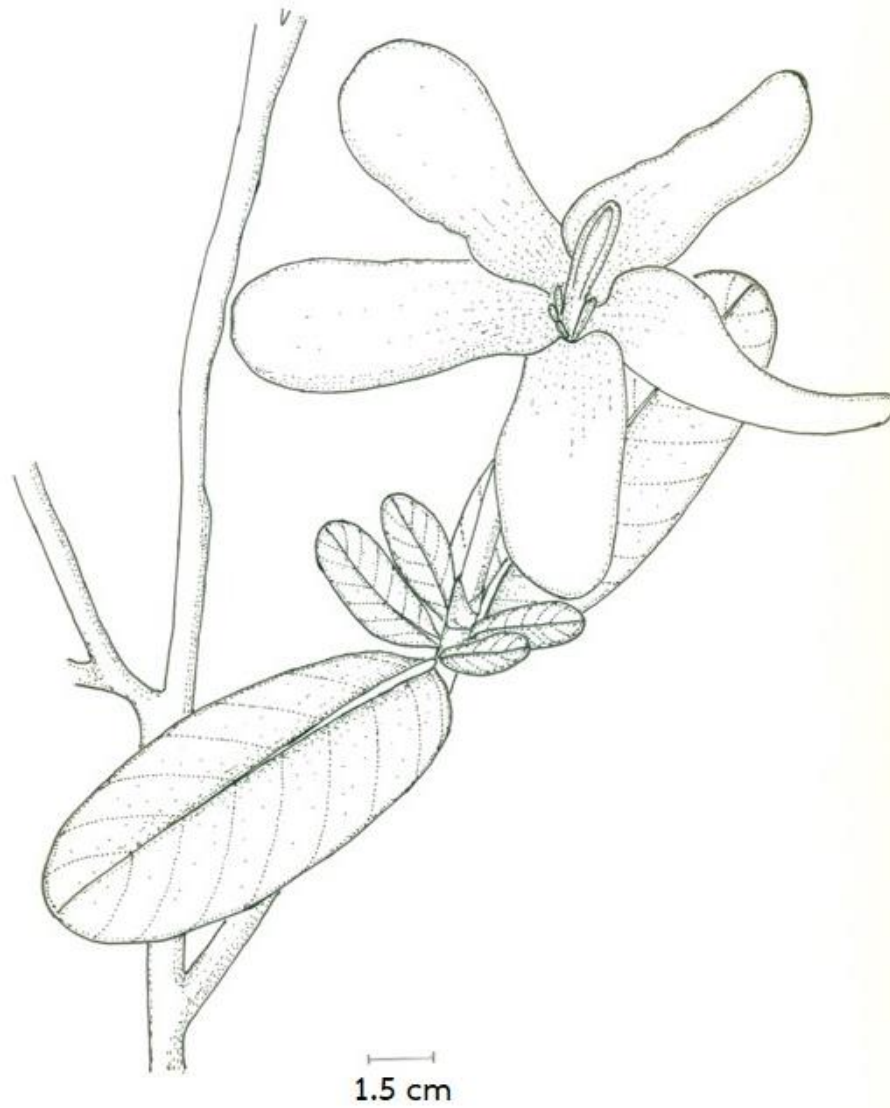


Figure 18 Branch of *Gardenia obtusifolia* Roxb. ex Hook. f.

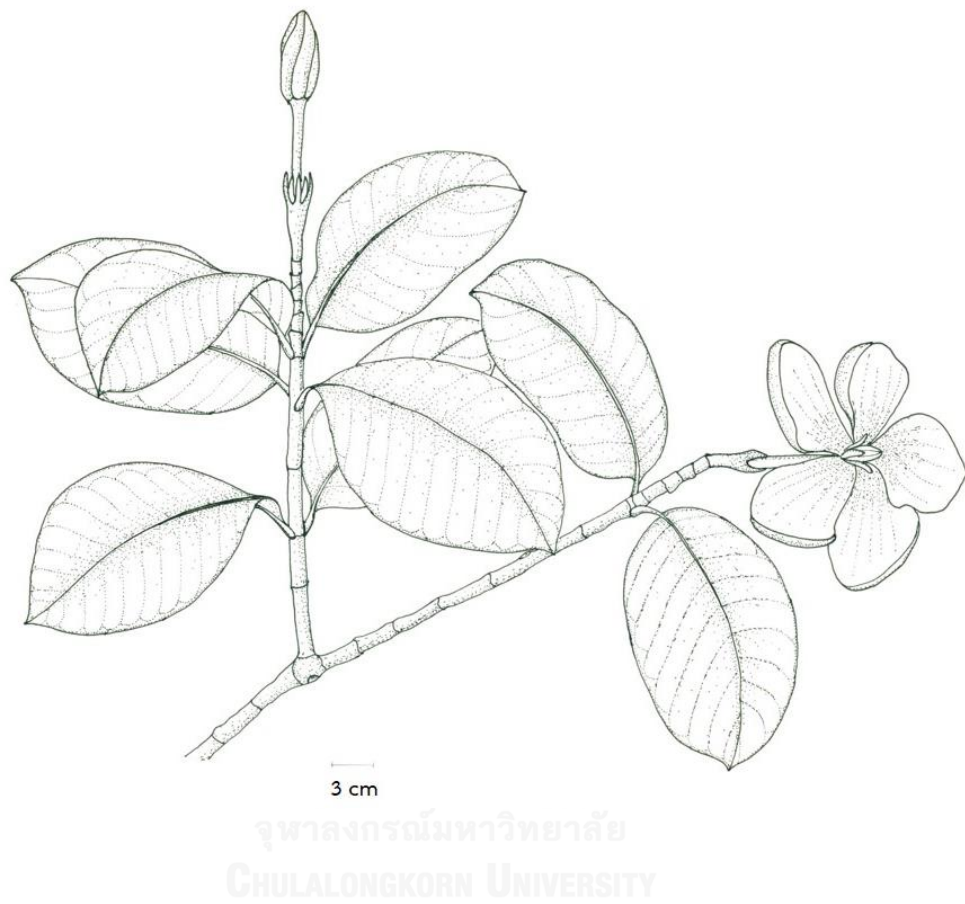


Figure 19 Branch of *Gardenia sootepensis* Hutch.



จุฬาลงกรณ์มหาวิทยาลัย  
CHULALONGKORN UNIVERSITY

Figure 20 Branch of *Gardenia thailandica* Tirveng

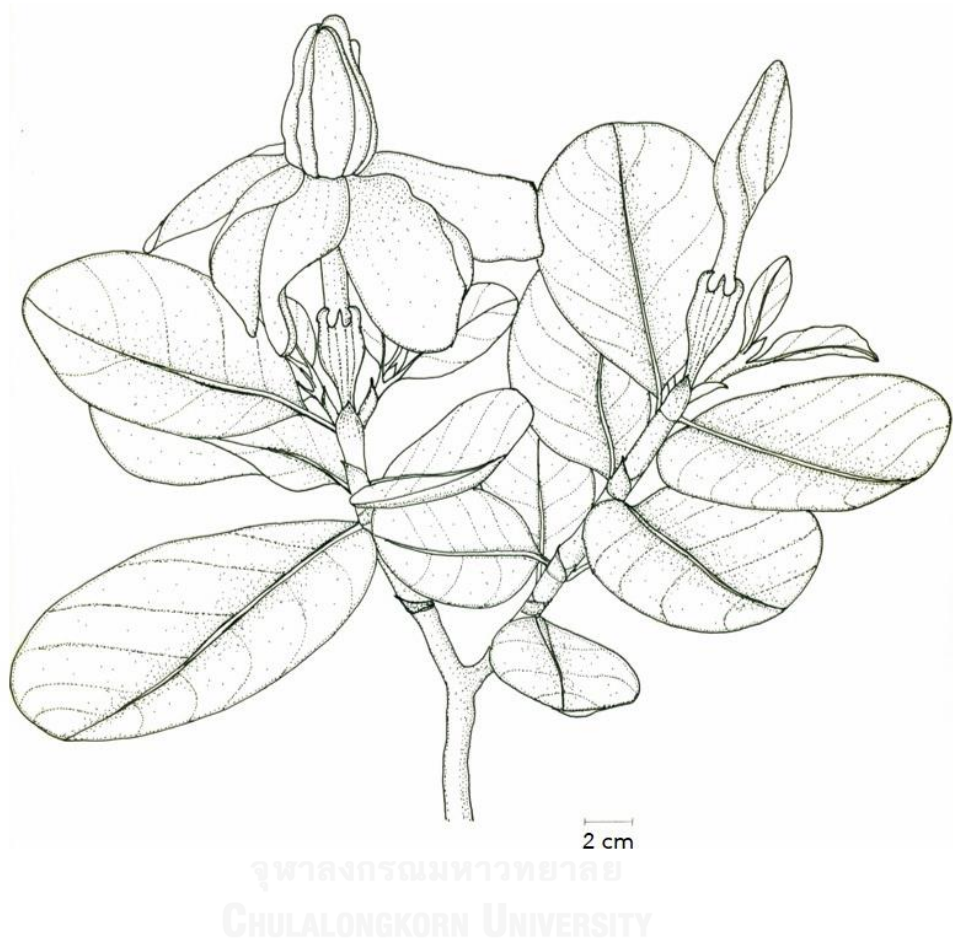
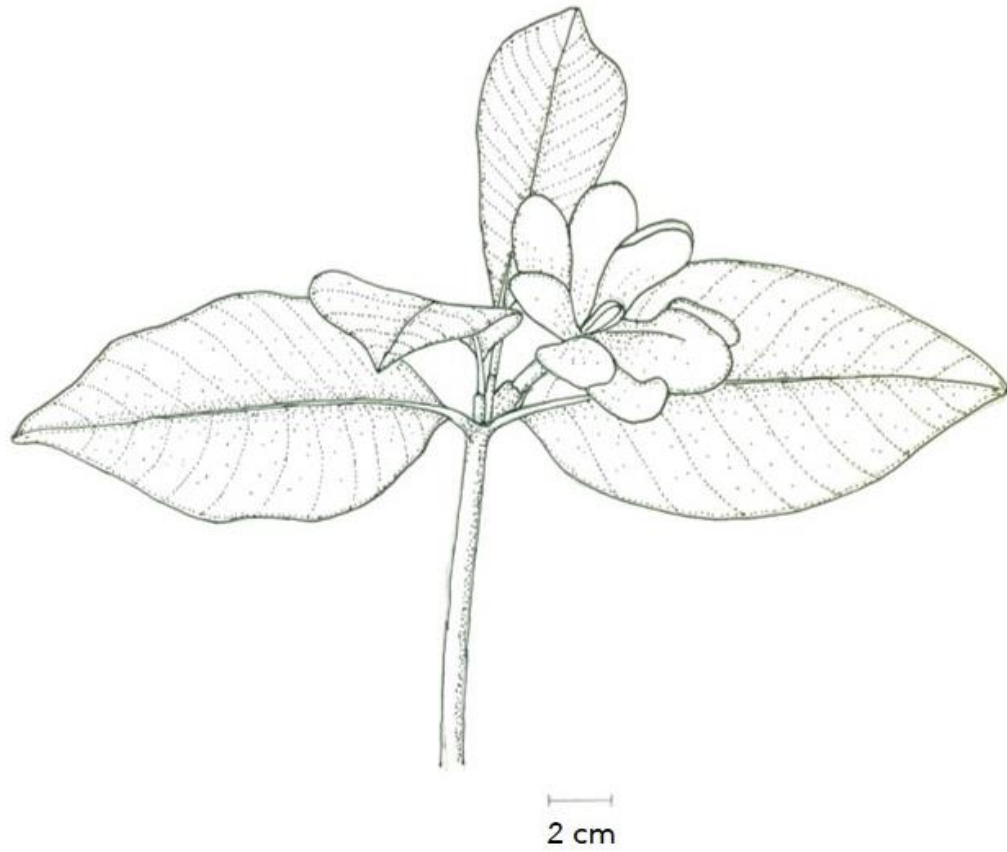


Figure 21 Branch of *Gardenia taitensis* DC.



CHULALONGKORN UNIVERSITY

Figure 22 Branch of *Gardenia tubifera* Wall.

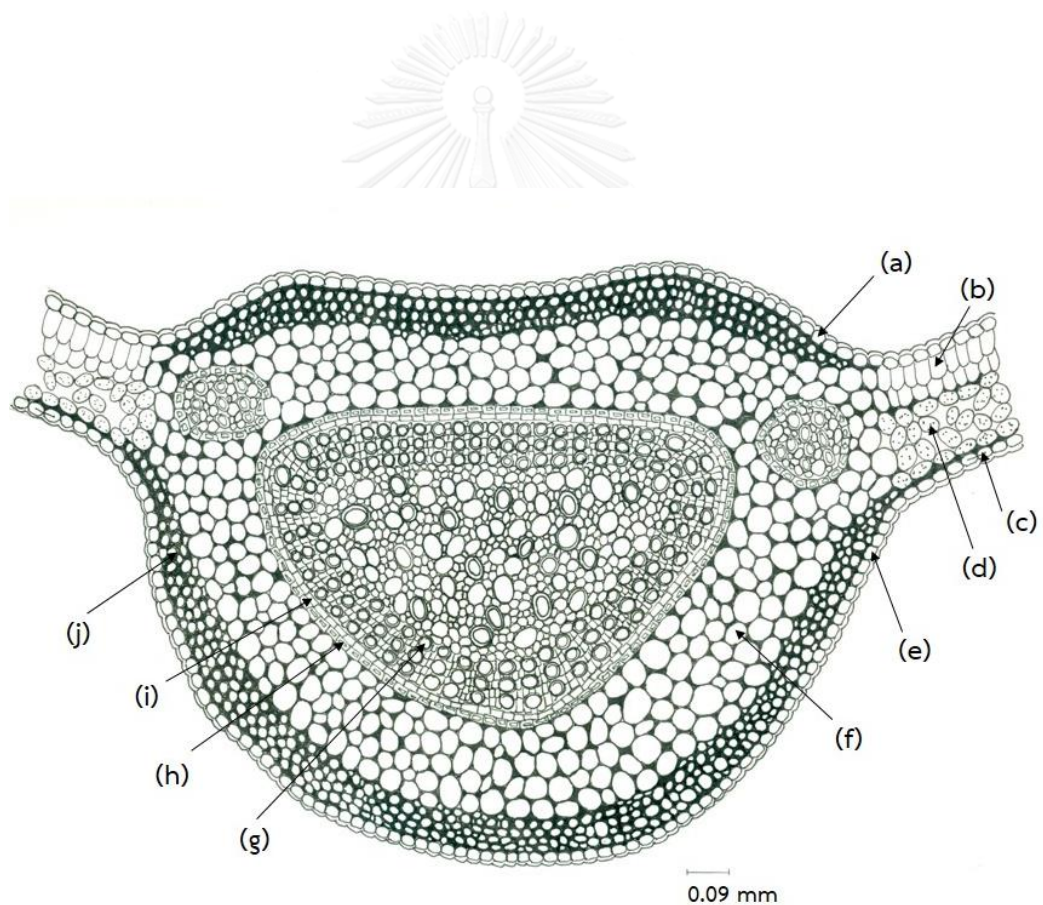


Figure 23 Branch of *Gardenia vietnamensis*

## 4.1.2 Microscopic evaluation

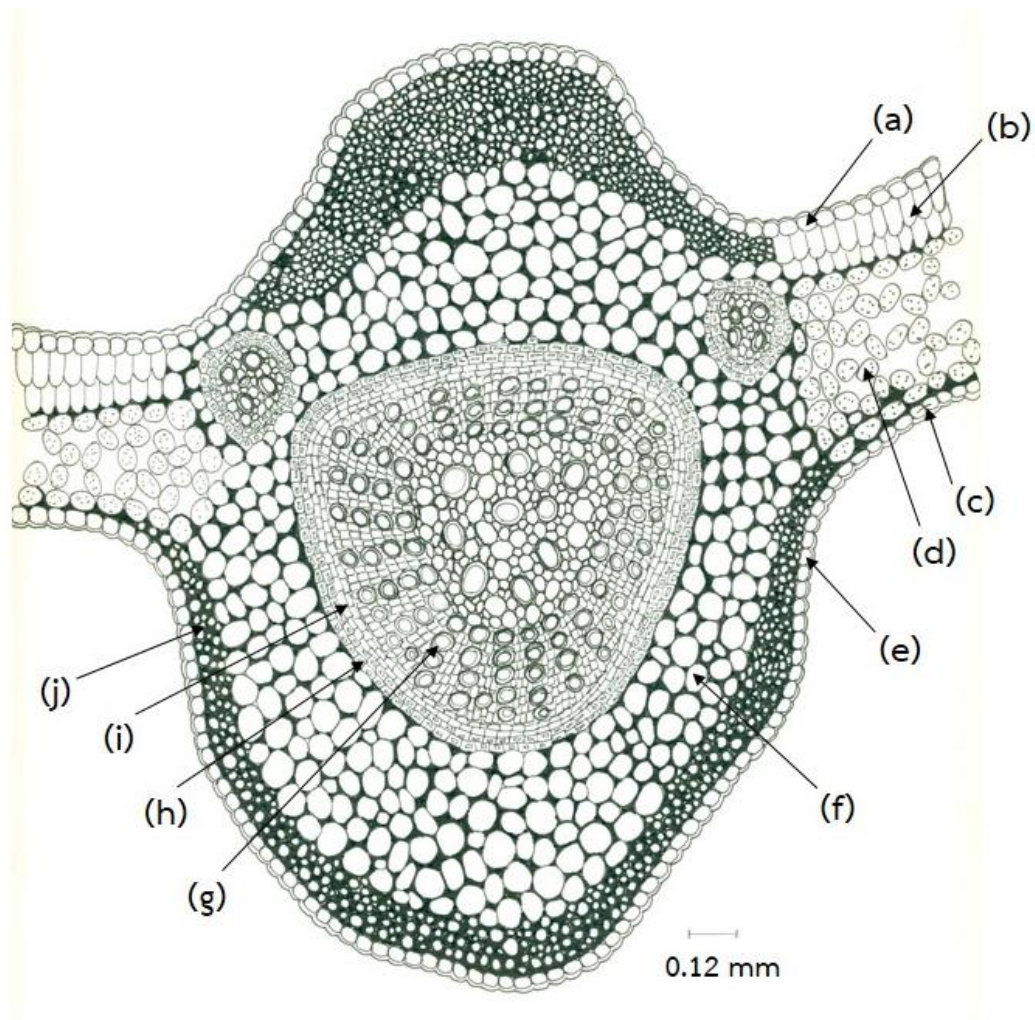
### 4.1.2.1 Transverse section of leaf

Transverse section through the midrib region of the leaf of eleven *Gardenia* species was investigated (Figure 24-34). Midrib cross section of all *Gardenia* species showed upper epidermis, palisade cell, stomata, spongy cell, lower epidermis, parenchyma, xylem vessel, fiber, phloem tissue and collenchyma.

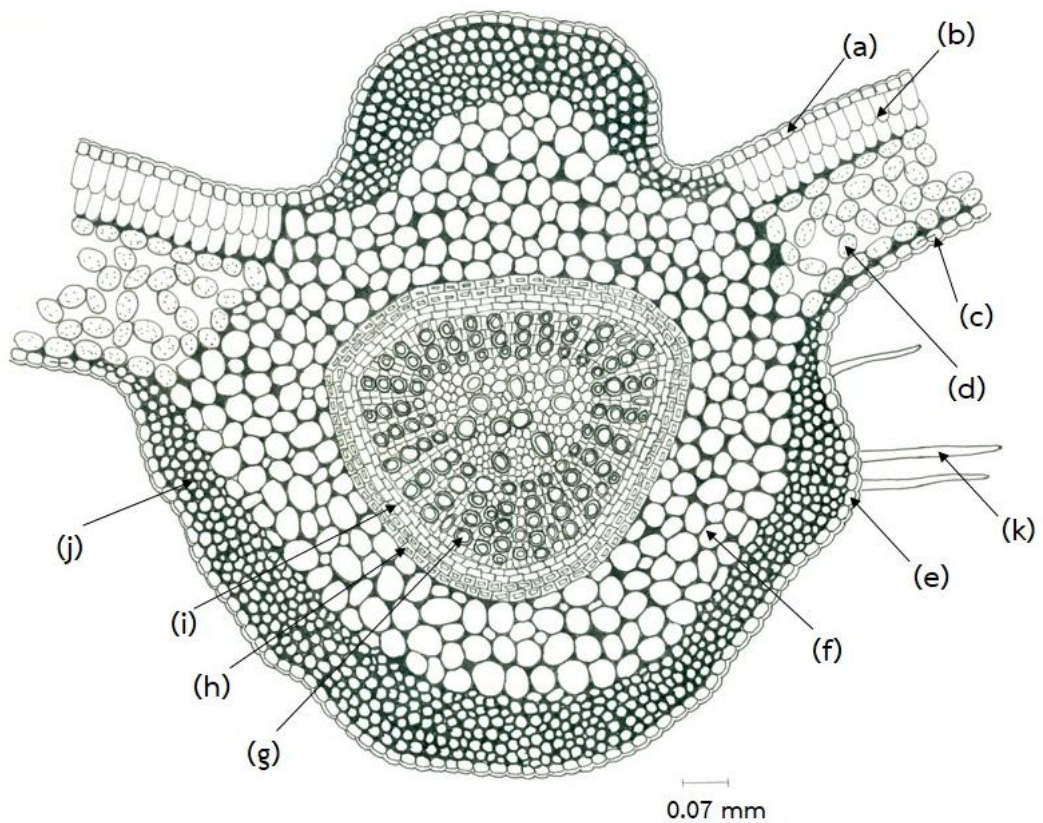


**Figure 24** Transverse section of leaf midrib of *Gardenia carinata*: upper epidermis (a); palisade cell (b); stomata (c); spongy cell (d); lower epidermis (e); parenchyma (f); xylem vessel (g); fiber (h); phloem tissue (i); collenchyma (j)

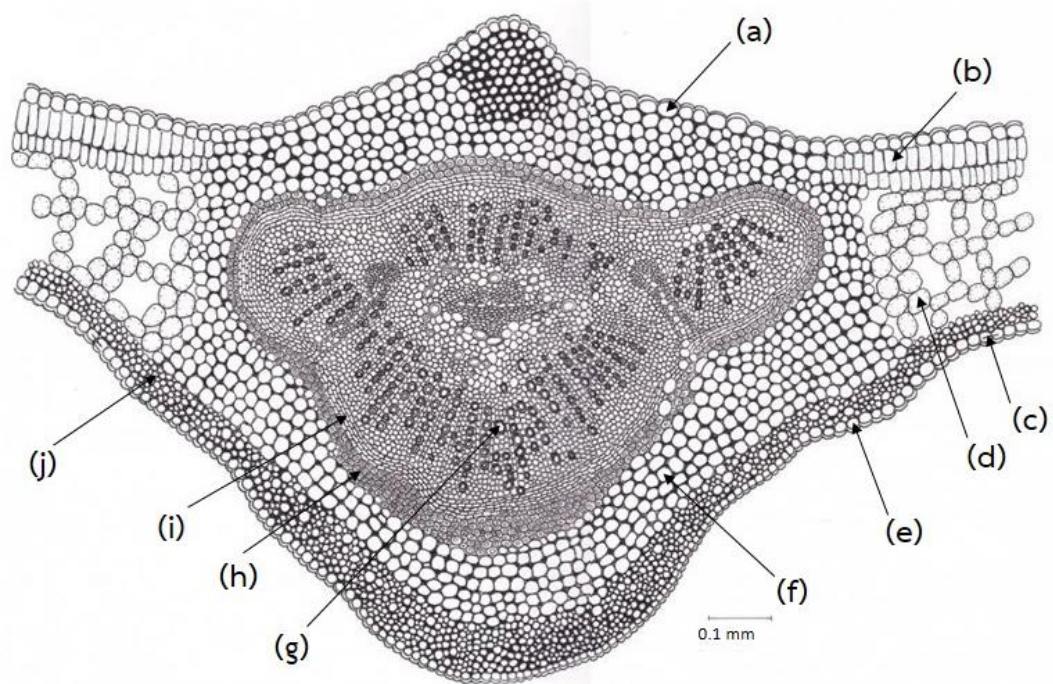




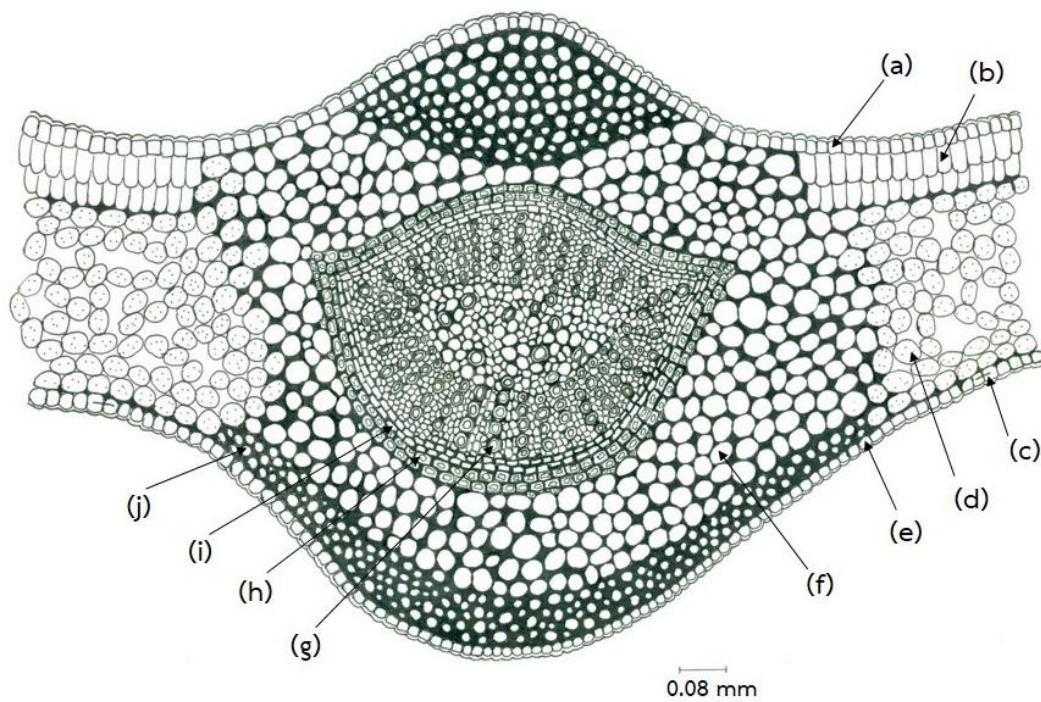
**Figure 25** Transverse section of leaf midrib of *Gardenia collinsae*: upper epidermis (a); palisade cell (b); stomata (c); spongy cell (d); lower epidermis (e); parenchyma (f); xylem vessel (g); fiber (h); phloem tissue (i); collenchyma (j)



**Figure 26** Transverse section of leaf midrib of *Gardenia griffithii*: upper epidermis (a); palisade cell (b); stomata (c); spongy cell (d); lower epidermis (e); parenchyma (f); xylem vessel (g); fiber (h); phloem tissue (i); collenchyma (j); trichome (k)

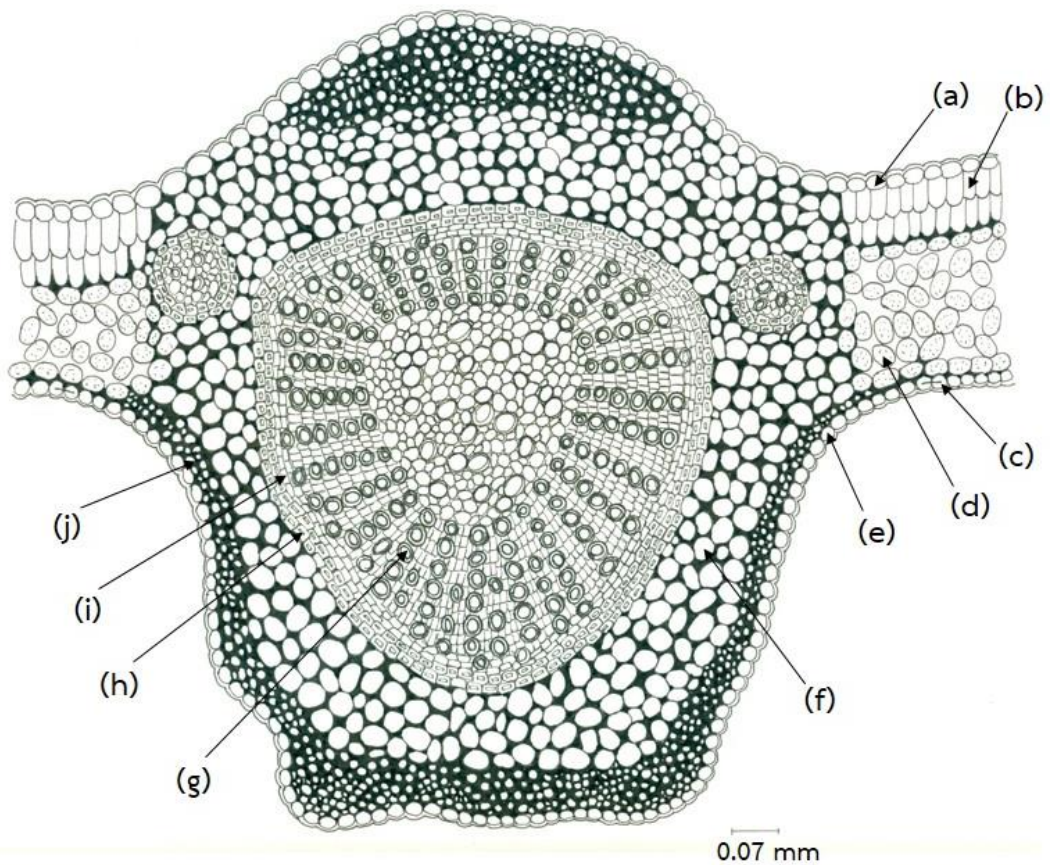


**Figure 27** Transverse section of leaf midrib of *Gardenia jasminoides*: upper epidermis (a); palisade cell (b); stomata (c); spongy cell (d); lower epidermis (e); parenchyma (f); xylem vessel (g); fiber (h); phloem tissue (i); collenchyma (j)

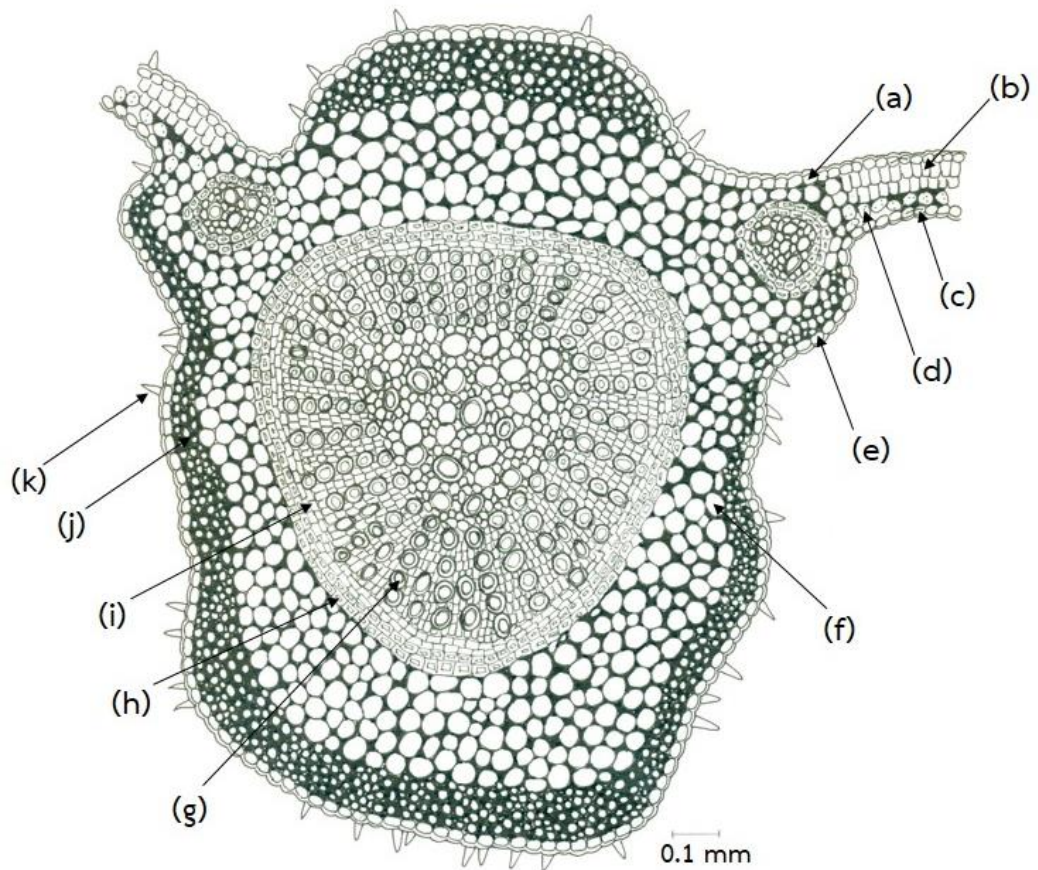


CHULALONGKORN UNIVERSITY

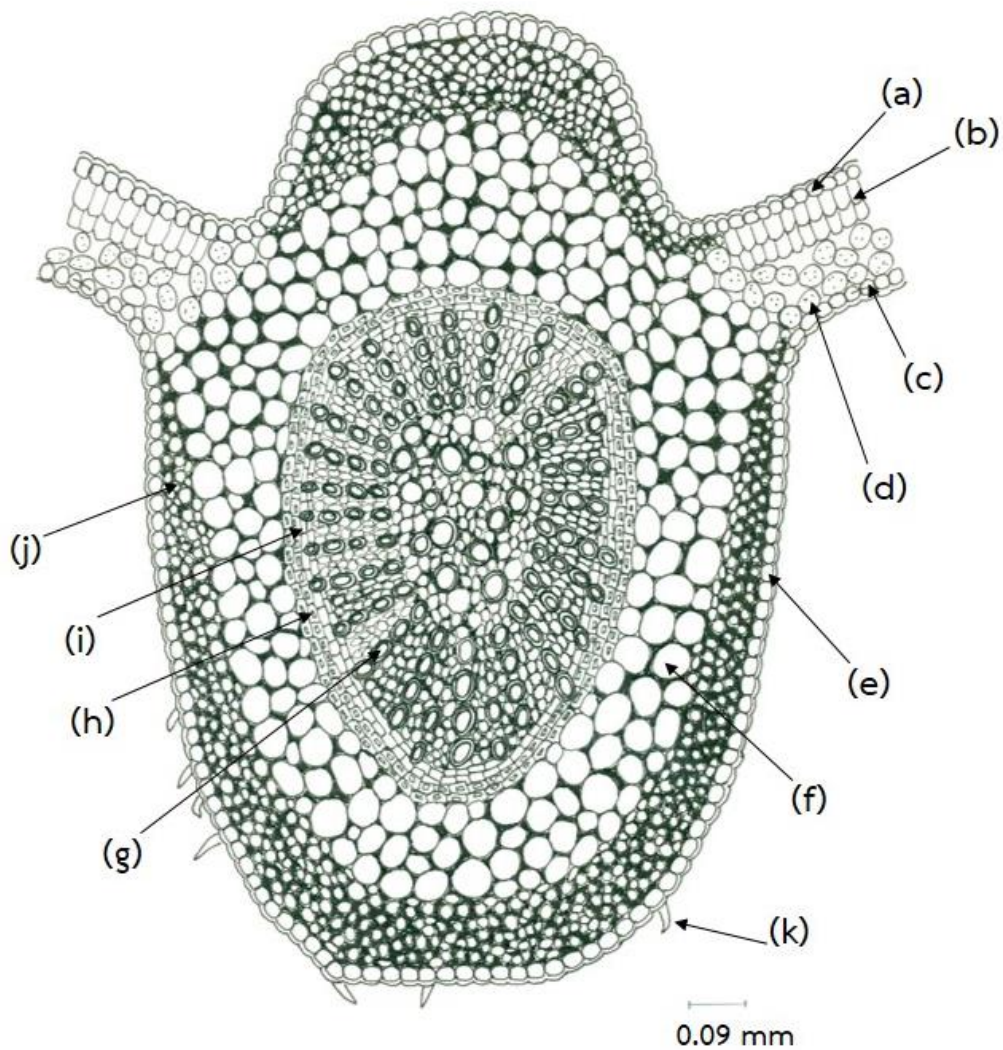
**Figure 28** Transverse section of leaf midrib of *Gardenia lineata*: upper epidermis (a); palisade cell (b); stomata (c); spongy cell (d); lower epidermis (e); parenchyma (f); xylem vessel (g); fiber (h); phloem tissue (i); collenchyma (j)



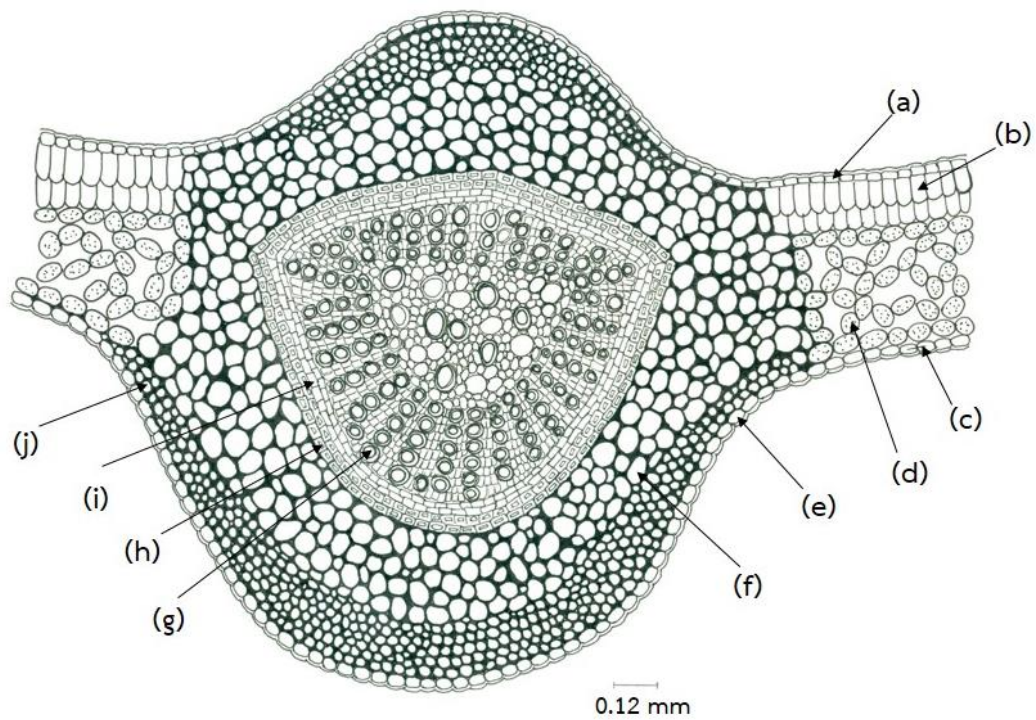
**Figure 29** Transverse section of leaf midrib of *Gardenia obtusifolia*: upper epidermis (a); palisade cell (b); stomata (c); spongy cell (d); lower epidermis (e); parenchyma (f); xylem vessel (g); fiber (h); phloem tissue (i); collenchyma (j)



**Figure 30** Transverse section of leaf midrib of *Gardenia sootepensis*: upper epidermis (a); palisade cell (b); stomata (c); spongy cell (d); lower epidermis (e); parenchyma (f); xylem vessel (g); fiber (h); phloem tissue (i); collenchyma (j); trichome (k)

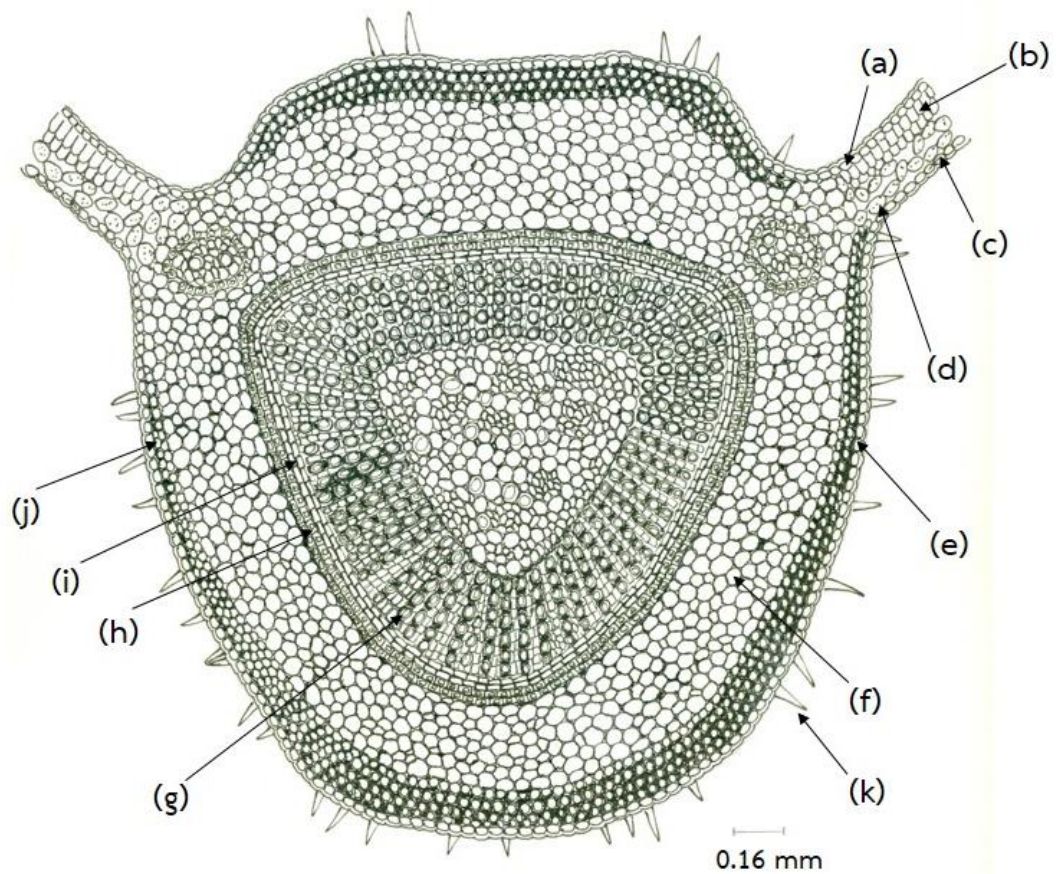


**Figure 31** Transverse section of leaf midrib of *Gardenia thailandica*: upper epidermis (a); palisade cell (b); stomata (c); spongy cell (d); lower epidermis (e); parenchyma (f); xylem vessel (g); fiber (h); phloem tissue (i); collenchyma (j); trichome (k)

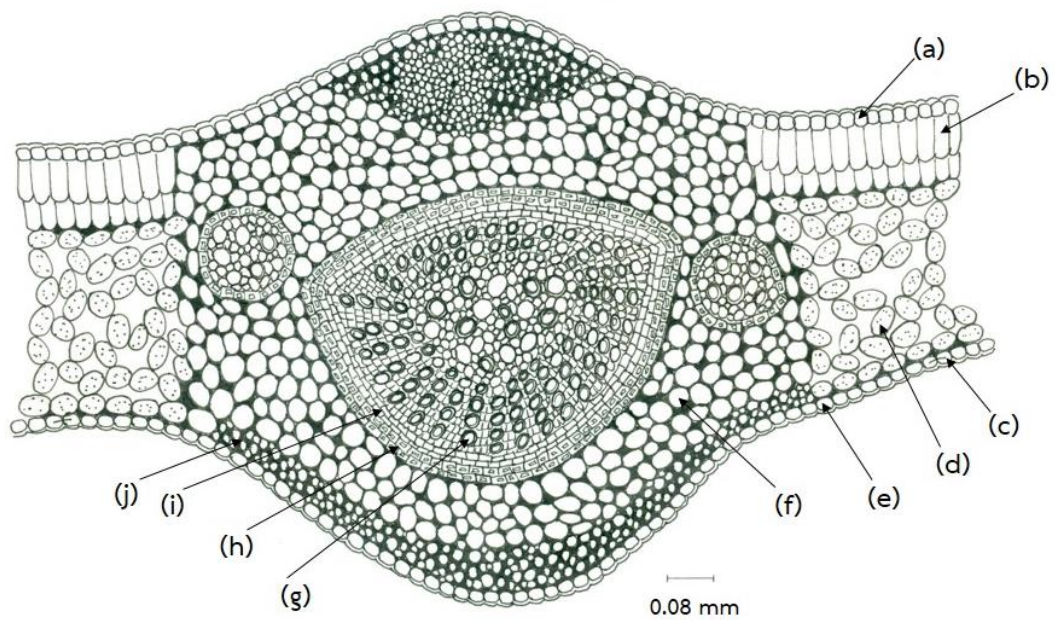


**Figure 32** Transverse section of leaf midrib of *Gardenia taitensis*: upper epidermis (a); palisade cell (b); stomata (c); spongy cell (d); lower epidermis (e); parenchyma (f); xylem vessel (g); fiber (h); phloem tissue (i); collenchyma (j)





**Figure 33** Transverse section of leaf midrib of *Gardenia tubifera*: upper epidermis (a); palisade cell (b); stomata (c); spongy cell (d); lower epidermis (e); parenchyma (f); xylem vessel (g); fiber (h); phloem tissue (i); collenchyma (j); trichome (k)

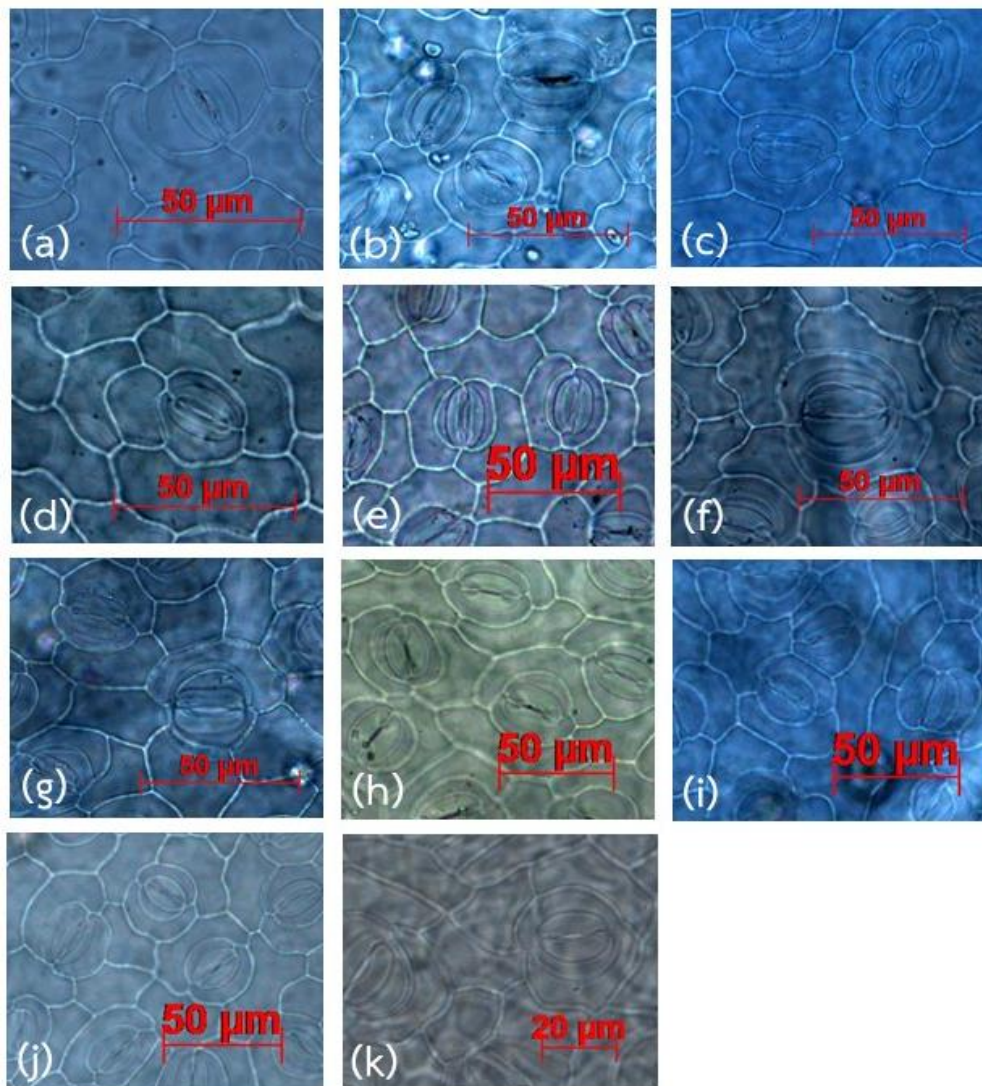


**Figure 34** Transverse section of leaf midrib of *Gardenia vietnamensis*: upper epidermis (a); palisade cell (b); stomata (c); spongy cell (d); lower epidermis (e); parenchyma (f); xylem vessel (g); fiber (h); phloem tissue (i); collenchyma (j)

#### 4.1.2.2 Type of stomata

The distribution of the stomata is hypostomatic in eleven species (stomata occurring only on lower surface) of the taxa studied. Stomatal types are generally paracytic in eleven *Gardenia* species (**Figure 35**).

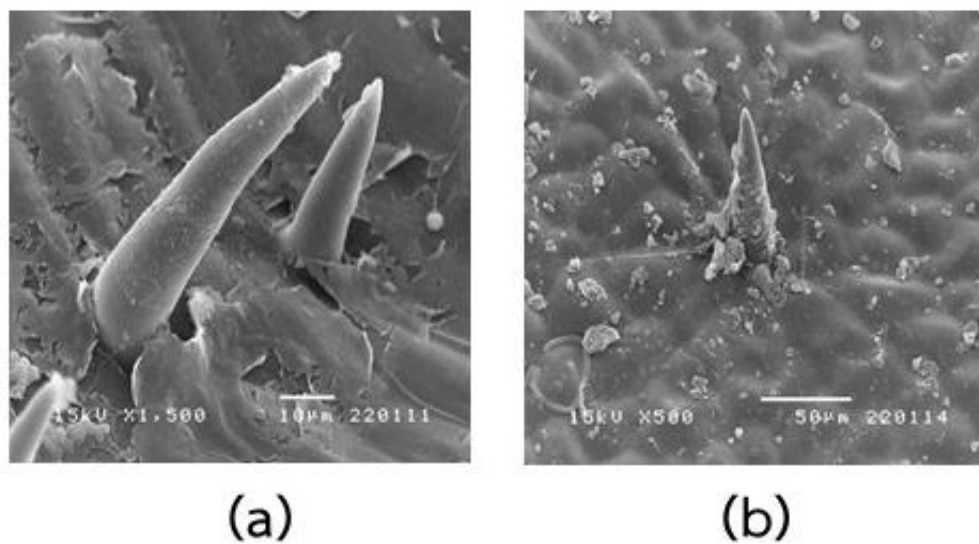




**Figure 35** Photographs of leaf epidermal cells of eleven *Gardenia* species: Lower surface of *G. carinata* (a); *G. collinsae* (b); *G. griffithii* (c); *G. jasminoides* (d); *G. lineata* (e); *G. obtusifolia* (f); *G. sootepensis* (g); *G. taitensis* (h); *G. thailandica* (i); *G. vietnamensis* (j); *G. tubifera* (k)

#### 4.1.2.3 Leaf measurement

The mature fresh leaves of eleven *Gardenia* species were subjected to quantitative analysis for leaf constants including stomatal number, stomatal index, palisade ratio, epidermal cell number, epidermal cell area and trichome number. The results are shown in Table 4.1-4.3. The highest stomatal index ( $32.62 \pm 1.37$ ) obtained from *G. taitensis* and the lowest ( $17.24 \pm 0.67$ ) from *G. tubifera*. *Gardenia tubifera* exhibited the highest epidermal cell number ( $4261.0 \pm 80.04$ ) but exhibited the lowest epidermal cell area ( $234.7 \pm 4.39 \mu\text{m}^2$ ) whereas *G. collinsae* exhibited the lowest epidermal cell number ( $439.6 \pm 17.19$ ) but exhibited the highest epidermal cell area ( $2278.5 \pm 89.48 \mu\text{m}^2$ ). The largest palisade ratio was found in *G. sootepensis* ( $18.80 \pm 0.88$ ) and the lowest was found in *G. tubifera* ( $4.12 \pm 0.34$ ). The density of non-glandular trichomes, unicellular and simple unbranched were observed in the lower surface of *G. sootepensis* and *G. tubifera* (**Figure 36**).



**Figure 36** Scanning electron microscope of trichome of *Gardenia sootepensis*: non glandular, unicellular trichome occurred on lower surface (a); non glandular, unicellular trichome occurred on upper surface (b)

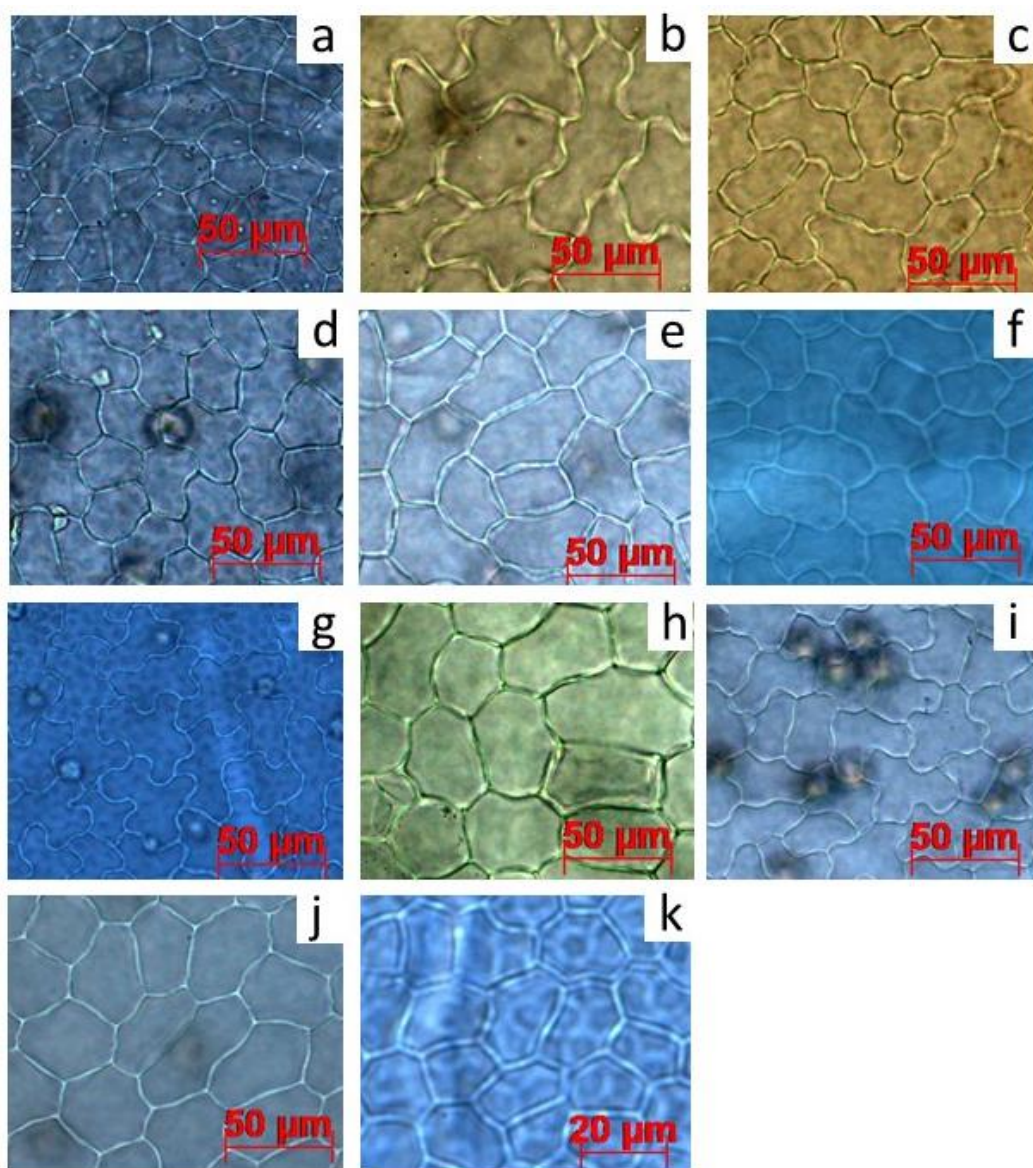
**Table 6** Stomatal number and stomatal index of *Gardenia* species

<i>Gardenia</i> species	Stomatal number		Stomatal index	
	min-max	mean±SD	min-max	mean±SD
<i>G. tubifera</i>	400-575	466.39±33.34	15.69-19.17	17.24±0.67
<i>G. carinata</i>	312-484	380.49±30.05	15.56-24.41	19.58±1.48
<i>G. vietnamensis</i>	216-312	261.73±23.08	15.63-25.09	20.73±1.88
<i>G. jasminoides</i>	212-368	277.60±31.28	14.66-25.61	21.47±1.88
<i>G. collinsae</i>	376-444	405.73±11.38	21.93-25.06	23.59±0.50
<i>G. griffithii</i>	400-456	417.07±12.87	24.41-25.97	25.23±0.38
<i>G. sootepensis</i>	356-448	403.47±17.79	24.81-27.92	26.02±0.74
<i>G. lineata</i>	380-444	415.96±14.07	25.64-28.42	27.04±0.63
<i>G. thailandica</i>	508-588	537.91±18.85	27.79-29.30	28.40±0.33
<i>G. obtusifolia</i>	524-700	583.38±39.80	27.02-30.79	28.64±0.66
<i>G. taitensis</i>	292-344	319.29±12.69	29.80-35.56	32.62±1.37

**Table 7** Epidermal cell number and epidermal cell area of *Gardenia* species

<i>Gardenia</i> species	Epidermal cell number		Epidermal cell area ( $\mu\text{m}^2$ )	
	min-max	mean $\pm$ SD	min-max	mean $\pm$ SD
<i>G. tubifera</i>	4100.0-4400.0	4261.0 $\pm$ 80.04	227.27-243.90	234.7 $\pm$ 4.39
<i>G. carinata</i>	1940.0-2316.0	2119.3 $\pm$ 70.09	431.78-515.46	472.4 $\pm$ 15.36
<i>G. vietnamensis</i>	652.0-772.0	714.0 $\pm$ 28.54	1295.34-1533.74	1402.7 $\pm$ 56.17
<i>G. jasminoides</i>	884.0-1116.0	1028.2 $\pm$ 53.63	896.06-1131.22	975.2 $\pm$ 52.87
<i>G. collinsae</i>	400.0-476.0	439.6 $\pm$ 17.19	2100.84-2500.00	2278.5 $\pm$ 89.48
<i>G. griffithii</i>	1184.0-1652.0	1420.3 $\pm$ 112.61	605.33-844.59	708.4 $\pm$ 54.88
<i>G. sootepensis</i>	804.0-936.0	887.1 $\pm$ 27.06	902.53-1243.78	1076.1 $\pm$ 82.61
<i>G. lineata</i>	940.0-1124.0	1015.3 $\pm$ 36.81	889.68-1063.83	986.1 $\pm$ 34.97
<i>G. thailandica</i>	1264.0-1396.0	1331.8 $\pm$ 34.67	716.33-791.14	751.4 $\pm$ 19.59
<i>G. obtusifolia</i>	1084.0-1404.0	1262.7 $\pm$ 61.57	712.25-922.51	793.8 $\pm$ 39.07
<i>G. taitensis</i>	748.0-912.0	826.5 $\pm$ 46.65	1096.49-1336.90	1213.8 $\pm$ 67.98

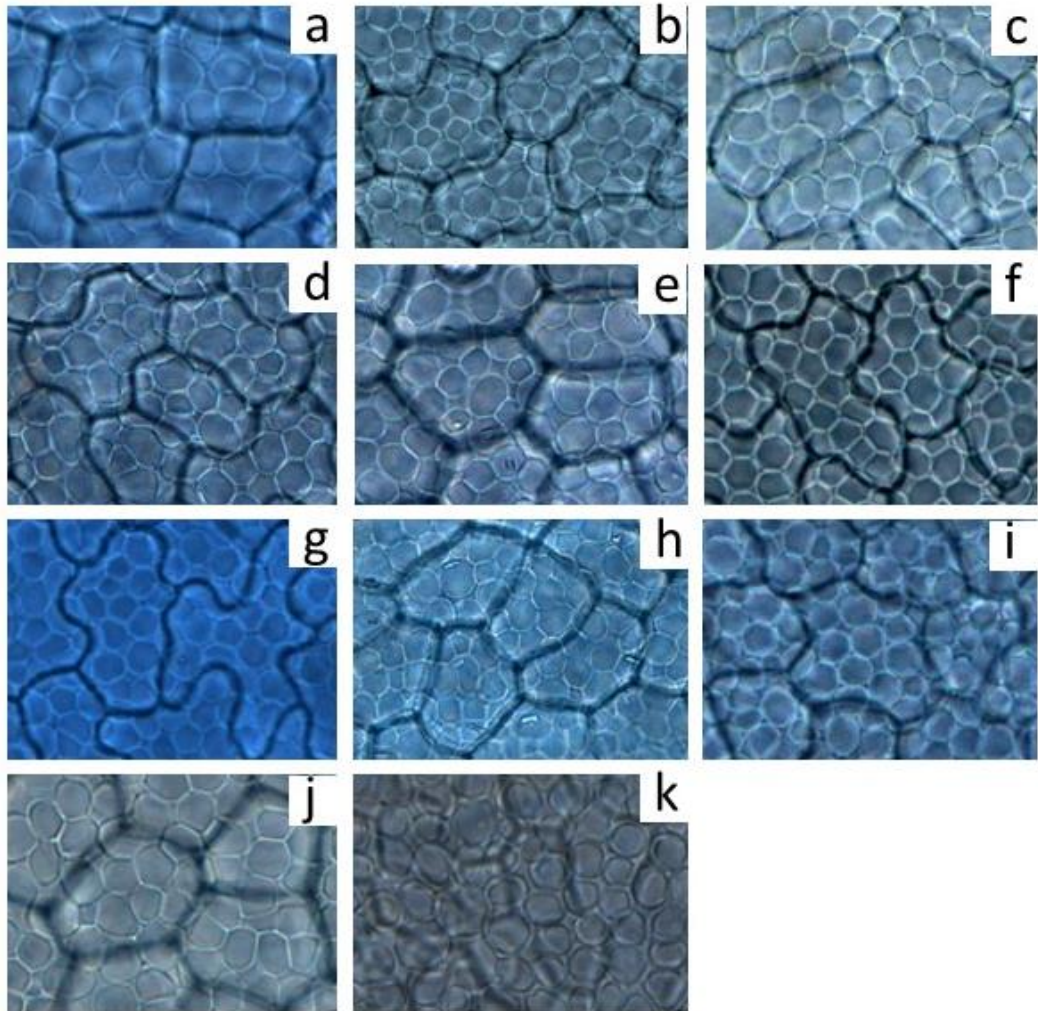




**Figure 37** Photographs of upper epidermal cells of eleven *Gardenia* species: *G. carinata* (a); *G. collinsae* (b); *G. griffithii* (c); *G. jasminoides* (d); *G. lineata* (e); *G. obtusifolia* (f); *G. sootepensis* (g); *G. taitensis* (h); *G. thailandica* (i); *G. vietnamensis* (j); *G. tubifera* (k)

**Table 8** Palisade ratio and trichome number of *Gardenia* species

<i>Gardenia</i> species	Palisade ratio		Trichome number	
	min-max	mean±SD	min-max	mean±SD
<i>G. tubifera</i>	3.25-4.75	4.12±0.34	8-16	11.11±2.92
<i>G. carinata</i>	3.62-5.75	4.60±0.52	-	-
<i>G. vietnamensis</i>	12.12-14.62	13.30±0.46	-	-
<i>G. jasminoides</i>	10.00-11.62	10.67±0.39	-	-
<i>G. collinsae</i>	14.88-17.25	15.96±0.55	-	-
<i>G. griffithii</i>	7.50-8.88	8.13±0.38	-	-
<i>G. sootepensis</i>	16.62-21.00	18.80±0.88	12-28	17.95±3.71
<i>G. lineata</i>	9.75-11.50	10.49±0.42	-	-
<i>G. thailandica</i>	9.62-11.62	10.44±0.36	-	-
<i>G. obtusifolia</i>	11.50-14.62	12.84±0.65	-	-
<i>G. taitensis</i>	12.00-14.25	12.97±0.49	-	-



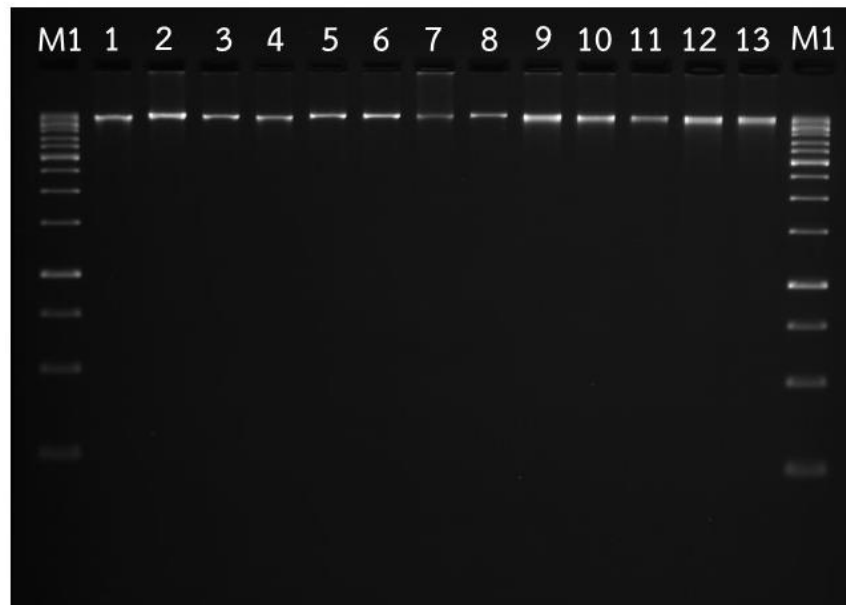
**Figure 38** Photographs of palisade cells of eleven *Gardenia* species: *G. carinata* (a); *G. collinsae* (b); *G. griffithii* (c); *G. jasminoides* (d); *G. lineata* (e); *G. obtusifolia* (f); *G. sootepensis* (g); *G. taitensis* (h); *G. thailandica* (i); *G. vietnamensis* (j); *G. tubifera* (k)

### 4.1.3 Molecular analysis

#### 4.1.3.1 DNA isolation

Genomic DNA was isolated from young fresh leaf tissues of *Gardenia* species collected from different locations. 50-100 ng of DNA concentration was obtained from 200 mg of fresh young leaf and the DNA purity was 1.8. The extracted genomic DNA was shown in **Figure 39**.





**Figure 39** Genomic DNA of 11 *Gardenia* species in 1.0% agarose gel electrophoresis. Lane M1= 1 kb molecular weight marker; lane1= *G. carinata*; lane2= *G. collinsae*; lane3= *G. griffithii*; lane4= *G. jasminoides*; lane5= *G. lineata*; lane6= *G. tubifera*; lane7= *G. obtusifolia*; lane8= *G. sootepensis*; lane9= *G. taitensis*; lane10= *G. thailandica*; lane11= *G. vietnamensis*; lane12= *Ixora finlaysoniana*; lane13= *Cassia timoriensis*

#### 4.1.3.2 RAPD analysis

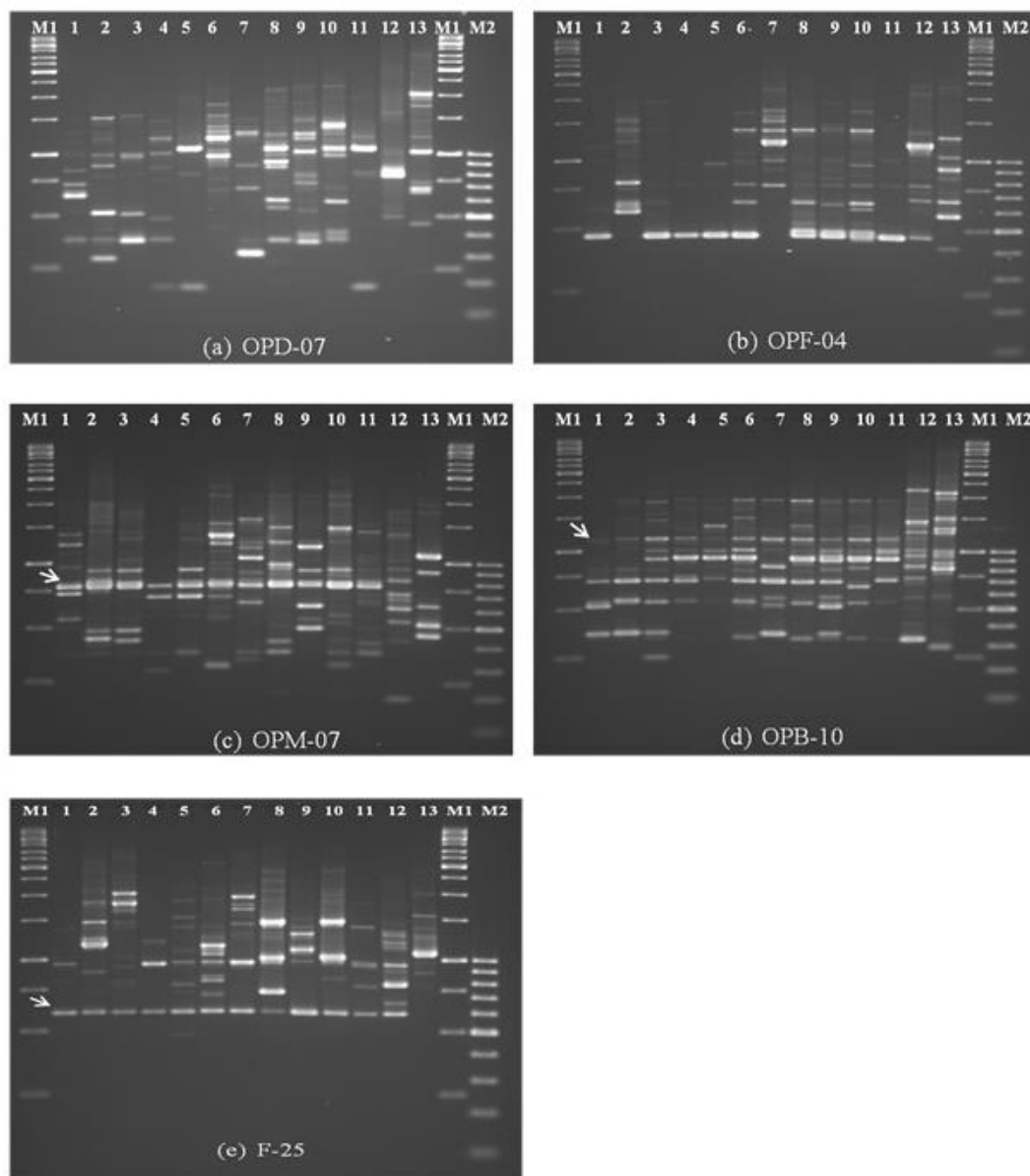
The RAPD analysis of 11 *Gardenia* species were initially screened with 90 arbitrarily primers. Among these, 20 primers produced 573 clear and reproducible polymorphic bands ranging from 15 to 42 bands with an average 28.65 bands per primer (**Table 9**). The amplified fragments varied from 193 to 3702 base

pair (bp) in size. The highly percentage of polymorphism was obtained from all 20 primers (95-100%). The RAPD fingerprint of 11 *Gardenia* species obtained from OPD-07, OPF-04, OPM-07, OPB-10 and F-25 primers was showed in **Figure 40**. The highest number of polymorphic bands (42) was obtained from primers OPD-07 (**Figure 40a**) and the lowest (15) from primers OPF-04 (**Figure 40b**). Monomorphic band in all *Gardenia* species was obtained from primer OPM-07 (**Figure 40c**) and OPB-10 (**Figure 40d**) while F-25 primer showed monomorphic band in all *Gardenia* species and *Ixora finlaysoniana* (out group sample in Rubiaceae Family) (**Figure 40e**).



**Table 9** The list of 20 RAPD primers and the number of amplified bands, size range and percentage of polymorphic bands in 11 *Gardenia* species

Primer name	Primer sequence (5' to 3')	Total amplified bands	Fragment size range (bp)	Polymorphic bands	Polymorphism (%)
OPA-04	AATCGGGCTG	32	196-2658	32	100.0
OPB-04	GGA CTGGAGT	18	316-1865	18	100.0
OPB-10	CTGCTGGGAC	20	255-1942	19	95.0
OPC-04	CCGGATCTAC	32	357-2327	32	100.0
OPC-06	GAACGGACTC	40	278-2569	40	100.0
OPC-08	TGGACCGGTG	34	242-2600	34	100.0
OPC-12	TGTCATCCCC	25	362-2124	25	100.0
OPC-20	ACTTCGCCAC	24	382-2309	24	100.0
OPD-07	TTGGCACGGG	42	193-2286	42	100.0
OPF-04	GGTGATCAGG	15	399-2297	15	100.0
OPF-07	CCGATATCCC	18	519-3509	18	100.0
OPL-01	GGCATGACCT	25	331-2135	25	100.0
OPL-05	ACGCAGGCAC	26	391-1803	26	100.0
OPM-07	CCGTGACTCA	30	291-2279	29	96.7
OPN-16	AAGCGACCTG	32	239-2438	32	100.0
RAPD02	TTCCGAACCC	35	287-2440	35	100.0
RAPD07	GAGGTCCAGA	36	238-2894	36	100.0
A-29	GGTTCGGGAATG	30	424-3702	30	100.0
F-25	CCAGATCCGAAT	30	482-2046	29	96.7
F-29	GCCGCTAATATG	35	411-3579	35	100.0
<b>Total</b>		<b>573</b>	<b>193-3702</b>	<b>570</b>	<b>99.5</b>



**Figure 40** RAPD fingerprints of 11 *Gardenia* species obtained from (a) OPD-07, (b) OPF-04, (c) OPM-07, (d) OPB-10, and (e) F-25 primers. M1 and M2: 1 kb and 100 bp molecular weight marker respectively, lane1= *G. carinata*, lane2= *G. collinsae*, lane3= *G. griffithii*, lane4= *G. jasminoides*, lane5= *G. lineate*, lane6= *G. tubifera*, lane7= *G. obtusifolia*, lane8= *G. sootepensis*, lane9= *G. taitensis*, lane10= *G. thailandica*, lane11= *G. vietnamensis*, lane12= *Ixora finlaysoniana*, lane13= *Cassia timoriensis*. Arrows indicated monomorphic bands.



#### 4.1.4 Specific band for *Gardenia* species by RAPD analysis

From the RAPD analysis of 11 *Gardenia* species by 20 primers, 9 primers (A29, OP B-10, OP C-04, OP C-06, OP C-08, F25, OP A-04, OP D-07 and RAPD02) produced specific band for 7 *Gardenia* species (*G. lineata*, *G. Griffithii*, *G. obtusifolia*, *G. sootepensis*, *G. vietnamensis*, *G. taitensis*, and *G. collinsae*) as present in **Table 10**.

**Table 10** Specific band for *Gardenia* species by RAPD analysis

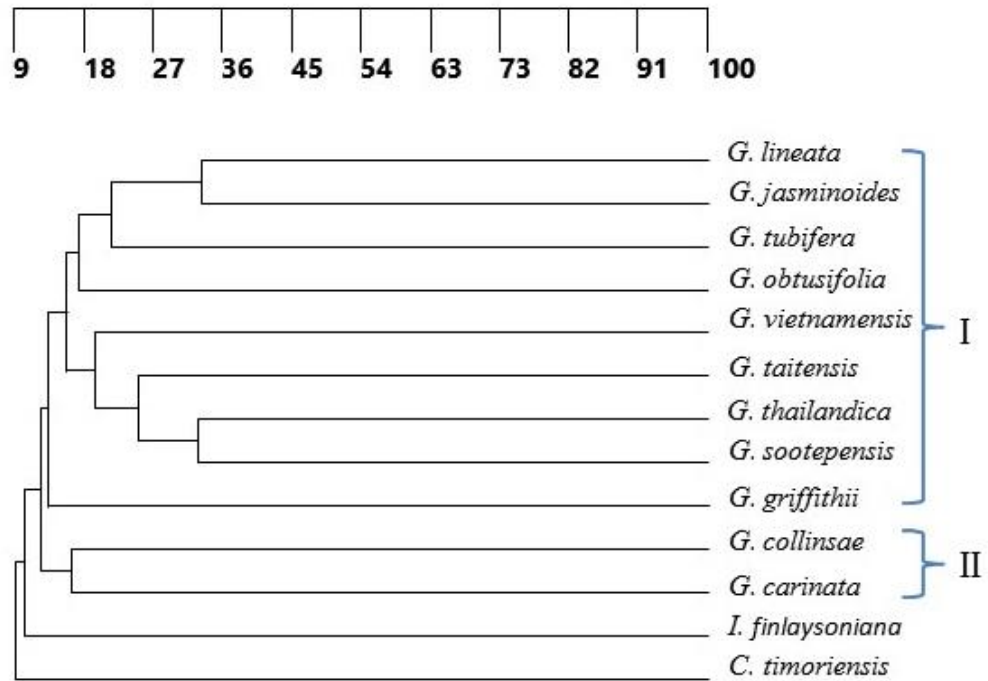
Primer	<i>G. lineata</i>	<i>G. Griffithii</i>	<i>G. obtusifolia</i>	<i>G. sootepensis</i>	<i>G. vietnamensis</i>	<i>G. taitensis</i>	<i>G. collinsae</i>
A29	622 bp	666 bp					
OP B-10		250 bp					
OP C-04			375 bp	357 bp			
OP C-06					449 bp		
OP C-08	317 bp	243 bp				270 bp	302 bp
F25	484 bp						
OP A-04		196 bp					
OP D-07			305 bp				282 bp
RAPD02			355 bp				

#### 4.1.5 Genetic relationship of 11 *Gardenia* species based on RAPD analysis

To evaluate the genetic relationship, RAPD bands produced from 20 primers were scored and a phylogenetic dendrogram was constructed between 11 *Gardenia* species (**Figure 41**). Dice similarity index (SI) among 11 *Gardenia* species ranged from 0.089 to 0.332 (**Table 11**). The highest similarity index (0.332) was found between *G. lineata* and *G. jasminoides* while the lowest similarity index (0.089) was found between *G. carinata* and *G. sootepensis*. The phylogenetic dendrogram can be divided into 2 main clusters. Cluster I includes 9 *Gardenia* species (*G. jasminoides*, *G. griffithii*, *G. lineata*, *G. obtusifolia*, *G. sootepensis*, *G. thailandica*, *G. taitensis*, *G. tubifera* and *G. vietnamensis*) showing 0.083 to 0.332 similarity index and can be divided into 2 subgroups; subgroup 1 includes 8 *Gardenia* species (*G. lineata*, *G. jasminoides*, *G. tubifera*, *G. obtusifolia*, *G. sootepensis*, *G. thailandica*, *G. taitensis*, and *G. vietnamensis*) and subgroup 2 includes only 1 *Gardenia* species (*G. griffithii*). Cluster II includes 2 *Gardenia* species (*G. carinata* and *G. collinsiae*) showing 0.089 to 0.162 similarity index. *Ixora finlaysoniana* and *C. timoriensis* were used as an out-group in RAPD analysis can be clearly separated from all *Gardenia* species.

Table 11 Nei and Li's genetic similarity index among eleven *Gardenia* species based on the RAPD markers

<i>Gardenia</i> species	<i>G. lineata</i>	<i>G. jasminoides</i>	<i>G. tubifera</i>	<i>G. obtusifolia</i>	<i>G. vietnamensis</i>	<i>G. taitensis</i>	<i>G. thailandica</i>	<i>G. sootepensis</i>	<i>G. griffithii</i>	<i>G. collinsae</i>	<i>G. carinata</i>	<i>I. finlaysoniana</i>	<i>C. timoriensis</i>
<i>G. lineata</i>	1												
<i>G. jasminoides</i>	0.332	1											
<i>G. tubifera</i>	0.215	0.211	1										
<i>G. obtusifolia</i>	0.142	0.185	0.187	1									
<i>G. vietnamensis</i>	0.205	0.164	0.169	0.128	1								
<i>G. taitensis</i>	0.148	0.121	0.187	0.205	0.208	1							
<i>G. thailandica</i>	0.118	0.103	0.192	0.175	0.199	0.268	1						
<i>G. sootepensis</i>	0.111	0.134	0.166	0.139	0.167	0.232	0.328	1					
<i>G. griffithii</i>	0.179	0.153	0.155	0.127	0.094	0.083	0.110	0.121	1				
<i>G. collinsae</i>	0.118	0.140	0.145	0.131	0.106	0.115	0.162	0.149	0.129	1			
<i>G. carinata</i>	0.143	0.104	0.099	0.114	0.094	0.111	0.111	0.089	0.106	0.160	1		
<i>I. finlaysoniana</i>	0.113	0.116	0.079	0.123	0.098	0.094	0.103	0.089	0.099	0.116	0.057	1	
<i>C. timoriensis</i>	0.065	0.068	0.117	0.109	0.085	0.119	0.082	0.082	0.079	0.061	0.058	0.093	1



**Figure 41** The genetic relationship based on UPGMA between eleven *Gardenia* species. The scale indicates the genetic similarities between individual

#### 4.2 *Gardenia jasminoides* fruit examination



Figure 42 Crude drug of *Gardenia jasminoides* Ellis fruits

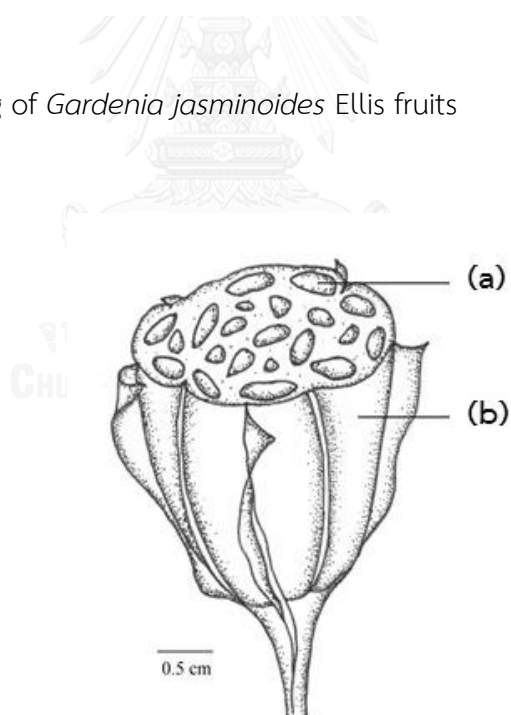


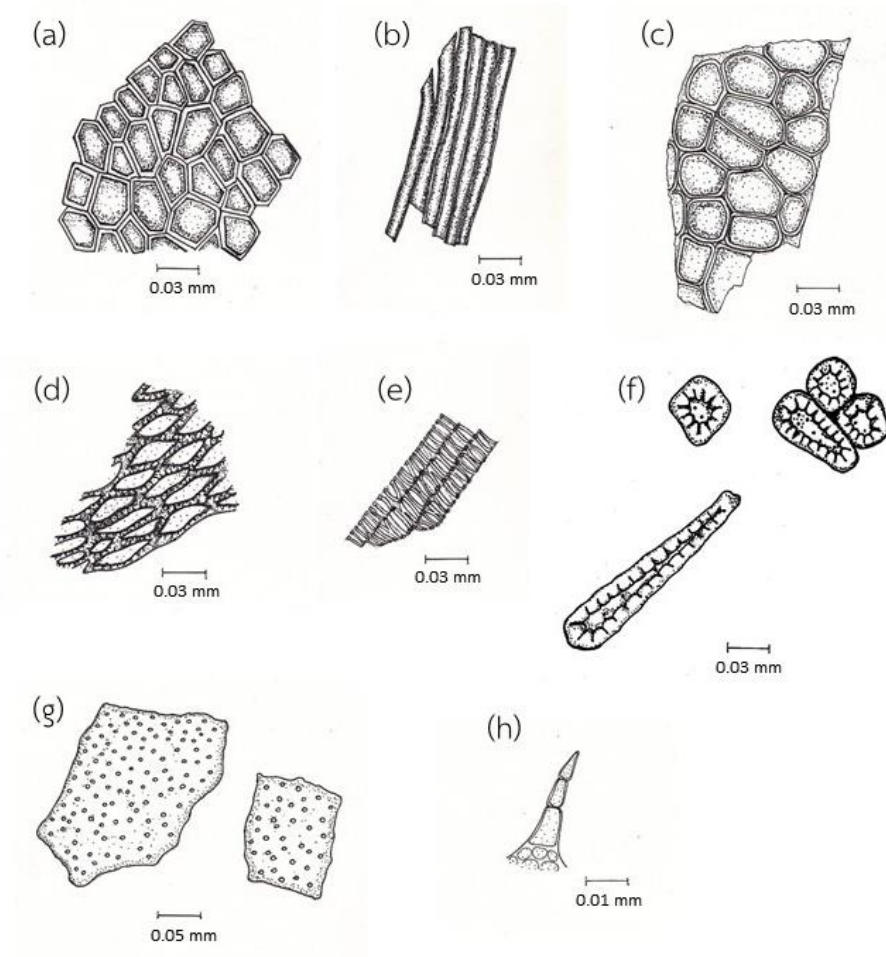
Figure 43 Transverse section of the dried fruit of *Gardenia jasminoides* Ellis; seed (a), pericarp (b)

## 4.2.1 Standardization

### 4.2.1.1 Powder microscopy

The powder microscopy of *G. jasminoides* fruit revealed the presence of epidermal cell; fiber; parenchyma; epidermis of seed coat; fragment of spiral vessels; sclereids; fragment of pitted vessels and multicellular trichomes (**Figure 44**).





**Figure 44** Microscopic characters of powdered *Gardenia jasminoides* fruit: epidermal cell (a); fiber (b); parenchyma (c); epidermis of seed coat (d); fragment of spiral vessels (e); sclereids (f); fragment of pitted vessels (g); multicellular trichomes (h)

#### 4.2.1.2 Physicochemical parameters

The physicochemical parameters of *G. jasminoides* fruit powder were determined including loss on drying, moisture content, ash and extractive values and the results were summarized in **Table 4.7**.

**Table 12** Physicochemical parameters analysis of *G. jasminoides* fruit

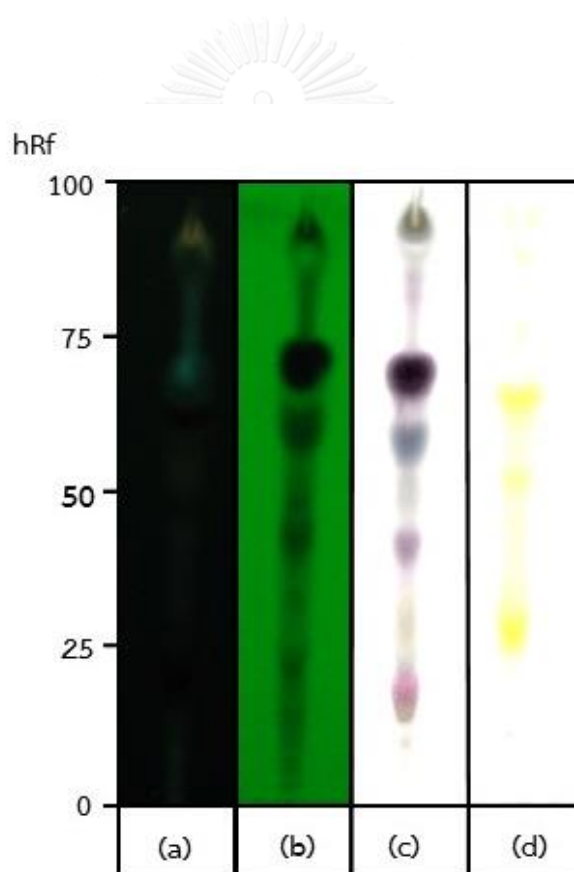
Parameter	Content* (%w/w)
Total ash	4.93±0.16
Acid insoluble ash	0.71±0.13
Loss on drying	8.85±1.13
Water soluble extractives	26.91±2.41
Ethanol soluble extractives	22.53±1.64
Moisture	10.04±0.06

\*Results were expressed as grand mean ± pooled SD from 12 samples in triplicate.



#### 4.2.1.3 TLC fingerprint

The TLC fingerprint profile of *G. jasminoides* fruits using ethyl acetate: isopropyl alcohol: water (65:25:10) as mobile phase showed three yellow spots under daylight, four major spots under 254 nm, one major spot under 366 nm and four major spots under daylight after spraying with p-anisaldehyde developing reagent (Figure 45).



**Figure 45** TLC fingerprint profile of *G. jasminoides* fruit under UV light 366 nm (a), under UV light 254 nm (b), under daylight after spray with p-anisaldehyde reagent (c), under daylight (d)

#### 4.2.2 Crocin content analysis using spectrophotometric method

The yields of ethanolic extracted by soxhlet extraction and crocin contents determined by spectrophotometric method of 12 samples of *G. jasminoides* fruits collected from different locations in Thailand were presented in Table 13.

**Table 13** Yield of ethanolic extract by soxhlet extraction and crocin content by UV/visible spectrophotometry of *G. jasminoides* fruits

Sample	Extract yield (mg/g of dried crude drug)	Crocin content (mg/g of dried crude drug)
1. Chiang Mai	383.1	4.74±0.06
2. Nakhon Pathom	386.4	7.52±0.20
3. Surat Thanee	351.5	5.54±0.53
4. Ubon Ratchathani	376.6	7.66±0.19
5. Rayong	368.0	7.19±0.34
6. Uthai Thanee	353.7	7.22±0.79
7. Bangkok1	360.9	6.46±0.16
8. Bangkok2	373.6	13.34±0.32
9. Bangkok3	375.6	10.11±0.32
10. Lampang	374.1	4.39±0.25
11. Chumporn	434.7	8.95±0.52
12. Nakhon Phanom	455.7	7.55±0.27
Mean±SD	382.8±31.3	7.55±2.39

#### 4.2.2.1 Method validation

The  $\lambda_{\max}$  of crocin was found to be 434 nm. Method validities with respect to linearity, range, accuracy, precision, LOD, LOQ and robustness performed according to the ICH guideline were shown in **Table 14**

**Table 14** The validities of quantitative analysis of crocin in *G. jasminoides* fruits using spectrophotometric method

Method validities	
$\lambda_{\max}$ (nm)	434
Range ( $\mu\text{g/ml}$ )	5-100
Regression equation	$y = 0.0084x - 0.0045$
$R^2$	0.999
LOD ( $\mu\text{g/ml}$ )	1.36
LOQ ( $\mu\text{g/ml}$ )	4.12
Accuracy (%Recovery)	88.96
Repeatability (%RSD)	0.97
Intermediate precision (%RSD)	1.35
Robustness (%RSD)	0.45

#### 4.2.2.2 Crocin components analysis using TLC densitometric method

The TLC chromatogram of 12 *G. jasminoides* fruit extracts developed in n-butanol: acetic acid: water (4:1:1) was shown in **Figure 46**. Standard crocin (Lane 1-3) showed six distinguishable bands indicated that standard crocin was composed of six crocin components with different retention factor (Rf) value while 12 *G. jasminoides* fruit extracts (Lane 4-15) showed less than six separated bands in yellow observed under daylight. Crocin component 6 (Rf 0.23) was not found in all 12 *G. jasminoides* fruit extracts while crocin component 1 (Rf 0.63), 3 (Rf 0.43), 4 (Rf 0.32) and 5 (Rf 0.28) were found in all 12 samples with different contents. Crocin component 2 (Rf 0.51) was found in 7 samples. The major crocin component content was crocin component 1 which was observed in all 12 samples ranging from 58.66-83.91% (**Table 15**).



## CHAPTER V

### DISCUSSION AND CONCLUSION

Plants are the important sources of valuable phytochemicals. Approximately 25% of the modern medicines are derived from plants sources [76]. Therefore, medicinal plants identification and standardization are required to control the quality, efficacy as well as safety of individual plants. Various analytical methods were elaborated for medicinal plant identification. Most of these methods were based on plant macroscopic, microscopic and chemical composition. According to WHO guideline, the quality evaluation of the starting material is a fundamental requirement of manufacturing herbal medicinal products. The development of authentic analytical methods including quantitative analyses of marker/bioactive compounds and other major constituents, is a major challenge to scientists. To prove the consistent composition of herbal preparations, adequate analytical methods have been applied including TLC and UV/visible spectrophotometry. This present study proposed the microscopic, molecular characteristics of eleven *Gardenia* species and the pharmacognostic specification of *G. jasminoides* fruits and with reference to crocin content analyzed using UV/visible spectrophotometry.

At present, sophisticated modern research tools for evaluation of the plant materials are available but microscopic method is still one of the simplest and cheapest methods to start for establishing the correct identity of the source materials

[103]. In this study, microscopic evaluation and RAPD analysis of eleven *Gardenia* species were carried out. Morphological and histological studies of the leaf will enable to identify the crude drug. Leaves have a great diversity of other internal structures that can potentially store information for discrimination patterns. One of them is the midrib, which drastically differs between species in its shape and composition of vascular and fundamental tissues. Anatomically, leaf midrib is composed by a set of highly specialized tissues (phloem and xylem) and other cells, which are normally very similar between individuals of the same species. The use of midrib anatomy to discriminate plant species has been recently explored as a new tool to assist plant classification [104]. The microscopical studies of the leaf and midrib transverse section of *Gardenia* species showed presence of upper epidermis, palisade cell, stomata, spongy cell, lower epidermis, parenchyma, xylem vessel, fiber, phloem tissue, collenchyma and paracytic stomata, which is characteristics of the family Rubiaceae. The paracytic type of stomata has been typified as Rubiaceous by Vesque in the year 1889 [105]. Patil, C.R. and Patil, D.A. reported paracytic stomatal type in some Rubiaceae including *G. jasminoides*, *G. gummifera* and *G. longistyla* [106]. In term of density of trichomes, the results showed that only two species, *G. sootepensis* and *G. tubifera*, is densely hairy on lower surface. The high density of trichomes on the lower surface of *G. sootepensis* and *G. tubifera* is of taxonomic interest and could be used to delimit the taxon from the other species. Kemka, C.I. used trichome density to classified eight *Crassocophalum* species [107].

Additionally, molecular characteristics of *Gardenia* species were also carried out for assessing the genetic information of this plant. The genetic information of *Gardenia* species in Thailand is still limited. Previously reported from some studies almost focus mainly on *G. jasminoides* such as genetic characterization and authentication of *G. jasminoides* in different regions of China using RAPD analysis [108], genetic diversity and biogeography of *G. jasminoides* based on AFLP markers [28], genetic relationships between *G. jasminoides* var. *radicans* and *G. jasminoides* for. *grandiflora* by RAPD [109], isolation and characterization of twenty-two polymorphic microsatellite markers from *G. jasminoides* [110], comparison of *G. jasminoides* cultivars using isozymes and RAPD markers [111].

In this study, RAPD analysis of eleven *Gardenia* species in Thailand including seven native species (*G. carinata*, *G. collinsiae*, *G. griffithii*, *G. obtusifolia*, *G. sootepensis*, *G. thailandica*, and *G. tubifera*) and four introduce species (*G. jasminoides*, *G. lineata*, *G. taitensis*, and *G. vietnamensis*) was carried out with 20 primers. Among 7 native species, the similarity index varied from 0.089 to 0.328 and the highest values was found between *G. sootepensis* and *G. thailandica* while 4 introduce species, the similarity index ranging from 0.121 to 0.332 and the highest similarity value was found between *G. jasminoides* and *G. lineata*. The highest similarity index between native and introduce species was found between *G. thailandica* and *G. taitensis* (0.268). From the previous study, the similarity values among 11 *Gardenia* species (*G. carinata*, *G.*



*collinsae*, *G. elata*, *G. jasminoides*, *G. obtusifolia*, *G. saxatilis*, *G. sootepensis*, *G. thailandica*, *G. gjellerupii*, *G. taitensis* and *G. volkensii*) by RAPD methods using 14 primers were also reported and the highest similarity value among native species was found between *G. sootepensis* and *G. thailandica* which supported the results in this study [10]. The phylogenetic dendrogram based on RAPD, separated *Gardenia* species examined into 2 main clusters, cluster I consisted of 9 species of native and exotic (*G. jasminoides*, *G. griffithii*, *G. lineata*, *G. obtusifolia*, *G. sootepensis*, *G. thailandica*, *G. taitensis*, *G. tubifera* and *G. vietnamensis*) which had some similar morphological characteristics such as large size of flower, growing into tree or shrub, whereas cluster II consisted of 2 species of native (*G. collinsae* and *G. carinata*) have small size of flower and growing into tree.

In present study, one unique band was observed in the leaf DNA of *G. lineata* (primer A29, OPC-08, F25), *G. griffithii* (primer A29, OPB-10, OPC-08, OPA-04), *G. obtusifolia* (primer OPC-04, OPD-07, RAPD02), *G. sootepensis* (primer OPC-04), *G. vietnamensis* (primer OPC-06), *G. taitensis* (primer OPC-08), *G. collinsae* (primer OPC-08, OPD-07) which might be utilized to distinguish this plant from others.

Development of RAPD markers can provide extensive applications in quality control of plant materials. In this study, 20 RAPD primers generated DNA fingerprinting of 11 species of *Gardenia* which could be used as a qualitative diagnostic tool for identification of *Gardenia* species. RAPD markers has main advantages include simple,

rapid, efficient, no requirement of sequence information for design of specific primers, require only small amounts of DNA template, procedure can be automated, high number of fragments, arbitrary primers are easily purchased and unit costs per assay are low compared to other marker technologies [112]. However, the limitation of RAPD is the reproducibility and cannot differentiate dominant homozygote from heterozygote. To concern about reproducibility, quality and quantity of DNA template, PCR buffer, concentration of magnesium chloride, primer to template ratio and annealing temperature must be optimized. Moreover, the RAPD primer should contain minimum of 40% GC content and the absence of palindromic sequence to avoid self annealing of primer. The present or absent of polymorphic bands due to the mismatches at the primer site, changes in DNA sequence that inhibit primer binding or the length of amplified region between primer sites. The polymorphic banding pattern which is the specific or unique band derived from RAPD marker can be further developed as SCAR (sequence characterized amplified region) marker for rapid and simple identification of medicinal plant species.

In this study, *G. jasminoides* fruits were also investigated on microscopic characteristics. The microscopic examination can be considered both for powders and ungrounded drugs. The types of epidermal parenchyma, stomata, trichomes, fibers, vessels and calcium oxalate crystals have been used for the identification [113-115]. According to the results, microscopic analysis of *G. jasminoides* fruit powder revealed

various important histological characters which could serve as useful parameters for the identification of this plant material.

Physicochemical parameters can also serve as valuable information in evaluation of purity and quality of plant materials [116]. This study is the first report of physicochemical parameters of *G. jasminoides* fruits. The water extractive matter ( $26.91 \pm 2.41\%$ ) was higher than ethanol extractives ( $22.53 \pm 1.64\%$ ). It indicates that *G. jasminoides* fruit has large amount of polar compounds or water soluble constituents like phenols, alkaloids, steroids, glycosides, flavonoids [4]. Percentages of loss on drying and moisture contents were found to be  $8.85 \pm 1.13$  and  $10.04 \pm 0.06$ , respectively. These specifications are useful to prevent bacterial, fungal or yeast growth [117]. The total ash and acid insoluble ash values were found to be  $4.93 \pm 0.16\%$  and  $0.71 \pm 0.13\%$ , respectively. Ash values are useful in determining authenticity and purity of plant material and also these values are important quantitative standards [117]. Evaluation of physicochemical parameters is an important part in the preparation of modern monograph [118].

The fingerprint of compounds present in plant materials can provide basic data for using to demonstrate the quality, consistency and stability of plant materials [119]. Various analytical methods have been used to analyze the chemical fingerprint of *G. jasminoides* fruit including HPLC [29], GC/MS [120], HPTLC [121] and HPLC-PDA [122]. Furthermore, the TLC fingerprint profile is useful in standard setting up for evaluating

the quality and purity as well as screening analysis of plant materials. TLC fingerprint is a simple, rapid and inexpensive method for chemical qualitative characteristic.

Crocin is an important bioactive compound which can be isolated from saffron (*Crocus sativus* L.) and gardenia fruit (*G. jasminoides*) [31, 123, 124]. In the present study, soxhlet apparatus was used for ethanolic extraction of crocin from gardenia fruits due to its continuous maceration, simple, not expensive method as well as its possibility to extract more sample mass than others methods [125]. The highest extract yields of 12 *G. jasminoides* fruits samples was 455.7 mg/g of dried crude drug (45.57%) which was higher than 70% ethanolic extract of *G. jasminoides* fruit by maceration (41.4%) [126] and ethanolic extract by decoction method (13.2%) [127].

Various analytical methods have been developed for determination of crocin content in saffron such as UV/visible spectrophotometry [128], HPLC [123], UPLC [129], HPLC- ELSD [130], TLC, infrared spectrophotometer and NMR [131], HPLC-DAD-ESI-MS [132, 133], LC-MS [134]. However, such equipment and instruments are expensive and they are not available in most laboratories. UV/visible spectrophotometry is the absorption spectroscopy using the UV and visible spectral region for the quantitation of the chemical compounds. Due to the relatively fast, cheap, simple and routinely use method, the UV/visible spectrophotometric method was employed in this study for the quantification of crocin content in *G. jasminoides* fruits.

Method validation plays a major role in achieving consistent, reliable and accurate data. According to the ICH guideline for quantitation of chemical compound, the parameters such as linearity, range, LOD, LOQ, accuracy, precision, and robustness should be validated. Thus the validated analytical procedure can be used to judge the quality standard result. The  $\lambda_{\text{max}}$  of crocin was found to be 434 nm and the standard linear calibration curve showed a good linear relationship with accepted value (0.999). The quantitative amount of crocin was in the range from  $4.39 \pm 0.25$  to  $13.34 \pm 0.32$  mg/g of dried crude drug. Six components of crocins were detected in standard crocin (Sigma) by TLC densitometry as well as other standard crocin (Fluka) has been detected six components of crocin by HPLC [135]. However, four to five crocin components were determined in twelve *G. jasminoides* fruit extract samples using TLC densitometry which similar to the previous reported less than six crocin components (crocin 1, crocin 2, crocin 3) in gardenia fruits by HPLC analysis [136, 137], five crocin components in gardenia fruits by MS, UV/visible and 1D NMR [138]. The standard crocin was extracted from saffron (*Crocus sativus*). Therefore, the number of crocin components detected from *G. jasminoides* fruits can be different from standard crocin.

## Conclusion

The finding on microscopic, molecular characteristics of *Gardenia* species and powder microscopy, physicochemical parameters and TLC fingerprint of *G. jasminoides* fruits can serve as an important tool for the identification and authentication parameters of these plant. Moreover, the simple, rapid, sensitive and specific UV/visible spectrophotometric method was developed for determination of crocin content in *G. jasminoides* fruits. This precisely and accurately analytical method was suitable for the quality control of crocin in herbal medicine.



## REFERENCES

1. Boroomand, N. and M.S.H. Grouh, *Macroelements nutrition (NPK) of medicinal plants: A review*. J. Med. Plants Res. 2012. **6**(12): p. 2249-225.
2. Efferth, T. and H.J. Greten, *Quality Control for Medicinal Plants*. Med Aromat Plants 2012. **1**(7): p. 1-3.
3. Organization, W.H., *Guidelines for the appropriate use of herbal medicines*. 1998. 88.
4. Kadam, P.V., et al., *Pharmacognostic, phytochemical and physicochemical studies of Mimusops Elengi Linn stem bark (Sapotaceae)* Pharm Lett, 2012. **4**(2): p. 607-613.
5. Rose, E.N., K.P. Namdeo, and P.K. Samal, *Standardization strategies for herbal drugs-an overview*. Research J. Pharm. and Tech., 2008. **1**(4): p. 310-312.
6. Bigoniya, P., C. Singh, and B. Srivastava, *Pharmacognostical and physico-chemical standardization of Syzygium cumini and Azadirachta indica seed*. Asian Pac J of Trop Biomed., 2012: p. S290-S295.
7. Parmar, V. and S. Sharma, *Novel constituents of Gardenia species: A review*. JSIR, 2000. **59**: p. 893-903.
8. Lee, J.-H., D.-U. Lee, and C.-S. Jeong, *Gardenia jasminoides Ellis ethanol extract and its constituents reduce the risks of gastritis and reverse gastric lesions in rats*. FCT, 2009. **47**: p. 1127-1131.
9. Shu, Z.Z., C. Tao, and C.M. Taylor, *Rubiaceae*. Flora of China. Vol.19. 2011.
10. Suwannakud, K.S., et al., *Genetic relations related to chemical containing and the efficient barcodes by psbAtrnH spacer and its combinations with rbcL and matK on Gardenia species*. JABS, 2014. **8**(3): p. 65-78.
11. Smittinand, T. *Rubiaceae*. Thai plant names. 2014: The Forest Herbarium, Royal Forest Department, Bangkok.

12. Puff, C., K. Chayamarit, and V. Chamchumroon, *Rubiaceae of Thailand: A Pictorial Guide to Indigenous and Cultivated Genera*. Bot. J. Linn. Soc., 2005. **152**: p. 131-132.
13. Wang, S.-C., et al., *Gardenia herbal active constituents: applicable separation procedures*. J. Chromatogr. B, 2004. **812**(1-2): p. 193-202.
14. Phromnoi, K., et al., *A Dihydroxy-pentamethoxyflavone from Gardenia obtusifolia suppresses proliferation and promotes apoptosis of tumor cells through modulation of multiple cell signaling pathways*. Anticancer Res. , 2010. **30**(9): p. 3599-3610.
15. Kongkum, N., et al., *Cytotoxic, antitopoisomerase II $\alpha$ , and anti-HIV-1 activities of triterpenoids isolated from leaves and twigs of Gardenia carinata*. J. Nat. Prod. , 2013. **76**: p. 530-537.
16. Pudhom, K., et al., *Antiangiogenic activity of 3,4-seco-cycloartane triterpenes from Thai Gardenia spp. and their semi-synthetic analogs*. Bioorg. Med. Chem. Lett, 2012. **22**: p. 512-517.
17. Tuchinda, P., et al., *Anti-HIV-1 cycloartanes from leaves and twigs of Gardenia thailandica*. Planta Med. 2004; **70**: 366-370.
18. Phatak, R.S., *Phytochemistry, pharmacological activities and intellectual property landscape of Gardenia jasminoides Ellis: a Review*. Phcog J., 2015. **7**(5): p. 254-265.
19. Jainul, M.A., et al., *Evaluation of thrombolytic effect of seven different Bangladeshi plants*. BJPR, 2014. **4**(11): p. 1400-1406.
20. Reutrakul, V., et al., *Cytotoxic and anti-HIV-1 constituents from leaves and twigs of Gardenia tubifera*. Tetrahedron, 2004. **60**(7): p. 1517-1523.
21. Zalke, A.S., et al., *Pharmacognostical evaluation of Cardiospermum halicacabum Linn. leaf and stem*. Anc Sci Life., 2013. **33**(1): p. 15-21.
22. Pourmohammad, A., *Application of molecular markers in medicinal plant studies*. Agric Environ, 2013. **5**: p. 80-90.



23. Khan, S., et al., *RAPD profile for authentication of medicinal plant Glycyrrhiza glabra Linn.* Internet Journal of Food Safety, 2009. **11**: p. 24-28.
24. Chirag, G., et al., *Molecular characterization of the nettle plant Urtica parviflora based on RAPD marker.* J Pharm Biomed Sci, 2011. **5**(5): p. 1-4.
25. Khan, S., et al., *Development of RAPD markers for authentication of Piper nigrum (L.).* Environ. We Int. J. Sci. Tech., 2010. **5**: p. 47-56.
26. Bharti, S. and K. Vijaya, *Random amplified polymorphic DNA (RAPD) analysis for genetic diversity in Terminalia bellirica species (Roxb.), an important medicinal tree.* Asian Journal of Plant Science and Research 2013. **3**(4): p. 21-27.
27. Manissorn, J., et al., *DNA fingerprint of selected Thai Phyllanthus species by RAPD analysis* J Health Res 2010, 2010. **24**(2): p. 73-79.
28. Han, J., et al., *Genetic diversity and biogeography of the traditional Chinese medicine, Gardenia jasminoides, based on AFLP markers.* Biochem. Syst. Ecol., 2007. **35**(3): p. 138-145.
29. Ding, Y., et al., *Chemical fingerprint analysis of Gardenia jasminoides fruit by High-Performance Liquid Chromatography.* JFDA, 2010. **18**(3): p. 180-190.
30. Singla, R.K. and V.B. G, *Crocins: an overview.* IGJPS, 2011. **1**(4): p. 281-286.
31. Zhang, H., et al., *Semi-Preparative Isolation of Crocins from Saffron (Crocus sativus L.).* Chromatographia, 2004. **59**: p. 691-696.
32. Carmona, M., et al., *Crocetin esters, picrocrocins and its related compounds present in crocus sativus stigmas and Gardenia jasminoides fruits. Tentative identification of seven new compounds by LC-ESI-MS.* J. Agric. Food Chem., 2006. **54**: p. 973-979.
33. Silva, G.L., et al., *Novel cytotoxic ring-a seco-cycloartane triterpenes from Gardenia coronaria and G. sootepensis.* Tetrahedron, 1997. **53**(2): p. 529-538.
34. Hussian, M.M. and E.N. Sokomba, *Pharmacological effects of Gardenia erubescens in mice, rats and cats.* Int J Pharmacogn, 1991. **29**: p. 94-100.

35. Chhabra, S.C., R.L.A. Mahunnah, and E.N. Mshiu, *Plants used in traditional medicine in Eastern Tanzania. V. angiosperms (passifloraceae to sapindaceae)*. J Ethnopharmacol, 1991. **33**: p. 143-157.
36. Mei, Z., et al., *Genetic authentication of Gardenia jasminoides Ellis var. grandiflora Nakai by improved RAPD-derived DNA markers*. Molecules, 2015. **20**: p. 20219-20229.
37. Keng, H. and R.-S.L. Keng, *The Concise Flora of Singapore: Gymnosperms and Dicotyledons*. 1990: Singapore University Press.
38. V-Sommai, A. and P. Kaewduangthain, *Wild trees in Thailand*. 2004: Bangkok: H.N.Y.Film.
39. Shu, Z.Z., *GARDENIA J. Ellis, Philos.* . Fl. China, 2011. **19**: p. 141-144.
40. Lanorsavanh, S. and P. Chantaranonthai, *Four new records of Rubiaceae from Lao PDR*. Thai Journal of Botany, 2011. **3**(2): p. 115-120.
41. Bhagya, D.K., et al., *Preliminary studies, anti-inflammatory and analgesic activity of leaf extract of gardenia taitensis in experimental models*. Indian J. Pharm. Sci., 2011. **1**(1): p. 15-18.
42. Suwannakud, K.S., et al., *Genetic relations related to chemical containing and the efficient barcodes by psbA-trnh spacer and its combinations with rbcl and matk on gardenia species*. JABS, 2014. **8**(3): p. 65-78.
43. Qin, F., et al., *A new triterpenoid from the fruits of Gardenia jasminoides var. radicans Makino*. Nat. Prod. Res. ;():. 2015. **29**(7): p. 633-637.
44. Yang, L., et al., *2-Methyl-l-erythritol glycosides from Gardenia jasminoides*. Fitoterapia, 2013. **89**: p. 126-130.
45. Huang, T., S. Mu, and X. Hao, *Study on the chemical constituents of fructus gardeniae*. Zhong Yao Cai. 2012 **35**(12): p. 1950-1952.
46. Chaichana, J., et al., *Volatile constituents and biological activities of gardenia jasminoides*. J Health Res 2009. **23**(3): p. 141-145.
47. Yu, Y., et al., *Bioactive iridoid glucosides from the fruit of Gardenia jasminoides*. J Nat Prod. , 2009 **72**(8): p. 1459-1464.

48. Li, B., et al., *Sedative, hypnotic and antiseizure effects of compound gardenia oil and jujube seed oil in mice*. Nan Fang Yi Ke Da Xue Xue Bao. , 2008. **28**(9): p. 1636-1639.
49. Surekha, D., et al., *A review on role of quality control and quality assurance system in regulation of herbal drugs*. Int.J.Rev.Life.Sci., 2011. **1**(3): p. 97-105.
50. Zhang, X.L. and H.J. Yu, *Sensitive determination of bioactive crocin analogues in Gardenia jasminoides Ellis using SPE prior to HPLC analysis*. AMM, 2013. **303-306**: p. 654-658.
51. Alavizadeh, S.H. and H. Hosseinzadeh, *Bioactivity assessment and toxicity of crocin: A comprehensive review*. Food Chem Toxicol, 2014. **64**: p. 65-80.
52. Nagatoshi, M., et al., *UGT75L6 and UGT94E5 mediate sequential glucosylation of crocetin to crocin in Gardenia jasminoides*. FEBS Letters, 2012. **586**(7): p. 1055-1061.
53. Chanda, S., *Importance of pharmacognostic study of medicinal plants: An overview*. J Pharmacogn Phytochem, 2014. **2**(5): p. 69-73.
54. Garg, V., et al., *facts about standardization of herbal medicine: a review*. Zhong Xi Yi Jie He Xue Bao, 2012. **10**(10): p. 1077-1083.
55. Kunle, O.F., H.O. Egharevba, and P.O. Ahmadu, *Standardization of herbal medicines - A review*. IJBC, 2012. **4**(3): p. 101-112.
56. Killedar, S.G., H.N. More, and S.J. Nadaf, *Microscopic evaluation of leaves of Memecylon umbellatum Burm*. Advances in Agriculture, 2014: p. 1-6.
57. Gokhale, S.B., C.K. Kokate, and A.P. Purohit, *Pharmacognosy first year diploma in pharmacy*. 29 ed. 2009: Nirali Prakashan.
58. Mukherjee, P.K., *Quality control herbal drugs: an approach to evaluation of botanicals*. 2007: Business Horizons. 800.
59. WHO, *Quality control methods for herbal materials*. 1998, Malta: WHO Press.
60. Evans, W.C., *Trease and Evans Pharmacognosy*. 16 ed. 2009: WB Saunders Elsevier Science Ltd. 603.
61. Woodward, F.I., J.A. Lake, and W.P. Quick, *Stomatal development and CO<sub>2</sub>: ecological consequences*. New Phytologist, 2002. **153**: p. 477-484.

62. Timmerman, H.A., *Stomatal number: their value for distinguishing species*. Pharm J 1927. **118**( ): p. 241-243.
63. R, F., et al., *Quantitative measures of leaf epidermal cells as a taxonomic and phylogenetic tool for the identification of Stanhopea species (Orchidaceae)*. J. Exp. Bot., 2008. **77**: p. 113-127.
64. Margineanu, A.-M., I. Molnar, and E. Rakosy-Tican, *Trichomes types analysis and their density in parental species solanum tuberosum and s. Chacoense and their derived somatic hybrids*. Biol. veget., 2014. **60**(2): p. 33-42.
65. Stefano, M., A. Papini, and L. Brighigna, *A new quantitative classification of ecological types in the bromeliad genus Tillandsia (Bromeliaceae) based on trichomes*. Rev. Biol. Trop. (Int. J. Trop. Biol.), 2008. **56** (1): p. 191-203.
66. Khalik, K.A., *Morphological studies on trichomes of Brassicaceae in Egypt and taxonomic significance*. Acta Bot. Croat., 2005. **64**(1): p. 57-73.
67. Perez-Estrada, L.B., Z. Cano-Santana, and K. Oyama, *Variation in leaf trichomes of Wigandia urens: environmental factors and physiological consequences*. Tree Physiol, 2000. **20**: p. 629-632.
68. Santosh, M.K., et al., *Physicochemical and phytochemical examination of medicinal plants used in indigenous system of medicine*. E-Journal of Chemistry, 2005. **2**(2): p. 142 -151.
69. Zunjar, V., et al., *Pharmacognostic, Physicochemical and Phytochemical Studies on Carica papaya Linn. Leaves*. Pharmacognosy Journal, 2011. **3**(20): p. 5-8.
70. Kar, A., *Pharmaceutical drug analysis*. 2 ed. 2005: New Age International (P) Ltd. 534.
71. Chandel, H.S., A.K. Pathak, and M. Tailang, *Standardization of some herbal antidiabetic drugs in polyherbal formulation*. Pharmacogn. Res., 2011. **3**(1): p. 49-56.

72. Gautam, A., et al., *Identification, evaluation and standardization of herbal drugs: A review*. Der Pharmacia Lettre, 2010. **2**(6): p. 302-315.
73. Kulkarni, K.M., et al., *Fingerprinting techniques in herbal standardization*. J Pharm Res., 2014. **4**(2): p. 1049-1062.
74. Tistaert, C., B. Dejaegher, and Y.V. Heyden, *Chromatographic separation techniques and data handling methods for herbal fingerprints: A review*. Anal. Chim. Acta., 2011. **690**(2): p. 148-161.
75. Nikam, P.H., et al., *Future trends in standardization of herbal drugs*. JAPS, 2012. **2**(6): p. 38-44.
76. Singh, V. and V. Kumar, *An optimized method of DNA isolation from highly mucilage-rich okra (Abelmoschus esculentus L.) for PCR analysis*. Advances in Applied Science Research 2012. **3**(3): p. 1809-1813.
77. Tiwari, K.L., S.K. Jadhav, and S. Gupta, *Modified CTAB technique for isolation of DNA from some medicinal plants*. Res J Med Plant, 2012. **6**(1): p. 65-73.
78. Bardakci, F., *Random amplified polymorphic DNA (RAPD) markers*. Turk J Biol 2001. **25**: p. 185-196.
79. Kumar, N.S. and G. Gurusubramanian, *Random amplified polymorphic DNA (RAPD) markers and its applications*. Sci Vis 2011. **11**(3): p. 116-124
80. Arif, I.A., et al., *A brief review of molecular techniques to assess plant diversity*. Int J Mol Sci, 2010. **11**: p. 2079-2096.
81. Hollingsworth, P.M., R.M. Bateman, and R.J. Gornall, *Molecular systematics and plant evolution*. 2002: Taylor and Francis.
82. Baxevanis, A.D. and B.F.F. Ouellette, *Phylogenetic analysis 2ed*. Bioinformatics: A practical guide to the analysis of genes and proteins. 2001.
83. Semagn, K., Å. Bjørnstad, and M.N. Ndjiondjop, *An overview of molecular marker methods for plants*. AJB, 2006. **5**(25): p. 2540-2568.
84. Khanh, N.D., *Advances in the extraction of anthocyanin from vegetables*. JFNS, 2015. **3**(1-2): p. 126-134.

85. Wang, L. and C.L. Weller, *Recent advances in extraction of nutraceuticals from plants*. TIFS, 2006. **17**(6): p. 300-312.
86. Azwanida, N., *A review on the extraction methods use in medicinal plants, principle, strength and limitation*. Med Aromat Plants 2015. **4**(3): p. 1-6.
87. Tiwari, P., et al., *Phytochemical screening and extraction: A review* Internationale Pharmaceutica Scientia, 2011. **1**(1): p. 98-106.
88. Feizzadeh, B., et al., *Cytotoxic effect of saffron stigma aqueous extract on human transitional cell carcinoma and mouse fibroblast*. Urol J. , 2008. **5**: p. 161-167.
89. Prashanth, K.N., K. Basavaiah, and C.M. Xavier, *Development and validation of UV-spectrophotometric methods for the determination of sumatriptan succinate in bulk and pharmaceutical dosage form and its degradation behavior under varied stress conditions*. JAAUBAS, 2014. **15**: p. 43-52.
90. ICH, *Validation of analytical procedures: text and methodology Q2(R1)*, in *International Conference on Harmonisation of technical requirements for registration of pharmaceuticals for human use 2005*.
91. Chin, Y.C., *Chemical constituents of the fruit of Gardenia jasminoides*. Yao Hsueh Hsueh Pao 1964. **11**: p. 342-345.
92. Yamano, T., *Hepatotoxicity of gardenia yellow color in rats*. Toxicol. Lett., 1988. **44**: p. 177-182.
93. Ozaki, A., *Genotoxicity of gardenia yellow and its components*. FCT, 2002. **40**: p. 1603-1610.
94. Koo, H., *Anti-inflammatory evaluation of gardenia extract, geniposide and genipin*. Journal of Ethnopharmacology, 2006. **103**: p. 496-500.
95. Tian, J., *Antidepressant-like effect of genipin in mice*. Neurosci. Lett., 2010. **479**: p. 236-239.
96. Kafua, L., *Antifungal activity of Gardenia brighamii leaf extracts* Antimicrob. Agents Chemother., 1997. **41**: p. 2326-2332.

97. Tuchinda, P., *Cytotoxic and anti-HIV-1 constituents of Gardenia obtusifolia and their modified compounds*. Tetrahedron, 2002. **58**: p. 8073-8086.
98. Pudhom, K., T. Nuanyai, and K. Matsubara, *Cytotoxic and anti-angiogenic properties of minor 3,4-seco-cycloartanes from Gardenia sootepensis Exudate*. Chem. Pharm. Bull., 2012. **60**(12): p. 1538-1543.
99. Phromnoi, K., S. Reuter, and B. Sung, *A dihydroxy-pentamethoxyflavone from Gardenia obtusifolia suppresses proliferation and promotes apoptosis of tumor cell through modulation of multiple cell signaling pathways*. Anticancer Res., 2010. **30**: p. 3599-3610.
100. Ruangrunsi, N., *Pharmacognostic specification of Thai crude drugs*, ed. 1. 2007, Bangkok, Thailand: The War Veterans Organization of Thailand under Royal Patronage of His Majesty the King, Bangkok. 88.
101. Bolhasani, A., et al., *Separation and purification of some components of Iranian saffron*. Asian J. Chem., 2005. **17**(2): p. 725-729.
102. Kumar, N.S. and G. Gurusubramanian, *Random amplified polymorphic DNA (RAPD) markers and its applications*. Sci Vis 2011. **11**(3): p. 116-124.
103. Kumar, S., V. Kumar, and O. Prakash, *Microscopic evaluation and physiochemical analysis of Dillenia indica leaf*. Asian Pac J Trop Biomed 2011. **1**(5): p. 337-340.
104. Silva, N.R.d., et al., *Plant identification based on leaf midrib cross-section images using fractal descriptors*. PLoS One., 2015. **10**(6): p. 1-14.
105. Vesque, I., *Del'emploi des caracteres anatomiques dans la classification des vegetaux*. Bull. Soc. Bot., 1889. **36**: p. 41-77.
106. Patil, C.R. and D.A. Patil, *Investigations on foliar epidermis in some Rubiaceae*. J. Phytol., 2011. **3**(12): p. 35-40.
107. Kemka, C.I. and C.U. Nwachukwu, *Epidermal micromorphology of species in the genus Crassocephalum MOENCH.S, MOORE (Compositae) in Nigeria*. JPCS, 2011. **3**: p. 29-41.

108. Mei, Z., et al., *Genetic characterization and authentication of Gardenia jasminoides in different regions of China by using improved RAPD analysis*. IJEB., 2015. **53**(3): p. 164-169.
109. Huh, M.K. and J.S. Choi, *Genetic relationships between Gardenia jasminoides var. radicans and G. jasminoides for. grandiflora revealed by randomly amplified polymorphic DNA*. KSHS, 2005. **46** (1 ): p. 69-75.
110. XU, Y.-Q., et al., *Isolation and characterization of twenty-two polymorphic microsatellite markers from Gardenia jasminoides (Rubiaceae)*. Journal of Genetics 2014. **93**: p. e22-e24.
111. Criley, R.A., et al., *A Comparison of Gardenia augusta cultivars using isozymes and RAPD markers*. 2008: p. 461-468.
112. Kumar, N.S. and G. Gurusubramanian, *Random amplified polymorphic DNA (RAPD) markers and its applications*. Sci Vis, 2011. **11**(3): p. 116-124.
113. Khare, P., et al., *A Study on the Standardization Parameters of a Halophytic Plant (Cressa cretica L.)*. JSR, 2013. **15**(10): p. 1472-1477.
114. Sanmugarajah, V., I. Thabrew, and S.R. Sivapalan, *Phyto, physicochemical standardization of medicinal plant Enicostemma littorale, Blume*. IOSR Journal of Pharmacy, 2013. **3** (2 ): p. 52-58.
115. Parmar, S. and P.M. Patel, *Pharmacognostic, Physicochemical and Phytochemical Study of Phyllanthus Amarus present in Some Appetizer Polyherbal formulations*. Am. J. PharmTech Res. , 2013. **3**(1): p. 526-537.
116. Kumar, D., A. Kumar, and O. Prakash, *Morphoanatomical and physicochemical standardization of Casuarina equisetifolia L. stem bark*. Beni-Suef University Journal of Basic and Applied Sciences, 2014. **3**(1): p. 32-36.
117. Mulla, S.K. and P. Swamy, *Preliminary pharmacognostical and phytochemical evaluation of Portulaca quadrifida Linn*. International Journal of PharmTech Research, 2010. **2**(3): p. 1699-1702.
118. Deb, N.K. and G.K. Dash, *Pharmacognostical studies of Gardenia latifolia Ait. barks* Der Pharmacia Lettre, 2014. **6**(4): p. 267-271



119. Mohammad, A., S.A. Bhawani, and S. Sharma, *Analysis of herbal products by thin-layer chromatography: A review*. IJPBS, 2010. **1**(2): p. 1-50.
120. Xin, W., et al., *Chemical fingerprinting of Gardenia jasminoides fruit using direct sample introduction and gas chromatography with mass spectrometry detection*. J. AOAC Int., 2006. **89**(1): p. 40-45.
121. Coran, S.A., S. Mulas, and A. Vasconi, *Profiling of components and validated determination of iridoids in Gardenia Jasminoides Ellis fruit by a high-performance-thin-layer- chromatography/mass spectrometry approach*. J. Chromatogr. A, 2014. **1325**: p. 221-226.
122. Yin, F., et al., *Quality control of Gardeniae fructus by HPLC-PDA fingerprint coupled with chemometric method*. J Chromatogr Sci, 2015.
123. Papandreou, M.A., et al., *Inhibitory activity on amyloid- $\beta$  aggregation and antioxidant properties of crocus sativus stigmas extract and its crocin constituents*. J. Agric. Food Chem., 2006: p. 8762–8768.
124. Hassani, F.V., et al., *Antidepressant effects of crocin and its effects on transcript and protein levels of CREB, BDNF, and VGF in rat hippocampus*. J. Pharm. Sci., 2014. **22**: p. 1-9.
125. Skalicka-Woz'niak, K., J. Widelski, and K. Gtowniak, *Plant materials in modern pharmacy and methods of their investigations*. Thin layer chromatography in phytochemistry Vol. 99. 2008, The United State of America: CRC Press.
126. Park, E.-H., et al., *Antiangiogenic activity of Gardenia jasminoides fruit*. Phytother. Res. , 2003. **17**: p. 961-962.
127. Liu, S.-L., et al., *Anti-depressive activity of Gardeniae fructus and geniposide in mouse models of depression*. AJPP, 2011. **5**(13): p. 1580-1588.
128. Dar, R.A., et al., *Indirect electrochemical analysis of crocin in phytochemical sample*. E-J. Chem., 2012. **9**(2): p. 918-925.
129. Yanga, W., et al., *A new method research for determination of natural pigment crocin yellow in foods by solid-phase extraction ultrahigh pressure liquid chromatography*. J. Chromatogr. A, 2011. **1218**: p. 1423–1428.

130. Y, C., et al., *Determination of geniposide, crocin and crocetin in different processing products of fructus gardeniae by HPLC-ELSD*. Zhong Yao Cai., 2011. **34**(5): p. 687-690.
131. Siwaporn siwawej and Auchareeya Jarayapun, *The food color extraction from Gardenia fruit (Gardenia jasminodes Ellisforma var gardiflora Makino) : The appropriate extraction conditions*. Kasetsart J. (Nat. Sci.) 1998. **32**: p. 520-528.
132. Wu, X., et al., *Quality control and producing areas differentiation of Gardeniae Fructus for eight bioactive constituents by HPLC-DAD-ESI/MS*. Phytomedicine, 2014. **21**(4): p. 551-559.
133. Bergonzi, M.C., et al., *Identification and quantification of constituents of Gardenia jasminoides Ellis (Zhizi) by HPLC-DAD-ESI-MS*. Food Chem., 2012(134): p. 1199-1204.
134. Xiaoling, Z., *Antioxidant activity of crocins from Gardeniae jasminoides Ellis evaluated by UV-Vis-NIR*. Adv Mat Res, 2014. **1073-1076**: p. 1863-1866.
135. Hadizadeh, F., S.A. Mohajeri, and M. Seifi, *Extraction and purification of crocin from saffron stigmas employing a simple and efficient crystallization method*. J Biol Sci, 2010. **13**(14): p. 691-698.
136. Chen, Y., et al., *Crocin and geniposide profiles and radical scavenging activity of gardenia fruits (Gardenia jasminoides Ellis) from different cultivars and at the various stages of maturation*. Fitoterapia, 2010. **81**(4): p. 269-273.
137. Wang, Y., et al., *Systematic Separation and Purification of Iridoid Glycosides and Crocetin Derivatives from Gardenia jasminoides Ellis by High-speed Counter-current Chromatography*. Phytochem. Anal., 2015. **26**: p. 202-208.
138. Chen, Y., et al., *Spectroscopic, stability and radical-scavenging properties of a novel pigment from gardenia*. Food Chem, 2008. **109**: p. 269-277.

APPENDICES

The logo of Chulalongkorn University, featuring a central emblem with a sunburst and a tiered structure, set within a circular frame.

จุฬาลงกรณ์มหาวิทยาลัย  
CHULALONGKORN UNIVERSITY



APPENDIX A

Leaf constant of eleven *Gardenia* species

จุฬาลงกรณ์มหาวิทยาลัย  
CHULALONGKORN UNIVERSITY

Table 16 Leaf constant of *Gardenia carinata*

Field	Stomatal number			Stomatal index			Palisaderatio		
	Source	Source	Source	Source	Source	Source	Source	Source	Source
	1	2	3	1	2	3	1	2	3
1	400.0	440.0	380.0	20.04	20.79	21.20	5.38	4.00	4.13
2	388.0	468.0	376.0	19.96	21.59	19.70	5.38	4.00	4.50
3	392.0	388.0	384.0	18.96	20.95	20.77	4.75	4.13	3.88
4	356.0	384.0	396.0	19.78	21.38	21.52	5.25	4.00	4.25
5	376.0	388.0	396.0	19.75	17.60	20.16	4.50	4.63	3.75
6	328.0	336.0	376.0	20.00	17.98	19.18	4.50	4.63	4.88
7	396.0	332.0	384.0	17.65	18.14	17.20	4.88	4.63	4.38
8	380.0	312.0	388.0	18.19	16.88	20.59	5.13	5.38	4.63
9	352.0	376.0	384.0	17.53	18.32	19.63	4.00	5.00	4.13
10	352.0	384.0	388.0	19.38	20.77	20.08	5.38	4.63	4.13
11	352.0	388.0	404.0	20.23	19.13	20.82	5.13	5.00	5.38
12	456.0	372.0	384.0	24.41	20.48	20.42	5.13	4.38	4.13
13	348.0	368.0	356.0	15.56	21.90	17.83	5.13	4.88	3.88
14	484.0	364.0	364.0	21.04	18.84	19.07	4.38	4.13	4.63
15	464.0	388.0	392.0	21.48	18.61	21.30	5.50	5.75	4.00
16	440.0	384.0	360.0	20.87	19.51	17.68	4.38	4.00	4.13
17	424.0	372.0	384.0	20.19	20.43	20.77	5.25	5.00	3.88
18	412.0	368.0	388.0	20.85	17.64	22.82	4.75	4.63	5.38
19	408.0	356.0	376.0	21.79	18.73	19.18	4.00	5.13	5.25
20	368.0	380.0	332.0	19.37	19.91	16.53	4.50	4.75	4.63
21	380.0	384.0	340.0	20.25	18.82	16.69	4.75	5.38	4.63
22	328.0	376.0	384.0	17.59	21.31	18.71	4.50	5.50	5.00
23	364.0	388.0	368.0	19.07	19.79	17.72	5.00	4.00	4.13
24	372.0	364.0	380.0	19.17	18.68	19.91	5.25	4.38	4.00
25	392.0	360.0	344.0	21.12	18.90	19.02	5.13	4.63	3.88
26	352.0	380.0	388.0	19.55	19.54	18.98	4.25	5.25	3.63
27	388.0	364.0	368.0	19.79	19.56	19.04	4.88	4.00	4.13
28	364.0	384.0	420.0	18.16	19.67	21.12	4.00	4.00	4.38
29	408.0	368.0	416.0	20.48	20.08	19.88	4.38	4.63	4.38
30	392.0	332.0	380.0	20.25	18.87	17.30	5.13	5.38	4.13
Min-Max	312-484			15.56-24.41			3.62-5.75		
Mean±SD	380.49±30.05			19.58±1.48			4.60±0.52		

Table 16 Leaf constant of *Gardenia carinata* (cont.)

Field	Epidermal cell number			Epidermal cell area			Trichome number		
	Source 1	Source 2	Source 3	Source 1	Source 2	Source 3	Source 1	Source 2	Source3
1	2156.0	2112.0	2124.0	463.82	473.48	470.81	-	-	-
2	2172.0	2132.0	2144.0	460.41	469.04	466.42	-	-	-
3	2020.0	2064.0	2036.0	495.05	484.50	491.16	-	-	-
4	2024.0	2064.0	2032.0	494.07	484.50	492.13	-	-	-
5	2080.0	2116.0	2092.0	480.77	472.59	478.01	-	-	-
6	2152.0	2116.0	2132.0	464.68	472.59	469.04	-	-	-
7	2144.0	2108.0	2132.0	466.42	474.38	469.04	-	-	-
8	2016.0	2032.0	2032.0	496.03	492.13	492.13	-	-	-
9	2140.0	2116.0	2128.0	467.29	472.59	469.92	-	-	-
10	2132.0	2156.0	2120.0	469.04	463.82	471.70	-	-	-
11	2096.0	2116.0	2108.0	477.10	472.59	474.38	-	-	-
12	2056.0	2072.0	2072.0	486.38	482.63	482.63	-	-	-
13	2064.0	2076.0	2068.0	484.50	481.70	483.56	-	-	-
14	2072.0	2080.0	2100.0	482.63	480.77	476.19	-	-	-
15	2152.0	2116.0	2132.0	464.68	472.59	469.04	-	-	-
16	2316.0	2292.0	2288.0	431.78	436.30	437.06	-	-	-
17	2164.0	2144.0	2128.0	462.11	466.42	469.92	-	-	-
18	2276.0	2292.0	2288.0	439.37	436.30	437.06	-	-	-
19	2148.0	2172.0	2136.0	465.55	460.41	468.16	-	-	-
20	2196.0	2152.0	2172.0	455.37	464.68	460.41	-	-	-
21	2084.0	2128.0	2096.0	479.85	469.92	477.10	-	-	-
22	1940.0	1972.0	2008.0	515.46	507.10	498.01	-	-	-
23	2076.0	2080.0	2100.0	481.70	480.77	476.19	-	-	-
24	2112.0	2116.0	2112.0	473.48	472.59	473.48	-	-	-
25	2104.0	2124.0	2120.0	475.29	470.81	471.70	-	-	-
26	2232.0	2204.0	2276.0	448.03	453.72	439.37	-	-	-
27	2172.0	2156.0	2164.0	460.41	463.82	462.11	-	-	-
28	2048.0	2096.0	2136.0	488.28	477.10	468.16	-	-	-
29	2016.0	2112.0	2088.0	496.03	473.48	478.93	-	-	-
30	2084.0	2100.0	2116.0	479.85	476.19	472.59	-	-	-
Min-Max	1940.00-2316.00			431.78-515.46			-		
Mean±SD	2119.3±70.09			472.4±15.36			-		

Table 17 Leaf constant of *Gardenia tubifera*

Field	Stomatal number			Stomatal index			Palisaderatio		
	Source 1	Source 2	Source 3	Source 1	Source 2	Source 3	Source 1	Source 2	Source 3
1	500.0	450.0	500.0	17.69	17.30	17.85	4.00	3.75	4.00
2	425.0	400.0	450.0	16.34	16.49	16.66	4.25	4.25	3.50
3	500.0	475.0	425.0	17.54	17.92	16.50	3.75	4.50	4.25
4	450.0	500.0	450.0	16.82	17.54	16.82	3.75	4.00	4.25
5	475.0	450.0	425.0	18.09	17.14	16.34	4.50	4.75	3.75
6	450.0	475.0	500.0	16.66	17.59	17.54	4.25	3.25	4.00
7	425.0	450.0	425.0	16.19	16.98	16.03	4.00	4.50	4.50
8	500.0	475.0	500.0	17.54	17.11	18.01	3.50	4.00	3.75
9	575.0	500.0	475.0	19.16	17.45	16.66	4.50	4.00	4.25
10	525.0	500.0	475.0	18.26	17.69	17.11	4.25	4.50	4.25
11	500.0	450.0	450.0	17.85	16.82	16.66	3.75	3.50	3.75
12	450.0	425.0	425.0	16.82	16.50	16.66	4.25	4.00	4.00
13	425.0	450.0	425.0	16.50	17.47	16.34	4.50	4.25	4.50
14	475.0	500.0	400.0	17.43	17.24	15.68	4.50	4.25	4.50
15	500.0	475.0	500.0	17.85	17.27	17.85	4.00	4.25	4.75
16	500.0	475.0	475.0	18.01	17.59	17.75	4.25	3.75	4.25
17	475.0	500.0	450.0	18.09	17.85	16.21	4.50	4.25	4.25
18	450.0	425.0	450.0	16.98	16.50	17.47	3.75	4.25	4.25
19	475.0	500.0	475.0	18.26	17.54	16.66	4.25	4.00	3.75
20	500.0	450.0	500.0	18.18	16.51	17.24	4.75	4.50	4.50
21	450.0	475.0	425.0	17.14	17.75	16.03	4.00	3.50	4.00
22	475.0	450.0	500.0	18.26	17.64	17.39	4.25	4.50	4.00
23	475.0	425.0	450.0	17.75	16.83	17.47	3.50	4.25	3.50
24	500.0	525.0	475.0	17.54	17.94	16.37	4.00	4.25	4.50
25	525.0	500.0	425.0	18.26	17.85	15.88	4.50	4.00	4.25
26	500.0	450.0	425.0	17.85	16.98	17.34	3.75	3.75	4.25
27	475.0	425.0	475.0	17.59	16.66	17.59	4.25	3.75	4.75
28	500.0	400.0	425.0	17.69	16.32	16.66	4.25	4.25	3.75
29	450.0	425.0	450.0	16.82	16.83	17.30	4.50	4.25	3.75
30	450.0	500.0	475.0	16.66	17.54	18.09	3.75	4.50	4.25
Min-Max	400-575			15.69-19.17			3.25-4.75		
Mean±SD	466.39±33.34			17.24±0.67			4.12±0.34		

Table 17 Leaf constant of *Gardenia tubifera* (cont.)

Field	Epidermal cell number			Epidermal cell area			Trichome number		
	Source 1	Source 2	Source 3	Source 1	Source 2	Source 3	Source 1	Source 2	Source 3
1	4325.0	4250.0	4300.0	231.21	235.29	232.56	8.00	12.00	8.00
2	4350.0	4300.0	4375.0	229.89	232.56	228.57	8.00	12.00	12.00
3	4400.0	4375.0	4350.0	227.27	228.57	229.89	12.00	8.00	8.00
4	4250.0	4200.0	4300.0	235.29	238.10	232.56	8.00	8.00	8.00
5	4200.0	4150.0	4175.0	238.10	240.96	239.52	16.00	12.00	12.00
6	4150.0	4250.0	4250.0	240.96	235.29	235.29	16.00	16.00	8.00
7	4175.0	4125.0	4125.0	239.52	242.42	242.42	16.00	12.00	12.00
8	4400.0	4300.0	4375.0	227.27	232.56	228.57	8.00	8.00	12.00
9	4200.0	4225.0	4225.0	238.10	236.69	236.69	12.00	16.00	8.00
10	4125.0	4100.0	4150.0	242.42	243.90	240.96	16.00	8.00	8.00
11	4350.0	4375.0	4375.0	229.89	228.57	228.57	8.00	12.00	16.00
12	4325.0	4300.0	4275.0	231.21	232.56	233.92	8.00	16.00	12.00
13	4375.0	4200.0	4250.0	228.57	238.10	235.29	12.00	8.00	16.00
14	4300.0	4350.0	4350.0	232.56	229.89	229.89	12.00	12.00	8.00
15	4225.0	4350.0	4175.0	236.69	229.89	239.52	8.00	8.00	16.00
16	4200.0	4250.0	4275.0	238.10	235.29	233.92	8.00	12.00	8.00
17	4275.0	4175.0	4300.0	233.92	239.52	232.56	12.00	12.00	12.00
18	4375.0	4325.0	4350.0	228.57	231.21	229.89	12.00	8.00	12.00
19	4325.0	4275.0	4225.0	231.21	233.92	236.69	8.00	16.00	12.00
20	4300.0	4225.0	4150.0	232.56	236.69	240.96	16.00	8.00	16.00
21	4225.0	4100.0	4275.0	236.69	243.90	233.92	12.00	12.00	12.00
22	4150.0	4275.0	4250.0	240.96	233.92	235.29	16.00	8.00	12.00
23	4325.0	4350.0	4300.0	231.21	229.89	232.56	12.00	12.00	8.00
24	4250.0	4200.0	4225.0	235.29	238.10	236.69	12.00	12.00	12.00
25	4375.0	4325.0	4200.0	228.57	231.21	238.10	16.00	8.00	8.00
26	4200.0	4250.0	4275.0	238.10	235.29	233.92	12.00	12.00	8.00
27	4150.0	4150.0	4375.0	240.96	240.96	228.57	8.00	12.00	12.00
28	4225.0	4175.0	4125.0	236.69	239.52	242.42	8.00	8.00	12.00
29	4350.0	4300.0	4200.0	229.89	232.56	238.10	12.00	12.00	16.00
30	4300.0	4275.0	4250.0	232.56	233.92	235.29	8.00	8.00	8.00
Min-Max	4100.00-4400.00			227.27-243.90			8-16		
Mean±SD	4261.0±80.04			234.7±4.39			11.11±2.92		



Table 18 Leaf constant of *Gardenia lineata*

Field	Stomatal number			Stomatal index			Palisade ratio		
	Source 1	Source 2	Source 3	Source 1	Source 2	Source 3	Source 1	Source 2	Source 3
1	436.0	440.0	428.0	27.25	27.50	27.50	10.25	9.88	10.50
2	424.0	416.0	420.0	27.24	26.94	26.58	10.63	10.75	11.13
3	432.0	420.0	412.0	26.79	26.18	26.41	10.00	10.75	10.38
4	400.0	428.0	424.0	27.62	27.15	26.36	10.50	10.13	10.00
5	412.0	440.0	440.0	27.61	27.77	27.29	10.75	11.38	10.25
6	416.0	416.0	388.0	28.10	27.01	26.00	10.13	10.38	10.63
7	444.0	440.0	420.0	27.33	27.29	27.20	10.63	10.00	10.38
8	384.0	412.0	412.0	26.30	27.17	26.89	11.00	10.75	10.50
9	428.0	408.0	424.0	25.90	26.63	27.31	10.38	10.88	10.63
10	436.0	432.0	408.0	26.84	27.69	25.69	10.50	11.50	10.25
11	416.0	420.0	404.0	27.80	26.64	27.22	10.00	10.38	10.25
12	428.0	416.0	392.0	26.55	26.53	26.70	10.13	10.00	10.50
13	420.0	424.0	416.0	27.70	27.74	27.73	10.38	10.50	10.13
14	432.0	384.0	412.0	27.90	25.73	27.61	11.25	11.00	10.88
15	420.0	416.0	416.0	26.25	25.80	27.73	10.25	10.13	11.50
16	444.0	412.0	412.0	27.47	25.94	27.91	10.75	10.63	10.25
17	400.0	420.0	424.0	25.64	26.71	27.53	11.00	10.25	10.25
18	424.0	432.0	404.0	28.41	27.62	26.79	10.00	10.50	10.38
19	412.0	416.0	412.0	27.03	27.36	26.68	10.75	11.00	11.00
20	408.0	420.0	412.0	27.56	26.99	26.27	10.00	11.38	10.63
21	412.0	428.0	404.0	27.61	26.81	27.22	10.63	10.13	10.38
22	428.0	416.0	396.0	26.61	26.19	27.42	10.00	10.25	10.25
23	408.0	384.0	440.0	27.71	27.27	27.29	11.25	10.00	10.50
24	412.0	400.0	416.0	26.96	26.59	27.73	10.50	10.75	10.25
25	428.0	420.0	408.0	26.55	26.38	27.41	10.13	9.75	10.38
26	380.0	388.0	416.0	27.53	27.87	27.80	11.25	11.13	11.50
27	404.0	416.0	404.0	26.71	27.44	26.79	10.00	10.50	10.25
28	392.0	428.0	408.0	27.84	26.88	26.08	10.13	10.25	9.88
29	412.0	416.0	420.0	26.27	26.66	27.70	10.00	10.50	10.63
30	420.0	416.0	408.0	27.13	26.46	27.41	11.00	10.13	10.00
Min-Max	380-444			25.64-28.42			9.75-11.50		
Mean±SD	415.96±14.07			27.04±0.63			10.49±0.42		

Table 18 Leaf constant of *Gardenia lineata* (cont.)

Field	Epidermal cell number			Epidermal cell area			Trichome number		
	Source	Source	Source	Source	Source	Source	Source	Source	Source
	1	2	3	1	2	3	1	2	3
1	1032.0	1024.0	1012.0	968.99	976.56	988.14	-	-	-
2	1008.0	1016.0	1016.0	992.06	984.25	984.25	-	-	-
3	1040.0	1028.0	1012.0	961.54	972.76	988.14	-	-	-
4	1000.0	1012.0	1004.0	1000.00	988.14	996.02	-	-	-
5	1044.0	1020.0	1032.0	957.85	980.39	968.99	-	-	-
6	1048.0	1032.0	1024.0	954.20	968.99	976.56	-	-	-
7	1008.0	1024.0	1016.0	992.06	976.56	984.25	-	-	-
8	1084.0	1048.0	1048.0	922.51	954.20	954.20	-	-	-
9	1116.0	1068.0	1108.0	896.06	936.33	902.53	-	-	-
10	1036.0	1072.0	1024.0	965.25	932.84	976.56	-	-	-
11	1004.0	1048.0	1016.0	996.02	954.20	984.25	-	-	-
12	1040.0	1012.0	1044.0	961.54	988.14	957.85	-	-	-
13	1024.0	1020.0	1016.0	976.56	980.39	984.25	-	-	-
14	1124.0	1116.0	1112.0	889.68	896.06	899.28	-	-	-
15	952.0	1046.0	988.0	950.42	1024.59	912.15	-	-	-
16	1004.0	1012.0	1012.0	996.02	988.14	988.14	-	-	-
17	988.0	1016.0	996.0	1012.15	984.25	1004.02	-	-	-
18	1020.0	1012.0	1028.0	1040.39	988.14	972.76	-	-	-
19	984.0	1032.0	996.0	1016.26	1008.06	1004.02	-	-	-
20	1040.0	1044.0	964.0	1063.83	1059.32	1037.34	-	-	-
21	992.0	1016.0	1012.0	1008.06	984.25	988.14	-	-	-
22	1072.0	1080.0	988.0	1028.81	1020.41	1012.15	-	-	-
23	984.0	1000.0	1012.0	1016.26	1000.00	988.14	-	-	-
24	1060.0	1024.0	1016.0	1043.40	976.56	984.25	-	-	-
25	980.0	1024.0	1004.0	1020.41	976.56	996.02	-	-	-
26	1080.0	956.0	1052.0	1020.41	1046.03	1050.42	-	-	-
27	988.0	1000.0	996.0	1012.15	1000.00	1004.02	-	-	-
28	988.0	1004.0	1016.0	1012.15	996.02	984.25	-	-	-
29	940.0	996.0	1004.0	1063.83	1004.02	996.02	-	-	-
30	1036.0	996.0	1008.0	965.25	1004.02	992.06	-	-	-
Min-Max	940.00-1124.00			889.68-1063.83			-		
Mean±SD	1015.3±36.81			986.1±34.97			-		

Table 19 Leaf constant of *Gardenia taitensis*

Field	Stomatal number			Stomatal index			Palisaderatio		
	Source 1	Source 2	Source 3	Source 1	Source 2	Source 3	Source 1	Source 2	Source 3
1	304.0	312.0	316.0	35.18	31.57	31.85	12.75	12.63	12.38
2	308.0	316.0	296.0	34.37	32.37	30.83	13.25	13.50	13.00
3	332.0	320.0	316.0	32.80	31.62	32.37	12.50	12.38	12.88
4	336.0	328.0	304.0	33.07	32.28	34.08	12.88	13.13	12.50
5	332.0	296.0	344.0	32.93	34.57	33.20	12.88	12.75	12.75
6	308.0	308.0	328.0	30.43	30.07	33.06	13.38	12.63	12.75
7	312.0	304.0	304.0	31.96	31.14	30.64	13.50	13.13	13.13
8	292.0	320.0	324.0	30.54	35.24	32.27	14.00	12.75	13.50
9	300.0	336.0	332.0	31.12	33.20	33.06	12.63	12.63	14.13
10	304.0	320.0	324.0	31.53	32.25	32.40	12.50	14.25	12.50
11	316.0	336.0	320.0	34.64	33.60	32.00	12.88	13.50	12.38
12	344.0	324.0	320.0	33.20	32.27	32.52	13.13	13.00	12.75
13	344.0	340.0	320.0	33.33	33.33	34.93	12.50	12.88	13.13
14	340.0	320.0	320.0	33.07	31.25	34.93	12.50	12.63	14.00
15	320.0	312.0	320.0	30.88	34.36	31.25	12.50	12.50	14.25
16	324.0	336.0	336.0	32.53	33.07	31.93	13.13	12.75	13.38
17	304.0	320.0	304.0	31.14	32.52	29.80	13.38	13.13	12.50
18	312.0	320.0	316.0	31.57	31.74	31.47	12.88	14.25	12.75
19	312.0	312.0	316.0	35.45	31.96	31.47	12.50	13.88	12.75
20	316.0	312.0	320.0	34.64	31.20	34.78	13.13	12.88	13.13
21	344.0	300.0	340.0	33.20	33.48	33.46	13.13	12.50	12.38
22	344.0	336.0	316.0	33.33	31.93	32.24	12.50	12.50	12.00
23	344.0	312.0	320.0	33.33	31.57	34.93	13.13	12.88	12.88
24	320.0	300.0	332.0	30.88	31.12	32.42	13.38	14.00	13.00
25	320.0	328.0	316.0	32.12	32.15	32.24	12.50	12.75	13.38
26	304.0	304.0	320.0	31.02	33.62	31.74	13.13	12.88	13.75
27	300.0	320.0	320.0	31.12	31.74	32.00	13.38	12.50	12.88
28	320.0	316.0	316.0	34.78	31.85	31.85	13.13	13.25	12.50
29	304.0	316.0	328.0	34.38	34.64	32.66	12.88	13.13	12.63
30	316.0	320.0	328.0	34.64	35.55	32.80	13.00	12.50	12.50
Min-Max	292-344			29.80-35.56			12.00-14.25		
Mean±SD	319.29±12.69			32.62±1.37			12.97±0.49		

Table 19 Leaf constant of *Gardenia taitensis* (cont.)

Field	Epidermal cell number			Epidermal cell area			Trichome number		
	Source 1	Source 2	Source 3	Source 1	Source 2	Source 3	Source 1	Source 2	Source 3
1	776.0	880.0	760.0	1288.66	1136.36	1315.79	-	-	-
2	768.0	796.0	788.0	1302.08	1256.28	1269.04	-	-	-
3	840.0	904.0	816.0	1190.48	1106.19	1225.49	-	-	-
4	856.0	828.0	872.0	1168.22	1207.73	1146.79	-	-	-
5	836.0	784.0	844.0	1196.17	1275.51	1184.83	-	-	-
6	872.0	876.0	860.0	1146.79	1141.55	1162.79	-	-	-
7	868.0	824.0	876.0	1152.07	1213.59	1141.55	-	-	-
8	800.0	772.0	788.0	1250.00	1295.34	1269.04	-	-	-
9	804.0	900.0	812.0	1243.78	1111.11	1231.53	-	-	-
10	784.0	764.0	796.0	1275.51	1308.90	1256.28	-	-	-
11	748.0	808.0	760.0	1336.90	1237.62	1315.79	-	-	-
12	756.0	852.0	760.0	1322.75	1173.71	1322.75	-	-	-
13	776.0	776.0	764.0	1288.66	1288.66	1308.90	-	-	-
14	828.0	784.0	816.0	1207.73	1275.51	1225.49	-	-	-
15	912.0	860.0	908.0	1096.49	1162.79	1101.32	-	-	-
16	904.0	824.0	892.0	1106.19	1213.59	1121.08	-	-	-
17	904.0	756.0	892.0	1106.19	1322.75	1121.08	-	-	-
18	888.0	872.0	900.0	1126.13	1146.79	1111.11	-	-	-
19	808.0	784.0	816.0	1237.62	1275.51	1225.49	-	-	-
20	852.0	808.0	844.0	1173.71	1237.62	1184.83	-	-	-
21	888.0	896.0	896.0	1126.13	1116.07	1116.07	-	-	-
22	872.0	784.0	884.0	1146.79	1275.51	1131.22	-	-	-
23	868.0	796.0	876.0	1152.07	1256.28	1141.55	-	-	-
24	796.0	816.0	804.0	1256.28	1225.49	1243.78	-	-	-
25	788.0	860.0	780.0	1269.04	1162.79	1282.05	-	-	-
26	776.0	844.0	776.0	1288.66	1184.83	1288.66	-	-	-
27	816.0	896.0	824.0	1225.49	1116.07	1213.59	-	-	-
28	784.0	784.0	776.0	1275.51	1275.51	1288.66	-	-	-
29	800.0	848.0	796.0	1250.00	1179.25	1256.28	-	-	-
30	808.0	844.0	812.0	1237.62	1184.83	1231.53	-	-	-
Min-Max	748.00-912.00			1096.49-1336.90			-		
Mean±SD	826.5±46.65			1213.8±67.98			-		

Table 20 Leaf constant of *Gardenia thailandica*

Field	Stomatal number			Stomatal index			Palisade ratio		
	Source 1	Source 2	Source 3	Source 1	Source 2	Source 3	Source 1	Source 2	Source 3
1	568.0	536.0	580.0	28.34	28.03	28.88	10.38	9.63	10.63
2	588.0	548.0	536.0	28.26	28.13	28.94	10.00	10.38	10.00
3	588.0	568.0	520.0	28.99	28.28	28.38	10.75	10.00	10.13
4	520.0	524.0	520.0	28.26	28.41	28.26	10.38	10.25	10.00
5	532.0	560.0	512.0	28.41	28.28	28.13	11.00	10.38	10.75
6	528.0	532.0	524.0	28.63	28.78	28.11	10.13	11.00	11.63
7	548.0	544.0	528.0	28.78	28.63	28.38	10.00	10.63	11.00
8	508.0	512.0	552.0	27.78	27.94	28.63	10.13	10.00	10.63
9	544.0	580.0	524.0	28.75	28.43	28.41	10.75	10.25	10.75
10	532.0	524.0	524.0	28.60	28.29	28.05	10.50	10.38	10.00
11	528.0	544.0	520.0	28.63	28.87	28.01	10.75	9.88	10.38
12	536.0	528.0	532.0	28.57	28.26	28.35	10.63	10.13	9.75
13	512.0	528.0	528.0	28.07	28.69	28.14	10.63	11.13	10.00
14	568.0	536.0	580.0	28.92	28.09	28.71	10.50	11.25	10.13
15	580.0	560.0	536.0	28.88	28.16	28.63	10.50	10.13	11.13
16	552.0	544.0	524.0	28.22	27.92	28.29	10.38	10.25	10.63
17	548.0	528.0	528.0	28.96	28.20	28.08	10.50	10.50	10.75
18	532.0	532.0	520.0	28.72	28.72	28.13	10.75	10.13	10.25
19	532.0	552.0	544.0	28.54	29.29	28.81	10.88	10.50	10.00
20	528.0	544.0	536.0	28.26	28.87	28.03	10.13	10.63	10.63
21	512.0	528.0	528.0	27.94	28.57	28.44	10.38	11.00	10.50
22	544.0	536.0	548.0	28.33	28.03	28.07	11.00	10.38	10.38
23	532.0	532.0	564.0	28.05	28.05	28.42	10.63	10.00	10.25
24	572.0	528.0	520.0	29.00	28.02	28.26	10.75	10.25	10.75
25	580.0	552.0	528.0	27.93	28.87	28.44	10.75	10.38	10.50
26	528.0	548.0	520.0	28.32	29.02	28.19	10.13	10.75	10.13
27	524.0	536.0	544.0	28.05	28.51	28.63	10.50	10.63	9.88
28	548.0	524.0	528.0	28.96	28.05	28.20	10.38	10.75	10.13
29	520.0	524.0	516.0	28.01	28.17	28.16	10.50	10.13	10.38
30	532.0	524.0	528.0	28.60	28.29	28.26	10.13	10.75	10.25
Min-Max	508-588			27.79-29.30			9.62-11.62		
Mean±SD	537.91±18.85			28.40±0.33			10.44±0.36		

Table 20 Leaf constant of *Gardenia thailandica* (cont.)

Field	Epidermal cell number			Epidermal cell area			Trichome number		
	Source 1	Source 2	Source 3	Source 1	Source 2	Source 3	Source 1	Source 2	Source 3
1	1392.0	1368.0	1348.0	718.39	730.99	741.84	-	-	-
2	1324.0	1312.0	1336.0	755.29	762.20	748.50	-	-	-
3	1320.0	1332.0	1320.0	757.58	750.75	757.58	-	-	-
4	1344.0	1324.0	1332.0	744.05	755.29	750.75	-	-	-
5	1396.0	1376.0	1384.0	716.33	726.74	722.54	-	-	-
6	1344.0	1320.0	1352.0	744.05	757.58	739.64	-	-	-
7	1332.0	1324.0	1324.0	750.75	755.29	755.29	-	-	-
8	1356.0	1340.0	1368.0	737.46	746.27	730.99	-	-	-
9	1384.0	1388.0	1368.0	722.54	720.46	730.99	-	-	-
10	1276.0	1288.0	1304.0	783.70	776.40	766.87	-	-	-
11	1384.0	1380.0	1352.0	722.54	724.64	739.64	-	-	-
12	1316.0	1324.0	1320.0	759.88	755.29	757.58	-	-	-
13	1384.0	1328.0	1380.0	722.54	753.01	724.64	-	-	-
14	1376.0	1388.0	1384.0	726.74	720.46	722.54	-	-	-
15	1380.0	1368.0	1356.0	724.64	730.99	737.46	-	-	-
16	1300.0	1312.0	1320.0	769.23	762.20	757.58	-	-	-
17	1288.0	1312.0	1320.0	776.40	762.20	757.58	-	-	-
18	1340.0	1332.0	1328.0	746.27	750.75	753.01	-	-	-
19	1384.0	1360.0	1372.0	722.54	735.29	728.86	-	-	-
20	1308.0	1316.0	1320.0	764.53	759.88	757.58	-	-	-
21	1356.0	1368.0	1332.0	737.46	730.99	750.75	-	-	-
22	1324.0	1324.0	1324.0	755.29	755.29	755.29	-	-	-
23	1264.0	1280.0	1276.0	791.14	781.25	783.70	-	-	-
24	1272.0	1296.0	1284.0	786.16	771.60	778.82	-	-	-
25	1332.0	1336.0	1328.0	750.75	748.50	753.01	-	-	-
26	1264.0	1296.0	1272.0	791.14	771.60	786.16	-	-	-
27	1276.0	1280.0	1292.0	783.70	781.25	773.99	-	-	-
28	1284.0	1288.0	1288.0	778.82	776.40	776.40	-	-	-
29	1340.0	1336.0	1344.0	746.27	748.50	744.05	-	-	-
30	1340.0	1320.0	1336.0	746.27	757.58	748.50	-	-	-
Min-Max	1264.00-1396.00			716.33-791.14			-		
Mean±SD	1331.8±34.67			751.4±19.59			-		

Table 21 Leaf constant of *Gardenia griffithii*

Field	Stomatal number			Stomatal index			Palisade ratio		
	Source 1	Source 2	Source 3	Source 1	Source 2	Source 3	Source 1	Source 2	Source 3
1	424.0	412.0	404.0	25.91	25.36	24.87	7.88	7.88	7.50
2	412.0	404.0	408.0	24.93	24.57	24.81	7.50	8.00	7.88
3	408.0	416.0	440.0	25.06	25.42	25.76	7.63	7.75	8.25
4	456.0	408.0	412.0	25.22	25.31	25.06	8.00	7.63	8.00
5	432.0	424.0	400.0	24.82	25.41	24.57	8.25	8.00	7.88
6	404.0	440.0	432.0	25.06	25.94	25.71	8.50	8.25	8.13
7	440.0	408.0	404.0	24.83	25.24	25.18	8.50	8.25	8.00
8	448.0	404.0	404.0	25.28	24.81	25.0	7.50	8.13	8.63
9	444.0	412.0	424.0	25.17	25.00	25.72	8.13	8.25	8.63
10	440.0	412.0	400.0	24.66	25.18	25.0	8.63	8.50	8.50
11	408.0	424.0	408.0	24.93	25.66	25.24	8.50	8.75	8.75
12	440.0	432.0	428.0	25.11	24.77	25.97	7.50	8.13	8.00
13	408.0	436.0	400.0	25.18	25.89	24.93	8.25	8.50	8.50
14	424.0	440.0	416.0	25.72	25.64	25.12	8.00	7.88	7.88
15	416.0	416.0	408.0	25.18	25.18	25.0	8.50	8.00	8.00
16	404.0	408.0	416.0	25.06	25.24	25.74	7.88	8.50	7.63
17	408.0	408.0	444.0	25.37	25.37	25.93	8.50	8.25	8.88
18	416.0	412.0	404.0	25.36	25.18	25.06	7.88	7.63	8.25
19	408.0	400.0	412.0	25.18	24.81	25.43	7.50	8.00	7.75
20	424.0	416.0	432.0	25.72	25.36	25.59	7.50	8.25	8.13
21	432.0	424.0	408.0	24.54	25.66	24.93	8.50	8.75	8.00
22	408.0	408.0	424.0	24.87	24.87	24.42	8.63	8.13	7.75
23	404.0	420.0	408.0	25.06	25.79	25.0	7.50	8.25	8.25
24	404.0	416.0	408.0	25.18	25.74	25.24	8.13	8.63	7.63
25	416.0	412.0	404.0	25.61	25.43	24.81	8.00	8.38	8.50
26	408.0	432.0	428.0	25.18	25.41	25.41	8.50	8.50	8.75
27	404.0	416.0	408.0	25.18	25.74	24.81	7.50	7.50	8.00
28	408.0	412.0	420.0	25.24	25.43	25.17	8.63	8.13	8.63
29	416.0	428.0	412.0	25.67	25.90	24.40	7.50	7.88	7.88
30	424.0	420.0	412.0	25.79	25.60	24.87	8.50	8.50	8.00
Min-Max	400-456			24.41-25.97			7.50-8.88		
Mean±SD	417.07±12.87			25.23±0.38			8.13±0.38		

Table 21 Leaf constant of *Gardenia griffithii* (cont.)

Field	Epidermal cell number			Epidermal cell area			Trichome number		
	Source	Source	Source	Source	Source	Source	Source	Source	Source
	1	2	3	1	2	3	1	2	3
1	1184.0	1196.0	1248.0	844.59	836.12	801.28	-	-	-
2	1264.0	1252.0	1284.0	791.14	798.72	778.82	-	-	-
3	1336.0	1320.0	1344.0	748.50	757.58	744.05	-	-	-
4	1328.0	1312.0	1324.0	753.01	762.20	755.29	-	-	-
5	1320.0	1336.0	1324.0	757.58	748.50	755.29	-	-	-
6	1308.0	1324.0	1336.0	764.53	755.29	748.50	-	-	-
7	1312.0	1332.0	1328.0	762.20	750.75	753.01	-	-	-
8	1280.0	1316.0	1348.0	781.25	759.88	741.84	-	-	-
9	1340.0	1352.0	1344.0	746.27	739.64	744.05	-	-	-
10	1360.0	1340.0	1316.0	735.29	746.27	759.88	-	-	-
11	1384.0	1368.0	1408.0	722.54	730.99	710.23	-	-	-
12	1392.0	1376.0	1348.0	718.39	726.74	741.84	-	-	-
13	1392.0	1372.0	1396.0	718.39	728.86	716.33	-	-	-
14	1380.0	1408.0	1388.0	724.64	710.23	720.46	-	-	-
15	1468.0	1440.0	1428.0	681.20	694.44	700.28	-	-	-
16	1476.0	1460.0	1448.0	677.51	684.93	690.61	-	-	-
17	1408.0	1424.0	1412.0	710.23	702.25	708.22	-	-	-
18	1420.0	1396.0	1420.0	704.23	716.33	704.23	-	-	-
19	1536.0	1500.0	1512.0	651.04	666.67	661.38	-	-	-
20	1648.0	1616.0	1584.0	606.80	618.81	631.31	-	-	-
21	1428.0	1452.0	1484.0	700.28	688.71	673.85	-	-	-
22	1644.0	1612.0	1616.0	608.27	620.35	618.81	-	-	-
23	1628.0	1640.0	1636.0	614.25	609.76	611.25	-	-	-
24	1528.0	1548.0	1520.0	654.45	645.99	657.89	-	-	-
25	1504.0	1536.0	1568.0	664.89	651.04	637.76	-	-	-
26	1432.0	1472.0	1504.0	698.32	679.35	664.89	-	-	-
27	1328.0	1368.0	1384.0	753.01	730.99	722.54	-	-	-
28	1368.0	1336.0	1344.0	730.99	748.50	744.05	-	-	-
29	1652.0	1616.0	1588.0	605.33	618.81	629.72	-	-	-
30	1512.0	1536.0	1524.0	661.38	651.04	656.17	-	-	-
Min-Max	1184.00-1652.00			605.33-844.59			-		
Mean±SD	1420.3±112.61			708.4±54.88			-		



Table 22 Leaf constant of *Gardenia collinsae*

Field	Stomatal number			Stomatal index			Palisaderatio		
	Source 1	Source 2	Source 3	Source 1	Source 2	Source 3	Source 1	Source 2	Source 3
1	392.0	384.0	404.0	23.16	23.94	23.99	15.38	15.63	14.88
2	420.0	408.0	396.0	23.86	23.39	23.02	16.25	16.00	16.88
3	376.0	412.0	412.0	23.55	23.20	24.29	16.13	15.88	16.38
4	384.0	392.0	408.0	23.07	23.22	23.56	15.25	15.00	16.00
5	408.0	404.0	420.0	23.39	23.93	24.25	16.63	15.63	15.88
6	444.0	408.0	412.0	23.76	23.56	23.52	15.75	16.13	16.00
7	424.0	404.0	404.0	23.71	23.71	23.22	15.88	16.25	16.63
8	428.0	408.0	408.0	24.37	23.72	24.23	16.00	15.63	15.13
9	396.0	392.0	416.0	24.26	23.44	24.24	15.75	15.88	16.13
10	380.0	408.0	396.0	23.69	23.56	22.86	15.38	15.00	16.00
11	408.0	408.0	408.0	23.34	23.56	24.23	15.50	16.63	17.00
12	392.0	408.0	408.0	23.00	23.56	23.34	15.25	17.25	15.88
13	404.0	396.0	400.0	23.37	22.81	22.88	15.25	16.38	15.38
14	404.0	424.0	416.0	24.04	24.04	23.91	17.00	15.63	15.00
15	396.0	420.0	400.0	23.34	24.08	24.21	15.38	15.75	15.50
16	424.0	400.0	408.0	23.82	21.93	25.06	16.25	15.13	16.25
17	408.0	408.0	392.0	23.39	23.61	22.90	16.50	15.25	16.63
18	400.0	420.0	400.0	23.20	24.03	23.04	17.00	15.25	16.25
19	388.0	408.0	392.0	23.31	23.56	23.06	16.25	15.50	16.25
20	392.0	412.0	404.0	23.72	23.95	23.76	16.38	16.13	15.88
21	400.0	420.0	424.0	23.09	24.08	24.26	16.25	16.88	15.38
22	408.0	408.0	392.0	23.55	24.58	22.79	17.00	16.50	15.75
23	412.0	396.0	416.0	23.40	22.60	24.13	16.50	15.63	16.13
24	404.0	416.0	396.0	23.48	23.74	23.13	16.50	16.13	15.75
25	396.0	404.0	404.0	23.02	23.71	23.38	17.00	15.63	15.88
26	416.0	400.0	412.0	23.74	22.88	23.30	15.38	16.00	16.25
27	404.0	412.0	424.0	23.59	23.57	24.26	15.75	16.25	16.63
28	392.0	400.0	416.0	23.84	23.09	23.91	15.25	16.13	15.13
29	400.0	400.0	412.0	23.25	23.87	23.62	16.50	15.63	16.13
30	416.0	416.0	404.0	23.90	24.59	23.71	15.75	16.63	15.75
Min-Max	376-444			21.93-25.06			14.88-17.25		
Mean±SD	405.73±11.38			23.59±0.50			15.96±0.55		

Table 22 Leaf constant of *Gardenia collinsae* (cont.)

Field	Epidermal cell number			Epidermal cell area			Trichome number		
	Source 1	Source 2	Source 3	Source 1	Source 2	Source 3	Source 1	Source 2	Source 3
1	460.0	456.0	436.0	2173.91	2192.98	2293.58	-	-	-
2	448.0	452.0	452.0	2232.14	2212.39	2212.39	-	-	-
3	424.0	432.0	444.0	2358.49	2314.81	2252.25	-	-	-
4	408.0	416.0	428.0	2450.98	2403.85	2336.45	-	-	-
5	412.0	428.0	424.0	2427.18	2336.45	2358.49	-	-	-
6	424.0	420.0	420.0	2358.49	2380.95	2380.95	-	-	-
7	440.0	444.0	448.0	2272.73	2252.25	2232.14	-	-	-
8	460.0	452.0	452.0	2173.91	2212.39	2212.39	-	-	-
9	416.0	432.0	428.0	2403.85	2314.81	2336.45	-	-	-
10	412.0	440.0	436.0	2427.18	2272.73	2293.58	-	-	-
11	424.0	416.0	440.0	2358.49	2403.85	2272.73	-	-	-
12	416.0	432.0	428.0	2403.85	2314.81	2336.45	-	-	-
13	468.0	428.0	460.0	2136.75	2336.45	2173.91	-	-	-
14	400.0	408.0	420.0	2500.00	2450.98	2380.95	-	-	-
15	436.0	436.0	456.0	2293.58	2293.58	2192.98	-	-	-
16	452.0	452.0	432.0	2212.39	2212.39	2314.81	-	-	-
17	464.0	464.0	436.0	2155.17	2155.17	2293.58	-	-	-
18	452.0	452.0	436.0	2212.39	2212.39	2293.58	-	-	-
19	440.0	444.0	456.0	2272.73	2252.25	2192.98	-	-	-
20	472.0	464.0	452.0	2118.64	2155.17	2212.39	-	-	-
21	428.0	436.0	448.0	2336.45	2293.58	2232.14	-	-	-
22	436.0	432.0	436.0	2293.58	2314.81	2293.58	-	-	-
23	476.0	464.0	456.0	2100.84	2155.17	2192.98	-	-	-
24	444.0	452.0	464.0	2252.25	2212.39	2155.17	-	-	-
25	472.0	468.0	452.0	2118.64	2136.75	2212.39	-	-	-
26	440.0	456.0	456.0	2272.73	2192.98	2192.98	-	-	-
27	424.0	428.0	444.0	2358.49	2336.45	2252.25	-	-	-
28	412.0	416.0	424.0	2427.18	2403.85	2358.49	-	-	-
29	444.0	432.0	416.0	2252.25	2314.81	2403.85	-	-	-
30	452.0	440.0	432.0	2212.39	2272.73	2314.81	-	-	-
Min-Max	400.00-476.00			2100.84-2500.00			-		
Mean±SD	439.6±17.19			2278.5±89.48			-		

Table 23 Leaf constant of *Gardenia obtusifolia*

Field	Stomatal number			Stomatal index			Palisade ratio		
	Source 1	Source 2	Source 3	Source 1	Source 2	Source 3	Source 1	Source 2	Source 3
1	528.0	564.0	556.0	28.94	28.66	28.08	12.13	11.50	12.88
2	700.0	556.0	608.0	28.87	27.97	28.52	12.50	13.13	11.75
3	652.0	588.0	588.0	27.67	28.38	28.21	12.00	12.50	12.50
4	624.0	568.0	568.0	28.05	28.29	28.51	12.13	12.38	13.00
5	696.0	552.0	628.0	28.66	27.82	28.24	13.00	12.75	12.63
6	660.0	544.0	620.0	27.82	28.22	28.13	12.38	12.50	12.75
7	536.0	568.0	532.0	28.51	28.57	28.06	13.75	14.00	13.00
8	524.0	544.0	648.0	28.79	29.12	29.03	14.63	13.88	14.13
9	636.0	588.0	576.0	28.14	28.11	28.69	13.13	13.13	13.75
10	564.0	604.0	552.0	28.71	28.60	28.28	11.75	12.63	12.75
11	644.0	536.0	568.0	28.39	28.21	28.46	13.25	13.50	12.63
12	556.0	644.0	656.0	28.48	28.60	29.29	12.38	13.00	13.00
13	616.0	636.0	528.0	27.74	28.39	30.48	12.88	13.75	12.13
14	572.0	576.0	540.0	28.65	28.80	28.42	13.50	12.63	12.75
15	548.0	628.0	568.0	29.14	28.19	29.28	12.50	12.75	13.38
16	552.0	592.0	548.0	28.22	29.66	28.36	12.13	13.13	13.00
17	568.0	556.0	564.0	29.09	28.66	30.79	12.38	12.00	11.75
18	616.0	612.0	552.0	28.10	27.97	28.51	12.00	11.63	12.63
19	528.0	592.0	568.0	29.38	28.52	28.92	12.13	12.50	12.75
20	552.0	576.0	628.0	28.51	29.39	28.14	13.13	12.75	12.50
21	548.0	608.0	640.0	28.18	30.34	28.37	11.88	12.00	12.25
22	576.0	568.0	548.0	29.38	29.10	29.46	12.63	13.00	12.13
23	556.0	552.0	572.0	28.71	28.57	28.54	13.75	12.88	13.00
24	608.0	564.0	648.0	28.41	27.27	29.08	13.00	12.50	12.75
25	592.0	632.0	568.0	27.87	29.21	29.77	13.13	12.50	13.75
26	612.0	548.0	588.0	28.43	27.02	28.00	13.75	14.25	13.13
27	556.0	576.0	604.0	28.77	29.51	28.60	13.75	12.88	12.75
28	536.0	616.0	556.0	30.73	29.00	28.72	12.63	13.50	13.25
29	572.0	532.0	548.0	29.36	27.88	28.72	12.50	13.00	14.38
30	588.0	568.0	632.0	29.05	28.34	29.31	13.25	13.75	12.88
Min-Max	524-700			27.02-30.79			11.50-14.62		
Mean±SD	583.38±39.80			28.64±0.66			12.84±0.65		

Table 23 Leaf constant of *Gardenia obtusifolia* (cont.)

Field	Epidermal cell number			Epidermal cell area			Trichome number		
	Source	Source	Source	Source	Source	Source	Source	Source	Source
	1	2	3	1	2	3	1	2	3
1	1316.0	1304.0	1296.0	759.88	766.87	771.60	-	-	-
2	1320.0	1312.0	1324.0	757.58	762.20	755.29	-	-	-
3	1320.0	1340.0	1316.0	757.58	746.27	759.88	-	-	-
4	1380.0	1388.0	1376.0	724.64	720.46	726.74	-	-	-
5	1320.0	1296.0	1324.0	757.58	771.60	755.29	-	-	-
6	1176.0	1200.0	1188.0	850.34	833.33	841.75	-	-	-
7	1328.0	1312.0	1316.0	753.01	762.20	759.88	-	-	-
8	1296.0	1312.0	1288.0	771.60	762.20	776.40	-	-	-
9	1404.0	1372.0	1376.0	712.25	728.86	726.74	-	-	-
10	1208.0	1240.0	1224.0	827.81	806.45	816.99	-	-	-
11	1216.0	1256.0	1232.0	822.37	796.18	811.69	-	-	-
12	1328.0	1292.0	1340.0	753.01	773.99	746.27	-	-	-
13	1284.0	1272.0	1272.0	778.82	786.16	786.16	-	-	-
14	1252.0	1260.0	1248.0	798.72	793.65	801.28	-	-	-
15	1264.0	1256.0	1252.0	791.14	796.18	798.72	-	-	-
16	1264.0	1256.0	1232.0	791.14	796.18	811.69	-	-	-
17	1300.0	1312.0	1328.0	769.23	762.20	753.01	-	-	-
18	1264.0	1256.0	1272.0	791.14	796.18	786.16	-	-	-
19	1336.0	1316.0	1340.0	748.50	759.88	746.27	-	-	-
20	1192.0	1216.0	1204.0	838.93	822.37	830.56	-	-	-
21	1224.0	1232.0	1236.0	816.99	811.69	809.06	-	-	-
22	1192.0	1204.0	1184.0	838.93	830.56	844.59	-	-	-
23	1084.0	1112.0	1200.0	922.51	899.28	833.33	-	-	-
24	1212.0	1204.0	1212.0	825.08	830.56	825.08	-	-	-
25	1212.0	1200.0	1204.0	825.08	833.33	830.56	-	-	-
26	1160.0	1256.0	1184.0	862.07	796.18	844.59	-	-	-
27	1276.0	1268.0	1244.0	783.70	788.64	803.86	-	-	-
28	1184.0	1208.0	1228.0	844.59	827.81	814.33	-	-	-
29	1204.0	1236.0	1216.0	830.56	809.06	822.37	-	-	-
30	1280.0	1240.0	1264.0	781.25	806.45	791.14	-	-	-
Min-Max	1084.00-1404.00			712.25-922.51			-		
Mean±SD	1262.7±61.57			793.8±39.07			-		

Table 24 Leaf constant of *Gardenia jasminoides*

Field	Stomatal number			Stomatal index			Palisaderatio		
	Source	Source	Source	Source	Source	Source	Source	Source	Source
	1	2	3	1	2	3	1	2	3
1	280.0	268.0	240.0	20.89	22.94	18.40	10.38	10.50	10.88
2	276.0	268.0	268.0	20.11	19.64	21.26	10.13	11.13	10.25
3	292.0	324.0	252.0	21.85	23.34	19.68	10.25	10.00	10.00
4	308.0	284.0	304.0	23.40	22.25	23.52	11.25	10.38	10.88
5	256.0	224.0	256.0	20.31	18.41	19.63	10.75	10.50	10.75
6	260.0	304.0	248.0	21.17	22.66	19.87	10.75	10.38	10.63
7	220.0	276.0	264.0	20.99	20.65	19.29	10.63	10.75	10.25
8	216.0	328.0	324.0	20.30	23.83	24.25	11.25	11.50	11.25
9	212.0	368.0	272.0	19.77	22.00	20.98	10.88	11.00	11.13
10	260.0	276.0	276.0	21.17	21.76	23.46	11.00	10.63	11.25
11	268.0	332.0	264.0	21.33	23.44	21.42	10.13	10.50	10.63
12	248.0	292.0	284.0	19.68	22.46	23.43	10.75	11.38	10.25
13	300.0	236.0	224.0	24.35	21.52	14.65	10.63	10.13	10.50
14	268.0	304.0	320.0	21.26	23.10	19.04	10.50	10.38	10.38
15	304.0	268.0	236.0	24.67	20.93	17.87	10.75	11.00	11.00
16	268.0	260.0	256.0	21.26	20.44	18.93	11.25	10.50	11.25
17	272.0	268.0	268.0	21.86	21.75	21.06	10.88	11.25	10.50
18	256.0	304.0	296.0	20.51	22.82	25.60	10.50	10.75	10.25
19	248.0	312.0	272.0	20.46	18.66	21.5	10.25	10.63	10.38
20	304.0	276.0	276.0	22.48	21.83	24.55	11.00	10.13	10.88
21	272.0	300.0	240.0	21.18	22.59	19.23	10.38	10.75	10.75
22	328.0	264.0	304.0	24.47	20.82	23.17	10.50	10.00	10.50
23	300.0	232.0	264.0	22.59	20.00	20.30	10.38	11.00	10.00
24	308.0	272.0	280.0	23.44	21.93	22.36	10.25	10.63	10.63
25	324.0	264.0	316.0	19.23	21.35	23.79	10.13	10.50	10.38
26	332.0	224.0	252.0	24.55	20.89	19.20	10.75	11.25	10.50
27	332.0	332.0	304.0	24.77	24.77	23.10	10.50	10.25	11.63
28	276.0	292.0	272.0	21.63	20.91	20.93	10.38	10.88	10.75
29	292.0	280.0	228.0	20.91	21.47	18.68	11.25	10.88	11.00
30	292.0	276.0	244.0	20.91	21.63	20.19	11.25	10.25	11.50
Min-Max	212-368			14.66-25.61			10.00-11.62		
Mean±SD	277.60±31.28			21.47±1.88			10.67±0.39		

Table 24 Leaf constant of *Gardenia jasminoides* (cont.)

Field	Epidermal cell number			Epidermal cell area			Trichome number		
	Source 1	Source 2	Source 3	Source 1	Source 2	Source 3	Source 1	Source 2	Source 3
1	1080.0	1056.0	1024.0	925.93	946.97	976.56	-	-	-
2	916.0	928.0	944.0	1091.70	1077.59	1059.32	-	-	-
3	884.0	896.0	912.0	1131.22	1116.07	1096.49	-	-	-
4	984.0	996.0	1004.0	1016.26	1004.02	996.02	-	-	-
5	996.0	988.0	1012.0	1004.02	1012.15	988.14	-	-	-
6	1008.0	1000.0	1024.0	992.06	1000.00	976.56	-	-	-
7	988.0	1004.0	912.0	1012.15	996.02	1096.49	-	-	-
8	1116.0	1108.0	1104.0	896.06	902.53	905.80	-	-	-
9	1060.0	1052.0	1072.0	943.40	950.57	932.84	-	-	-
10	1100.0	1108.0	1076.0	909.09	902.53	929.37	-	-	-
11	1056.0	1044.0	1032.0	946.97	957.85	968.99	-	-	-
12	1064.0	1056.0	1084.0	939.85	946.97	922.51	-	-	-
13	1016.0	1024.0	1028.0	984.25	976.56	972.76	-	-	-
14	1000.0	1004.0	1012.0	1000.00	996.02	988.14	-	-	-
15	932.0	1056.0	1048.0	972.96	1046.03	954.85	-	-	-
16	1040.0	1028.0	1016.0	961.54	972.76	984.25	-	-	-
17	1032.0	1020.0	1056.0	968.99	980.39	946.97	-	-	-
18	1044.0	1020.0	1024.0	957.85	980.39	976.56	-	-	-
19	1040.0	1016.0	1024.0	961.54	984.25	976.56	-	-	-
20	1092.0	1112.0	1108.0	915.75	899.28	902.53	-	-	-
21	1096.0	1100.0	1072.0	912.41	909.09	932.84	-	-	-
22	1064.0	1080.0	988.0	937.34	1020.41	912.15	-	-	-
23	1048.0	1060.0	1068.0	954.20	943.40	936.33	-	-	-
24	1052.0	1044.0	1064.0	950.57	957.85	939.85	-	-	-
25	1076.0	1068.0	1052.0	929.37	936.33	950.57	-	-	-
26	1108.0	1104.0	1108.0	902.53	905.80	896.06	-	-	-
27	1068.0	1068.0	1032.0	936.33	936.33	968.99	-	-	-
28	1008.0	1020.0	1036.0	992.06	980.39	965.25	-	-	-
29	1024.0	1008.0	1024.0	976.56	992.06	976.56	-	-	-
30	1080.0	1044.0	996.0	1020.41	959.32	1004.02	-	-	-
Min-Max	884.00-1116.00			896.06-1131.22			-		
Mean±SD	1028.2±53.63			975.2±52.87			-		

Table 25 Leaf constant of *Gardenia vietnamensis*

Field	Stomatal number			Stomatal index			Palisaderatio		
	Source 1	Source 2	Source 3	Source 1	Source 2	Source 3	Source 1	Source 2	Source 3
1	240.0	232.0	236.0	21.20	18.29	18.97	14.00	13.38	13.38
2	292.0	264.0	264.0	21.66	21.42	23.74	13.13	13.00	12.63
3	280.0	232.0	228.0	21.27	17.36	17.11	13.75	13.13	13.75
4	276.0	220.0	216.0	21.49	17.91	18.24	14.00	14.25	14.38
5	292.0	264.0	244.0	22.53	19.29	18.10	13.25	13.75	13.50
6	276.0	260.0	252.0	22.18	18.84	18.36	13.63	13.63	13.13
7	268.0	292.0	224.0	24.45	22.39	18.18	13.50	13.13	12.75
8	284.0	312.0	260.0	25.08	23.35	20.24	13.13	12.50	13.38
9	248.0	256.0	284.0	22.30	21.54	22.25	13.00	13.25	13.25
10	260.0	240.0	252.0	21.12	20.54	19.93	14.00	13.38	14.13
11	264.0	288.0	276.0	21.08	22.71	22.11	13.50	14.00	12.63
12	268.0	268.0	308.0	20.93	21.61	22.64	13.13	13.88	13.00
13	224.0	260.0	272.0	19.37	21.24	20.48	13.25	13.50	12.50
14	232.0	292.0	264.0	18.95	23.17	20.68	13.00	13.13	12.75
15	236.0	276.0	276.0	20.27	20.78	21.29	13.63	13.00	13.38
16	264.0	284.0	248.0	21.01	17.27	21.01	13.13	12.63	13.50
17	276.0	228.0	292.0	22.11	17.75	22.46	13.00	12.75	14.00
18	256.0	272.0	240.0	20.51	21.25	18.80	13.25	13.38	13.00
19	296.0	268.0	228.0	23.49	20.67	18.21	12.88	14.00	12.88
20	280.0	248.0	260.0	21.02	19.80	23.89	12.50	13.63	13.25
21	304.0	268.0	268.0	23.03	20.93	21.47	13.25	13.75	13.13
22	216.0	224.0	236.0	17.58	18.00	18.67	13.50	13.00	13.75
23	244.0	256.0	292.0	19.18	20.25	22.53	13.38	13.13	14.63
24	220.0	264.0	260.0	17.95	20.62	20.37	12.88	13.50	13.50
25	252.0	276.0	276.0	15.63	21.83	22.18	13.25	13.38	13.13
26	272.0	236.0	264.0	21.05	19.21	21.01	12.88	13.25	12.63
27	284.0	264.0	232.0	21.98	21.01	19.39	13.00	13.88	13.25
28	288.0	260.0	272.0	20.45	23.89	21.51	13.75	12.50	13.63
29	300.0	244.0	256.0	21.36	19.74	21.62	12.88	12.13	13.88
30	300.0	264.0	272.0	21.36	23.74	21.58	13.13	13.25	13.38
Min-Max	216-312			15.63-25.09			12.12-14.62		
Mean±SD	261.73±23.08			20.73±1.88			13.30±0.46		

Table 25 Leaf constant of *Gardenia vietnamensis* (cont.)

Field	Epidermal cell number			Epidermal cell area			Trichome number		
	Source	Source	Source	Source	Source	Source	Source	Source	Source
	1	2	3	1	2	3	1	2	3
1	760.0	728.0	696.0	1315.79	1373.63	1436.78	-	-	-
2	736.0	724.0	700.0	1358.70	1381.22	1428.57	-	-	-
3	740.0	716.0	708.0	1351.35	1396.65	1412.43	-	-	-
4	704.0	716.0	712.0	1420.45	1396.65	1404.49	-	-	-
5	728.0	720.0	760.0	1373.63	1388.89	1315.79	-	-	-
6	720.0	704.0	720.0	1388.89	1420.45	1388.89	-	-	-
7	684.0	696.0	696.0	1461.99	1436.78	1436.78	-	-	-
8	700.0	708.0	712.0	1428.57	1412.43	1404.49	-	-	-
9	716.0	740.0	756.0	1396.65	1351.35	1322.75	-	-	-
10	696.0	712.0	704.0	1436.78	1404.49	1420.45	-	-	-
11	672.0	680.0	688.0	1488.10	1470.59	1453.49	-	-	-
12	772.0	716.0	712.0	1295.34	1396.65	1404.49	-	-	-
13	660.0	676.0	668.0	1515.15	1479.29	1497.01	-	-	-
14	744.0	712.0	760.0	1344.09	1404.49	1315.79	-	-	-
15	732.0	764.0	728.0	1366.12	1308.90	1373.63	-	-	-
16	724.0	704.0	716.0	1381.22	1420.45	1396.65	-	-	-
17	668.0	684.0	680.0	1497.01	1461.99	1470.59	-	-	-
18	676.0	684.0	692.0	1479.29	1461.99	1445.09	-	-	-
19	752.0	744.0	732.0	1329.79	1344.09	1366.12	-	-	-
20	692.0	704.0	708.0	1445.09	1420.45	1412.43	-	-	-
21	772.0	744.0	712.0	1295.34	1344.09	1404.49	-	-	-
22	704.0	732.0	716.0	1420.45	1366.12	1396.65	-	-	-
23	652.0	656.0	668.0	1533.74	1524.39	1497.01	-	-	-
24	720.0	712.0	712.0	1388.89	1404.49	1404.49	-	-	-
25	752.0	764.0	744.0	1329.79	1308.90	1344.09	-	-	-
26	700.0	708.0	752.0	1428.57	1412.43	1329.79	-	-	-
27	656.0	688.0	696.0	1524.39	1453.49	1436.78	-	-	-
28	716.0	720.0	716.0	1396.65	1388.89	1396.65	-	-	-
29	704.0	716.0	704.0	1420.45	1396.65	1420.45	-	-	-
30	764.0	764.0	744.0	1308.90	1308.90	1344.09	-	-	-
Min-Max	652.00-772.00			1295.34-1533.74			-		
Mean±SD	714.0±28.54			1402.7±56.17			-		




Table 26 Leaf constant of *Gardenia sootepensis*

Field	Stomatal number			Stomatal index			Palisade ratio		
	Source 1	Source 2	Source 3	Source 1	Source 2	Source 3	Source 1	Source 2	Source 3
1	448.0	392.0	420.0	26.92	24.81	26.99	19.50	18.13	19.13
2	420.0	396.0	392.0	25.92	26.04	25.45	17.75	17.25	18.00
3	408.0	392.0	404.0	25.62	26.84	26.64	20.50	18.75	17.38
4	392.0	380.0	428.0	25.65	25.50	26.61	18.63	18.13	18.63
5	416.0	408.0	400.0	27.22	26.47	25.57	21.00	19.00	17.50
6	404.0	420.0	392.0	25.56	25.65	25.58	18.00	18.63	19.38
7	388.0	412.0	440.0	25.39	24.93	27.91	18.38	18.50	20.63
8	440.0	388.0	436.0	26.82	26.57	27.45	18.13	18.88	20.75
9	416.0	392.0	404.0	27.65	25.83	26.50	17.88	18.38	18.50
10	404.0	372.0	376.0	26.23	26.07	26.25	19.00	18.50	19.50
11	444.0	404.0	388.0	26.94	27.75	26.50	18.13	18.88	18.75
12	424.0	400.0	384.0	26.43	25.38	25.87	18.50	17.75	18.50
13	400.0	412.0	396.0	25.12	26.57	25.51	19.00	18.38	19.13
14	372.0	404.0	408.0	24.86	26.64	27.27	18.63	18.75	18.63
15	412.0	416.0	408.0	26.61	25.66	25.37	18.50	18.25	18.00
16	408.0	440.0	408.0	25.56	26.42	26.42	18.63	20.38	17.88
17	416.0	436.0	380.0	27.15	25.58	25.74	18.50	17.63	18.25
18	392.0	428.0	412.0	25.32	25.87	26.82	19.50	19.13	18.25
19	396.0	408.0	372.0	26.90	26.54	25.54	18.50	20.00	18.38
20	388.0	404.0	392.0	24.93	25.72	26.06	19.00	19.75	18.75
21	408.0	400.0	408.0	25.31	25.81	26.35	19.38	18.75	18.88
22	400.0	384.0	416.0	25.06	26.78	27.01	19.50	19.75	20.50
23	396.0	376.0	380.0	25.64	26.64	25.06	20.00	18.88	19.88
24	408.0	380.0	412.0	26.70	26.42	25.49	19.00	19.50	16.63
25	388.0	388.0	400.0	25.00	25.56	25.25	18.13	20.13	19.13
26	380.0	384.0	412.0	25.06	25.25	25.30	21.00	18.75	18.63
27	372.0	372.0	404.0	25.06	24.81	25.89	18.50	19.13	18.75
28	356.0	408.0	388.0	26.02	26.28	25.79	20.13	18.75	18.25
29	408.0	412.0	372.0	26.63	26.24	25.54	17.88	17.00	18.63
30	388.0	408.0	384.0	25.19	25.65	25.06	17.50	19.50	19.50
Min-Max	356-448			24.81-27.92			16.62-21.00		
Mean±SD	403.47±17.79			26.02±0.74			18.80±0.88		

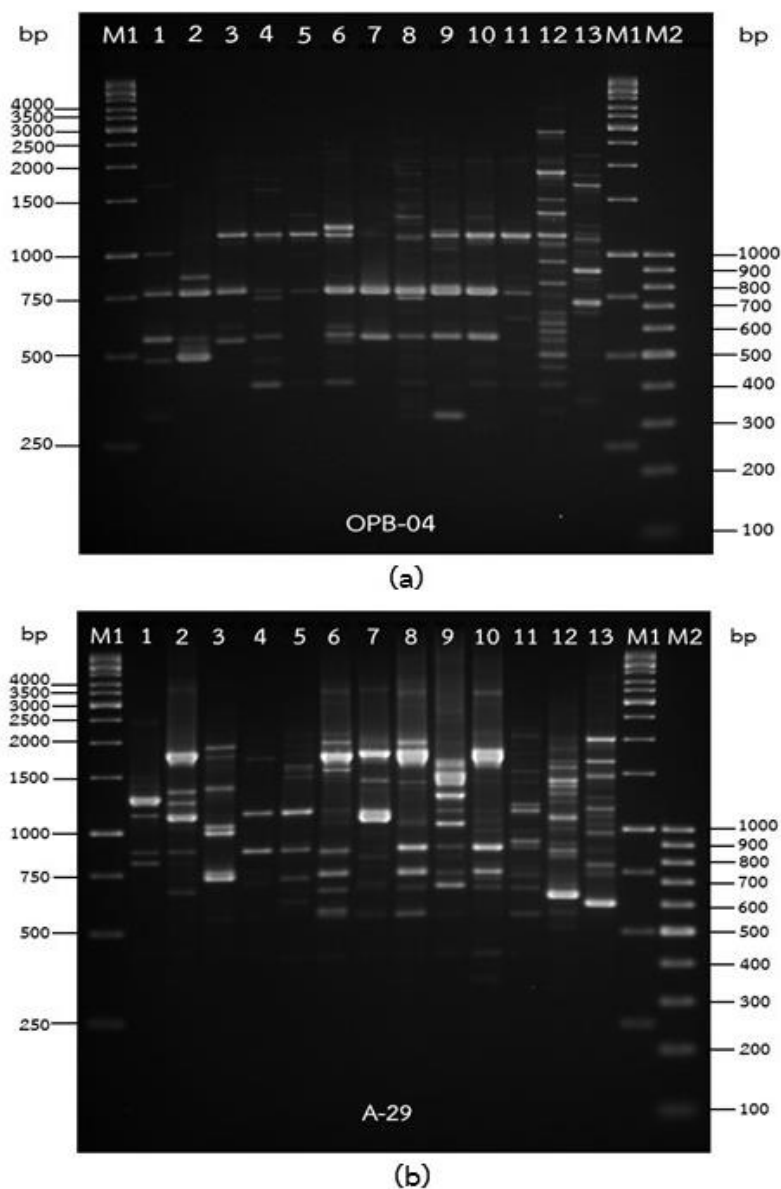
Table 26 Leaf constant of *Gardenia sootepensis* (cont.)

Field	Epidermal cell number			Epidermal cell area			Trichome number		
	Source 1	Source 2	Source 3	Source 1	Source 2	Source 3	Source 1	Source 2	Source 3
1	888.0	876.0	872.0	1126.13	1141.55	976.56	16.00	12.00	16.00
2	876.0	864.0	892.0	1141.55	1157.41	1059.32	28.00	24.00	20.00
3	904.0	888.0	892.0	1106.19	1126.13	1096.49	28.00	20.00	20.00
4	856.0	868.0	872.0	1168.22	1152.07	996.02	12.00	24.00	16.00
5	904.0	892.0	916.0	1106.19	1121.08	988.14	12.00	16.00	12.00
6	884.0	896.0	872.0	1131.22	1116.07	976.56	16.00	16.00	16.00
7	896.0	888.0	908.0	1116.07	1126.13	1096.49	20.00	16.00	24.00
8	924.0	912.0	900.0	1082.25	1096.49	905.80	16.00	16.00	20.00
9	880.0	888.0	900.0	1136.36	1126.13	932.84	12.00	16.00	16.00
10	920.0	908.0	896.0	1086.96	1101.32	929.37	20.00	16.00	16.00
11	876.0	888.0	888.0	1141.55	1126.13	968.99	16.00	24.00	20.00
12	852.0	864.0	840.0	1173.71	1157.41	922.51	20.00	16.00	16.00
13	848.0	864.0	864.0	1179.25	1157.41	972.76	16.00	12.00	12.00
14	848.0	888.0	872.0	1179.25	1126.13	988.14	16.00	20.00	20.00
15	804.0	844.0	820.0	1243.78	1184.83	1054.85	16.00	16.00	24.00
16	836.0	852.0	824.0	1196.17	1173.71	984.25	28.00	20.00	20.00
17	916.0	924.0	900.0	1091.70	1082.25	946.97	16.00	20.00	20.00
18	880.0	872.0	864.0	1136.36	1146.79	976.56	20.00	16.00	16.00
19	936.0	920.0	924.0	1068.38	1086.96	976.56	16.00	16.00	16.00
20	924.0	904.0	912.0	1082.25	1106.19	902.53	16.00	20.00	24.00
21	888.0	900.0	900.0	1126.13	1111.11	932.84	16.00	20.00	28.00
22	860.0	876.0	836.0	1162.79	1141.55	1012.15	16.00	20.00	20.00
23	908.0	900.0	872.0	1101.32	1111.11	936.33	16.00	24.00	16.00
24	916.0	916.0	912.0	1091.70	1091.70	939.85	24.00	16.00	16.00
25	900.0	904.0	904.0	1111.11	1106.19	950.57	16.00	16.00	16.00
26	912.0	908.0	912.0	1096.49	1101.32	902.53	16.00	16.00	16.00
27	892.0	900.0	904.0	1121.08	1111.11	968.99	16.00	20.00	20.00
28	936.0	928.0	916.0	1068.38	1077.59	965.25	16.00	20.00	16.00
29	856.0	884.0	868.0	1168.22	1131.22	976.56	20.00	16.00	16.00
30	868.0	896.0	884.0	1152.07	1116.07	1004.02	16.00	16.00	16.00
Min-Max	804.00-936.00			902.53-1243.78			12-28		
Mean±SD	887.1±27.06			1076.1±82.61			17.95±3.71		

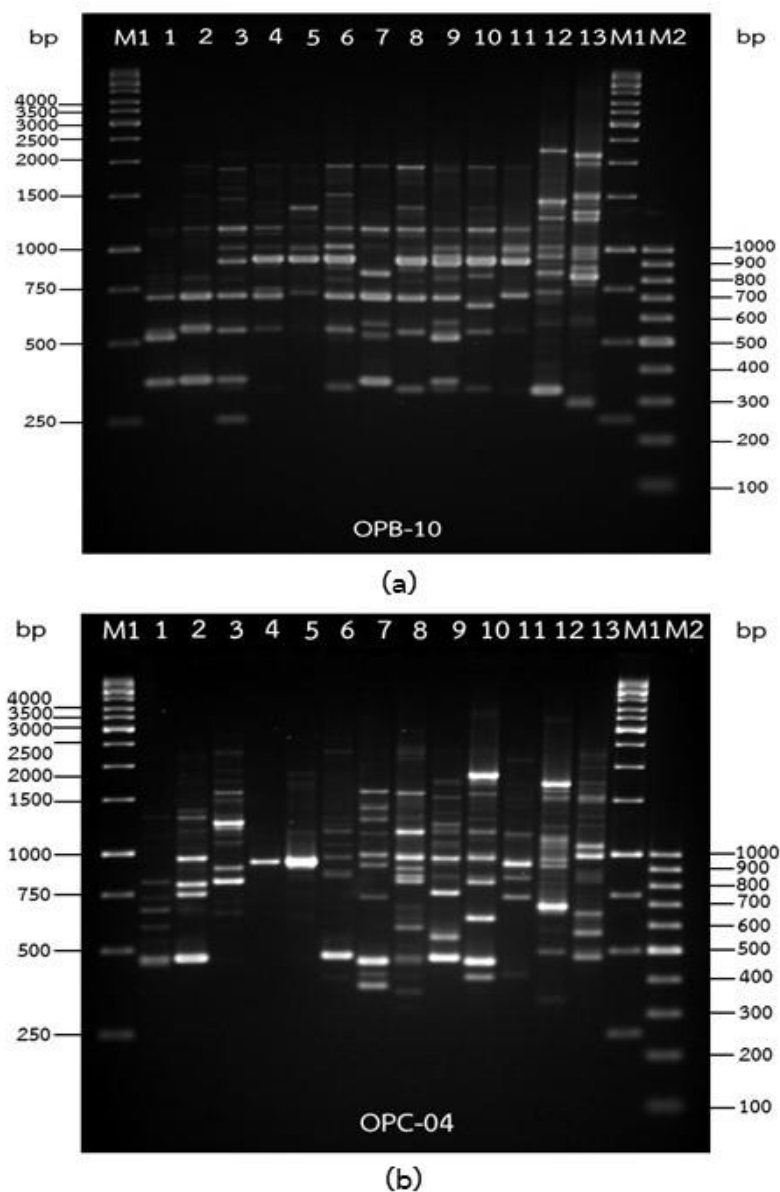


APPENDIX B  
RAPD fingerprint of eleven *Gardenia* species

จุฬาลงกรณ์มหาวิทยาลัย  
CHULALONGKORN UNIVERSITY



**Figure 47** RAPD fingerprints of 11 *Gardenia* species obtained from OPB-04 (a), and A-29 primers (b). M1 and M2: 1 kb and 100 bp molecular weight marker respectively, lane1= *G. carinata*, lane2= *G. collinsae*, lane3= *G. griffithii*, lane4= *G. jasminoides*, lane5= *G. lineate*, lane6= *G. tubifera*, lane7= *G. obtusifolia*, lane8= *G. sootepensis*, lane9= *G. taitensis*, lane10= *G. thailandica*, lane11= *G. vietnamensis*, lane12= *Ixora finlaysoniana*, lane13= *Cassia timoriensis*.



**Figure 48** RAPD fingerprints of 11 *Gardenia* species obtained from OPB-10 (a), and OPC-04 primers (b). M1 and M2: 1 kb and 100 bp molecular weight marker respectively, lane1= *G. carinata*, lane2= *G. collinsae*, lane3= *G. griffithii*, lane4= *G. jasminoides*, lane5= *G. lineate*, lane6= *G. tubifera*, lane7= *G. obtusifolia*, lane8= *G. sootepensis*, lane9= *G. taitensis*, lane10= *G. thailandica*, lane11= *G. vietnamensis*, lane12= *Ixora finlaysoniana*, lane13= *Cassia timoriensis*.

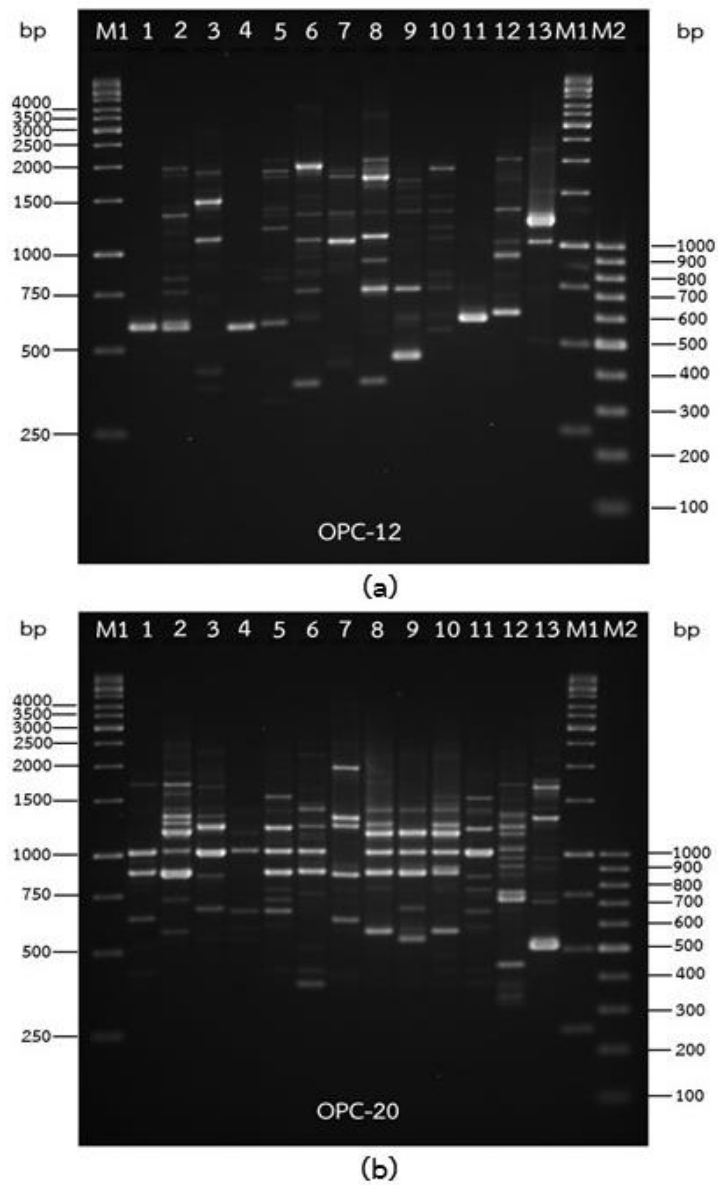


(a)

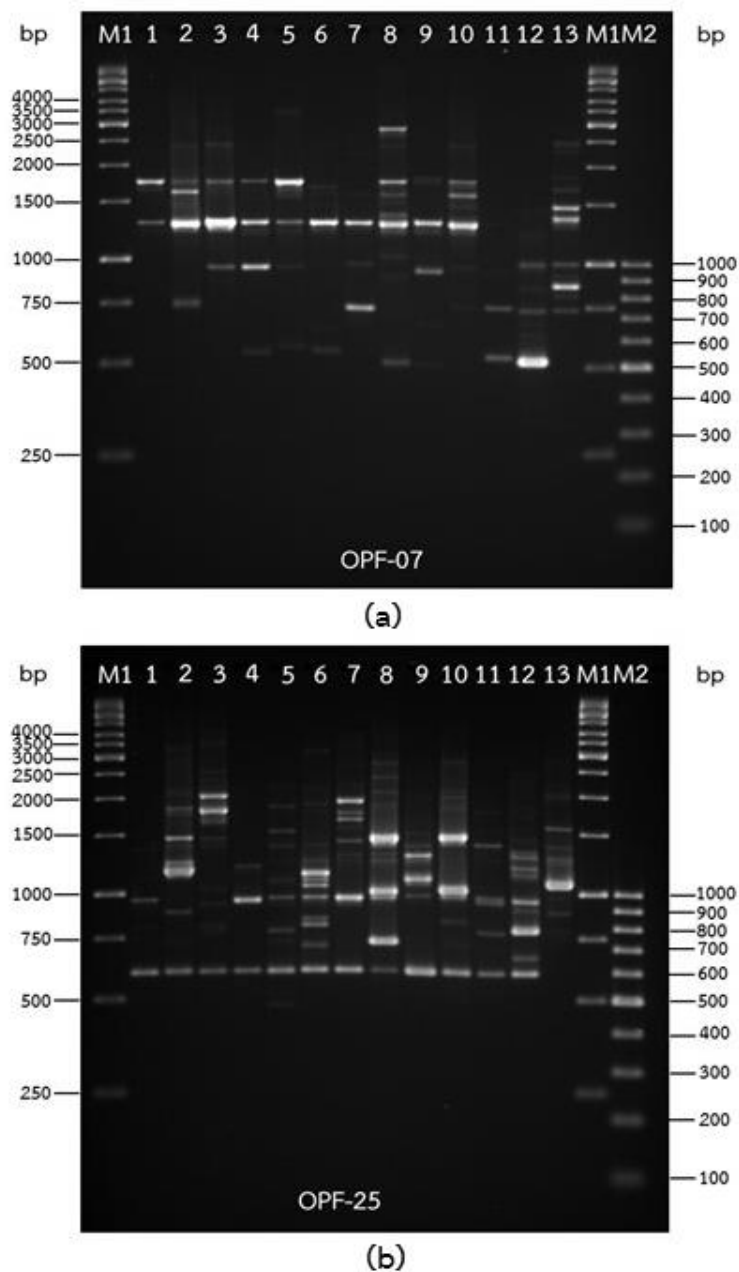


(b)

**Figure 49** RAPD fingerprints of 11 *Gardenia* species obtained from OPC-06 (a), and OPC-08 primers (b). M1 and M2: 1 kb and 100 bp molecular weight marker respectively, lane1= *G. carinata*, lane2= *G. collinsae*, lane3= *G. griffithii*, lane4= *G. jasminoides*, lane5= *G. lineate*, lane6= *G. tubifera*, lane7= *G. obtusifolia*, lane8= *G. sootepensis*, lane9= *G. taitensis*, lane10= *G. thailandica*, lane11= *G. vietnamensis*, lane12= *Ixora finlaysoniana*, lane13= *Cassia timoriensis*.

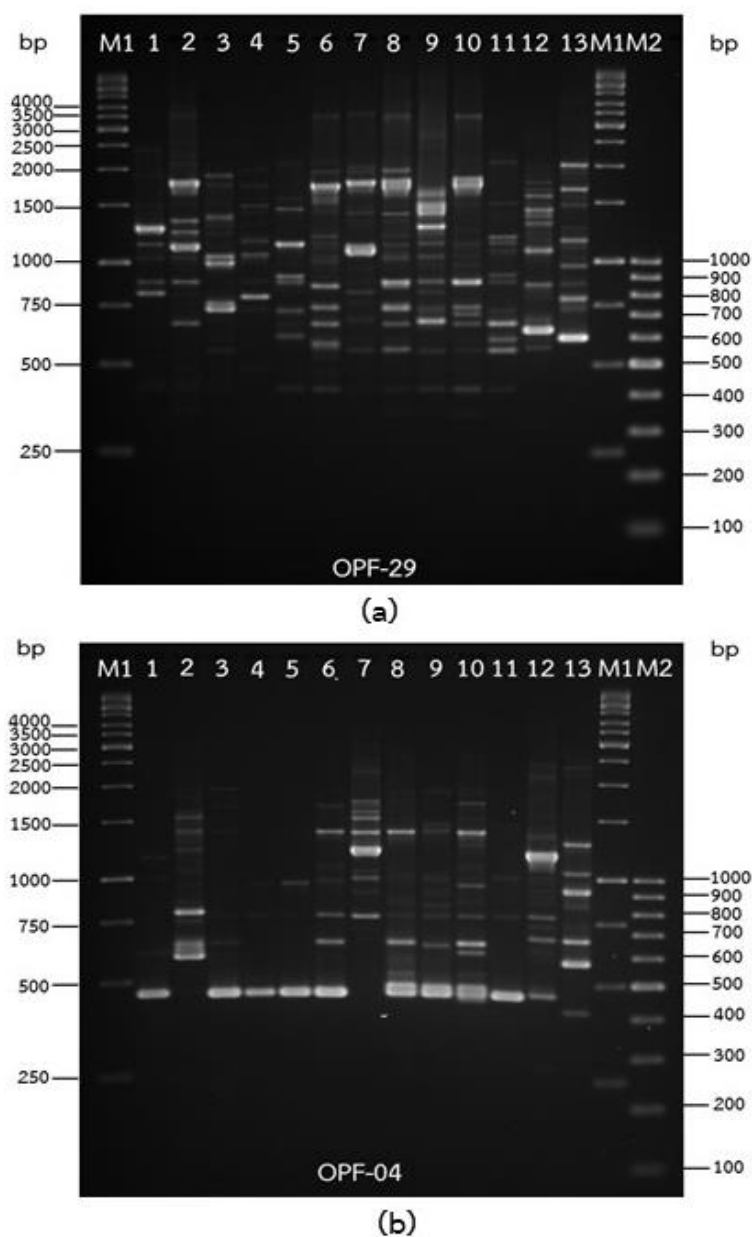


**Figure 50** RAPD fingerprints of 11 *Gardenia* species obtained from OPC-12 (a), and OPC-20 primers (b). M1 and M2: 1 kb and 100 bp molecular weight marker respectively, lane1= *G. carinata*, lane2= *G. collinsae*, lane3= *G. griffithii*, lane4= *G. jasminoides*, lane5= *G. lineate*, lane6= *G. tubifera*, lane7= *G. obtusifolia*, lane8= *G. sootepensis*, lane9= *G. taitensis*, lane10= *G. thailandica*, lane11= *G. vietnamensis*, lane12= *Ixora finlaysoniana*, lane13= *Cassia timoriensis*.

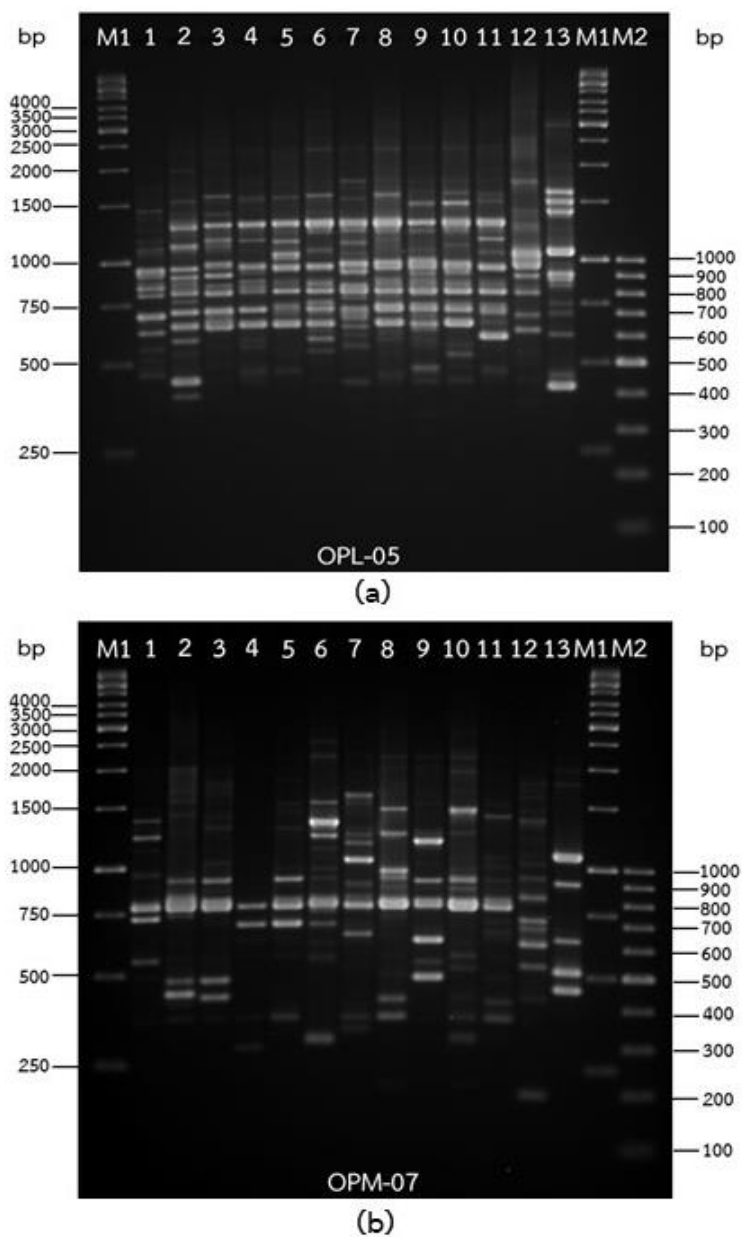


**Figure 51** RAPD fingerprints of 11 *Gardenia* species obtained from OPF-07 (a), and OPF-25 primers (b). M1 and M2: 1 kb and 100 bp molecular weight marker respectively, lane1= *G. carinata*, lane2= *G. collinsae*, lane3= *G. griffithii*, lane4= *G. jasminoides*, lane5= *G. lineate*, lane6= *G. tubifera*, lane7= *G. obtusifolia*, lane8= *G. sootepensis*, lane9= *G. taitensis*, lane10= *G. thailandica*, lane11= *G. vietnamensis*, lane12= *Ixora finlaysoniana*, lane13= *Cassia timoriensis*.

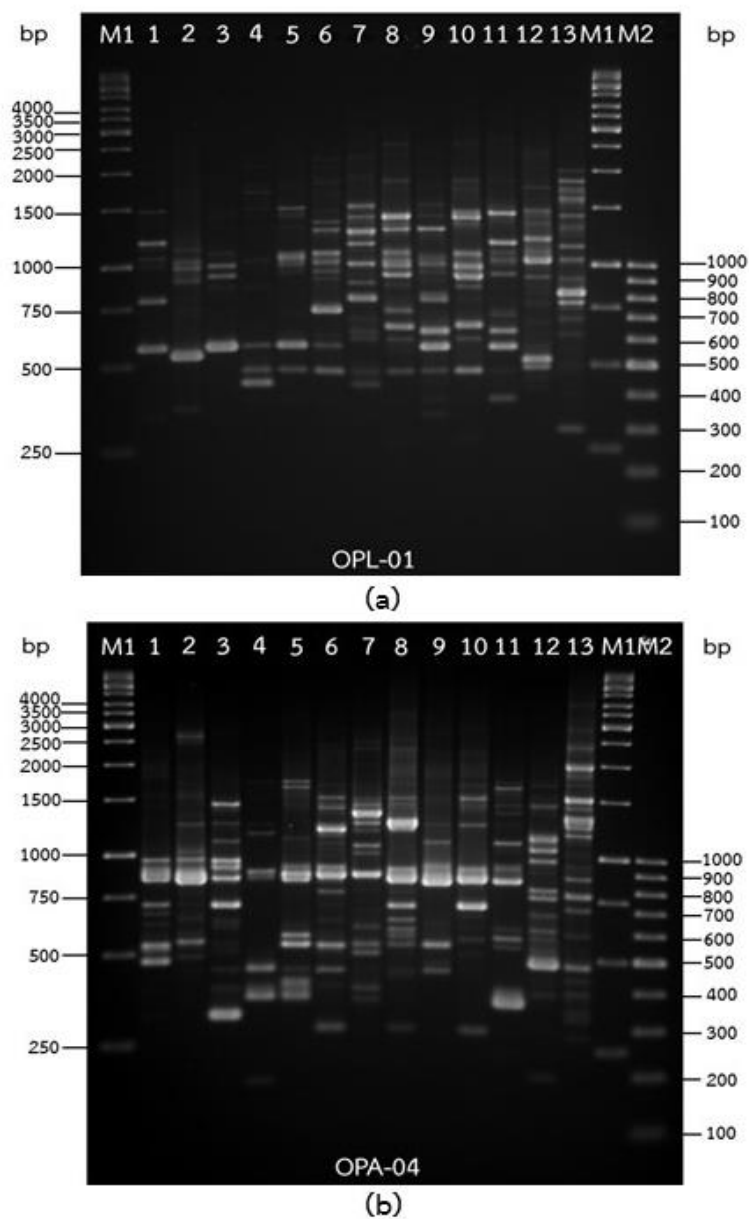




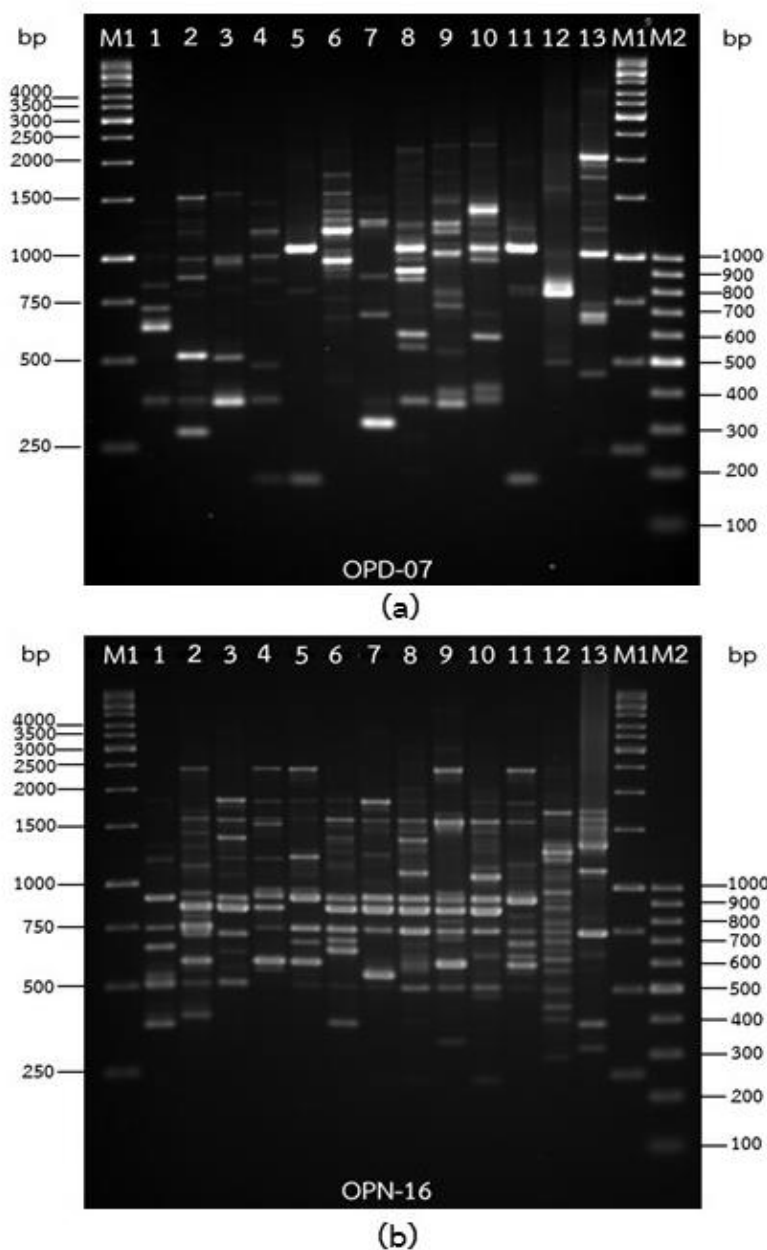
**Figure 52** RAPD fingerprints of 11 *Gardenia* species obtained from OPF-29 (a), and OPF-04 primers (b). M1 and M2: 1 kb and 100 bp molecular weight marker respectively, lane1= *G. carinata*, lane2= *G. collinsae*, lane3= *G. griffithii*, lane4= *G. jasminoides*, lane5= *G. lineate*, lane6= *G. tubifera*, lane7= *G. obtusifolia*, lane8= *G. sootepensis*, lane9= *G. taitensis*, lane10= *G. thailandica*, lane11= *G. vietnamensis*, lane12= *Ixora finlaysoniana*, lane13= *Cassia timoriensis*.



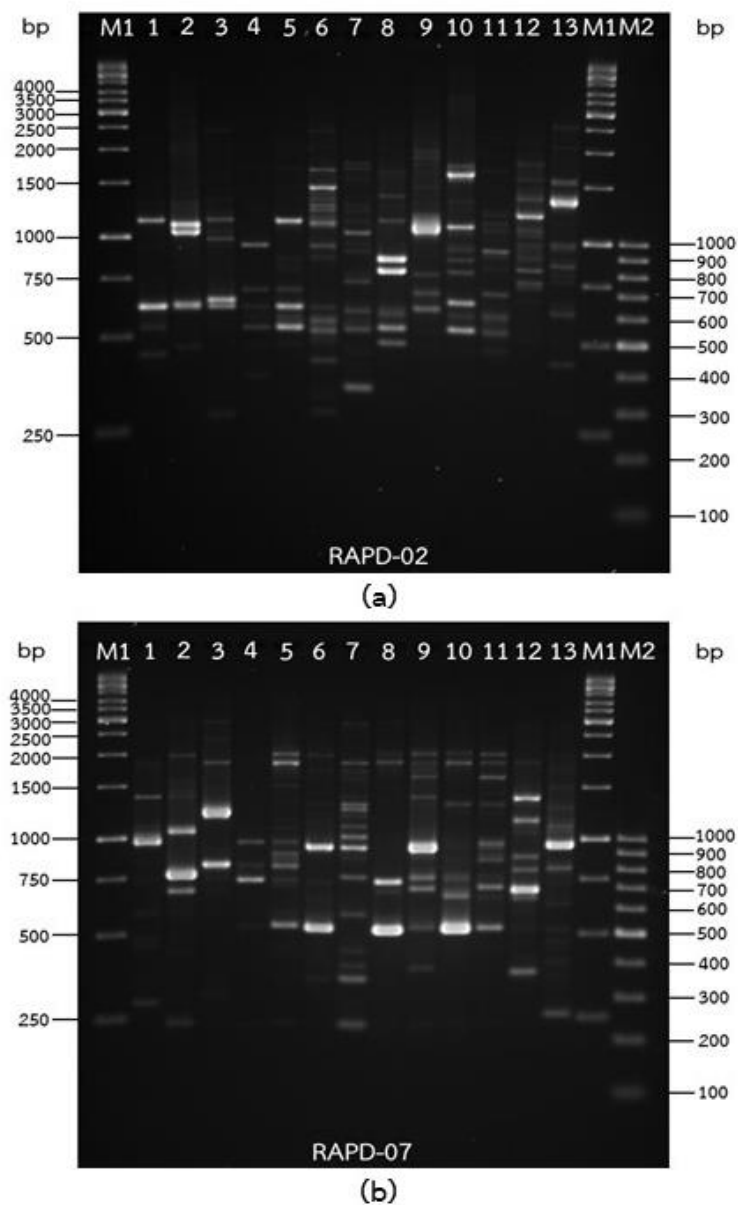
**Figure 53** RAPD fingerprints of 11 *Gardenia* species obtained from OPL-05 (a), and OPM-07 primers (b). M1 and M2: 1 kb and 100 bp molecular weight marker respectively, lane1= *G. carinata*, lane2= *G. collinsae*, lane3= *G. griffithii*, lane4= *G. jasminoides*, lane5= *G. lineate*, lane6= *G. tubifera*, lane7= *G. obtusifolia*, lane8= *G. sootepensis*, lane9= *G. taitensis*, lane10= *G. thailandica*, lane11= *G. vietnamensis*, lane12= *Ixora finlaysoniana*, lane13= *Cassia timoriensis*.



**Figure 54** RAPD fingerprints of 11 *Gardenia* species obtained from OPL-01 (a), and OPA-04 primers (b). M1 and M2: 1 kb and 100 bp molecular weight marker respectively, lane1= *G. carinata*, lane2= *G. collinsae*, lane3= *G. griffithii*, lane4= *G. jasminoides*, lane5= *G. lineate*, lane6= *G. tubifera*, lane7= *G. obtusifolia*, lane8= *G. sootepensis*, lane9= *G. taitensis*, lane10= *G. thailandica*, lane11= *G. vietnamensis*, lane12= *Ixora finlaysoniana*, lane13= *Cassia timoriensis*.



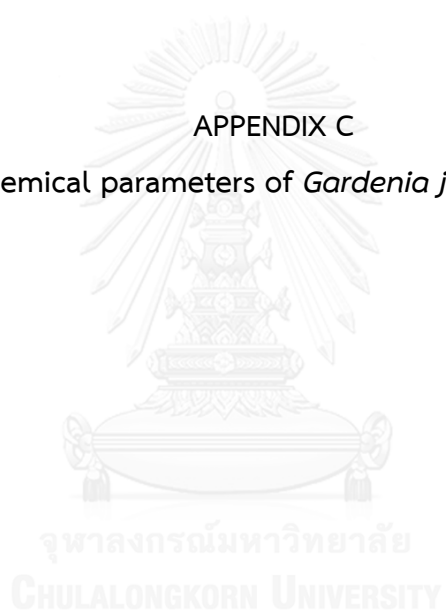
**Figure 55** RAPD fingerprints of 11 *Gardenia* species obtained from OPD-07 (a), and OPN-16 primers (b). M1 and M2: 1 kb and 100 bp molecular weight marker respectively, lane1= *G. carinata*, lane2= *G. collinsae*, lane3= *G. griffithii*, lane4= *G. jasminoides*, lane5= *G. lineate*, lane6= *G. tubifera*, lane7= *G. obtusifolia*, lane8= *G. sootepensis*, lane9= *G. taitensis*, lane10= *G. thailandica*, lane11= *G. vietnamensis*, lane12= *Ixora finlaysoniana*, lane13= *Cassia timoriensis*.



**Figure 56** RAPD fingerprints of 11 *Gardenia* species obtained from RAPD-02 (a), and RAPD-07 primers (b). M1 and M2: 1 kb and 100 bp molecular weight marker respectively, lane1= *G. carinata*, lane2= *G. collinsae*, lane3= *G. griffithii*, lane4= *G. jasminoides*, lane5= *G. lineate*, lane6= *G. tubifera*, lane7= *G. obtusifolia*, lane8= *G. sootepensis*, lane9= *G. taitensis*, lane10= *G. thailandica*, lane11= *G. vietnamensis*, lane12= *Ixora finlaysoniana*, lane13= *Cassia timoriensis*.

APPENDIX C

Physicochemical parameters of *Gardenia jasminoides* fruits



**Table 27** Physicochemical parameters of *Gardenia jasminoides* fruits

Sources	No.	Moisture content	Loss on drying	Ash value		Extractive value	
				Total ash	Acid insoluble ash	Water	Ethanol
1. Chiang Mai	1	11.58	10.36	5.05	0.72	27.96	21.42
	2	11.58	10.37	4.99	0.66	28.08	21.17
	3	11.69	10.38	5.09	0.66	27.99	21.12
2. Nakhon Pathom	1	10.78	9.27	4.67	0.81	29.79	24.28
	2	10.89	9.22	4.72	0.83	29.27	24.48
	3	10.79	9.34	4.73	0.80	29.68	24.06
3. Surat Thanee	1	11.99	10.02	4.76	0.63	28.18	22.59
	2	11.79	10.07	4.75	0.60	28.77	22.70
	3	11.89	9.99	4.78	0.68	28.69	22.78
4. Ubon Ratchathani	1	10.29	9.66	4.92	0.89	28.37	22.79
	2	10.18	9.64	4.94	0.91	28.27	22.66
	3	10.19	9.72	4.92	0.82	28.45	22.53
5. Rayong	1	10.29	8.04	4.83	0.61	27.92	24.27
	2	10.29	8.12	4.87	0.60	28.14	24.31
	3	10.20	8.07	4.89	0.53	28.01	24.41
6. Uthai Thanee	1	10.18	8.43	4.79	0.89	25.08	24.28
	2	10.29	8.45	4.80	0.91	25.72	23.83
	3	10.19	8.46	4.79	0.85	24.72	23.49

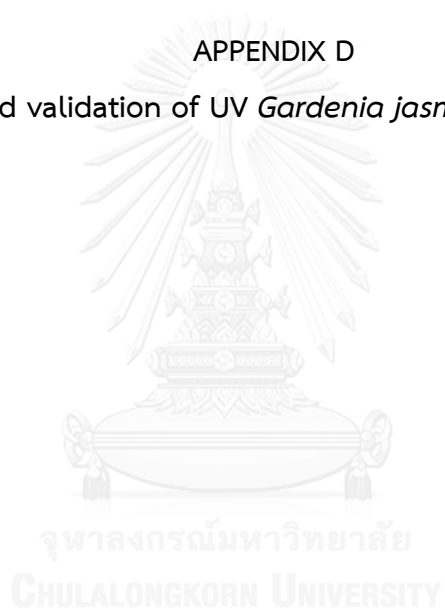
Table 27 Physicochemical parameters of *Gardenia jasminoides* fruits (cont.)

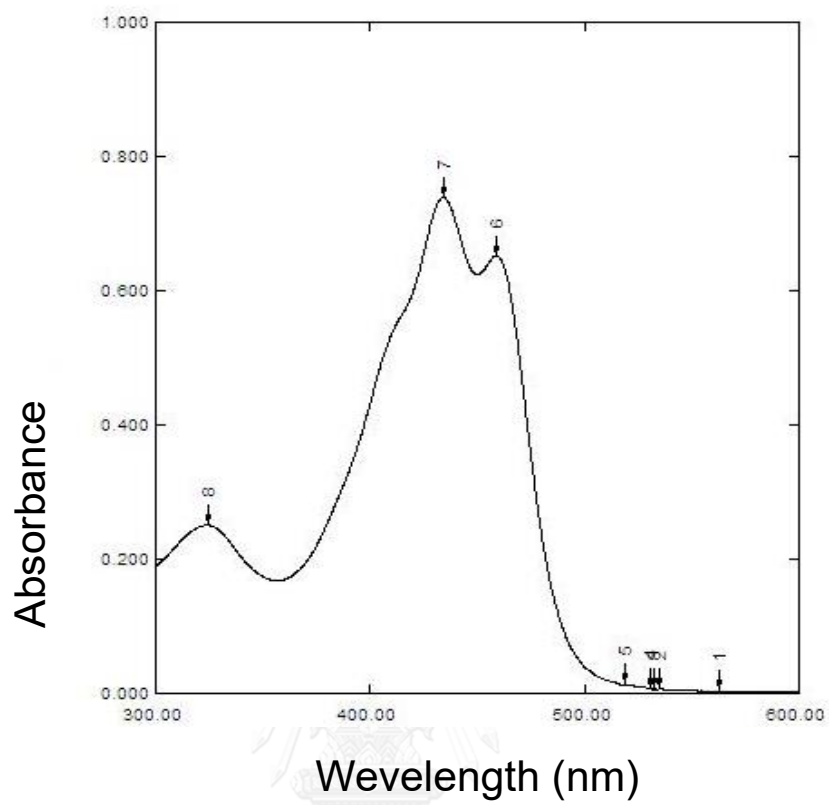
Sources	No.	Moisture content	Loss on drying	Ash value		Extractive value	
				Total ash	Acid insoluble ash	Water	Ethanol
7. Bangkok1	1	9.69	9.63	4.98	0.89	28.63	21.77
	2	9.59	9.56	4.95	0.86	28.69	22.05
	3	9.58	9.66	4.95	0.91	28.32	22.03
8. Bangkok2	1	9.09	9.63	4.96	0.81	25.08	24.28
	2	9.19	9.67	4.93	0.78	25.72	23.83
	3	9.19	9.53	4.94	0.80	24.72	23.49
9. Bangkok3	1	8.59	8.19	5.12	0.69	27.92	24.27
	2	8.69	8.22	5.05	0.61	28.14	24.31
	3	8.59	8.16	5.10	0.61	28.01	24.41
10. Lampang	1	9.89	7.68	5.02	0.57	21.16	19.75
	2	9.89	7.68	5.15	0.56	21.60	19.99
	3	9.99	7.65	5.03	0.53	21.67	19.74
11. Chumporn	1	10.38	9.02	4.74	0.54	23.39	19.87
	2	10.29	8.92	4.79	0.56	23.95	19.75
	3	10.29	8.92	4.80	0.55	23.34	19.77
12. Nakhon Phanom	1	7.69	6.40	5.22	0.68	28.37	21.50
	2	7.79	6.28	5.23	0.63	28.43	21.51
	3	7.79	6.19	5.28	0.69	28.48	21.55
Min-Max		7.69- 11.99	6.19- 10.38	4.67- 5.28	0.53- 0.91	21.16- 29.79	19.74- 24.48
Grand mean ±pooled SD		10.04± 0.06	8.85± 1.13	4.93± 0.16	0.71± 0.13	26.91± 2.41	22.53± 1.64



APPENDIX D

Method validation of UV *Gardenia jasminoides* fruits



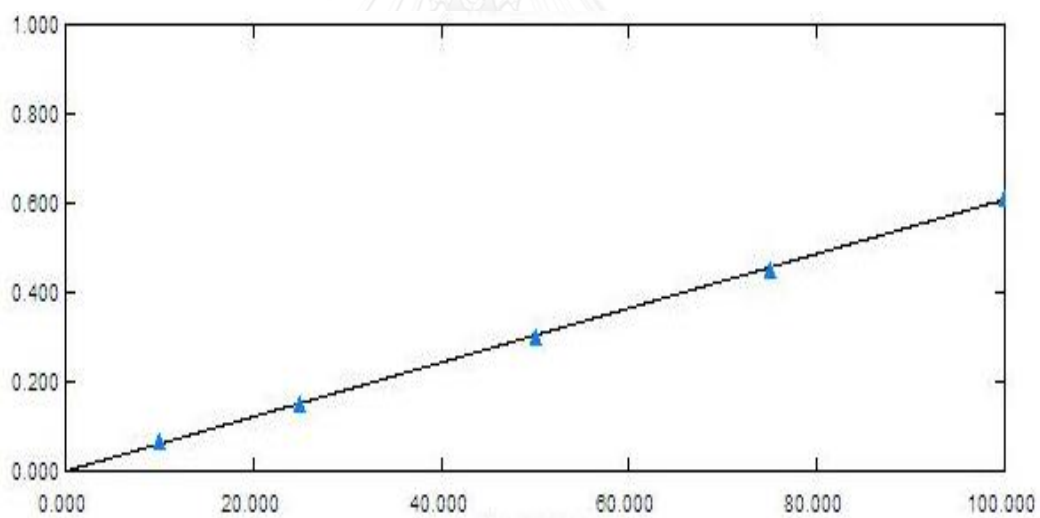


จุฬาลงกรณ์มหาวิทยาลัย  
CHULALONGKORN UNIVERSITY

Figure 57 UV Spectrum of standard crocin in methanol

**Table 28** Calibration curve data for crocin

Sr. No.	Concentration ( $\mu\text{g/ml}$ )	Absorbance at 434 nm
1	5	0.037
2	25	0.120
3	50	0.326
4	75	0.496
5	100	0.673

**Figure 58** Calibration curve of standard crocin in methanol at 434 nm (5-100  $\mu\text{g/ml}$ )

**Table 29** Results of recovery studies

No.	Crocin sample ( $\mu\text{g/ml}$ )	Std. crocin added ( $\mu\text{g/ml}$ )	Total crocin found ( $\mu\text{g/ml}$ )	%Mean recovery
1	13.50	20	32.43	99.61
2			34.71	
3			33.13	
1	13.50	40	47.43	83.75
2			47.00	
3			46.57	
1	13.50	60	64.86	85.51
2			65.57	
3			64.00	

Table 30 Results of repeatability study

Crocin sample ( $\mu\text{g/ml}$ )	Std. crocin added ( $\mu\text{g/ml}$ )	Total crocin found ( $\mu\text{g/ml}$ )	%RSD
13.50	20	32.43	0.07
		34.71	
		33.13	
13.50	40	47.43	0.58
		47.00	
		46.57	
13.50	60	64.86	2.25
		65.57	
		64.00	

Table 31 Results of intermediate precision

Crocin sample ( $\mu\text{g/ml}$ )	Std. crocin added ( $\mu\text{g/ml}$ )	Day 1		Day 2		Day 3	
		Total crocin found ( $\mu\text{g/ml}$ )	%RSD	Total crocin found ( $\mu\text{g/ml}$ )	%RSD	Total crocin found ( $\mu\text{g/ml}$ )	%RSD
13.50	20	36.72	0.07	33.00	0.92	32.43	3.50
		36.72		33.61		34.71	
		36.68		33.21		33.13	
13.50	40	49.06	0.58	55.26	1.15	47.43	0.72
		48.53		54.38		47.00	
		48.63		55.62		46.57	
13.50	60	61.92	2.25	64.12	1.73	64.86	1.21
		63.04		64.99		65.57	
		60.27		66.36		64.00	

Table 32 Result of robustness study

No.	Wevelength	Crocin sample ( $\mu\text{g/ml}$ )	Std. crocin added ( $\mu\text{g/ml}$ )	Total crocin found ( $\mu\text{g/ml}$ )	%RSD
1	433	13.50	30	44.32	1.57
2				43.01	
3				43.25	
4				44.76	
5				43.22	
6				43.91	
1	434	13.50	30	43.56	1.38
2				44.18	
3				43.09	
4				44.12	
5				44.88	
6				44.16	
1	435	13.50	30	44.32	0.68
2				45.01	
3				44.41	
4				44.51	
5				44.85	
6				44.28	

## VITA

Ms. Onuma Zongram was born on January 30, 1970 in Buriram Province, Thailand. She received her Bachelor's degree of Sciences (Radiology) from Mahidol University, Thailand in 1993 and Master's degree of Sciences (Biochemistry) from Chulalongkorn University, Thailand in 1998. She has worked at Institute of Health Research, Chulalongkorn University during December, 1998 to September, 2007 and College of Public Health Sciences, Chulalongkorn University, since October, 2007.

### Poster presentation

1. Zongram, O., Ruangrunsi, N., Palanuvej, C. and Rungsihirunrat, K. Epidermal studies of ten *Gardenia* species in Thailand. The 2nd international conference on advanced pharmaceutical research strategies and innovation in pharmaceutical research: safety, efficacy and quality. March 12, 2015, Auditorium room, Digital multimedia complex, Rangsit University, Thailand.

### Publications

1. Zongram, O., Ruangrunsi, N., Palanuvej, C. and Rungsihirunrat, K. Standardization of *Gardenia jasminoides* Fruits and Crocin Content Analysis Using UV/visible Spectrophotometry. *Chiang Mai Journal of Science*. (Accepted to publish)

2. Zongram, O., Ruangrunsi, N. and Rungsihirunrat, K. RAPD fingerprinting and genetic relationship of *Gardenia* species in Thailand. *Songklanakarin Journal of Science and Technology*. (Accepted to publish)

3. Zongram, O., Ruangrunsi, N., Palanuvej, C. and Rungsihirunrat, K. Leaf constant numbers of selected *Gardenia* species in Thailand. *Journal of Health Research*, 2017. 31(1): (Accepted to publish)

### Scholarships

1. Research Fund; 90th Anniversary of Chulalongkorn University Fund (Ratchadaphiseksomphot Endowment Fund).