

CHAPTER II



BACKGROUND

2.1 General Ozone

Ozone is a gaseous molecule contained with three atoms of oxygen (O_3). It has been firstly discovered in 1839 by C.F. Schönbein when he was observing electrical discharges. The name of ozone is a Greek word means “smell”, a pungent odor when in large concentrations. Most of ozone found in two regions of the Earth’s atmosphere where 90 percent is found in the stratosphere (10-50 km) and concentrated in 15 to 35 km (see Fig.2.1) above the Earth’s surface, commonly known as the ‘ozone layer’ which absorbed the harmful ray from the sun to protected life on the Earth. The remaining of ozone about 10 percent is found in the troposphere (0-10 km) where it is a key ingredient of urban smog or oftenly called ‘bad ozone’.

Although there is a small amount of the ozone which has average mixing ratio 0.4 parts per million, corresponding to 3 mm of the thickness if all ozone were compressed down to the Earth surface at Standard Temperature and Pressure (STP) [1], but it plays a vital role in the atmosphere by absorbing dangerous UV radiation which linked to harmful effects including various types of skin cancer, cataracts and harmful to some crops, materials and some forms of marine life.

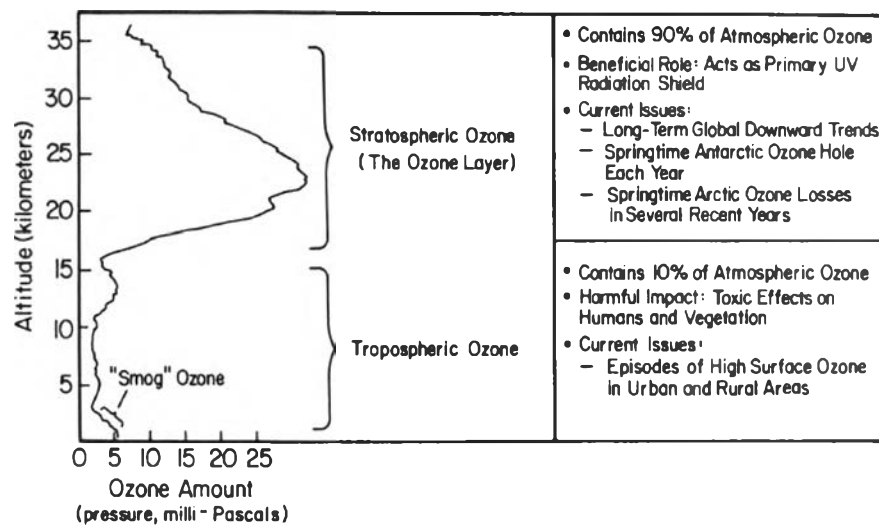
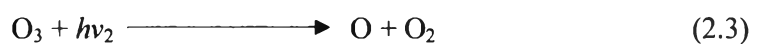
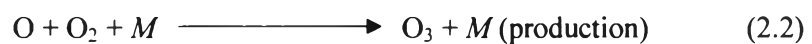
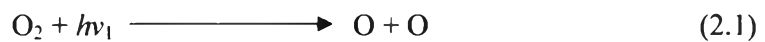

Fig 2.1 Atmospheric ozone layer [4]

The relationship between atmospheric ozone and ultraviolet radiation also influence to the global climate system where decreasing of stratospheric ozone is an increasing of ultraviolet radiation. The destruction of ozone more sunlight enters and heats the lower atmosphere. The consequences of global warming are severe even when the average temperature changes are small. The United Nations Environment Program estimates that a sustained 1 percent depletion of ozone will ultimately lead to a 2-3 percent increase in the incidence of non-melanoma skin cancer [2]. Additionally, increased ultraviolet light at the surface of Earth may aggravate problems with photochemical smog with emissions from industry and traffic conditions for very reactive chemistry that leads to ozone formation (at the surface of the Earth, ozone acts as a toxic gas) therefore the vertical ozone distribution patterns can be indicated the changing of atmospheric ozone both in the lower and upper atmosphere.

The ozone distribution is a balance between production, destruction and transport changes to any of these processes can lead to net changes in the ozone distribution, such as the changes between summer and winter, or long-term trends. The amount of ozone in the stratosphere is controlled by a photochemical balance between production and destruction. The basic reactions involved are as follows:



where $h\nu_1$ is high energy from solar radiation at wavelengths shorter than 242 nm for production and $h\nu_2$ is wavelengths shorter than 1,200 nm (infrared) for destruction [3] and M is a molecule of gases such as nitrogen or oxygen.

Ozone is not distributed uniformly through the vertical column. The global average value is about 300 Dobson Unit (DU) and varies by latitude from about 230 to 500 DU [4]. The ozone produced all year round in the stratosphere over equatorial belt. It is transported by air movements towards the polar latitudes. Total column ozone average is lowest over the equatorial belt and increases with latitude. The factors influencing ozone concentration are:

Latitudinal and Seasonal variation

The ozone is naturally created over the tropics and carried to higher latitudes by prevailing winds which is a consequence of the general circulation in the stratosphere known as the Brewer-Dobson circulation, which moves the ozone from tropics to the middle and polar latitudes [5]. Therefore, the ozone layer is usually thinnest in the tropics. The seasonal variation is found significant as shown in Fig. 2.2 that the high amount of total ozone are in summer months especially in May and lower in winter months or in November – February.

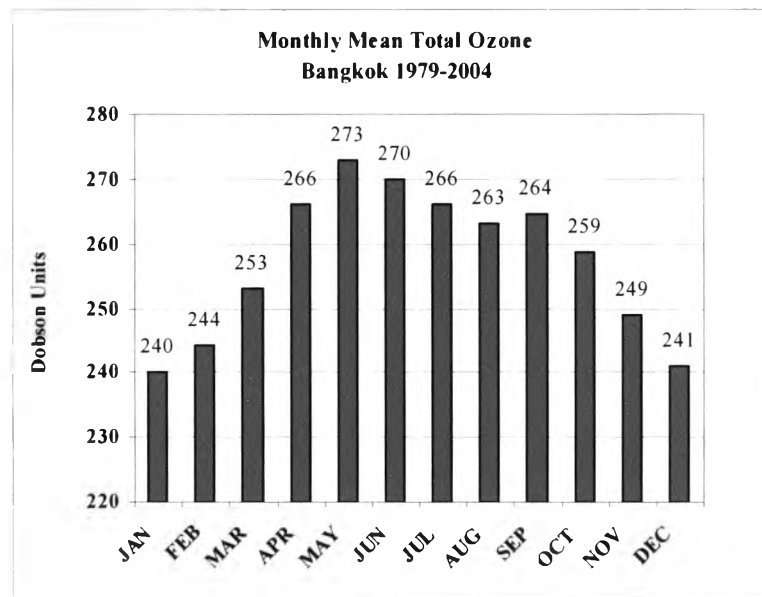

Fig 2.2 Seasonal variation of total ozone at Bangkok during 1979-2004

Sunspot solar-cycle

Due to the atmospheric ozone is created by the UV radiation, which its intensity is varies within an 11 years of solar-cycle. The solar-cycle is occurred by the changes of the magnetic field of the sun which increases the intensity of solar UV radiation. The high amount of sunspot activity corresponds to more intense of the solar UV radiation and lead to more rapid ozone production (see Fig.2.3). Variation of annual ozone corresponding with the sun spot cycle is illustrated in Fig. 2.3. A study by Brien Sparling [6] mentioned that the global change of ozone causing by the solar cycle is about 2 percent.

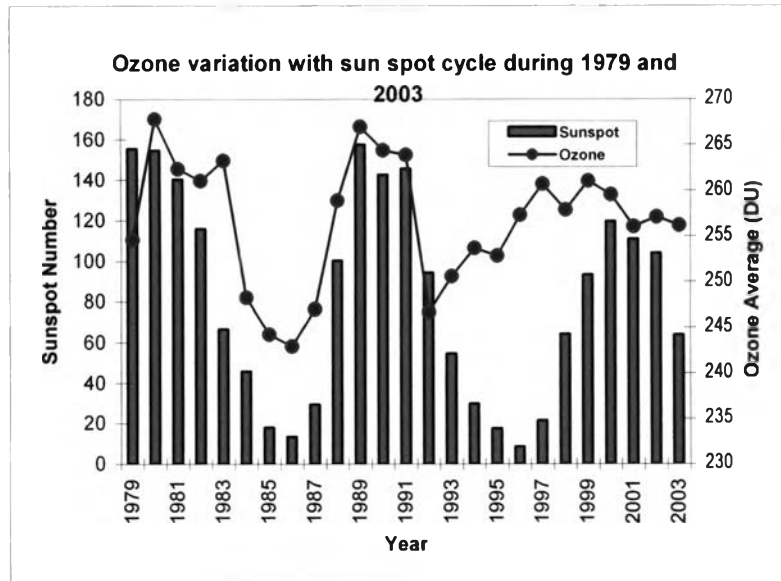

Fig 2.3 Ozone variation with sun spot cycle during 1997-2003

Tropical stratospheric winds

An event of the tropical winds in lower stratosphere switch from easterly to westerly and then back again in every two years is called the Quasi-Biennial Oscillation (QBO) [5]. The QBO wind can transport atmospheric ozone from particular latitude to others and lead to 3% of ozone changing [6]. Fig.2.4 shows a study of the inter-annual anomalies of TOMS column ozone at the equator related to optimal QBO referenced in time series [7].

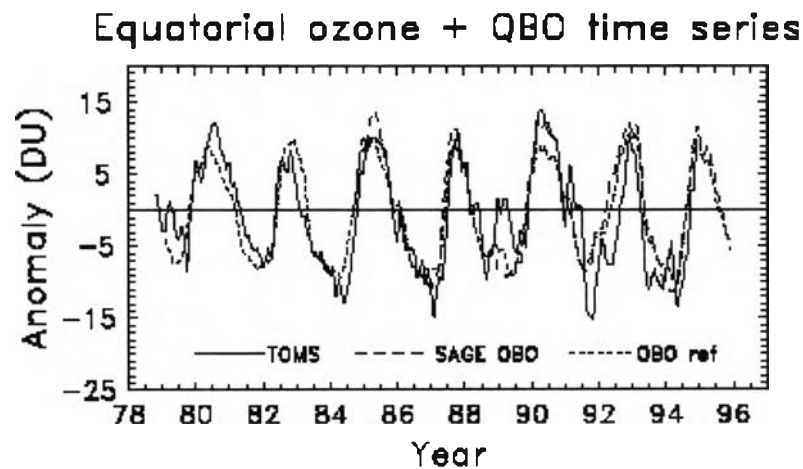

Fig 2.4 Inter-annual anomalies related to QBO [7]

Stratospheric sulfate aerosols

The effects of a large volcano on global weather are able to place a amount of aerosols into the lower stratosphere, such as chlorine. Mt. El Chichon in Mexico (1982) and Mt. Pinatubo in Philippines (1991) eruption which injected the chemical compounds, change the radiation balance in the stratosphere by scattering light and which convert inactive chlorine compounds to active, ozone destroying forms rapidly in this period (less than 3 percent) and last no more than 2-3 years [6] (see Fig.2.3).

Greenhouse gases

Greenhouse gases such as carbon dioxide and methane enhance heat the planet and alter weather patterns. The global warming predicts cooler stratospheric temperature leading to more active chlorine in the area of Antarctic ozone hole. Due to Thailand is agriculture, biomass burning is an important source of ozone precursors for the tropical troposphere. Burning of agricultural waste and shifting cultivation influence on increasing of the tropospheric ozone (especially in winter season).

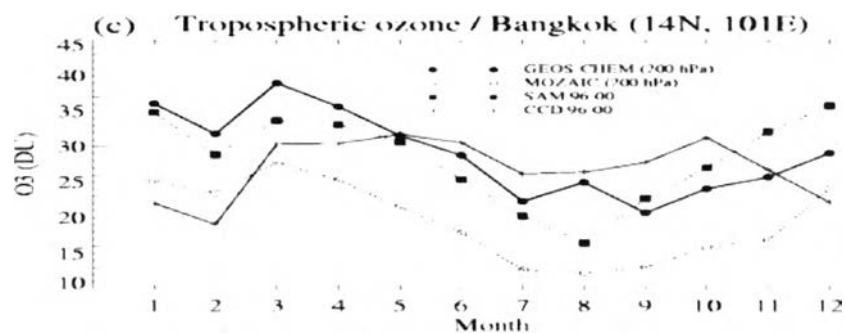

Fig 2.5 Seasonality of tropical tropospheric ozone during 1996-2000 [8]

Ozone-Depleting Substances

Ozone-Depleting Substances (ODS) such as chlorofluorocarbons (contain of the chemical elements chlorine, fluorine and carbon) and halocarbon (contain several of the chemical elements chlorine, fluorine, bromine, carbon and hydrogen) are important human-produced ozone depleting gases that have been used in many applications. These substances are effective ozone depletes namely; they are long life time in the atmosphere and can drift up into the stratosphere that helps the natural reactions to destroy ozone.

The vertical distribution of ozone or Umkehr effect was discovered and named by Götzt in 1931. He realized that observations of Umkehr effect contained information about the vertical ozone distribution in the atmosphere. The first attempt to retrieve this information was made in 1934. He described the classical methods A and B for the Dobson Umkehr observations. In 1957 the specific procedures were developed by Walton [9] as method A, and by Ramanathan and Dave [9] as method B. In 1959, Dütsch was developing a computer algorithm for retrieval of profile information of method B. An improved version method which used for evaluation of all Umkehr observations proposed in 1964 by Mateer and Dütsch. During 1970's the Brewer Spectrophotometer was developed, based on the same measurement principle as the Dobson Spectrophotometer but the Brewer instruments are completely automated and data are collected by a computer. A new Umkehr inversion algorithm based on 1964 was improved by Mateer and DeLuisi in 1992, this algorithm has been in use since that time.

2.2 Literature Review

Several studies had been carried out for understanding the measurements and algorithm of ozone profile; some advanced researches are reviewed as follows:

2.2.1 The Vertical Distribution of Ozone in the Atmosphere

The Umkehr Effect was noticed by Götzt. He found that the observation of the ratio of the intensities of two wavelengths in ultraviolet radiation were decreased at first as the sun zenith distance (Z) increased but then suddenly increased after passed a minimum (at approximately 85 degree solar zenith angle). The ratio of the intensities can be expressed as the logarithm:

$$I_0 = -\log \frac{I}{I'} + C \quad (2.5)$$

where:

- I_0 = the intensity of solar radiation outside the atmosphere;
- I = the intensity of short wavelength;
- I' = the intensity of long wavelength; and
- C = a constant.

Plots of $-\log I/I'$ against Z referred to as the Umkehr Curves show as an example in the Fig. 2.6.

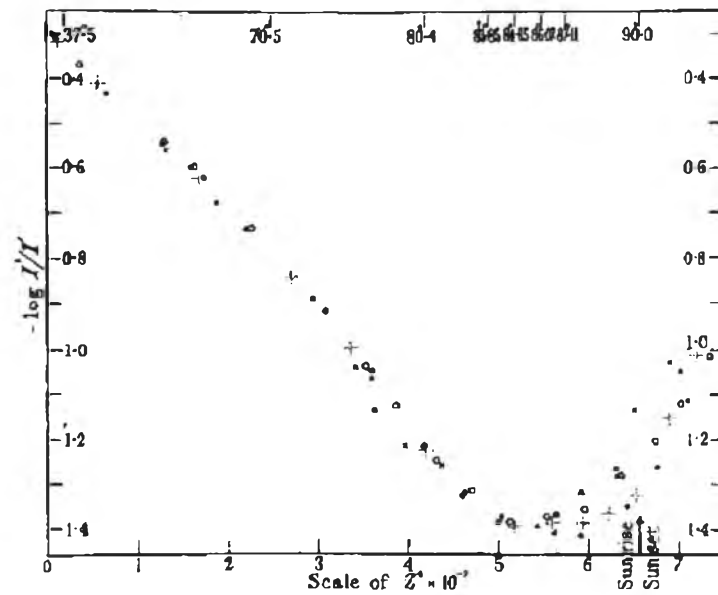

Fig 2.6 Observed values of $-\log I/I'$ for zenith blue sky on 5 days of which the total ozone content was nearly identical [10]

The light that comes through the atmosphere will be attenuated by the ozone absorption and air scattering. Amount of zenith sky light received by the instrument is the sum of all scattered layers. To find out the vertical ozone distribution in the atmosphere the classical method A and B were used [10].

Calculation of the Distribution of the Ozone from Zenith Sky Observation

The intensity of scattered light of any given wavelength reaching any point at a height (H) in the atmosphere is:

$$I = I_0 10^{-\int_H^{\infty} (\alpha x_h + \beta_h) \sec \zeta_h dh} \quad (2.6)$$

where

- I = the intensity of scattered light;
- I_0 = the intensity of solar radiation outside the atmosphere;
- x_h = the total amount of ozone at layer h ;
- α = the ozone absorption coefficient;

- β_h = the scattering coefficient of the air at layer h; and
 ζ_h = the sun zenith distance as seen from the point of measurement at layer h.

Thus, incoming of vertical scattering light will be:

$$I = K_{\rho H} (1 + \cos^2 Z) \times I_0 10^{-\int_H^{\infty} (\alpha x_h + \beta_h) \sec \zeta_h dh} \quad (2.7)$$

where:

- K = the instrumental constant; and
 ρ_H = the density of the air at layer H.

The total light reaching the instrument which was scattered at a height H will be:

$$I = K_{\rho H} (1 + \cos^2 Z) \times I_0 10^{-\int_H^{\infty} (\alpha x_h + \beta_h) \sec \zeta_h dh} \times 10^{-\int_0^H (\alpha x_h + \beta_h) dh} \quad (2.8)$$

Hence, the total light reaching the instrument from zenith sky will be:

$$I = KI_0 (1 + \cos^2 Z) \int_0^{\infty} \rho_h \left\{ 10^{-\int_h^{\infty} (\alpha x_h + \beta_h) \sec \zeta_h dh} \times 10^{-\int_0^h (\alpha x_h + \beta_h) dh} \right\} dh \quad (2.9)$$

The term of $(1 + \cos^2 Z)$ can be neglected because too small affect to the ratios of the intensities of two wavelengths. In addition, the constant K is also neglected since the values were necessary to compare at any height of the sun with that at some fixed height; all terms are independent of Z and the total amount of ozone.

To finding the strict mathematical method of the vertical ozone distribution in the atmosphere is not easy thus, the Umkehr Curve are very useful to be used as an approximately method. Two different methods but give similar results have been employed at Arosa in Switzerland (for method A) and Oxford in England (for method B) are to be represented.

Method A of Calculating the Vertical Distribution of Ozone

This method is to make use of the Umkehr curve for deriving the values x_γ in the different sections (γ) where the summation of x_γ is the total ozone amount (x). The calculation to be done as the following steps:

1. Divide the atmosphere into 5 sections, the ozone in each sections are also expressed as below:

Above	50 km	= 0 cm
Between	35-50 km	= x_1 (unknown)
Between	20-35 km	= x_2 (unknown)
Between	5-20 km	= $x - (x_1 + x_2 + u)$
Between	2-5 km	= u (3% of x)

where x is the total amount of ozone which obtained by Direct Sunlight (DS) observation.

2. Find two unknown amounts of ozone (x_1, x_2) by a mean observed Umkehr curve (values of $-\log I/I'$) given at two values of Z . For this paper Table 2.1 represents the mean path (l) for $Z = 80^\circ$ and $Z = 90^\circ$ (for the other values of Z , the atmosphere should be divided into different sections) which obtain two unknown x_1 and x_2 where:

$$I = \sum 10^{-\beta l} \cdot b \cdot 10^{\alpha l} \times const. \quad (2.10)$$

when
$$L = 1 + b / 760 [f(Z) - 1] \quad (2.11)$$

where:

- I = the intensity of scattered light;
- L = the whole mass of air which the beam has to traverse;
- l = the path through the ozone measured in centimeters;
- β = the scattering coefficient of the whole atmosphere (for 760 mmHg);
- α = the ozone absorption coefficient;
- b = the pressure at the height of scattering (in millimeters of Hg); and
- $f(Z)$ = the function of $\sec Z$.

Table 2.1 The mean paths for $Z = 80^\circ$ and $Z = 90^\circ$ [10]

Hight (km)	Mean path (l) in cm of ozone	
	$Z = 80^\circ$	$Z = 90^\circ$
Above 50	x	x
35-50	$x+2.31x_1$	$x+19.03x_1$
20-35	$x+4.38x_1+2.31x_2$	$x+15.30x_1+18.90x_2$
5-20	$3.31x+1.75x_1+2.06x_2-2.31u$	$19.87x-9.99x_1-3.62x_2-18.87u$
2-5	$5.51x-0.62x_1-0.33x_2-2.14u$	$22.34x-13.18x_1-10.64x_2+17.52u$

To evaluate two unknown x_1 and x_2 by using the Eq. (2.10) for each x (from observed) and Z hence, the total ozone in the different values per section can be determined.

Method B of Calculating the Vertical Distribution of Ozone

This method is dividing the atmosphere into eight sections for finding the distribution of ozone. The vertical temperature and pressure distribution in the atmosphere and the heights of sections including the layers are to be assumed for the accuracy. The amount of light that received by the instrument is the summation of the scattered light by all layers. To calculate the Umkehr Curves, the amount of light of the two wavelengths (short and long wavelengths, I , I') in any zenith distance are to be used. The calculation will be completed when the curves are not greatly different between the calculated and observed Umkehr Curves.

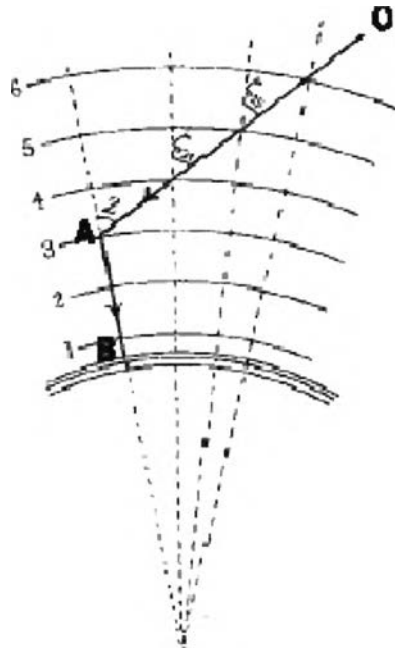

Fig 2.7 The vertical section through the atmosphere [10]

To obtain the values of the total light received by the instrument it is possible to consider the ray in the direction OA from the sun which scattered by layer 3 (see in the Fig.2.7). Define S as the intensity of radiation for the shorter wavelength (311.0 nm) from outside the atmosphere thus, the intensity which reaching the center of layer 3 will be given by;

$$\log F_3 = \log S - (\alpha_3 + \beta_3) \sec \zeta_{38} \dots - (\alpha_4 + \beta_4) \sec \zeta_{34} - \frac{1}{2} (\alpha_3 + \beta_3) \sec Z \quad (2.12)$$

The intensity I_3 received by the instrument will be given by:

$$\log I_3 = \log F_3 + \log f_3 - \frac{1}{2} (\alpha_3 + \beta_3) - (\alpha_2 + \beta_2) - (\alpha_1 + \beta_1) \quad (2.13)$$

The total intensities received by the instrument from the clear zenith sky for the wavelength 311.0 nm will then be:

$$I = I_1 + I_2 + I_3 + \dots + I_8 \quad (2.14)$$

When Z becomes nearly 90° , there is not sufficiently accurate for this method because the scattering light in each layer reaching the instrument, the scattering light express as:

$$(\alpha_\gamma + \beta_\gamma)(1 + \sec Z)/2 \quad (2.15)$$

Thus Eq. (2.12) becomes:

$$\begin{aligned} \log F_3 = \log S - (\alpha_3 + \beta_3) \sec \zeta_{38} - \dots - (\alpha_4 + \beta_4) \sec \zeta_{34} \\ - (\alpha_3 + \beta_3) \sec Z / 2 - (\alpha_3 + \beta_3) / 2 \end{aligned} \quad (2.16)$$

Combine Eq. (2.16) with Eq. (2.13) and the function which can evaluate by graphical integration thus, the intensity of the layer 3 when Z nearly 90° will be:

$$\begin{aligned} \log I_3 = \log S - (\alpha_8 + \beta_8) \sec \zeta_{38} - \dots - (\alpha_4 + \beta_4) \sec \zeta_{34} - (\alpha_3 + \beta_3) \Phi(Z) \\ - (\alpha_2 + \beta_2) - (\alpha_1 + \beta_1) \end{aligned} \quad (2.17)$$

where $\Phi(Z)$ is a function which can be evaluated by graphical integration

As the instrument give the value of $-\log \frac{I}{I'} + C$, where C is the instrumental constant. The problem of the constant is none of the instruments is calibrated in zenith sky radiance mode; sensibilities in the observation can be occurred therefore it is significant to find out the problem. The fact that the value of $-\log \frac{I}{I'}$ does not depend on the distribution of ozone when the zenith distance is less than 40° therefore compare the calculated values of $-\log \frac{I}{I'}$ when Z is less than 40° with the observed value, then add the difference to the calculated values for all of Z is to be the appropriated resolve.

2.2.2 Calculation of the Vertical Distribution of Atmospheric Ozone

The purpose of this section is to describe a method [9] of finding the vertical distribution of ozone which using the standard tables to derive a set of the Umkehr

curves. The Umkehr measurements with the Dobson spectrophotometer are expressed as the number of N defined as follows:

$$N = \text{const.} - 100 \log \frac{I}{I'} \quad (2.18)$$

where:

- I = the intensity of shorter wavelength from the zenith sky; and
 I' = the intensity of longer wavelength from the zenith sky.

The Umkehr observations made in different solar zenith angles thus the constant in Eq. (2.18) can be eliminated and the equation become:

$$N(Z_2) - N(Z_1) = 100 \left[\log \frac{I}{I'} \text{ at } Z_1 - \log \frac{I}{I'} \text{ at } Z_2 \right] \quad (2.19)$$

where:

- Z₁ = the higher solar zenith angle; and
 Z₂ = the smaller solar zenith angle.

Considering only primary scattering, the equation can be expressed as the following:

$$\frac{I}{I'} = \frac{\beta}{\beta'} \frac{10^{-\alpha x} (A_0 + \sum_1^4 A_\gamma 10^{-\alpha} Y_\gamma)}{10^{-\alpha' x} (A'_0 + \sum_1^4 A'_\gamma 10^{-\alpha'} Y_\gamma)} \quad (2.20)$$

where:

- x = the total ozone amount;
 α = the ozone absorption coefficients at shorter wavelength;
 α' = the ozone absorption coefficients at longer wavelength;
 β = the air molecules scattering coefficients at shorter wavelength;
 β' = the air molecules scattering coefficients at longer wavelength;
 Y_γ = the sectional amounts of ozone;
 A_γ = the sectional constant depend on the scattering coefficients at shorter wavelength;
 A'_γ = the sectional constant depend on the scattering coefficients at longer wavelength;

wavelength;

A_0 = the constant depend on the scattering coefficients at shorter wavelength outside the atmosphere; and

A_0' = the constant depend on the scattering coefficients at longer wavelength outside the atmosphere.

The sectional amounts of ozone assigned as Table 2.2, the symbol u is assumed to be $0.085 x$, x_1 and x_2 can be determined from the Eq. (2.23)

Table 2.2 Division of the atmosphere into sections [9]

Section no. (γ)	Height limits (km)	Assigned amount of ozone (cm)
0	54- ∞	0
1	48-54	$0.057x_1$
	42-48	$0.204x_1$
	36-42	$0.739x_1$
2	24-36	x_2
3	12-24	$x-x_1-x_2-u$
4	0-12	u

Let

$$Q(Z) = \frac{A_0 + \sum_1^4 A_\gamma 10^{-x} Y_\gamma}{A_0' + \sum_1^4 A_\gamma' 10^{-x} Y_\gamma} \quad (2.21)$$

Put (2.21) into Eq. (2.19)

If

$$\log \frac{Q(Z_1)}{Q(Z_2)} = \log \frac{I}{I'} atZ_1 - \log \frac{I}{I'} atZ_2 \quad (2.22)$$

Will get ΔN as following:

$$100 \log \frac{Q(Z_1)}{Q(Z_2)} = N(Z_2) - N(Z_1) = \Delta N \quad (2.23)$$

The unknown x_1 and x_2 can be determined by using the standard (ΔN , x) curves (show in Fig 2.8 (a)-(e)). The standard tables constructed for the C wavelengths (311.2/332.3 nm) by evaluating $\log Q(60^\circ)/Q(80^\circ)$ and $\log Q(60^\circ)/Q(86.5^\circ)$ for five

values of x namely, 0.15, 0.20, 0.25, 0.30 and 0.35 cm, five values of x_1 namely, 0, 0.01, 0.02, 0.03 and 0.04 cm. The seven values of x_2 covering a suitable range in each case thus the values of x_1 and x_2 can be read by the curves.

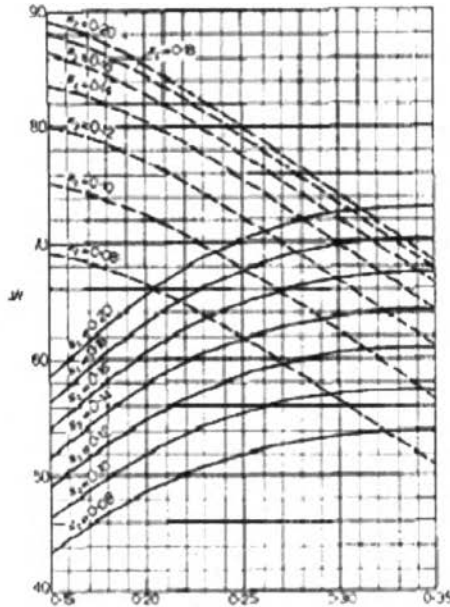
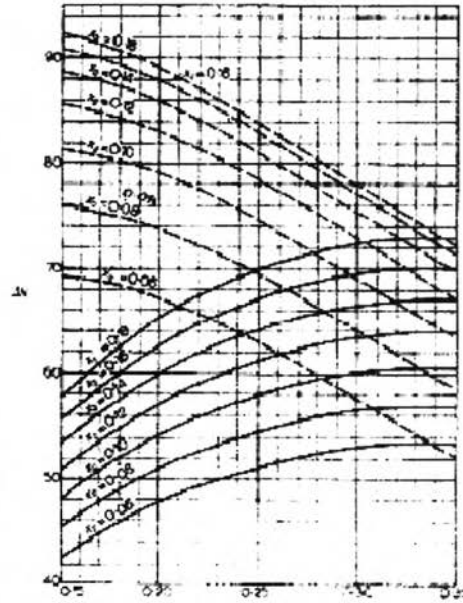
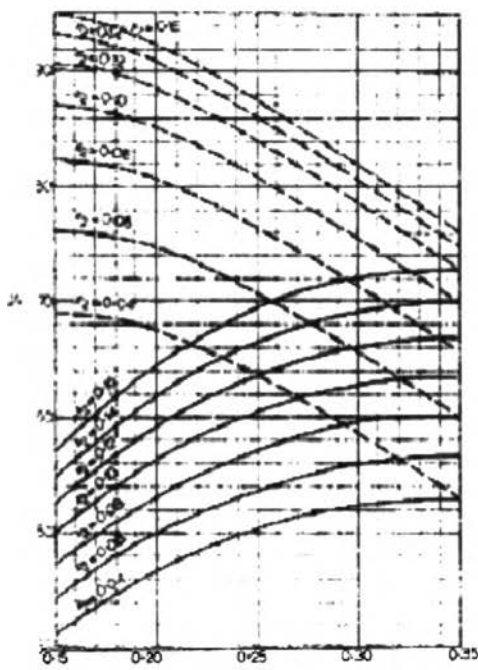
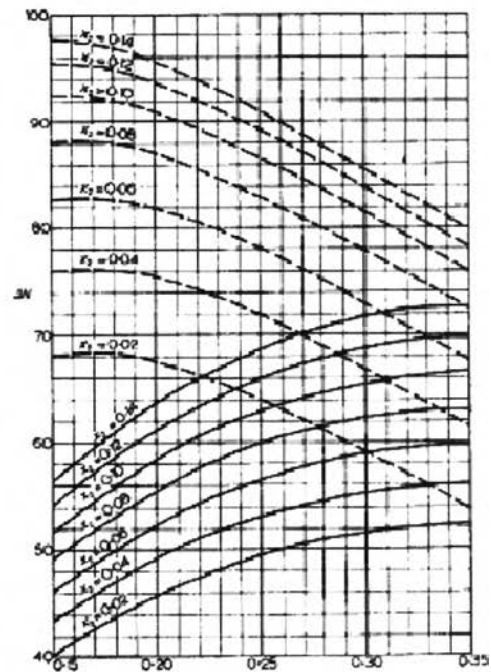
(a) $x_1 = 0$ (b) $x_1 = 0.01$ (c) $x_1 = 0.02$ (d) $x_1 = 0.03$

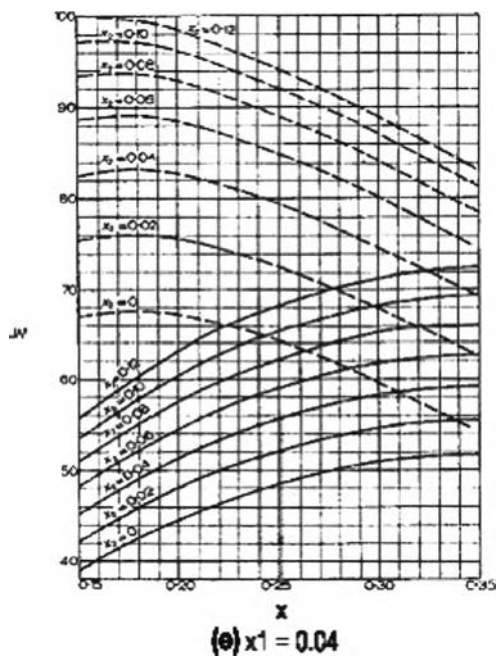

Fig 2.8 ($\Delta N, x$) curves for different x_1 and x_2 (cm). Full line: $\Delta N = N(80^\circ) - N(60^\circ)$.
Dashed lines: $\Delta N = N(86.5^\circ) - N(60^\circ)$, [9]

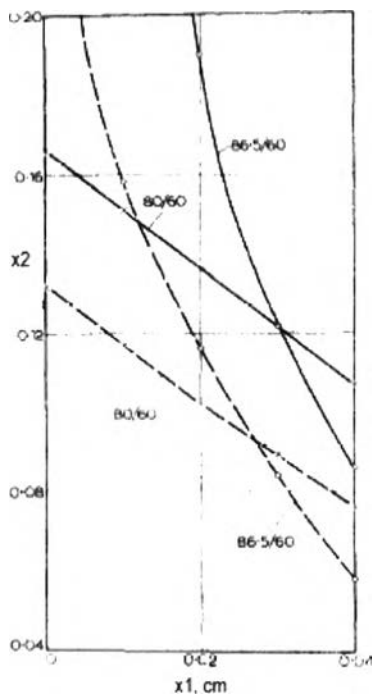

Fig 2.9 (x_1, x_2) curves, the broken curves are obtained from data corrected for secondary scattering [9]

For example, Umkehr data obtained at Ahmedabad by method B on 16 October 1956, $x = 0.192$ cm at $\Delta N = N(80^\circ) - N(60^\circ) = 60.2$ and $\Delta N = N(86.5^\circ) - N(60^\circ) = 94.3$, the values become 55.7 and 88.3 after corrections for secondary scattering table. The two sets of values of x_1 and x_2 (uncorrected and corrected) can be obtained by interpolating the values of x and ΔN (as the Fig.2.9). The results show the vertical distribution of ozone was decreasing after being corrected (as Fig.2.10 and 2.11).

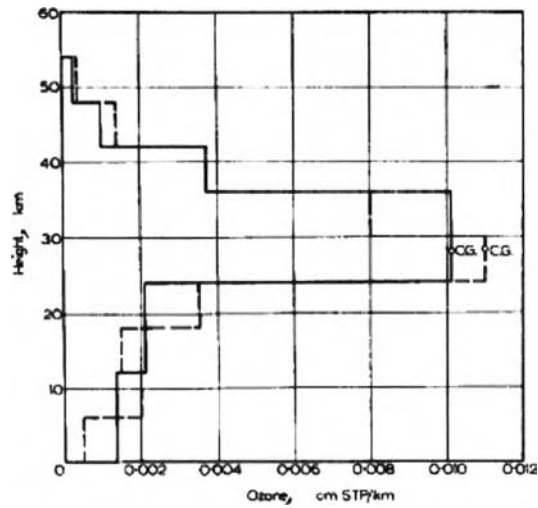

Fig 2.10 Ozone distributions at Ahmedabad (solid line) on 16 October 1956 (uncorrected), [9]

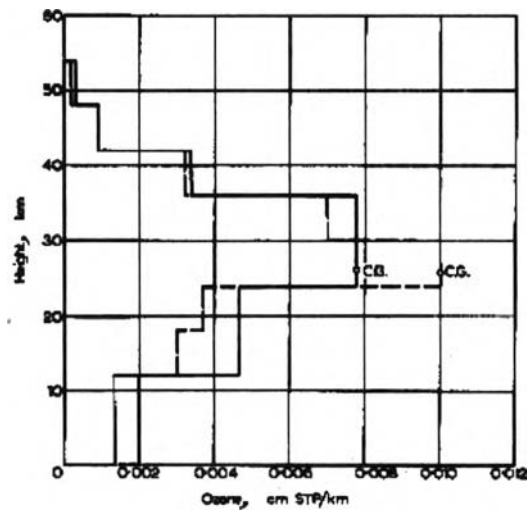

Fig 2.11 Ozone distributions at Ahmedabad (solid line) on 16 October 1956 (corrected), [9]

2.2.3 A New Umkehr Inversion Algorithm

A new Umkehr algorithm has been developed for estimation of the vertical ozone profile [11]. The system input is the actual atmospheric ozone profile and the system output is the retrieved ozone profile. He defined two models for the ozone profile retrieval algorithm called the forward and inverse models where describe as below:

Forward Model

The forward model calculates the N-value from the zenith sky measurement with the formula:

$$N(x, z) = 100 \log_{10} \left\{ \frac{I(x, z, L_2)}{[I(x, z, L_1)/F_0(L_1)]} \right\} + C_0 \quad (2.24)$$

where N is the relative logarithmic attenuation for the wavelength pair and is referred to as the N-value, The quantity x refer to the ozone profile, z is the solar zenith angle, $I(x, z, L_1)$ is the 311.5 nm radiance of the C-wavelength pair, $I(x, z, L_2)$ is the 332.4 nm radiance of the C-wavelength pair, F_0 is the extra-terrestrial solar flux, C_0 is an instrumental constant.

In this algorithm, N can break down into four separate components:

$$N_p = N - N_{MS} - N_R - C_0 \quad (2.25)$$

where N_p is the primary scattering component of N, N_{MS} is the multiple scattering components, N_R is a refraction component and, C_0 is the instrument constant

The measurement vector elements (y_k) consist of the observed N-values at the various solar zenith angles (Z_k). To corrected for multiple scattering and refraction, the smallest zenith angle (Z_{min}) to be subtracted from the observations at each of the other angles therefore the instrument constant can be also eliminated.

$$y_k = N_{(z_k)} - N_{(Z_{min})} \quad (2.26)$$

Additionally, there is a y element (always equal to zero) for the total ozone conservation equation. The retrieved profile is constrained to have very nearly the

same total ozone as observed. The measurement vector y is expanded about the linearization point x_n as follow:

$$y = y_n + \frac{\partial y}{\partial x(x - x_n)} = y_n + K_n(x - x_n) \quad (2.27)$$

where K_n is the matrix of weighting functions and x is a priori ozone profile.

Inverse Model

The ozone profile retrieval uses the optimum statistical estimation method. This part is done in the inverse model where the new adjusted profile is produced. At the n th iteration, retrieval x_{n+1} are obtained from x_n as follows:

$$x_{n+1} = x^A \times [S_x^{-1} + K_n^T S_E^{-1} K_n]^{-1} \times [K_n^T S_E^{-1}] [(y - y_n) - K_n(x^A - x_n)] \quad (2.28)$$

where $x_1 = x^A$ is the a priori ozone profile, S_x is the covariance uncertainty matrix for the first-guess profile. S_E is the error covariance matrix for the measurements, y_n is the vector of calculated observations for x_n and the superscript T represents matrix transposition.

2.2.4 Brewer Umkehr Software Description and Use

McElroy reported on the current status of the Brewer Umkehr software and described how to use it [12]. He described the Umkehr measurement technique depends on the process of scattering radiation in the atmosphere. Observations of the zenith sky brightness are made between 60 and 95 degrees solar zenith angle. The variation of the mean scattering height of radiation reaching the instrument as a function of the solar zenith angle, together with the total ozone column amount estimated from direct sun observations is used in a model calculation to deduce the vertical profile of ozone. A useful feature of the Umkehr technique is the relative independence of the retrieved profile on instrumental characteristics providing that an accurate total column ozone measurement is available for the time of the Umkehr observations. Umkehr observations are made at standard set of ozone observing wavelengths. The full set of eight Umkehr wavelengths includes 306.3, 310.1, 313.5, 316.8, 320.1, 323.2, 326.4 and 329.5 nm.

The algorithm of Mateer and Deluisi in 1992 is very useful for the Brewer Umkehr analysis. The processing procedure is automatic programme. The first step to use this programme is to enter site and instrument number in the setup files for the pre-processor and the Umkehr analysis programme. The pre-processor will reduce the observations data from photon counts to corrected count rates per second. The intensity at each wavelength in the form of 100 times the logarithm to the base 10 of corrected counts (N-values). The data include such parameters as the ozone absorption coefficients and the site location including the average site surface pressure. In addition to the setup files, it is necessary to have a file in standard format (the OZOAV file) so that the pre-processor can determine the total ozone associated with each Umkehr observation. The actual Umkehr data are contained in a separate U file for each observing day. The file names are formatted as Ujjjyy.nnn where the jjj is the Julian local day number, the yy is the two digit year and nnn represents the instrument serial number. It was noted that different setup files must be used with data from different locations.

The data from the pre-processing step are corrected for the multiply-scattered light component and then fitted using a single-scattering, radiative transfer code. The inversion algorithm adjusts the amount of ozone as a function of height to retrieve the vertical ozone profile. The first-guess profile of ozone used in the inversion process is determined from a climatological data set which uses the measured total ozone, the latitude and the day of the year to generate an estimate of the ozone profile for the day to be analyzed.

2.2.5 An Improved Umkehr Algorithm

Petropavlovskikh proposed an improvement of Umkehr ozone profile retrieval algorithm which based on Mateer and DeLuisi in 1992. The new several changes to the algorithm are as follows:

1. The newly up dated algorithm is used more traditional approach of a priori climatology on season and latitude (does not depend on total ozone) therefore the new a priori profile has no variation in short-term, long-term and inter-annual.
2. The newly updated algorithm is requiring less a priori information to obtain stable solutions because of the standard ozone profiles are linearly interpolated to the observed total ozone where the standard ozone profiles are altitude and total

ozone dependent, and have been created to present typical ozone profile at high, middle and low latitudes at sea-level pressure.

3. The newly updated algorithm increased the vertical resolution of the solution which approach minimizes the errors of the retrieval caused by interpolation procedures. To minimize the errors, the a priori profile has to be smooth. Because of the new algorithm does not vary from year to year therefore an updated a priori information to the retrieval is to reduce the bias in the retrieved data.

4. The newly updated algorithm allowed for solar zenith dependence in the measurement noise in the retrieval namely, at high latitudes during the wintertime where the sun does not reach a 60 degree solar zenith angle, the normalization can be changed to 70 or up to 77 degree solar zenith angle.

5. The newly updated algorithm is modified the a priori covariance matrix according to recommendations by Rodgers (2000) in order to provide a minimum standard deviation in the monthly mean ozone values. The results suggest that a priori covariance matrix 0.1 provides a good compromise between the variability of the atmosphere and typical measurement noise.