

ARCHITECTURAL JOINERY DESIGN TO PREVENT WATER LEAKAGE IN A PRECAST
CONCRETE DETACHED HOUSE



A Thesis Submitted in Partial Fulfillment of the Requirements
for the Degree of Master of Architecture in Architectural Design

Common Course

FACULTY OF ARCHITECTURE

Chulalongkorn University

Academic Year 2019

Copyright of Chulalongkorn University

การออกแบบรอยต่อทางสถาปัตยกรรมเพื่อป้องกันการรั่วซึมของน้ำในบ้านเดี่ยวคอนกรีตสำเร็จรูป



วิทยานิพนธ์นี้เป็นส่วนหนึ่งของการศึกษาตามหลักสูตรปริญญาสถาปัตยกรรมศาสตรมหาบัณฑิต

สาขาวิชาการออกแบบสถาปัตยกรรม ไม่สังกัดภาควิชา/เทียบเท่า

คณะสถาปัตยกรรมศาสตร์ จุฬาลงกรณ์มหาวิทยาลัย

ปีการศึกษา 2562

ลิขสิทธิ์ของจุฬาลงกรณ์มหาวิทยาลัย

Thesis Title ARCHITECTURAL JOINERY DESIGN TO PREVENT WATER
LEAKAGE IN A PRECAST CONCRETE DETACHED HOUSE
By Miss Prokchol Vataniyobol
Field of Study Architectural Design
Thesis Advisor PAT SEEUMPORNROJ, Ph.D.

Accepted by the FACULTY OF ARCHITECTURE, Chulalongkorn University in Partial
Fulfillment of the Requirement for the Master of Architecture

..... Dean of the FACULTY OF
ARCHITECTURE
(Associate Professor PINRAJ KHANJANUSTHITI, Ph.D.)

THEESIS COMMITTEE

..... Chairman
(Associate Professor PINRAJ KHANJANUSTHITI)

..... Thesis Advisor
(PAT SEEUMPORNROJ, Ph.D.)

..... Examiner
(CHOMCHON FUSINPAIBOON, Ph.D.)

..... Examiner
(Assistant Professor VORAPAT INKAROJRIT, Ph.D.)

..... External Examiner
(Associate Professor Chawalit Nitaya, Ph.D.)

ปรกชล วทานิโยบล : การออกแบบรอยต่อทางสถาปัตยกรรมเพื่อป้องกันการรั่วซึมของน้ำในบ้าน
เดี่ยวคอนกรีตสำเร็จรูป. (ARCHITECTURAL JOINERY DESIGN TO PREVENT WATER
LEAKAGE IN A PRECAST CONCRETE DETACHED HOUSE) อ.ที่ปรึกษาหลัก : ดร.ภัทร์ สี
อัมพรโรจน์

การก่อสร้างคอนกรีตสำเร็จรูปใช้กันอย่างแพร่หลายในประเทศไทยโดยลูกค้าและนักพัฒนาเพื่อการพัฒนาที่อยู่อาศัย หลายทศวรรษของการสร้างด้วยระบบผนังคอนกรีตสำเร็จรูป ปัญหาของการรั่วไหลของน้ำเป็นปัญหาที่ผู้ซื้อเป็นกังวลมากที่สุด วิทยานิพนธ์ฉบับนี้มีวัตถุประสงค์เพื่อค้นหาปัญหาที่นำไปสู่สาเหตุของการแทรกซึมของน้ำและเสนอแนวทางแก้ไขเพื่อป้องกันการรั่วไหลของน้ำ จากการทบทวนวรรณกรรมพบว่าแหล่งที่มาของการรั่วไหลของน้ำอยู่ที่ตำแหน่งการเชื่อมต่อระหว่างโมดูลสำเร็จรูป น้ำสามารถทะลุผ่านช่องเปิดด้วยแรงสั่นอย่าง โมเมนต์ค้ำของน้ำฝน การซึมตามรูเล็ก แรงโน้มถ่วง และแรงดันอากาศ วิทยานิพนธ์ฉบับนี้แบ่งการเชื่อมต่อคอนกรีตสำเร็จรูปเป็นสามประเภทคือ ข้อต่อแบบชั้นตอนเดียว ข้อต่อแบบสองชั้นตอน และข้อต่อแบบระบายน้ำ การทดลองเกี่ยวกับการแทรกซึมของน้ำได้ดำเนินการบนพื้นฐานของการรั่วไหลของน้ำ ด้วยการทดสอบของน้ำแบบมีแรงดึงดูดของโลกและการทดสอบด้วยการพ่นน้ำซึ่งมีแรงโมเมนต์ค้ำของฝน หรือฝนที่ขับเคลื่อนด้วยลม นั่นเอง การทดสอบบนผนังคอนกรีตสำเร็จรูปหกชั้น โดยที่สามโมดูลไม่มีรายละเอียดของบังใบ และอีกสามโมดูลมีรายละเอียดของบังใบแบบทางเดียว ผลการศึกษาพบว่าการเชื่อมต่อชนิดที่มีประสิทธิภาพมากที่สุด คือ ข้อต่อแบบชั้นตอนเดียว แต่เนื่องจากมีโอกาสสูงที่จะเกิดการผิดพลาดจากข้อต่อทำให้ข้อต่อมีแนวโน้มที่จะทำให้เกิดการรั่วซึมของได้ง่าย ดังนั้นระบบรอยต่อที่มีประโยชน์อันดับที่สองคือข้อต่อแบบระบายน้ำที่มีรายละเอียดบังใบทางเดียว ซึ่งมีการเปลี่ยนแปลงในอุณหภูมิของผิวคอนกรีตต่ำสุดในการทดสอบ วิทยานิพนธ์ฉบับนี้ได้้นำผลการศึกษาไปออกแบบและปรับปรุงหมู่บ้านเดอะเซ็นโพรังสิตเฟสสอง โดยโครงการเป็นบ้านเดี่ยวสองชั้นที่ใช้ระบบผนังคอนกรีตสำเร็จรูป การออกแบบใหม่ได้แก่ การแยกส่วนในการวางแผนพื้นที่เพื่อลดจุดเชื่อมต่อและเสริมองค์ประกอบเพิ่มเติมเพื่อหักเหและดันน้ำออกจากพื้นผิวอาคาร จากการทดลองการแทรกซึมของน้ำข้อต่อแบบระบายน้ำที่มีรายละเอียดบังใบทางเดียวได้ถูกเลือกนำมาใช้ในการออกแบบใหม่ วิทยานิพนธ์ฉบับนี้เสนอการออกแบบใหม่ที่ปรับปรุงโมดูลบ้านทั้งสามแบบของหมู่บ้านเดอะเซ็นโพรังสิตเฟสสอง โดยซึ่งเพิ่มกลไกการป้องกันการรั่วซึมของน้ำให้กับบ้านรูปแบบปรับปรุงใหม่ใหม่นี้ด้วย

จุฬาลงกรณ์มหาวิทยาลัย
CHULALONGKORN UNIVERSITY

สาขาวิชา	การออกแบบสถาปัตยกรรม	ลายมือชื่อนิติต
ปีการศึกษา	2562	ลายมือชื่อ อ.ที่ปรึกษาหลัก

6073702625 : MAJOR ARCHITECTURAL DESIGN

KEYWORD: Joinery design, Precast concrete joint, Precast concrete wall system, Water leakage

Prokchol Vataniyobol : ARCHITECTURAL JOINERY DESIGN TO PREVENT WATER LEAKAGE IN A
PRECAST CONCRETE DETACHED HOUSE. Advisor: PAT SEEUMPORNROJ, Ph.D.

The precast concrete construction is widely used in Thailand by customers and developers for residential development. For many decades of building with the precast concrete wall system, the common problems of water leakage are the most pressing concerns. This thesis aims to find the issues that lead to the causes of water penetration and propose a solution to prevent water leakage. From the literature review, the sources of water leakage are at the connection location between the precast modules. The water can penetrate through the opening with the four forces: a momentum of the raindrop, capillary action, gravity, and air pressure. This thesis categorized the precast concrete joinery into three types of a one-stage joint, a two-stage joint, and a drain joint. The experiment on water infiltration was conducted based on the two leading forces of water leakage with water on the surface test for gravity force and a water spray test for the raindrop momentum (wind-driven rains). The six precast concrete wall modules are setup where three modules do not have a scarf detail, and three modules had a one-way scarf detail. The result shows that the most efficient joinery types are the one-stage joint but, due to the high chance of defection, make the joint more likely to cause water leakage. The second useful joinery is a drain joint with scarfs details with the lowest change of temperature on the two water tests. The research finding of this thesis is used for redesigns the Centro Rangsit village(phase 2) which is a two-story detached house. The project used a precast concrete wall system. The redesign had implemented the modularity in space planning, the panels division that reduces the point of connection, and incorporates the additional element to deflect and discharge the water away from the building surface. Based on the water infiltration experiment, the redesign integrates the scarf drain joinery types. This thesis proposed a redesign that improves the three house modules of the Centro Rangsit village(phase 2) that increases the water leakage prevention mechanism.

จุฬาลงกรณ์มหาวิทยาลัย
CHULALONGKORN UNIVERSITY

Field of Study: Architectural Design

Student's Signature

Academic Year: 2019

Advisor's Signature

ACKNOWLEDGEMENTS

I would like to express my very great appreciation to my thesis advisor Pat Seeumpornroj, Ph.D., for the advice and guideline throughout the research.

I would also like to extend my thanks to the Chairman of the Master of Architecture in Architectural Design (International Program), Associate Professor Pinraj Khanjanusthiti, Ph.D., and the committee members, Assistant Vorapat Inkarojrit, Ph.D., Assistant Professor M.L. Chittawadi Chitrabongs, Ph.D., and Chomchon Fusinpaiboon, Ph.D. for the knowledge that they given me in this master program. I would like to express my gratitude to the external examiner, Associate Professor Chawalit Nitiya, Ph.D., for his expertise and helpful comments.

I would like to offer my special thanks to Mr. Sathaporn Khamchoo, for the assistance with the preparation of my experiment and the collection of my data.

Finally, I wish to thank my family for their support and encouragement throughout my study. I would like to thank all my INDA and I+MArch classmates for their support and encouragement.

TABLE OF CONTENTS

	Page
ABSTRACT (THAI).....	iii
ABSTRACT (ENGLISH)	iv
ACKNOWLEDGEMENTS.....	v
TABLE OF CONTENTS.....	vi
LIST OF FIGURES	xi
LIST OF TABLES.....	xvii
CHAPTER 1	1
1. INTRODUCTION.....	1
1.1. Problem statement and significance	1
1.2. Purpose of the study.....	2
1.3. Scope of the study.....	2
1.3.1. Research framework.....	2
1.3.2. Program framework	2
1.3.3. Financial framework.....	3
1.4. The benefit of the study	3
1.5. Research methodology	3
CHAPTER 2	6
2. LITERATURE REVIEW	6
2.1. Water leakage problem in the precast concrete wall system	6
2.1.1. Sources of water leakage	7
2.1.2. Mechanism of water leakage.....	8

2.1.3. Terminology	9
2.1.4. Solution for water leakage	10
2.1.5. Type of joinery.....	11
2.1.5.1. One-stage joints.....	12
2.1.5.2. Two-stage joints.....	13
2.1.5.3. Drains joints	13
2.1.6. Joinery design factor	15
2.1.7. Additional elements to prevent water leakage	16
2.1.7.1. Water deflection elements	16
2.1.7.2. Water discharge elements.....	17
2.2. Literature review conclusion	19
CHAPTER 3	21
3. CASE STUDIES AND EXPERIMENTATION	21
3.1. Case studies	21
3.1.1. Case study on precast concrete joinery in Thailand.....	21
3.1.1.1. Selected case study 1: AP Thai.....	22
3.1.1.2. Selected case study 2: Prosperity Concrete Company	24
3.1.1.3. Selected case study 3: PCM Construction Material Company 28	
3.1.2. The joinery from literature reviews and case study.....	29
3.2. Experiment design	31
3.3. Experimentation on water infiltration.....	34
3.3.1. Test setup	34

3.3.1.1.	Surface flow tests.....	34
3.3.1.2.	Water spray tests	35
3.3.1.3.	Equipment for data collection.....	37
3.3.2.	Test factor	39
3.3.3.	Test results.....	42
3.3.3.1.	The three types of joints on a surface test	42
3.3.3.1.1.	One-stage joint	43
3.3.3.1.2.	Two-stage joint	44
3.3.3.1.3.	Drain joints	44
3.3.3.2.	The three types of joints on a spray test	45
3.3.3.2.1.	One-stage joint	46
3.3.3.2.2.	Two-stage joint	46
3.3.3.2.3.	Drain joints	47
3.3.3.3.	The three types of joints with scarf detail on a surface test	48
3.3.3.3.1.	The scarf one-stage joint.....	48
3.3.3.3.2.	The scarf two-stage joint	49
3.3.3.3.3.	The scarf drain joint.....	50
3.3.3.4.	The three type of joints with scarf detail on a spray test... 50	
3.3.3.4.1.	The scarf one-stage joint.....	51
3.3.3.4.2.	The scarf two-stage joint	52
3.3.3.4.3.	The scarf drain joint.....	53
3.3.3.5.	The perfect and the defected one-stage joint on the two water tests.....	53

3.3.3.5.1. The water on the surface test result	54
3.3.3.5.2. The water spray test result	56
3.4. Conclusion: Experiment	58
3.4.1. Case study in theory and in practice.....	59
3.4.2. The installation of the three-joinery type.....	59
3.4.3. The water test evaluation	61
3.4.4. The water movement behavior of the three-joinery type.....	62
CHAPTER 4	65
4. ANALYSIS OF THE WATER EXPERIMENT.....	65
4.1. Analysis: The three types of joints comparison	66
4.1.1. One-stage joint and two-stage joint comparison	66
4.1.2. One-stage joint and drain joint comparison	69
4.1.3. Two-stage joint and drain joint comparison	73
4.1.4. Perfect and defected one-stage joint comparison.....	76
4.2. Analysis: No scarf joint and scarf joint comparison	80
4.2.1. One-stage joint and scarfs one-stage joint comparison	80
4.2.2. Two-stage joint and scarfs two-stage joint comparison.....	82
4.2.3. Drain joint and scarfs drain joint comparison.....	84
4.3. Conclusion: Analysis	86
4.4. Cost Analysis.....	88
4.5. Synthesis of the most effective joint for water leakage prevention	89
CHAPTER 5	92
5. DESIGN PROCESS AND DESIGN IMPLEMENTATION	92

5.1. The Centro Rangsit two-story detached house development.....	92
5.1.1. Site analysis	93
5.1.2. Law and regulation	96
5.2. Space planning and panel division	98
5.2.1. Proposed Modules.....	105
5.3. Additional elements to prevent water leakage	109
5.4. Joint integration from the experimentation	111
5.5. Design implementation of the two-story precast concrete detached house 114	
5.6. Financial analysis.....	126
CHAPTER 6	128
6. CONCLUSION	128
6.1. Conclusion	128
6.2. Limitations of the study	129
6.3. Suggestions	130
REFERENCES.....	131
VITA	134

LIST OF FIGURES

Figure 1 Rain penetration mechanism, force associate with water leakage, and pressure equalization principle. Reprinted from Cheetham & Killip (1984), Chew & Silva (2003). ..9	
Figure 2 Diagram of categorization of wall system by rain control strategy. (Straube, 2010)..... 11	
Figure 3 The illustration of a one-stage joint. a. and b. reprinted from (Straube, 2007, 2016a, 2016b), c. reprinted from Killip and Cheetham (1984)..... 12	
Figure 4 The illustration of a two-stage joint. a. reprinted from Straube (2007, 2016b), b. reprinted from Killip and Cheetham (1984) 13	
Figure 5 The illustration of a two-stage joint. a. reprinted from, Straube (2007, 2016a, 2016b), b. reprinted from Killip and Cheetham (1984), c. reprinted from Committee and International (2017). 14	
Figure 6 The study of wall problem percentage vs. the width of the overhang above the wall..... 17	
Figure 7 The illustration of the drip edges that is applied to the horizontal surface. 19	
Figure 8 The Centro Rangsit project phase of construction. The data adapted from personal contact with Prosperity concrete company. 23	
Figure 9 The photograph from Prosperity Concrete Company factory visit..... 25	
Figure 10 Photograph from a PCM Construction Materials main factory site visit. 28	
Figure 11 The equipment used in the surface flow test and the installation to the test module before and during the test..... 35	
Figure 12 The equipment used in the water spray test and the installation before and during the test..... 36	
Figure 13 Bosch professional GIS 1000C equipment, product specification, and collected data reading. 37	

Figure 14 The Seek thermal Compact equipment and the example of the collected thermal image.....	38
Figure 15 An example of thermal image that mark the location of the connection area and structure components.	38
Figure 16 The spectrum of color shown in the collected thermal image that represents the difference in surface temperature.....	39
Figure 17 Change in temperature ($^{\circ}\text{C}$) of the three joints without scarf detail on a surface test.	67
Figure 18 Change in rel. humidity (%) of the three joints without scarf detail on a surface test.	67
Figure 19 Change in temperature ($^{\circ}\text{C}$) of the three joints without scarf detail on a spray test.	68
Figure 20 Change in rel. humidity (%) of the three joints without scarf detail on a spray test.	69
Figure 21 Change in temperature ($^{\circ}\text{C}$) of the three joints without scarf detail on a surface test.	70
Figure 22 Change in rel. humidity (%) of the three joints without scarf detail on a surface test.	71
Figure 23 Change in temperature ($^{\circ}\text{C}$) of the three joints without scarf detail on a spray test.	72
Figure 24 Change in rel. humidity (%) of the three joints without scarf detail on a spray test.	72
Figure 25 Change in temperature ($^{\circ}\text{C}$) of the three joints without scarf detail on a surface test.	73
Figure 26 Change in rel. humidity (%) of the three joints without scarf detail on a surface test.	74

Figure 27 Change in temperature (°C) of the three joints without scarf detail on a spray test.	75
Figure 28 Change in rel. humidity (%) of the three joints without scarf detail on a spray test.	75
Figure 29 Change in temperature (°C) and rel. humidity (%) of the perfect one-stage joint compared with the defected one-stage joints from a surface tests.	76
Figure 30 Change in temperature (°C) and rel. humidity (%) of the perfect one-stage joint compared with the defected one-stage joints from a spray tests.	77
Figure 31 The image was taken from the interior side (left) and the exterior side of the one-stage test module (right).	79
Figure 32 Change in temperature (°C) and rel. humidity (%) of the one-stage joint compared with the one-stage joint with scarf details on a surface test.	81
Figure 33 Change in temperature (°C) and rel. humidity (%) of the one-stage joint compared with the one-stage joints with scarf detail on a spray test.	81
Figure 34 Change in temperature (°C) and rel. humidity (%) of the two-stage joint compared with the two-stage joints with scarf detail from a surface test.	83
Figure 35 Change in temperature (°C) and rel. humidity (%) of the two-stage joint compared with the two-stage joints with scarf detail on a spray test.	84
Figure 36 Change in temperature (°C) and rel. humidity (%) of the drain joint compared with the drain joints with scarf detail from a surface test.	85
Figure 37 Change in temperature (°C) and rel. humidity (%) of the drain joint compared with the drain joints with scarf detail on a spray test.	86
Figure 38 The top view image (left) and front view image (right) of a one-stage joint.	90
Figure 39 The top view image (left) and front view image (right) of a scarfs drains joint.	90
Figure 40 The graphic illustration of the Avid, Bravo-A and Bravo-B unit in the Centro Rangsit housing development.	93

Figure 41 Site location on the satellite image (left) and the illustration of the surrounding sites with land use identification (right).....	94
Figure 42 The illustration of site boundary (left) and site accessibility (right).	95
Figure 43 The land use according to Ministerial regulations to enforce the city plan of Pratumthani city B.E. 2548 (2005).....	96
Figure 44 The land use according to ministry regulations, enforcing the Lamlukka Town Plan, Bueng-yitho, and the Pathumthani Province B.E. 2555 (2012).	96
Figure 45 The site boundary with a two-meter setback regulation.	97
Figure 46 ACI Standard – Building Code Requirements for Structural Concrete (ACI 318-19), 2019 sub-section 11.3.1 – minimum wall thickness.	98
Figure 47 Space planning that considers the modular system principle.....	102
Figure 48 The maximum length for the panel is 6 m due to restrictions in transportation law.....	103
Figure 49 Panels division that reduces the point of connection principle.	103
Figure 50 Design schemes for Avid unit grid planning.....	106
Figure 51 The selected maximum 6m-sized panels with extensions to the front with a full width of 6200mm.	107
Figure 52 Design schemes for Bravo unit grid planning.	108
Figure 53 The selected “maximum 6m size panels with extension to the front – full 6800mm width” and their adjustment to achieve a more modular approach.....	109
Figure 54 The overhang extension on the second-floor slabs of the integrated into the precast concrete floor slabs.	110
Figure 55 The awning angle variations of 5°, 10°, and 15° angles.	110
Figure 56 The flat-slab overhang (left) and a proposed 5° sloped overhang with drip edges (right).....	111

Figure 57 The joinery installation at the Centro Rangsit development. The walls to walls connection (left), the wall-to-slab connection (Middle), and a slab-to-slab connection (right). 112

Figure 58 The scarf details on the side of the panels (left) and the scarf drain joint details (right). 112

Figure 59 The illustration of precast concrete formwork of flat side panels and one-way scarf side panels. 113

Figure 60 Proposed design module drawing of an A1 unit foundation, floor slabs and precast concrete wall plan. 114

Figure 61 Proposed design module drawing of a A2 unit foundation, floor slabs and precast concrete wall plan. 115

Figure 62 Proposed design module drawing of a A3 unit foundation, floor slabs and precast concrete wall plan. 115

Figure 63 The selection for the opening dimension based on the existing Centro Rangsit opening. 116

Figure 64 Space planning for the proposed design of the A1, A2, and A3 unit. 117

Figure 65 Elevation drawing of the proposed design A1, A2, and A3. 118

Figure 66 Exploded axonometric of the building components in the proposed A2 units. 119

Figure 67 Illustration of a section cut location of A1, A2, and A3 unit. 120

Figure 68 Drawing of front section cut of A1 unit at section A-1, section A-2, section A-3 and a side section cut of A1 unit at section A-A, section A-B, and section A-C. 121

Figure 69 Drawing of front section cut of A2 unit at section B-1, section B-2, section B-3 and a side section cut of A2 unit at section B-A, section B-B, and section B-C. 122

Figure 70 Drawing of front section cut of A3 unit at section C-1, section C-2, section C-3 and a side section cut of A3 unit at section C-A, section C-B and section C-C. 123

Figure 71 The perspective view of the proposed module A-1 (The Centro Rangsit Avid unit redesign)..... 124

Figure 72 The perspective view of the proposed module A-2 (The Centro Rangsit Bravo-A unit redesign). 124

Figure 73 The perspective view of the proposed module A-3 (The Centro Rangsit Bravo-B unit redesign). 125

Figure 74 The perspective view of the proposed two-story detached house of The Centro Rangsit phase 2..... 125



LIST OF TABLES

Table 1 Research methodology	4
Table 2 Table of research problem with precast concrete building	7
Table 3 The table of water discharge element and the mechanism of preventing water leakage.....	18
Table 4 Categorization of joinery with characteristic and mechanism of water leakage prevention.....	20
Table 5 List of some precast concrete developer in Thailand	22
Table 6 List of some precast concrete manufacturers in Thailand	22
Table 7 The on-site study of connection type at the Centro Rangsit detached house....	24
Table 8 The connection of two wall panels from Precast concrete step-by-step (Yodpruktigarn, 2011)	27
Table 9 The combined research on joinery from the literature and the case study	30
Table 10 The table of the three-joinery categorization that was tested in this experiment with illustration and joinery details.	32
Table 11 Research and experiment design.....	33
Table 12 The illustration of the three test modules with the flat-side detail.....	40
Table 13 The illustration of the three test modules with the scarf detail.	41
Table 14 The table represented variances from a surface test of the three joints with no scarf details.	43
Table 15 The thermal image of a one-stage joint of the start to the end of a surface experiment.....	44
Table 16 The thermal image of a two-stage joint from the start to the end of a surface experiment.....	44

Table 17 The table represented variances from a spray test of the three joints with no scarf details.	45
Table 18 The thermal image of a one-stage joint of the start to the end of a spray experiment.....	46
Table 19 The thermal image of a two-stage joint from the start to the end of a spray experiment.....	47
Table 20 The thermal image of a drain joint from the start to the end of a spray experiment.....	47
Table 21 The table represented variances from a surface test of the three joints with a scarf details.	48
Table 22 The thermal image of a scarfs one-stage joint of the start to the end of a surface experiment.....	49
Table 23 The thermal image of a scarfs two-stage joint of the start to the end of a surface experiment.....	49
Table 24 The thermal image of a scarfs drain joint from the start to the end of a surface experiment.....	50
Table 25 The table represented variances from a spray test of the three joints with scarf details.	51
Table 26 The thermal image of a scarfs one-stage joint from the start to the end of a spray experiment.....	52
Table 27 The thermal image of a scarfs two-stage joint from the start to the end of a spray experiment.....	52
Table 28 The thermal image of a scarfs drains joint of the start to the end of a spray experiment.....	53
Table 29 The table represented variances from a surface test of the perfect one-layer joint compared with a defected one-layer joint.....	54

Table 30 The thermal image of a perfect and defected one-stage joint from the start to the end of a surface experiment	56
Table 31 The table represents variances from a spray test of the perfect one-layer joint compared with a defected one-layer joint.	57
Table 32 The thermal image of a perfect and defected one-stage joint from the start to the end of a spray experiment	58
Table 33 Three joinery test modules without scarf details.....	60
Table 34 Three joinery test modules with scarf details.....	61
Table 35 The table of collected data of 0 minutes and 5 minutes of the experiment.	62
Table 36 The illustration of water movement on the three-test module and the effect from water temperature.	63
Table 37 The framework of analyzing the six-test modules.....	65
Table 38 The table of data was collected from defected one-stage, joint image, thermal image, temperature collected from connection, and temperature at the location of the leaks.....	78
Table 39 The table of all three types of joinery and scarfs three types of joinery in summery with the relative temperature.....	87
Table 40 The cost analysis of joinery materials in one meter of connection.	89
Table 41 Illustration of the Centro Rangsit Avid units wall panel plans and elevation...	100
Table 42 Illustration of the Centro Rangsit Bravo-B units wall panel plans and elevation.	101
Table 43 The table analyzing the Centro Rangsit existing grid and connection points.	104
Table 44 The total number of Precast elements in The Centro Rangsit Avid and Bravo Units.....	105

Table 45 The total length of the external joint in The Centro Rangsit Avid and Bravo units	105
Table 46 Material cost per meter for the Centro Rangsit development and the proposed scarf drain joint	126
Table 47 The total length of connection in the Centro Rangsit first-phase houses and the proposed modules	126
Table 48 The total joinery cost per house in the Centro first phase house modules and the proposed modules A-1/A-2/A-3	127



CHAPTER 1

INTRODUCTION

This chapter is the preface to the research question and research plan. The topic of the study is discussed, that is, precast concrete panels and the problems of water leakage in detached houses. This chapter also provides an outline of the methods to study water infiltration in precast concrete panels.

1.1. Problem statement and significance

The current precast concrete wall panels took more than ten years to be accepted in Thailand among customers and developers (Lim, 2016). They have now been used in all types of residential construction. However, in the literature review, it was found that home buyers have several problems and concerns. The most common issue is water leakage problems. Many water leakage problems are confined to the connection between panels and between a panel and another object. The key to designing precast panels that protect against rain penetration is to pay special attention to the point of connection.

What are the solutions in architectural joinery design to achieve zero rain penetration in precast concrete detached houses? This thesis researches and tests selected factors on precast concrete joinery to find the most efficient joint to prevent water leakage. The unit of analysis for the thesis are joinery types, module types, and the number of joints. The architectural factor for joinery is separated into four different categories: type of joints, joint materials, scarf details, and width and depth of joints. The types of joints and scarf detail are the crucial variables of an architectural factor in joinery that will be used to experiment on the properties of water infiltration. The two tests to study the joinery mechanism are the water on a surface test and the water spray test. The thesis will analyze each variable to understand the water leakage mechanism caused by each factor. The data from the experiment will lead to the understanding of water behavior, joinery mechanism, and behavior and effectiveness of the joinery in preventing water leakage. The most effective joint is combined with the change in module design will create zero-rain penetration joinery in the precast concrete wall system.

1.2. Purpose of the study

This thesis proposes a design solution for a precast concrete connection to prevent water leakage. It aims to reduce or eliminate the possibility of water entering the house. The research in the architectural designing of a precast concrete wall is combined with the water infiltration experiment. The outcome of the research purposed a solution to reduce water leakage problem.

1.3. Scope of the study

This thesis mainly focuses on water leakage problems of precast wall system in a single-detached house. According to the National Statistical Office Census and Housing Research 2010, it is stated that 72.6% of Thailand's population lives in detached houses. This thesis will focus on detached houses in order to serve this apparent demand for detached housing in the country. The researcher will study a two-story detached house. The water leakage problem within the load-bearing wall of a precast concrete house will be studied. The scope of the study is on the architectural design factors for the connection of the precast panels. The aims are to research and to find a current solution and theoretical principle that can be applied to improve the modules for reducing water leakage.

1.3.1. Research framework

This thesis considered water infiltration as the initiation of a water leakage problem; therefore, a sign of water infiltration in precast concrete joints is a critical problem. The researcher studied the behavior and the mechanism of water penetration at the joints of the precast concrete panels. The framework is created by the literature review on the topics related to water leakage in precast concrete panels and an on-field case study with an expert in the precast concrete industry. The framework is used to set up an experiment to test the chosen joinery. The framework is also used to understand the behavior of water and the mechanism of water leakage.

1.3.2. Program framework

The researcher will use the existing program and layout of the selected two-story detached house at "The Centro Rangsit" as the design framework for the thesis. The project had three housing types for this housing development at Klong 4, Pathum-Thani province. The total area of the site is 96,908 sq.m., with the first phase of 135 single-detached houses entirely constructed. The thesis will redesign the joinery for the three-housing typology with research specifically on water leakage in precast concrete panels. In addition, the thesis will improve on the precast concrete panels from the existing design of this housing development.

1.3.3. Financial framework

The thesis will analyze the cost of the joinery installation of the selected joints to compare the financial aspect for all housing types. The financial analysis will represent a feasible approach for the selection of joinery for future use.

1.4. The benefit of the study

The study will integrate water leakage solutions for the joinery into the precast concrete walls with a new module design. The improvement of the precast wall will increase rain protection for the building. The research will provide an architectural guideline in joinery for designing precast concrete modules in the future.

1.5. Research methodology

The research methodology for this thesis is a literature review on joinery to find the architectural design factor to create zero-rain penetration precast concrete wall panels. The literature review on joinery is research to identify factors for joinery design and to understand the precast concrete modules design. The second research section looks at the problem regarding water leakages in precast concrete buildings. This thesis will determine the mechanism of water penetration and the locations of leakages. The purpose of the literature review is to understand different approaches to solving water leakage problems in precast concrete buildings. The source of the problem needs to be identified so that the change in design and construction can be improved. The research also studies the additional elements that increase the water leakage prevention to the system. All the research sections will be combined to redesign the precast concrete module that will be less susceptible to rain penetration. The joinery research also includes a case study from the precast concrete manufacturer in Thailand. The current joinery used in the precast concrete industry will identify the conventional techniques for joinery in Thailand. Moreover, it will be used as a guideline in conducting a test on the two factors of joinery design: type of joints and scarf details (Table 1).

Table 1 Research methodology

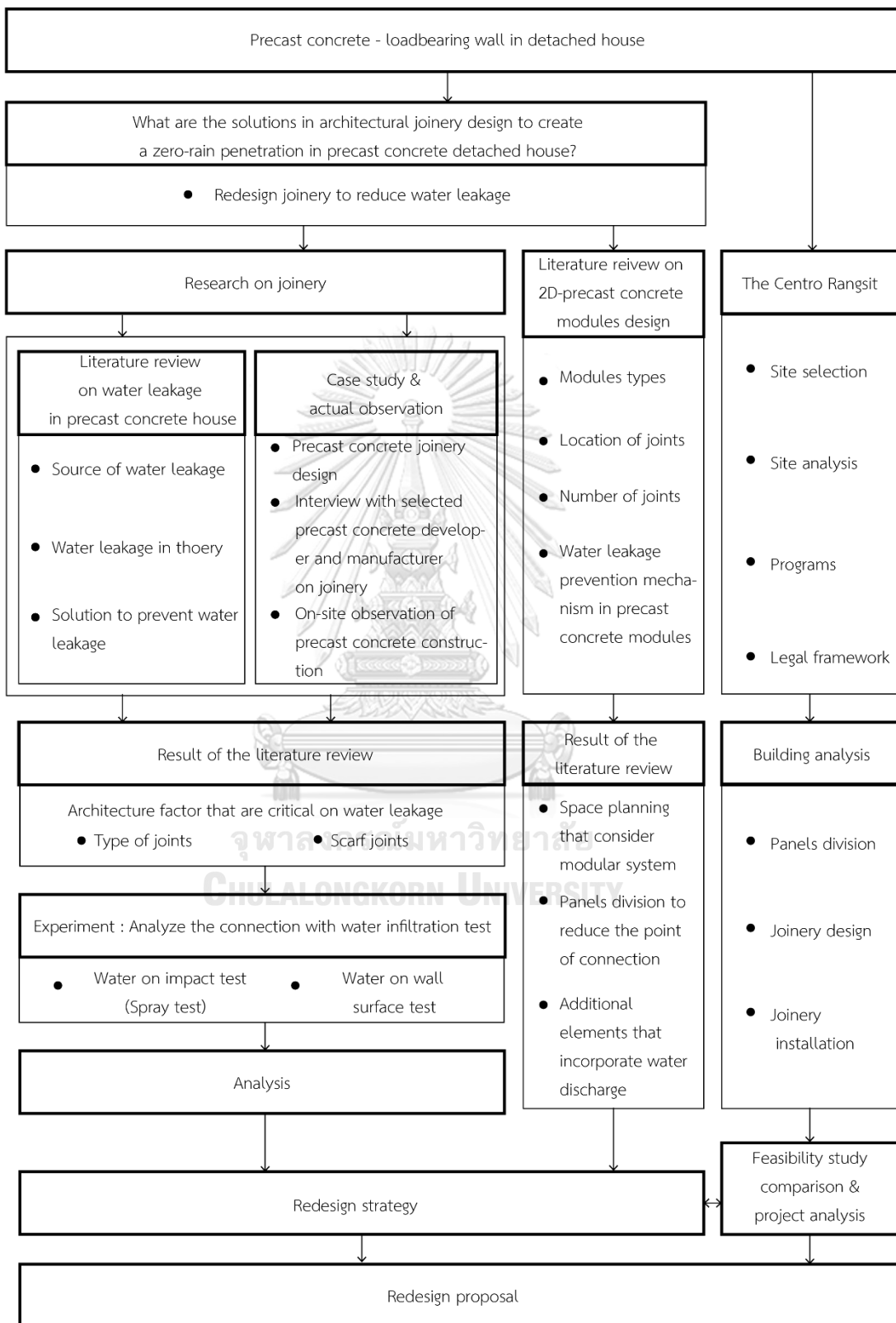

The experiment will be conducted with physical testing on a different precast concrete connection. The physical testing for water leakage on a precast concrete joint is a spray test and water-on-the-surface test. The experiment will be testing the two main factors, which are the type of joints and scarf details. The waterproof test for precast concrete walls is based on ASTM E-2128 (Standard Guide for Evaluating Water Leakage of Building Walls). ASTM International is the standard organization that is formally known as the American Society for Testing and Materials. The experiment is trying to replicate the evaluation technique proposed in the ASTM E-2128. The water-on-the-surface test is done by running the water from the top and past the connection. This test is using gravitational force to push the water through the connection. The test will be controlled by using the same amount of volume of water. The thesis will test the water infiltration with a water spray test for the water on impact evaluation. The water spray test is like a wind-driven kinetic force that is one of the leading forces that cause water leakage. The experiment applies the same force mentioned in the standard to each of the two-testing technique. The two tests for evaluating water leakage efficiency on a selected precast concrete connection are a water on a surface test and a spray test.

After the experiment, the synthesis of the outcome will determine the most efficient joinery design for limiting water leakage. The site is based on the selected case study of "The Centro Rangsit" from AP Thai developer. The total area of the project is 96,908 sq.m, and the site is divided into two phases of construction. The first phase was entirely constructed with 135 detached houses, and they are currently working on the construction of phase two. The thesis will redesign the modules division and the joinery detail for the second phase. The research includes the studies of site location, site analysis, legal framework, design program, and feasibility study. The redesign improved the quality of water leakage prevention mechanism to the existing house modules.

CHAPTER 2

LITERATURE REVIEW

The chapter explores, through literature reviews, the topics of precast concrete, joinery design, and water leakage problems. The research is on terminology, theory, application, and examples for three topics. These literature reviews form the guideline for the study in Chapter Three and Chapter Four. The research performs as a design-criteria for the selected site and detached house design in Chapter Five.

2.1. Water leakage problem in the precast concrete wall system

The literature review on water leakage related to the precast concrete building was studied to identify the sources and the reason that caused the problems. Killip and Cheetham (1984) stated that half of the defect after the analysis was dampness; the cause of which was from rain penetration (54%) and water condensation (35%). The two factors introduced in *Canadian Building Digest (CBD)* that were the roots of the problem were water and temperature differences (Garden & Canada, 1967). There are two types of joint applications: wet joints or dry joints. The wet joint application refers to the process of connecting the joints in a wet process. The wet joint process includes grouting with a non-shrink cement mixture and injecting polyurethane foam (PU) or any liquid mixture. The dry joint process includes bolted joints and welded joints. The two techniques require the steel to be installed into the precast wall panels; and during the panel's placement, the connection should be screwed together for the bolted joint, or the steel plate should be welded together for the welded joint. Regarding the issues of controlling the water, rain, and water vapor that are present in the air, moisture from wet joint installations can be treated as a temporary problem that does not harm the structure. The openings that allow water to enter can manifest in many different forms, such as pores, cracks, weak bonds, and at the joint (Chew & Silva, 2003). Small pores and cracks can be filled and covered with a coating or waterproofing material. The joints can be sealed with sealant material, but they need to be sealed correctly. A perfect seal is hard to accomplish due to the deflection from fabrication and job-site inaccuracies. A high-quality sealant could be used to reduce the stretching and contracting of the sealant. However, all sealants struggle to maintain perfect joints because, as time passes, the quality and strength of sealants deteriorate (Table 2).

Table 2 Table of research problem with precast concrete building

References	Issues related to precast concrete	Source of issue
Baan-lae-suan (2018)	Water leakage	Labor skill
Garden and Canada (1967), Latta (1967)	Presence of water inside a building	Joint / design
	Deterioration/ corrosion of metal connection between precast modules	Water penetration
	Deterioration of surface appearance	Rainwater
Chew and Silva (2003)	Water seepage/leakage	Porous structure Cracks Joints Penetrations
Other sources	Water leakage at the connection	Crack/opening The aging of sealant Imperfect application of seal Improper material for sealant

2.1.1. Sources of water leakage

The sources of water infiltration are one of the guidelines for redesigning joinery to fix the water leakage problem. Water penetration can occur at the discontinuities of the wall assemblies. The disassembly between material such as at the grout joint, cracked or broken material, sealants gaps, or blocked weep-hole in drain joint. Another water penetration source is the wall material, in which the material has absorbed the water, such as porous brick and concrete. The process of water passing through the material is call permeation. The factor of water permeation should be considered in the design phase.

The three factors that determine the water direction and movement are gravity, surface tension, and wind velocity (wind speed and wind direction). Surface tension is the effect that makes water cling to the surface or move horizontally along the surface. This effect may cause the water to go into the area that may not be directly exposed to the rain. Wind-driven rain in some places has wind velocity higher than the gravitational force that, in this case, causes that water to flow sideways or upwards. Water can be transported with moving streams of air to penetrate through joints, cracks, or holes. The connection between horizontal and vertical surfaces can cause sheeting action on the vertical surface. Sheeting action or beading action is when the water pulls itself together to form a sheet of water on the surface. The area where water accumulates in the high amount on the horizontal joint is a more critical area for water penetration (Committee & International, 2017).

2.1.2. Mechanism of water leakage

The research for water leakage is to understand the process that leads to water infiltration. The mechanism of rain penetration (Garden & Canada, 1967) first consists of water on the wall, a hole through which water can pass, and a force to move it inward (Figure 1). The forces that push water inward are the momentum of the raindrop, capillarity, gravity, and air pressure. Garden and Canada (1967) elaborated on the problem of strain in that the joint width needs to increase to allow for deformation, but, with a larger joint, more sealant would be required. This was another problem concerning the sealant's sagging. The concrete had pores smaller than 0.01 millimeters, and this was only able to draw in a small amount of water, which didn't contribute to the water penetration. However, large openings of cracks and unsealed gaps created significant impacts on the problems. The penetration could be stopped with air gaps or a discontinuity at the capillary, joint, and wall. The gravity mechanism acts on the opening passage that leads downward and inward, which refers to vertical joint and surface irregularity. The overlap of the surface can prevent water penetration through gravity (i.e., water falling or seeping down). Similarly, for water momentum, the air gaps and discontinuity will prevent any inward flow into the building. The effect of gravity can be checked on the overlapping areas of the components. This prevents an unintentional path of water flowing into the building. The momentum pushes water through large openings, and, if the opening is small, the raindrop will be shattered, and the water will continue inward. The momentum of the raindrop could be halted with the implementation of design elements, such as battens, splines, baffles, interlocks, and labyrinths. The illustration for pressure equalization is shown in Figure 1.

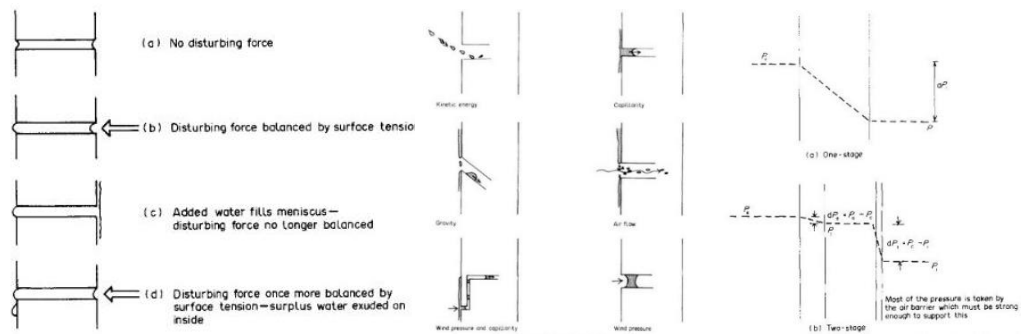

Figure 1 Rain penetration mechanism, force associated with water leakage, and pressure equalization principle. Reprinted from Cheetham & Killip (1984), Chew & Silva (2003).

The illustration to the right shows that the pressure differs within the surface of one-stage joints and two-stage joints. The more gaps there are between the line, the higher the force will be pushing the water into the building. The exterior is the most important location because the outer wall is the surface that first encounters all the rain.

2.1.3. Terminology

The terms and definitions related to water leakage are according to the inspection standard in ASTM E2128-17: Standard Guide for Evaluating Water Leakage of Building Walls (Committee & International, 2017).

Incidental water is referred to as “an unplanned water filtration that penetrates beyond the primary barrier and the flashing or secondary barrier system, with such a limited volume that it can escape or evaporate without causing adverse consequences”.

Water absorption is “a process in which a material takes water through its pores and interstices and retains it wholly without transmission”.

Water infiltration is “a process in which water passes through a material or between materials in a system and reaches a space that is not directly or intentionally exposed to the water source”.

Water leakage is “uncontrolled water; it exceeds the resistance, retention, or discharge capacity of the system; or causes subsequent damage or premature deterioration”.

Water penetration is “a process in which water gains access into a material or system by passing through the surface exposed to the water source”.

Water permeation is “a process in which water enters, flows, and spreads within and discharges from a material”.

2.1.4. Solution for water leakage

According to Straube (2010), rainwater that deposited on the wall can be drained (rain bounced off from the surface or surface drainage), stored (absorbed or attached by surface tension), and transmitted (water penetration or infiltration). The diagram below is based on the actual wall behavior to the rain control strategy. The wall system is made up of both wall joints and wall panels (element). The two broad categories are perfect barriers and imperfect barriers. A perfect barrier is a wall that is wholly sealed or a wall that is solid with no gap or opening. A perfect barrier can be a seal that is on the external face (a face seal) or a seal that is concealed in between the walls. This approach relies on the assumed perfection of the single plane of material and its ability to completely resist water penetration. In theory, the precast concrete panels are a perfect barrier, but the connection at the joints is an imperfect barrier. The research on joinery is more related to the imperfect barrier category. A mass joint is a type of joint that absorbs water into the joint material. Therefore, in mass joints, the efficiency of water prevention depends on the mass of the material, as it does in grouted joints. Screen joints form a layer of protective devices that shield against rainwater. The two types of screen joints are drained joints and undrained joints. (Deposited water is drained when it comes through a screen but is removed by gravity.) The undrained joint performs like a perfect barrier in which a layer of material shields the concrete panels from rain. On the other hand, the drain joint had a layer of protective shield but allowed the water to penetrate the inner layer. The cavity is an open or filled space that helps gravitational drainage, airflow, and act as a capillary break. Vented design allows some degree of air to enter, whereas ventilated design allows a large amount of air to help dry the water vapor in the cavity. Pressure-moderated is a system that moderates pressure differences within the screen system. When the perfect moderation of pressure occurs, the general condition of pressure equalization is achieved. (Straube, 2010, 2016b) (Figure 2).

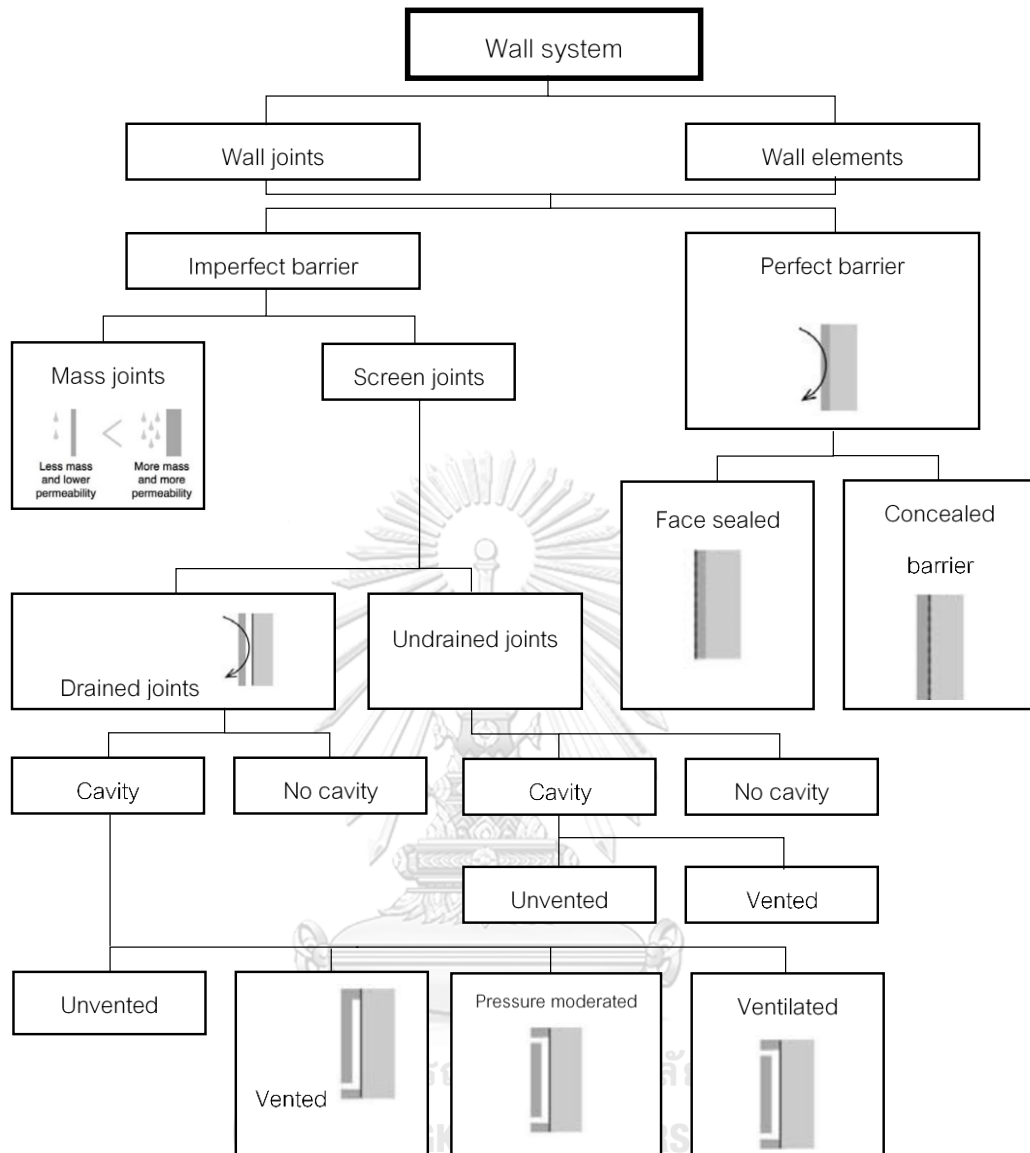

Figure 2 Diagram of categorization of wall system by rain control strategy. (Straube, 2010)

2.1.5. Type of joinery

The literature review on the proposed solution from other researcher and their mechanism to prevent water leakage in precast concrete panels are as follows: From the research, (Garden & Canada, 1967) proposed an open rain screen on the outer layer that integrates an air chamber into the joints, which are an adaptation of traditional methods. Furthermore, from the research of CBD—Garden and Canada (1967), Chew and Silva (2003) provide detailed research on designing with pressure equalization principle to reduce the air pressure from pushing the water into the building. The three designs for rain prevention aim to provide drainage for water, redesign of joints, and rain screen walls. Water can leak through both the horizontal and vertical planes. A simple one-stage joint

is an overlapping of elements and completely seals an unwanted opening. The hole must be completely sealed to prevent rain penetration. On the contrary, multiple layers are separated where any opening is not critical for rain penetration.

The joints for water tightness can be categorized into three basic types: one-stage, two-stage, and drainage joints. Each type has a different characteristic, installation, appearance, and mechanism to protect against water penetration.

2.1.5.1. One-stage joints

One-stage joints are also known as face-sealed joints. They are the simplest and the easiest for installation. A one-stage joint has an imperfect barrier where the air and rain barriers occur at the exterior side of the façade (Figure 3). The most common example of a one-layer connection is a grouted fresh mortar with or without any sealant materials. The joint's water prevention depends on the quality of sealant materials, the condition of joint surfaces, the quality of field installation, and the overall wall design. This approach has no second layer of water control hidden in the connection. The main element is visible from the surface. The identification of a one-stage joint system is that there will be no visible drainage hole (weep hole) in the external sealant.

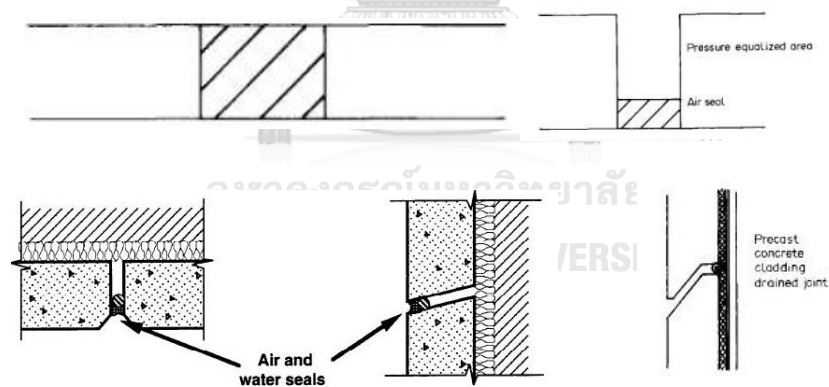

Figure 3 The illustration of a one-stage joint. a. and b. reprinted from (Straube, 2007, 2016a, 2016b), c. reprinted from Killip and Cheetham (1984).

The water prevention mechanism of the barrier wall is blocking the water movement to the interior. There are two walls within the barrier wall categories: mass barrier and face-sealed barrier. The mass barrier relies on wall material and thickness, in which the wall material may absorb or let the water through. Therefore, the wall must have enough thickness and high absorption to prevent water infiltration. The face-sealed barrier mechanism relies solely on the exterior layer. All joints are

continuously sealed on all exterior barriers and control the absorption properties of the wall material. This mechanism can also add a water-resistant secondary system in some locations to prevent incidental infiltration. The joinery had been discussed in John Straube's precast concrete and rain penetration article (Straube, 2007, 2016a, 2016b), the water leakage in precast concrete panels ASTM standard (Committee & International, 2017), a journal article by Killip and Cheetham (1984) discuss the mechanism of water leakage of a one-stage joints. The example of second layer incorporation proposed in Committee and International (2017) has adhered exterior insulation finishing system (EIFS).

2.1.5.2. Two-stage joints

The two-stage joint is a two-layered seal with a separate water seal and air seal (Figure 4). The two-stage joints make the connection more waterproof, improving with the second line of sealant. The recess gap of the inner seal and the outer seal create an air seal that helps reduce temperature difference and act in the reduced pressure difference between exterior and interior.

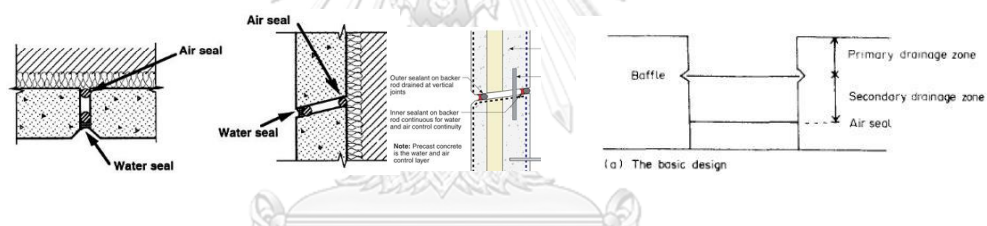

Figure 4 The illustration of a two-stage joint. a. reprinted from Straube (2007, 2016b), b. reprinted from Killip and Cheetham (1984)

The two-stage joint has the characteristic of being face-sealed where the external surface is completely sealed. The joint is a seal of sealant on the outer surface that is backed with backer rods. The air seal can also act as an insulation layer. The typical two-layer backer rods seal is mentioned in Committee and International (2017) and rain controls article from Straube (2007, 2016b). The two layers but with one-layer backer rod and an intercept barrier called baffle panel are discussed in Straube (2016a) and Killip and Cheetham (1984).

2.1.5.3. Drains joints

Drains joint is a two-stage joint with a drainage plane and drainage gap. The essential identification of this system is the visible weep hole on the exterior surface. The weep hole is the gap for the rainwater to enter and exit. The rain control approach that allows some water to penetrate through the external surface (screen surface) and directs the water back out to the external surface. The water is drained out by gravity from the designated drainage plane to the flashing or weep holes.

Killip and Cheetham (1984) suggest a basic design to improve the joint between precast concrete to have an air layer gap, drainage area, and baffle. This system is also known as the rain-screen system. The traditional “rain screen principle” of the external cladding layer is based on the same principle as two-stage joints but with a more physical attachment to the exterior wall. The rain screen principle is a two-stage wall of external cladding, air gap, and the structural wall. The rain-screen outer layer is designed to intercept raindrops and drain the rain away from the wall's surface. The open rain screen principle has the advantage of rain penetration control and minimizes the problems arising from imperfectly sealed joints. As a result, the sealant life is extended due to there being less contact with solar radiation.

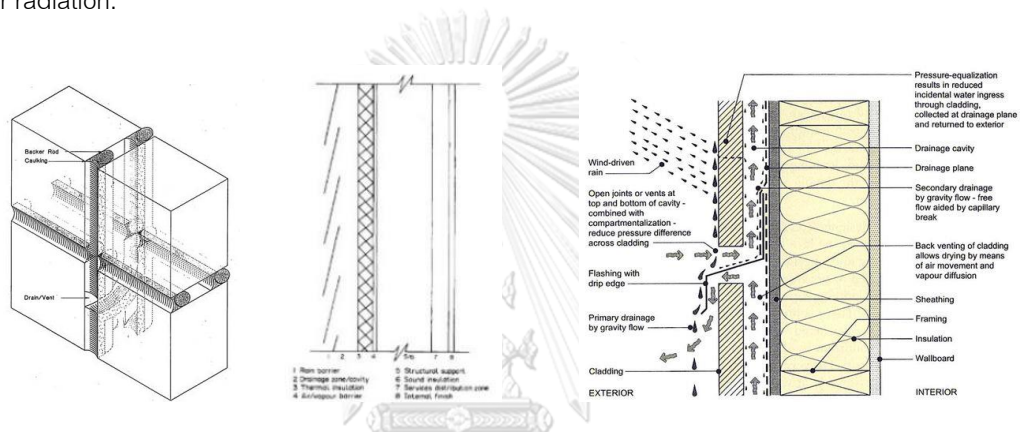

Figure 5 The illustration of a two-stage joint. a. reprinted from, Straube (2007, 2016a, 2016b), b. reprinted from Killip and Cheetham (1984), c. reprinted from Committee and International (2017).

Water-managed wall mechanism controls and discharges the anticipated water that penetrates the exterior surfaces. The water-managed walls can be sub-categorized into three systems: drainage walls, collection and retention walls, rain screen walls and pressure equalization walls. A drainage system allows the water to go into the provided cavity inside the system and, then, instantly discharge the water at the flashing or drainage area. The water behavior in this system is intended to move freely along the provided path. The criteria for this system are that the cavity must be wide enough to not cause water retention from the surface tension of water and must be clear of any obstruction that may block the water movement. The collection and retention system allow the water to go through the exterior surface like the drainage system, but it does not discharge penetrated water at the instance. The discharge of collected water is meant to provide a mechanism to redirect the collected water and drain to the exterior to the discharge area. The mechanism of this system is to control the collected penetrated water systematically. The system has a provided area to accommodate water or short-term water retention like, for example, cavity dams or reservoirs. The

discharge of water can be in any form, as some systems use evaporation to discharge the collected water as water vapor. The volume of water must not exceed the retention capacity of the system. Rain screen wall and pressure equalization is a system that integrates the concept that reduces the air pressure difference. This system decreases the amount of wind-driven rain that enters the system. This system, in theory, aims to achieve perfect equalization, which also means no pressure difference in any layer. These air leaks are a critical factor in this system because they reduce the effectiveness of pressure equalization that may result in water leakage. The mechanism of a water drain is shown in many articles such as in Straube (2007, 2016a, 2016b) and Committee and International (2017).

2.1.6. Joinery design factor

The design of the wall system and the condition of exposure must be understood. The exposed exterior surface of the wall system is the “first line of defense” against water penetration. However, the ability to resist water leakage does not depend on the first line of defense. The critical location of water leakage, which is at the intersection of the horizontal and vertical panels, can integrate a proper design and functioning of interface joinery, sealants, and closures between vertical and horizontal elements. The water leakage that may be caused by water on the surface can be stopped with a drip-edge design. The drip edge stops the flow of water from continuing to the unwanted area. The water vapor from the air can be stopped through the reasonable control of air movement. A combination of materials has to function together to provide water leakage protection. The factors that determine how the wall or system should function are anticipated volume of rain penetration, method of controlling rain penetration, location of barrier in the wall from joinery design, the interaction of all wall components, choice of materials, and the amount of exposure to wind pressure and rain.

The factors for designing joints are the type of joint, the number of joints, the locations of joints, the width and depth of the joints, the material selection, the joint size, and the architectural treatment (Canadian-Precast-Prestressed-Concrete-Institute(CPCI), n.d). The joint determines the design of the panels and the installation of the panels in the construction phase. Furthermore, identify the water prevention mechanism for the project. The process of segmentation of precast concrete panels during the architectural design should consider reducing the number of panels to lower the number of connections. The number of panels is related to the number of connections — therefore, controlling the panels can reduce the critical area of water penetration. The location of the joint

placement will determine the design of the joints and implementation technique. It is best if the joints are located at the maximum panel thickness because it will increase the water protection mechanism in the depth of the joint. The width and depth of the joints are other factors that consider the panel dimension, assembly tolerance, adjacent material, and a practical dimension of the selected sealant materials. An optional layer of architectural finishing for the precast concrete joints is a sealant. The sealant materials should be selected for its adhesion to the surface properties. The strong bonds create another seal that covers the joints. However, the sealant plays as an architectural finishing that protects the joint from direct contact to the sun and rain.

2.1.7. Additional elements to prevent water leakage

There are additional elements that can boost the mechanism of water leakage prevention. The rainwater can cause sheeting action on the precast concrete joint and surface. The external prevention that reduces the contact of rainwater has two main principles: water deflection and water discharge. The water deflection played a role in diverting the water from a wind-driven rain away from the building. Conversely, the water discharge's mechanism pushes the water that is already on the surface away from the building.

2.1.7.1. Water deflection elements

The water deflection element protects the building wall surface from direct rainwater. The mechanism deflects some water away from the building. The house walls have long exposure to rain, especially the wind-driven rain. The walls have an extreme exposure during annual rainy seasons, monsoons, and tropical cyclones. The amount of water deposited on the wall can be diminished using water deflection elements and building positioning. It is the first line of defense for the house in order to reduce water leakage problems. The study of wall problem in relation to the overhang length in "Rain Control in Buildings" article from the Building Science Digest journal (Straube, 2007 #38) show that the length of overhang can reduce the wall problem in the wall surface. A survey from British Columbia of a wood frame building shows that the width of a building's overhang is linked with the damage caused by rain. Overhang width is studied in order to understand wall problems caused by exposure to rainwater.

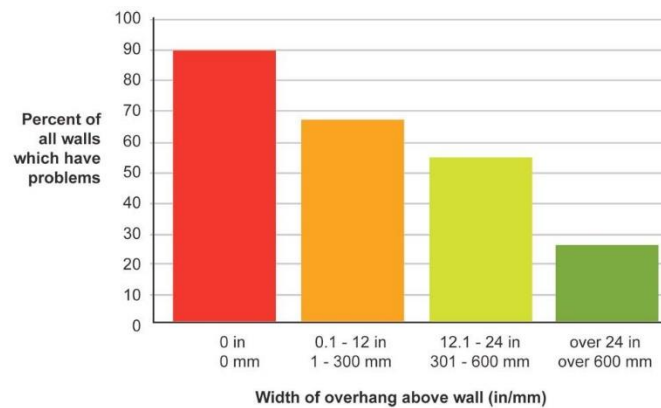

Figure 6 The study of wall problem percentage vs. the width of the overhang above the wall.

An overhang is an extension of the external surface of a building. The purpose of an overhang is to deflect rainwater away from the building. It also had an effect on wind flow in wind tunnel testing. A building with no overhang had 90 percent chance of wall problems. A building with overhang width of 1–300mm width had more than 60 percent chance, and a building with overhang width of 301–600mm had about 55 percent of the wall problems. A building with an overhang more than 600mm wide had about 28 percent wall damage. From these surveys, we conclude that the wall problems caused by exposure to rain can be reduced with an additional overhang element (Straube, 2007).

2.1.7.2. Water discharge elements

The literature review on solutions to improve water leakage shows that one prevention mechanism is to stop the water flow. The water can have a sheeting action that forms a sheet of water on the surface, which may lead to water infiltration at the accumulated area. The water discharge incorporation helps the precast concrete module to push the water away from the surface. The mechanism prevents more water from building on the surface.

The surface overlaps to allow the water to flow down and not into the system. The water discharge elements are battens, splines, baffles, interlocks, labyrinths, and drip edges. A batten's approach is to attach additional material onto the surface. The bump created by the material interrupts the water flow and bumps off some of the water on the surface. The splines and interlocks had the same approach. The spline's element is put in-between the panels to help conceal the gap between the panels. The interlocks system is incorporated on the panels in the same method as a scarf detail. The shape on the edge of the panels helps to lock the panels together. The baffle is defined as a device that refrains the flow of any material. On the panels, the baffle would intercept

the water flow. The baffle can be any texture, such as a flat surface or a wavy surface. The horizontal wavy surface of the baffle helps bounce off the rainwater. The labyrinth approach can be applied to the surface and on the connection area of the panels. The labyrinth is a pattern that creates a path for the water to flow. A good design of a labyrinth could discharge the water to the controlled area to reduce the water accumulation at the unwanted location. The drip edges are a very common approach that can be applied to the panel design. A drip edge is defined as a metal flashing or other overhang component that projects the water outward. It is to control the direction of dripping water and to protect the underlying part of the building.

Table 3 The table of water discharge element and the mechanism of preventing water leakage.

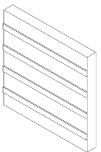
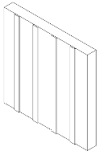
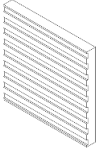
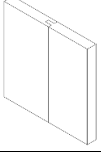
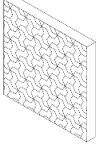
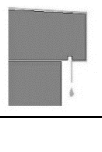
Water discharge elements	Illustration	Locations	Mechanism	Protect against
Battens		Panels surface	The bump on the surface interrupt the water on the surface flow.	Water sheeting action
Splines		Panels surface	The vertical strips that leads the water along the path downward.	Water accumulation.
Baffles		Panels surface	The bump on the surface interrupt the water on the surface flow.	Water sheeting action
Interlocks		Joint	The shape on the panels at the connection that intended to prevent water entry.	Water entry
labyrinths		Panels surface	The pattern on the surface can disrupt the water flow and lead the water to the designated location.	Water sheeting action and water accumulation
Drip edges		Overhang / roof / panels edge	Accumulate the water on the curved surface until it is heavy enough to drops to the ground.	Water sheeting action

The drip edge is an integration of an angle cut edge that discharges some water away from the building or the recess on the lower edge of the surface. The standard size for a water drip edge is 25mm – 75mm width; the thickness is typically 20mm – 25mm, and the depth of no less than 50mm (Paul, 2017).

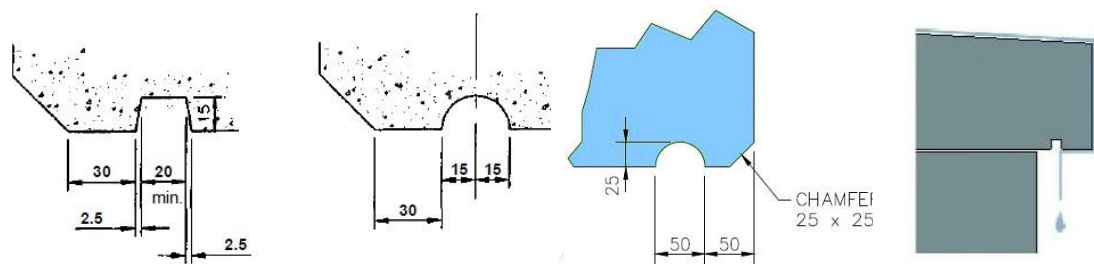

Figure 7 The illustration of the drip edges that is applied to the horizontal surface.

2.2. Literature review conclusion

The joinery research through literature reviews provides a basic guideline in the type of joints and techniques of each type of joint against water penetration. This thesis focuses on the joints of precast concrete panels in the properties of water leakage prevention. The joinery is summarized from the literature into four different types of joints (Table 4). The difference is in the layer of joint, application methods, material, and scarf details. The table categorizes and analyzes the mechanism of water leakage prevention with three forces associated with water leakage. The associated forces on the joint are the kinetic force, gravitational force, and capillary force. The water behavior in infiltrating the connection area and the understanding of forces that cause water leakage is used to studies the three types of joinery. The research on the architectural elements that heighten the system in preventing the water infiltration by water deflection and water discharge. The elements such as battens, splines and water drip edges can be easily added to the system.

The features in joinery to design a water leakage prevention joint can be listed into two main components, types of joints and scarf joints, which will determine the water leakage prevention mechanism. The type of joints identifies the water behavior when in contact with the connection system. Whereas for the scarf joint, the additional side details to the precast concrete panels cause changes to the connection system. These two factors will be used as a guideline in experimenting to test for water infiltration.

Table 4 Categorization of joinery with characteristic and mechanism of water leakage prevention

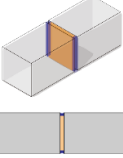
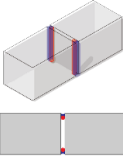
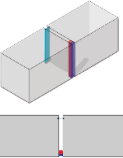
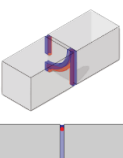
Type of joints	Joints	Location of joints	Type of applications	Joint materials	Scarf joints details	Water leakage prevention mechanism			Sources from the literature review
		(Vertical / Horizontal)	(Wet / Dry)		(Yes / No)	Kinetic force (Wind)	Gravity	Capillary	
One-stage		Vertical / Horizontal	Wet	Grout, sealant	No	✓	✓	X	Straube (2016a), Committee and International (2017), Kilip and Cheetham (1984), Straube (2016b), Straube (2007)
Two-stage		Vertical / Horizontal	Dry	Backer rods, sealant	No	✓	✓	✓	Committee and International (2017), Straube (2016b), Straube (2007)
		Vertical	Dry	Baffle panel, backer rods, sealant	No	X	✓	✓	Straube (2016a), Kilip and Cheetham (1984)
Drains		Vertical / Horizontal	Dry	Backer rods, sealant	No	✓	✓	✓	Straube (2016a), Committee and International (2017), Straube (2016b), Straube (2007)

CHAPTER 3

CASE STUDIES AND EXPERIMENTATION

The research in this chapter covers case studies and a water leakage experiment, including an exploration of a precast concrete panels system and the joinery system in a detached house. The thesis looks at the panel design, joinery type, joinery materials, and joinery details. The case studies part of the thesis is combined with literature reviews to conduct the water leakage experiment on selected joinery. This chapter provides data on selected joinery type, joinery material, and joinery details related to water leakage prevention. The methodology of the chapter is an experiment to identify the most efficient joinery to prevent water leakage.

3.1. Case studies

The case studies' objective is to study the joinery in the construction industry; the joinery in practice has improved over time. The case studies cover construction companies in Thailand. A selection of three companies will be studied, including the design phase, production phase, transportation phase, and installation phase. The research will also perform a closed study on the type of joinery used in practice. The research on case studies will be combined with the literature research to guide the selection of joinery in the analysis phase.

3.1.1. Case study on precast concrete joinery in Thailand

The precast residential project can be categorized into two main types of companies: developers and manufacturers. Developer companies do the design and are generally the owner of the project. Some developers do their production and construction up until the completion of the project. Manufacturing companies carry out the production part of the precast process. The design is assigned to the company to produce the formwork needed to manufacture the modules. They produce and deliver the modules to the construction site. In Thailand, there are various types of precast projects, from high-rise condominiums to detached houses. The case study selection criteria for developers include two-story detached house projects, use of precast 2D-panelized modules, and accessible information (Table 5). Similarly, the manufacturer's case study selection criteria are 2D-panelized module, two-story detached house projects, and accessible information (Table 6).

Table 5 List of some precast concrete developer in Thailand

Precast concrete developers	Pruksa Real Estate	Q-House	AP Thai	Land & Houses
Precast component	✓	✓	✓	✓
Precast 2D-panelized	✓	✓	✓	✓
Precast 3D-volumetric	PBU	-	-	-
High-rise project	✓	✓	✓	✓
Detached house	✓	✓	✓	✓
Self-manufacturer	✓	✓ (Some outsource)	✓ (Some outsource)	✓ (Some outsource)
Accessible to information	×	×	✓	✓

Note: The data adapted from Pruksa real estate, Q-house, AP Thai, Land & Houses website, and personal contacts. Retrieved from <https://www.pruksa.com/>, <https://www.qh.co.th/>, <https://www.apthai.com/th>, and <https://www.lh.co.th/th>.

Table 6 List of some precast concrete manufacturers in Thailand

Precast concrete manufacturers	Baan Thai Home Gold	SCG	PCM Construction Materials	Prosperity Concrete
Precast component	✓	✓	✓	✓
Precast 2D-Panelized	✓	✓	✓	✓
Precast 3D-volumetric	-	-	-	-
High-rise project	-	-	✓	✓
Detached house	✓	✓	✓	✓
Accessible to information	-	✓	✓	✓

Note: The data was adapted from Baan Thai Home Gold, SCG, PCM, Prosperity Concrete company's websites and through personal contact. Retrieved from <https://www.baanthaihome.com/>, <https://www.scg.com>, <http://www.pcm.co.th>, and <https://www.pros-concrete.com/>.

The three case studies were chosen from the basic criteria shown in Table 5 and Table 6. The selected case study for this thesis is AP Thai Company for the two stories, single-detached house project, the Prosperity Concrete Company, and PCM Construction Materials Company for the manufacturing of the precast 2D-panelized module for the case study.

3.1.1.1. Selected case study 1: AP Thai

The AP Thai Company core business is a developer on properties and projects. The housing development is a townhouse, condominium, and single-detached houses. There are many product brands that the company is developing. The Centro Rangsit project is one of the many single-detached houses in development under AP Thai. The design phase is done by the AP's

company and cooperates with Prosperity Concrete Company for a production phase (Figure 8). The Prosperity concrete company is a manufacturer of a precast concrete walls system. Prosperity's company is responsible for delivering the product to the construction site. In this project, the external contractor is responsible for the assembly phase (installation phase).

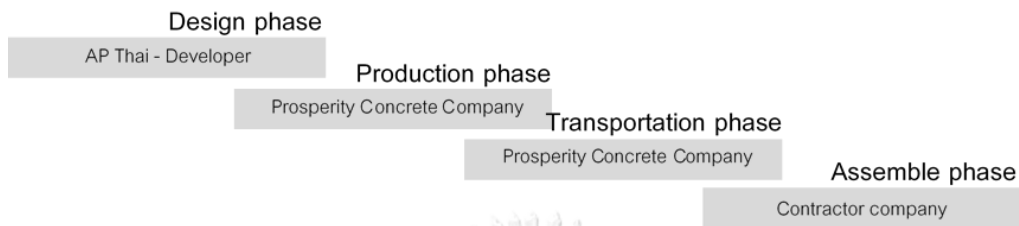

Figure 8 The Centro Rangsit project phase of construction. The data adapted from personal contact with Prosperity concrete company.

The Centro Rangsit project is located on Klong 4, Rangsit-Nakornnyok Rd. Bueng-Yi-Tho, Ampuer Thanyaburi, Pathum Thani, 12130. The total area of the project is 107,030 square miles, and the site is divided into two phases of construction. The project is a detached housing village with three housing types. The Avid unit is comprised of a three-bedroom, three-bathroom, detached house and a larger Bravo-A and Bravo-B unit with a four-bedroom, four-bathroom house. The project is currently in the second phase of construction. The first phase had 133 housing units that used load-bearing wall panels for structure and architecture walls for the interior room partitions.

The on-site process includes site preparation, such as groundwork, laying of foundations, and ground floor beams. Then, hollow core floor slabs are installed as well as a precast tray (bathroom tray) on the ground floor. The precast load-bearing walls were placed, and the steel plates were welded together. If the positioning was not properly aligned, the panels could be subsequently adjusted using a plastic plate. After this, the metal plates between the walls on the same plane and the metal plates between the perpendicular wall were welded. The contractor covers the connection with non-shrinking grout. After all the gaps have been grouted, the floor plate for the second floor is placed on top of the load-bearing wall. Then, the process is repeated (which involves positioning, welding, and grouting). There are two-sides for one joint; the exterior and interior finishing are for different requirements. The exterior surface is used to protect the inside from the rain and sunlight. The connection gaps for this project are 1 cm in length (Table 7).

The positioning accuracy per panel is 5 mm, which means some of the connections had a joinery gap close to zero millimeters. The installation of a grouted joint (a one-stage joint) requires at least 5 mm to fill the gap with a non-shrink mortar. When the connection gap is small, the mortar may not cover all the void area. These may lead to an unfilled opening in the joint.

3.1.1.2. Selected case study 2: Prosperity Concrete Company

The Prosperity Concrete Company was founded in 2001 in Ratchaburi province, Thailand. The concrete manufacturing company has precast products such as hollow-core floor slabs, floor slabs, precast fences, columns and beams, pre-stressed concrete product, and precast panels (Figure 9). The company produces a precast wall panel for all types of housing projects. The project covers single-detached houses, townhouses, low-rise condominiums, and high-rise condominiums.

Table 7 The on-site study of connection type at the Centro Rangsit detached house.

Location / Step	Before	After	Before	After
Exterior				
	Grouted the gap	Seal with sealant	Grouted the gap	Seal with sealant
Interior				
	Welded steel plate	Grouted and sealed	Welded steel rod	Grouted the gap

Note: The photograph is from on-site observation at The Centro Rangsit project by author.



Figure 9 The photograph from Prosperity Concrete Company factory visit.

The small ready-made precast concrete buildings, such as mini shops and mini houses, are under development for prosperity. The company published a book called *Precast Concrete Step-by-Step* (Yodpruktigarn, 2011) in collaboration with Mr. Therdtum Yodpruktigarn. The book is a general guide to construction with the precast concrete wall system. The book provides information and illustration of precast concrete in the entire construction process. The precast concrete production has four main stages: design, production, transportation, and installment. The precast piece must be designed and calculated before production. There are many factors to decide upon in the design phase, such as the dimensions (width/length/height/thickness), opening, reinforcement unit, a connection of member piece, and overall building structure. After the member piece design is complete, the next step is the design of the formwork to cast the member. The production phase is when the member piece is produced. The formwork is a mold for casting a concrete mixture. The preparation process is when the mold is cleaned and then oiled. The production process then continues with a reinforced steel placement; the system (piping) is installed, and the concrete

mixture is poured onto the formwork. A curing process determines the strength of the concrete. There are many techniques that can be applied to increase the strength and reduce the curing time, all of which vary in the requirement of the standard code. When the member piece is ready to be removed, the formwork is disassembled and removed from the member piece. The transportation comprises two phases, each having its own considerations; the first is where (and how) to transport the member piece to be stored, and the second is the method of transportation to the construction site. The transportation is planned by deciding the mode of transportation and appropriate route. The process also includes putting the member onto the mode of transportation and off again for the delivery. In the installation phase, the site needs to have space for equipment and a member piece. Then each member is placed onto the designed location. The member is placed and joined with another sealant mixture to cover the joint for the finishing process.

The design phase is the most crucial phase in determining the outcome of the building. Because it comprised of finished building design, module design, and connection design, the design phase starts from architectural design to structural design and the detailed design. The architecture design for the precast structure requires setting out the dimensions, height, and position. Basic information is needed in the construction process. The position of the foundation will act as a basic guideline for tanks and the piping location. That structure foundation will be aligned with the wall panels. The position should be distributed equally for balance and weight transfer to the ground. The design should take into consideration the floor-to-ceiling height because the precast concrete floor will be placed on top of the wall. The height may increase or decrease depending on the module's position and the thickness of the slab. It is recommended that for the load-bearing wall alignment, the panels touch both sides of the wall to prevent uneven weight distribution.

The joinery mentioned in this book can be identified into four types—side to side connection, cast structural connection, welded connection, and top to bottom connection (Table 8). The table below illustrated the joinery described in the book with the process of installation of each joint. The side-to-side connection used a one-stage non-shrink grouted technique with the sealant to cover the joint. The structural connection also uses the one-stage cast technique. The joint had metal rods cast into the precast concrete panel. When put together, the straight metal rod is inserted in the middle to link the two panels. The concrete formwork is installed to the connection, and then the concrete can be cast into the connection. The welded connection is used to link the two panels by welding the metal plate together. The metal plate is cast with the precast concrete panels. The panels are then

put in place, and the external metal plate is placed between the joint. The metal plate is then welded to connect the panels. The gaps between the panels then need to be grouted to finish the connection. The top-to-bottom connection is when the lower wall is connected to the upper wall. This connection is welded to lock the panels in place. Then the connection can be grouted (one-stage joinery technique) or sealed with a backer rod and sealant (two-stage joinery technique) (Table 7).

Table 8 The connection of two wall panels from Precast concrete step-by-step (Yodpruktigarn, 2011)

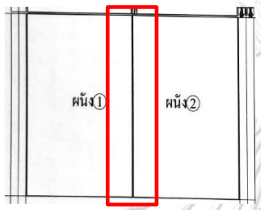
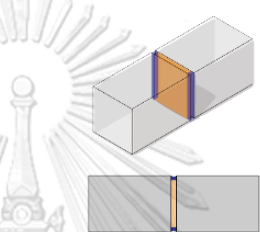
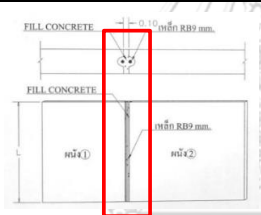
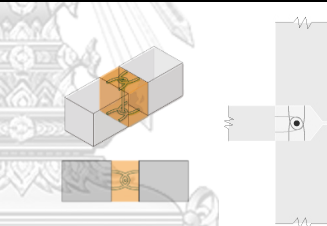
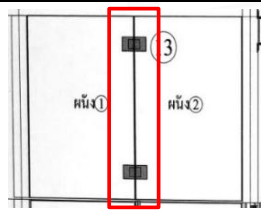
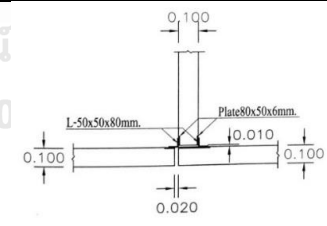
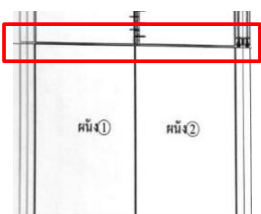
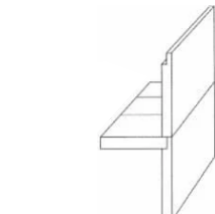
Type	Location of connection	Illustration of technique	Description/Note
Side-to-Side Connection			<ul style="list-style-type: none"> - Side-to-side connection - Grouted - Waterproofing with sealant
Cast structural connection			<ul style="list-style-type: none"> - The metal rods are placed in the panels. - Side-to-side connection - Metal backer rod locked all panels together - Cast with concrete
Welded connection			<ul style="list-style-type: none"> - The metal rods are placed in the panels. - Side-to-side connection - Welded together - Cover the gap with grout
Top-to-Bottom Connection			<ul style="list-style-type: none"> - The metal rods are placed in the panels. - Top-to-bottom connection - Welded the rod together - Grouted the gap

3.1.1.3. Selected case study 3: PCM Construction Material Company

The PCM Construction Materials Company Limited is a precast concrete products manufacturer. The company was established in 1984. Their products are made of pre-stressed concrete and include corrugated planks, concrete piles, glass-fiber reinforced concrete (GRC), precast concrete wall, and hollow core slab. PCM has 3 factories: PCM factory, NP1 factory, and GRC factory. The company produces a structural concrete product and an architectural concrete product (Figure 10). PCM offers a design service (design phase), a production phase, and transportation and structural installation services. The joinery design is selected by the project owner in collaboration with the PCM design team.



Figure 10 Photograph from a PCM Construction Materials main factory site visit.

The use of polyurethane foams in precast concrete joinery resulted in water leakage problems. The company uses non-shrink cement to fill the joinery. Joints often show crack lines at the connection point but no evidence of water leakage. Epoxy-based sealant is more common for this application.

The precast concrete formwork consists of a side-form and a block-out component. The division of panels is designed on the basis of aesthetic appearance on the outside and the installation process. The condominium project commonly uses two-stage joinery with backer rods and a polyurethane sealant. The two-stage joints are less vulnerable to water leakage because if the water enters the joint, the water cannot go into the inner seal. The water content left in the joint can evaporate over time. Meanwhile, for the houses, the company uses one-stage joinery. The process includes grouting with non-shrink cement to connect the precast concrete panels. As the polyurethane sealant is an oil-based product, when the housing development had to paint over the joinery area, the connection line is clearly visible. This is purely an aesthetic choice on the selection of joinery in housing development. The disadvantage of one-stage joinery is that a connection is more vulnerable to water condensation.

3.1.2. The joinery from literature reviews and case study

The combined research on joinery from the literature and the case study is concluded in Table 8. The different joints are categorized into three main types: one-stage, two-stage, and drain joint. The variation of joinery is an adaptation through time to get the most effective joint. The joint is designed to function according to the proposal in each project.

Table 9 The combined research on joinery from the literature and the case study

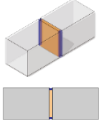
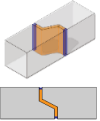
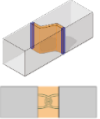
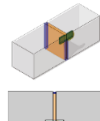
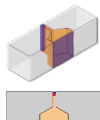
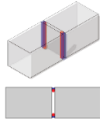
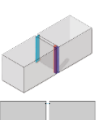
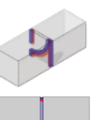
Type of joints	Joints	Location of joints	Type of applications	Joint materials	Scarf joints details	Water leakage prevention mechanism			Sources
		(Vertical / Horizontal)	(Wet / Dry)		(Yes / No)	Kinetic force (Wind)	Gravity	Capillary	
One-stage		Vertical / Horizontal	Wet	Grout, sealant	No	✓	✓	X	Straube (2016a), Committee and International (2017), Killip and Cheetham (1984), Straube (2010b), Straube (2007), Yodprukitgam (2011), PCM Construction Material company
		Vertical / Horizontal	Wet	Grout, sealant	Yes	✓	✓	X	Prosperity concrete company, Yodprukitgam (2011)
		Vertical	Wet	Grout, steel, sealant	No	✓	✓	X	Yodprukitgam (2011)
		Vertical	Wet	Grout, steel, sealant	No	✓	✓	X	The Centro Rangsit project
		Vertical	Wet	Grout, steel, sealant	No	✓	✓	X	PCM Construction Material Company
Two-stage		Vertical / Horizontal	Dry	Backer rods, sealant	No	✓	✓	✓	Committee and International (2017), Straube (2016a), Straube (2007), PCM Construction Material company
		Vertical	Dry	Baffle panel, backer rods, sealant	No	X	✓	✓	Straube (2016a), Killip and Cheetham (1984)
Drains		Vertical / Horizontal	Dry	Backer rods, sealant	No	✓	✓	✓	Straube (2016a), Committee and International (2017), Straube (2016a), Straube (2007)

3.2. Experiment design

The purpose of an in-depth study of a water leakage in a precast concrete panel is to understand the mechanism. The literature reviews are a guideline to the selection of crucial factors to a precast wall system. The selected factors that have significant effects on the water leakage protection are the joinery types and the scarf details of the connection. The joint is selected based on the joinery mechanism. The simplest design of the three categories is selected for the experiment. The selected joinery types are a one-stage joint, a two-stage joint, a drain joint, a scarf one-stage joint, a scarfs two-stage joint, and a scarfs drain joint (Table 9). The six types of joinery are casted into six different modules for the experiment on the water leakage prevention mechanism.

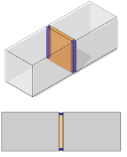
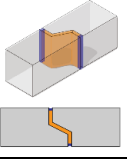
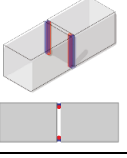
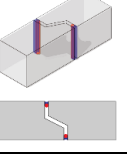
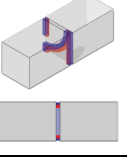
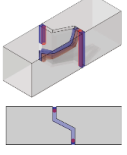
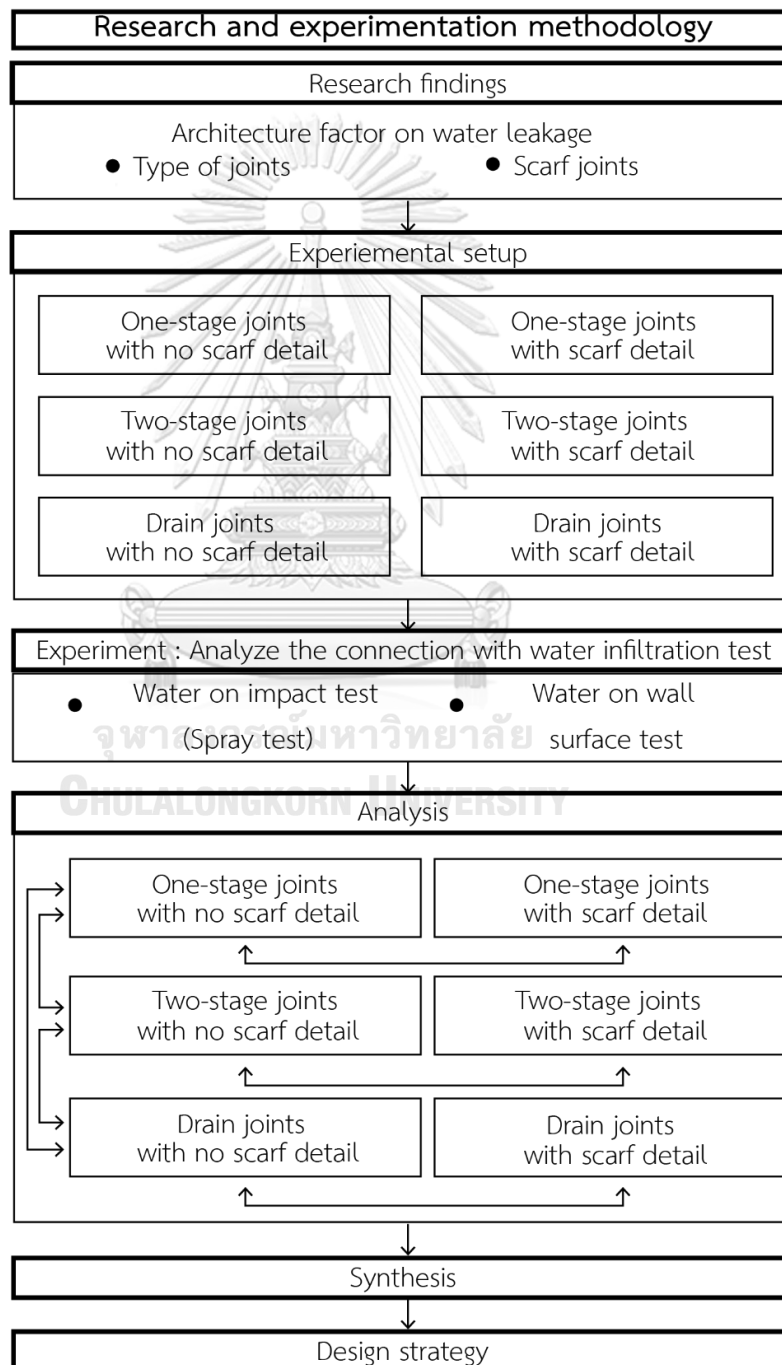

Table 10 The table of the three-joinery categorization that was tested in this experiment with illustration and joinery details.

Type of joints	Joints	Location of joints	Type of applications	Joint materials	Scarf joints details	Water leakage prevention mechanism			Sources
		(Vertical / Horizontal)	(Wet / Dry)		(Yes / No)	Kinetic force (Wind)	Gravity	Capillary	
One-stage		Vertical / Horizontal	Wet	Grout, sealant	No	✓	✓	X	Straube (2016a), Committee and International (2017), Kilip and Cheetham (1984), Straube (2010b), Straube (2007), Yodsprukitgam (2011), PCM Construction Material company
		Vertical / Horizontal	Wet	Grout, sealant	Yes	✓	✓	X	Prosperity concrete company, Yodonutigam (2011)
Two-stage		Vertical / Horizontal	Dry	Backer rods, sealant	No	✓	✓	✓	Committee and International (2017), Straube (2016b), Straube (2007), PCM Construction Material company
		Vertical / Horizontal	Dry	Backer rods, sealant	Yes	✓	✓	✓	-
Drains		Vertical / Horizontal	Dry	Backer rods, sealant	No	✓	✓	✓	Straube (2016a), Committee and International (2017), Straube (2016b), Straube (2007)
		Vertical / Horizontal	Dry	Backer rods, sealant	Yes	✓	✓	✓	-

This thesis aims to perform a test on these factors to study the joinery. The selected test is the water on the surface test and the water spray test (Table 11). The water on the surface test applies the gravitational force onto the water with the continuous flow of water onto the joint, whereas the water spray test applies a kinetic force from the water pressure that is sprayed onto the joint.

Table 11 Research and experiment design



The first analysis is comparing one joinery type with another joinery type to understand the mechanism: a one-stage joint with a two-stage joint, a one-stage joint with a drain joint, and a two-stage joint with a drain joint. The second analysis is comparing the three joineries with a scarfed detail: a one-stage joint with a scarfs one-stage joint, a two-stage joint with a scarfs two-stage joint, and a drain joint with a scarf drain joint. The comparison of the scarf joint is to identify the effectiveness of applying scarf detail to improve the water leakage prevention mechanism. The collected data after the analysis will be synthesized to select the most effective joint to apply to the design strategies.

3.3. Experimentation on water infiltration

This chapter provides details of the water test setup, the identification test factor, and the test result. The experiment follows the research methodology design derived from the literature reviews.

3.3.1. Test setup

The test setup is the formation of the test method adapted from the ASTM standard. The test equipment and the data collection equipment are identified. The test method is a surface flow test and a water spray test.

3.3.1.1. Surface flow tests

The surface flow test is a simulation of water on the surface that runs down on the precast concrete panels. The surface flow test criteria are to create a continuous film of water on the testing surface (Figure 11). This method test for the water with the gravitational force for the situation without wind-induced differential pressure (Committee & International, 2017). The water hose is punched to create a line of holes attached to a pipe. The water hose is connected to the water tap for water supplies. The rack is attached to the top front surface of the precast concrete panels. When the tap is turned on, the line of holes created a continuous film of water onto the tested surface. The water running down the surface is affected by the earth's gravity of 9.81 m/s^2 in acceleration. The test will let the water flow for thirty minutes, and the data is collected every five minutes. The data collected are surface temperature, relative humidity, observation at the joint, and thermal imaging. In addition, the researcher will also collect the thermography image to identify the change in temperature to identify the leakage location.

Surface flow test: equipment



Figure 11 The equipment used in the surface flow test and the installation to the test module before and during the test.

3.3.1.2. Water spray tests

The water spray test is to simulate the wind-driven rain or typical rain. The simulate wind-driven rain test is a method that produces the kinetic energy of the raindrops and the differential pressure caused by the wind. The simulation is a water spray test with a specific direction from the tested surface or a hydrostatic head to create pressure difference. The setup is a water hose that has installed a spray nozzle being attached to a rack or frame. The distance of the spray nozzle to the test area is marked on the rack at 50.8 cm (Figure 12). This research used a 4/7 mm brass atomizing nozzle that has a flow rate of 0.7 L/min (which is equal to 42 L/hr). The test uses four spray nozzles on the 0.5 m by 1 m test surface (only the joinery area) make the water spray rate equal to 336 L/m²/hr (liter per square meter per hour).

$$0.7 \text{ L/min} \times 60 \text{ min} = 42 \text{ L/hr}$$

$$0.5 \text{ m} \times 1 \text{ m} = 0.5 \text{ m}^2$$

$$42 \text{ L/hr} \times 4 \text{ spray nozzle} = 168 \text{ L/hr}$$

$$168 \text{ L/hr} \times 2 \text{ (convert } 0.5\text{m}^2 \text{ to } 1\text{m}^2) = 336 \text{ L/m}^2\text{/hr}$$

The standard water spray rate is normally between 195.73 L/m²/hr and 489.34 L/m²/hr, or an average of 244.67 L/m²/hr. The experiment spray rack exceeded the average rate and is within

the standard spray rate at 336 L/m²/hr. The control factors for the experiment are the amount of water, duration of the test, distance from the test surface to the spray-rack, and the equipment used for the test. The test will let the water sprays for 30 minutes, and the data is collected every 5 minutes. The data collected are surface temperature, relative humidity, observation, and thermography image. The calibrated spray-rack mentioned in the standard is to ensure that the water deposited equally to an area but, the calibrated test is for opening such as window and door. Therefore, the calibration is not necessary for the test conducted in this experiment, whereas the line of joinery was tested. The aligned spray head will ensure that area coverage of water deposited onto the test area. The distance mentioned in the standard is 50.8 cm (20 inches) away from the test surface.

Water spray test: equipment



Figure 12 The equipment used in the water spray test and the installation before and during the test.

3.3.1.3. Equipment for data collection

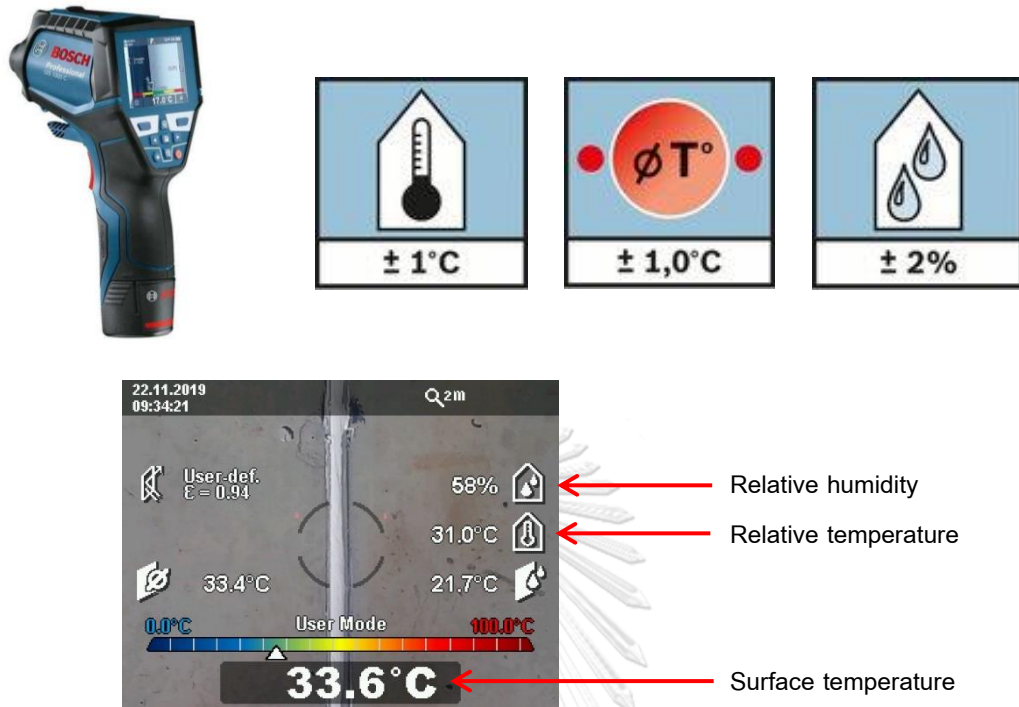

Figure 13 Bosch professional GIS 1000C equipment, product specification, and collected data reading.

The visual observation is the first data collection method that does not use any equipment. In addition to visual observation, the thesis used two professional equipment to collect more accurate data. The equipment to collect surface temperature and relative humidity is "Bosch professional GIS 1000C" (Figure 13). It is a piece of handheld thermal detector equipment that gives accurate measurements and recordings of temperature with ambient conditions. The temperature is collected in degrees Celsius (symbol: $^\circ\text{C}$). The relative humidity is measured in percent (symbol: %). This equipment's accuracy of measurement is $\pm 1.0^\circ\text{C}$ for ambient temperature, $\pm 1.0^\circ\text{C}$ for surface temperature, and $\pm 2.0\%$ for relative humidity.

The device for thermal image collection is a thermography camera called "Seek thermal Compact" (Figure 14). This device is an all-purpose thermal imaging camera that connects to an iOS device and captures temperature in the form of a visual image. The thermal image will show a clearer temperature difference on the tested surface and identify the location of water penetration.



Figure 14 The Seek thermal Compact equipment and the example of the collected thermal image.

The experiment will look at the change of temperature that happens at the connection of the precast concrete panels. The changes at the other part of the panels will not be taken into the sign of water penetration because the experiment is conducted to test the joinery of the precast concrete panels (Figure 15). In

Figure 16 shows the color spectrum of the collected thermal image. The color ranges from deep red to deep blue, where the deep red is the highest temperature, and deep blue is the lowest temperature. The equipment captures the thermal image by a range of the spectrum that does not specify the color as a temperature value. The temperature had to be compared to the legend on the left side of the image. The water temperature is lower than the temperature of the panels. Therefore, if the water enters the joint, the water temperature would transfer to the precast concrete panels. The sign of water infiltration will be represented in the format of the joint, changing the color to the deep blue range.

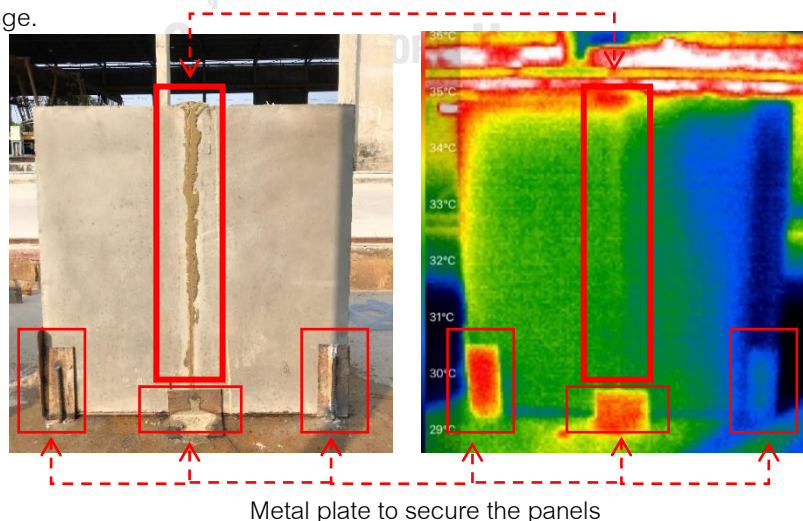

Figure 15 An example of thermal image that mark the location of the connection area and structure components.



Figure 16 The spectrum of color shown in the collected thermal image that represents the difference in surface temperature.

The technological types of equipment used to collect the experiment's raw data are a handheld infrared thermometer and a thermal imaging device. The collected data is controlled with the same equipment and the same setting. The collected data will be studied and correlated with the visual observation of water infiltration.

3.3.2. Test factor





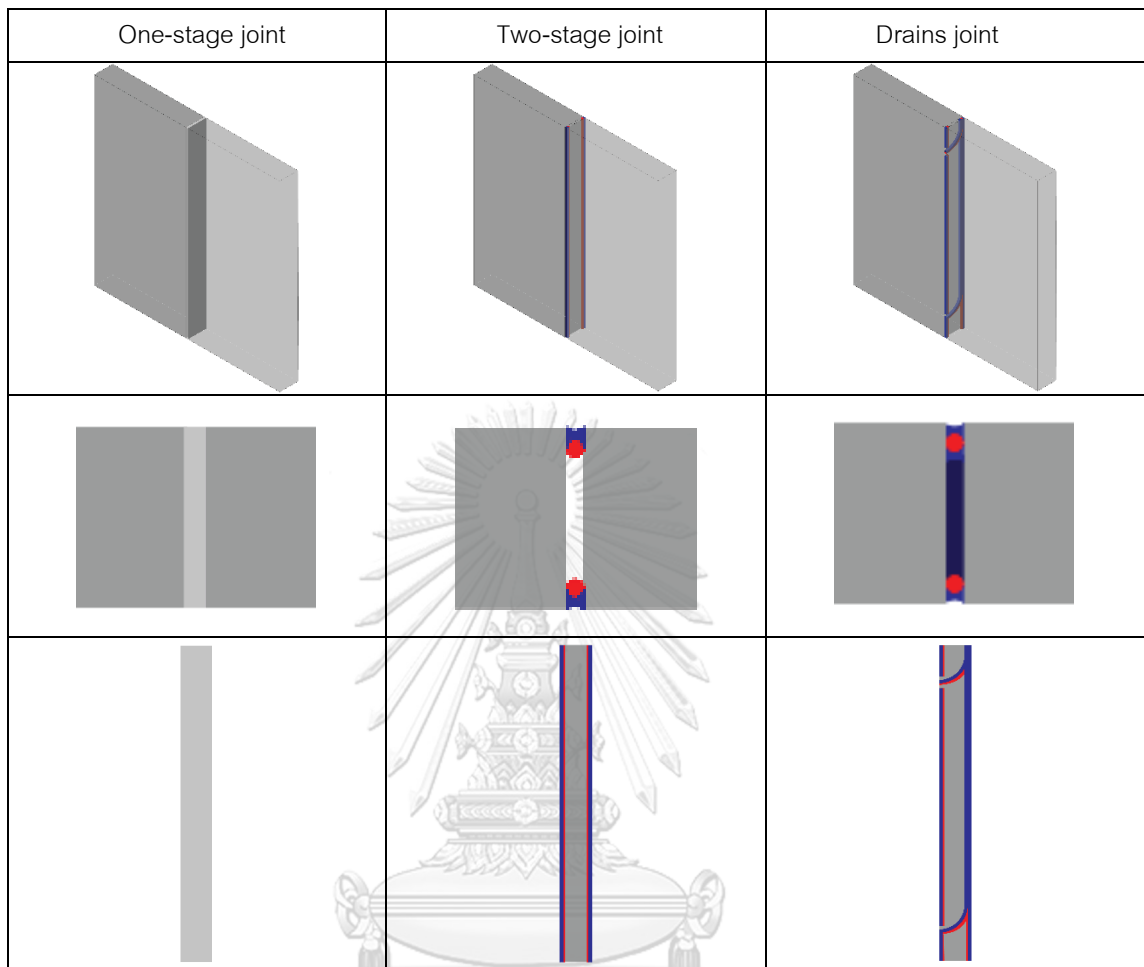

The type of joint test is on the stage of joinery, as reviewed in literature reviews. The test would identify the performance of the one-stage joint, the two-stage joint, and drain joints in terms of water protection (Table 12). One-stage joints are fully grouted with non-shrink mortar; these are classified as mass joints. The two-stage joints are composed of an undrained screen joint with a double seal screen (water-sealed and air-sealed). The drained joints are unique joints that act as screens to allow some water to enter the first layer and drain the water out through the provided weep hole (prepared water exit).

Table 12 The illustration of the three test modules with the flat-side detail.

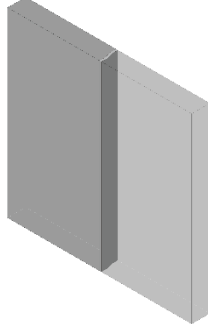
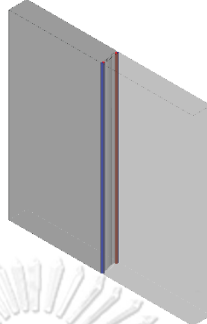
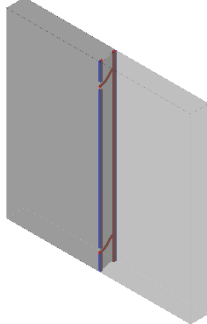

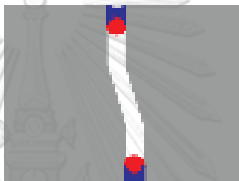
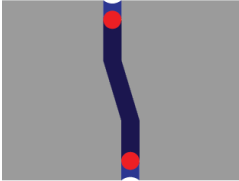
The experiment on the module detail at the connection is the scarf joint (Table 13). The shape of the connecting edge plays a part in the water infiltration mechanism. The test is on how much better it stops water from entering the interior of the building. This experiment compares a flat precast concrete panel with no scarf detail and one that has a one-way scarf detail that is lower on one side and higher on the other side.

Table 13 The illustration of the three test modules with the scarf detail.

One-stage joint	Two-stage joint	Drains joint
		
		
		

CHULALONGKORN UNIVERSITY

The test method is concluded to a two-water test to inspect how the joints affect the behavior of water, and how successful these joints function as a water prevention mechanism within the joints. The experiment was on two types of side details (flat-side and scarf side) and with six precast concrete modules. The data collection for the experiment consisted of visual observation of the water entry behavior and an infrared thermometer usage to identify the change in temperature possibly caused by water infiltration. The experiment results looked at the variance (different) values of the joints before the water infiltration experiment and the values after the experiment. These values were supported by the visual observation of watermarks on the surface during the experiment. The experiment's-controlled data included the precast concrete panel depth, which was 100 mm in panel

thickness; the equipment used for the water leakage experiment; and the equipment used for data collection.

3.3.3. Test results

The test results are collected and have an indication point that shows a sign of water penetration. The indication point is the lower in temperature detected by the handheld infrared thermometer, in addition to the change in color spectrum to a lower range (deep blue) in the thermal image captured by the thermal camera. The collected temperature result was compared with the visual observation of the connection area for signs of water penetration. Visual observation involves looking for water spots on the joints.

The experiment was performed on the three types of joints: one-layer, two-layer, and drain joints. The three precast concrete modules were tested using the water on the surface test and the water spray test. The experiment sought to collect data on surface temperature and relative humidity and observe the changes for 30 minutes. Decreases in surface temperature were used to identify water penetration. The crucial second identification was changes in relative humidity. An increase in relative humidity refers to an increase in water vapor in the air. Changes in relative humidity can have an effect on the surface temperature of an object. The collected data from the test was plotted into a column from 0 minutes to 30 minutes, which covered the whole length of the test. The rows will show the collected temperature value, the percentage of the humidity content, and the visual observation in a categorical format. The objective is to study changes in values that may be caused by water penetration. The thesis also looked at the co-relation of variance values that may represent water penetration. The co-relation that this thesis marks is when there is a drop in temperature at the same time as the increase in relative humidity contents. The relative humidity indicates how close it is for water to be saturated. So, the water vapor will be saturated to form water when the relative humidity is 100% (Sivaiah, 2016). Then the condensation of water on the internal surface may occur. The collected data is plotted in the table format with a one-by-one description in this chapter.

3.3.3.1. The three types of joints on a surface test

The first test is the water on the surface test with the three selected joints (one-stage joint, two-stage joint, and drains joint) that have a flat side surface (no scarf details). The test has shown no visual sign of water penetration on all three joints (Table 14).

Table 14 The table represented variances from a surface test of the three joints with no scarf details.

Layer of joint	Water on surface test						
	0 min	5 min	10 min	15 min	20 min	25 min	30 min
One - layer joint	0 min	5 min	10 min	15 min	20 min	25 min	30 min
Temp (°C)	33.3	33.2	33.4	33.7	34.2	34.7	35.4
Variance		-0.1	0.2	0.3	0.5	0.5	0.7
R. Humidity (%)	55	56	56	60	54	55	58
Variance		1.0	0.0	4.0	-6.0	1.0	3.0
Visual observation	No	No	No	No	No	No	No
Two - layer joint	0 min	5 min	10 min	15 min	20 min	25 min	30 min
Temp (°C)	43.4	43	43	43.7	42.4	41.9	41.7
Variance		-0.4	0	0.7	-1.3	-0.5	-0.2
R. Humidity (%)	48	48	52	48	50	49	49
Variance		0.0	4.0	-4.0	2.0	-1.0	0.0
Visual observation	No	No	No	No	No	No	No
Drains joint	0 min	5 min	10 min	15 min	20 min	25 min	30 min
Temp (°C)	45.3	44.8	44.4	44.2	44.1	43.3	43.4
Variance		-0.5	-0.4	-0.2	-0.1	-0.8	0.1
R. Humidity (%)	45	47	46	47	48	48	48
Variance		2.0	-1.0	1.0	1.0	0.0	0.0
Visual observation	No	No	No	No	No	No	No

3.3.3.1.1. One-stage joint มหาวิทยาลัย

The one-stage joint module tested with surface test shown one co-relation of decrease in temperature and an increase in humidity value that occurred at five minutes. The constant increase in humidity of 1% and 3% happened at twenty-five minutes and thirty minutes (Table 14). There was no visual sign of water penetration on this test module with this experiment.

The thermal image taken from zero minutes and thirty minutes was to compare the change that may happen at the joint. The thermal image had shifted in the color spectrum at five minutes, ten minutes, fifteen minutes, and twenty minutes. The thermal image also showed a higher color spectrum at the top corner in some images. The precast concrete panels might get heated up from the sunlight. However, there was no change in color on the joint, so there was no mark of water that infiltrates the connection (Table 15).

Table 15 The thermal image of a one-stage joint of the start to the end of a surface experiment.

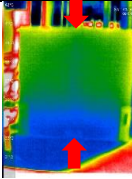
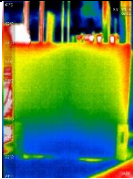
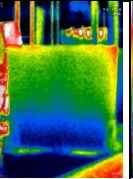
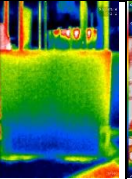
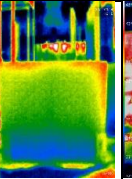
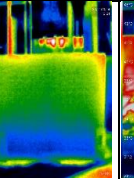
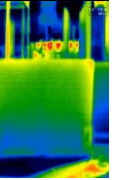
Surface test	0 min	5 min	10 min	15 min	20 min	25 min	30 min
Perfect One-stage							

3.3.3.1.2. Two-stage joint

The two-stage joint module represented one co-relation that happened at twenty minutes when the temperature dropped at -1.3°C , and the humidity increased by $+2\%$. However, five minutes after, the humidity dropped by -1% . The constant decrease in temperature happens at 20 minutes to 30 minutes of the test, from 42.4°C to 41.7°C (Table 14). Nevertheless, there is no visual sign of water penetration on this test module with this experiment (Table 16).

Table 16 The thermal image of a two-stage joint from the start to the end of a surface experiment

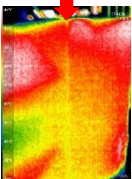
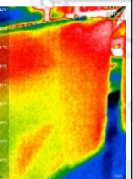
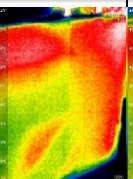
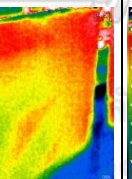
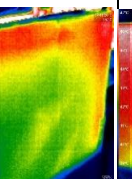
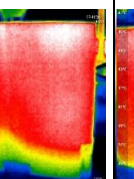
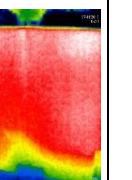
Surface test	0 min	5 min	10 min	15 min	20 min	25 min	30 min
Two-stage							

Despite the different angles of the captured thermal images and the different ranges of color represented in the table, there is no lower spectrum of color at the joint connection. The change in temperature only happens at the bottom of the panels in contact with the water.

3.3.3.1.3. Drain joints

The drain joint module data from the water on the surface shows three co-relations at 5 minutes, 15 minutes, and 20 minutes. The constant decrease in temperature happened from 5 minutes to 25 minutes. In addition to a decrease in temperature, the increase in humidity from 5 minutes is $+2\%$, -1% , $+1\%$, and $+1\%$. The humidity becomes steady at 25 minutes and 30 minutes of the test. There is no visual sign of water penetration for this test module of this experiment (Table 14).

The constant decrease in temperature of the drain joint can happen by the nature of the drain joint that allows the water to pass through the first layer. The inner layer of the drain joint has close contact with water. The temperature of the water (which is lower than the surface temperature) may have transferred to the backer rods in the joinery. The lower the temperature, the easier the humidity to rise. It does not require as much water vapor (moisture) to be saturated. Therefore, the water vapor humidifies faster in the colder temperature. The same content of water vapor in the air. When the temperature decreases, then the relative humidity increases. Furthermore, with the same water vapor content, an increase in temperature will cause the relative humidity to lower.

3.3.3.2. The three types of joints on a spray test

The second test on the three selected module is a water spray test. The experiment uses the water spray rack to distribute water onto the joints area of the test modules. The collected data are shown below in Table 17. The change in temperature is studied in terms of variance throughout the 30 minutes of the experiment. The three types of joints in the spray test experiment show no visual sign of water penetration.

Table 17 The table represented variances from a spray test of the three joints with no scarf details.

Layer of joint	Distribute spray test						
	0 min	5 min	10 min	15 min	20 min	25 min	30 min
One - layer joint							
Temp (°C)	35.8	35.9	36.2	36.5	36.7	36.4	36.5
Variance		0.1	-0.3	-0.3	0.2	-0.3	0.1
R. Humidity (%)	54	55	55	56	54	54	56
Variance		1.0	0.0	1.0	-2.0	0.0	2.0
Visual observation	No	No	No	No	No	No	No
Two - layer joint							
Temp (°C)	42	42.3	43	42	41.3	41	40.2
Variance		0.3	0.7	-1.0	-0.7	-0.3	-0.8
R. Humidity (%)	50	51	53	50	49	48	45
Variance		1.0	2.0	-3.0	-1.0	-1.0	-3.0
Visual observation	No	No	No	No	No	No	No
Drains joint							
Temp (°C)	41.4	40.8	40.7	39.5	38.9	38.2	37.5
Variance		-0.6	-0.1	-1.2	-0.6	-0.7	-0.7
R. Humidity (%)	49	50	54	52	53	53	54
Variance		1.0	4.0	-2.0	1.0	0.0	1.0
Visual observation	No	No	No	No	No	No	No

3.3.3.2.1. One-stage joint

The spray test on a one-stage joint module shows no co-relation that identifies water penetration both in temperature and humidity content. The lower temperature happens at 25 minutes with a drop of 0.3°C (Table 17). There is no visual sign of water penetration on this test module with this experiment. The thermal image shows no sign of water penetration. The lighter color spectrum shows an increase in temperature in all the surfaces of the panels (Table 18).

Table 18 The thermal image of a one-stage joint of the start to the end of a spray experiment.

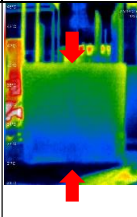
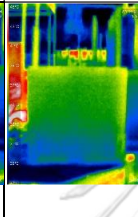
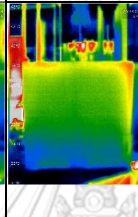
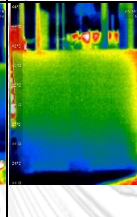
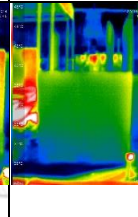
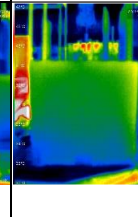
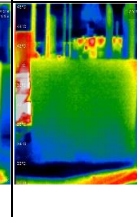
Spray test	0 min	5 min	10 min	15 min	20 min	25 min	30 min
Perfect One-stage							

The change of surface temperature at the top corners in 10 minutes and 15 minutes may occur due to the increase in surrounding temperature which is correlated with the increase in temperature in Table 17. The color spectrum errors do not affect the connection area on the test modules. Therefore, the collected thermal image can be read for the analysis.

3.3.3.2.2. Two-stage joint

There no co-relation for the two-stage joint in the spray test. The constant decrease in temperature happens from 15 minutes to 30 minutes in the test. However, the humidity does not represent an increase in water vapor content during these periods. The increase in humidity of 1% and 2% happens at 5 minutes and 10 minutes of the experiment, respectively (Table 17). Nevertheless, the temperature value does not match the data on any water leakage. There is no visual sign of water penetration on this test module for this experiment. The thermal image shows a lighter spectrum from the change in ambient temperature. The joinery area represents a lighter color of the spectrum, which shows that there is no sign of water penetration (Table 19).

Table 19 The thermal image of a two-stage joint from the start to the end of a spray experiment

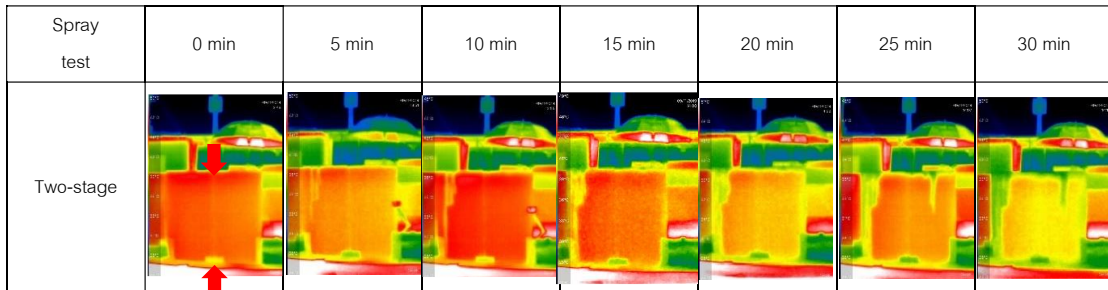

During the experiment, the water drips from the top of the tested panels due to water accumulation from the water test equipment installation. The water does not affect the experiment because it did not go to the connection area. The color spectrum of the precast concrete panels is from the surrounding temperature that causes the thermal camera to interpret it as shown in Table 19.

3.3.3.2.3. Drain joints

The test on the drain joint module had four occurrences of correlation of decrease in temperature and increase in humidity values at 5, 10, 20, and 30 minutes of the experiment. The data also showed a constant decrease in temperature values from 5 minutes to 30 minutes. The changes in temperature values are -0.6°C , -0.1°C , -1.2°C , -0.6°C , -0.7°C , and -0.7°C . The constant increase in humidity content is 1% and 4% at five minutes and ten minutes. And again, for 1% and 1% at 30 minutes and 30 minutes (Table 17). There is no visual sign of water penetration on this test module with this experiment and the thermal image at the joint area does not represent water entry marks.

The change in temperature spectrum on the top of the test module is the water accumulated from the equipment placement (Table 20). This causes the water to drip along the surface but does not pass through the connection area. Therefore, this incident does not affect the collected data.

Table 20 The thermal image of a drain joint from the start to the end of a spray experiment.

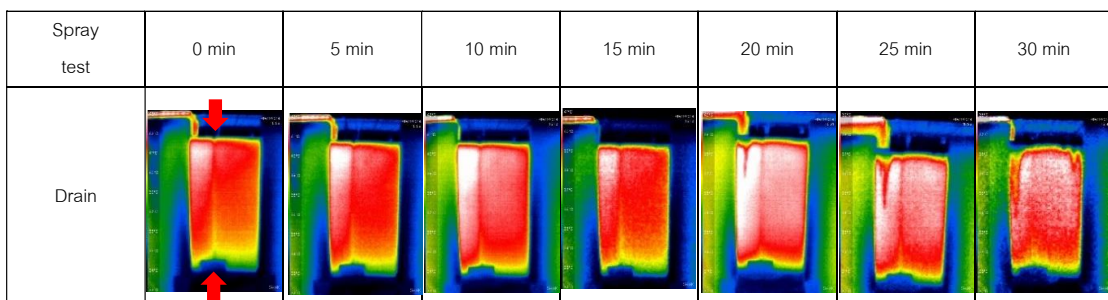

3.3.3.3. The three types of joints with scarf detail on a surface test

The three selected joinery designs are installed with a one-way scarf joint detail. The test is to analyze the scarf detail factor on the properties of the water prevention mechanism. The experiment will test the three modules on a two-water test using the same equipment as the module with no scarf detail. The experiment shows no visual sign of water penetration in the three modules for both surface and spray test. (Table 21)

Table 21 The table represented variances from a surface test of the three joints with a scarf details.

Layer of joint	Water on surface test						
	0 min	5 min	10 min	15 min	20 min	25 min	30 min
One - layer joint							
Temp (°C)	33.7	33.9	34.5	35.2	35	35.6	36.3
Variance		0.2	0.6	0.7	-0.2	0.6	0.7
R. Humidity (%)	76	76	71	68	69	67	67
Variance		0.0	-5.0	-3.0	1.0	-2.0	0.0
Visual observation	No	No	No	No	No	No	No
Two - layer joint							
Temp (°C)	30.3	30.5	30.8	31.5	31.8	32.2	32.5
Variance		0.2	0.3	0.7	0.3	0.4	0.3
R. Humidity (%)	64	67	66	65	66	67	66
Variance		3.0	-1.0	-1.0	1.0	1.0	-1.0
Visual observation	No	No	No	No	No	No	No
Drains joint							
Temp (°C)	30.1	30.4	30.4	30.8	31.3	31.6	31.8
Variance		0.3	0.0	0.4	0.5	0.3	0.2
R. Humidity (%)	67	69	66	66	66	64	66
Variance		2.0	-3.0	0.0	0.0	-2.0	2.0
Visual observation	No	No	No	No	No	No	No

3.3.3.3.1. The scarf one-stage joint

The test data of a one-stage module showed one co-relation at 20 minutes of the experiment with - 0.2°C and +1% in humidity (Table 21). There is no constant change that may represent water penetration in this experiment and no visual sign of water penetration on this test module with this experiment. The thermal image shows no significant change in color spectrum that leads to water penetration signs (Table 22).

Table 22 The thermal image of a scarfs one-stage joint of the start to the end of a surface experiment

Surface test	0 min	5 min	10 min	15 min	20 min	25 min	30 min
Scarfs One-stage							

The errors of the spectrum color range at 15 minutes are from the thermal camera errors. Despite the different range of color at 15 minutes, the thermal image overall shows an increase in temperature with the higher spectrum. The change of color spectrum at the connection area is from the increase in temperature of the environment.

3.3.3.3.2. The scarf two-stage joint

The two-stage module data showed no co-relation in the two-stage joint water on the surface test. There is an unstable change in humidity content from 5 minutes to 25 minutes of the experiment. The data showed +3%, - 1%, - 1%, +1%, and +1% accordingly (Table 21). There is no visual sign of water penetration in this test module with this experiment.

Table 23 The thermal image of a scarfs two-stage joint of the start to the end of a surface experiment

Surface test	0 min	5 min	10 min	15 min	20 min	25 min	30 min
Scarfs Two-stage							

The thermal image is captured in the direction of the sun, so the test modules are not exposed to direct sunlight. The outcome of the thermal image shows an overall deep blue color. The connection area's color spectrum in the thermal image does not show signs of water penetration (Table 23).

3.3.3.3. The scarf drain joint

The drain joint module result showed no co-relation in this test module. The humidity content in this experiment showed an increase of 2% at 5 minutes but later decreased by 3% at 10 minutes. Similarly, at 25 minutes, the humidity drops by 2% and then later increases by 2% at 30 minutes of the experiment (Table 21). There is no visual sign of water penetration on this test module with this experiment.

The thermal image, captured from the opposite direction of the sun, was a dark blue range. Additionally, the background has a higher temperature, which affects the color range generated from the camera. The thermal image shows an increase in surface temperature due to an increase in ambient temperature, but the connection area shows no sign of water penetration at the joint area (Table 24).

Table 24 The thermal image of a scarfs drain joint from the start to the end of a surface experiment

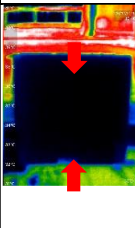
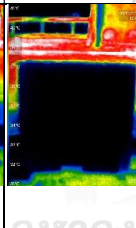
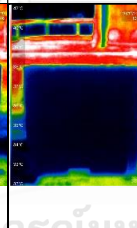
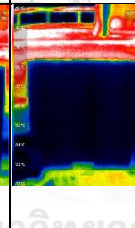
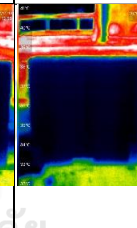
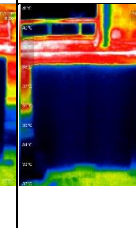
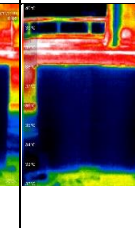
Surface test	0 min	5 min	10 min	15 min	20 min	25 min	30 min
Scarfs Drain							

3.3.3.4. The three type of joints with scarf detail on a spray test

The result of a water spray test on the three modules with scarf detail is studied. The three test modules showed no sign of water penetration based on the visual observation method. The table of collected data from the experiment is plotted below (Table 24).

Table 25 The table represented variances from a spray test of the three joints with scarf details.

Layer of joint	Distribute spray test						
One - layer joint	0 min	5 min	10 min	15 min	20 min	25 min	30 min
Temp (°C)	37.2	36.8	36.9	36.4	36.4	36	35.8
Variance		-0.4	0.1	-0.5	0.0	-0.4	-0.2
R. Humidity (%)	67	66	65	65	65	65	65
Variance		-1.0	-1.0	0.0	0.0	0.0	0.0
Visual observation	No	No	No	No	No	No	No
Two - layer joint	0 min	5 min	10 min	15 min	20 min	25 min	30 min
Temp (°C)	33.7	33.4	33.4	33.2	33	33.1	33
Variance		-0.3	0.0	-0.2	-0.2	0.1	-0.1
R. Humidity (%)	60	64	65	67	71	66	68
Variance		4.0	1.0	2.0	4.0	-5.0	2.0
Visual observation	No	No	No	No	No	No	No
Drains joint	0 min	5 min	10 min	15 min	20 min	25 min	30 min
Temp (°C)	32.4	31.9	32.2	31.8	32.1	31.7	32
Variance		-0.5	0.3	-0.4	0.3	-0.4	0.3
R. Humidity (%)	65	68	68	70	69	68	66
Variance		3.0	0.0	2.0	-1.0	-1.0	-2.0
Visual observation	No	No	No	No	No	No	No

3.3.3.4.1. The scarf one-stage joint

The one-stage module showed no co-relation in temperature and humidity values in this test. There was a constant change in temperature of -0.4°C and -0.2°C at 25 minutes and 30 minutes of the experiment (Table 24). Moreover, there was no visual sign of water penetration in this experiment.

The thermal image shows a lowering in overall temperature with a lower color spectrum. The color spectrum in the thermal image from the start to the end of the test shows no sign of water penetration (Table 26).

Table 26 The thermal image of a scarfs one-stage joint from the start to the end of a spray experiment

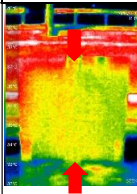
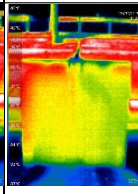
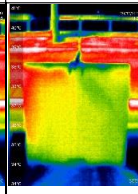
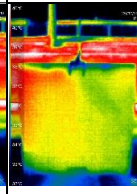
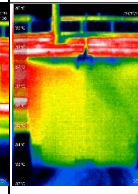
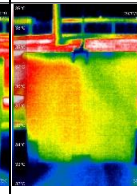
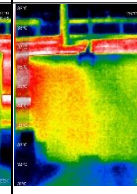
Spray test	0 min	5 min	10 min	15 min	20 min	25 min	30 min
Scarfs One-stage							

3.3.3.4.2. The scarf two-stage joint

The result showed four correlations of change in the two-stage module, which may represent water penetration at 5, 15, 20, and 30 minutes of the experiment. The constant decrease in temperature happened between 5 minutes and 20 minutes, from -0.3°C , 0.0°C , -0.2°C , and -0.2°C . The constant rise in humidity content also occurred between 5 minutes and 20 minutes. The recorded increases are 4%, 1%, 2% and 4% respectively. However, the collected data showed a sudden decline in the humidity of 5% at 25 minutes and an increase of 2% at 30 minutes (Table 24). These changes may represent an error in data collection and lead to unreadable data. There was no visual sign of water penetration on this test module in this experiment.

The thermal image represented an increase in surface temperature all over the panels. The water dripped from the top of the panels but did not affect the joint area. At the joint location, the joint surface had a lower temperature than the panel's surface. However, the thermal image showed no mark of water penetration (Table 27).

Table 27 The thermal image of a scarfs two-stage joint from the start to the end of a spray experiment

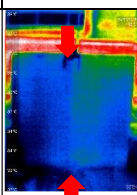
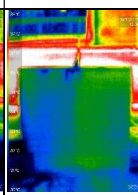
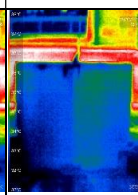
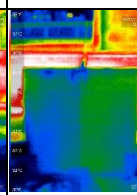
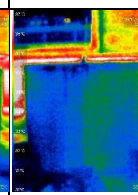
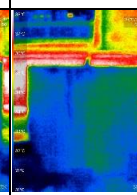
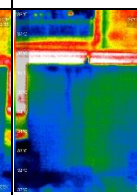
Spray test	0 min	5 min	10 min	15 min	20 min	25 min	30 min
Scarfs Two-stage							

3.3.3.4.3. The scarf drain joint

The test on the drain joint module represented two co-relations of change in temperature and humidity that happened at 5 minutes and 15 minutes. The change in temperature varied significantly throughout these test modules. There was a pattern of an increase in temperature followed by a decrease in temperature. The variances were -0.5°C , $+0.3^{\circ}\text{C}$, -0.4°C , $+0.3^{\circ}\text{C}$, -0.4°C , and change to $+0.3^{\circ}\text{C}$. The data showed an unstable change from the start to the end of the experiment. There were constant increases in the humidity of 3% at 5 minutes, with no change at 10 minutes and an increase of 2% at 15 minutes (Table 25). There is no visual sign of water penetration on this test module with this experiment.

The thermal image changed from a green spectrum to a deeper blue spectrum. This represents the lowering of surface temperature. Despite the error, in 15 minutes, the thermal image caused by the camera interprets the range of colors different from another image, the incidental water accumulation on the top of the module, and incidental drip from the left side. It does not affect the connection location. The thermal image shows no sign of water infiltration (Table 28).

Table 28 The thermal image of a scarfs drains joint of the start to the end of a spray experiment

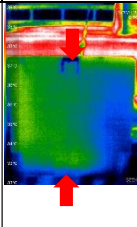
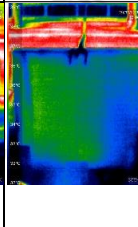
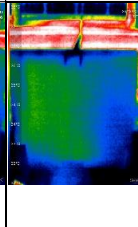
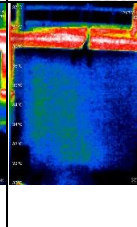
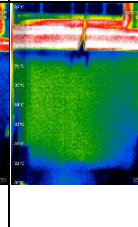
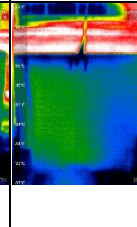
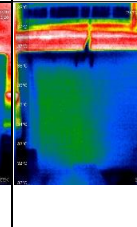
Spray test	0 min	5 min	10 min	15 min	20 min	25 min	30 min
Scarfs Drain							

3.3.3.5. The perfect and the defected one-stage joint on the two water tests.

The deflection in grouting mortar can occur during the installation of the precast concrete panels. This deflection may cause a crack line, unfilled gaps, or opening to the connection. The additional experiment on the fully grouted mortar (perfectly grouted mortar) compared with defected grouted mortar. During the experiment, the improper seal joint is shown a clear sign of water penetration. The collected data from both test modules are plotted into the table below. There is no visual sign of water penetration for the perfect one-stage joint module for the two water tests. On the other hand, the defected one-stage modules show a visual sign of water penetration in both tests.

3.3.3.5.1. The water on the surface test result

The water surface test on a defected one-stage module shows a visual water penetration at two-minutes into the experiment. The spray test also shows a water penetration sign after five-minutes. The thesis also collects the data at the location of the water penetration entry location to analyze the result. (Table 29)

Table 29 The table represented variances from a surface test of the perfect one-layer joint compared with a defected one-layer joint

One - layer joint	Water on surface test						
Perfect grout	0 min	5 min	10 min	15 min	20 min	25 min	30 min
Temp (°C)	33.3	33.2	33.4	33.7	34.2	34.7	35.4
Variance		-0.1	0.2	0.3	0.5	0.5	0.7
R. Humidity (%)	55	56	56	60	54	55	58
Variance		1.0	0.0	4.0	-6.0	1.0	3.0
Visual observation	No	No	No	No	No	No	No
Defected grout	0 min	5 min	10 min	15 min	20 min	25 min	30 min
Temp (°C)	46.9	45.9	46.5	45.7	45.3	45	44.2
Variance		-1.0	0.6	-0.8	-0.4	-0.3	-0.8
R. Humidity (%)	50	52	51	52	52	52	54
Variance		2.0	-1.0	1.0	0.0	0.0	2.0
Visual observation	No	Yes	Yes	Yes	Yes	Yes	Yes
Temp at leakage (°C)	46.9	42.9	41	40.2	39.4	38.8	38.2
Variance		-4.0	-1.9	-0.8	-0.8	-0.6	-0.6
Humidity at leakage (%)	50	53	49	52	53	53	55
Variance		3.0	-4.0	3.0	1.0	0.0	2.0

The variances on a perfect one-stage and a defected one-stage on a surface flow test are shown in Table 29. The perfectly grouted one-stage joint represents one co-relation at five minutes. The change at the co-related time is -0.1°C and $+1\%$ humidity values. The collected data shows no change in temperature from 10 minutes toward the end of the test. In contrast to the change in temperature, the change in humidity occurs from the beginning of the experiment. There is a change in humidity of $+1\%$ at five minutes, stable at 10 minutes, $+4\%$ at 15 minutes, with a sudden drop of -6% at 20 minutes, $+1\%$ at 25 minutes, and $+3\%$ at 30 minutes of the test. The result from 15 to 30 minutes represents an unstable change that may not be an identification factor of water penetration in the precast concrete joinery.

The collected data from the defected test module is acquired at two location points: the marked point from the start of the test and the physical water entry location (the identified location of water entry point). The data from a marked location had the co-relation value at five minutes, 15 minutes, and 30 minutes. The constant lowering of temperature happens at 15 minutes of the experiment to the end at 30 minutes. The change at 15 minutes is -0.8°C , at 20 minutes is -0.4°C , at 25 minutes is -0.3°C , and at 30 minutes is -0.8°C . The change in humidity in the defected module shows the overall trend of gradually increasing with some stable value in-between the rise. The variance shows an increase of 2% at 5 minutes, but later shows a decrease of 1% at 10 minutes. Then the humidity increases by 1% at 15 minutes, remains the same at 20 minutes and 25 minutes, and later rises by 2% at 30 minutes. The second location—the point of water penetration—shows a clear sign of water leakage in the collected data. There are four co-relations of change that happen at 5 minutes, 15 minutes, 20 minutes, and 30 minutes. The constant change in surface temperature occurs from 5 minutes to the end of the experiment. The surface temperature started at 46.9°C and lowered to 38.2°C at 30 minutes. The change is -4°C , -1.9°C , -0.8°C , -0.8°C , -0.6°C , and -0.6°C accordingly. Moreover, the change in humidity also suggested a clear sign of water leakage in the collected data. The change in humidity increases 3% at 5 minutes, with a drop of -4% at 10 minutes, and later, constantly increasing up to 6% at the end of the experiment. The change is $+3\%$ at 15 minutes, $+1\%$ at 20 minutes, no change at 25 minutes, and $+2\%$ at 30 minutes.

The thermal image of a perfect one-stage joint represented no change in the color spectrum that led to a sign of water penetration. In contrast, the thermal image of the defected one-stage joint showed a clear change in the color spectrum. The yellow spot on the start of the test was the leak's location left by the previous surface test. The panel's surface had a red color from the ambient temperature. During the test, the surface temperature changed from a red area to a yellow and green area. The color of the water path at the start represented a green mark, with a yellow area around the leak's location. The constant leaks of water lowered the joint temperature over time and changed the joinery color spectrum to a dark blue. The area around the leak's location also showed lower in the color spectrum that spread wider at the end of the test (Table 30).

Table 30 The thermal image of a perfect and defected one-stage joint from the start to the end of a surface experiment

Surface test	0 min	5 min	10 min	15 min	20 min	25 min	30 min
Perfect One-stage							
Defected One-stage							

3.3.3.5.2. The water spray test result

The variances on a perfect one-stage and a defected one-stage on a spray test are shown in a table below. There is no correlation between temperature and humidity for the perfectly grouted one-stage joint with a water spray test. The decrease in surface temperature only happens at 25 minutes by -0.3°C . The humidity content increased and decreased throughout the experiment. The changes in humidity are $+1\%$ at 5 minutes, 0% at 10 minutes, -1% at 15 minutes, -2% at 20 minutes, 0% at 25 minutes, and $+2\%$ at 30 minutes. The humidity content at the start is 54% and rises to 56% at the end of the experiment (Table 31).

Table 31 The table represents variances from a spray test of the perfect one-layer joint compared with a defected one-layer joint.

One - layer joint	Distribute spray test						
Perfect grout	0 min	5 min	10 min	15 min	20 min	25 min	30 min
Temp (°C)	35.8	35.9	36.2	36.5	36.7	36.4	36.5
Variance		0.1	0.3	0.3	0.2	-0.3	0.1
R. Humidity (%)	54	55	55	56	54	54	56
Variance		1.0	0.0	1.0	-2.0	0.0	2.0
Visual observation	No	No	No	No	No	No	No
Defected grout	0 min	5 min	10 min	15 min	20 min	25 min	30 min
Temp (°C)	43.7	43	43.6	43.3	42.1	41.5	40.1
Variance		-0.7	0.6	-0.3	-1.2	-0.6	-1.4
R. Humidity (%)	45	48	48	50	49	49	51
Variance		3.0	0.0	2.0	-1.0	0.0	2.0
Visual observation	No	No	Yes	Yes	Yes	Yes	Yes
Temp at leakage (°C)				38.4	38.5	37.3	37.2
Variance					0.1	-1.2	-0.1
Humidity at leakage (%)				57	48	47	56
Variance					-9.0	-1.0	9.0

On the other hand, the defected one-stage module shows that the correlation occurs at 5 minutes, 15 minutes, and 30 minutes of the experiment. The collected data from the defected test module is acquired at two location points: the marked point from the start of the test and the physical water entry location. The data at the marked location represent a constant decrease in temperature that happens at 15 minutes by -0.3°C , at 20 minutes by -1.2°C , at 25 minutes by -0.6°C , and at 30 minutes by -1.4°C . The increase in humidity content happens at 5 minutes by 3%, at 15 minutes by 2%, a slight drop of -1% at 20 minutes, and later increases by 2% at 30 minutes. The data collected from the water entry location happen after 15 minutes from the start of the experiment. The values of temperature are 38.4°C and the humidity content at 57% at 15 minutes. There is one extra co-relation at 30 minutes of the experiment with a defected test module with a water spray test from the second location. The constant decrease in surface temperature happens at 25 minutes by -1.2°C and at 30 minutes by -0.1°C . The change in surface temperature values at the second location started at 38.4°C and collected at the end of the experiment of 37.2°C . The total change in surface temperature is a decrease of -1.2°C . The change in humidity content contradicted itself with -9% at 20 minutes, -1% at 25 minutes, and $+9\%$ at 30 minutes. The humidity content at the mark

of water entry started from 57% and ended with 56%. The total change of humidity content reduced by 1%.

The thermal image of the spray test of the perfect one-stage joint compared with the defected joint shows a clear difference that points to water leakage. There are no changes in color that show water entry on the perfect one-stage joint, but the color spectrum changes from red to a lighter color in the defected one-stage joint. The water entry point is represented in the yellow spot in the middle of the connection. The precast concrete panel color changes over the duration of the test. The water drips coming from the top of the panels do not come from the connection area and does not affect the connection area. Therefore, the water drip line will not be considered in this experiment (Table 32).

Table 32 The thermal image of a perfect and defected one-stage joint from the start to the end of a spray experiment

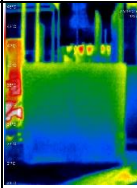
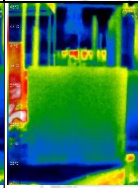
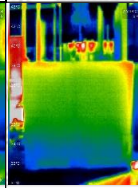
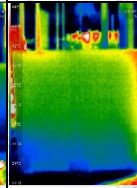
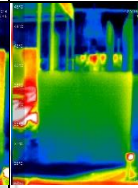
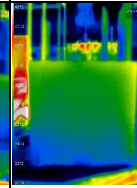
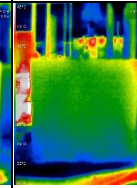
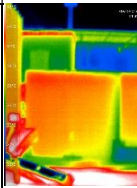
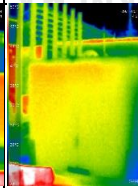
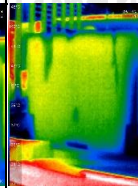
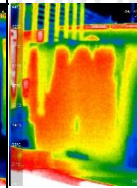
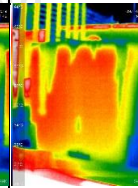
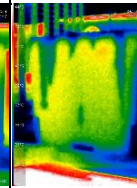
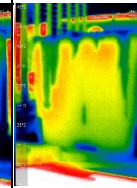
Spray test	0 min	5 min	10 min	15 min	20 min	25 min	30 min
Perfect One-stage							
Defected One-stage							

3.4. Conclusion: Experiment

The case study leads to a setup of the two-water test for the study of the water leakage prevention mechanism of the selected joinery. The water on the surface and the water spray test looked for the change in joint temperature that can be caused by water entering the joint. The indication that points to water penetration is a decrease in temperature combined with thermal images of the panels and visual observation. The experiment can be concluded into four main points. First, the case study from the research presented a theory on precast concrete joinery, when in

practice the knowledge is passed on through on-site construction. Second, the installation procedure for a precast concrete test module helps to understand the mechanism and layers of the three selected types of joints. Third, the researcher evaluated the water test that was conducted on the test modules. Last, the water movement and the mechanism that the joint used to prevent water penetration are analyzed in this chapter.

3.4.1. Case study in theory and in practice







The case study research helps to explain the precast concrete joinery in practice. The practice included on-site experience and different factors of joint selection. Typically, the type of joinery is chosen under the criteria of cost, efficiency, and aesthetics. The housing development company chooses the most efficient joint that works best for the project in terms of cost control. The aesthetic factor is another reason that the housing developer chooses one joint over another joint. For example, the two-stage joint is only used in condominium buildings but is not commonly used in houses. From the case study, the use of silicone sealant (which is oil-based) causes an uneven color when painted. The aesthetic value affects the developer's choice of a one-stage joint that is related to the customer perspective. From the test, the researcher sees that the designs of the joints from all sources are similar. However, all the joints have different advantages and disadvantages. The joint selection should be based on the requirement of each project. The experiment combines data on joinery in theory and in practice. Therefore, we selected three typologies of joints to test, with and without the additional scarf detail.

3.4.2. The installation of the three-joinery type

The installation process for the three-joint type without scarf details is easier than that with scarf detail; the one-stage joint needs formwork to cover the two sides of the panel faces. The wet process starts when mixing the mortar and pouring (or applying) it to the joinery gaps. The mortar needs to be partially dry before the formwork can be removed. The installation of a two-stage joint takes less time than a one-stage joint. The installation of the two backer rods can be done easily by carefully pressing the backer rods in between the connection gap, leaving 0.5 cm space to apply the sealant. The sealant is then applied to seal the two panels together. The average setting time for sealant is 30 minutes to 1 hour, and the curing time is 24 to 72 hours. The drain joint is more complicated to install compared to other types of joints. The installation of the backer rods has an inner layer that goes from the top to the bottom of the connection. Then, the second layer of backer rods is installed to curve down and serve as the water path. The application of sealant needs to be







done before the installation of the third external layer of the backer rods can be applied. The third layer of backer rods needs to have an opening at the top for water to go in and another opening for the water to exit (weep hole). The sealant is applied to secure the backer rods and connect the precast concrete panel (Table 33).

Table 33 Three joinery test modules without scarf details

One-stage joint	Two-stage joint	Drains joint
Grouted with non-shrink	Two-layer of backer rods with silicone sealant	Layers of backer rods with silicone sealant
		
		

The one-way scarf is a zigzag pattern on the side of the precast concrete wall. The shape makes it harder to install the backer rods for a drain joint. The installation process for the three-joint with the one-way scarf detail is the same as the flat-side panels. The shape does not affect the installation process of a two-stage joint. The insertion of backer rods is simply because it is on the face of the panels. However, the drain joint requires the insertion of the backer rods to go in the middle of the joint. The difficulty happens with the backer rods and the sealant application. The caulking gun (sealant gun) head is a linear-cone shape. It is hard to apply the sealant with a scarf detail panel. The custom caulking gun head may be needed to apply the sealant (Table 34).

Table 34 Three joinery test modules with scarf details.

One-stage joint	Two-stage joint	Drains joint
Grouted with non-shrink	Two-layer of backer rods with silicone sealant	Layers of backer rods with silicone sealant
		
		

3.4.3. The water test evaluation

The experiment is to understand joinery in action and study the behavior when in contact with water. The experiment is solely to test the efficiency of the joinery system in protecting the inside space from water. The water on a surface test and the water spray test in the experimentation showed the different behaviors of the joints. The water characteristic is different in speed and direction. The result from conducting both tests helps to understand the water prevention mechanism because the result can be compared. The test achieved the participated result.

The result of the test, specifically at 5 minutes into the test, explains the change that may be caused by relative temperature and relative humidity. The relative environment can change after the distribution of water from the surface test or when the water sprays to the exterior surface of the tested module. The first test is the water on the surface test; the temperature results from the surface test shows -0.1C, -0.4C, and -0.5C. All the three-test module temperature decrease after the water have run for 5 minutes; this shows a sign of change that is caused by the test. The humidity result at 5 minutes shows a change of +1%, 0%, and +2%. This increase in humidity value also represents the

change that is caused by the experiment to the joint or the surrounding. The second test is the water spray test; the temperature at 5 minutes of the test shows a change of +0.1C, +0.3C, and -0.6C. The decrease in temperature only shows on the drain joint test module. However, all the three-test module shows a change in humidity content at 5 minutes. The humidity content increases +1% in all the test modules. Therefore, the increase in humidity content in all three modules on a water spray test influences the joint and its surroundings during the experiment (Table 35).

Table 35 The table of collected data of 0 minutes and 5 minutes of the experiment.

The Water on surface test				
	No scarf detail		Scarf detail	
	0 min	5 min	0 min	5 min
One - layer joint				
Temp (°C)	33.3	33.2	33.7	33.9
Humidity (%)	55	56	76	76
Two - layer joint				
Temp (°C)	43.4	43	30.3	30.5
Humidity (%)	48	48	64	67
Drains joint				
Temp (°C)	45.3	44.8	30.1	30.4
Humidity (%)	45	47	67	69

3.4.4. The water movement behavior of the three-joinery type

The water movement behavior on joinery in the three selected joints. The one-stage joints prevent water well as a barrier wall. The grouted joint protects the inside wall from the water with less transfer of temperature — therefore, the water has less effect on the connection. However, the joint needs to be filled with mortar (perfectly grouted). The one-stage joints have a stable and robust connection to the precast panels. The inflexible connection of this joint has both an advantage and a disadvantage. The disadvantage of a one-stage joint is that any movement may cause the mortar to crack. The crack line in a one-stage joint is critical in the water penetration mechanism. The water can seep through all the opening with the capillary force. In the case that the crack line leads to the interior side of the wall, then the water penetration will happen at the crack-line opening point on the wall. Similar to an incompletely filled one-stage joint, the capillary action will occur when in contact with water (Table 36).

Table 36 The illustration of water movement on the three-test module and the effect from water temperature.

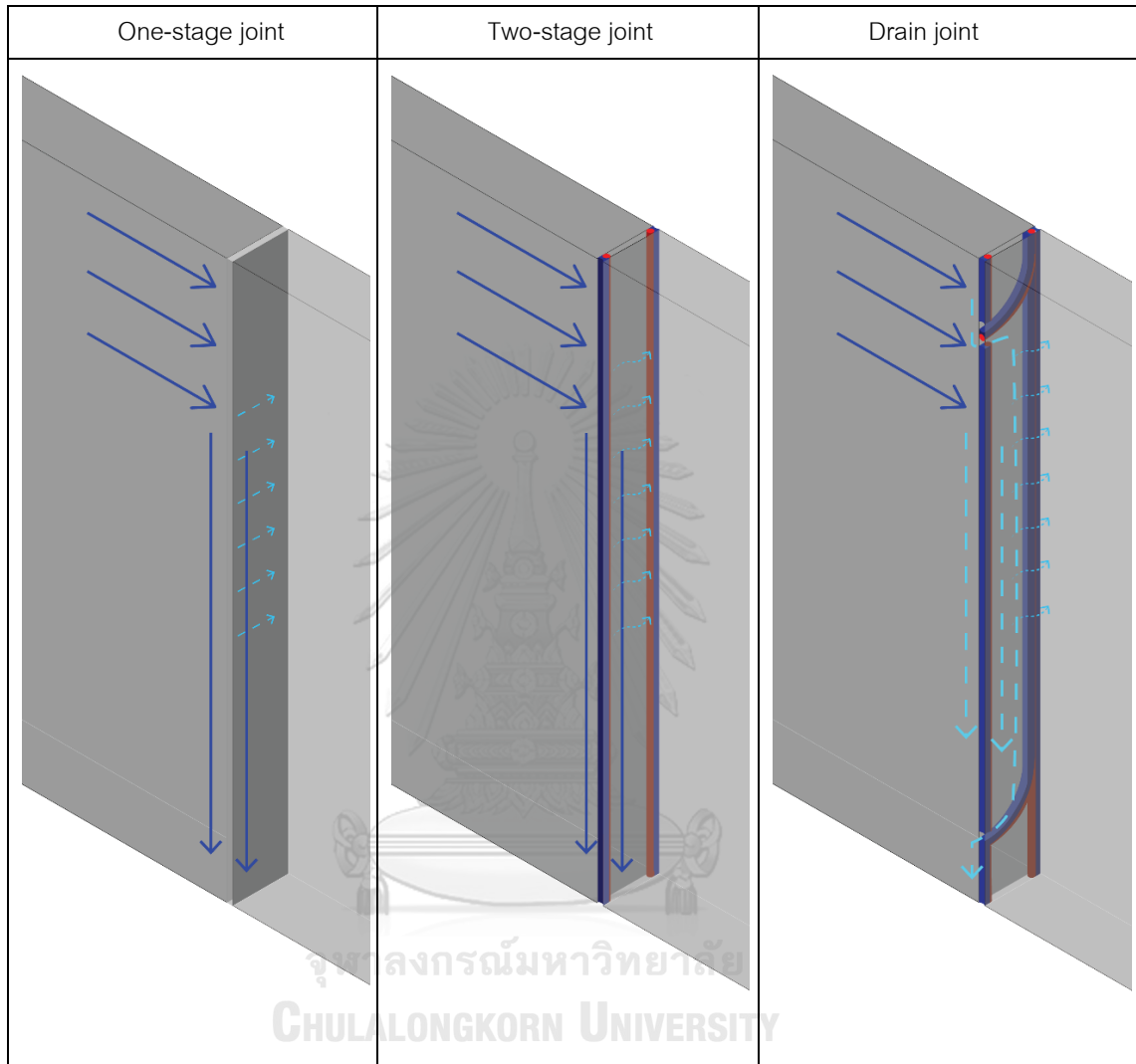

The behavior of a two-stage joint has a small effect when in contact with water. The water is almost inconceivable to reach the interior side of the wall. Even if the water penetrates the exterior layer through the first backer rods' seals of a two-stage joint, it does not mean the water will reach the inner layer. The water will run down along the joints due to the gravitational force before it hits the inner layer. However, the water content in the enclosed wall may cause an increase in humidity and lead to the growth of mold. The moisture created a habitable environment for mold. The two-stage joint's disadvantage is that the properties of joints rely on the product lifespan of the sealant. The external life expectancy of sealant differs from sealant materials. The silicone-based sealant will last from five to fifteen years. The polyurethane and polyurethane-based sealants may last for up to 20

years. The lifespan of sealant also varies due to external conditions such as temperature, humidity, and UV content from the sun ("Whole life costing: Sealants,").

When in contact with water, the drain joints' behavior becomes a unique mechanism of all the joinery. The complexity of the joint that allows the water to penetrate the first layer creates advantages and disadvantages. The advantages of the drain joint are the predicted paths where the water will flow, which includes the prepared opening and the path to the exit weep-hole. The downside to this type of joinery is the way water temperature gets easily transferred to the interior space. The water that enters the joint is protected with two back-to-back layers of backer rods. The two-layer backer rods have no air gap to lessen the heat transfer. Therefore, when compared to other joinery types, the drain joint has a high-temperature transfer from both the external and the internal side.

In the experiment, the installation of the first one-stage joint was not fully grouted. When the joint is not properly installed, the test module cannot be tested for the perfectly grouted one-stage joint. The incidental defective one-stage test module was used for the water leakage test to compare results with the perfect one-stage. The installation incident was also considered in a selection of the most effective joints for the research. The results of the experiment were analyzed in pairs to compare the types of joints and the effectiveness of scarf detail when applied to the joint.

CHAPTER 4

ANALYSIS OF THE WATER EXPERIMENT

This chapter will provide the analysis of the experiment on water leakage for the selected joinery, the comparison of each type of joints, and the scarf joint factor in the three types of joints. The chapter will analyze the collected data to further develop a synthesis of the most efficient joint for the design phase. The test results from chapter three are used to do a comparison analysis following the experiment framework (Table 37). The analysis of the water experiment plotted the test result in a graph format to understand the behavior and overall change of surface temperature and the relative humidity of the environment. The six-test modules are a one-stage joint, a two-stage joint, a drain joint, a scarf one-stage joint, a scarf two-stage joint, and a scarf drain joint. The analysis is a paired comparison of two types of joints and the comparison of the same type of joint without scarf detail (flat-side panels) with the joint with scarf details (one-way scarf / zig-zag side).

The chapter evaluates the selected joint with the criteria for selecting the most effective joint at preventing water leakage. The analysis then is synthesized to select the most effective joint to be a design strategy for the proposed project.

Table 37 The framework of analyzing the six-test modules.

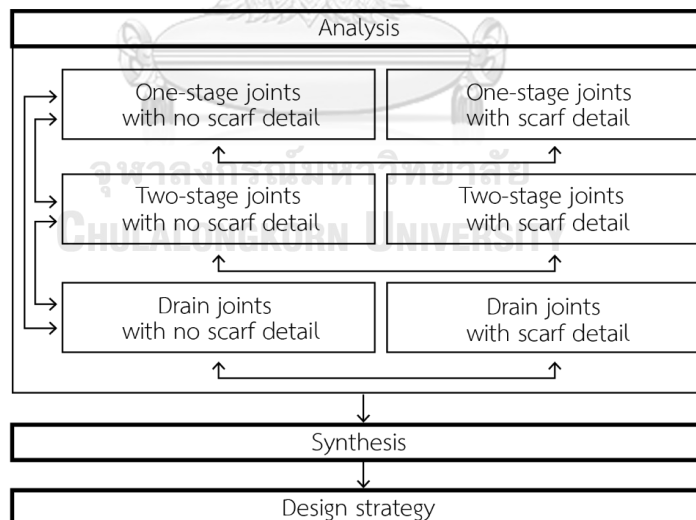

4.1. Analysis: The three types of joints comparison

The comparison of the type of joint to analyze the ability to prevent water penetration. The three pairs are a one-stage to a two-stage joint, a one-stage to a drain joint, and a two-stage to a drain joint. In addition to the three pairs, the defected one-stage joint incident added another pair of analyses. The comparison of a perfect one-stage joint and a defected one-stage joint is being analyzed.

4.1.1. One-stage joint and two-stage joint comparison

The analysis of a one-stage joint compared with a two-stage joint to find the most effective joinery to protect against water penetration. The two's joinery has the same value for the co-relation occurrence of one in the surface test. The one-stage joint is at 5 minutes, and the two-stage joint is at 20 minutes of the test—the one-stage joint temperature when from 33.3°C to 35.4°C. The increasing trend of +2.1°C identifies no water penetration that lowers the interior surface of the one-stage joint (Figure 17). However, the humidity content change from 55% to 58% in the surface experiment (Figure 18). The trend represents an increase of +3% in relative humidity value. The humidity value is fluctuated at 15 minutes to 30 minutes from +4% to a sudden drop of -6% and then raise at +4%. The two-stage joint temperature changes from 43.4°C to 41.7°C. The trend represents a decrease of -1.7°C, which is a sign of water penetration. The gradual decrease of temperature for 15 minutes at 20 minutes to 30 minutes of the test can show that water penetrates the joint and lowers the interior temperature. Besides the humidity change from 48% to 49%, these increases of +1% in humidity value is a sign of change that may be identified as water penetration. The humidity content shows an unstable change in the collected data. The data collected at 10 minutes and 15 minutes cancel out the value; it is an increase of +4% and then a decrease of -4%.

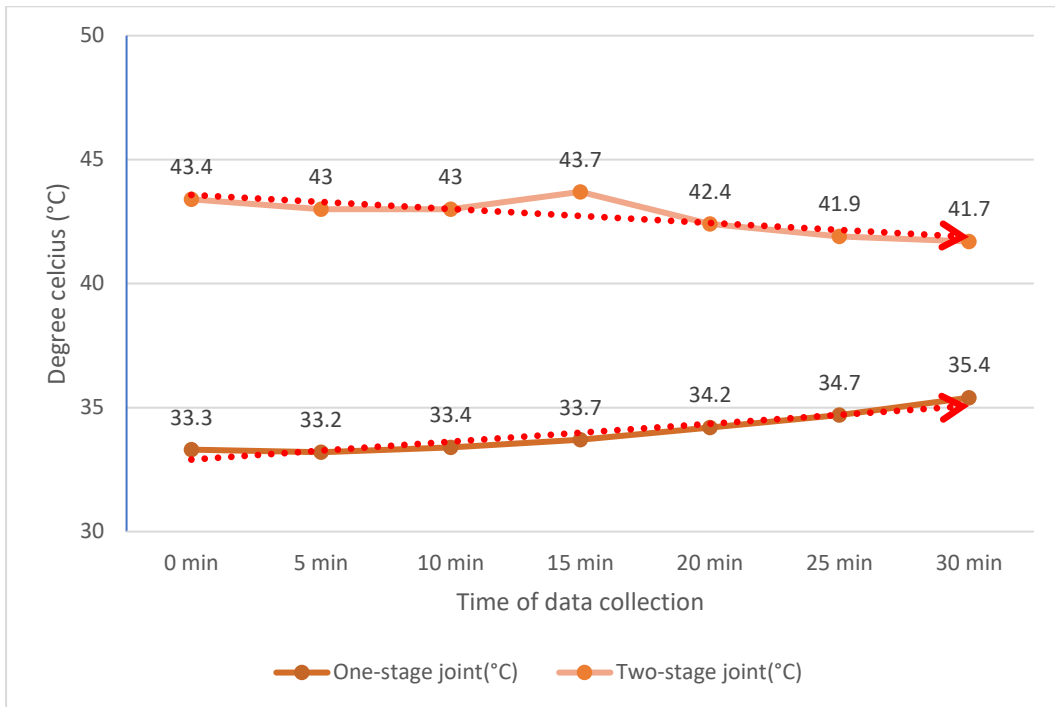

Figure 17 Change in temperature (°C) of the three joints without scarf detail on a surface test.

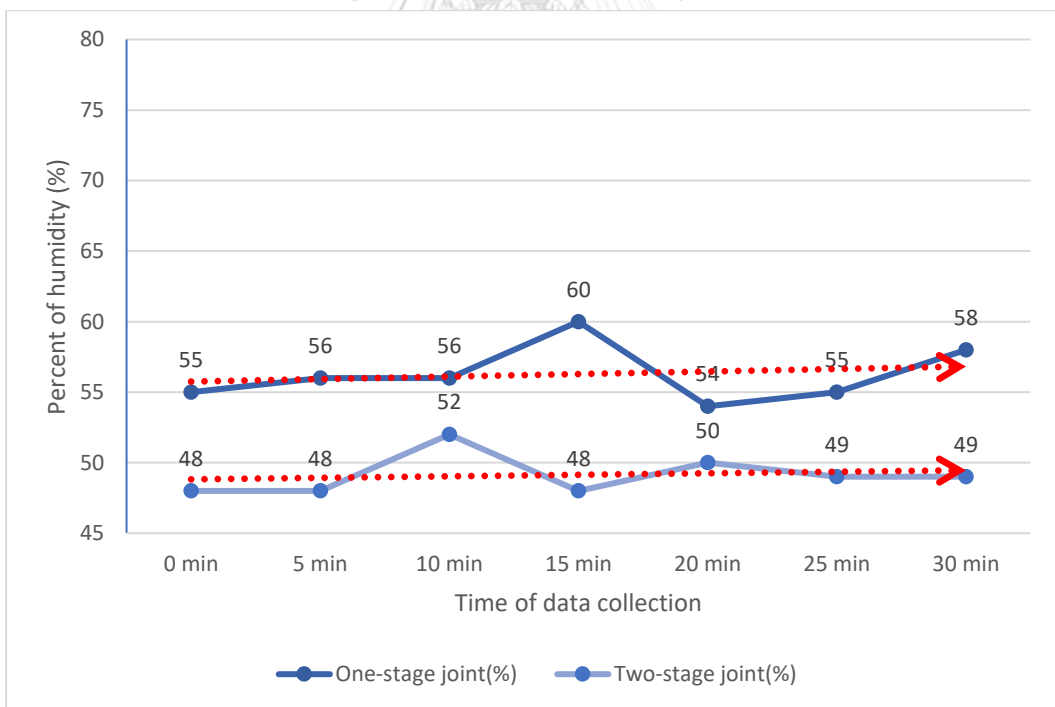

Figure 18 Change in rel. humidity (%) of the three joints without scarf detail on a surface test.

The spray test on a one-stage joint compared with the two-stage joint both show zero occurrences of co-relation in the collected data. The one-stage joint temperature change from

35.8°C to 36.5°C, it is an increase of +0.7°C. This change does not represent water entering the joint (Figure 19). The humidity starts at 54% and increases by +2% to 56% at 30 minutes (Figure 20). However, if the humidity increases, the temperature should lower as the water enters. The humidity may be transferred through the mass joint system. The two-stage joint temperature change, from 42°C to 40.2°C, shows a decrease of -1.8°C . In addition to an overall decrease in temperature at 15 minutes, there is a constant decrease in temperature of -1°C , -0.7°C , -0.3°C and -0.8°C . In contrast, the humidity lowered -8% in the same period, which identifies the opposite to the temperature. A similar case happens in the first ten minutes of the test, the temperature decreases -1°C , and the humidity increases 3% — the data in the two-stage joint contradicts the hypothesis of water penetration. The increase in temperature might be from the relative temperature because the test is conducted outdoors with direct contact from sunlight.

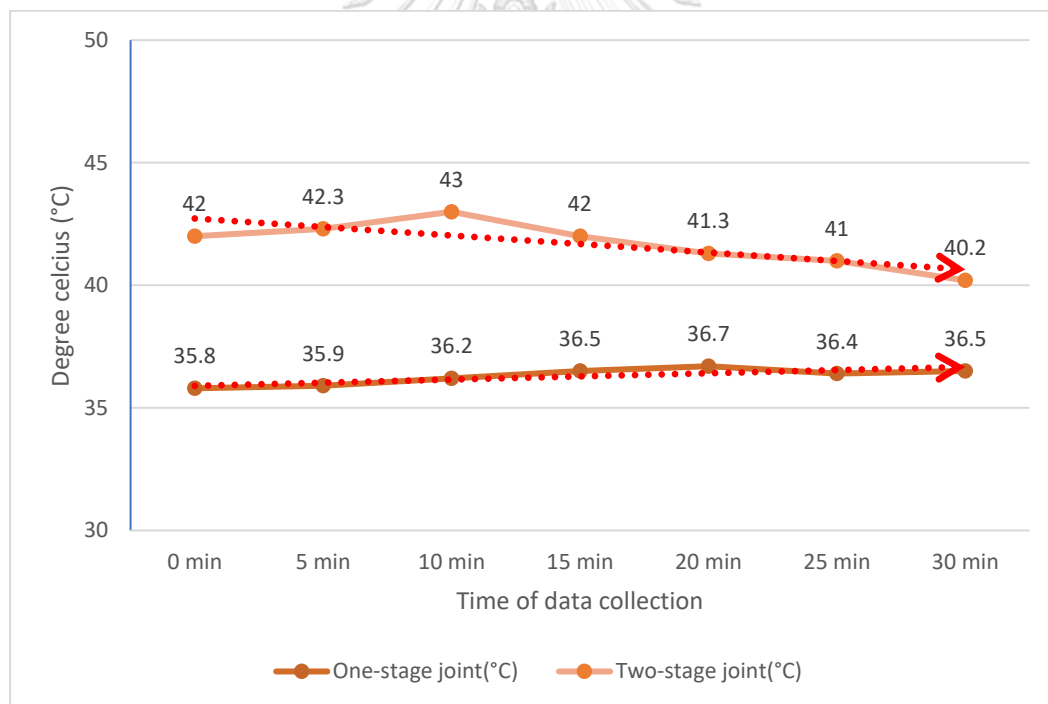

Figure 19 Change in temperature ($^{\circ}\text{C}$) of the three joints without scarf detail on a spray test.

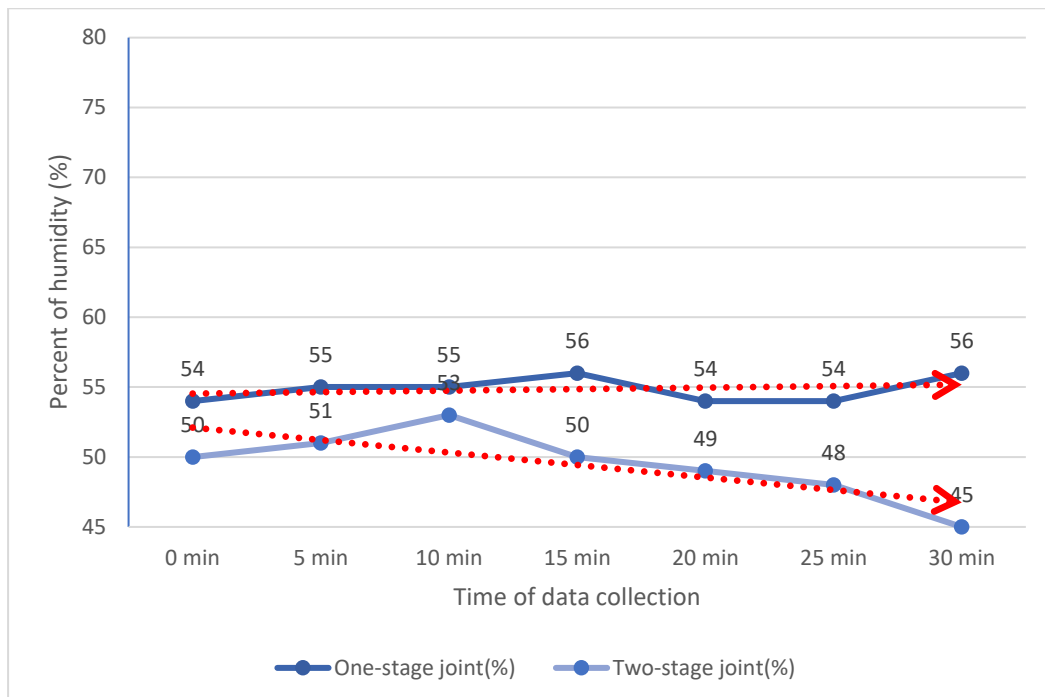

Figure 20 Change in rel. humidity (%) of the three joints without scarf detail on a spray test.

The one-stage joint had better performance than the two-stage joint. The one-stage shows no decrease in the surface temperature. This result means that the surface temperature increases with the surrounding temperature and does not affect water temperature. However, the relative humidity of a surface test on a one-stage joint had a higher increase by 3%, where the two-stage joint had an increase of 1%. Additionally, the spray test shows that the one-stage joint performs better than the two-stage joint. There are no drops in surface temperature in a one-stage joint. Whereas for the two-stage joint, the temperature decreases by -1.8°C , but the relative humidity decreases by -5% while the one-stage joint's relative humidity increases by $+2\%$. Therefore, the one-stage joint has a better performance at preventing water leakage than the two-stage joint.

4.1.2. One-stage joint and drain joint comparison

The comparison analysis between the one-stage joint and the drains joint shows a different mechanism of preventing water penetration. A one-stage joint mechanism is a mass joint that stops water at all the exterior surfaces. Whereas, for the drain joint, the mechanism prevents the water from reaching its inner layer. The water on the surface test shows one co-relation at 5 minutes for the one-stage joint. The co-relation only happens at the start and may be caused by the water from the experiment. The temperature starts from 33.3°C and increases by $+2.1^{\circ}\text{C}$; the temperature at 30 minutes is 35.4°C . The change at 10 minutes until 30 minutes is a gradual increase in small values of

+0.2°C, +0.3°C, +0.5°C, +0.5°C, and +0.7°C (Figure 21). The humidity increases from 55% to 58%, with an unstable change of +4%, -6%, +1%, and +3%. The stable increase in humidity in the last 10 minutes of 1% and 3% may be a sign of water entry. The drain joint shows three co-relations at 5 minutes, 15 minutes, and 20 minutes. The overall trend suggests a sign of water penetration because of the temperature decrease by -1.9°C and humidity content increase by 3%. The constant is lower in temperature for 25 minutes, and the constant increased in humidity for 20 minutes. Moreover, in the last 10 minutes, the humidity remains steady (Figure 22).

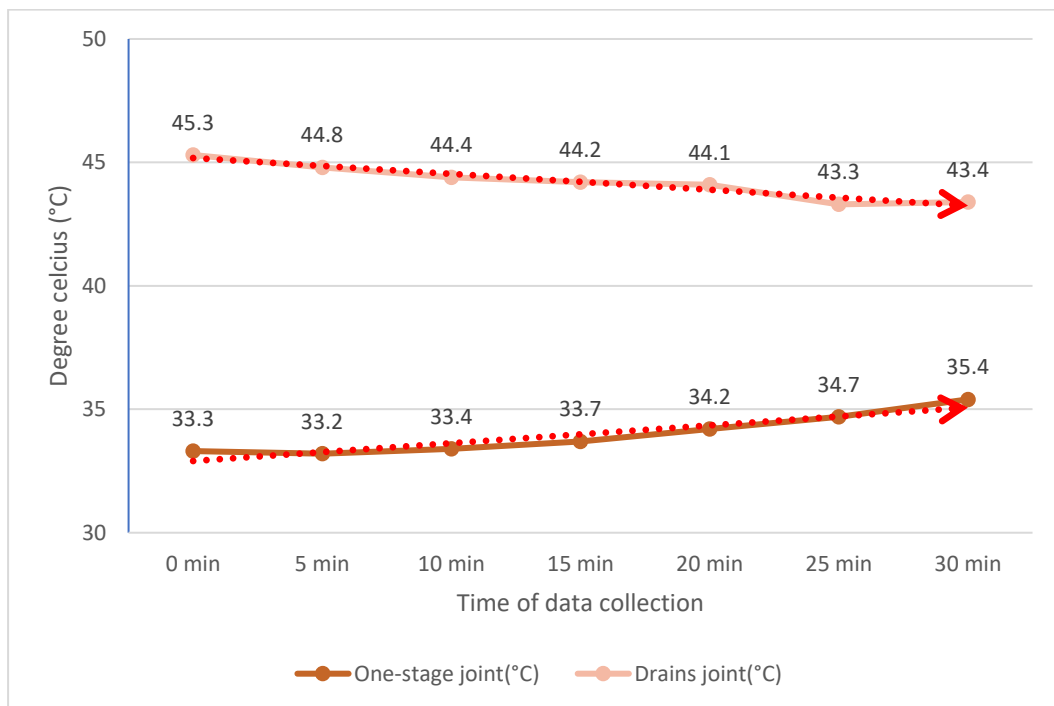

Figure 21 Change in temperature ($^{\circ}\text{C}$) of the three joints without scarf detail on a surface test.

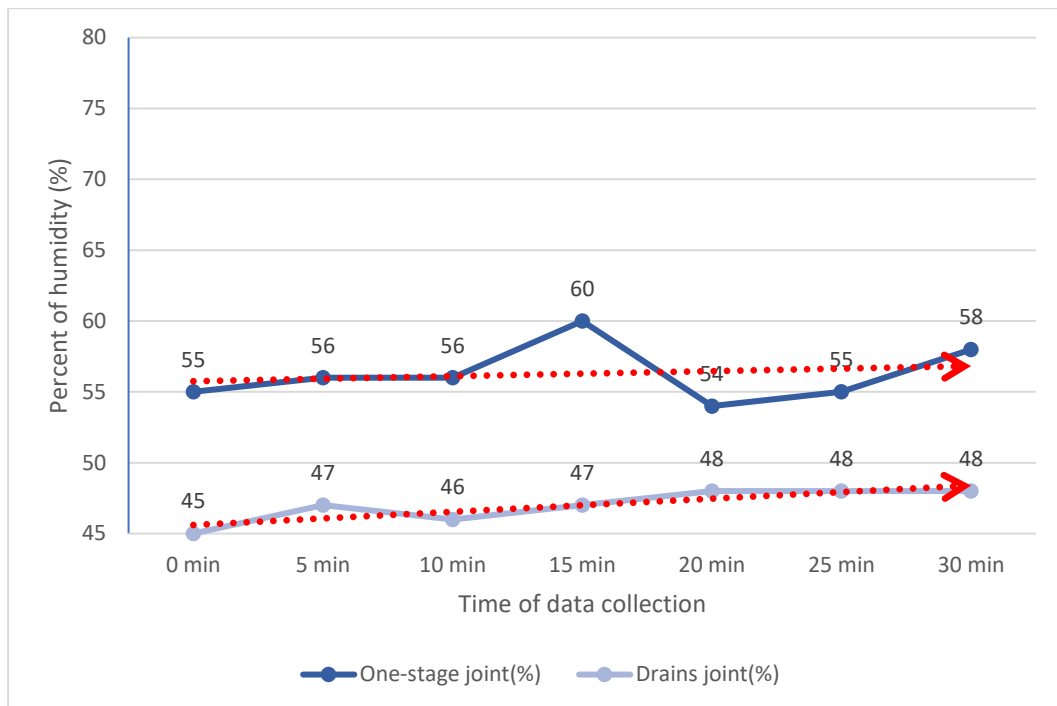

Figure 22 Change in rel. humidity (%) of the three joints without scarf detail on a surface test.

The water spray test shows zero co-relation for the one-stage joint. On the other hand, the drain joint shows four occurrences of co-relation. The co-relation happens at 5 minutes, 10 minutes, 20 minutes, and 30 minutes. The one-stage joint temperature increases from 35.8°C to 36.5°C; the overall change is an increase of 0.7°C (Figure 23). The humidity content starts from 54% and increases by 2% to a value of 56% (Figure 24). The temperature of one-stage joint increases in the two water tests. The change caused by a surface test is 2.1°C and the change by a spray test is 0.7°C. The humidity increases by 3% in a surface test and 2% in a spray test. The drain joint shows a decrease in temperature and an increase in humidity in the two water tests. The changes caused by the surface test and spray test are -1.9°C and 3%, and -3.9°C and 5% respectively.

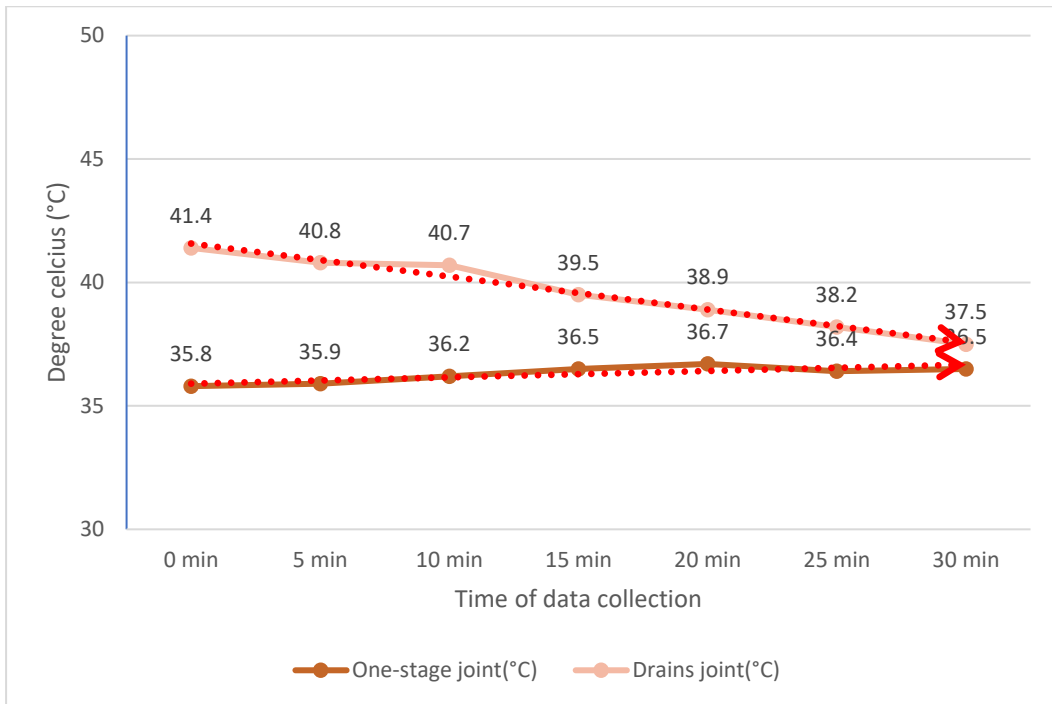

Figure 23 Change in temperature ($^{\circ}\text{C}$) of the three joints without scarf detail on a spray test.

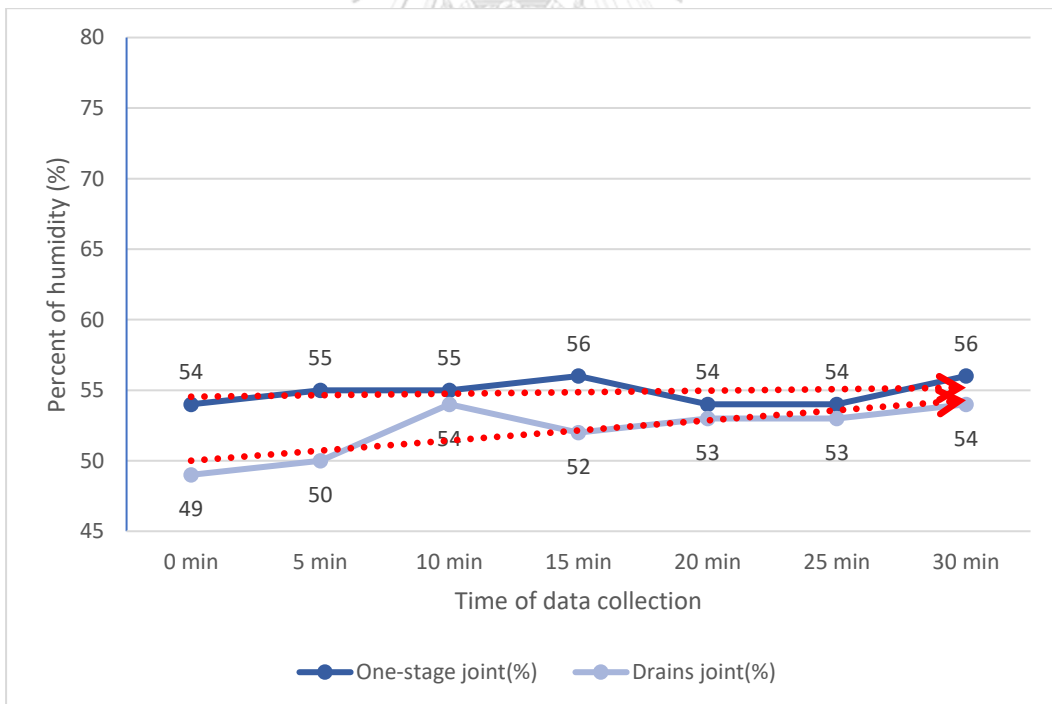

Figure 24 Change in rel. humidity (%) of the three joints without scarf detail on a spray test.

The one-stage joint performs better in preventing water leakage than a drain joint in both the two-water tests. The one-stage showed no decrease in surface temperature. In contrary, the drain

joint surface temperature drops from 45.3°C to 43.4°C in a surface test and 41.4°C to 37.5°C in a spray test. Therefore, the one-stage joint had a better performance when compared to the drain joint.

4.1.3. Two-stage joint and drain joint comparison

The two-stage joint and drain joint had a similar installation process. The differences are that a two-stage joint mechanism stops the water with the exterior surface, whereas the drain joint does not stop the water. The system allows the water to flow in and out of the joint freely. The surface test shows one co-relation that happens at 20 minutes. The drain joint shows three co-relations at 5, 15, and 30 minutes of the test. In the two-stage joint, the temperature went from 43°C to 41.7°C, which is a decrease of -1.7°C (Figure 25). The result also shows a constant decrease in 15 minutes. The change in temperature is -1.3°C at 20 minutes, -0.5°C at 25 minutes, and -0.2°C at 30 minutes. In addition, The humidity increased with an overall value of 1% (Figure 26). The change in humidity content fluctuated throughout the test. The overall result in a two-stage joint indicates a sign of water penetration. The drain joint result represents a sign of water penetration with the overall change of -1.9°C in temperature and +3% in humidity. The temperature changed from 45.3°C to 43.4°C, with a constant change for 25 minutes from the first 5 minutes of the test. The change is -0.5°C, -0.4°C, -0.2°C, -0.1°C, and -0.8°C respectively. The humidity changes from 45% to 48%, with a small and gradual increase of +2% and +1%.

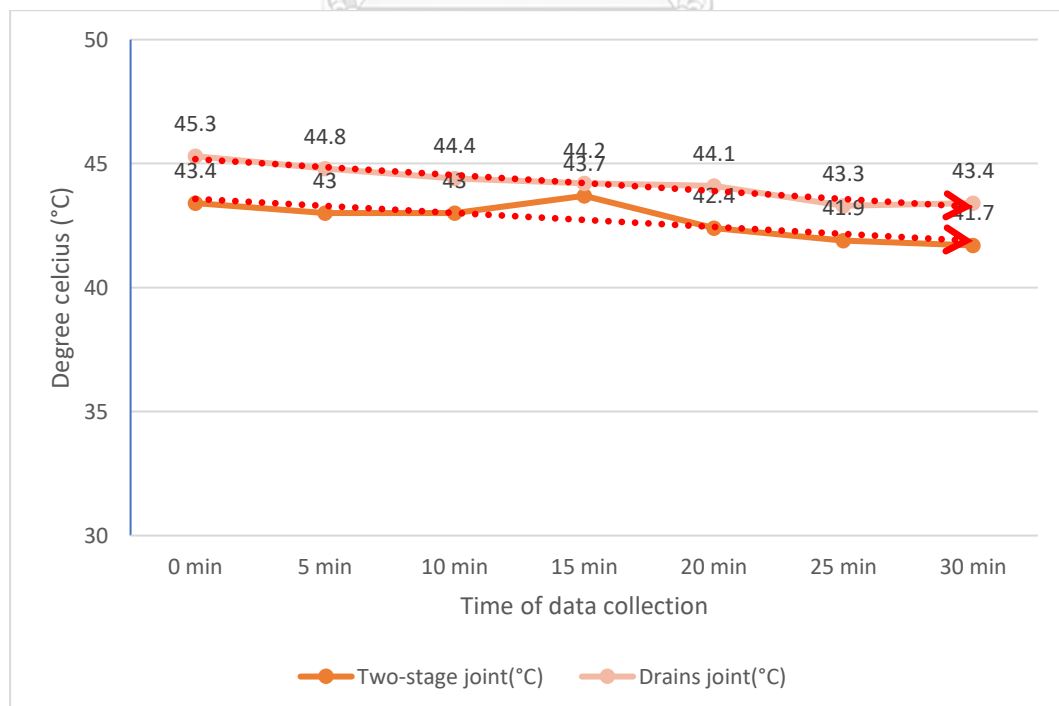

Figure 25 Change in temperature (°C) of the three joints without scarf detail on a surface test.

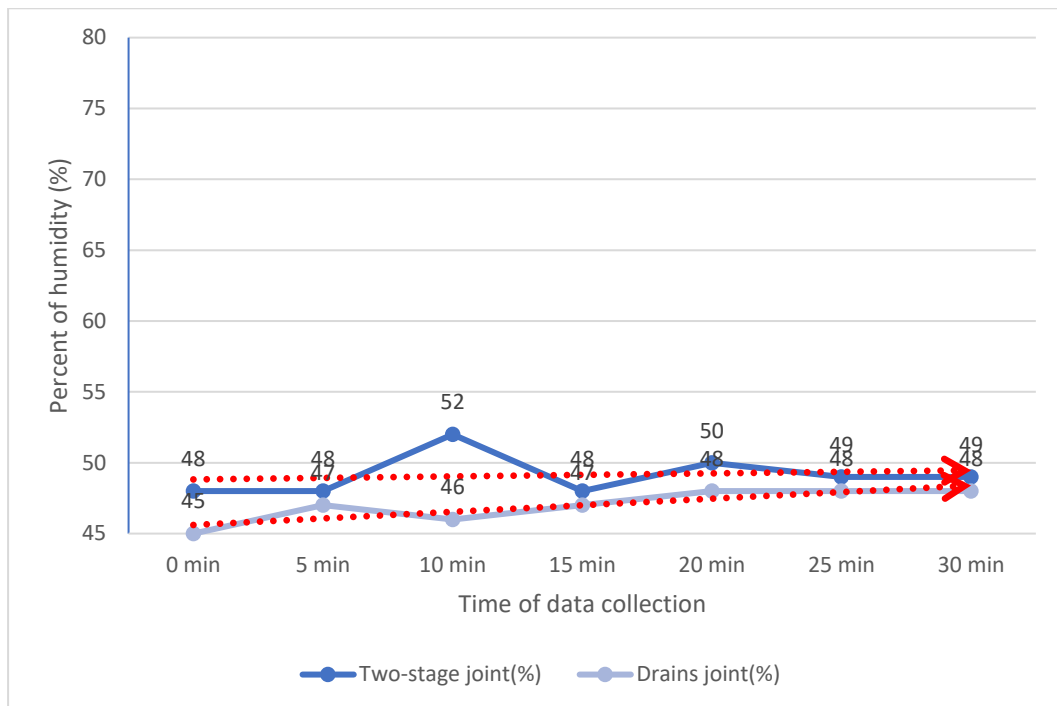

Figure 26 Change in rel. humidity (%) of the three joints without scarf detail on a surface test.

The spray test in the two-stage joint shows no co-relation in the sign of water penetration. The drain joint shows four co-relations at 5, 10, 20, and 30 minutes. The two-stage joint temperature changed from 42°C to 40.2°C, with an overall decrease of -1.8°C (Figure 27). On the other hand, the humidity content decreased by a total of -5% (Figure 28). The humidity goes from 50% to 45%. The constant increase happens at 5 minutes by +1% and 10 minutes by +2%. But after 15 minutes of the test, the humidity gradually drops by -3% , -1% , -1% , and -3% respectively. The result indicates that the temperature transfers through the joint. However, there is no increase in humidity to support that the water enters the joint. The drain joint changes from 41.4°C to 37.5°C, with a constant decrease in value of 0.6°C at 5 minute, 0.1°C at 10 minute, 1.2°C at 15 minute, 0.6°C at 20 minute, 0.7°C at 25 minute, and 0.7°C at 30 minute. The overall decrease in temperature for the drain joint is -3.9°C . Additionally, the humidity increases from 49% to 54% and with a total change of +5%. There is a high amount of water that enters the joint, which causes the temperature to lower on the interior surface. However, the humidity also increases on the interior surface. The change indicates a water penetration through the joint.

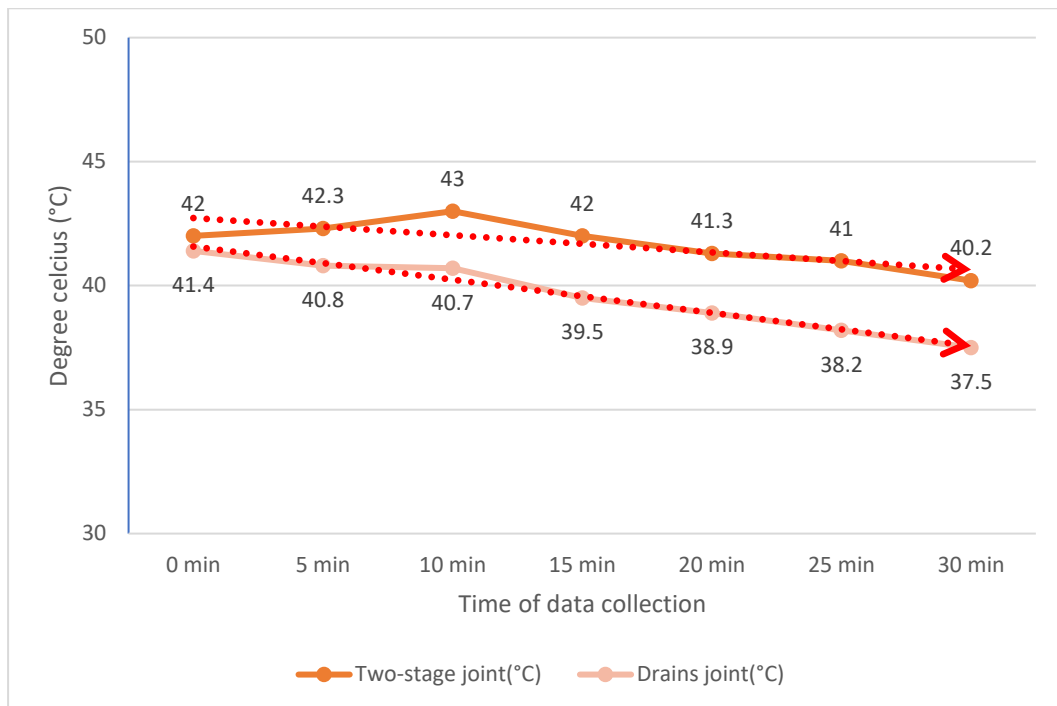

Figure 27 Change in temperature ($^{\circ}\text{C}$) of the three joints without scarf detail on a spray test.

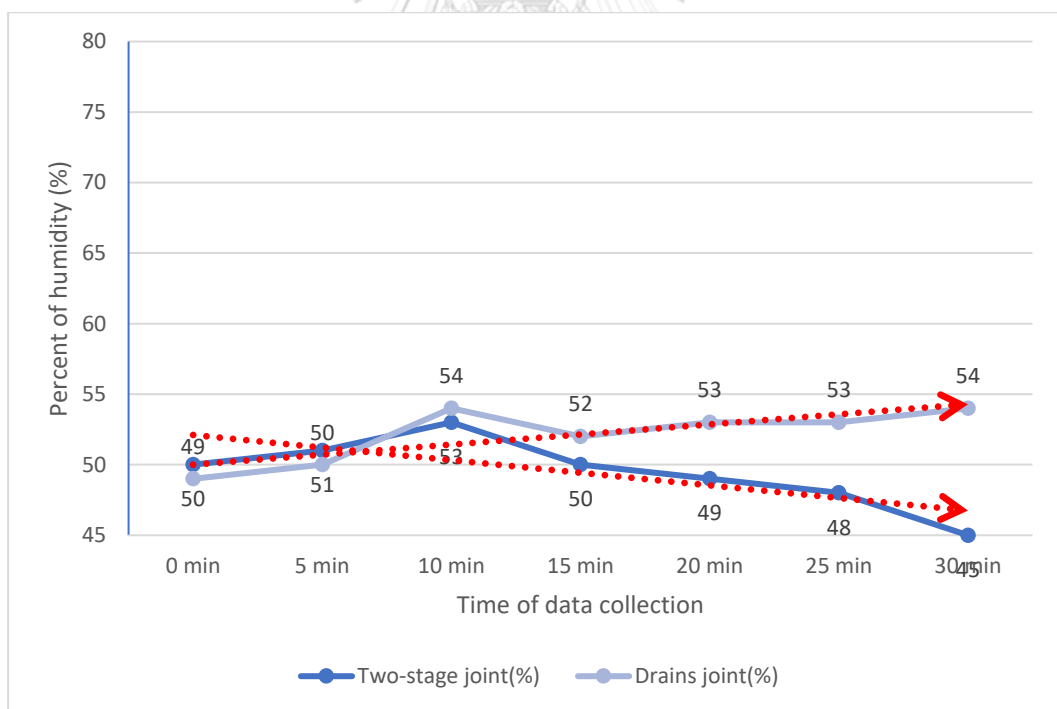

Figure 28 Change in rel. humidity (%) of the three joints without scarf detail on a spray test.

The surface test on the two-stage joint showed smaller decrease in surface temperature than the drain joint with changes of -1.7°C and -1.9°C , respectively. In addition, the two-stage joint

also performed better in the spray test with a surface temperature change of -1.8°C where drain joint had a change of -3.9°C . The drain joint result showed a higher change caused by the transfer of temperature from water to the connection because the nature of the drain joint that allowed water to penetrate to the inside layer caused the lower surface temperature but did not present any leaks. Therefore, the two-stage joint performed better when neglecting the drain joint nature, which was the biggest cause in lowering the surface temperature, with a lesser cause of water during the test.

4.1.4. Perfect and defected one-stage joint comparison

The collected data from a surface test on the perfect one-stage joint shows an overall increase in temperature of 2.1°C , from 33.3°C to 35.4°C (Figure 29). The increasing temperature trend is related to increased ambient temperature. On the other hand, the defected one-stage joint shows a decrease in temperature from 46.9°C to 44.2°C . The surface temperature drops by 2.7°C , which represents a sign of water penetration in the joint system. The relative humidity content from both test modules shows an increase in the water vapor of 3% and 4%.

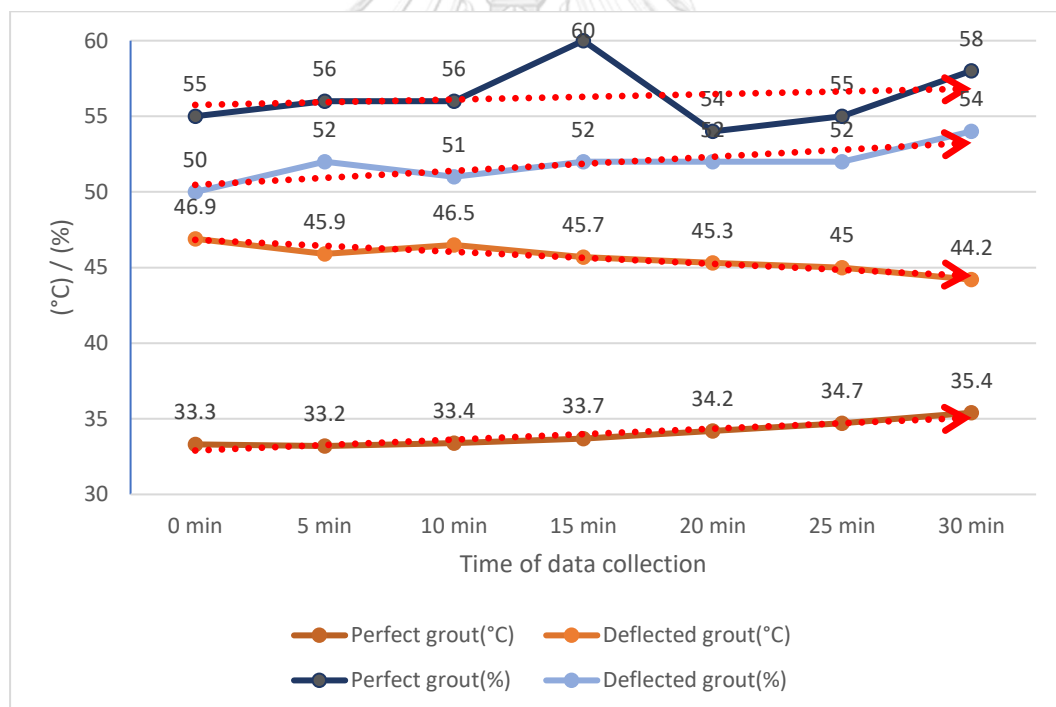

Figure 29 Change in temperature ($^{\circ}\text{C}$) and rel. humidity (%) of the perfect one-stage joint compared with the defected one-stage joints from a surface tests.

Similar to the spray test, the results showed an increase in temperature of $+0.7^{\circ}\text{C}$ in the perfect one-stage joint and a decrease in temperature of -3.6°C in the defected one-stage joint

(Figure 30). In the one-stage joint, the surface temperature changed with the ambient temperature, whereas the leak's one-stage joint surface temperature was lowered from the water that penetrated through the joinery. The relative humidity from both test modules showed an increase trend of +2% in the perfect one-stage joint and +6% in the defected one-stage joint.

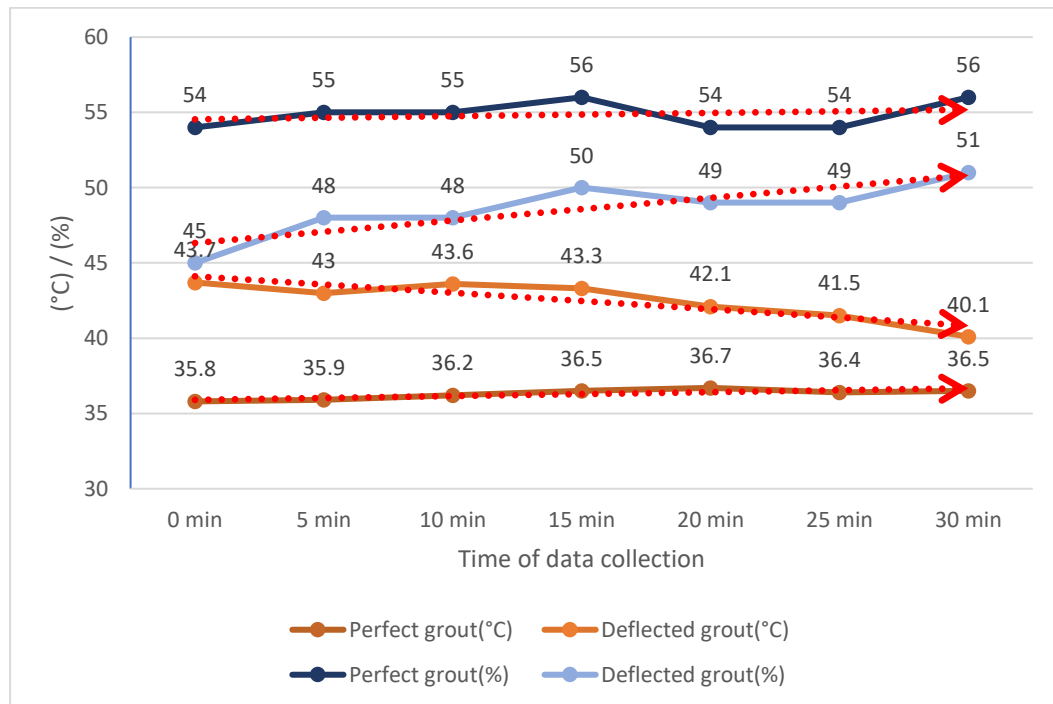

Figure 30 Change in temperature (°C) and rel. humidity (%) of the perfect one-stage joint compared with the defected one-stage joints from a spray tests.

The comparison of the collected data on the visual observation and thermal image was to see the change in temperature on all the panel's surfaces (Table 38). The thermal image helps identify the water entry and the behavior of water flow during the water infiltration. The temperatures collected at the two locations were compared to see the effect of water on the concrete panels. The temperature at the mark's location did not show any water leak areas. However, the temperature at the connection lowered from 45.9°C to 44.2°C when the temperature at the leaks showed a significant drop from 42.9°C to 38.2°C. The temperature at the leaks changed at a very high rate when the other location was affected by water infiltration.

Table 38 The table of data was collected from defected one-stage, joint image, thermal image, temperature collected from connection, and temperature at the location of the leaks.

Time (min)	Visual observation	Thermography image	Temperature at joint	Temperature at leak
0			<p>45.9 °C</p>	
5			<p>46.5 °C</p>	<p>42.9 °C</p>
10			<p>45.7 °C</p>	<p>41.0 °C</p>
20			<p>45.3 °C</p>	<p>39.4 °C</p>
25			<p>45.0 °C</p>	<p>38.8 °C</p>
30			<p>44.2 °C</p>	<p>38.2 °C</p>

The image in Figure 31 shows the two sides of the precast concrete panels after the water-on-the-surface test. An inspection of the panels indicated the water path on the exterior side of the panel. A tiny opening on the exterior wall led the water from the outside into the interior. The leakage was caused by a 1–2 mm opening that did not indicate a path to another side of the panel. The theory of a water leakage mechanism applied to this water penetration behavior with a capillary force. The capillary action was caused by the small passageway inside the precast concrete joint, and the water tension force (capillary force) pulled the water from one opening to another opening.



Figure 31 The image was taken from the interior side (left) and the exterior side of the one-stage test module (right).

The water on the surface test had a greater effect on the defected one-stage joint than the water spray test. The surface test represented a larger mark of water penetration, which means there was a greater amount of water leaking through the joint opening toward the interior. Therefore, the constant flow of water from the surface with the action of gravitational force caused greater water penetration than wind-driven rain with kinetic force. The water on the surface provided a constant flow that allowed the capillary force caused by water tension to constantly pull the water through the opening. When the water had passed through the opening, it kept moving through the same path. The water penetration stopped when there was no longer any water on the exterior surface at the opening. Therefore, if the rains wet the joinery area for a long duration, the water will enter the opening throughout that period.

This defected one-stage joint module showed the unexpected error caused by the installation of the joinery. The errors can be from many factors, such as the inconsistency of the mortar mixture, skills of the worker, and minimum achievement of joint spacing to fill in the mortar.

The risks of water leakages that are caused by a defective one-stage joint relies on the errors from the installation phase.

4.2. Analysis: No scarf joint and scarf joint comparison

The analysis compares the joint without the scarf detail to the joint with a one-way scarf detail. In general, the scarf helps to interlock the connection and partly prevent the water from entering the joint. The shape of the scarf joint makes it harder for the water to go through to the interior side. The analysis compares a one-stage joint with scarf one-stage joint, two-stage joint with scarf two-stage joint and drain joint with scarf drain joint. This will help identify the mechanism of the scarf detail and the effectiveness of scarf detail in water leakage prevention.

4.2.1. One-stage joint and scarfs one-stage joint comparison

The co-relation of a one-stage joint with scarfs one-stage joint is the same for the two tests. There is one co-relation in the surface test and no co-relation for the spray test. The scarf one-stage joint only shows two changes that may be identified as water penetration at 20 minutes with -0.2°C and $+1\%$. However, there is no constant change that may lead to water penetration. The overall temperature change for scarf one-stage is an increase by $+2.6^{\circ}\text{C}$, and humidity change shows a decrease of -9% (Figure 32). The two values showed no change that may lead to a sign of water penetration, while the one-stage joint displayed an increase in humidity value of $+3\%$. In the spray test, the overall temperature of scarf's one-stage joint decreased by -1.4°C . However, the change in humidity exhibited the opposite sign with a decline of -2% . The one-stage also showed the opposite result with a surge of $+0.7^{\circ}\text{C}$ and an increase in humidity of $+2\%$. The spray test on a scarf's one-stage joint represented a reduction in temperature at 5 minutes by -0.4°C and at 15 minutes by -0.5°C . One constant change was recorded at 25 minutes and 30 minutes of the test with -0.4°C and -0.2°C , respectively. On the other hand, the humidity content did not demonstrate a constant change.

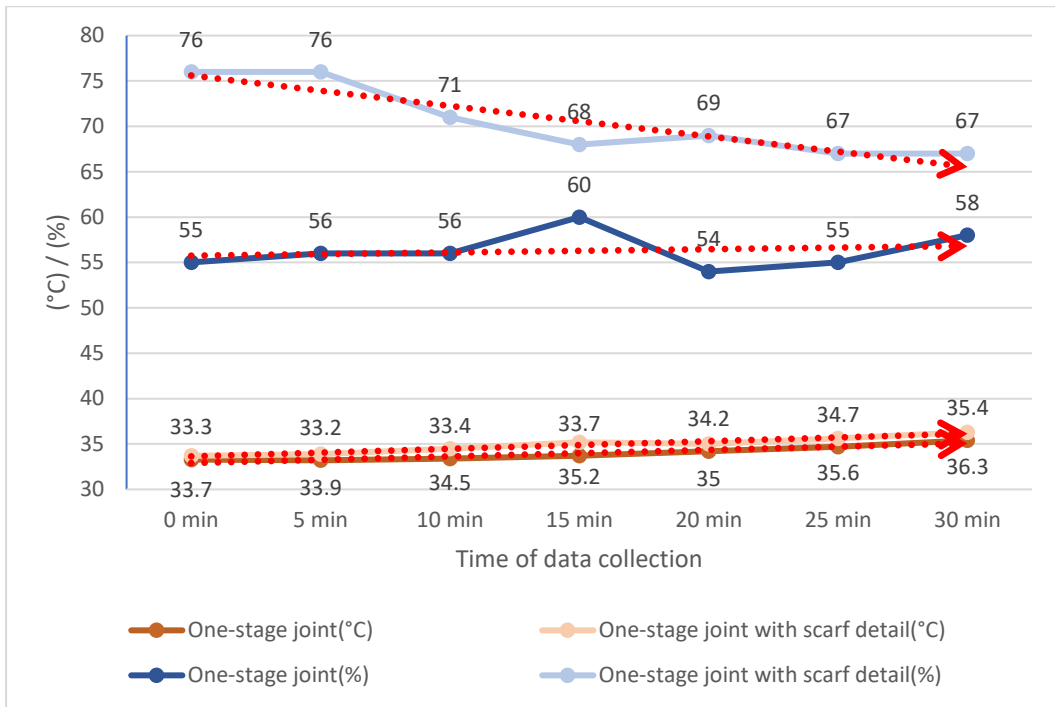

Figure 32 Change in temperature (°C) and rel. humidity (%) of the one-stage joint compared with the one-stage joint with scarf details on a surface test.

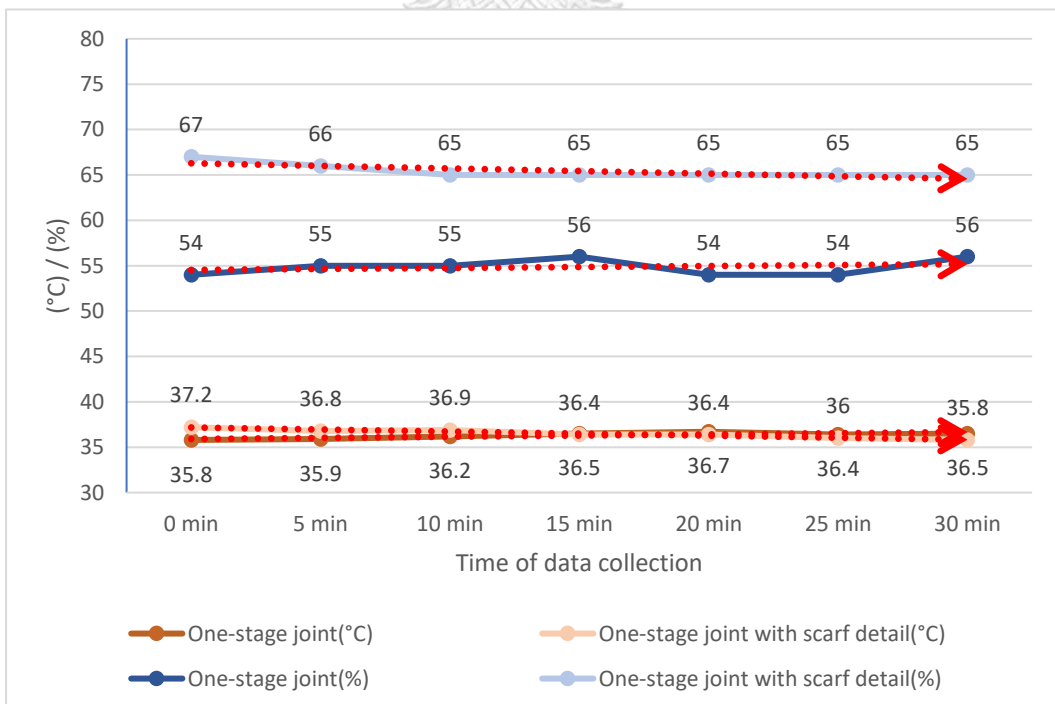

Figure 33 Change in temperature (°C) and rel. humidity (%) of the one-stage joint compared with the one-stage joints with scarf detail on a spray test.

The scarf's one-stage joint performed better on the surface test than the one-stage joint for a total change that signified water penetration (Figure 33). The spray test result revealed that the scarf's one-stage joint was better than the one-stage joint when it comes to preventing the water from entering the joint. The humidity in scarf one-stage joint shows a decrease value of -2% as opposed to the one-stage joint that increases the value of +2%.

The comparison of the one-stage joint with the scarfs one-stage joint shows that the one-stage joint with no scarf detail performs better at preventing water leakage. The two modules show no decrease in surface temperature with the change of +2.1°C in a one-stage joint and +2.6°C in a scarfs one-stage joint. In the spray test, the one-stage joint shows a clear result with an increase with +0.7°C compared to a scarfs one-stage joint with a change of -1.4°C. Therefore, the flat-side one-stage joint performs better than the scarfs one-stage joint.

4.2.2. Two-stage joint and scarfs two-stage joint comparison

The surface test in the two-stage joint has one co-relation at 20 minutes with -1.3°C and +2%. The overall change also shows a co-relation of a decreasing trend of temperature change of -1.7°C and an increasing trend of humidity of 1% (Figure 34). In addition, the constant change of temperature at 20 minutes to 30 minutes supports a sign of water penetration. The scarfs two-stage joint in a surface test shows no co-relation in the collected data. The total change of temperature is an increase in +2.2°C. The total change of humidity is an increase of 2%, and these show a sign of water entry. The constant change of humidity at 20 minutes and 25 minutes also supports the result. However, the change before and after the constant change is a decrease of -1%. Therefore, the change dismisses the showing of constant change in this information.

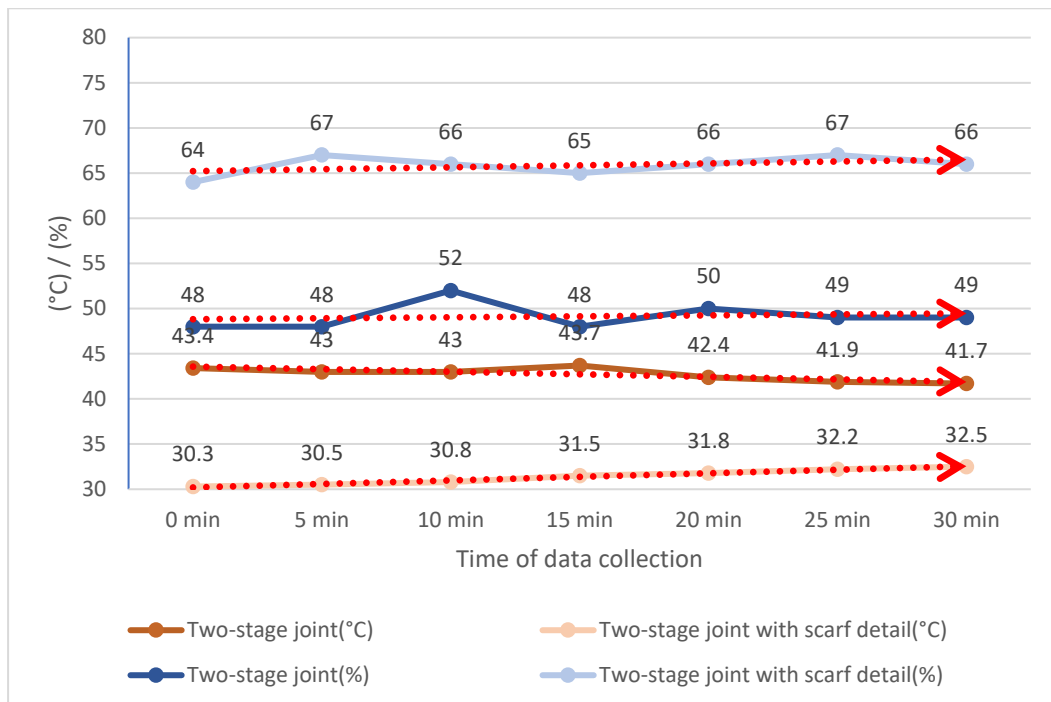

Figure 34 Change in temperature (°C) and rel. humidity (%) of the two-stage joint compared with the two-stage joints with scarf detail from a surface test.

The spray test of the two-stage joint compared with a scarf two-stage joint shows a significant difference. The two-stage joint has zero co-relation with contrast change that shows no sign of water leakage. The contrast change is when temperature increases, the humidity decreases, and vice versa. The overall trend shows a decrease in temperature of -1.8°C and a decrease in the humidity of -5% (Figure 35). The co-relation in the scarf's two-stage joint happens five times, with an additional overall change at the end. The total change shows a decrease in temperature of -0.7°C and an increase in humidity of $+8\%$. The constant change of humidity at five to twenty minutes of the test supports the water penetration sign.

The co-relation in the scarf two-stage joint happens five times, with an additional overall change at the end. The total change shows a decrease in temperature of -0.7°C and an increase in humidity of $+8\%$. The constant change of humidity at 5 to 20 minutes of the test supports the water penetration sign.

The scarf's two-stage-joint collected data show a better performance on a surface test with zero co-relation. However, the scarf's two-stage joint in a spray test shows five co-relations. The two-stage joint prevents water penetration better in a spray test.

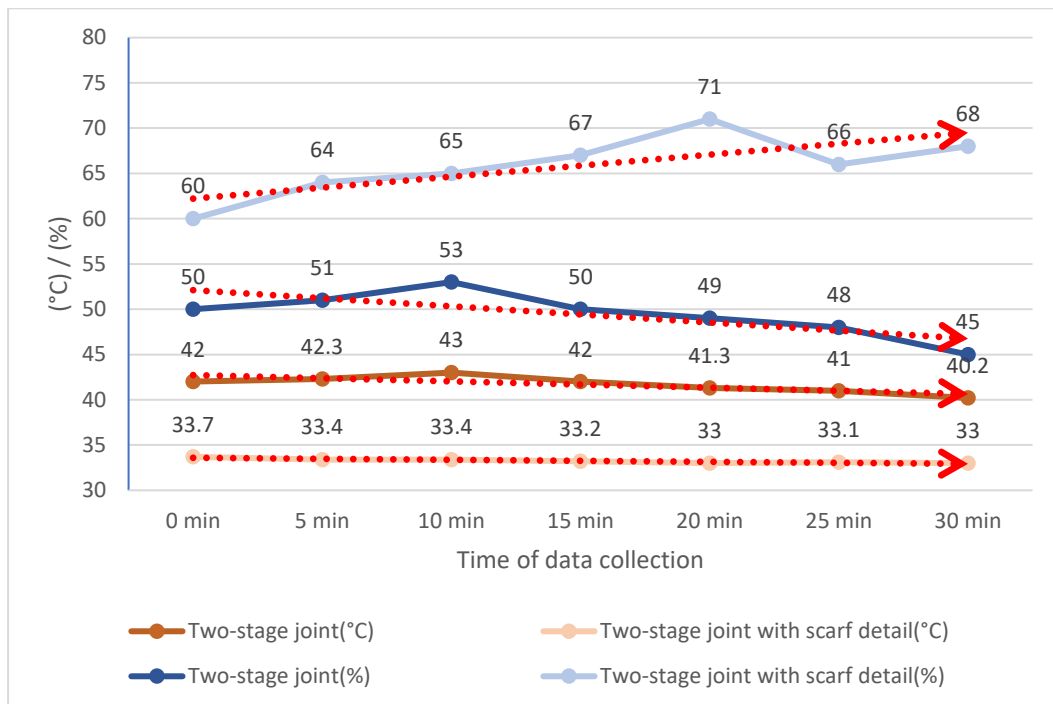

Figure 35 Change in temperature ($^{\circ}\text{C}$) and rel. humidity (%) of the two-stage joint compared with the two-stage joints with scarf detail on a spray test.

The result of the two-stage joint shows the change in the surface temperature of -1.7°C when the scarf's two-stage shows an increase of $+2.2^{\circ}\text{C}$. The spray test shows a decrease of -1.8°C for two-stage joint and scarf's two-stage had a change of -0.7°C . The scarf's two-stage joint represents a good result for a surface test and a better result when compared to a two-stage joint. Therefore, the scarf's two-stage joint performs better than the flat-side two-stage joint in the two-water test.

4.2.3. Drain joint and scarfs drain joint comparison

The surface test on a drain joint shows four co-relations with the co-relation of the overall trend. The total change shows a decrease in temperature of -1.9°C and an increase in humidity at 3% (Figure 36). A constant change supports the sign of water entry from five minutes to twenty-five minutes of the test. On the other hand, the scarf drain joint shows no co-relation in the collected data. The overall change is an increase of $+1.7^{\circ}\text{C}$ and a decrease of -1% . The data shows no sign of water penetration.

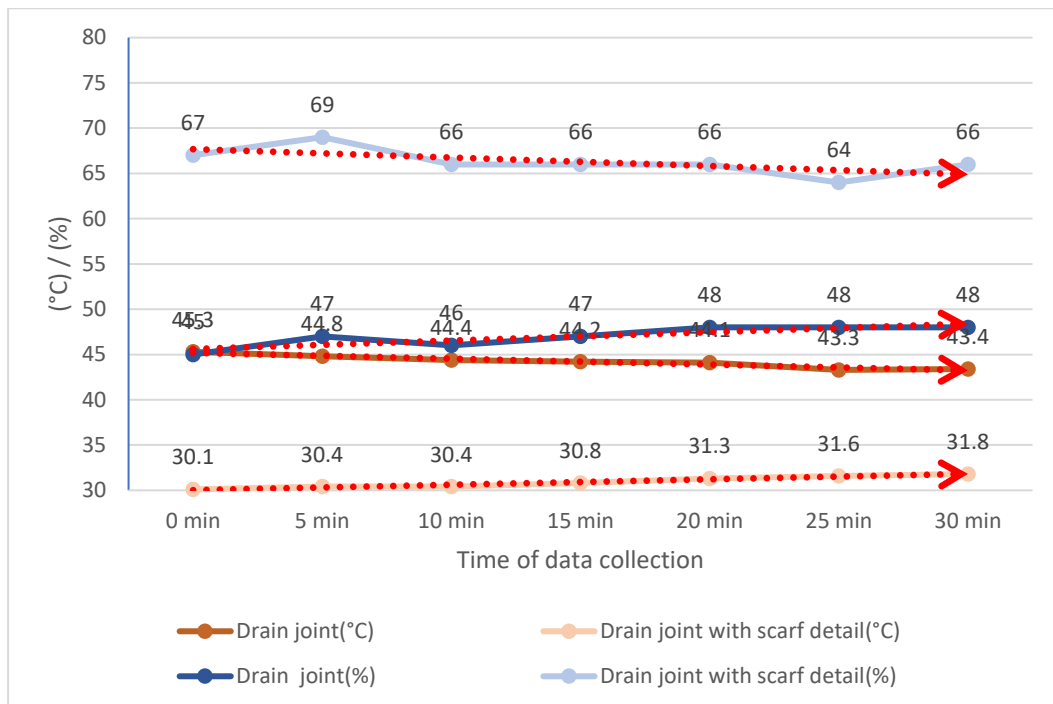

Figure 36 Change in temperature ($^{\circ}\text{C}$) and rel. humidity (%) of the drain joint compared with the drain joints with scarf detail from a surface test.

The spray test on the drain joint shows a greater effect than a surface test. The drain joint has five co-relations at 5 minutes, 10 minutes, 20 minutes, 30 minutes, and on the overall change. The constant change occurs throughout the 30 minutes of the test. The trend shows a decrease of -3.9°C with and an increase in humidity of 5% (Figure 37). The result shows many signs of water penetration in a drain joint during a spray test. The spray test on the scarf drain joint shows three co-relations at 5 minutes, 15 minutes, and on the overall change. The unstable change in temperature makes the data unreadable, but the humidity content has a constant change from 5 to 15 minutes of the test. The overall trend shows a decrease of -0.4°C and an increase in humidity of +1%.

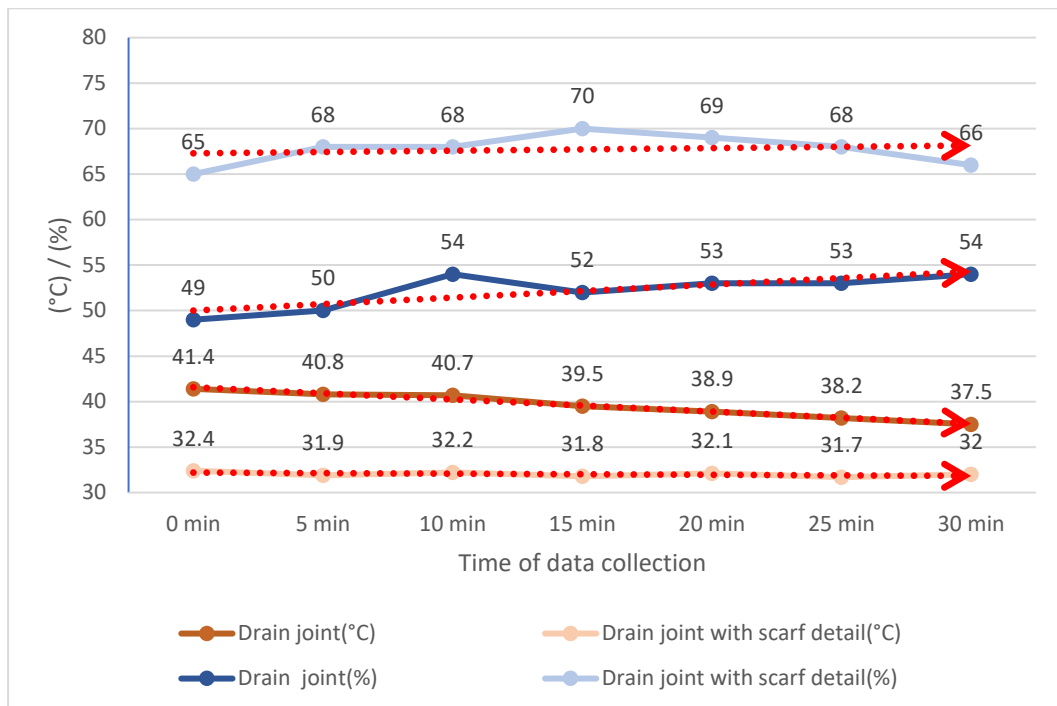

Figure 37 Change in temperature (°C) and rel. humidity (%) of the drain joint compared with the drain joints with scarf detail on a spray test.

The results of a surface test show a decrease in surface temperature of 1.9°C in a drain joint and an increase of 1.7°C in a scarf drain joint. The scarf drain joint had a better result from the experiment. The spray test in the drain joint shows a decrease of 3.9°C, while the scarf drain joint had less of a decrease in surface temperature of -0.4°C. The spray test comparison shows that the scarf joint had less of a drop in surface temperature than the drain joint, which means the scarf drain joint was affected less by water than the flat-side drain joint. Therefore, the scarf drain joint performed better in preventing water leakage.

4.3. Conclusion: Analysis

The analysis compared three types of joint in two-way: The joint is tested against another type of joint and the same type of joint with and without scarf detail. The result is compared with the relative temperature (ambient temperature) to identify the source of the change in temperature. The one-stage joint with no scarf and one-stage joint with scarf experienced surface temperature increases proportionally with the relative temperature in the surface test. The spray test on the one-stage joint showed no change in relative temperature but showed an increase in surface temperature of 0.7°C. And the scarf's one-stage joint on the spray test showed a contrast change of a decrease in

surface temperature of -1.4°C , but the relative temperature change was an increase of 0.6°C (Table 39).

Table 39 The table of all three types of joinery and scarfs three types of joinery in summery with the relative temperature.

The layer of joint with no scarf detail						
Water on surface test						
One - layer joint	Different at 0 min [1]	0 min	30 min	Overall change ($^{\circ}\text{C}/\%$)	Different at 30 min [2]	The overall change of S/R. temp. [3]
Temp ($^{\circ}\text{C}$)	0.9	33.3	35.4	2.1	2.1	1.2
RH (%)		55	58	3		
R.T ($^{\circ}\text{C}$)		32.4	33.3	0.9		
Two-layer joint						
Temp ($^{\circ}\text{C}$)	5.4	43.4	41.7	-1.7	5.2	-0.2
RH (%)		48	49	1		
R.T ($^{\circ}\text{C}$)		38	36.5	-1.5		
Drains joint						
Temp ($^{\circ}\text{C}$)	7	45.3	43.4	-1.9	5.4	-1.6
RH (%)		45	48	3		
R.T ($^{\circ}\text{C}$)		38.3	38	-0.3		
Distribute spray test						
One - layer joint	Different at 0 min [1]	0 min	30 min	Overall change ($^{\circ}\text{C}/\%$)	Different at 30 min [2]	The overall change of S/R. temp. [3]
Temp ($^{\circ}\text{C}$)	2.6	35.8	36.5	0.7	3.3	0.7
RH (%)		54	56	2		
R.T ($^{\circ}\text{C}$)		33.2	33.2	0		
Two-layer joint						
Temp ($^{\circ}\text{C}$)	6.3	42	40.2	-1.8	2.8	-3.5
RH (%)		50	45	-5		
R.T ($^{\circ}\text{C}$)		35.7	37.4	1.7		
Drains joint						
Temp ($^{\circ}\text{C}$)	6.1	41.4	37.5	-3.9	4.2	-1.9
RH (%)		49	54	5		
R.T ($^{\circ}\text{C}$)		35.3	33.3	-2		

The layer of joint with scarf detail						
Water on surface test						
One - layer joint	Different at 0 min [1]	0 min	30 min	Overall change ($^{\circ}\text{C}/\%$)	Different at 30 min [2]	The overall change of S/R. temp. [3]
Temp ($^{\circ}\text{C}$)	4.2	33.7	36.3	2.6	3.5	-0.7
RH (%)		76	67	-9		
R.T ($^{\circ}\text{C}$)		29.5	32.8	3.3		
Two-layer joint						
Temp ($^{\circ}\text{C}$)	-9.4	30.3	32.5	2.2	-0.1	9.3
RH (%)		64	66	2		
R.T ($^{\circ}\text{C}$)		39.7	32.6	-7.1		
Drains joint						
Temp ($^{\circ}\text{C}$)	-2.5	30.1	31.8	1.7	-0.7	1.8
RH (%)		67	66	-1		
R.T ($^{\circ}\text{C}$)		32.6	32.5	-0.1		
Distribute spray test						
One - layer joint	Different at 0 min [1]	0 min	30 min	Overall change ($^{\circ}\text{C}/\%$)	Different at 30 min [2]	The overall change of S/R. temp. [3]
Temp ($^{\circ}\text{C}$)	5.1	37.2	35.8	-1.4	3.1	-2
RH (%)		67	65	-2		
R.T ($^{\circ}\text{C}$)		32.1	32.7	0.6		
Two-layer joint						
Temp ($^{\circ}\text{C}$)	-1.7	33.7	33	-0.7	-0.2	1.5
RH (%)		60	68	8		
R.T ($^{\circ}\text{C}$)		35.4	33.2	-2.2		
Drains joint						
Temp ($^{\circ}\text{C}$)	-0.7	32.4	32	-0.4	-0.7	0
RH (%)		65	66	1		
R.T ($^{\circ}\text{C}$)		33.1	32.7	-0.4		

Notes: [1] the difference in surface temperature to relative temperature at 0 minutes; [2] the difference in surface temperature to relative temperature at 30 minutes; [3] the overall change in surface temperature to relative temperature.

The two-stage joint on the surface test decrease in surface temperature is related to the relative temperature. The surface temperature decreased by -1.7°C , and the relative temperature decreased by -1.5°C . The scarfs two-stage joint on a surface test showed a contradicting change in a good way, where the surface temperature increased by $+2.2^{\circ}\text{C}$ when the relative temperature dropped by -7.1°C . however, the spray test on the two-stage joint showed a decrease in surface temperature of -1.8°C when the relative temperature increased by $+1.7^{\circ}\text{C}$. The scarfs two-stage joint







on a spray test performed better when the surface temperature had a smaller decrease than the change in relative temperature. The relative temperature dropped by -2.2°C when the surface temperature dropped by -0.7°C .

The drain joint on a surface test showed a proportional decrease in the change of surface temperature and relative temperature. Although the surface temperature may affect the relative temperature, the surface temperature change is greater than the change caused by the relative temperature. The surface temperature drops by -1.9°C when the relative temperature drops by -0.3°C . The spray test on the drain joint also showed a similar result when the surface temperature decrease was greater than the relative temperature. The scarfs drain joint showed a better result compared to the module without scarf detail. The result from the surface test showed an increase in the surface temperature of $+1.7^{\circ}\text{C}$ when the relative temperature dropped slightly by -0.1°C . Additionally, the scarf drain joint on the spray test showed the same value in the change of surface temperature and the relative temperature. The surface temperature decreased by -0.4°C and also the relative temperature decreased by -0.4°C . The difference of change is zero, suggesting that the decrease in temperature on a spray test of a scarf drain joint is caused by the relative temperature.

4.4. Cost Analysis

This cost analysis is the calculation of cost per one meter of each joinery. The financial aspect of the joinery will not be weighed for the joinery selection in this thesis. However, it is important to compare the initial cost for the six joints. The non-shrink mortar is calculated in cost per cubic meter. A 20 kg sack of non-shrink mortar costs 250 baht and can fill 0.011 cubic meters (m^3). One cubic meter of non-shrink grout will cost 22,728 baht per cubic meter. The foam backer rod is measured based on length and will be calculated as baht per meter. The foam backer rod with a 10 mm diameter costs 755 baht per roll (100 m). Therefore, the cost of a foam backer rod is 7.55 baht per meter. The silicone sealant is calculated in cost per volume (m^3). One bottle of 300 ml silicone sealant costs 95 baht and has a coverage volume of 0.0003 m^3 . One cubic meter of the sealant would cost 316,667 baht/ m^3 ("Building material, product," 2020) (Table 40).

Table 40 The cost analysis of joinery materials in one meter of connection.

Material	Cost per unit	One-stage joint	Two-stage joint	Drain joint	Scarfs one-stage joint	Scarfs two-stage joint	Scarfs drain joint
							
Non-shrink mortar (m3)	22,728	0.001	-	-	0.001	-	-
Backer rod (m)	7.55	-	2	3	-	2	3.127
Sealant (m3)	316,667	-	0.0001	0.00015	-	0.0001	0.00017
Cost per meter (baht)		22.73	46.77	70.15	22.73	46.77	77.44

Note : The cost analysis is based on the market price from Building Material Company Limited (www.buildingmaterial.co.th)

The cost of each type of joinery is calculated as baht per meter (baht/m). The cost of the material of a one-stage joint proved to be the lowest compared to the two-stage and the drain joint. The one-stage joint and the scarf one-stage joint will cost 22.73 baht/m. The two-stage joint and the scarf two-stage joint uses the same amount of material, which will cost 46.77 baht/m. The highest cost of materials is the drain joint that requires one additional layer of backer rods. The cost per meter of a drain joint is 70.15 baht/m, and the scarf drain joint costs 77.44 baht/m. The two-stage joint costs twice as much compared to a one-stage joint, when the drain joint triples the cost of a one-stage joint cost per meter.

4.5. Synthesis of the most effective joint for water leakage prevention

The one-stage joint without scarf detail (refer to Figure 38) has an increase in the surface temperature of +2.1°C in the surface test and an increase of 0.7 in a spray test. The relative temperature in the surface test shows an increase of +2.1°C, indicating that the increase in surface temperature is likely to change from the relative temperature. The relative temperature for the spray test is an increase of +3.2°C, indicating that the slight increase in surface temperature might be an effect of the relative temperature. The one-stage joint transfers the humidity from the exterior to interior through the mass joint, since the two tests show an increase in relative humidity of 3% and 2%.



Figure 38 The top view image (left) and front view image (right) of a one-stage joint.

The scarf drain joint (Figure 39) has an increase in the surface temperature of 1.7°C on a surface test and a decrease of 0.4°C on a spray test. The surface test shows an increasing trend despite the lowering of the relative temperature by 0.7°C , which indicates that there is no sign of water penetration. In addition, the relative temperature for a spray test is a decrease of 0.7°C , which indicates that the change of -0.4°C is likely to be from the relative temperature. Despite the 0.4°C drop in temperature on the spray test, when compared to a scarf two-stage joint, the scarf drain joint was affected less by water temperature.



Figure 39 The top view image (left) and front view image (right) of a scarfs drains joint.

The mechanism of a one-stage joint connects the precast concrete panels together as one panel with a non-shrinkage grout, a similar mixture to a concrete mixture—the mechanism almost creates one continuous surface. From the study, the most efficient joint in the prevention of water leakage is a one-stage joint without scarf detail. However, installation errors can happen in the installation phase that cause a defected joint. The fully filled one-stage installation is hard to accomplish and check as the presence of any cracks or pores will cause water to enter the joint. Although the system worked well, the possibility of water penetration depends on the worker and equipment. The possibility of water leakage is a serious risk for a precast concrete house. Therefore, the second effective joint is the scarf drain joint. However, the service life of the sealant will last about 5 to 20 years, depending on the exposure to the external environment. Maintenance should be done on the joint when it reaches the sealant's serviceable life. The suggested maintenance periods are

every five years for the exterior side of the joint and every 10 to 15 years for in the interior side of the joint.

The scarf drain joint is the selected joinery system that will be incorporated into the proposed redesign of the two-story detached house development in chapter five. The selection is based on the water test that proves effectiveness against rainwater and wind-driven rainwater. The redesign will follow that precast concrete design principle and apply the scarf drain joint to the house.



CHAPTER 5

DESIGN PROCESS AND DESIGN IMPLEMENTATION

Chapter five presents the design process and design implementation on the redesign of the Centro Rangsit housing development. The Centro Rangsit has a fully constructed phase one in the first front half of the site. The project will redesign the modules and joinery detail of the phase-one panels from the Centro Rangsit project. The proposed thesis project is to redesign the Avid and Bravo units to improve the water protection mechanism to lower the water leakage problems. The redesign will follow that precast concrete design principle and apply the selected joinery from the experiment. The redesign principle is improved spatial planning that considers a modular system, precast wall panels division, additional elements to disrupt the rainwater, and scarf drain joint integration. The scarf drain joints were selected based on the synthesis in the analysis chapter; they were the most effective joint from the two-water experiment. These improvements in water leakage prevention are to be built in the second phase of the project. Phase two, the detached house construction, will entail building 165 new units on the same site.

5.1. The Centro Rangsit two-story detached house development

The Centro Rangsit project is a detached housing village with three housing types. All the three types are two-story precast-concrete load-bearing wall structures. The development had a total of 289 units. The three housing types are Avid, Bravo-A, and Bravo-B. The Avid unit comprises three bedrooms, three bathrooms, and two car parks. Avid unit is a 51-square-meter footprint with a total functional area of 154 square meters. Bravo-A or Bravo-B unit is a larger unit with four bedrooms, four bathrooms, and two car parks. The larger unit had a 55-square-meter footprint equipped with 164-square-meter functional space. Bravo-A and Bravo-B had the same precast-concrete wall panels with the difference at the extension of the car park's roof. The internal space is the same with 164-square-meter space and a functional area of 173 square meters (Figure 40).



Figure 40 The graphic illustration of the Avid, Bravo-A and Bravo-B unit in the Centro

Rangsit housing development.

The facility includes a swimming pool, parks, clubhouse, fitness, and security. The facility is already open for the phase-one resident. The purposed design will be redesigning the Centro Avid, Brava-A, and Bravo-B. The facilities building will not be part of the purposed design.

5.1.1. Site analysis

The Centro Rangsit project is located on Klong 4, Rangsit-Nakornnyok Rd. Bueng-yi-tho, Thanyaburi, Pathumthani, 12130 (Figure 41). The total area of the project is 60-9-4 rai (96,908 square meters) with the first phase entirely constructed. The main road in front of the development is Rangsit-Nakorn-Nayok Road near the Bangkok-Eastern Outer Ring Road (Motorway 9). The surrounding areas are mainly residential with Krung-Kavee developments and the Living Nara Village next to the site. The other villages near the site are Bangkok Boulevard Rangsit Village, Metharom Village, Praemaporn Village, Chaiyapruerk-Rangsit Village, Baan Sin-Sab 1 Village, Ban Fah Rangsit Village, The Village Rangsit-Wongwaen, and The Color Mix Rangsit-Wongwaen Village.

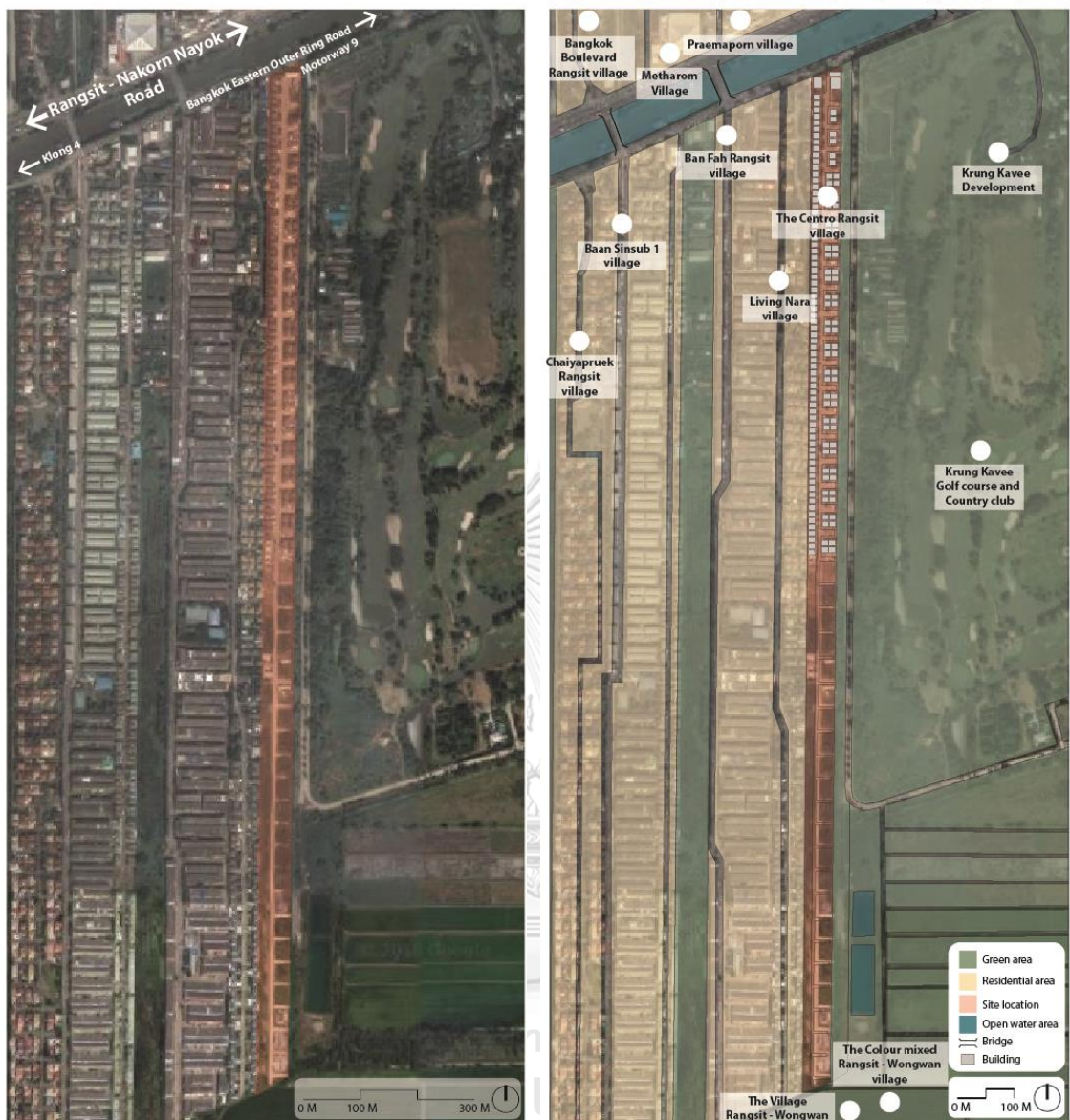

Figure 41 Site location on the satellite image (left) and the illustration of the surrounding sites with land use identification (right).

The first phase of the project is a 135 two-story detached house with three housing types (Figure 42). The house orientation is east-facing along the village road. The sub-road has north-facing and south-facing orientations. The open green area next to the site is Krung-Kavee Golf Course and Country Club with an internal restaurant and a golf course. The existing site has fully built houses occupying half of the site. The main internal road is fully paved to the end of the site. The sub-road branches out from the left from the entrance when entering. The plot for each unit starts from 200sq.m and higher. The site is an elongated plot with front width of 57.97 m and estimated length of 1,785.23 m (Figure 42).

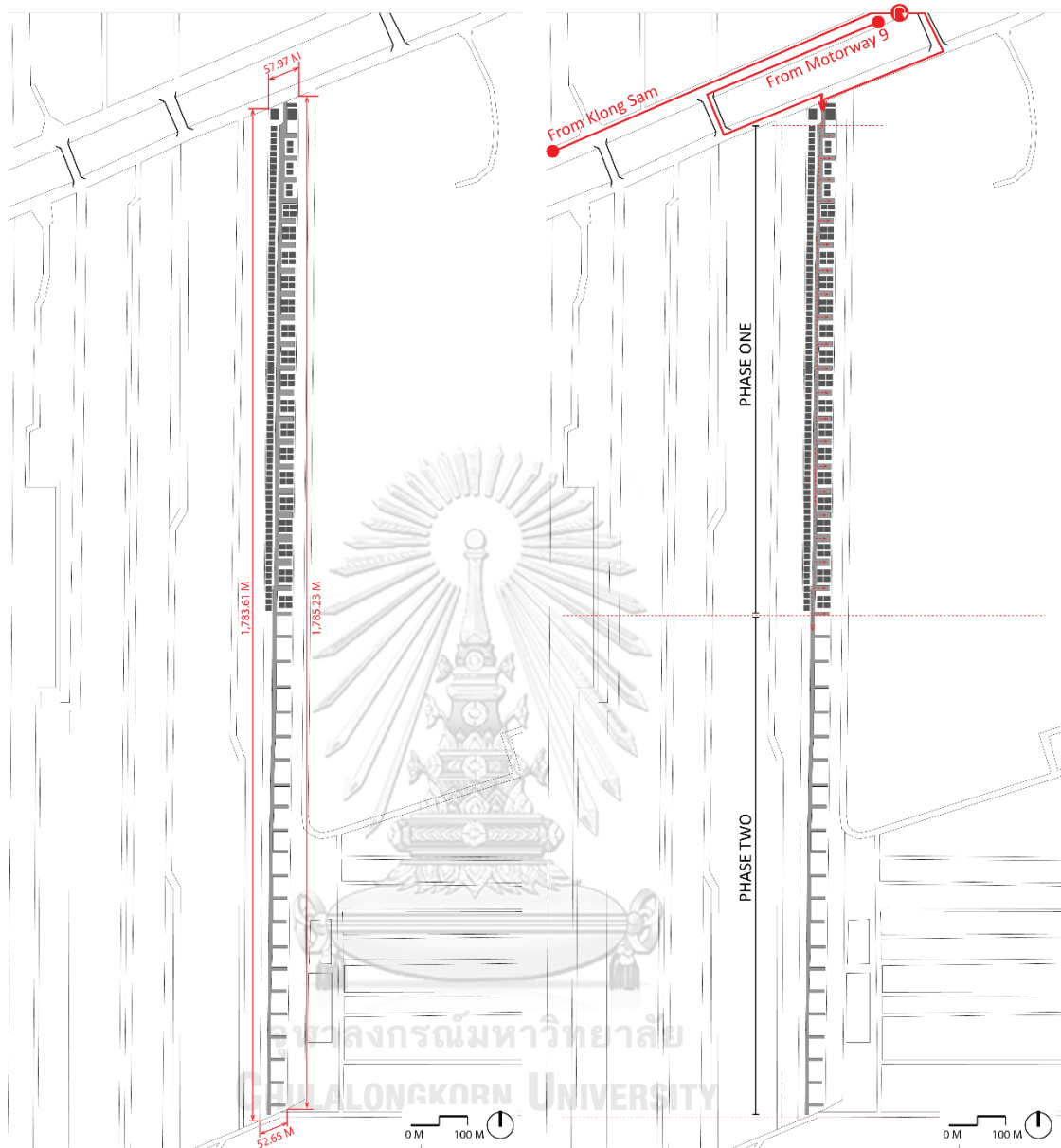

Figure 42 The illustration of site boundary (left) and site accessibility (right).

The site had one entrance from the small public road parallel to Rangsit-Nakornnayok Road. The site accessibility from Klong Sam requires driving along the Rangsit-Nakornnayok Road and taking a U-turn before the Bangkok-Eastern Outer Ring Road (Figure 42). Then, take a left to cross the bridge in front of Krung-Kravee development, and turn right toward the Centro Rangsit Village. Accessibility from Motorway 9 requires turning left to cross the bridge in front of Krung-Kravee Road or turning left to cross the bridge in front of Baan Fah Rangsit Village. From Baan Fah Rangsit Village, turn left toward Centro Rangsit Village.

5.1.2. Law and regulation

Types of land use, according to the ministerial regulations to enforce the city plan of Pratumthani City B.E. 2548 (2005), are based on community land types (Figure 43). according to the Department of Public Works and Town & Country Planning of Pratumthani City.



Figure 43 The land use according to Ministerial regulations to enforce the city plan of Pratumthani city B.E. 2548 (2005).

Ministry regulations enforce the Lam-Luk-Ka Town Plan, Bueng-Yi-Tho, and Pathum Thani Province B.E. 2555 (2012) (Figure 44). The site falls under a type 1.2 category of the land use code. Under section number 7, the land in low-density housing is to be used for housing, government institutions, and public utilities. The regulation states that other purposes are to use no more than fifteen percent of the plot.



Figure 44 The land use according to ministry regulations, enforcing the Lamlukka Town Plan, Bueng-yitho, and the Pathumthani Province B.E. 2555 (2012).

The Centro Rangsit site had no ministry restrictions enforcing the Lamlukka Town Plan, Bueng-yitho, and the Pathum Thani Province B.E. 2555 (2012). However, the project had to follow the Building Control Act and other ministerial regulations, such as height restrictions, opening minimum dimensions, and room area restriction. The ministerial regulation issue 55, number 44 states that the

height of the building at any point should not exceed twice the horizontal length from the opposite side of the public road. The public road inside the development is 6 meters for a two-way road, with a 1-meter public sidewalk on each side. With the two-meter setback from the plot, the building height should not exceed 20 meters (

Figure 45). The precast concrete modules need to be transported to the selected site with a trailer truck, so the laws from the Department of Land and Transport must be followed. The maximum dimensions of the truck and its weight restrictions are the transportation laws that are related to the project. Therefore, the modules will be designed following the framework of building laws and transportation laws. Ministerial regulations issue 60 B.E. 2552 (2009) and 9 B.E. 2524 (1981) limit the length to be ≤ 8 m for trailer trucks, with the maximum height of ≤ 4 m, and width of ≤ 2.55 m. For semi-trailer trucks, the maximum length is ≤ 13.6 m, with a height of ≤ 4 m and a width of ≤ 2.55 m. The Highway Act B.E. 2535 placed weight restrictions for each type of trailer trucks. The four-wheeler's weight limit is 15,000 kg, six-wheeler is 25,000 kg, eight-wheeler is 30,000 kg, and 47,000 kg for ten-wheeler trailers. The semi-trailer has a limit of 45,000 kg for ten-wheeler trucks and 50,500 kg for twelve-wheeler trucks.

Figure 45 The site boundary with a two-meter setback regulation.

The site boundary for each detached house is 16,700mm by 13,600mm. When the regulation is applied to the site, the buildable area becomes 12,700mm by 9,600mm. The two-story single-detached house needs to be within the buildable area and cannot have any extensions over the area.

The design of the precast concrete wall is based on an ACI Standard – Building Code Requirements for Structural Concrete (ACI 318-19), 2019, the universal recognized concrete building code from American Concrete Institute. The ACI 318-19 provides a requirement for materials, design and structure detailing for a structural concrete building. In chapter 11 – Walls, the section 11.3 – *design limits* sub-section 11.3.1 – *minimum wall thickness* that states a guideline for the precast concrete wall thickness. The wall type in the redesigning of the Centro Rangsit required a bearing wall type (Figure 46).

Table 11.3.1.1—Minimum wall thickness h

Wall type	Minimum thickness h		
Bearing ^[1]	Greater of:	4 in.	(a)
		1/25 the lesser of unsupported length and unsupported height	(b)
Nonbearing	Greater of:	4 in.	(c)
		1/30 the lesser of unsupported length and unsupported height	(d)
Exterior basement and foundation ^[1]		7.5 in.	(e)

^[1]Only applies to walls designed in accordance with the simplified design method of 11.5.3.

Figure 46 ACI Standard – Building Code Requirements for Structural Concrete (ACI 318-19), 2019 sub-section 11.3.1 – minimum wall thickness.

In accordance with the minimum wall thickness of 4 inch which are 10.16 cm, The two-story detached house with the load bearing precast concrete wall in the redesign will used a 12 cm thick wall panels for a main structure of the building.

5.2. Space planning and panel division

The precast concrete construction has four main stages: Design, production, transportation, and installation. The design phase is to follow the three steps of architectural, structural, and detailed design. The architectural design phase is the building position and foundation positioning, where building grids and floor to ceiling height are designed. The architecture design sets an overall design for the house. The interior space planning and the exterior spacing is set in this phase. The structural design is the design for the precast concrete modules for the connection and joinery design. The detailed design is the design for building efficiency and the design of temporary bracing (Yodpruktigarn, 2011 #17).

The architectural design phase is the positioning of the building and foundation which rely on the building grid. The Avid unit main grid planning is an unequal division of 9,500mm by 6,200mm. The precast concrete panels had various lengths, which are 3,000mm, 3,100mm, 3,200mm, and 3,400mm (

Table 41). The Bravo unit main grid planning is an unequal division of 9,500mm by 6,800mm. The precast concrete panels had various lengths, which are 3,000 mm, 3,050 mm, 3,100 mm, 3,200 mm, 3,400 mm, and 3,750 mm (Table 42).



Table 41 Illustration of the Centro Rangsit Avid units wall panel plans and elevation.

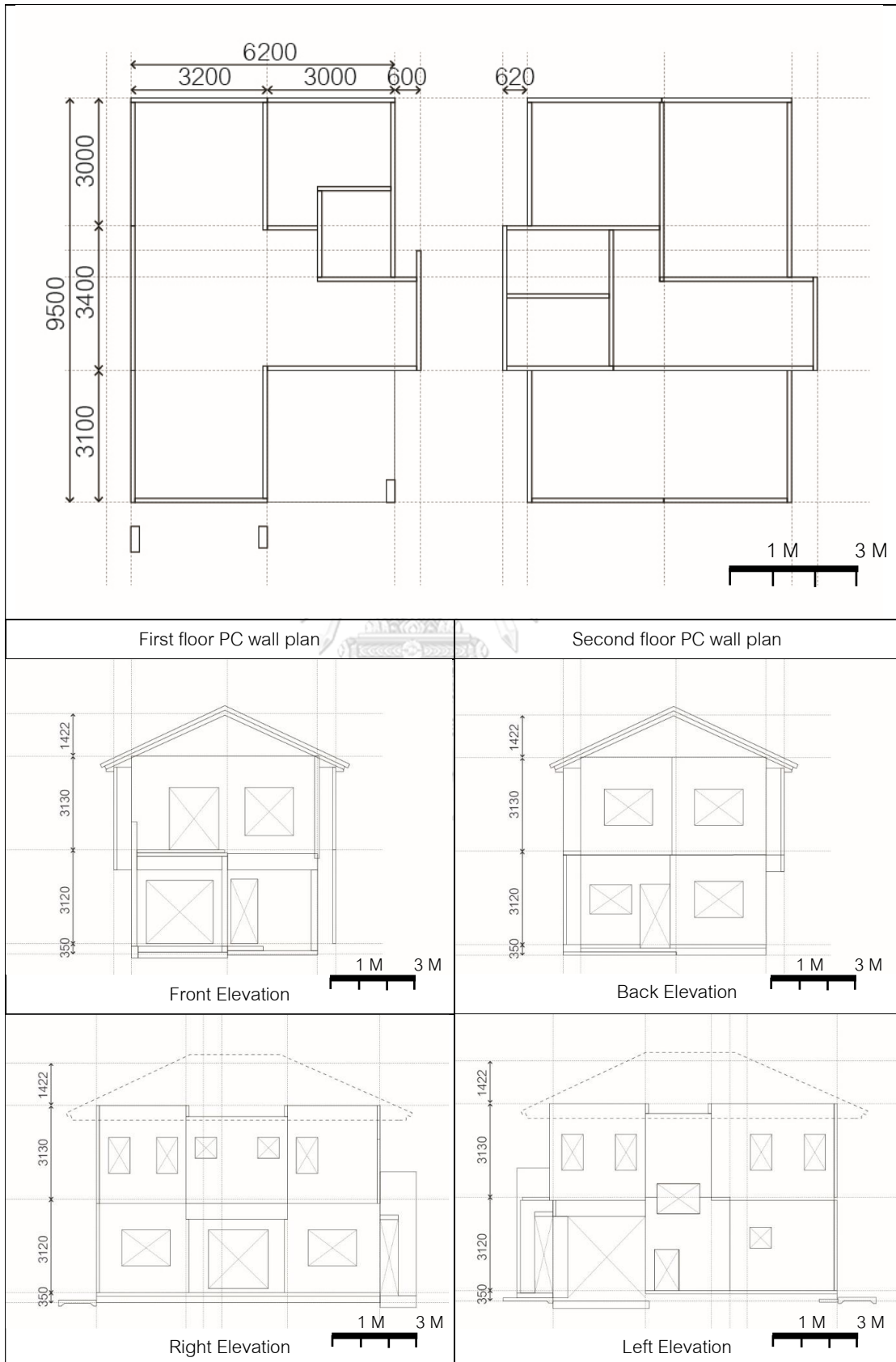
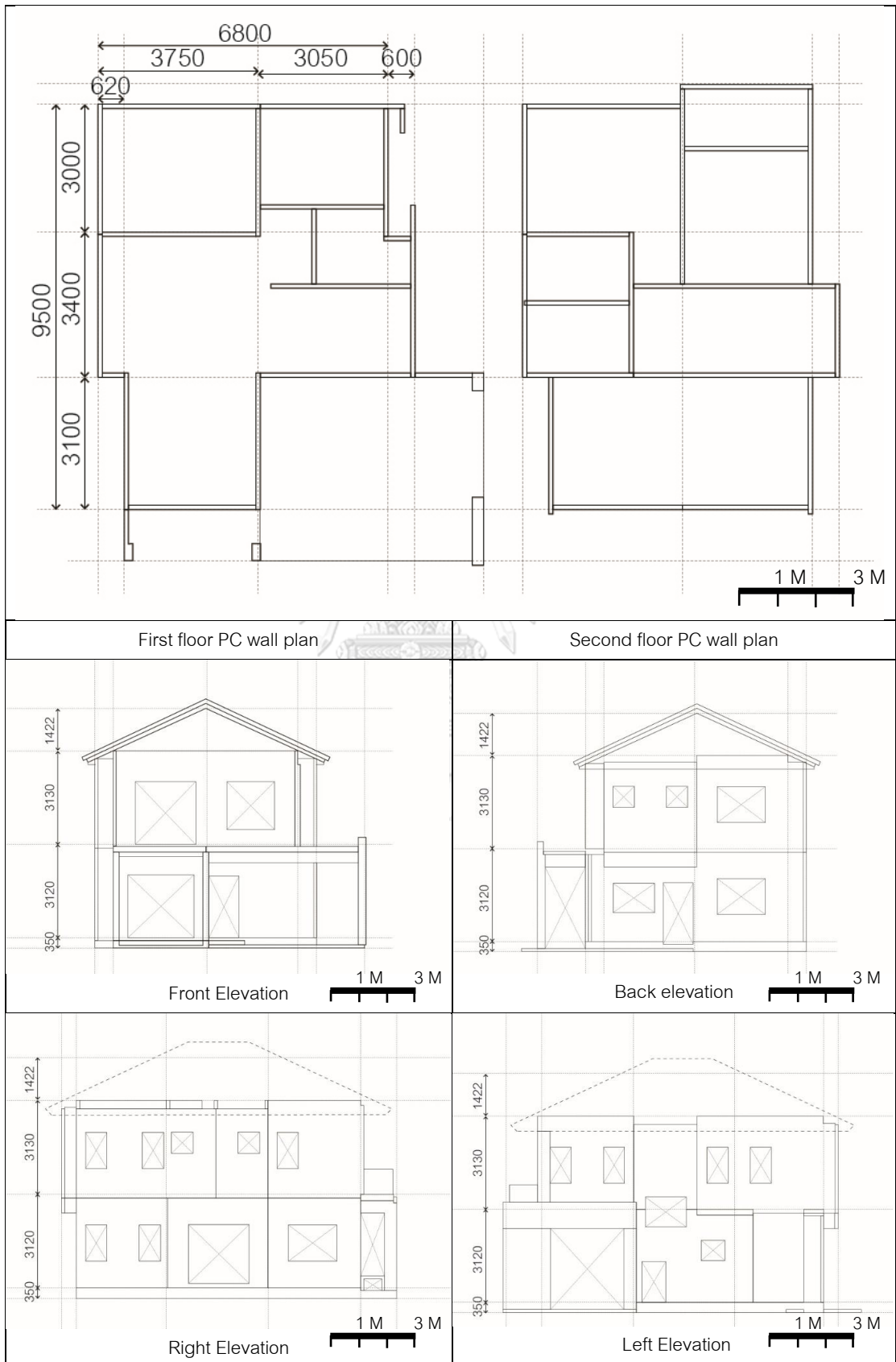

Table 42 Illustration of the Centro Rangsit Bravo-B units wall panel plans and elevation.



The positioning of building grids is related to space planning and will incorporate the modular system principle. The modular system is generally a design theory and practice that divides the panels (modules) so that they can be reused or rescaled between systems. The full modular system exists so that all modules are the same and the system can be adapted without interruptions. The modular system can also be an application of a system that standardizes the module size. In this case, the principle will set a grid division that controls the length of the panels of the project system. The panels' dimensions determine the number of precast concrete formworks. When the panels have the same dimension, it helps reduce the number of formworks in the production phase (Figure 47).

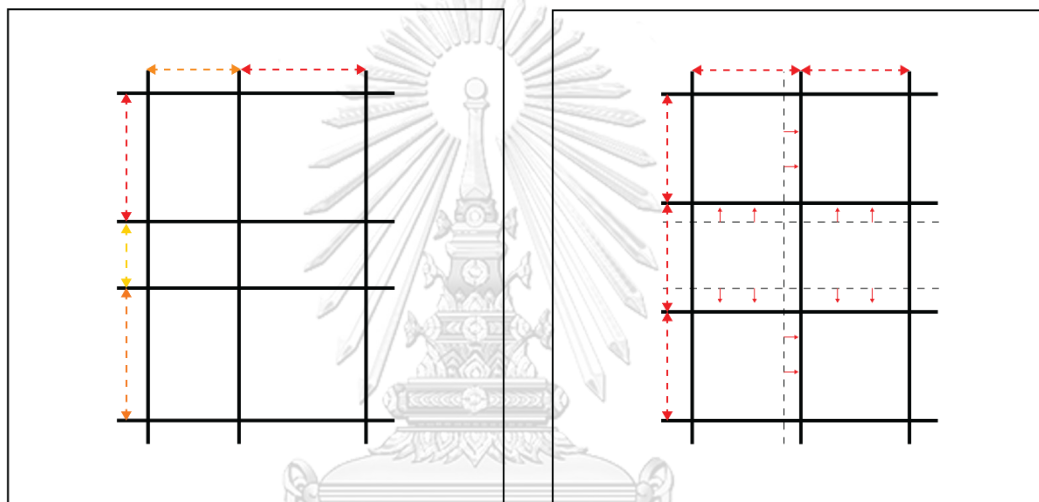

Figure 47 Space planning that considers the modular system principle.

The space planning principle is combined with panel division to maximize protection against water leakage. Panel division is a design principle that considers planning and positioning of the wall length. Good integration of modular space planning and panel division will reduce the number of panels for each unit. The number of panels determines the number of connections. The design of precast modules needs to take transportation into consideration. This factor limits the shape, size, and weight of the module. The modules depended on the mode of transportation and hosting machine. For land transport, trailer trucks are commonly used. Trailers must meet certain dimensions and weight regulations by law. Ministerial regulations issue 60 B.E. 2552 (2009) and Ministerial regulations issue 9 B.E. 2524 (1981) limit the length of trucks and goods. The trailer truck limits the shape and size of the modules that can be attached to it. Another limitation is weight; this depends solely on the transportation type and crane capacity. The weight limit is combined with truck weight and the module weight. To calculate the module weight, the volume of the module in cubic meters is

multiplied by 2,450 kg for concrete with steel reinforcement. Three generic types of crane in the market are tower cranes, mobile cranes and crawler cranes. The maximum length for a precast concrete wall panels is 6 m due to the length of the truck. The 6 m panels would weight up to 5,500 kg (5.5 tons). The construction site will require a higher lifting capacity crane than the mobile crane used in housing construction.



Figure 48 The maximum length for the panel is 6 m due to restrictions in transportation law.

The panels division in the proposed design will incorporate the 6 m panels length into the grid design to reduce the number of panels and, thereby, reduce the number of connection points. The grid planning should integrate the maximum panel size of 6 meters to decrease the number of connection points. The illustration in Figure 49 shows the integration of a longer panel length and compares the number of panels with the number of connections. The reduction of precast concrete panels helps reduce the number of connections. With fewer connection points, the possibility of water leakage is also lowered.

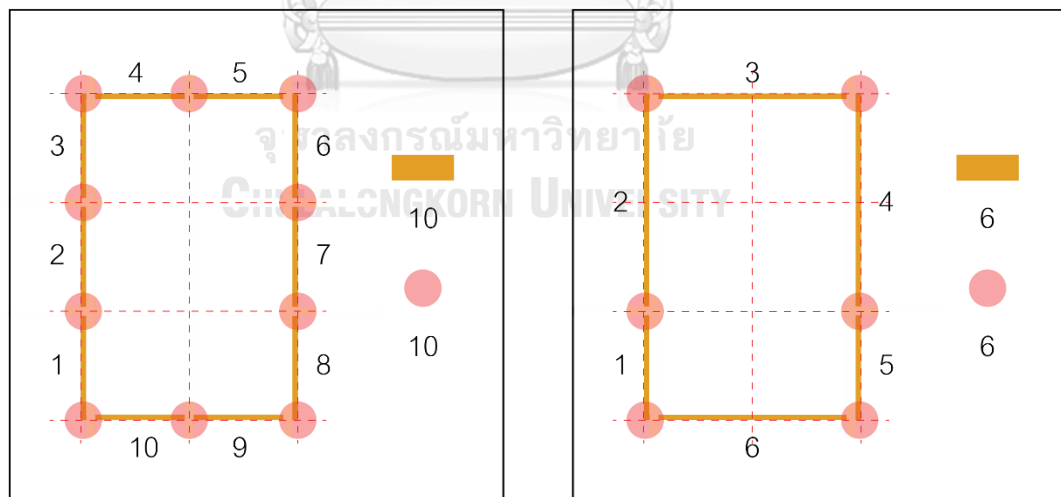
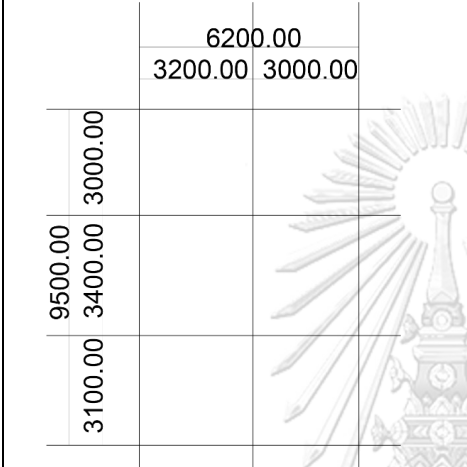
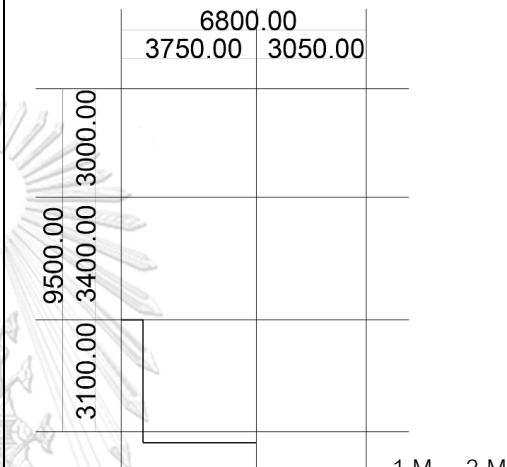
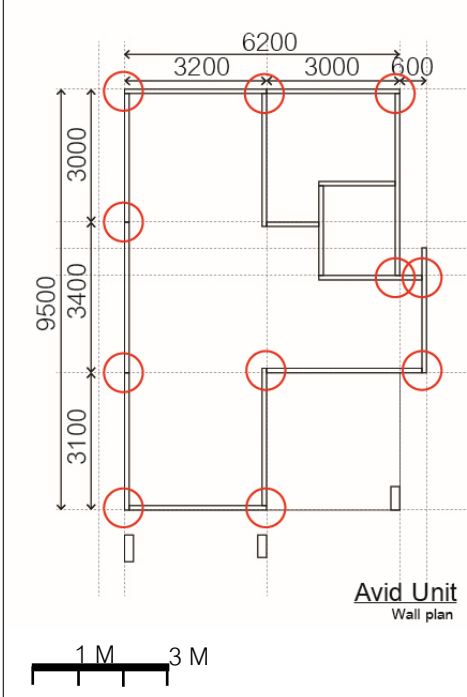
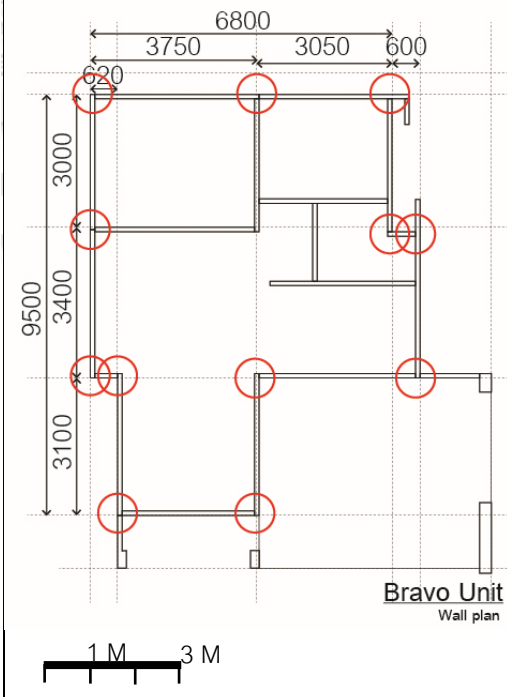

Figure 49 Panels division that reduces the point of connection principle.

The proposed design is a redesign of the three-existing Centro Rangsit two-story detached house module: Avid, Bravo-A, and Bravo-B. The proposed module will have an approach to the most efficient design to prevent water leakage. The redesign units will be called A-1 for Avid unit, A-2 for Bravo-A unit, and A-3 for Bravo-B unit.

Table 43 The table analyzing the Centro Rangsit existing grid and connection points.

Avid unit		Bravo unit	
			
49.9 sq.m		54.2 sq.m	
 <p style="text-align: center;">Avid Unit Wall plan</p>		 <p style="text-align: center;">Bravo Unit Wall plan</p>	
11 external p.c. panels		12 external p.c. panels	
11 external connection points		12 external connection points	

The Avid unit had 35 walls, 8 slabs, 5 beams, and 8 decoration pieces. The total number of panels used in the Avid unit is 56 panels. The thesis focuses on the external joints that are directly related to water leakage problems. The total length of the external connection is 215 meters. The Bravo unit had 40 walls, 8 slabs, 5 beams, and 5 decoration pieces. The total panels used in the Bravo unit are 58 panels. The length of connection in the Bravo unit is 254 m.

Table 44 The total number of Precast elements in The Centro Rangsit Avid and Bravo Units.

	Avid Units	Bravo Units
Walls	35	40
Slabs	8	8
Beams	5	5
Fin / Bua	8	5
Total number of panels	56	58

Table 45 The total length of the external joint in The Centro Rangsit Avid and Bravo units

Unit (M)	The Centro Rangsit	
	Avid Unit	Bravo Unit
Horizontal	102.86	135.49
Vertical	112.32	118.56
Total	215.18	254.05

The length of the connection will be used for calculation of cost analysis to compare the existing Centro unit to the proposed modules.

5.2.1. Proposed Modules

The grid planning that considers the modular system and the panels division to reduce the connection point is the first architectural design phase. The six-meter maximum length dimension became the framework of planning the grid for the proposed design. The new grid zoning for the proposed design chose the grid that can reduce the number of panels by using six-meter precast concrete panels.

The selected grid is chosen from the number of panels, the maximization of precast concrete formwork, and the area of the footprint. The number of panels identifies the number of the connection point of the project, whereas the reduction of formwork reduces the cost in the production

phase of the project. The proposed module footprint should not be too much different from the Centro Rangsit existing units. The plotting of the grid variations is in Figure 50 by modularity, from no maximum length to a maximum length of panels. The graph plotted 8 different variations of grid planning. The selected modules should be higher than the existing by 2 times and should be efficient to produce.

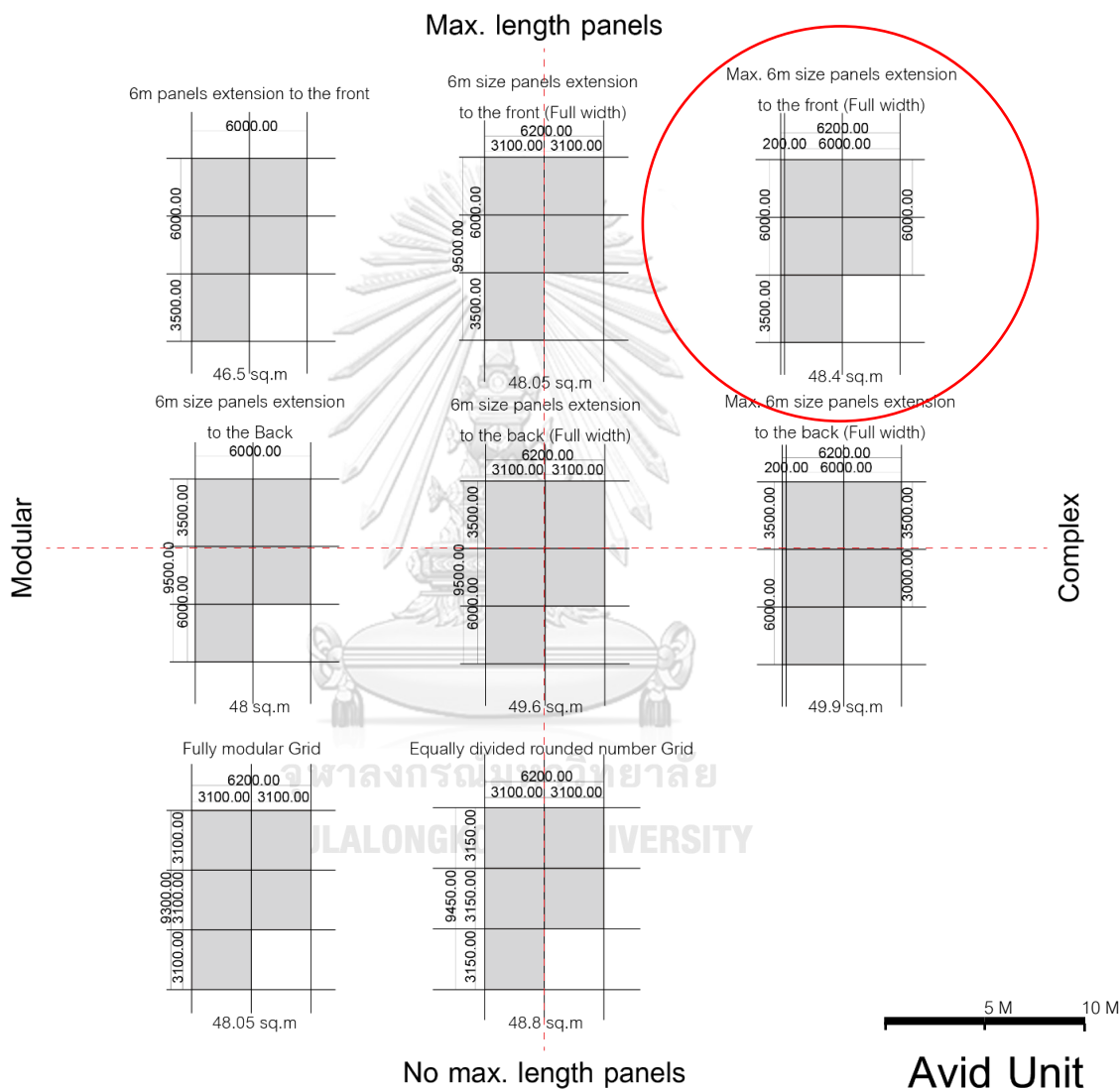

Figure 50 Design schemes for Avid unit grid planning.

The selected grid planning for the proposed module is the maximum 6m-sized panel extensions with a full width of 6200mm; 48.4 sq.m compared to the existing panel extensions of 49.9 sq.m. The selected 6m panels on three sides of the house. When comparing the number of panels and connection points of the existing Avid unit that has 11 external wall panels on the first floor, the new grid has reduced the number of panels to 7 external wall panels. Therefore, the connection point has reduced to 7 locations (Figure 51).

Max. 6m size panels extension

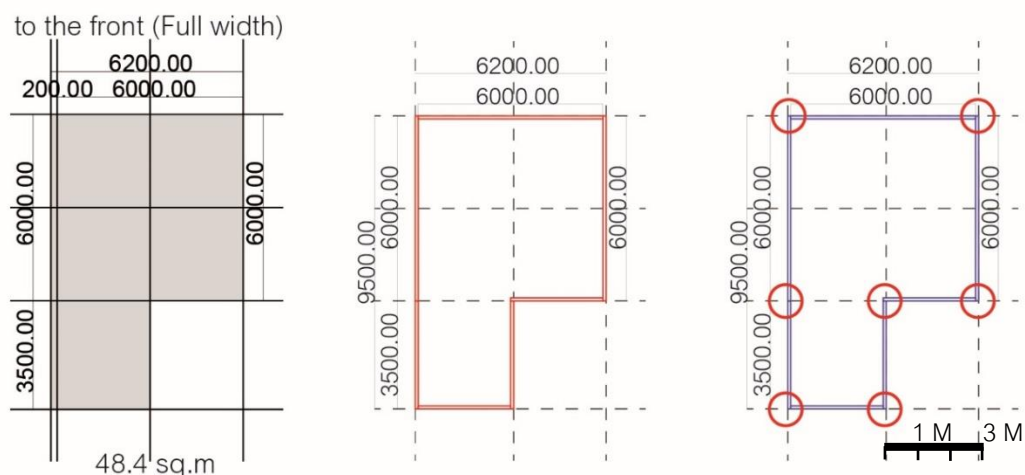

Figure 51 The selected maximum 6m-sized panels with extensions to the front with a full width of 6200mm.

The selection of the grid planning of the Bravo unit also followed the same criteria with the same plotted graph, from modularity to complexity and integration of the 6m panels. The graph had nine different variations of grid planning. Although the adaptation of a fully modular grid planning is good for the production phase, it reduces the building footprint by more than two sq m. The integration of the six-meter panels principle can reduce the number of points of connection without a decrease in building footprint.

The selected grid planning for the proposed module A is the “6m size panels extension to front with full width of 6800mm” and 52.7 sq m compared to the existing of 54.2 sq m. The chosen grid planning decreased the building footprint by 1.5 sq m, but the system had to integrate the 6 m maximum size for panels with the modular principle of repeated a 3,400 mm panels length. In addition, to take the modular principle to the next step, the Bravo unit building width was increased to 7,000 mm. The 3,500 mm formwork can be repeated three times on the right side and the back of the building. The repetition of the formwork increases the modularity of the design.

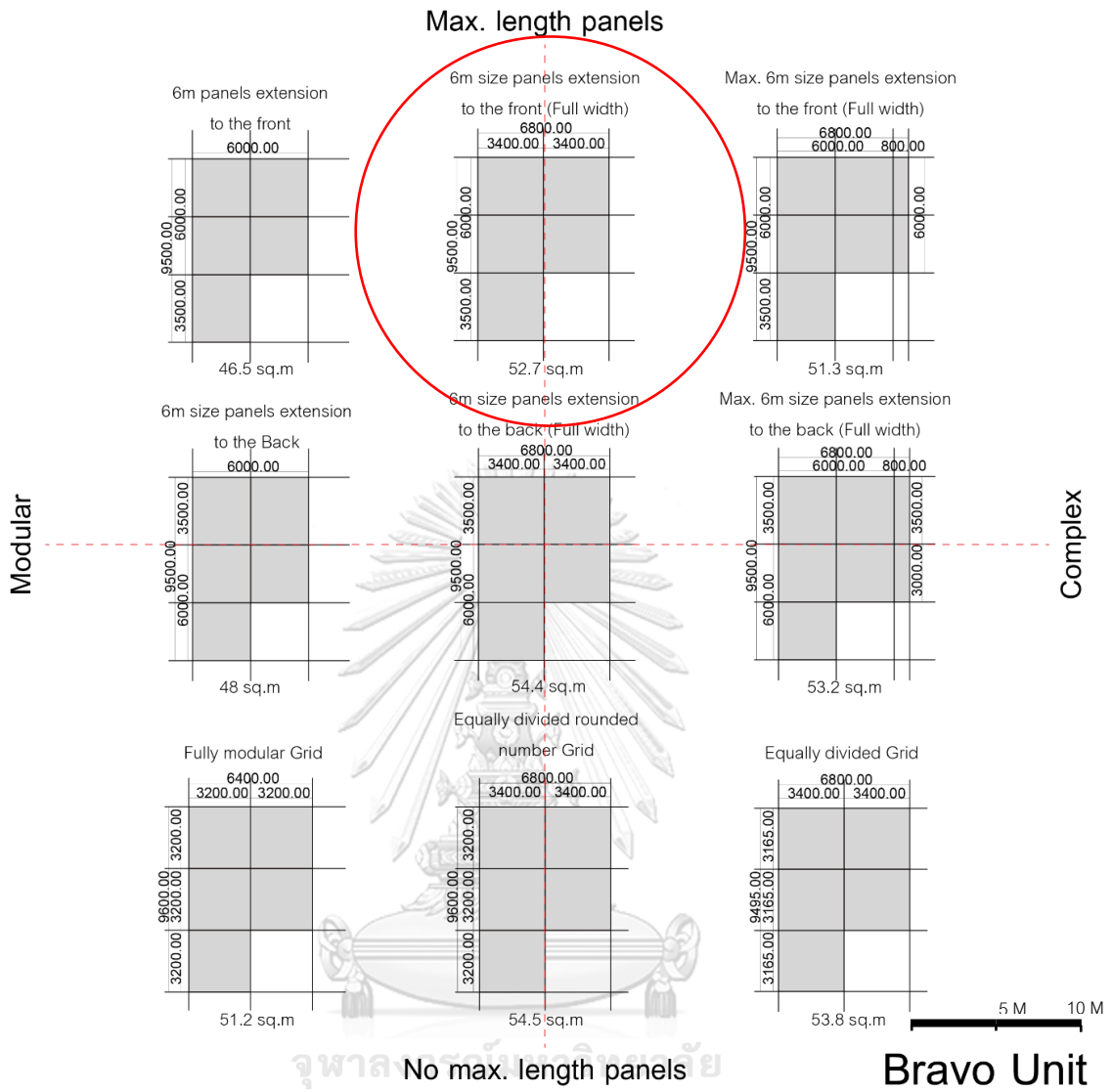

Figure 52 Design schemes for Bravo unit grid planning.

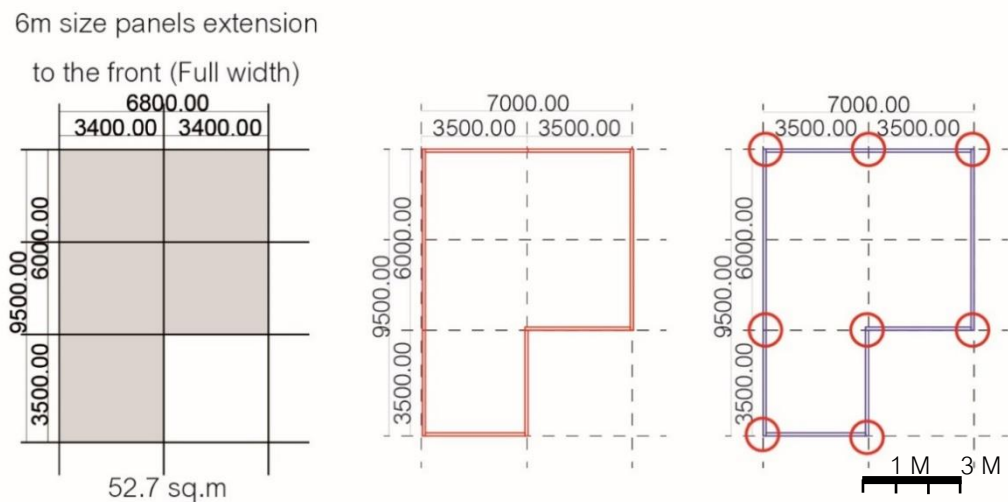

Figure 53 The selected “maximum 6m size panels with extension to the front – full 6800mm width” and their adjustment to achieve a more modular approach.

The number of external panels was reduced from twelve to eight panels for the first floor. The connection point of the proposed module decreased from twelve points to eight points. The possibility of water penetration points lessened from the controlled number of the joinery.

5.3. Additional elements to prevent water leakage

The additional extension of the overhangs helps reduce the water contact on the precast concrete surface by water deflection. The roof already acts as a water deflection element for the second-floor panels. The proposed module will incorporate the overhang element into the slab’s module of the second floor to extend out and protect the first-floor panels. The proposed module will apply a 600mm offset to the designed floor slab. The 600mm width is from the research from the “Rain Control in Buildings” article from the *Building Science Digest* journal (Straube, 2007 #38). The extended slabs are illustrated in Figure 54 for proposed module A.

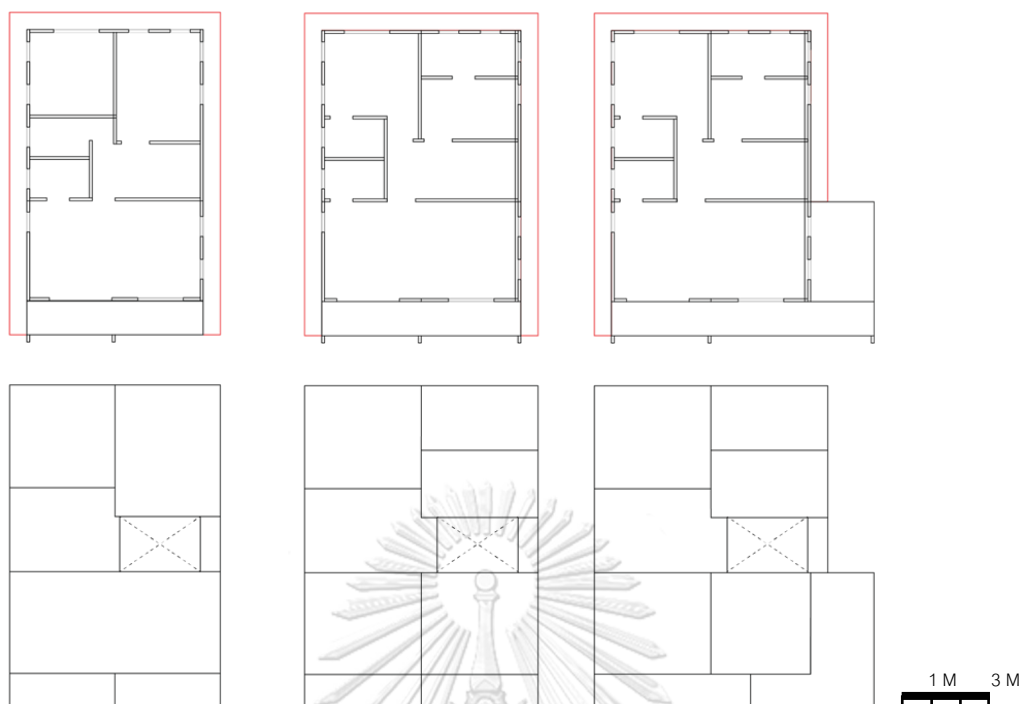

Figure 54 The overhang extension on the second-floor slabs of the integrated into the precast concrete floor slabs.

In addition to the extended flat slabs structure, the incorporation of a sloped overhang is being considered. The standard sloped angles of an awning installation are 5° , 10° , and 15° angles. For slabs with more than a 5° angle, the width of the overhang has to be deducted. The slope overhang reduces the water accumulation at the connection of the slabs and wall panels and helps discharge the water from the building.

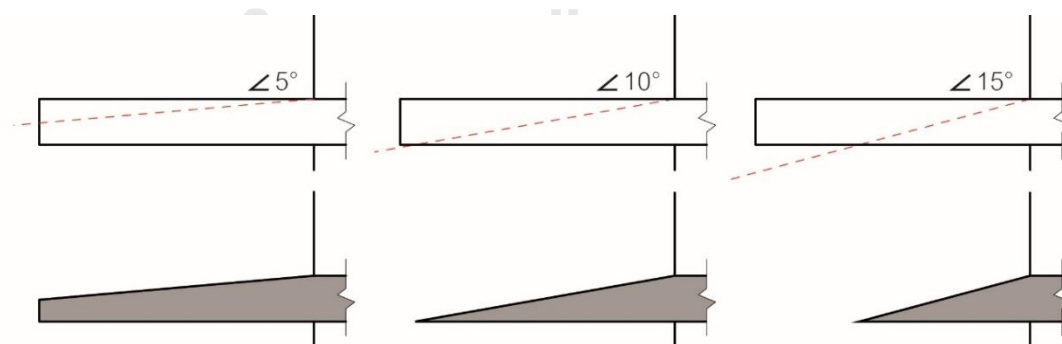

Figure 55 The awning angle variations of 5° , 10° , and 15° angles.

The proposed design is applying the 5° sloped overhang with a drip edge instead of the flat-slab overhang (Figure 56). This design acts as a water deflection element from the 600mm overhang: the slope and the drip edge act as a water discharge element of the design.

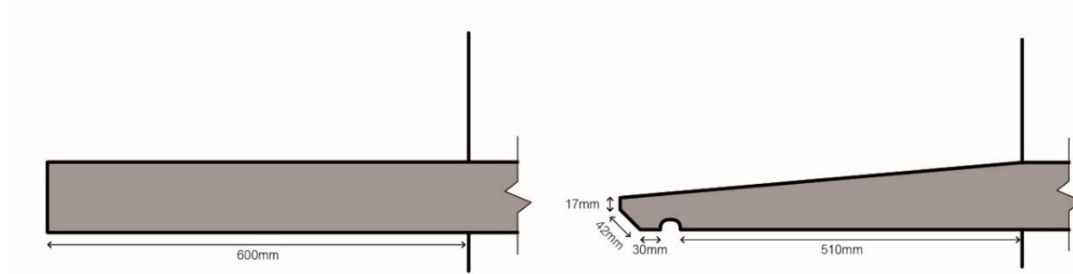

Figure 56 The flat-slab overhang (left) and a proposed 5° sloped overhang with drip edges (right).

5.4. Joint integration from the experimentation

The joinery type used in phase one Centro Rangsit development is a mix of dry application and a wet application. The dry process is to lock the precast concrete panels into place. The metal plate is pre-casted to the precast concrete panels. The external 6mm plate is attached to the pre-casted metal plate of the two panels. The next step is to weld the metal plate to secure the position. The gaps between the panels then need to be concealed with the wet joint application of grouting. The non-shrink cement mix is poured (injected) into the gaps and let dry. The finishing process is to apply the polyurethane sealant to the external side of the joint. The joint is then coated with a waterproofing solution on the external side. The connection includes a wall-to-wall connection, a walls-to-slabs connection (Figure 57).

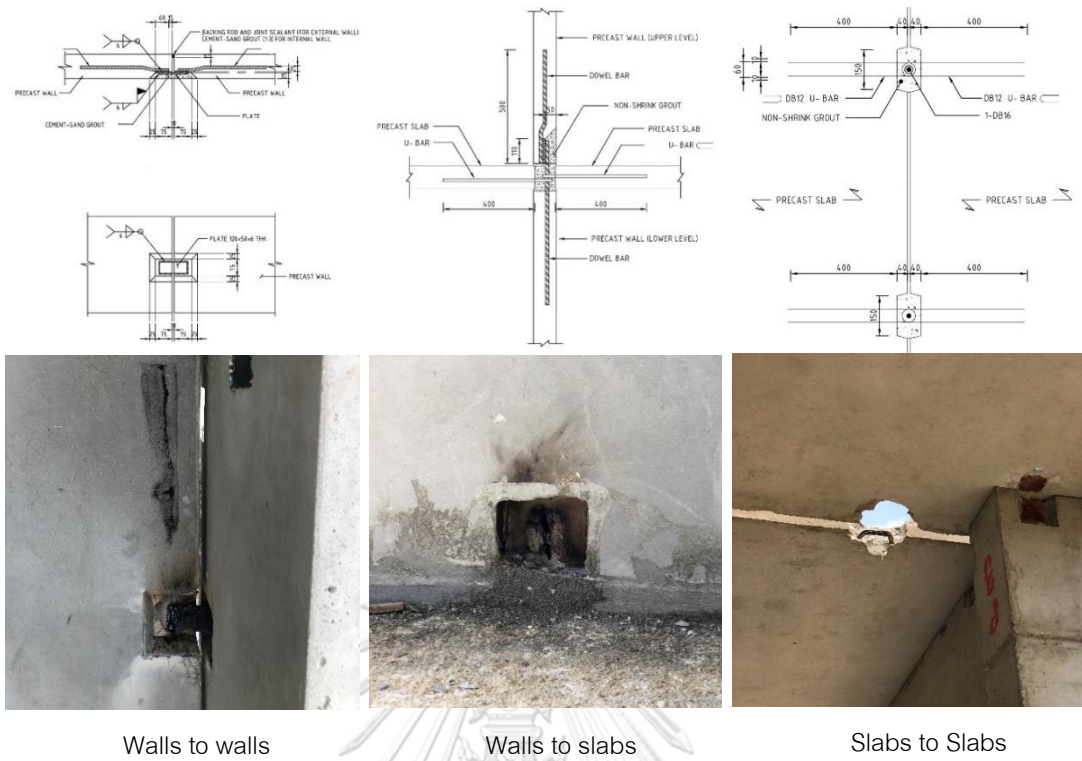

Figure 57 The joinery installation at the Centro Rangsit development. The walls to walls connection (left), the wall-to-slab connection (Middle), and a slab-to-slab connection (right).

The proposed design for the joints is based on the experimentation in the water prevention mechanism. The selection is based on the water test that proves the effectiveness of rainwater and wind-driven rainwater. The scarf drain joint controlled the water path and discarded the water out of the joint system. The integration was separated into two phases: the scarf precast concrete panels in the production phase and the application of the drain joint in the installation phase (Figure 58).

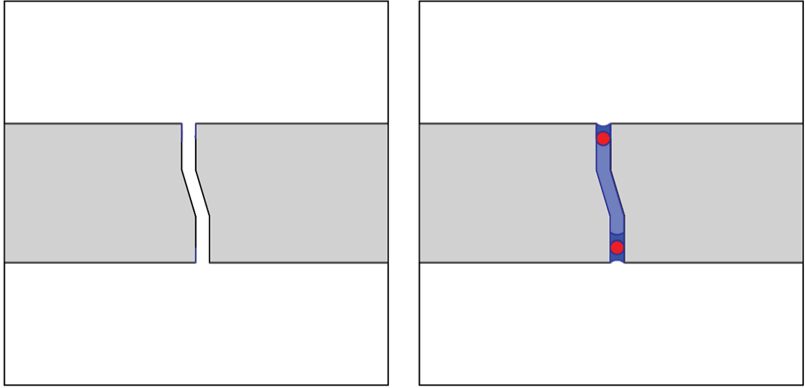

Figure 58 The scarf details on the side of the panels (left) and the scarf drain joint details (right).

The production phase consisted of an installation of a metal formwork, a blocked-out piece, a metal plate, and a system element. The existing formwork had a flat side piece that produced flat sidewall panels. The proposed walls panels had a scarf detail to increase the water prevention mechanism in the proposed design. The experiment proved that the scarf drain joint performs better than the flat side drain joint. The one-way scarf detail is applied to the folds on the metal formwork. The scarf wall panels are from the manufacturing of the panels in the production phase (Figure 59).

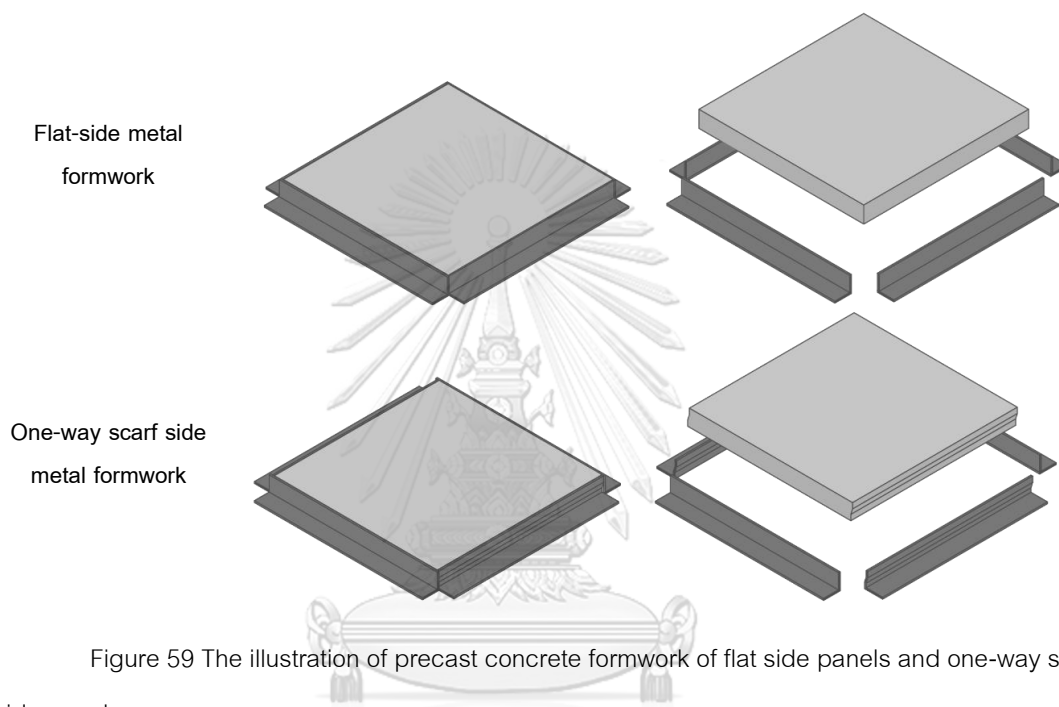

Figure 59 The illustration of precast concrete formwork of flat side panels and one-way scarf side panels.

The proposed design will use a mixed dry joint application. The precast metal plate is placed into the precast concrete panels in the production phase. The installation process of the joint entails positioning and securing it by welding the 6 mm thick metal plate connecting the panels together. The foam backer rod is inserted first in the panel's gap on the internal side in a linear, top-to-bottom direction. The second foam backer rod is inserted in a top-to-bottom direction and forms a curved shape at the weep hole. The polyurethane sealant can then be applied along the internal and external sides of the connection. The third layers of the foam backer rod can then be installed in a linear, top-to-bottom direction on the external side of the connection. Polyurethane sealant is then applied on the external side of the backer rod of the third layer, leaving 20 mm gaps that act as water exit holes at the top and the bottom of the connection.

5.5. Design implementation of the two-story precast concrete detached house

The research findings show that the highest percentage of water leaks occurs in the joints. The proposed design focuses on reducing the number of joints, using efficient joints, and increasing protection for the joints (). The proposed joints are evaluated from the water test conducted on three selected types of joints from the literature review. The most suitable joint is the scarf drain joint because it had the lowest change in temperature. Additionally, the joint mechanism allowed water to penetrate the outer layer that caused the change in temperature represented in the collected data.

Apart from the joint design, there is also the architectural design to improve the existing module. The proposed design is from the implementation of the space planning and panel division principle that applies a new grid to the Avid and Bravo redesign. The design had a full-length panel of six meters to reduce the number of joints. The grid planning reduced the amount of module variation in order to lower the cost of production. The 3500mm panels can be applied to both the Avid and Bravo units. The standardization of modules increases the modularity of the redesign.

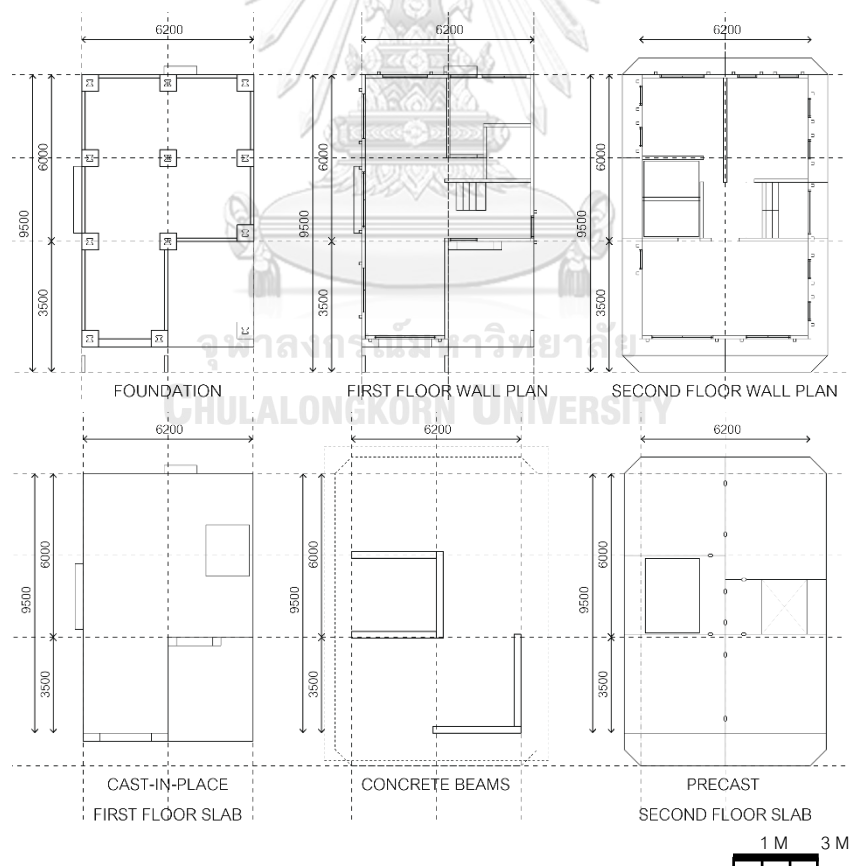

Figure 60 Proposed design module drawing of an A1 unit foundation, floor slabs and precast concrete wall plan.

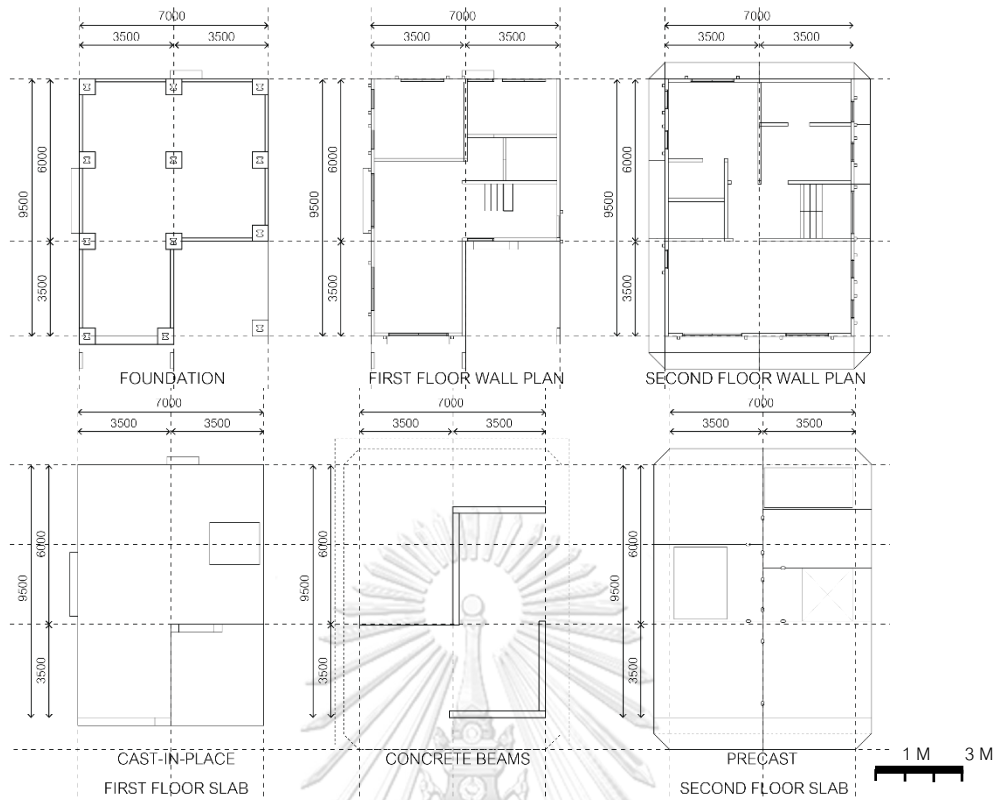

Figure 61 Proposed design module drawing of a A2 unit foundation, floor slabs and precast concrete wall plan.

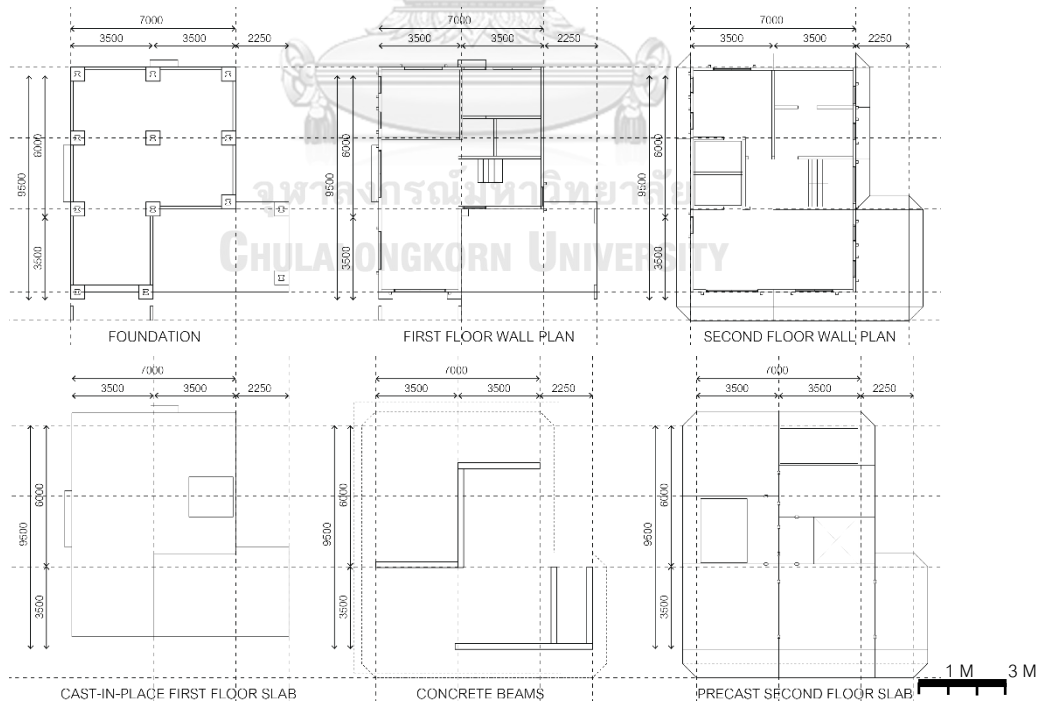

Figure 62 Proposed design module drawing of a A3 unit foundation, floor slabs and precast concrete wall plan.

ARCHITECTURE WINDOW		ARCHITECTURE DOOR	
AW 1	1600.00 1200.00	AD 1	2200.00 2090.00
AW 2	2000.00 1950.00	AD 6	800.00 1340.00
AW 3	1400.00 1000.00	AD 7	2000.00 2070.00
AW 4	1200.00 700.00	WOODEN DOOR	
AW 5	800.00 700.00	WD 1	890.00 2070.00
AW 6	700.00 700.00	WD 2	800.00 2020.00
AW 7	1400.00 1010.00	WD 3	990.00 1940.00
AW 8	1600.00 1600.00	WD 4	990.00 2040.00
AW 9	1700.00 2070.00	WD 5	990.00 2040.00

Figure 63 The selection for the opening dimension based on the existing Centro Rangsit opening.

The variation of openings in the Centro Rangsit had 17 modules. The 17 dimensions of the opening mean that the blocked out module in the production is 17 different sizes. The dimensions of the opening are not much different from one another. The cut down on the number of modules type will save costs in the production phase. The proposed design had selected 10 modules out of the 17 modules to use in the project. The selections are based on the usage type for opening. The five selected windows are AW1 for a big window, AW2 for a large window, AW3 for a horizontal window, AW4 for a vertical window, and AW6 for a bathroom window. The two architectural doors are the AD1 for a large door and an AD6 for the service door under the staircase. The two wooden doors in the proposed design are WD3 for the back door and WD5 for the main front door (Figure 63).



Figure 64 Space planning for the proposed design of the A1, A2, and A3 unit.

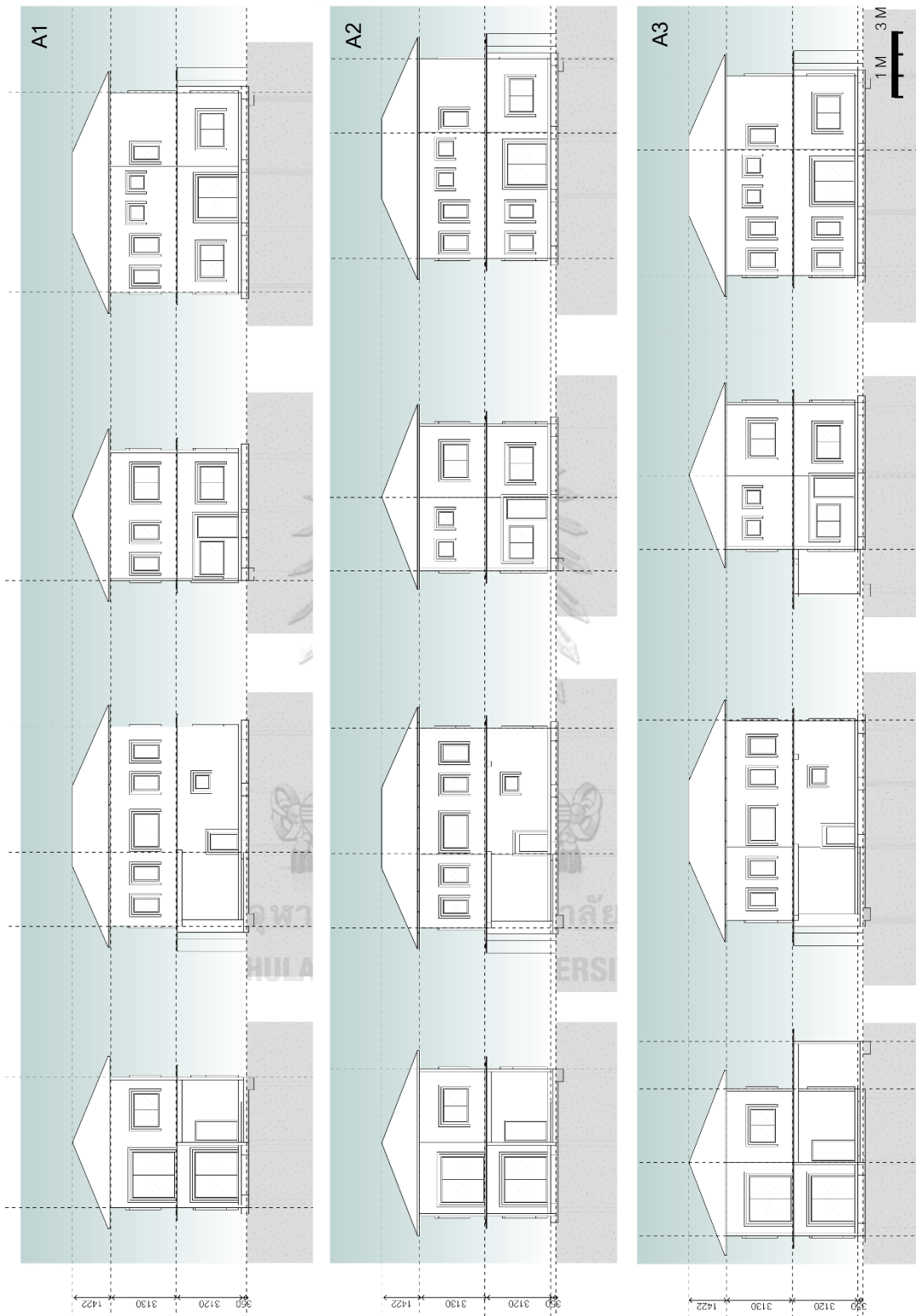

Figure 65 Elevation drawing of the proposed design A1, A2, and A3.

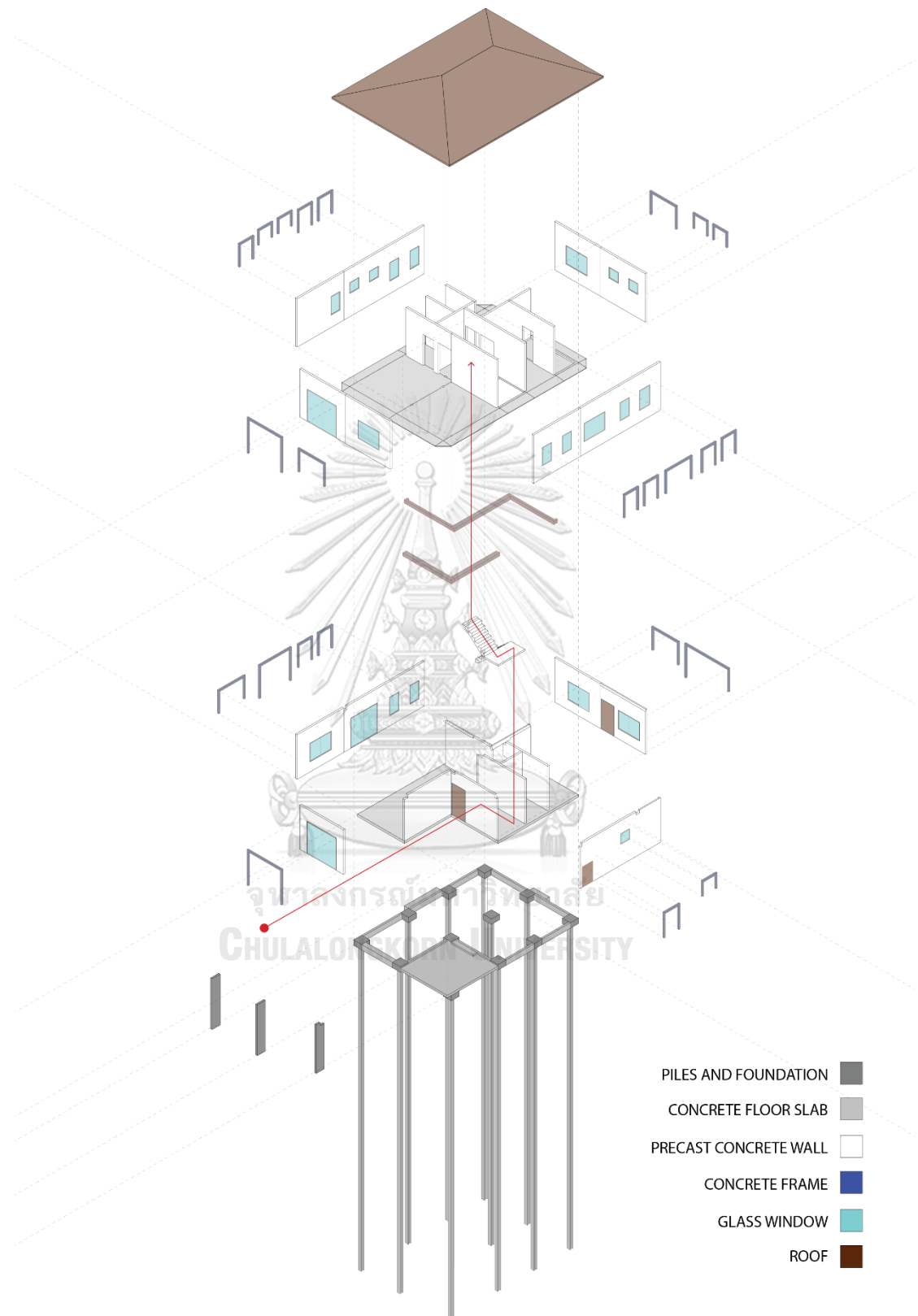

Figure 66 Exploded axonometric of the building components in the proposed A2 units.

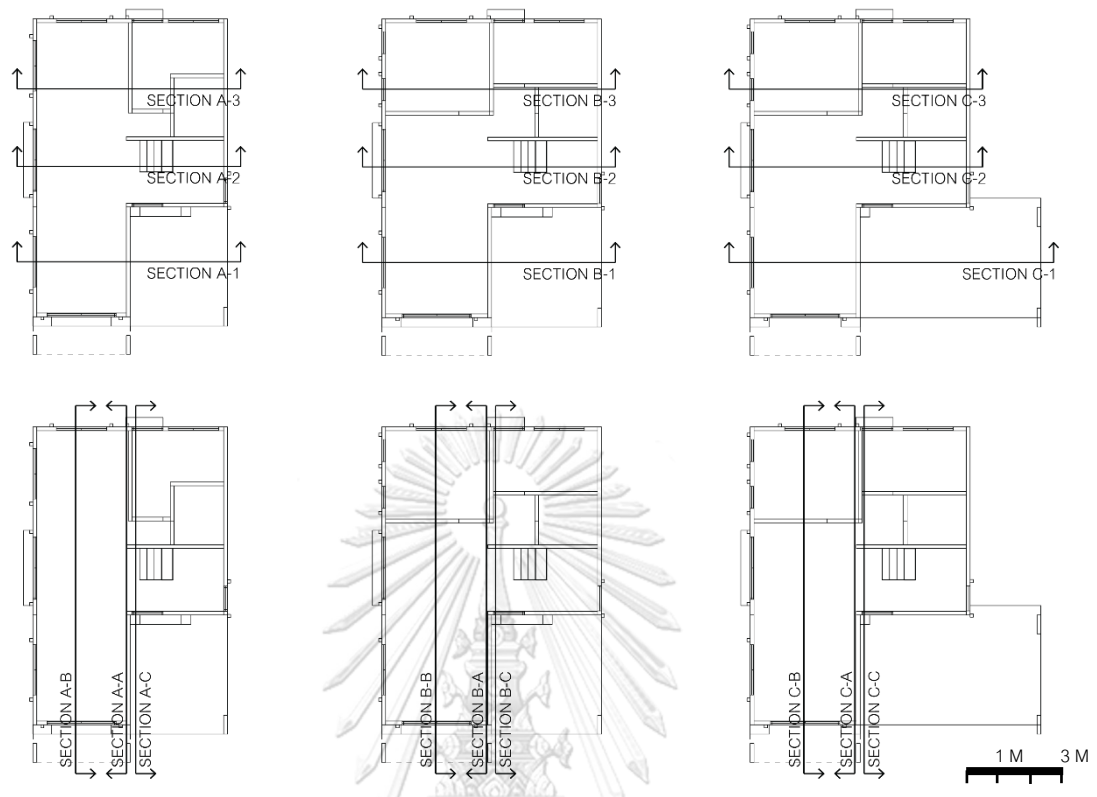

Figure 67 Illustration of a section cut location of A1, A2, and A3 unit.



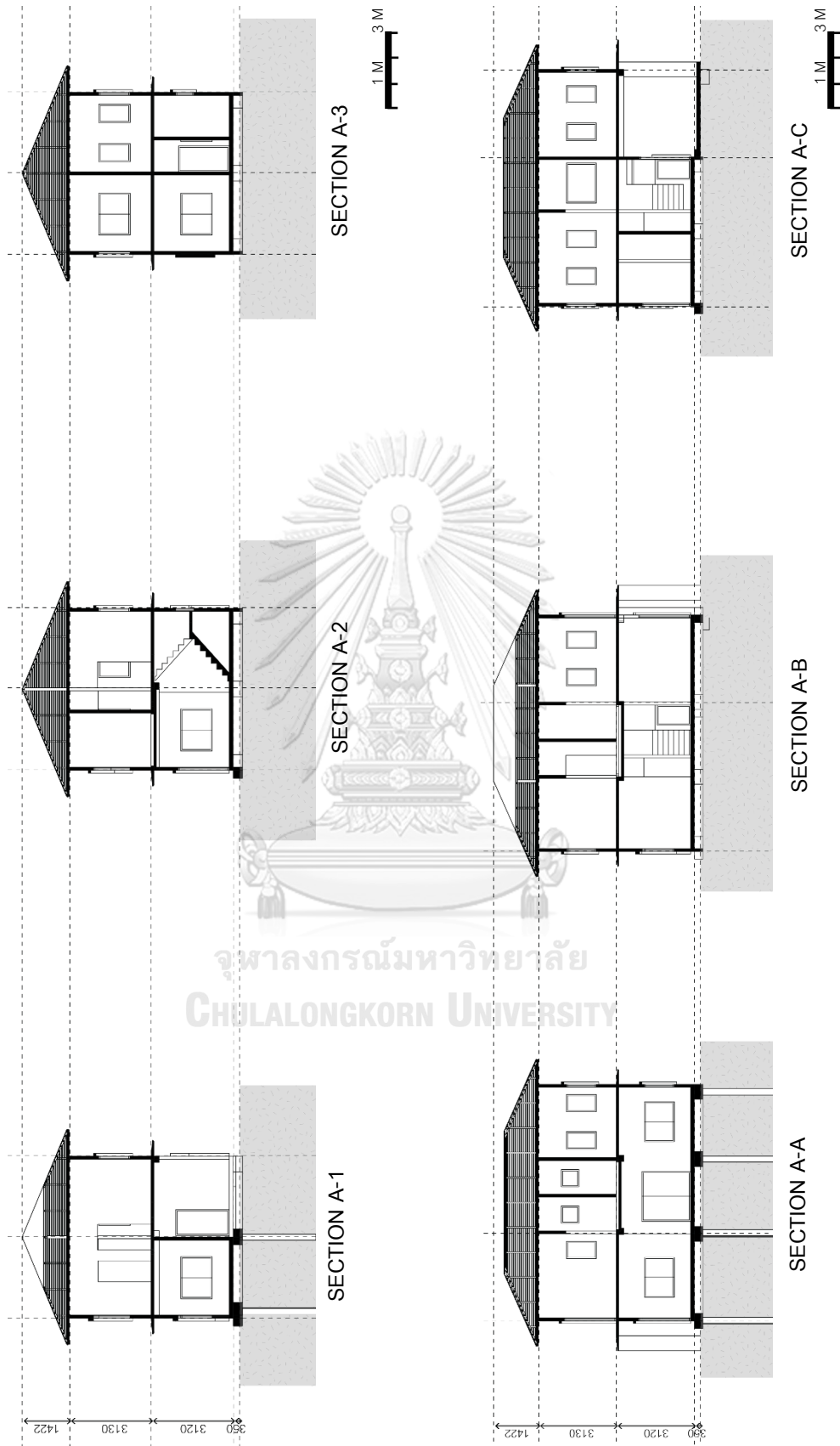

Figure 68 Drawing of front section cut of A1 unit at section A-1, section A-2, section A-3 and a side section cut of A1 unit at section A-A, section A-B, and section A-C.

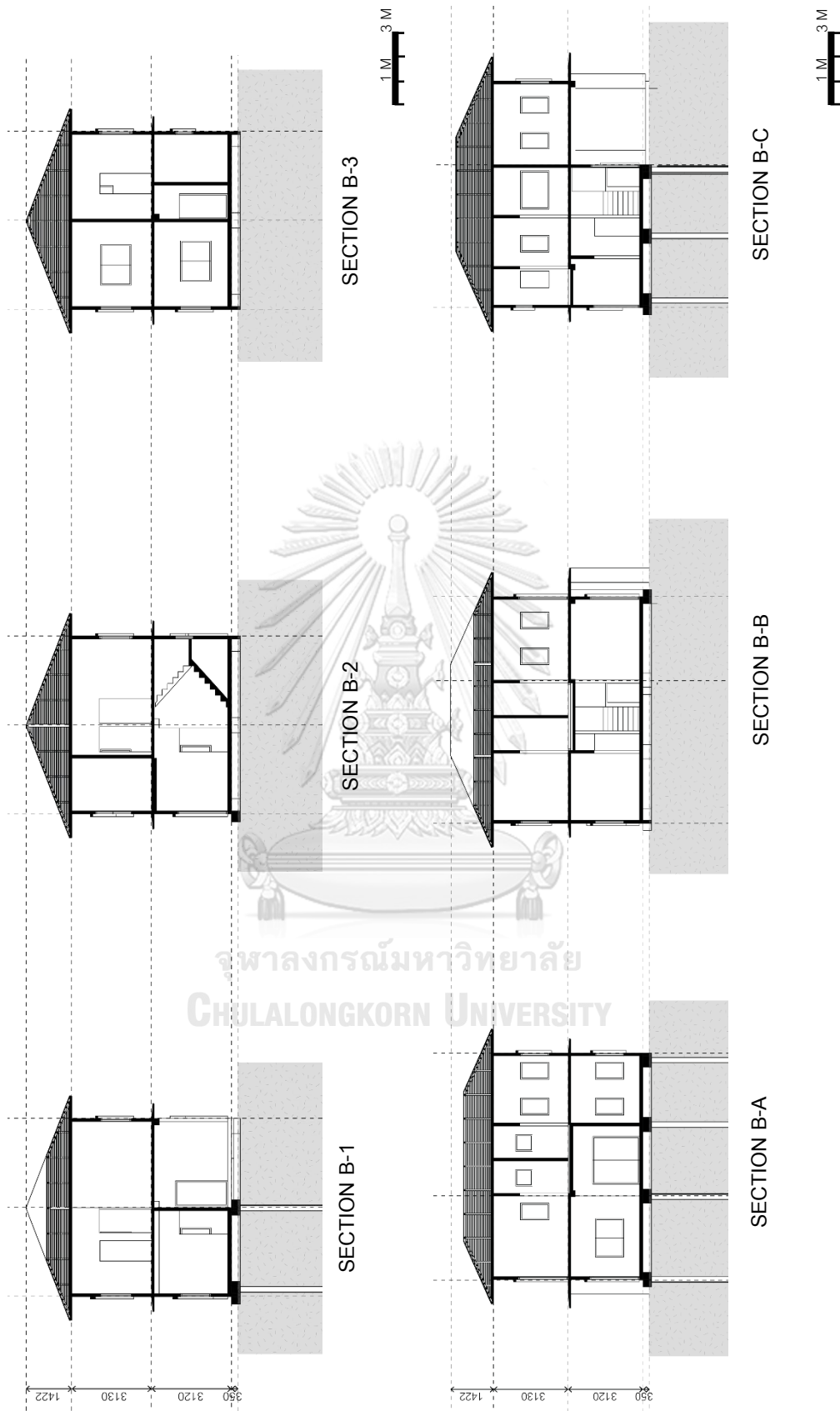

Figure 69 Drawing of front section cut of A2 unit at section B-1, section B-2, section B-3 and a side section cut of A2 unit at section B-A, section B-B, and section B-C.

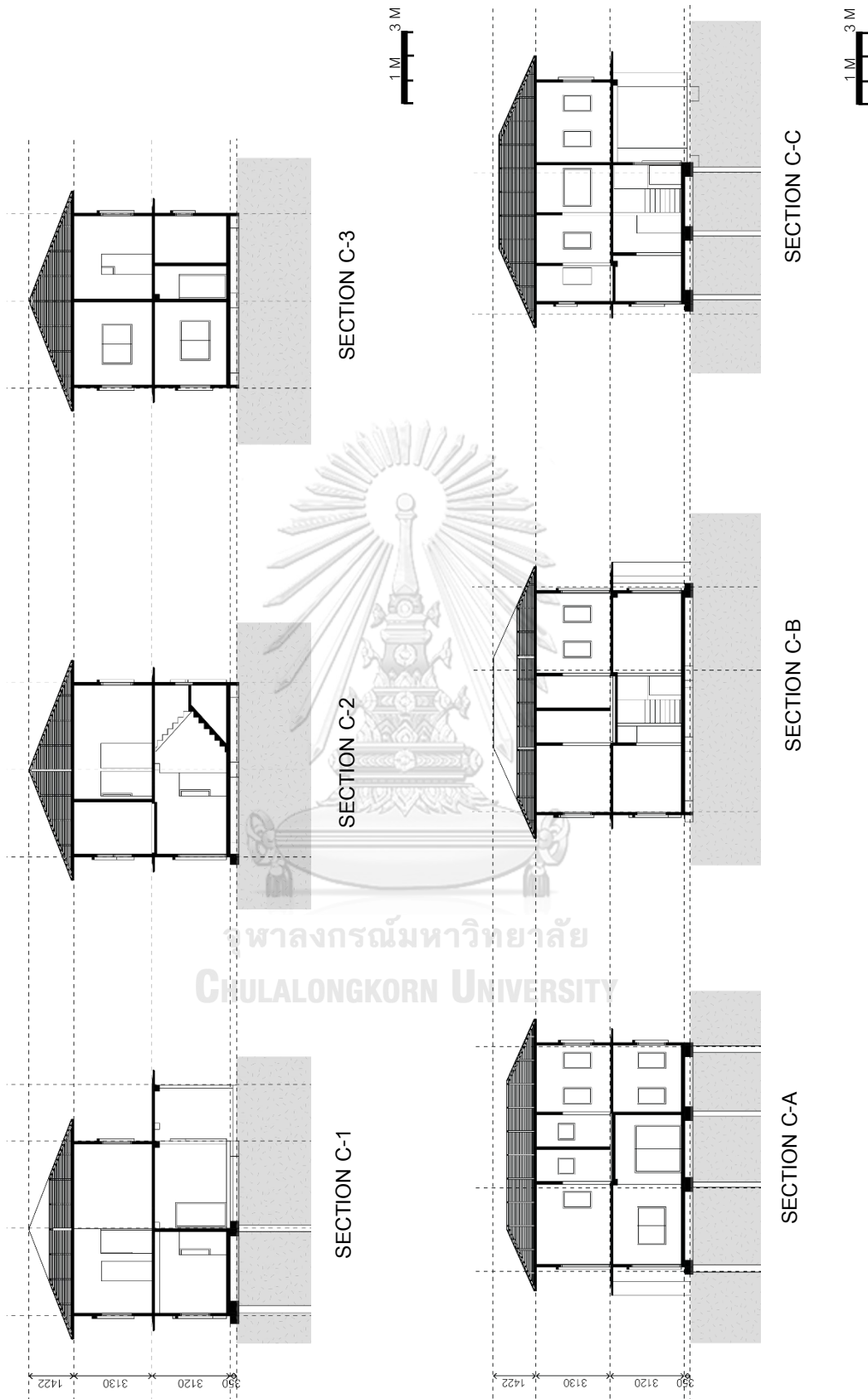

Figure 70 Drawing of front section cut of A3 unit at section C-1, section C-2, section C-3 and a side section cut of A3 unit at section C-A, section C-B and section C-C



Figure 71 The perspective view of the proposed module A-1 (The Centro Rangsit Avid unit redesign).



Figure 72 The perspective view of the proposed module A-2 (The Centro Rangsit Bravo-A unit redesign).



Figure 73 The perspective view of the proposed module A-3 (The Centro Rangsit Bravo-B unit redesign).



Figure 74 The perspective view of the proposed two-story detached house of The Centro Rangsit phase 2.

5.6. Financial analysis

The Centro Rangsit uses a one-stage joint grouting method combined with the application of a polyurethane sealant on the external layer. The cost of material of the Centro Rangsit joint per one meter is 38.56 baht, whereas the scarf drain joint material costs 77.44 baht per meter. The proposed joinery adds 38.88 baht more to the material cost per meter (Table 46).

Table 46 Material cost per meter for the Centro Rangsit development and the proposed scarf drain joint

	Cost per units	The first phase house modules	The proposed modules
Non-shrink mortar (m3)	22,728	0.001	-
Backer rod (m)	7.55	-	3.127
Sealant (m3)	316,667	0.00005	0.00017
Total (baht)		38.56	77.44

The Centro Rangsit Avid unit has a total connection length of 216 m when compared to the proposed module A-1 with a length of 286 m. The new module has higher number connection length of 70 m. Bravo-A and Bravo-B units has a total connection of 255 m when the proposed modules A-2 has the total length of 318 m and the proposed modules A-3 has the length of 320 m. The proposed module has higher connection length of 63 m in Bravo-A and 65 m in Bravo-B (Table 47).

Table 47 The total length of connection in the Centro Rangsit first-phase houses and the proposed modules

Unit (M)	The first phase house modules		The proposed modules		
	Avid	Bravo-A/B	A1	A2	A3
horizontal	103	136	195	215	217
vertical	113	119	91	103	103

total	216	255	286	318	320
-------	-----	-----	-----	-----	-----

The proposed modules have a greater connection length when compared to the Centro Rangsit, and also the material cost for the joint installation is higher. The calculation of joinery cost in the Avid units is 8,328.96 baht per unit, and the Bravo-A/B unit joinery cost is 9,832.80 baht per unit. The proposed module A-1 had a joinery cost of 22,147.84 baht per unit. The proposed modules A-2 had a total joinery cost of 24,625.92 baht per unit and A-3 had a total joinery cost of 24,788.80 baht per unit (Table 48).

Table 48 The total joinery cost per house in the Centro first phase house modules and the proposed modules A-1/A-2/A-3

	The first phase house modules		The proposed modules		
	Avid	Bravo-A/B	A-1	A-2	A-3
Total length of joint (M)	216	255	286	318	320
Cost per meter (Baht)	38.56	38.56	77.44	77.44	77.44
Total (Baht)	8,328.96	9,832.80	22,147.84	24,625.92	24,788.80

The cost of joinery is higher in the A-1 compared to Avid unit by 13,818.88 baht and higher in A-2/A-3 compared to Bravo unit by 14,793.12 baht and 14,956 baht. The cost of change in the proposed joinery doubles the previous joinery design. However, the scarf drain joint design prevents the water from entering the inner layer of the joinery system. The scarf drain joint lets the water through the exterior layer with all the external force of gravity and kinetic force. The path is made from backer rods and sealant guides the water in and out of the system. The joinery system removes any accumulation from the rainwater. Moreover, the joinery system dismisses the water leakage problem that is caused by capillary action. The joinery water tests and literature reviews have guided the research that the proposed joinery has a higher chance of lowering the water leakage problem. The proposed modules prevent water penetration at the main source of the water leakage problem, which is the joints.

CHAPTER 6

CONCLUSION

6.1. Conclusion

Nowadays, the construction of residential buildings uses the precast concrete system due to mass production and lowering of the on-site construction time. The precast concrete system reduces the cost of construction and reduces the construction time. However, the problems and concerns over the water leakage of a precast concrete house are numerous. The research studies the techniques to prevent water leakage through literature reviews and experiments. The literature reviews on the problems of water leakage have guided this research to experiment with the three main joint types: the one-stage joint, the two-stage joint, and the drains joint. These three joints had different approaches to protect the interior wall from water penetration. The case studies helped frame the experiment and increased the understanding of the precast concrete joinery in practice. The collected data of the changes in temperature, the changes in relative humidity, and the changes in the thermal image spectrum help validate the experiment result. The most effective joinery is the one-stage joint, but the installation of one-stage joints had a higher risk of deflection. The one-stage joint system has one flaw: when the grouting is not completely filled (not perfectly filled), any crack or gaps will cause water penetration in the system. The second effective joint is the drains joint with the one-way scarf detail. The one-way scarf drain joint had a lesser change in temperature in the two-water test.

The proposed design focuses on the improvement of existing Centro Rangsit, and the integration of the scarfs drain joint. The redesign uses the space planning that considers the modular system to change the grid division of the Avid and Bravo-A/B unit to a more standardize panel width that can be used throughout the project. The panel division principle is applied to reduce the number of connections. From the case study and transportation regulations, the maximum length of precast concrete panels that can be produced and transported is 6m in length. The crane with the lifting capacity higher than 5.5 tons is required for the installation of panels for the redesigned modules. The 6m panels are integrated into the grid planning to reduce the number of panels, and to reduce the connection points. These two principles helped to reduce connection length in the proposed units, as proven in the financial analysis. The proposed module to improve the water prevention mechanism was the addition of an extended sloped overhang and water drip edges. The additional batten and spline frame elements is added to the openings increase the water protection to the

connection of the window frame and the precast concrete. These additional mechanisms acted as the water deflection and discharge element of the design to stop water from reaching the wall surface. Despite the higher cost per unit for the joints in the proposed modules, the proposed modules should perform better at preventing water leakage. The second phase of the Centro Rangsit project will have a lower chance of water penetration based on this experiment and research.

6.2. Limitations of the study

The limitation of this thesis is the research methods, the full-scale experiments, and the validation processes. These limitations in the research method refer to the accessibility of the information and the on-site case study. One limitation was obtaining information from the private organization, including the sensitive information of water leakage problems in the development. Some limitations of conducting a full-scale experiment were that some professional water testing equipment is hard to obtain, and the experiment could have been more controlled within a closed environment. The experiment was a water test on a 1m x 1m precast concrete panel for the vertical connection. The limitation of the precast concrete panel's installation in the vertical connection is that it is harder to setup. The collected data had some controlled variables, but some errors in the result still appeared. The validity of the collected result could have been higher with better equipment and a more controlled environment. Concerns for the result being affected by researcher subjectivity have been taken into consideration. To increase the validity of the collected result, other than the visual observation, the researcher used the infrared thermometer and the thermal imagery to support the result.

The experiment that trying to replicate the ASTM standard may be inaccurate, due to the limitation of tools and the interpretation of the researcher. Although the experiment controls the collected data by using the same tool in all experiments, the infrared temperature measurement tools have an accuracy to the reading of one degree Celsius. Therefore, the collected data may have a variance from the actual surface temperature.

The financial analysis calculation in this research only calculation the initial cost for the change in joinery. The financial cost for the research may not cover all construction costs of the project. The change in redesigning the house effects many aspects of the project. The designs change the precast concrete formwork from a flat-sided panel to a one-way scarf details sided panel which increases the initial cost to the project. The production of the panels is reduced from the

increase in maximum length of 6 m. The other factor in the transportation and installation phase is also affected from the proposed modules but are not calculated in this research

The research combined the water leakage prevention technique from literature and the experiment that is conducted. The conclusion of the best performing joinery is based on the experiment result only. However, the full scales experiment in the precast concrete house have not been tested to confirm the effectiveness of the selected joinery. There is still the limitation of the verification of the proposed design water prevention mechanism for this research.

6.3. Suggestions

This thesis focused on the experiment of the joint factors alone through the experiment. This thesis proposed a design that is a combination of water leakage prevention techniques. There are other factors associated with water leakage problems that can be explored. For the developer and designer, the use of this research will depend on the condition of the site and the workmanship of the selected contractor. The design can have more aesthetic value to improve the appearance of the house units. For researchers, there are many more factors that can improve the water prevention mechanism that will prevent water leakage in the precast concrete wall system. More elaborate research can improve the experimentation method and the validation process of the water test. There are more room for improvement in this experiment technique to test the water infiltration experiment on the precast concrete wall, and more technique and factor to be explored in this topic of study.

REFERENCES

- Baan-lae-suan* (Producer). (2018, April 11). *Why precast in Thailand had a bad perspective from consumer views, an answer from large scale precast manufacturer.* *Baanlaesuan*. Retrieved from <https://www.baanlaesuan.com/79663/dontmiss/pros-2>
- Building material, product*. (2020). Retrieved from www.buildingmaterial.co.th
- Canadian-Precast-Prestressed-Concrete-Institute(CPCI). (n.d). *Architectural Precast Concrete Sealant and Joint Guide*. In C. P. P. C. Institute(CPCI) (Ed.).
- Chew, M. Y., & Silva, N. D. (2003). *Benchmarks to minimize water leakages in basements*. *STRUCTURAL SURVEY*, 21(4), 131-145.
- Committee, E., & International, A. (2017). *ASTM E2128-17 : Standard Guide for Evaluating Water Leakage of Building Walls*. West Conshohocken, PA: ASTM International.
- Garden, G. K., & Canada, N. R. C. o. (1967). *Rain penetration and its control*. *Canadian building digest*, CBD-40.
- Killip, I. R., & Cheetham, D. W. (1984). *The Prevention of Rain Penetration through External Walls and Joints by Means of Pressure Equalization*. *Building and Environment*, 19(2), 81-91.
- Latta, J. K. (1967). *Precast Concrete Walls - Problems With Conventional Design*. *Canadian building digest*, 93.
- Lim, P. J. (2016). *Industry practices need to change to benefit from advanced pre-fab techniques: Experts*. *Channel NewsAsia*.
- Paul, A. (2017). *What is a Drip Inducer or Water Cut*. Retrieved from <https://civildigital.com/drip-inducer-structures-water-cut-water-shedding-requirements/>
- Sivaiah, B. (2016). *Re: What is the relationship between temperature and humidity? Directly proportional or inversely proportional, if temperature increases/decreases, does humidity decrease/increase? Message posted to* <https://www.quora.com/What-is-the-relationship-between-temperature-and-humidity-Directly-proportional-or-inversely-proportional-if-temperature-increases->

[decreases-does-humidity-decrease-increase](#)

Straube, J. (2007). *Rain Control in Buildings. Building Science Digests, 013.*

Straube, J. (2010). *BSD-030: Rain Control Theory. Building Science Digests.*

Straube, J. (2016a). *High Performing Precast Concrete Building Enclosures: Rain Control.*
In C. P. P. C. Institute (Ed.), RDH Building Science.

Straube, J. (2016b). *Maintenance and Inspection Manual for Precast Concrete Building Enclosures. RDH Building Science.*

Whole life costing: Sealants. Retrieved from <http://www.greenspec.co.uk/building-design/sealants-costs/>

Yodpruktigarn, T. (2011). *Garn-Gor-Srang-Doi-Chai-Ra-Bhop-Krong-Srang-Concrete-Sum-Let-Roop (Precast concrete construction step by step). Thailand, Bangkok, Thailand: Therdtum Yodpruktigarn.*



จุฬาลงกรณ์มหาวิทยาลัย
CHULALONGKORN UNIVERSITY

VITA

NAME Prokchol Vataniyobol

DATE OF BIRTH 06 November 1995

PLACE OF BIRTH Phitsanulok, Thailand

INSTITUTIONS ATTENDED In 2017, she received a Bachelor of Science Degree in Architectural Design (International Program) from the faculty of Architecture, Chulalongkorn University. She then enrolled in the Master of Architecture in Architectural Design (International Program) at Chulalongkorn University.

HOME ADDRESS 506/77 Klangmuang grand de Paris village, Soi rojjanamin, Prachautis Rd. Wangthonglang, Bangkok, 10310

PUBLICATION She presented her research “The study of the three types of precast concrete panels joinery on the mechanism of water leakage prevention By Prokchol, Vataniyobol; Pat, Seeumpornroj” on 24th of May, 2020 for the 648TH International Conference on Science, Engineering & Technology - ICSET 2020 conference.