

## REFERENCES

- Adamczeski, M., Quinoa, E., and Crews, P. 1989. Novel sponge-derived amino acids. 5.<sup>1</sup> structures, stereochemistry, and synthesis of several new heterocycles. J. Am. Chem. Soc. 111: 647-654.
- Adamczeski, M., Reed, A. R., and Crews, P. 1995. New and known diketopiperazines from the Caribbean sponge, *Calyx cf. podatypa*. J. Nat. Prod. 58(2): 201-208.
- Admi, V., Afek, U., and Carmeli, S. 1996. Raocyclamides A and B, novel cyclic hexapeptides isolated from the cyanobacterium *Oscillatoria raoi*. J. Nat. Prod. 59: 396-399.
- Alvarez, M. E., Houck, D. R., White, C. B., Brownell, E. J., Bobko, M. A., Rodger, C. A., Stawicki, B. M., Sun, H. H., Gillum, A. M., and Cooper, R. 1994. Isolation and structure elucidation of two new calpain inhibitors from *Streptomyces griseus*. J. Antibiot. 47(11): 1195-1201.
- Anderson, L. E., Coffey, G. L., Senos, G. D., Underhill, M. A., Vogler, D. L., and Ehrlich, J. 1972. Butirosin, a new aminoglycoside antibiotic complex. Bacterial origin and some microbiological properties. Antimicrob. Agents Chemother. 2: 79-83.
- Anteunis, M. J. O. 1978. The cyclic dipeptides. Proper model compounds in peptide research. Bull. Soc. Chem. Belg. 87: 627-650.
- Aoyagi, T., Morishima, H., Kojiri, K., Yamamoto, T., Kojima, F., Nagaoka, K., Hamada, M., Takeuchi, T., and Umezawa, H. 1989. Alphostatin, an inhibitor of alkaline phosphatase of bovine liver produced by *Bacillus megaterium*. J. Antibiot. 42(3): 486-488.

- Aoyagi, T., Yoshida, S., Matsuda, N., Ikeda, T., Hamada, M., and Takeuchi, T. Leuhistin, a new inhibitor of aminopeptidase M, produced by *Bacillus laterosporus* BMI156-14F1. I. Taxonomy, production, isolation, physico-chemical properties and biological activities. J. Antibiot. 44(6): 573-578.
- Atsumi, K., Oiwa, R., and Omura, S. 1975. Production of bacillin by *Bacillus* sp. strain no. KM-208 and its identity with tetaine (bacilysin). J. Antibiot. 28(1): 77-78.
- Austin, B. 1989. Novel pharmaceutical compounds from marine bacteria. J. Appl. Bacteriol. 67: 461-470.
- Barbetta, M., Casnati, G., Pochini, A., and Selva, A. 1969. Neoechinuline, a new indole metabolite from *Aspergillus amstelodami*. Tetrahedron Lett. 51: 4457-4460.
- Barchi, J. J., Moore, R. E., and Patterson, M. G. L., 1984. Acutiphycin and 20,21-didehydroacutiphycin: new antineoplastic agents from the cyanophyte *Oscillatoria acutissima*. J. Am. Chem. Soc. 106: 8193-8197.
- Barrow, C. J., and Sedlock, D. M. 1994. 1'-(2-phenyl-ethylene)-ditryptophenaline, a new dimeric diketopiperazine from *Aspergillus flavus*. J. Nat. Prod. 57(9): 1239-1244.
- Barrow, C. J., Cai, P., Synder, J. K., Sedlock, D. M., Sun, H. H., and Cooper R. 1993. WIN 64821, a new competitive antagonist to substance P isolated from an *Aspergillus* species: structure determination and solution conformation. J. Org. Chem. 58: 6016-6021.
- Barrow, G. I., Feltham, R. K. A. 1993. Cowan and Steel's Manual for the Identification of Medicinal Bacteria, 3<sup>rd</sup> ed. pp. 50-90. Cambridge : Cambridge University Press.
- Berkeley, R. C. W., Claus, D. 1989. Endospore-forming gram-positive rods and cocci. In Bergey's Manual of Systematic Bacteriology; Sneath, P. H. A., Mair, N. S.,

- Sharpe, M. E., Holt, J. G. (eds), Vol. 2, Section 13, pp. 1104-1139, Baltimore : Williams & Wilkins.
- Besson, F., and Michel, G. 1987. Isolation and characterization of new iturins: iturin D and iturin E. J. Antibiot. 40(4) : 437-442.
- Besson, F., and Michel, G. 1988. Bacillomycins Fb and Fc: isolation and characterization. J. Antibiot. 41(3) : 282-288.
- Bewley, C. A., Holland, N. D., and Faulkner, D. J. 1996. Two classes of metabolites from *Theonella swinhoei* are localized in distinct populations of bacterial symbionts. Experientia 52: 716-722.
- Birch, A. J., and Russell, R. A. 1972. Studies in relation to biosynthesis-XLIV<sup>1</sup> structural elucidations of brevianamides B, -C, -D and -F. Tetrahedron 28: 2999-3008.
- Bodanszky, M., and Bodanszky A. 1994. The practice of peptide synthesis. 2<sup>nd</sup> ed. Germany: Springer-Verlag.
- Bodanszky, M., and Perlman, D. 1964. Are peptide antibiotics small proteins?. Nature 204: 840-844.
- Boden, C. D. J., Norley, M. C., and Pattenden, G. 1996. Total synthesis of the thiazoline-based cyclopeptide cyclodidemnamide. Tetrahedron Lett. 37(50): 9111-9114.
- Bogna, R., Brown, B. O., Lockley, J. W. S., Makleit, S., Toubé, T. P., Weedon, C. B. L., and Zsupan, K. 1970. The structure of flavofungin. Tetrahedron Lett. 7: 471-477.
- Boyes-Korkis, J. M., Gurney, K. A., Penn, J., and Mantle, P. G. 1993. Anacine, a new benzodiazepine metabolite of *Penicillium aurantiogriseum* produced with other alkaloids in submerged fermentation. J. Nat. Prod. 56(10): 707-1717.
- Brock, T. D., and Madigan, M. T. 1988. Biology of microorganisms. 15<sup>th</sup> ed, pp. 548-602, New Jersey: Prentice-Hall.

- Brock, T. D., Madigan, M. T., Martinko, J. M., and Parker, J. 1993. Biology of microorganisms. 7<sup>th</sup> ed. New Jersey: Prentice Hall.
- Brown, R., Kelley, C., and Wiberley, S. E. 1965. The production of 3-benzylidene-6-isobutylidene-2,5-dioxopiperazine, 3,6-dibenzylidene-2,5-dioxopiperazine, 3-benzyl-6-benzylidene-2,5-dioxopiperazine, and 3,6-dibenzyl-2,5-dioxopiperazine by a variant of *Streptomyces noursei*. Experientia 30: 1965.
- Bryans, J., Charlton, P., Chicarelli-Robinson, I., Collins, M., Fiant, R., Latham, C., and Shaw, I. 1996. Inhibition of plasminogen activator inhibitor-1 activity by two diketopiperazines, XR330 and XR334 produced by *Streptomyces* sp. J. Antibiot. 49(10): 1014-1021.
- Bull, S. D., Davies, S. G., Parkin, R. M., and Sanchez-Sancho, F. 1998. The biosynthetic origin of diketopiperazines derived from D-proline. J. Chem. Soc., Perkin Trans 1: 2313-2320.
- Canedo, LM., *et al.* 1997. PM-94128, a new isocoumarin antitumor agent produced by a marine bacterium. J. Antibiot. 50(2): 175-176.
- Cardillo, F., Fuganti, C., Gatti, G., Ghiringhelli, D., and Grasselli, P. 1974. Molecular structure of cryptoechinuline A, a new metabolite of *Aspergillus amstelodami*, isolated during investigations on echinuline biosynthesis. Tetrahedron Lett. 36: 3163-3166.
- Carmeli, S., Moore, R. E., and Patterson, L. G. M. 1990. Tolytoxin and new scytophycins from three species of *Scytonema*. J. Nat. Prod. 53(6): 1533-1542.
- Carmely, S., and Kashman, Y. 1985. Structure of swinholide-A, a new macrolide from the marine sponge *Theonella swinhoei*. Tetrahedron Lett. 26(4): 511-514.
- Carroll, A. R., Bowden, B. F., Coll, J. C., Hockless, D. C. R., Skelton, B. W., and White, A. H. 1994. Studies of Australian ascidians. IV mollamide, a cytotoxic cyclic

heptapeptide from the compound ascidian *Didemnum molle*. Aust. J. Chem. 47: 61-69.

Chatterjee, S., Chatterjee, S., Lad, S. J., Phansalkar, M. S., Rupp, R. H., Ganguli, B. N., Fehlhauer, H.W., and Kogler, H. 1992. Mersacidin, a new antibiotic from *Bacillus*. Fermentation, isolation, purification and chemical characterization. J. Antibiot. 45(6): 832-838.

Chu, M., Mierzwa, R., Truumees, I., Gentile F., Patel, M., Gullo, V., Chan, T., and Puar, S. M. 1993. Two novel diketopiperazines isolated from the fungus *Tolypocladium* sp. Tetrahedron Lett. 34(47): 7537-7540.

Chu, M., Truumees, M., Rothofsky, M. L., Patel, M. G., Gentile, F., Das, P. R., Puar, M. S., and Lin, L. S. 1995. Inhibitor of *c-fos* proto-oncogene induction by Sch 52900 and Sch 52901, novel diketopiperazines produced by *Gliocladium* sp. J. Antibiot. 48(12): 1440-1445.

Cimino, G., Crispino, A., De Stefano, S. Gavagnin, M., and Sodano, G. 1986. A naturally-occurring analog of methylthioadenosine (MTA) from the nudibranch mollusc *Doris verrucosa*. Experientia 42: 1301-1302.

Cimino, G., De Rosa, S., and De Stefano, S. 1984. Antiviral agents from a gorgonian, *Eunicella cavolini*. Experientia 40: 339-340.

Crescenzi, V., Cesaro, A., Russo, E. 1973. On some physicochemical properties of diketopiperazines in water. Int. J. Peptide Protein Res. 5: 427-434.

Cui, C., Kakeya, H., and Osada, H. 1997. Novel mammalian cell cycle inhibitors, cyclotryprostatins A-D, produced by *Aspergillus fumigatus*, which inhibit mammalian cell cycle at G2/M phase. Tetrahedron 53(1): 59-72.

- Cui, C., Kakeya, H., and Osada, H. 1996. Novel mammalian cell cycle inhibitors, spirotryprostatins A and B, produced by *Aspergillus fumigatus*, which inhibit mammalian cell cycle at G2/M phase. Tetrahedron 52(39): 12651-12666.
- Cui, C., Kakeya, H., and Osada, H. 1996. Novel mammalian cell cycle inhibitors, tryptostatins A, B and other diketopiperazines produced by *Aspergillus fumigatus*. J. Antibiotics. 49(6): 534-540.
- Darkin-Rattray, S. J., Gurnett, A. M., Myers, R. W., Dulski, P. M., Crumley, T. M., Allocco, J. J., Cannova, C., Meinke, P. T., Colletti, S. L., Bednarek, M. A., Singh, S. B., Goetz, A. M., Dombrowski, A. W., Polishook, J. D., and Schmatz, D. M. 1996. Apicidin, a novel antiprotozoal agent that inhibits parasite histone deacetylase. Proc. Natl. Acad. Sci. USA 93: 13143-13147.
- Davidson, B. S., Schumacher, R. W. 1993. Isolation and synthesis of caprolactins A and B, new caprolactams from a marine bacterium. Tetrahedron 49(30): 6569-6574.
- D'Auria, M. V., Paloma, L. G., Minale, L., Zampella, A., Verbist, J., Roussakis, C., and Debitus, C. 1993. Three new potent cytotoxic macrolides closely related to sphinxolide from the new Caledonian sponge *Neosiphonia superstes*. Tetrahedron 49(38): 8657-8664.
- D'Auria, M. V., Paloma, L. G., Minale, L., Zampella, A., Verbist, J., Roussakis, C., Debitus, C., and Patissou, J. 1994. Reidispongiolide A and B, two new potent cytotoxic macrolides from the new Caledonian sponge *Reidispongia coerulea*. Tetrahedron 50(16): 4829-4834.
- Degnan, B. M., Hawkins, C. J., Lavin, M. F., McCaffrey, E. J., Parry, D. L., Brenk, A. L., and Watters, D. 1989. New cyclic peptides with cytotoxic activity from the ascidian *Lissoclinum patella*. J. Med. Chem. 32: 1349-1354.



- Degnan, B. M., Hawkins, C. J., Lavin, M. F., McCaffrey, E. J., Parry, D. L., and Watters, D. 1989. Novel cytotoxic compounds from the ascidian *Lissoclinum bistratum*. J. Med. Chem. 32(6): 1354-1359.
- De man, J. M., De man, L., and Gupta, S. 1986. Texture and microstructure of soybean curd (tofu) as affected by different coagulants. Food Micro. struct. 5: 83-89.
- Dematte, N., *et al.* 1985. A screening of some colonial ascidiaceae for antibacterial and antifungal activities and, preliminary, for natural products: 2'-deoxyribonucleosides from *Trididemnum cereum* (Giard, 1872). Comp. Biochem. Physiol. 81B: 479-484.
- Desjardins, R. E., Canfield, C. J., Haynes, J. D., and Chulay, J. D. 1979. Quantitative assessment of antimalarial activity *in vitro* by a semiautomated microdilution technique. Antimicrob. Agents Chemother. 16: 710-718.
- DeVault, R. L., Rosenbrook, W. 1973. A novel class of diketopiperazines. J. Antibiot. 26 (9): 532-534.
- Dillman, R. L., and Cardellina, J. H. 1991. An unusual sulfur-containing diketopiperazine from the Bermudian sponge *Tedia ignis*. J. Nat. Prod. 54(4): 1159-1161.
- Dix, D. T., Martin, J., and Moppett, C. E. 1972. Molecular structure of the metabolite lanosulin. J. Chem. Soc., Chem. Comm.: 1168-1169.
- Doi, M., Ishida, T, Kobayashi, M., and Kitagawa, I.. 1991. Molecular conformation from the Okinawan marine sponge *Theonella swinhoei*: x-ray crystal structure of its diketone derivative. J. Org. Chem. 56: 3629-3632.
- Donadio, S., McAlpine, J. B., Sheldon, P. J., Jackson, M., and Katz, L. 1993. An erythromycin analog produced by reprogramming of polyketide synthesis. Proc. Natl. Acad. Sci. USA 90: 7119-7123.

- Ebata, M., Miyazaki, K., and Takahashi, Y. 1969. Studies on subsporin. I., isolation and characterization of subsporins A, B and C. J. Antibiot. 22(10) : 467-472.
- Eshita, S. M., Roberto, N. H., Beale, J. M., Mamiya, B. M., and Workman, R.F.. 1995. Bacillomycin Lc, a new antibiotic of the iturin group: isolations, structures, and antifungal activities of the congeners. J. Antibiot. 48(11): 1240-1247.
- Forbes, L. 1981. Rapid flagella stain. J. Clin. Microbiol. (Apr): 807-809.
- Foster, M. P., Concepcion, G. P., Caraan, G. B., and Ireland, C. M. 1992. Bistratamides C and D, two new oxazole-containing cyclic hexapeptides isolated from a Philippine *Lissoclinum bistratum* ascidian. J. Org. Chem. 57: 6671-6675.
- Francesconi, K. A., Stick, R. V., and Edmonds, J. S. 1991. An arsenic-containing nucleosides from the kidney of the giant clam *Tridacna maxima*. J. Chem. Soc., Chem. Commun. : 928-929.
- Freeman, B.A. 1979. Burrows textbook of microbiology. 21st ed., pp. 231-233, Toronto: W.B. Saunders company.
- Freeman, D. J., and Pattenden, G. 1998. Total synthesis and assignment of stereochemistry of raocyclamide cyclopeptides from cyanobacterium *Oscillatoria raoi*. Tetrahedron Lett. 39: 3251-3254.
- Fu, X., Zeng, L., Su, J., and Pais, M. 1997. A new diketopiperazine derivative from south China sea sponge *Dysidea fragilis*. J. Nat. Prod. 60: 695-696.
- Fuhrman, F. A., Fuhrman, G. J., Kim, Y. H., Pavelka, L. A., and Mosher, H. S. 1980. Doridosine: a new hypotensive N-methylpurine riboside from the nudibranch *Anisodoris nobilis*. Science 207 (11 January): 193-195.
- Fuhrman, F. A., Fuhrman, G. J., Nachman, R. J., and Mosher, H. S. 1981. Isoguanine: isolation from an animal. Science 212 (May): 557-558.



- Fujiu, M., Sawairi, S., Shimada, H., Takaya, H., Aoki, Y., Okuda, T., and Yokose, K. 1994. Azoxybacilin, a novel antifungal agent produced by *Bacillus cereus* NR2991: production, isolation and structure elucidation. J. Antibiot. 47(7): 833-835.
- Fujiwara, T., Takahashi, Y., Matsumoto, K., and Kondo, E. 1980. Production of a new aminoglycoside antibiotic by a mutant of *Bacillus circulans*. J. Antibiot. 33(8): 836-841.
- Funabashi, Y., Horiguchi, T., Iinuma, S., Tanida, S., and Harada, S. 1994. TAN-1496 A, C and E, diketopiperazine antibiotics with inhibitory against mammalian DNA topoisomerase I. J. Antibiot. 47(11): 1202-1218.
- Fusetani, N., Ejima, D., Matsunaga, S., Hashimoto, K., Itagaki, K., Akagi, Y., Taga, N., and Suzuki, K. 1987. 3-amino-3-deoxy-D-glucose: an antibiotic produced by a deep-sea bacterium. Experientia 43: 464-465.
- Fusetani, M., Matsunaga, S., Matsumoto, H., and Takebayashi, Y. 1990. Cyclotheonamides, potent thrombin inhibitors, from a marine sponge *Theonella* sp. J. Am. Chem. Soc. 112: 7053-7054.
- Fusetani, M., Sugawara, T., and Matsunaga, S. 1991. Orbiculamide A: a novel cytotoxic cyclic peptide from a marine sponge *Theonella* sp.. J. Am. Chem. Soc. 113: 7811-7812.
- Glasby, S. 1993. Encyclopedia of antibiotics. 3<sup>rd</sup> ed, pp. 1-712, John Wiley and Sons.
- Gerard, J. M., Haden, P., Kelly, T. M., and Andersen, J. R. 1999. Loloatins A-D, cyclic decapeptide antibiotics produced in culture by a tropical marine bacterium. J. Nat. Prod. 62: 80-85.

- Gerwick, W. H., Jiang, Z. D., and Farmer, B. T. 1992. Total structure of hormothamnin A, a toxic cyclic undecapeptide from the tropical marine cyanobacterium *Hormothamnion enteromorphoides*. Tetrahedron 48: 2313-2324.
- Gil-Turnes, M. S., and Fenical, W. 1991. Embryos of *Hamarus americanus* are protected by epibiotic bacteria. Biol. Bull. 182: 105-108.
- Gustafson, K., Roman, M., and Fenical, W. 1989. The macrolactins, a new class of antiviral and cytotoxic macrolides from a deep-sea marine bacterium. J. Am. Chem. Soc. 111: 7519-7524.
- Guzman, F. S., and Gloer, J. B. 1992. New diketopiperazine metabolites from the sclerotia of *Aspergillus ochraceus*. J. Nat. Prod. 55(7): 931-939.
- Hamada, Y., Kato, S., and Shioiri, T. 1985. New methods and reagents in organic synthesis. A synthesis of ascidiacyclamide, a cytotoxic cyclic peptide from ascidian-determination of its absolute configuration. Tetrahedron Lett. 26(27): 3223-3226.
- Hamamoto, T., Endo, M., Nakagawa, M., Nakanishi, T., and Mizukawa, K. 1983. A new cyclic peptide, ascidiacyclamide, isolated from ascidian. J. Chem. Soc., Chem. Commun. : 323-324.
- Hambley, T. W., Hawkins, C. J., Lavin, M. MF., Brenk, A., and Watters, D. J. 1992. Cycloxazoline: a cytotoxic cyclic hexapeptide from the ascidian *Lissoclinum bistratum*. Tetrahedron 48(2): 341-348.
- Hawkins, C. J., Lavin, M. F., Marshall, K. A., Brenk, A. L., and Watters, D. J. 1990. Structure-activity relationships of the lissoclinamides: cytotoxic cyclic peptides from the ascidian *Lissoclinum patella*. J. Med. Chem. 33: 1634-1638.

- Hayashi, K., Hayashi, T., Otsuka, H., and Takeda, Y. 1997. Antiviral activity of 5, 6, 7,-trimethoxyflavone and its potentiation of the antiherpes activity of acyclovir. J. Antimicrob. Chemother. 39(6): 821-824.
- Heaney-Kieras, J., and Kurylo-Borowska, Z. 1980. Tatumine, a peptide from *Bacillus brevis* Vm4-572-403. J. Antibiot. 33(4): 359-363.
- Helms, G. L., Moore, R. E., Niemczura, W. P., and Patterson, G. L. M. 1988. Scytonema A, a novel calcium antagonist from a blue-green alga. J. Org. chem. 53: 1298-1307.
- Hiramoto, S., Kinoshita, N., Hatanaka, S., and Seto, H. 1996. Stimulation of apolipoprotein E secretion in human hepatoma HepG2 cells by a cyclic acylpeptide, N-4909. J. Antibiot. 49(9): 949-952.
- Hirata, Y., and Uemura, D. 1986. Halichondrins-antitumor polyether macrolides from a marine sponge. Pure & Appl. Chem. 58(5): 701-710.
- Hirota, A., Suzuki, A., Aizawa, K., and Tamura, S. 1973. Structure of Cyl-2, a novel cyclotetrapeptide from *Cylindrocladium scoparium*. Agr. Biol. Chem. 37(4): 955-956.
- Hirsch, S., Miroz, A., McCarthy, P., and Kashman, Y. 1989. Etzionin, a new antifungal metabolite from a red sea tunicate. Tetrahedron Lett. 30(32): 4291-4294.
- Hodge, P. R., Harris, C. M., and Harris, T. M. 1988. Verrucofortine, a major metabolite of *Penicillium verrucosum* var. *cyclopium*, the fungus that produces the mycotoxin verrucosidin. J. Nat. Prod. 51(1): 66-73.
- Hosokawa, N., Naganawa, H., Hamada, M., Takeuchi, T., Ikeno, S., and Hori, M. 1996. Hydroxymycotrienins A and B, new ansamycin group antibiotics inhibit the growth of human cervical cancer cell lines of human papilloma virus (HPV). J. Antibiot. 49(5): 425-431.

- Hosono, K., and Suzuki, H. 1983. Acylpeptides, the inhibitors of cyclic adenosine 3',5'-monophosphate phosphodiesterase. J. Antibiot. 36(2): 194-196.
- Hotta, K., Yoshida, M., Hamada, M., and Oami, Y. 1980. Studies on new aminoglycoside antibiotics, istamycins, from an actinomycete isolated from a marine environment III. Nutritional effects on istamycin production and additional chemical and biological properties of istamycins. J. Antibiot. 33(12): 1515-1520.
- Ikai, Y., Oka, H., Hayakawa, J., Harada, I., and Suzuki, M. 1992. Structural characterization of bacitracin components by Frit-fast atom bombardment (FAB) liquid chromatography/mass spectrometry (LC/MS). J. Antibiot. 45(8): 1325-1334.
- Ikai, Y., Oka H, Hayakawa, J., Matsumoto, M., Saito, M., Harada, K., Mayumi, Y., and Suzuki, M. 1995. Total structures and antimicrobial activity of bacitracin minor components. J. Antibiot. 48(3): 233-42.
- Ireland, C., Durso, A. R., Newman, R. A., and Hacker, M. P. 1982. Antineoplastic cyclic peptides from the marine tunicate *Lissoclinum patella*. J. Org. Chem. 47: 1807-1811.
- Ireland, C., Scheuer, D. J. 1980. Ulicyclamide and ulithiacyclamide, two new small peptides from a marine tunicate. J. Am. Chem. Soc. 102: 5691-5692.
- Ishibashi, M., Moore, E. R., Patterson, G. M. L., Xu, C., and Cardy, J. 1986. Scytophycins, cytotoxic and antimycotic agents from the cyanophyte *Scytonema pseudohofmanni*. J. Org.Chem. 51: 5300-5306.
- Ishibashi, M., Ohizumi, Y., Hamashima, M., Nakamura, H., Hirata, Y., Sasaki, T., and Kobayashi, J. 1987. Amphidinolide-B, a novel macrolide with potent antineoplastic activity from the marine dinoflagellate *Amphidinium* sp.. J. Chem. Soc., Chem. Commun. :1127-1129.

- Ito, M., and Koyama, Y. 1972. Localization of jolipeptin and colistin in their producing strain, *Bacillus polymyxa* var. *colistinus* Koyama. J. Antibiot. 25(2): 147-148.
- Itoh, J., Omoto, S., Shomura, T., Nishizawa, N., Miyado, S., Yuda, Y., Shibata, U., Inouye, S. 1981. Amicoumacin-A, a new antibiotic with strong antiinflammatory and antiulcer activity. J. Antibiot. 34: 611-613.
- Izawa, M., Nakahama, K., Kasahara, F., Asai, M., and Kishi, T. 1981. Demethylation of ansamitocins and related compounds. J. Antibiot. 34(12): 1581-1586.
- Jayatilake, G. S., Thornton, M. P., Leonard, A. C., Grimwade, J. E., and Baker, B. J. 1996. Metabolites from an Antarctic sponge-associated bacterium, *Pseudomonas aeruginosa*. J. Nat. Prod. 59: 293-296.
- Jensen, P. R., and Fenical, W. 1995. The relative abundance and seawater requirements of gram-positive bacteria in new shore tropical marine samples. Microbial Ecology 29: 249-257.
- Johnson, J. L., Jackson, W. G., and Eble, T. E. 1951. Isolation of L-Leucyl-L-Proline anhydride from microbiological fermentation. J. Am. Chem. Soc. 73: 2947-2949.
- Kageyama, M., Burg, K. A., and Perlman, D. 1977. Microbial production of vitamin B12 antimetabolites. III Compound 102804 from *Bacillus cereus*. J. Antibiot. 30(4): 283-288.
- Kajimura, Y., and Kaneda, M. 1996. Fusaricidin A, a new depsipeptide antibiotic produced by *Bacillus polymyxa* KT-8. Taxonomy, fermentation, isolation, structure elucidation and biological activity. J. Antibiot. 49(2): 129-135.
- Kajimura, Y., and Kaneda, M. 1997. Fusaricidins B, C, and D, new depsipeptide antibiotics produced by *Bacillus polymyxa* KT-8: isolation, structure elucidation and biological activity. J. Antibiot. 50(3): 220-228.

- Kajimura, Y., Sugiyama, M., and Kaneda, M. 1995. Bacillopeptins, new cyclic lipopeptide antibiotics from *Bacillus subtilis* FR-2. J. Antibiot. 48(10): 1095-1103.
- Kakinuma, K., and Rinehart, K. L. 1974. Tryptophan-dehydrobutyryne diketopiperazine, a metabolite of *Streptomyces spectabilis*. J. Antibiot. 27(10): 733-737.
- Kameyama, T., Takahashi, A., Kurasawa, S., Ishizuka, M., Okami, Y., Takeuchi, T., and Umezawa, H. 1987. Bisucaberin, a new siderophore, sensitizing tumor cells to macrophage-mediated cytotoxicity I. Taxonomy of the producing organism, isolation and biological properties. J. Antibiot. 40(12): 1664-1670.
- Kameyama, T., Umino, T., Nakamura, Y., Itezono, Y., Sawairi, S., Satoh, T., and Yokose, K. 1994. Bacithrocins A, B and C, novel thrombin inhibitors. J. Antibiot. 47(9): 959-968.
- Kanzaki, H., Oda, S., Kobayashi, A., and Kawazu, K. 1997. Microbial hydrolysis of diketopiperazines different types of diketopiperazine-assimilating bacteria. J. Ferment. Bioeng. 83(4): 386-388.
- Kaouadji, M., Steiman, R., Seigle-Murandi, F., Krivobok, S., and Sage, L. 1990. Gliotoxin: uncommon  $^1\text{H}$  coupling and revised  $^1\text{H}$ - and  $^{13}\text{C}$ -nmr assignments. J. Nat. Prod. 53(3): 717-719.
- Katagiri, K., Sato, K., Hayakawa, T., Matsushima, T., and Minato, H. 1970. Verticillin A, a new antibiotic from *Verticillium* sp. J. Antibiot. 23: 420-422.
- Kato, Y., Fusetani, N., Matsunaga, S., and Hashimoto, K. 1985. Bioactive marine metabolites IX., mycalisines A and B, novel nucleosides which inhibit cell division of fertilized starfish eggs, from the marine sponge *Mycale* sp. Tetrahedron Lett. 26(29): 3483-3486.



- Kato, Y., Fusetani, N., Matsunaga, S., Hashimoto, K., Sakai, R., Higa, T., and Kashman, Y. 1987. Antitumor macrodiolides isolated from a marine sponge *Theonella* sp.; structure revision of misakinolide A. Tetrahedron Lett. 28(49): 6225-6228
- Katz, E., and Demain, A. L., 1977. The peptide antibiotics of *Bacillus*: chemistry, biogenesis, and possible functions. Bacteriol. Rev. 41(2): 449-474.
- Kawaguchi, H., Konishi, M., Tsuno, T., Miyaki, T., Tomita, K., Matsumoto, K., Fujisawa, K., Tsukiura, H. 1981. Glysperin, a new antibiotic complex of bacterial origin. I. Production, isolation and properties. J. Antibiot. 34(4): 381-389.
- Kawaguchi, H., Tomita, K., Hoshiya, T., Miyaki, T., and Fujisawa, K. 1974. Aminoglycoside antibiotics. V. The 4'-deoxybutirosins (Bu-1975C1 and C2), new aminoglycoside antibiotics of bacterial origin. J. Antibiot. 27(6): 460-470.
- Kazlauskas, R., Murphy, P. T., Wells, R. J., Baird-Lambert, J. A., and Jamieson, D. D. 1983. Halogenated pyrrolo[2,3-*d*]pyrimidine nucleosides from marine organisms. Aust. J. Chem. 36: 165-170.
- Kazlauskas, T. P., Murphy, T. P., and Wells, R. J. 1978. A diketopiperazine derived from trichloroleucine from the sponge *Dysidea herbacea*. Tetrahedron Lett. 49: 4945-4948.
- Kernan M. R., and Faulkner, D. J. 1987. Halichondramide, an antifungal macrolide from the sponge *Halichondria* sp.. Tetrahedron Lett. 28(25): 2809-2812.
- Kernan, M. R., Molinski, T. F., and Faulkner, D. J. 1988. Macrocyclic antifungal metabolites from the Spanish dancer nudibranch *Hexabranhus sanguineus* and sponges of the genus *Halichondria*. J. Org.Chem. 53: 5014-5020.

- Kikuchi, M., and Nakao, Y. 1977. SP127, a bacterial protein enhancing the activity of macrolide antibiotics against *Pseudomonas aeruginosa*: isolation and characterization. J. Antibiot. 30(3): 209-214.
- Kikuchi, Y., Ishibashi, M., Sasaki, T., and Kobayashi, J. 1991. Iejimalides C and D, new antineoplastic 24-membered macrolide sulfates from the Okinawan marine tunicate *Eudistoma cf. rigida*. Tetrahedron Lett. 32(6): 797-798.
- Kim, P. S., Pordesimo, E. O., Toth, S. I., Schmitz, F. J., and Van Altena, I. 1993. Pantherinine, a cytotoxic aromatic alkaloid, and 7-deazainosine from the ascidian *Aplidium pantherinum*. J. Nat. Prod. 56(10): 1813-1816.
- Kimura, Y., Kitamura, H., and Hayashi, K. 1982. A method for separating commercial colistin complex into new components: colistins pro-A, pro-B and pro-C. J. Antibiot. 35(11): 1513-1520.
- Kimura, Y., Murai, E., Fujisawa, M., Tatsuki, T., and Nobue, F. 1969. Polymyxin P, new antibiotics of polymyxin group. J. Antibiot. 22(9): 449-450.
- Kirst, H. A., Mynderse, J. S., Martin, J. W., Baker, P. J., Paschal, J. W., Steiner, L. R. J., Lobkovsky, E. 1996. Structure of the spiroketal-macrolide ossamycin. J. Antibiot. 49(2): 162-167.
- Klein, D., Braekman, J. C., Daloz, D., Hoffmann, L., and Demoulin, V. 1997. Lyngbyaloside, a novel 2,3,4-tri-*O*-methyl-6-deoxy- $\alpha$ -mannopyranoside macrolide from *Lyngbya bouillonii* (cyanobacteria). J. Nat. Prod. 60: 1057-1059.
- Kobaru, S., Tsunakawa, M., Hanada, M., Konishi, M., Tomita, K., and Kawaguchi, H. 1983. Bu-2743E, a leucine aminopeptidase inhibitor, produced by *Bacillus circulans*. J. Antibiot. 36(10): 1396-1398.
- Kobayashi, J. 1989. Pharmacologically active metabolites from symbiotic microalgae in Okinawan marine invertebrates. J. Nat. Prod. 52(2): 225-238.

- Kobayashi, J., Cheng, J., Ohta, T., Nakamura, H., Nozoe, S., Hirata, Y., Ohizumi, Y., and Sasaki, T. 1988. Iejimalides A and B, novel 24-membered macrolides with potent antileukemic activity from the Okinawan tunicate *Eudistoma cf. rigida*. J. Org. Chem. 53: 6147-6150.
- Kobayashi, J., Ishibashi, M., and Hirota, H. 1991. <sup>1</sup>H and <sup>13</sup>C-nmr spectral investigation on amphidinolide A, an antileukemic marine macrolide. J. Nat. Prod. 54(5): 1435-1439.
- Kobayashi, J., Ishibashi, M., Murayama, T., Takamatsu, M., Iwamura, M., Ohizumi, Y., and Sasaki, T. 1990. Amphidinolide E, a novel antileukemic 19-membered macrolide from the cultured symbiotic dinoflagellate *Amphidinium* sp. J. Org. Chem. 55: 3421-3423.
- Kobayashi, J., Ishibashi, M., Nakamura, H., Ohizumi, Y., Yamasu, T., Hirata, Y., and Sasaki, T. 1989. Cytotoxic macrolides from a cultured marine dinoflagellate of the genus *Amphidinium*. J. Nat. Prod. 52(5): 1036-1041.
- Kobayashi, J., Ishibashi, M., Nakamura, H., Ohizumi, Y., Yamasu, T., Sasaki, T., and Hirata, Y. 1986. Amphidinolide-A, a novel antineoplastic macrolide from the marine dinoflagellate *Amphidinium* sp.. Tetrahedron Lett. 27(47): 5755-5758.
- Kobayashi, J., Ishibashi, M., Walchli, M. R., Nakamura, H., Hirata, Y., Sasaki, T., and Ohizumi, Y. 1988. Amphidinolide C: the first 25-membered macrocyclic lactone with potent antineoplastic activity from the cultured dinoflagellate *Amphidinium* sp.. J. Am. Chem. Soc. 110: 490-494.
- Kobayashi, J., Itagaki, F., Shigemori, H., Ishibashi, M., Takahashi, K., Ogura, M., Nagasawa, S., Nakamura, T., Hirota, H., Ohta, T., and Nozoe, S. 1991. Keramamides B-D: novel peptides from the Okinawan marine sponge *Theonella* sp. J. Am. Chem. Soc. 113: 7813-7814.

- Kobayashi, J., Itagaki, F., Shigemori, H., Takao, T., and Shimonishi, Y. 1995. Keramamides E, G, H, and J, new cyclic peptides containing an oxazole or a thiazole ring from a *Theonella* sponge. Tetrahedron 51(9): 2525-2532.
- Kobayashi, J., Sato, M., Ishibashi, M., Shigemori, H., Nakamura, T., and Ohizumi, Y. 1991. Keramamide A, a novel peptide from the Okinawan marine sponge *Theonella* sp.. J. Chem. Soc. Perkin Trans 1 : 2609-2611.
- Kobayashi, J., Shigemori, H., Ishibashi, M., Yamasu, T., Hirota, H., and Sasaki, T. 1991. Amphidinolides G and H: new potent cytotoxic macrolides from the cultured symbiotic dinoflagellate *Amphidinium* sp. J. Org. Chem. 56: 5221-5224.
- Kobayashi, J., Takahashi, M., and Ishibashi, M. 1995. Biosynthetic studies of amphidinolide J: explanation of the generation of the unusual odd-numbered macrocyclic lactone. J. Chem. Soc., Chem. Commun. : 1639-1640.
- Kobayashi, J., Tsuda, M., Fuse, H., Sasaki, T., and Mikami, Y. 1997. Halishigamides A-D, new cytotoxic oxazole-containing metabolites from Okinawan sponge *Halichondria* sp. J. Nat. Prod. 60: 150-154.
- Kobayashi, J., Tsuda, M., Ishibashi, M., Shigemori, H., Yamasu, T., Hirota, H., and Sasaki, T. 1991. Amphidinolide F, a new cytotoxic macrolide from marine dinoflagellate *Amphidinium* sp. J. Antibiot. 44(11): 1259-1261.
- Kobayashi, J., Tsukamoto, S., Tanabe, A., Sasaki, T., and Ishibashi, M. 1991. New congeners of bistheonellides from Okinawan marine sponges of the genus *Theonella*. J. Chem. Soc., Perkin Trans. 1 : 2379.
- Kobayashi, M., Aoki, S., Gato, K., Matsunami, K., Kurosu, M., and Kitagawa, I. 1994. Marine natural products. XXXIV.<sup>1)</sup> Trisindoline, a new antibiotic indole trimer, produced by bacterium of *Vibrio* sp. isolated from the marine sponge *Hyrtios altum*. Chem. Pharm. Bull. 42(12): 2449-2451.

- Kobayashi, M., Tanaka, J., Katori, T., and Kitagawa, I. 1990. Marine natural products. XXIII.. Three new cytotoxic dimeric macrolides, swinholide B and isoswinholide A, congeners of swinholide A, from the Okinawan marine sponge *Theonella swinhoei*. Chem. Pharm. Bull. 38(11): 2960-2966.
- Kobayashi, M., Tanaka, J., Katori, T., Matsuura, M., and Kitagawa, I. 1989. Structure of swinholide A, a potent cytotoxic macrolide from the Okinawan marine sponge *Theonella swinhoei*. Tetrahedron Lett. 30(22): 2963-2966.
- Konda, Y., Nakagawa, A., Harigaya, Y., Onda, M., Masuma, R., and Omura, S. 1988. Aurantinin B, a new antimicrobial antibiotic from bacterial origin. J. Antibiot. 41 (5): C-5.
- Kondo, K., Shigemori, H., Ishibashi, M., and Kobayashi, J. 1992. Aplysidine, a new nucleoside from the Okinawan marine sponge *Aplysina* sp. Tetrahedron 48(35): 7145-7148.
- Konishi, M., Nishio, M., Saitoh, K., Miyaki, T., Oki, T., and Kawaguchi, H. 1989. Cispentacin, a new antifungal antibiotic I.. Production, isolation, physico-chemical properties and structure. J. Antibiot. 42(12): 1749-1755.
- Konishi, M., Sugawara, K., Tomita, K., Matsumoto, K., Miyaki, T., Fujisawa, K., Tsukiura, H., and Kawaguchi, H. 1983. Bu-2470, a new peptide antibiotic complex. I. Production, isolation and properties of Bu-2470 A, B1 and B2. J. Antibiot. 36(6): 625-633.
- Lampis, G., Deidda, D., Maullu, C., Madeddu, M. A., Pompei, R., Delle M. F, and Satta, G. 1995. Sattabacins and sattazolins: new biologically active compounds with antiviral properties extracted from a *Bacillus* sp. J. Antibiot. 48(9): 967-972.

- Larsen, T. O., Frisvad, J. C., and Jensen, S. R. 1992. Aurantiamine, a diketopiperazine from two varieties of *Penicillium aurantiogriseum*. Phytochemistry 31(5): 1613-1615.
- Lewis, J. C., and Snell, N. S. 1951. The amino acid composition of subtilin. Experientia. 73: 4812-4816.
- Lidgren, G., Bohlin, L., and Bergman, J. 1986. Studies of Swedish marine organisms VII. A novel biologically active indole alkaloid from the sponge *Geodia baretii*. Tetrahedron Letters 27(28): 3283-3284.
- Liebermann, B., Ihn, W., Baumann, E., and Tresselt, D. 1988. Dihydrotentoxin and a related dipeptide produced by *Alternaria alternata*. Phytochemistry 27(2): 357-359.
- Liesch, J. M., Sweeley, C. C., Staffeld, G. D., Anderson, M. S., Weber, D. J., and Scheffer, R. P. 1982. Structure of HC-toxin, a cyclic tetrapeptide from *Helminthosporium carbonum*. Tetrahedron 38(1): 45-48.
- Lorian, V. 1980. Antibiotics in laboratory Medicine., Baltimore: Williams & Wilkins Company, pp. 176-180.
- Luedemann, G., Charner, W., Woyciesjes, A., Pettersen, E., Peckham, W. D., Gentles, J. M., Marshall, H., and Herzog, L. H. 1961. Microbiological transformation of steroids. IX. The transformation of Reichstein's compound S by *Scenedesmus* sp. diketopiperazine metabolites from *Scenedesmus* sp. J. Am. Chem. Soc. 26: 1428-1430.
- Madison, V., Young, P. E., and Blout, E. R. 1976. Cyclic dipeptides, conformational energy and circular dichroism of proline-containing cyclic dipeptides. J. Am. Chem. Soc. 98(17): 531-537.



- Maehr, H., Blount, J. F., Pruess, D. L., Yarmchuk, L., and Kellett, M. 1973. Antimetabolites produced by microorganisms. N-5-hydroxy-L-arginine, a new naturally occurring amino acid. J. Antibiot. 26(5): 284-288.
- Matsunaga, S., Fusetani, N., Hashimoto, K., Koseki, K., and Noma, M., 1986. Kabiramide C, a novel antifungal macrolide from nudibranch eggmasses. J. Am. Chem. Soc. 108(4): 847-849.
- Matsunaga, S., Fusetani, N., Hashimoto, K., Koseki, K., Noma, M., Noguchi, H., and Sankawa, U. 1989. Further kabiramides and halichondramides, cytotoxic macrolides embracing trisoxazole, from *Hexabranchnus* egg masses. J. Org. Chem. 54: 1360-1363.
- Matsunaga, S., Fusetani, N., and Konosu, S. 1985. Bioactive marine metabolites VII. Structures of discodermins B, C, and D, antimicrobial peptides from the marine sponge *Discodermia kiiensis*. Tetrahedron Lett. 26(7): 855-856.
- McDonald, L. A., Foster, P.M., Phillips, D. R., Ireland, C. M., Lee, A. Y., and Clardy, J. 1992. Tawicyclamides A and B, new cyclic peptides from the ascidian *Lissoclinum patella*: studies on the solution and solid-state conformations. J. Org. Chem. 57: 4616-4624.
- Meyers, E., Brown, W. E., Principe, P. A., Rathnum, M. L., and Parker, W. L. 1973. EM49, a new peptide antibiotic. I. Fermentation, isolation, and preliminary characterization. J. Antibiot. 26(8): 444-448.
- Meyer, W. L., Templeton, G. E., Grable, C. L., Sigel, C. W., Jones, R., Woodhead, S. H., and Sauer, C. 1971. The structure of tentoxin. Tetrahedron Lett. 25: 2357-2360.
- Mhammedi, A., Peypoux, F., Besson, F., and Michel, G. 1981. Bacillomycin F, a new antibiotic of iturin group: isolation and characterization. J. Antibiot. 34(12): 1619-1621.

- Milne, P. J., Hunt, A. L., Rostoll, K., Van Der Walt, J. J., and Graz, C. J. M. 1998. The biological activity of selected cyclic dipeptides. J. Pharm. Pharmacol. 50: 1331-1337.
- Mitchell, S. S., Pomerantz, S. C., Concepcion, G. P., and Ireland, C. M. 1996. Tubercidin analogs from the ascidian *Didemnum voelzkowi*. J. Nat. Prod. 59: 1000-1001.
- Moore, R. E., Bornemann, V., Niemczura, W. P., Gregson, J. M., Chen, J., Norton, T. R., Patterson, M. L. G., and Helms, L. G. 1989. Puwainaphycin C, a cardioactive cyclic peptide from the blue-green alga *Anabaena* BQ-16-1. Use of two-dimensional  $^{13}\text{C}$ - $^{13}\text{C}$  and  $^{13}\text{C}$ - $^{15}\text{N}$  correlation spectroscopy in sequencing the amino acid units. J. Am. Chem. Soc. 111: 6128-6132.
- Mukhopadhyay, T., Nadkarni, S. R., Bhat, R. G., Gupte, S. V., Ganguli, B. N., Petry, S., and Kogler, H. 1999. Methemycin B, a new antifungal macrolactone from *Actinomyce* species HIL Y-8620959. J. Nat. Prod. 62: 889-890.
- Murakami, M., Makabe, K., Yamaguchi, K., Konosu, S., Walchli, M. R. 1988. Goniiodomin A, a novel polyether macrolide from the dinoflagellate *Goniodoma pseudogoniaulax*. Tetrahedron Lett. 29(10): 1149-1152.
- Nakahama, K., Harada, S., and Igarasi, S. 1975. Studies on lankacidin-group (T-2636) antibiotics. X. Microbial conversion of lankacidin-group antibiotics. J. Antibiot. 28(5): 390-394.
- Nakahama, K., Izawa, M., Asai, M., Kida, M., and Kishi, T. 1981. Microbial conversion of ansamitocin. J. Antibiot. 34(5): 611-613.
- Nakajima, N., Chihara, S., and Koyama, Y. 1972. A new antibiotic, gatavalin. I. Isolation and characterization. J. Antibiot. 25(4): 243-247.
- Nakamura, H., Asari, T., Fujimaki, K., Maruyama, K., Murai, A., Ohizumi, Y., and Kan, Y. 1995. Zootaxanthellatoxin-B; vasoconstrictive congener of zootaxanthellatoxin-A

- from a symbiotic dinoflagellate *Symbiodinium* sp. Tetrahedron Lett. 36(40): 7255-7258.
- Nakamura, H., Asari, T., Murai, A., Kan, Y., Kondo, T., Yoshida, K., and Ohizumi, Y. 1995. Zooxanthellatoxin-A, a potent vasoconstrictive 62-membered lactone a symbiotic dinoflagellate. J. Am. Chem. Soc. 117: 550-551.
- Naruse, N., Tenmyo, O., Kobaru, S., Kamei, H., Miyaki, T., Konishi, M., and Oki, T. 1990. Pumilacidin, a complex of new antiviral antibiotics. Production, isolation, chemical properties, structure and biological activity. J. Antibiot. 43(3): 267-280.
- Needham, J., Kelly, M. T., Ishige, M., and Anderson, R. J. 1994. Andrimid and moiramides A-C, metabolites produced in culture by a marine isolate of the bacterium *Pseudomonas fluorescens*: structure elucidation and biosynthesis. J. Org. Chem. 59: 2058-2063.
- Nishikiori, T., Masuma, R., Oiwa, R., Katagiri, M., Awaya, J., Iwai, Y., and Omura, S. 1978. Aurantinin, a new antibiotic of bacterial origin. J. Antibiot. 31(6): 525-532.
- Nitecki, D. E., Halpren, B., and Westley, J. W. 1968. A simple route to sterically pure diketopiperazines. J. Org. Chem. 33(2): 864-866.
- Nozaki, S., Muramatsu, I. 1984. Natural homologs of gramicidin S. J. Antibiot. 37(6): 689-690.
- Ogura, H., Furuhashi, K., and Furuhashi, K. 1975. Studies on lactams, VI. Stereochemistry of L-prolyl-L-valine anhydride. Chem. Pharm. Bull. 23(11): 2474-2477.
- Nakamura, H., Kigoshi, H., Ishigaki, T., and Yamada, K. 1993. Further studies on aplyronine A, an antitumor substance isolated from the sea hare *Aplysia kurodai*. Tetrahedron Lett. 34(52): 8501-8504.

- Nakamura, H., Nemoto, T., Nakamura, M., and Yamada, K. 1995. Dolastatin E, a new cyclic hexapeptide isolated from the sea hare *Dolabella auricularia*. Tetrahedron Lett. 36(28): 5057-5058.
- Okami, Y. 1986. Marine microorganisms as a source of bioactive agents. Microb. Ecol. 12: 65-78.
- Okami, Y., Okazaki, T., Kirahara, T., and Umezawa, H. 1976. Studies on marine microorganisms. V a new antibiotic, aplasmomycin, produced by a *Streptomyces* isolated from shallow sea-mud. J. Antibiot. 29: 1019-1025.
- Okazaki, H., Kishi, T., Beppu, T., and Arima, K. 1975. A new antibiotic, baciphelacin. J. Antibiot. 28(9): 717-719.
- Okazaki, T., Kitahara, T., and Okami, Y. 1975. Studies on marine microorganisms. IV a new antibiotic SS-228Y produced by *Chainia* isolated from shallow sea mud. J. Antibiot. 28: 176-184.
- Omura, S., Iwai, Y., Masuma, R., Hayashi, M., Furusato, T., and Takagaki, T. 1980. A new peptide antibiotic, alboleutin. J. Antibiot. 33(7): 758-759.
- Omura, S., Nishikiori, T., Oiwa, R., Iwai, Y., and Masuma, R. 1976. A new antibiotic KM-214 produced by a strain of *Bacillus*. J. Antibiot. 29(4): 477-478.
- Omar, S., Tenenbaum, L., Manes, L. V., and Crews, P. 1988. Novel marine sponge derived amino acids 7. The fenestins. Tetrahedron Lett. 29(43): 5489-5492.
- Oohata, N., Hori, Y., Yamagishi, Y., Fujita, T., Takase, S., Yamashita, M., Terano, H., and Okuhara, M. 1995. A new aromatase inhibitor, FR901537. I. Taxonomy, fermentation, isolation, physicochemical characteristics and biological activities. J. Antibiot. 48(8): 757-762.

- Ooka, K., Tanaka, M., Ishikawa, T., and Kato, F. 1999. An antimutagenic metabolite, streptovaricin C, isolated from *Streptomyces* sp. Biol. Pharm. Bull. 22(1): 107-110.
- Ovenden, S. B. P., Capon, R. J., Lacey, E., Gill, J. H., Friedel, T., and Wadsworth, D. 1999. Amphilactams A-D: novel nematocides from southern Australian marine sponges of the genus *Amphimedon*. J. Org.Chem. 64: 1140-1144.
- Park, J. K., Hasumi, K., and Endo, A. 1995. Inhibition of the binding of oxidized low density lipoprotein to the macrophages by iturin C-related compounds. J. Antibiot. 48(3): 226-232.
- Parker, W. L., Rathnum, M. L., Dean, L. D., Nimeck, M. W., Brown, W. E., and Meyers, E. 1977. Polymyxin E, a new peptide antibiotic. J. Antibiot. 30(9): 767-769.
- Parker, W. L., Rathnum, M. L., and Liu, W. C. 1982. SQ 26,517-a beta-lactone produced by a *Bacillus* species. J. Antibiot. 35(3): 306-311.
- Painuly, P., Perez, R., Fukai, T., and Shimizu, Y. 1988. The structure of a cyclic peptide toxin, cyanogenosin-RR from *Microcystis aeruginosa*. Tetrahedron Lett. 29(1): 11-14.
- Pergament, I., and Carmeli, S. 1994. Schizotrin A; a novel antimicrobial cyclic peptide from a cyanobacterium. Tetrahedron Lett. 35(45): 8473-8476.
- Perlman, K. L., Schomer, U., Williams, T.H , and Perlman, D. 1981. Microbial production of vitamin B12 antimetabolites. IV. Isolation and identification of 4-keto-5-amino-6-hydroxyhexanoic acid. J. Antibiot. 34(5): 483-488.
- Pettit, G. R., Dreele, R. B., Bolliger, G., Traxler, P. M., and Brown, P. 1973. Isolation and structural elucidation of 3,6-dioxo-hexahydro-pyrrolo[1,2-a]-pyrazine from the echinoderm *Lucidia clathrata*. Experientia 29: 521-522.

- Peypoux, S., Besson, F., Michel, G., and Delcambe, L. 1981. Structure of bacillomycin D, a new antibiotic of the iturin group. J. Biochem. 118: 323-327.
- Peypoux, S., Besson, F., Michel, G., Lenzen, C., Dierickx, L., and Delcambe, L. 1980. Characterization of a new antibiotic of iturin group: bacillomycin D. J. Antibiot. 33(10): 1146-1149.
- Pickenhagen, W., Dietrich, P., Keil, B., Polonsky, J., Nouaille, F., and Lederer, E. 1975. Identification of the bitter principle of cocoa. Helv. Chim. Acta 58: 1078-1086.
- Pinet, E., Cavelier, F., Verducci, J., Girault, G., Dubart, L., Haraux, F., Sigalat, C., and Andre, F. 1996. Synthesis, structure, and properties of MeSer<sup>1</sup>-tentoxin, a new cyclic tetrapeptide which interacts specifically with chloroplast F<sub>1</sub> H<sup>+</sup>-ATPase differentiation of inhibitory and stimulating effects. Biochemistry 35: 12804-12811.
- Pinet, E., Gomis, J., Girault, G., Cavelier, F., Verducci, J., Noel, J., and Andre, F. 1996. Tentoxin has at least two binding sites on CF<sub>1</sub> and  $\epsilon$ -depleted CF<sub>1</sub> ATPases isolated from spinach chloroplast. FEBS Letters 395: 217-220.
- Prave, P., Sukatsch, D., and Vertesy, L. 1972. Proticin, a new phosphorus-containing antibiotic. I. Taxonomy, fermentation, isolation, and biological properties. J. Antibiot. 25(1): 1-3.
- Prinsep, M., Moore, R. E., Levine, L. A., and Patterson, G. L. M. 1992. Westiellamide, a bistratamide-related cyclic peptide from the blue-green alga *Westiellopsis prolifica*. J. Nat. Prod. 55(1): 140-142.
- Quinn, R. J., Gregson, R. P., Cook, A. F., and Bartlett, R. T. 1980. Isolation and synthesis of 1-methylisoguanosine, a potent pharmacologically active constituent from the marine sponge *Tedania digitata*. Tetrahedron Lett. 21: 567-568.



- Robin, D. J., and Sefton, M. A. 1984. 1-*N*-methyl-(6*E*)-(2-methylpropylidene)-(3*Z*)-3-(phenylmethylene)-2,5-piperazinedione, a metabolite from *Streptomyces albus*. Phytochemistry 23(1): 200-201.
- Rosenfeld, W. D., and ZoBell, C. E., 1947. Antibiotic production by marine microorganism. J. Bacteriol. 54: 393-398.
- Rudi, A., Kashman, Y., Benayahu, Y., and schleyer, M. 1994, Amino acid derivatives from the marine sponge *Jaspis digonoxea*. J. Nat. Prod. 57(6): 829-832.
- Rychnovsky, S. D. 1995. Oxo polyene macrolide antibiotics. Chem Rev. 95: 2021-2040.
- Rychnovsky, S. D., Skalitzky, D. J., Pathirana, C., Jensen, P. R., and Fenical, W. 1992. Stereochemistry of the macrolactins. J. Am. Chem. Soc. 114: 671-677.
- Ryu, G., Choi, W., Hwang, S., Yeo, W., Lee, C., and Kim, S. 1999. Tetrin C, a new glycosylated polyene macrolide antibiotic produced by *Streptomyces* sp. GK9244. J. Nat. Prod. 62: 917-919.
- Sakemi, S., and Higa, T. 1985. Isolation of three deoxyribonucleosides and their bases from the acorn worm *Ptychodera flava*. Comp. Biochem. Physio. 82(B): 107-109.
- Sano, T., and Kaya, K. 1995. Oscillamide Y, a chymotrypsin inhibitor from toxic *Oscillatoria agardhii*. Tetrahedron Lett. 36(33): 5933-5936.
- Sato, A., Takahashi, S., Ogita, T., Sugano, M., and Kodama, K. 1995. Marine natural products. Annu. Rep. Sankyo. Lab. 47: 1-58.
- Schmitz, F. J., Gunasekera, S. P., Yalamanchili, G., Hossain, M. B., and Helm, D. 1984. Tedanolide, a potent cytotoxic macrolide from the Caribbean sponge *Tedania ignis*. J. Am. Chem. Soc. 106: 7251-7252.
- Schmitz, F. J., Ksebati, M. B., Chang, J. S., Wang, J. L., Hossian, M. B., Helm, D., Engel, M. H., Serban, A., and Silber, J. A. 1989. Cyclic peptides from the ascidian

- Lissoclinum patella*: conformation analysis of patellamide D by x-ray analysis and molecular modeling. J. Org. Chem. 54: 3463-3472.
- Schmitz, F. J., Vanderah, D. J., Hollenbeak, K. H., Enwall, C. L., and Gopichand, Y. 1983. Metabolites from the marine sponge *Tedania ignis*. A new atisanediol and several known diketopiperazines. J. Org. chem. 48: 3941-3945.
- Schneider, J., Taraz, K., Budzikiewicz, H., et al. 1999. The structure of two fengycins from *Bacillus subtilis* S499. J. Antibiot. 54(11): 859-866.
- Schumacher, R., Davidson, B. S., Montenegro, D. A., and Bernan, V. S. 1995.  $\gamma$ -Indomycinone, a new pluramycin metabolite from a deep-sea derived actinomycete. J. Nat. Prod. 58(4): 613-617.
- Scott, P. M., Kennedy, B. C. P., Harwig, J., and Chen, Y-K. 1974. Formation of diketopiperazines by *Penicillium italicum* isolated from oranges. Appl. Microbiol. 28(5): 892-894.
- Searle, P. A., and Molinski, T. F. 1995. Trachycladines A and B: 2'-C-methyl-5'-deoxyribofuranosyl nucleosides from the marine sponge *Trachycladus laevispirulifer*. J. Org. Chem. 60: 4296-4298.
- Serkedjieva, J., and Jvancheva, S. 1999. Antiherpes virus activity of extracts from the medicinal plant *Geranium sanguineum* L. J. Ethnopharmacology. 64(1): 59-68.
- Service, R.F. 1995, September 17-20<sup>th</sup>. 35<sup>th</sup> Interscience conference on anti-microbial agents and chemotherapy. San Francisco, California.
- Shibazaki, M., Sugawara, T., Nagai, K., Shimizu, Y., Yamaguchi, H., and Suzuki, K. 1996. YM-47522, a novel antifungal antibiotic produced by *Bacillus* sp. I. Taxonomy, fermentation, isolation and biological properties. J. Antibiot. 49(4): 340-344.

- Shida, O., Takag, H., Kadowaki, K., Nakamura, L. K., and Komagata, K. 1997. Transfer of *Bacillus alginolyticus*, *Bacillus chondroitinus*, *Bacillus curdolanolyticus*, *Bacillus glucanolyticus*, *Bacillus kobensis*, and *Bacillus thiaminolyticus* to the genus *Paenibacillus* and emended description of the genus *Paenibacillus*. Int. J. Syst. Bacteriol. 47(2): 289-298.
- Shimada, N., Hasegawa, S., Harada, T., Tomisawa, T., Fujii, A., and Takita, T. 1986. Oxetanocin, a novel nucleoside from bacteria. J. Antibiot. 39(11): 1623-1625.
- Shin, H. J., and Fenical, W. Isolation of gliovictin from the marine deuteromycete *Asteromyces cruciatus*. Phytochemistry 26(12): 3347.
- Shin, H. J., Matsuda, H., Murakami, M., and Yamaguchi, K. 1997. Anabaenopeptins E and F, two new cyclic peptides from the cyanobacterium *Oscillatoria agardhii* (NIES-204). J. Nat. Prod. 60: 139-141.
- Shoji, J., Hino, H., Sakazaki, R., Kato, T., Wakisaka, Y., Mayama, M., Matsuura, S., and Miwa, H. 1978. Isolation of tridecaptins A, B and C (studies on antibiotics from the genus *Bacillus*. XXIII). J. Antibiot. 31(7): 646-651.
- Shoji, J., Hino, H., Wakisaka, Y., Koizumi, K., and Mayama, M. 1975. Isolation of a new peptide antibiotic TL-119. Studies on antibiotics from the genus *Bacillus*. IV. J. Antibiot. 28(2): 126-128.
- Shoji, J., Hino, H., Wakisaka, Y., Koizumi, K., and Mayama, M. 1976. Isolation of three new antibiotics, thiocillins I, II and III, related to micrococcin P. Studies on antibiotics from the genus *Bacillus*. VIII. J. Antibiot. 29(4): 366-374.
- Shoji, J., Kato, T., and Hino, H. 1977. The structures of two new polymyxin group antibiotics. J. Antibiot. 31(5): 427-429.

- Shoji, J., Sakazaki, R., Wakisaka, Y., Koizumi, K., Matsuura, S., Miwa, H., and Mayama, M. 1980. Isolation of octapeptin D (studies on antibiotics from the genus *Bacillus*. XXVII). J. Antibiot. 33(2): 182-185.
- Shoji, J., Sakazaki, R., Wakisaka, Y., Koizumi, K., Mayama, M., and Matsuura, S. 1975. Isolation of galantins I and II, water-soluble basic peptides. Studies on antibiotics from the genus *Bacillus*. III. J. Antibiot. 28(2): 122-125.
- Shoji, J., Hino, H., Wakisaka, Y., Koizumi, K., and Mayama, M. 1975. Isolation of two new related peptide antibiotics, cerexins A and B (studies on antibiotics from the genus *Bacillus*. I). J. Antibiot. 28(1): 56-59.
- Shoji, J., Hino, H., Wakisaka, Y., Koizumi, K., and Mayama, M. 1976. Isolation of a new peptide antibiotic complex, B-43 (studies on antibiotics from the genus *Bacillus*. XV). J. Antibiot. 29(8): 813-817.
- Shoji, J., Hino, H., Wakisaka, Y., Koizumi, K., and Mayama, M. 1976. Isolation of a new antibiotic 333-25, related to antibiotic EM 49. (Studies on antibiotics from the genus *Bacillus*. XI). J. Antibiot. 29(5): 516-520.
- Shoji, J., Hino, H., Wakisaka, Y., Koizumi, K., and Mayama, M. 1976. Isolation of a new peptide antibiotic, 339-29 (studies on antibiotics from the genus *Bacillus*. XIV). J. Antibiot. 29(8): 809-812.
- Shoji, J., Kato, T., Matsumoto, K., Takahashi, Y., and Mayama, M. 1976. Production and isolation of cerexins C and D studies on antibiotics from the genus *Bacillus*. XVII. J. Antibiot. 29(12): 1281-1285.
- Shoji, J., Sakazaki, R., Wakisaka, Y., Koizumi, K., and Mayama, M. 1975. Isolation of a new peptide antibiotic complex 61-26. Studies on antibiotics from the genus *Bacillus*. V. J. Antibiot. 28(2): 129-131.

- Shoji, J., Sakazaki, R., Wakisaka, Y., Koizumi, K., and Mayama, M. 1976. Isolation of a new antibiotic, laterosporamine. Studies on antibiotics from the genus *Bacillus*. XIII. J. Antibiot. 29(4): 390-393.
- Shoji, J., Sakazaki, R., Wakisaka, Y., Koizumi, K., and Mayama, M. 1976. Isolation of brevistin, a new peptide antibiotic. Studies on antibiotics from the genus *Bacillus*. IX. J. Antibiot. 29(4): 375-379.
- Silverstein, R. M., Bassler, G. C., and Morill, T. C. 1991. Spectrometric identification of organic compounds, Singapore : John Wiley and Sons, pp. 165-202.
- Skehan, P., Storeng, R., Scudiero, D., Monks, A., McMahon, J., Vistica, D., Warren, J.T., Bokesch, H., Kenney, S., and Boyd, M.R. 1990. New colorimetric cytotoxicity assay for anticancer-drug screening. J. Natl. Cancer Inst. 82(13): 1107-1112.
- Soesener J. A., and Scheuer, P. J., 1986. Ulapualide A and B, extraordinary antitumor macrolides from nudibranch eggmasses. J. Am. Chem. Soc. 108: 846-847.
- Sorensen, D., Larsen, T. O., Christophersen, C., Neilsen, P. H., and Anthoni, U. 1999. Dipodazine, a diketopiperazine from *Penicillium dipodomyis*. Phytochemistry 51: 1181-1183.
- Spring, S., Ludwig, W., Marquez, M. C., Ventosa, A., and Schleifer, K-H. 1996. *Halobacillus* gen. Nov., with descriptions of *Halobacillus litoralis* sp. nov. and *Halobacillus trueperi* sp. nov. and transfer of *Sporosarcina halophila* to *Halobacillus halophilus* comb. nov. Int. J. Syst. Bacteriol. 46(2): 492-496.
- Steele, J. A., Uchytel, T. F., Durbin, R. D., Bhatnagar, P., and Rich, D. H. 1976. Chloroplast coupling factor 1: a specific receptor for tentoxin. Proc. Natl. Acad. Sci. USA 73(7): 2245-2248.
- Steyn, P.S. 1971. Austamide, a new toxic metabolite from *Aspergillus ustus*. Tetrahedron Lett. 36: 3331-3334.

- Stierle, A. C., Cardellina, J. H., and Singleton, F. L. 1988. A marine *Micrococcus* produces metabolites ascribed to the sponge *Tedia ignis*. Experientia 44: 102-1022.
- Stierle, A. C., Cardellina, J. H., and Strobel, G. A. 1988. Maculosin, a host-specific phytotoxin for spotted knapweed from *Alternaria alternata*. Proc. Natl. Acad. Sci. USA. 85: 8008-8011.
- Stierle, A. C., Cardellina, J. H., and Strobel, G. A. 1989. Phytotoxins from *Alternaria alternata*, a pathogen of spotted knapweed. J. Nat. Prod. 52(1): 42-47.
- Su, J., Zhong, Y., Zeng, L. 1993. Three new diketopiperazines from a marine sponge *Dysidea fragilis*. J. Nat. Prod. 56(4): 637-642.
- Su, J., Zhong, Y., Zeng, L., Wu, H., Shen, X., and Ma, K. 1996. A new *N*-carboxyindole alkaloid from the marine sponge *Rhaphisia pallida*. J. Nat. Prod. 59: 504-506.
- Suenaga, K., Nagoya, T., Shibata, T., Kigoshi, H., and Yamada, K. 1997. Dolabelides C and D, cytotoxic macrolides isolated from the sea hare *Dolabella auricularia*. J. Nat. Prod. 60: 155-157.
- Sugawara, K., Konishi, M., and Kawaguchi, H. 1984. BMY-28160, a new peptide antibiotic. J. Antibiot. 37(10): 1257-1259.
- Sugawara, K., Yonemoto, T., Konishi, M., Matsumoto, K., Miyaki, T., and Kawaguchi, H. 1983. Bu-2470, a new peptide antibiotic complex. II. Structure determination of Bu-2470 A, B1, B2a and B2b. J. Antibiot. : 364-638.
- Sugita, M., Hiramoto, S., Ando, C., Sasaki, T., Furihata, K., Seto, H., and Otake, N. 1985. Studies on mycotrienin antibiotics, a novel class of ansamycins. IV. Microbial conversion of mycotrienin-II to mycotrienol-II, 34-hydroxymycotrienin-II and 22-O-beta-D-glucopyranosylmycotrienin-II by *Bacillus megaterium*. J. Antibiot. 38(6): 799-802.



- Takahara, Y., Takeuchi, Y., Komura, I., Hirose, Y., and Murao, S. 1979. Isolation of a new peptide antibiotic, permétin A, from *Bacillus circulans*. J. Antibiot. 32(2): 115-120.
- Takahashi, A., Nakamura, H., Kameyama, T., Kurasawa, S., Naganawa, H., Okami, Y., Takeuchi, T., Umezawa, H., and Iitaka, Y. 1997. Bisucaberin, a new siderophore, sensitizing tumor cells to macrophage-mediated cytotoxicity II. Physico-chemical properties and structure determination. J. Antibiot. 40(12): 1671-1676.
- Takahashi, A., Saito, N., Hotta, K., Okami, Y., and Umezawa, H. 1986. Bagougeramines A and B, new nucleoside antibiotics produced by a strain of *Bacillus circulans*. I. Taxonomy of the producing organism and isolation and biological properties of the antibiotics. J. Antibiot. 39(8): 1033-1040.
- Takahashi, C., Numata, A., Ito, Y., Matsumura, E., Araki, H., Iwaki, H., and Kushida, K. 1994. Leptosins, antitumor metabolites of a fungus isolated from a marine alga. J. Chem. Soc., Perkin Trans 1: 1859-1864.
- Takahashi, C., Takada, T., Yamada, T., Minoura, K., Uchida, K., Matsumura, E., and Numata, A. 1994. Halichomycin, a new class of potent cytotoxic macrolide produced by an actinomycete from a marine fish. Tetrahedron Lett. 35(28): 5013-5014.
- Takeda, K., Aihara, K., and Furumai, T., Ito, Y. 1978. An approach to the biosynthetic pathway of butirosins and the related antibiotics. J. Antibiot. 31(3): 250-253.
- Takeda, K., Kinumaki, A., Furumai, T., Yamaguchi, T., Ohshima, S., and Ito, Y. 1978. Mutational biosynthesis of butirosin analogs. J. Antibiot. 31(3): 247-249.
- Takeuchi, T., Iinuma, H., Kunimoto, S., Masuda, T., Ishizuka, M., Takeuchi, M., Hamada, M., Naganawa, H., Kondo, S., and Umezawa, H. 1981. A new

- antitumor antibiotic, spergualin: isolation and antitumor activity. J. Antibiot. 34 (12): 1587-1590.
- Tamaoka, J. 1994. Determination of DNA base composition. In Goodfellow, M., and O'Donnell, A. G. (eds), Chemical methods in prokaryotic systematics. John Wiley and Sons, pp. 463-470.
- Tanaka, J., Higa, T., Kobayashi, M., and Kitagawa, I. 1990. Marine natural products. XXIV. The absolute stereostructure of misakinolide A, a potent cytotoxic dimeric macrolide from an Okinawan sponge *Theonella* sp. Chem. Pharm. Bull. 38(11): 2967-2970.
- Taylor, H. D., and Schmitz, H. 1976. Antibiotics derived from a mutant of *Bacillus circulans*. J. Antibiot. 29(5): 532-535.
- Thongton, C. 1998. Bioactive substances from a marine bacterium, *Alteromonas* sp. S9730. Master's Thesis, Chulalongkorn University.
- Tortora, G. I., Funke, B. R., and Case, C. L. eds. 1982. Microbiology : an introduction. California : The Benjamins, pp. 398-402.
- Torigoe, K., Murata, M., and Yasumoto, T. 1988. Prorocentrolide, a toxic nitrogenous macrocycle from a marine dinoflagellate, *Prorocentrum lima*. J. Am. Chem. Soc. 110: 7876-7877.
- Trager, W., and Jensen, J. B., 1976. Human malaria parasites in continuous culture. Science 193(4254): 673-674.
- Trigos, A., Reyna, S., and Matamoros, B. 1995. Macrophominol, a diketopiperazine from cultures of *Macrophomina phaseolina*. Phytochemistry 40(6): 1697-1698.
- Trischman, J. A., Jensen, P. R., and Fenical, W. 1994. Halobacillin: a cytotoxic cyclic acylpeptide of the iturin class produced by a marine *Bacillus*. Tetrahedron Lett. 35(31): 5571-5574.

- Trischman, J. A., Tapiolas, D. M., Jensen, P. R., Dwight, R., Fenical, W., McKee, T. C., Ireland, C. M., Stout, T. J., and Clardy, J. 1994. Salinamides A and B: anti-inflammatory depsipeptides from a marine streptomycete. J. Am. Chem. Soc. 116: 757-758.
- Tsukamoto, S., Ishibashi M., Sasaki, T., and Kobayashi, J. 1991. New congeners of swinholides from the Okinawan marine sponge *Thenella* sp. J. Chem. Soc., Perkin Trans. 1: 3185-3188.
- Tsukamoto, S., Kato, H., Hirota, H., and Fusetani, N. 1995. Pipecolate derivatives, anthosamines A and B, from a marine sponge *Anthosigmella* aff. *raromicrosclera*. Tetrahedron 51(24): 6687-6694.
- Tsukiura, H., Saito, K., Kobaru, S., Konishi, M., and Kawaguchi, H. 1973. Aminoglycoside antibiotics. IV. BU-1709 E1 and E2, new aminoglycoside antibiotics related to the butirosins. J. Antibiot. 26(7): 386-388.
- Umezawa, H., Aoyagi, T., Nishikiori, T., Okuyama, A., Yamagishi, Y., Hamada, M., and Takeuchi, T. 1986. Plipastatins: new inhibitors of phospholipase A<sub>2</sub>, produced by *Bacillus cereus* BMG302-ff67. I. Taxonomy, production, isolation and preliminary characterization. J. Antibiot. 39(6): 737-744.
- Umezawa, H., Okami, Y., Kurasawa, S., Ohnuki, T., Ishizuka, M., Takeuchi, T., Shiio, T., and Yugari, Y. 1983. Marinactan, antitumor polysaccharide produced by marine bacteria. J. Antibiot. 36(5): 471-477.
- Umezawa, S., Umino, K., Shibahara, S., Hamada, M., and Omoto, S. 1967. Fermentation of 3-amino-3-deoxy-D-glucose. J. Antibiot. 20(6): 355-360.
- Umezawa, H., Aoyagi, T., Ogawa, K., Naganawa, H., Hamada, M., and Takeuchi, T. 1984. Diprotins A and B, inhibitors of dipeptidyl aminopeptidase IV, produced by bacteria. J. Antibiot. 37(4): 422-425.

- Unson, M. D., and Faulkner D. J. 1993. Cyanobacterial symbiont biosynthesis of chlorinated metabolites from *Dysidea herbacea* (Porifera). Experientia 49: 349-353.
- Uramoto, M., Tanabe, M., Hirotsu, K., and Clardy, J. 1982. A new tremorgenic metabolite related to verruculogen from *Penicillium verruculosum*. Heterocycles 17: 349-354.
- Vanittanakom, N., Loeffler, W., Koch, U., and Jung, G. 1986. Fengycin, a novel antifungal lipopeptide antibiotic produced by *Bacillus subtilis* F-29-3. J. Antibiot. 39(7): 888-901.
- Waring, P., Eichner, R. D., Tiwari-Palni, U., and Mullbacher, A. 1987. Gliotoxin-E: a new biologically active epipolythioxopiperazine isolated from *Penicillium terlikowskii*. Aust. J. Chem. 40: 991-997.
- Weber, J. F., Fuhrman, F. A., Fuhrman, G. J., and Mosher, H. S. 1981. Isolation of allantoin and adenosine from the marine sponge *Tethya aurantia*. Comp. Biochem. Physiol. 70B: 799-801.
- Weinheimer, A. J., Chang, C. W. J., Matson, A., and Kaul, P.N. 1978. Marine cardioactive agents. Adenosine and 2'-deoxyadenosine from *Dasychalina cyathina*. J. Nat. Prod. (Lloydia) 41: 488-490.
- Winkelmann, G., Allgaier, H., Lupp, R., and Jung, G. 1983. Iturin AL--a new long chain iturin possessing an unusual high content of C16-beta-amino acids. J. Antibiot. 36(11): 1451-1457.
- Yoshida, S., Aoyagi, T., Harada, S., Matsuda, N., Ikeda, T., Naganawa, H., Hamada, M., and Takeuchi, T. 1991. Production of 2-methyl-4[3H]-quinazolinone, an inhibitor of poly(ADP-ribose) synthetase, by bacterium. J. Antibiot. 44(1): 111-112.

Zampella, A., D'Auria, M. V., Minale, L., and Debitus, C. 1997. Callipeltosides B and C, two novel cytotoxic glycoside macrolides from a marine *Lithistida* sponge *Callipelta* sp. Tetrahedron 53(9): 3243-3248.

Zampella, A., D'Auria, M. V., Minale, L., Debitus, C., and Roussakis, C. 1996. Callipeltoside A: a cytotoxic aminodeoxy sugar-containing macrolide of a new type from the marine *Lithistida* sponge *Callipelta* sp. J. Am. Chem. Soc. 118: 11085-11088.



สถาบันวิทยบริการ  
จุฬาลงกรณ์มหาวิทยาลัย



**APPENDIX**

สถาบันวิทยบริการ  
จุฬาลงกรณ์มหาวิทยาลัย



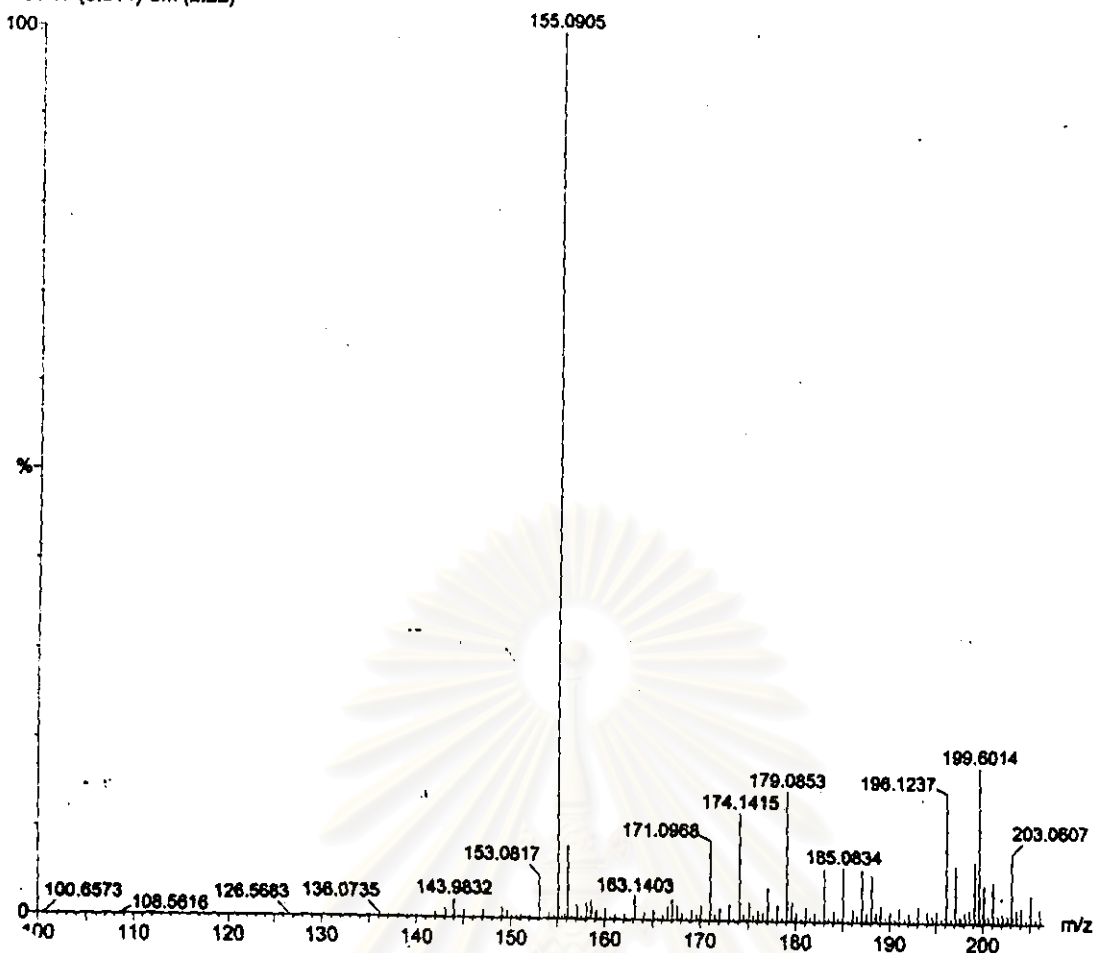


Figure 30. ESITOF mass spectrum of *cyclo*-(L-prolyl-glycyl) (S151)

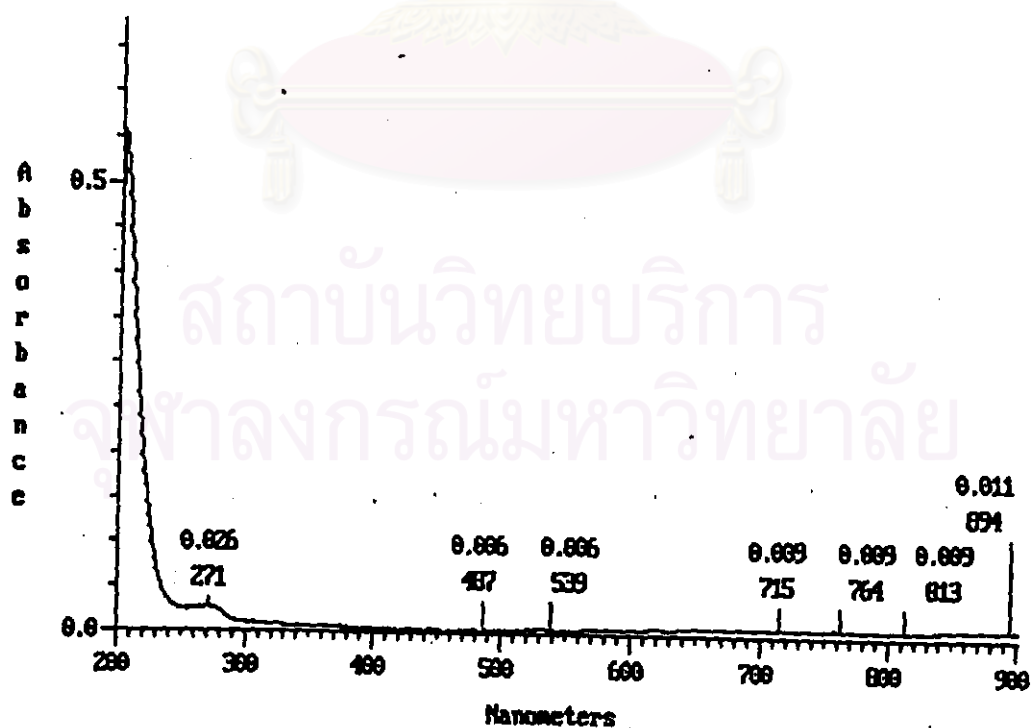


Figure 31. UV spectrum of *cyclo*-(L-prolyl-glycyl) (S151) (in MeOH)

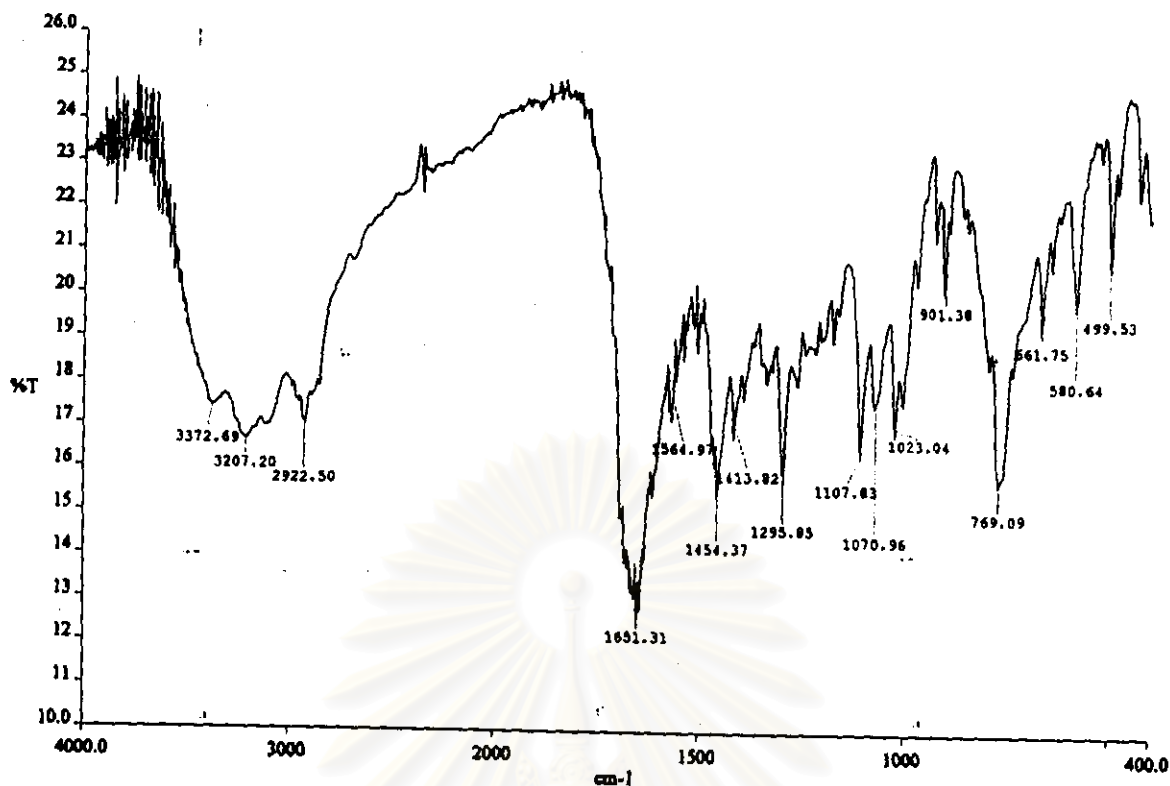


Figure 32. IR spectrum of *cyclo*-(L-prolyl-glycyl) (S151) (film)

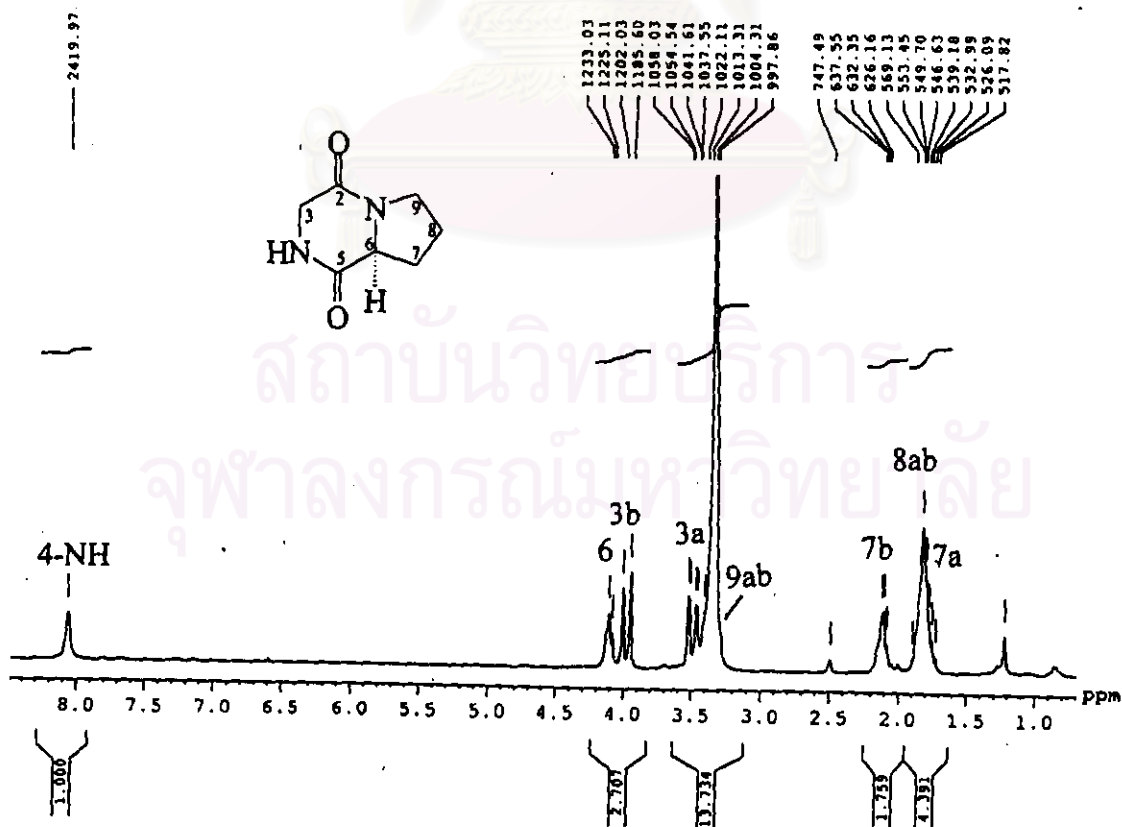


Figure 33. The 300 MHz <sup>1</sup>H NMR spectrum of *cyclo*-(L-prolyl-glycyl) (S151) (in  $\text{DMSO-}d_6$ )

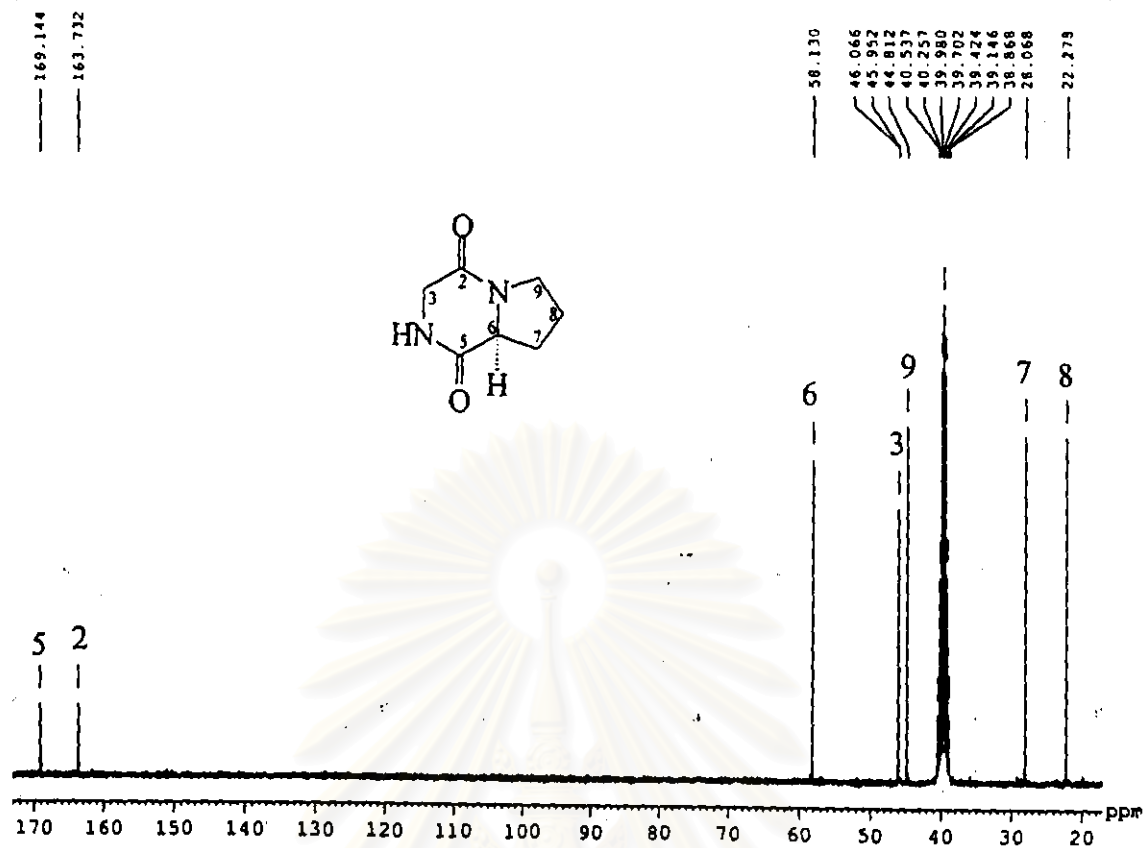


Figure 34. The 75 MHz  $^{13}\text{C}$  NMR spectrum of *cyclo*-(L-prolyl-glycyl) (S151) (in  $\text{DMSO-}d_6$ )

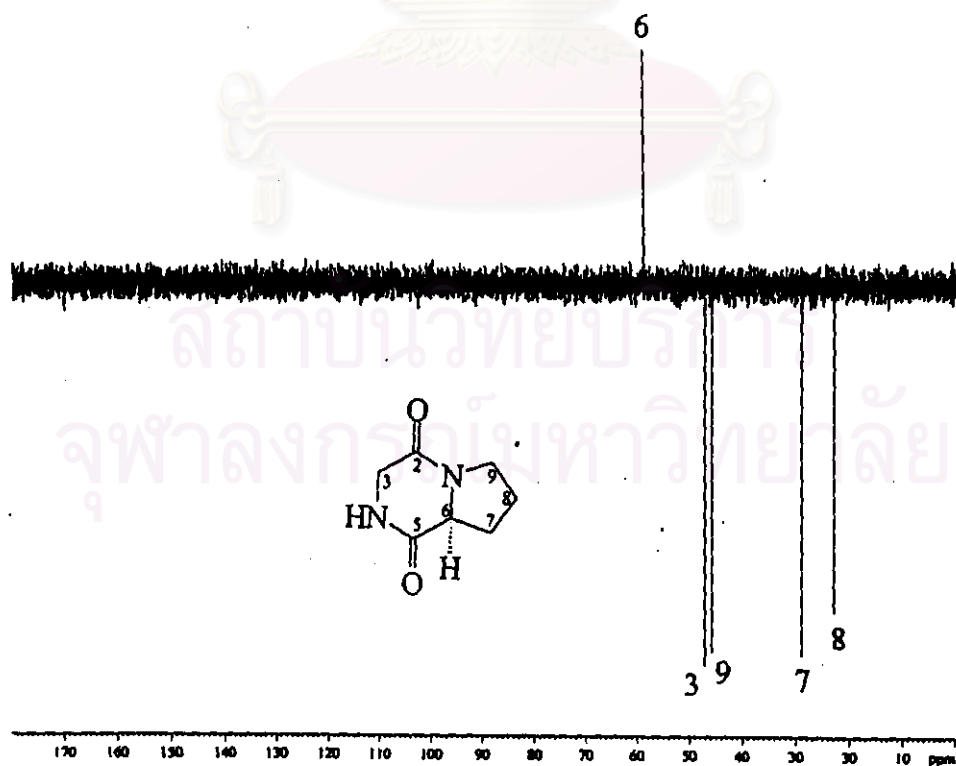


Figure 35. The 75 MHz DEPT 135 spectrum of *cyclo*-(L-prolyl-glycyl) (S151) (in  $\text{DMSO-}d_6$ )

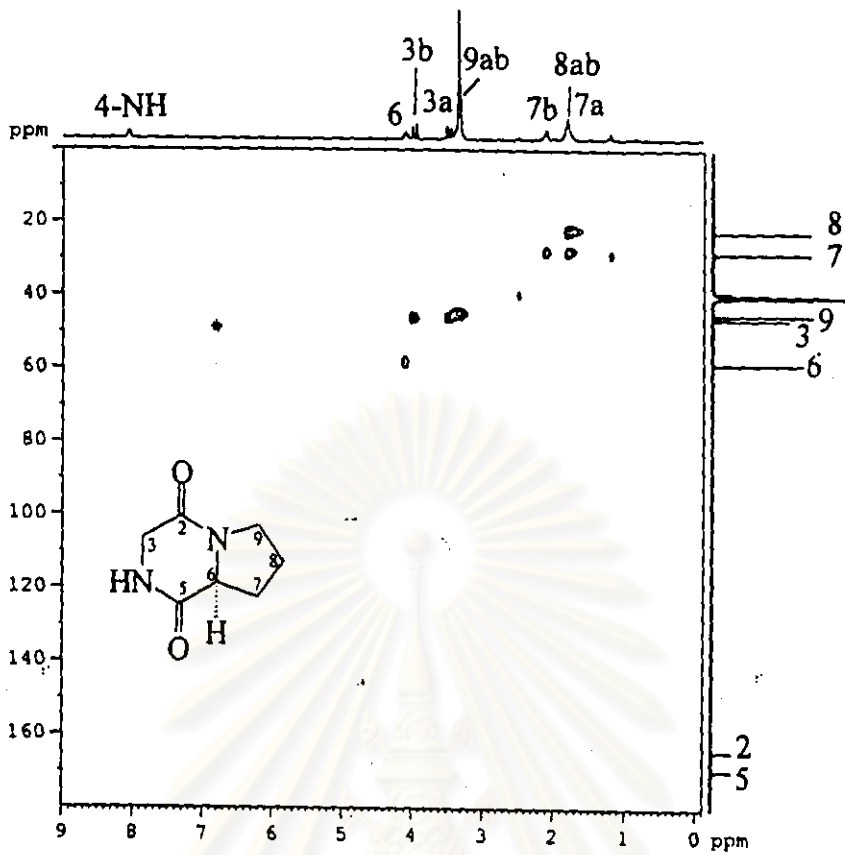


Figure 36. The 300 MHz HMQC spectrum of *cyclo*-(L-prolyl-glycyl) (S151) (in DMSO- $d_6$ )

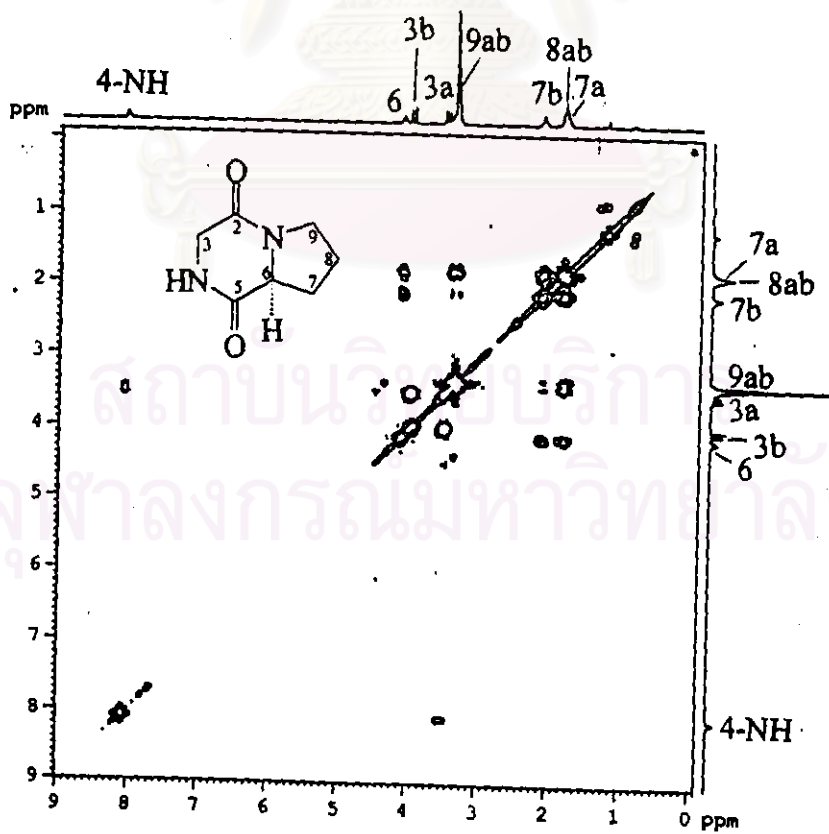
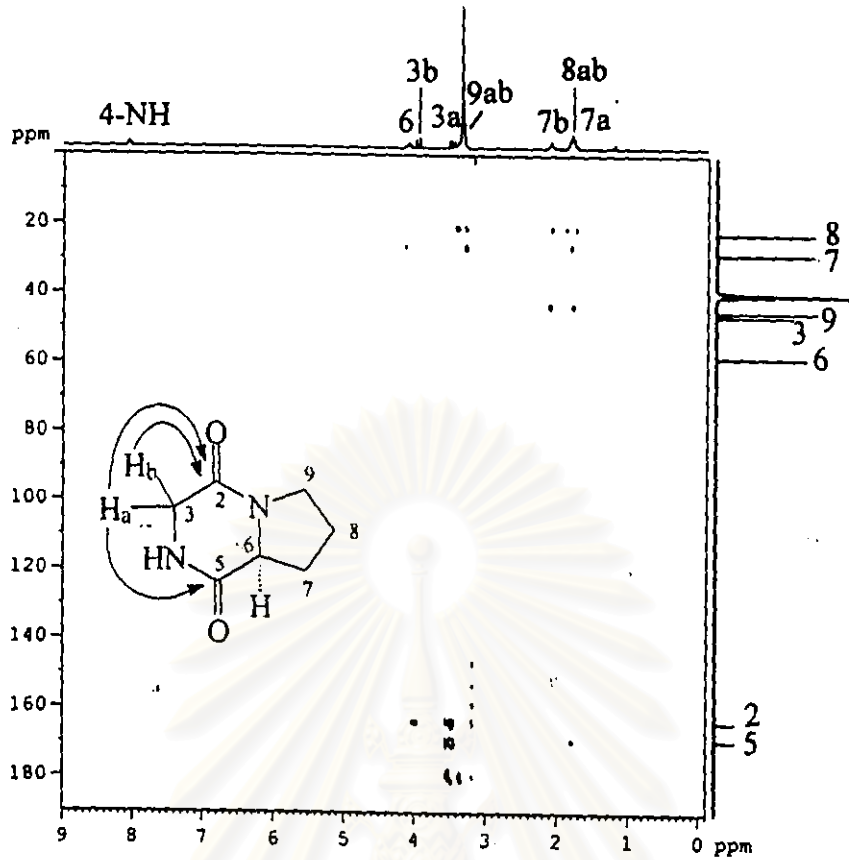


Figure 37. The 300 MHz  $^1\text{H}$ - $^1\text{H}$  COSY spectrum of *cyclo*-(L-prolyl-glycyl) (S151) (in DMSO- $d_6$ )



**Figure 38.** The 300 MHz HMBC spectrum of *cyclo*-(L-prolyl-glycyl) (S151) (in DMSO- $d_6$ )

สถาบันวิทยบริการ  
จุฬาลงกรณ์มหาวิทยาลัย

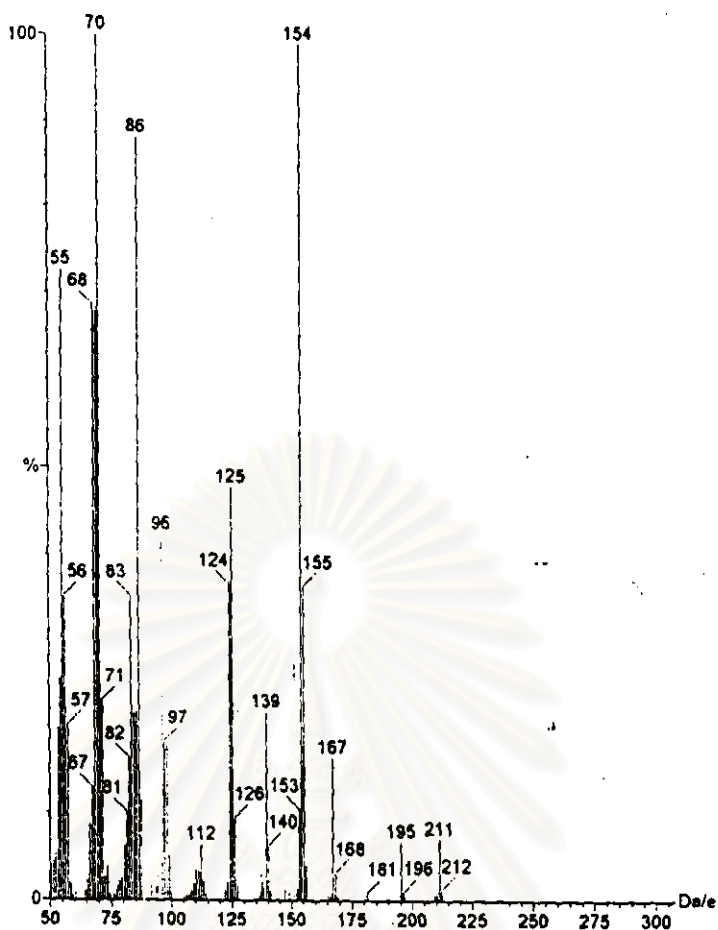


Figure 39. CI mass spectrum of *cyclo*-(L-prolyl-D-leucyl) (P049)

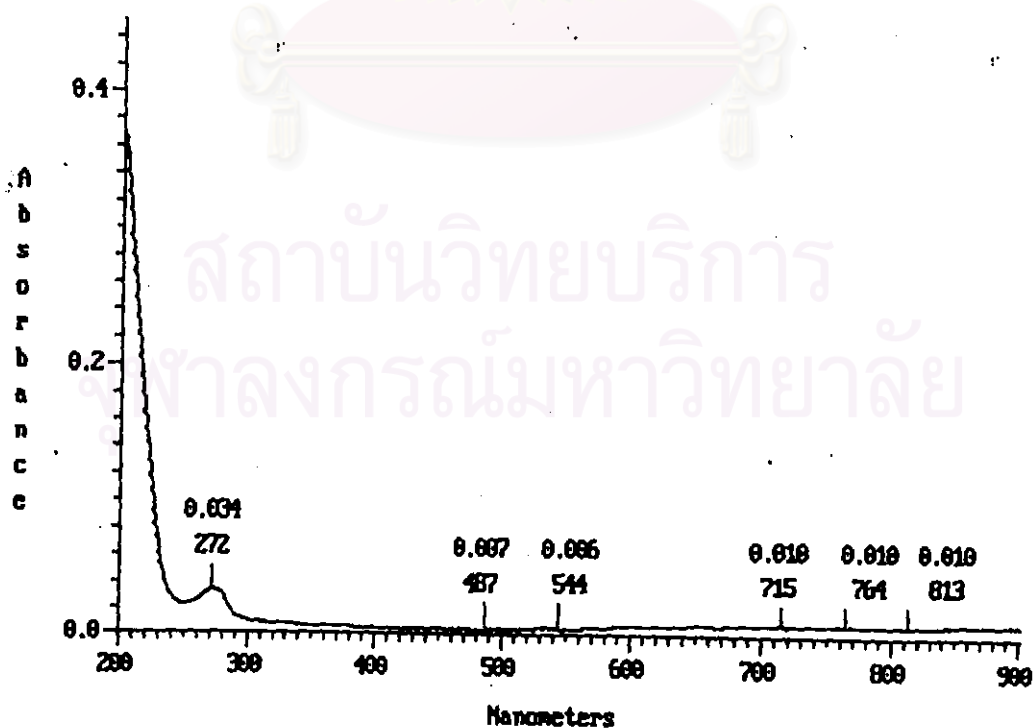


Figure 40. UV spectrum of *cyclo*-(L-prolyl-D-leucyl) (P049) (in MeOH)



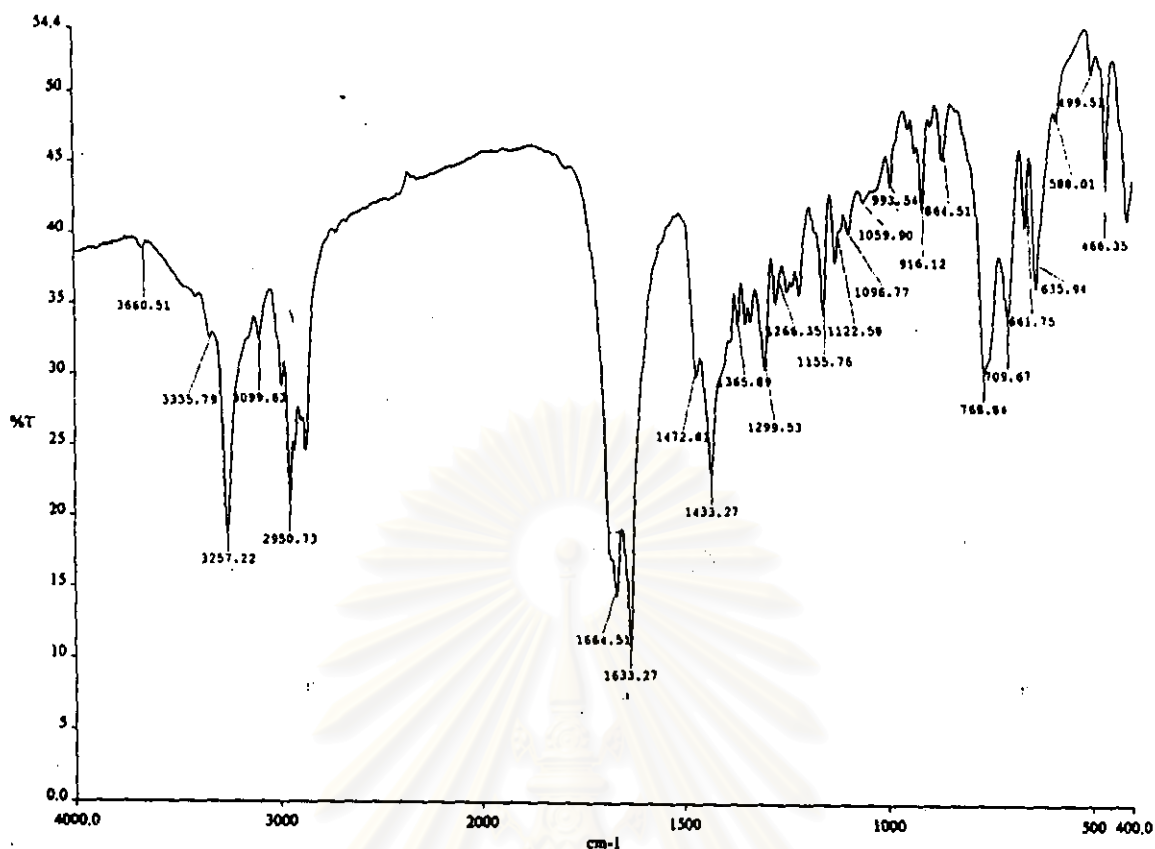


Figure 41. IR spectrum of *cyclo*-(L-prolyl-D-leucyl) (P049) (film)

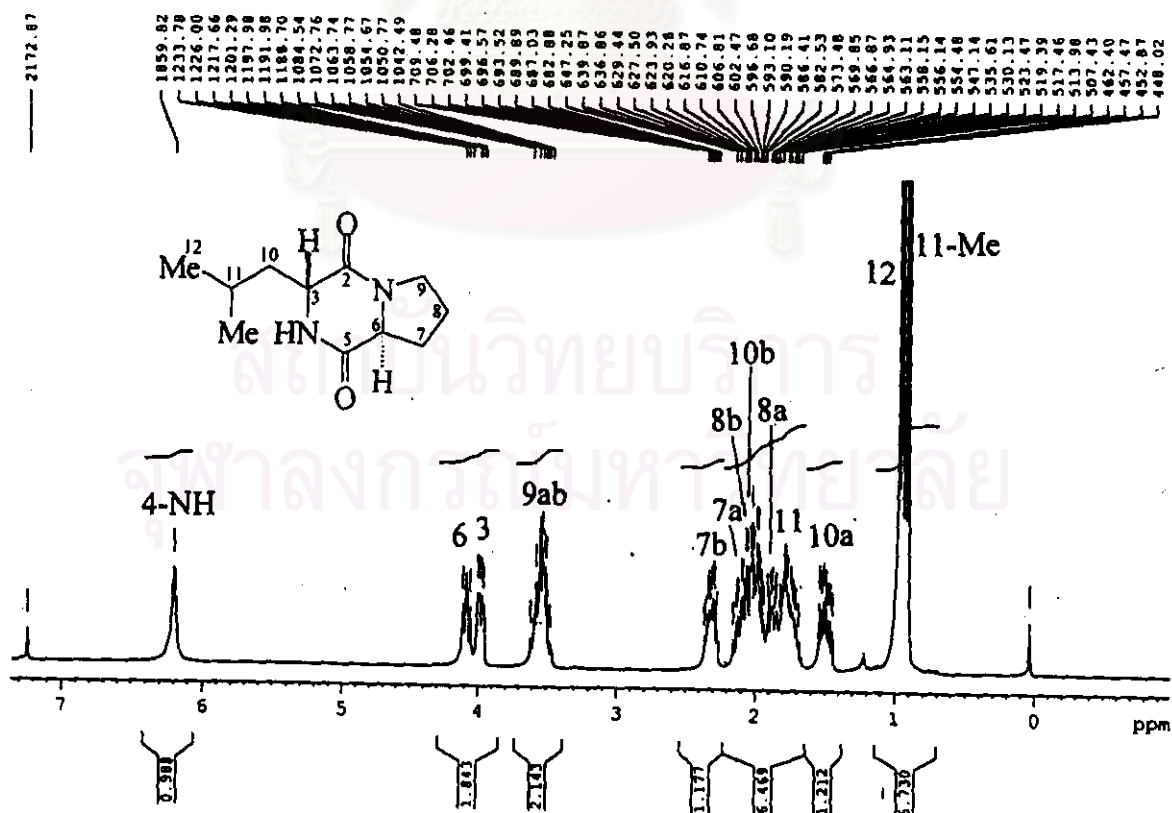


Figure 42. The 300 MHz  $^1\text{H}$  NMR spectrum of *cyclo*-(L-prolyl-D-leucyl) (P049) (in  $\text{CDCl}_3$ )

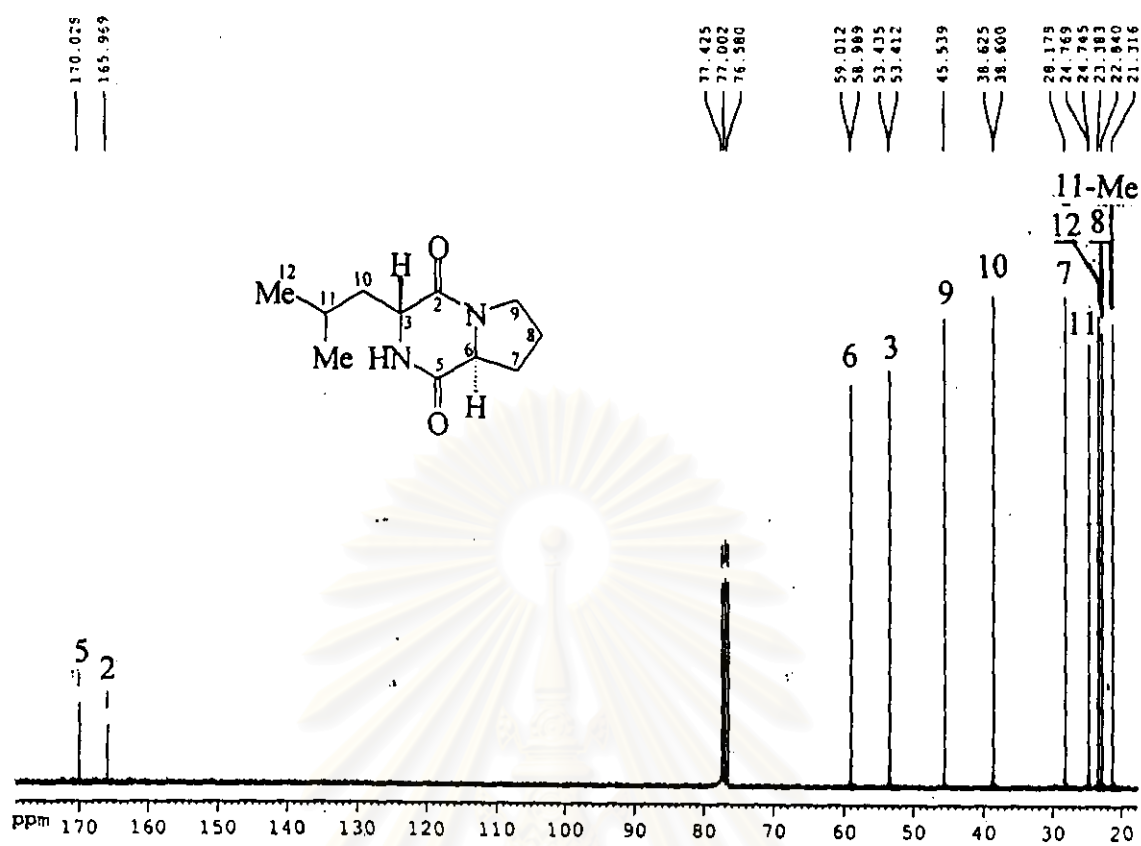


Figure 43. The 75 MHz  $^{13}\text{C}$  NMR spectrum of *cyclo*-(L-prolyl-D-leucyl) (P049) (in  $\text{CDCl}_3$ )

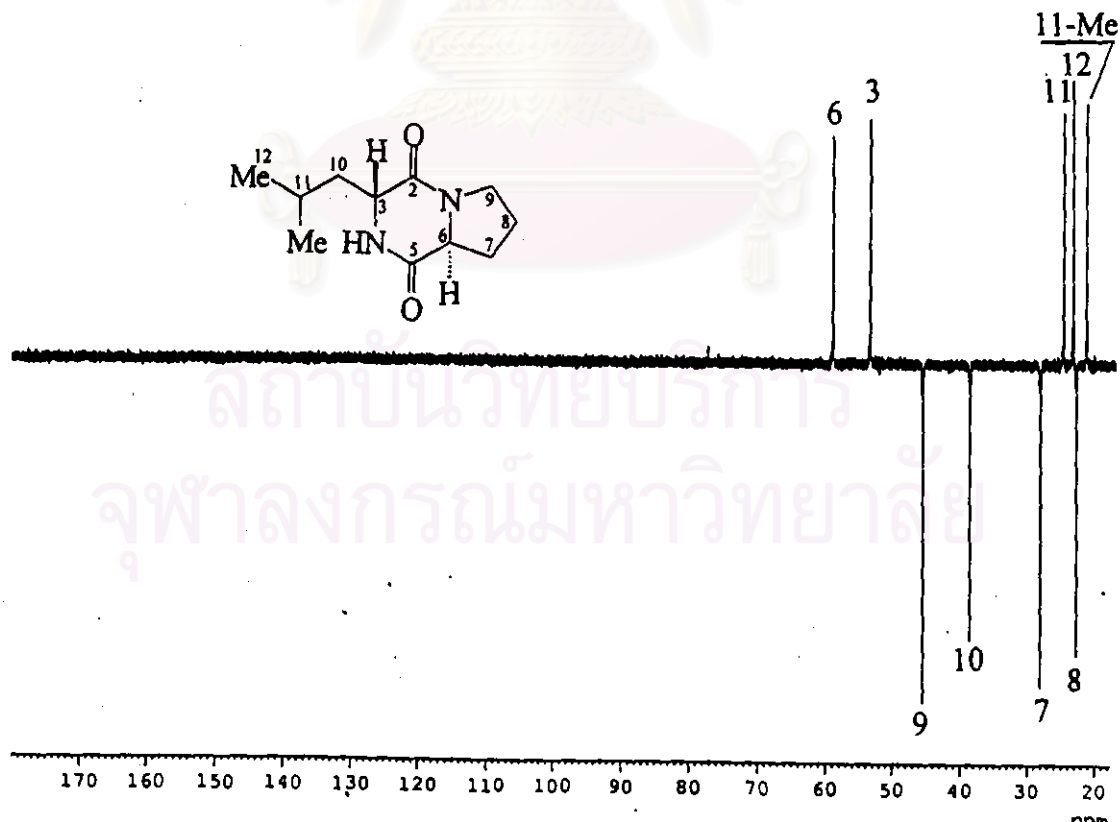


Figure 44. The 75 MHz DEPT 135 spectrum of *cyclo*-(L-prolyl-D-leucyl) (P049) (in  $\text{CDCl}_3$ )

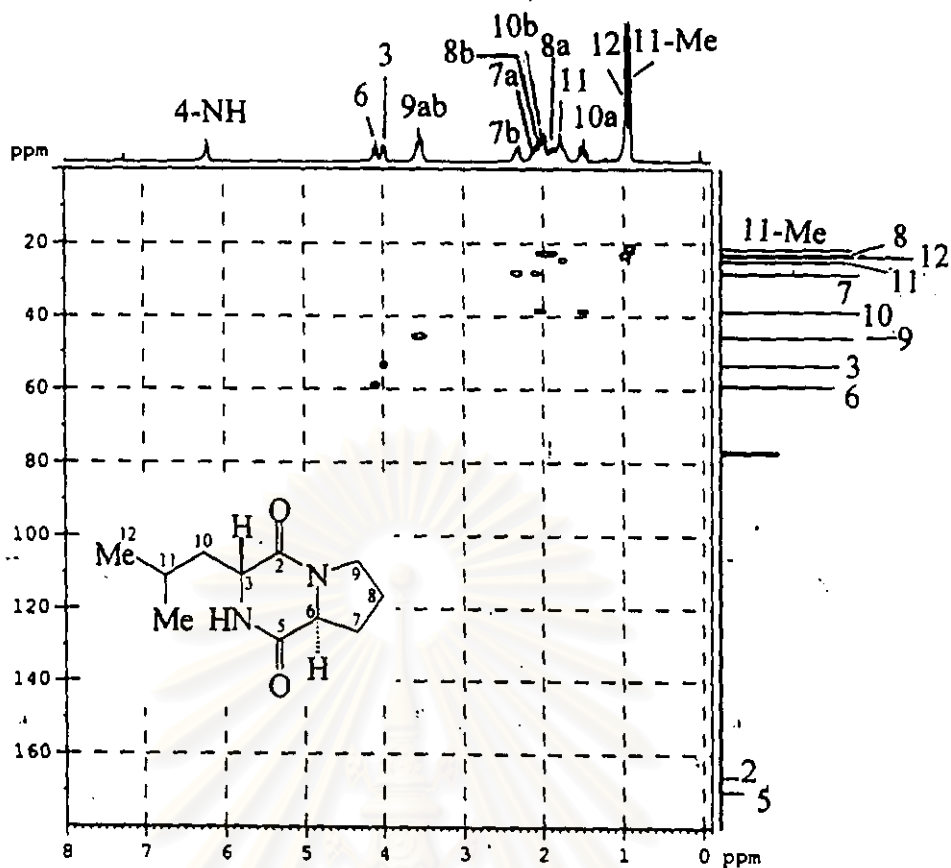


Figure 45. The 300 MHz HMQC spectrum of *cyclo*-(L-prolyl-D-leucyl) (P049) (in CDCl<sub>3</sub>)

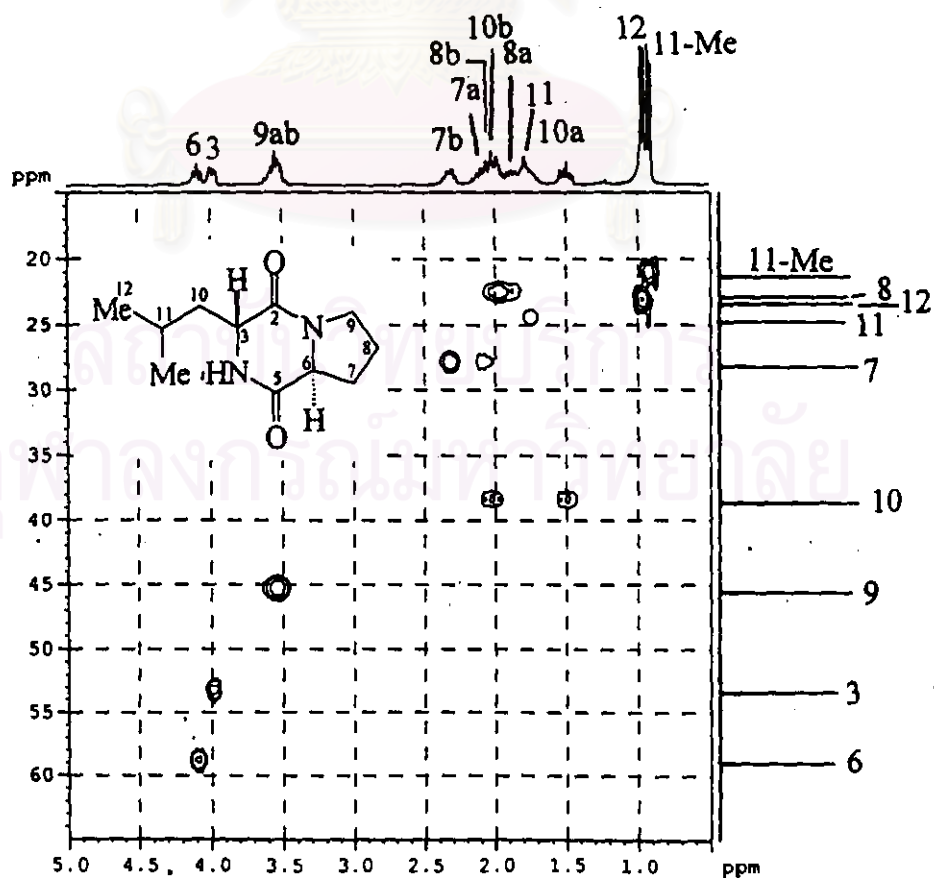
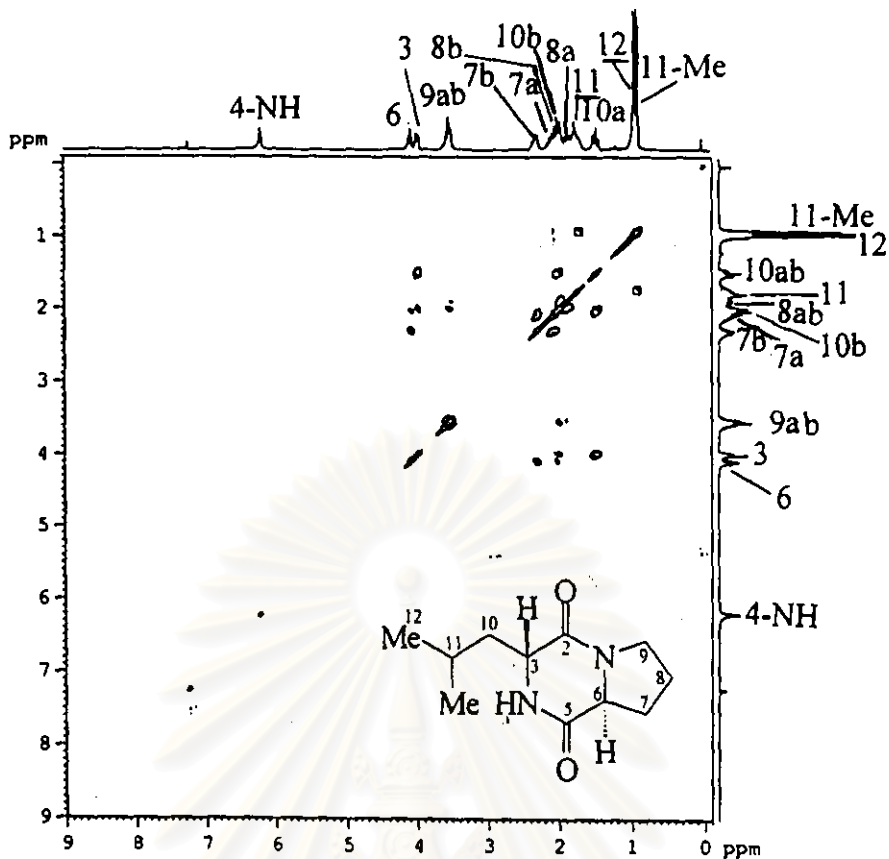
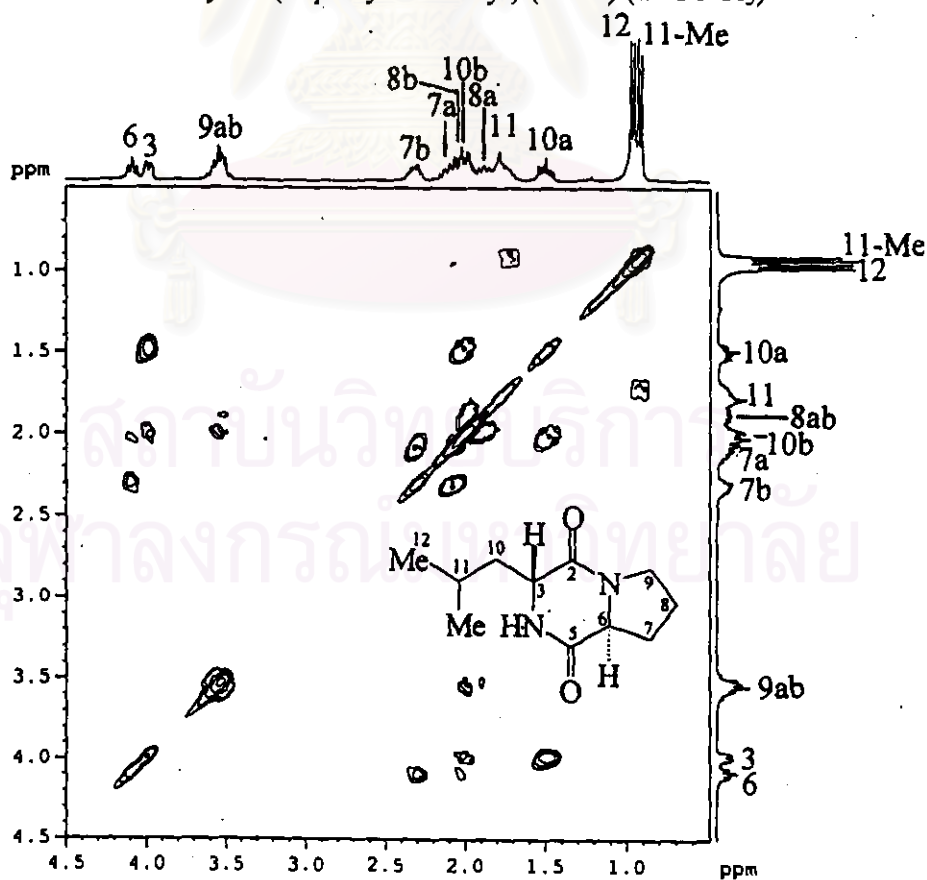


Figure 46. The 300 MHz HMQC spectrum of *cyclo*-(L-prolyl-D-leucyl) (P049) (in CDCl<sub>3</sub>) (expanded from 0.5-5.0 ppm)



**Figure 47.** The 300 MHz  $^1\text{H}$ - $^1\text{H}$  COSY spectrum of *cyclo*-(L-prolyl-D-leucyl) (P049) (in  $\text{CDCl}_3$ )



**Figure 48.** The 300 MHz  $^1\text{H}$ - $^1\text{H}$  COSY spectrum of *cyclo*-(L-prolyl-D-leucyl) (P049) (in  $\text{CDCl}_3$ ) (expanded from 0.5-4.5 ppm)

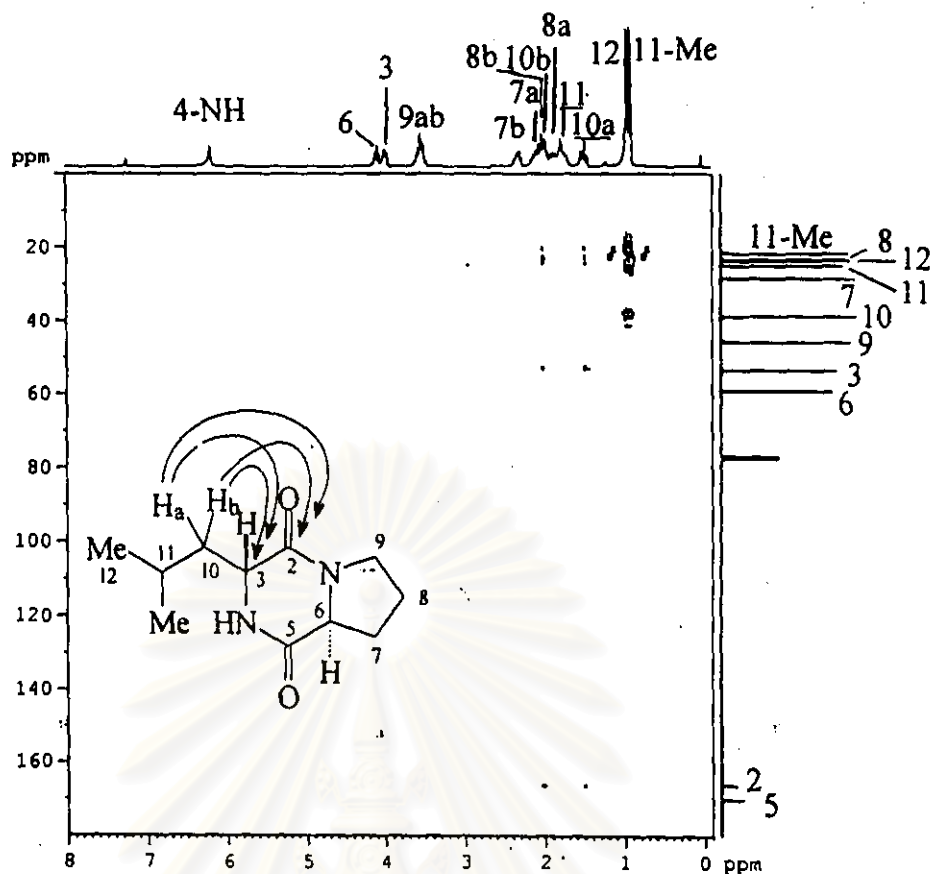


Figure 49. The 300 MHz HMBC spectrum of *cyclo*-(L-prolyl-D-leucyl) (P049) (in  $\text{CDCl}_3$ )

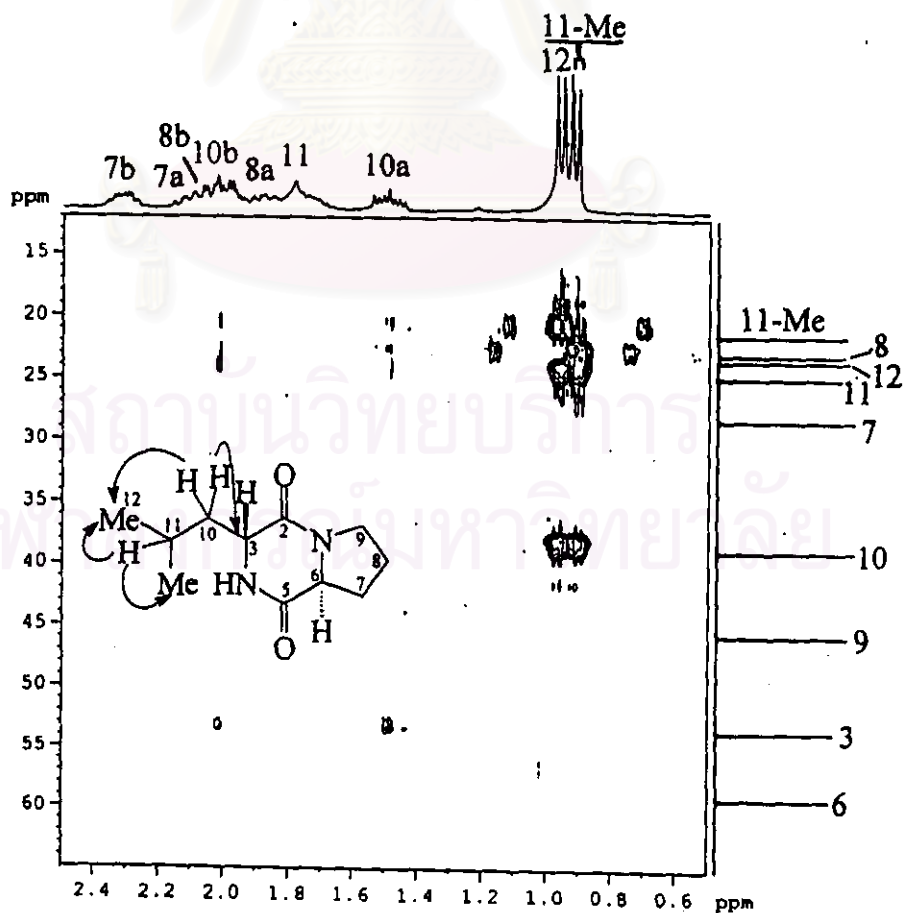
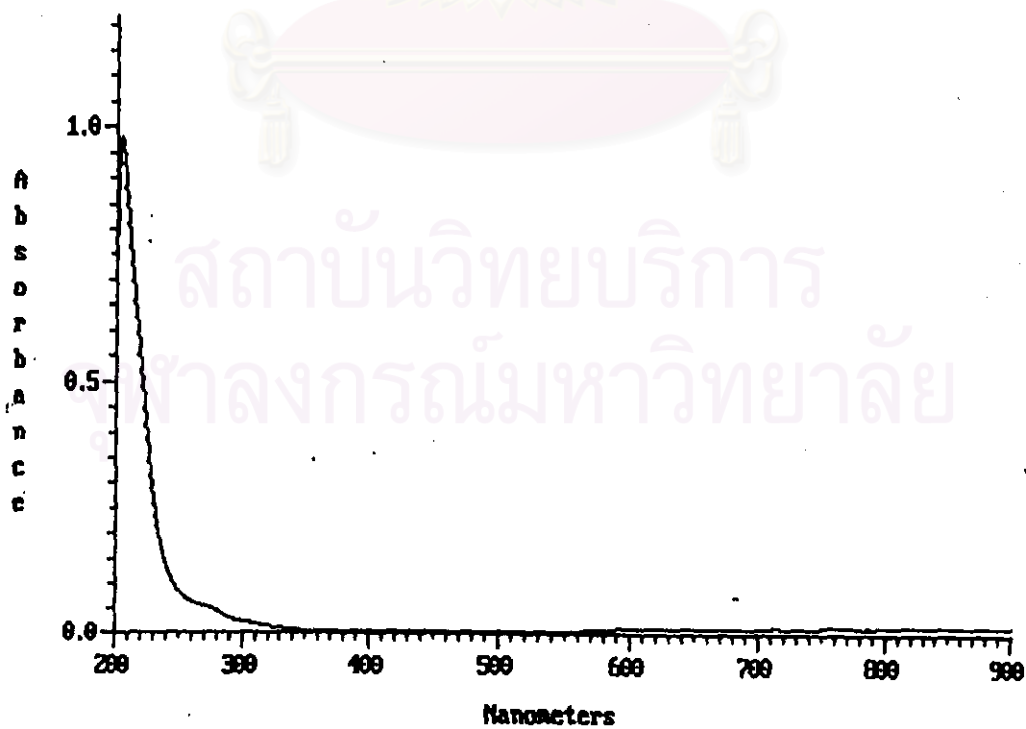
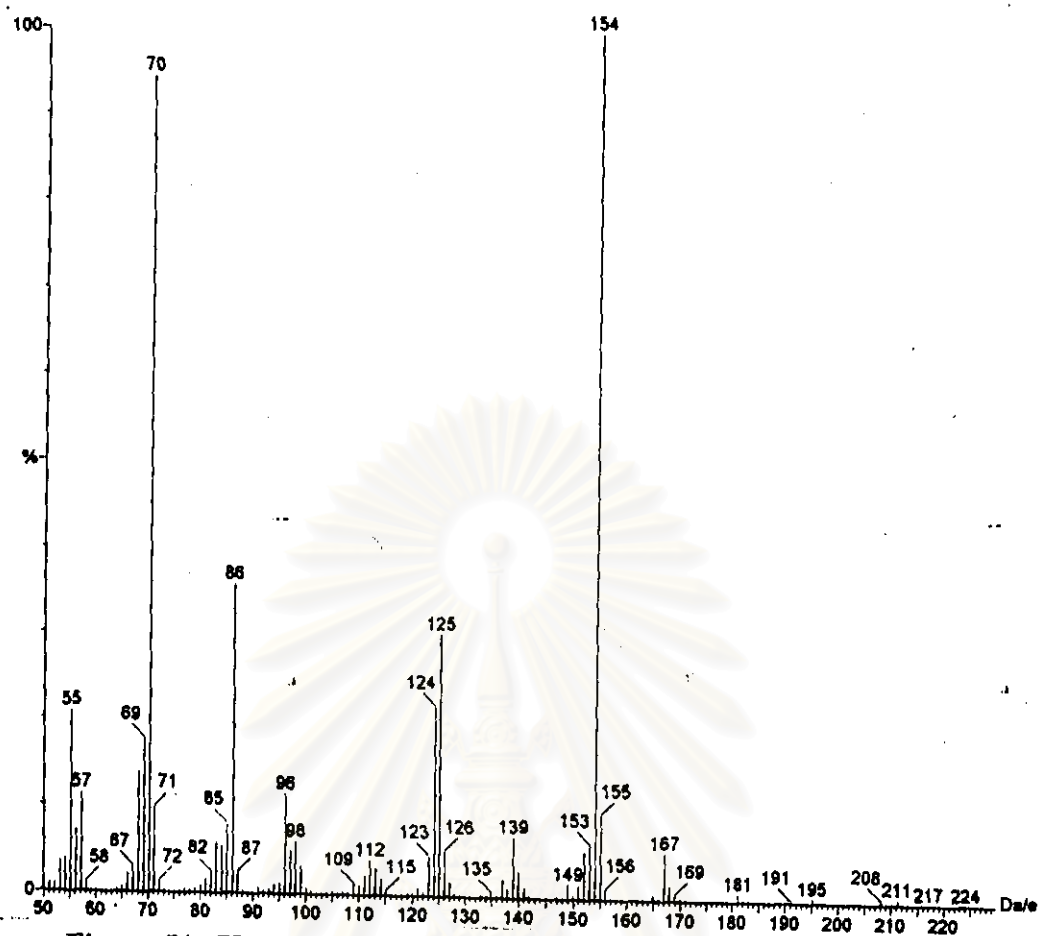


Figure 50. The 300 MHz HMBC spectrum of *cyclo*-(L-prolyl-D-leucyl) (P049) (in  $\text{CDCl}_3$ ) (expanded from 0.5-2.5 ppm)





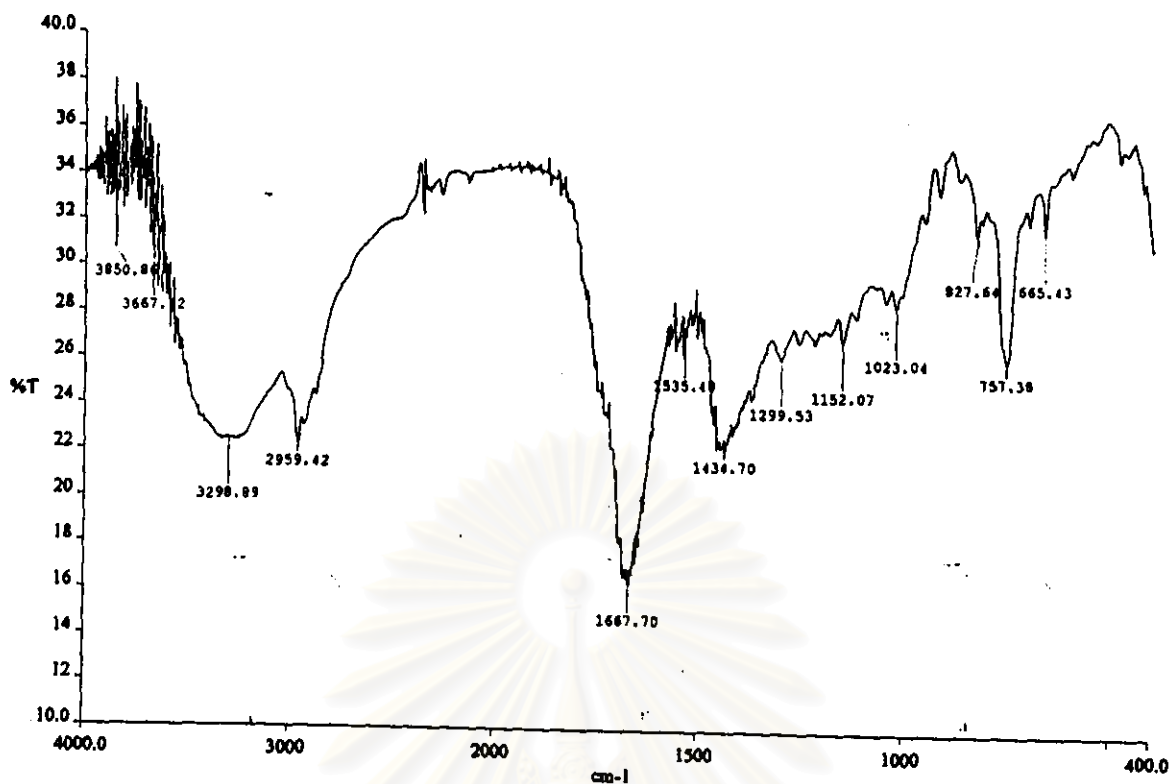


Figure 53. IR spectrum of cyclo-(D-prolyl-leucyl) (F019) (film)

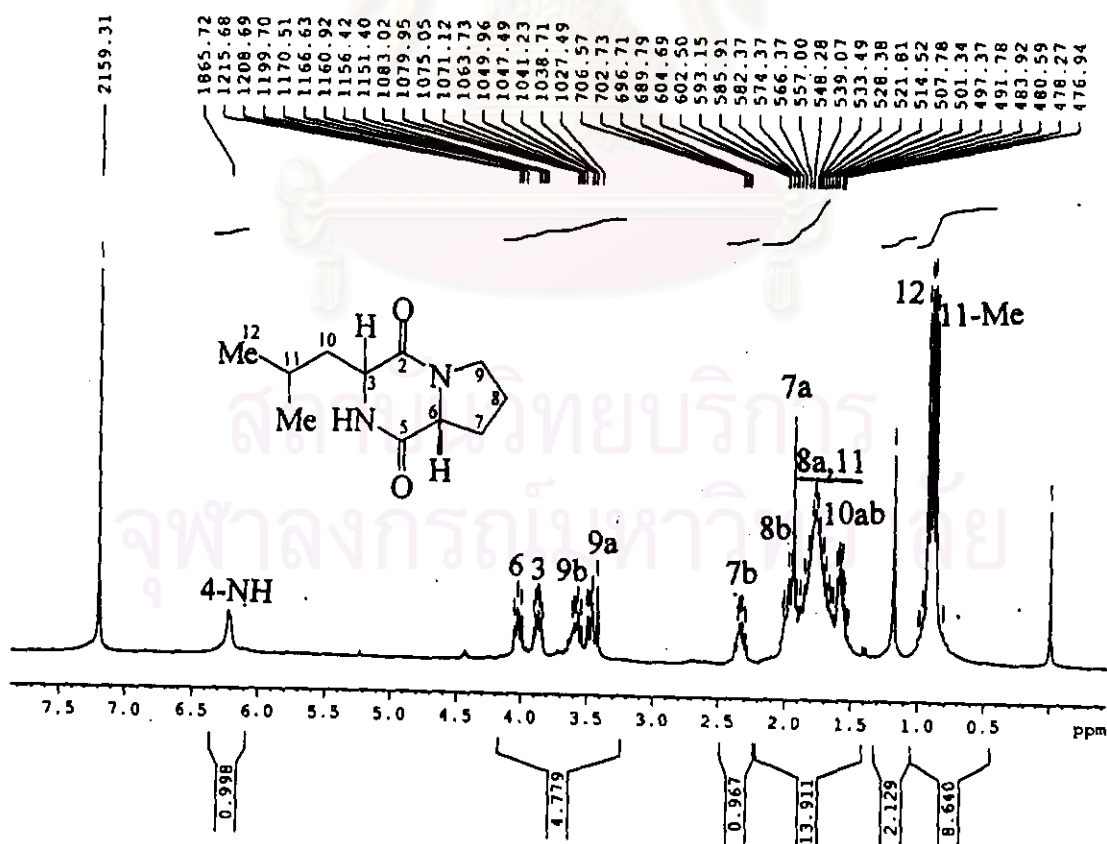


Figure 54. The 300 MHz <sup>1</sup>H NMR spectrum of cyclo-(D-prolyl-leucyl) (F019) (in CDCl<sub>3</sub>)

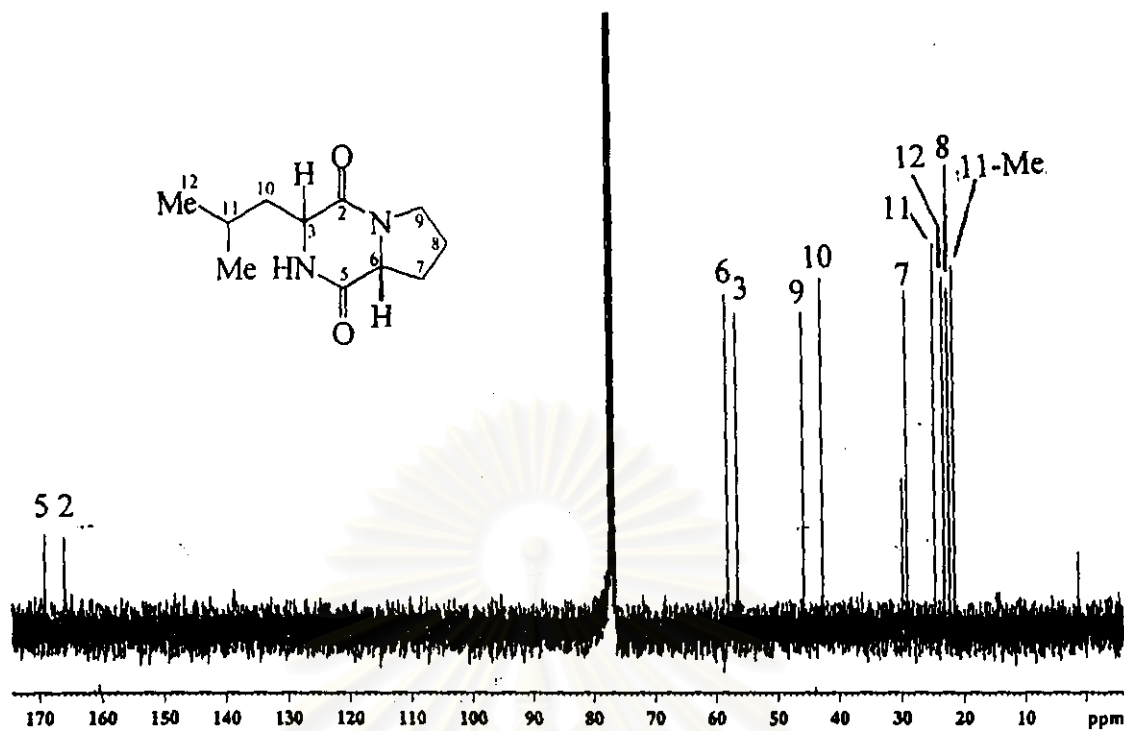


Figure 55. The 75 MHz  $^{13}\text{C}$  NMR spectrum of cyclo-(D-prolyl-leucyl) (F019) (in  $\text{CDCl}_3$ )

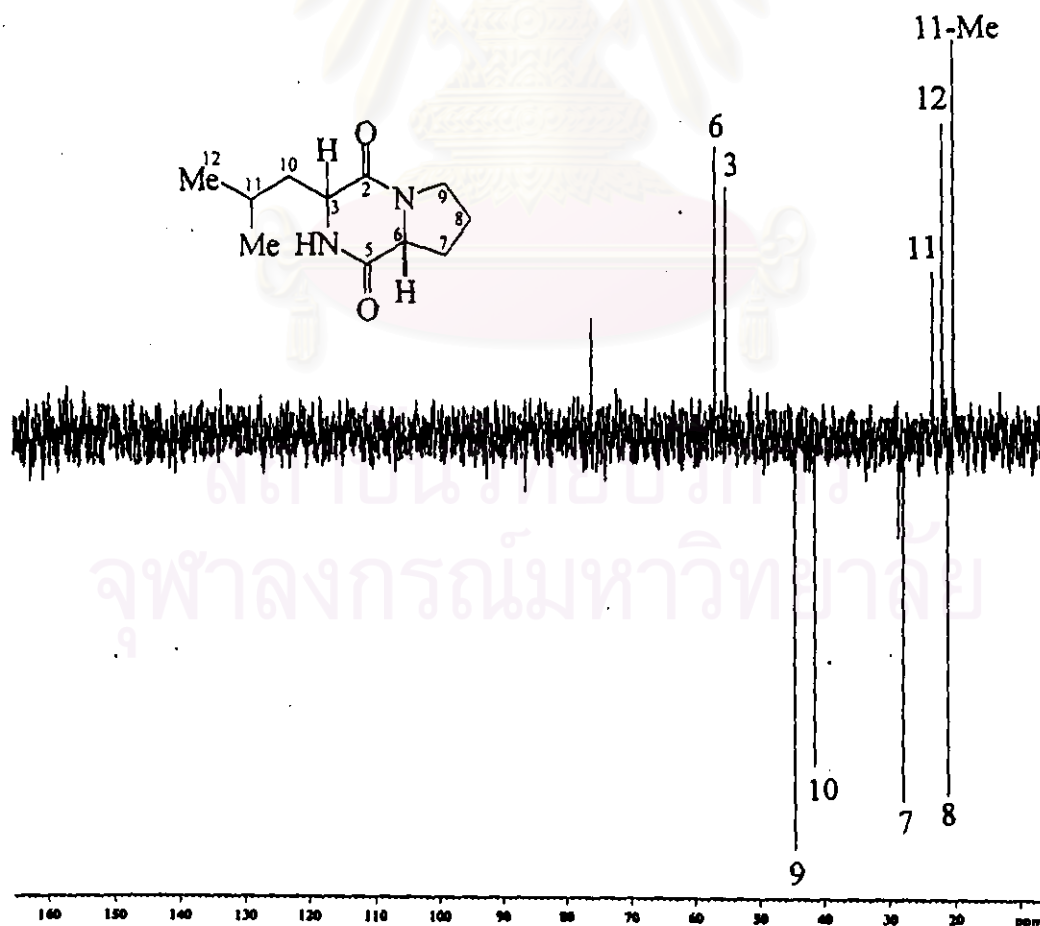


Figure 56. The 75 MHz DEPT 135 spectrum of cyclo-(D-prolyl-leucyl) (F019) (in  $\text{CDCl}_3$ )

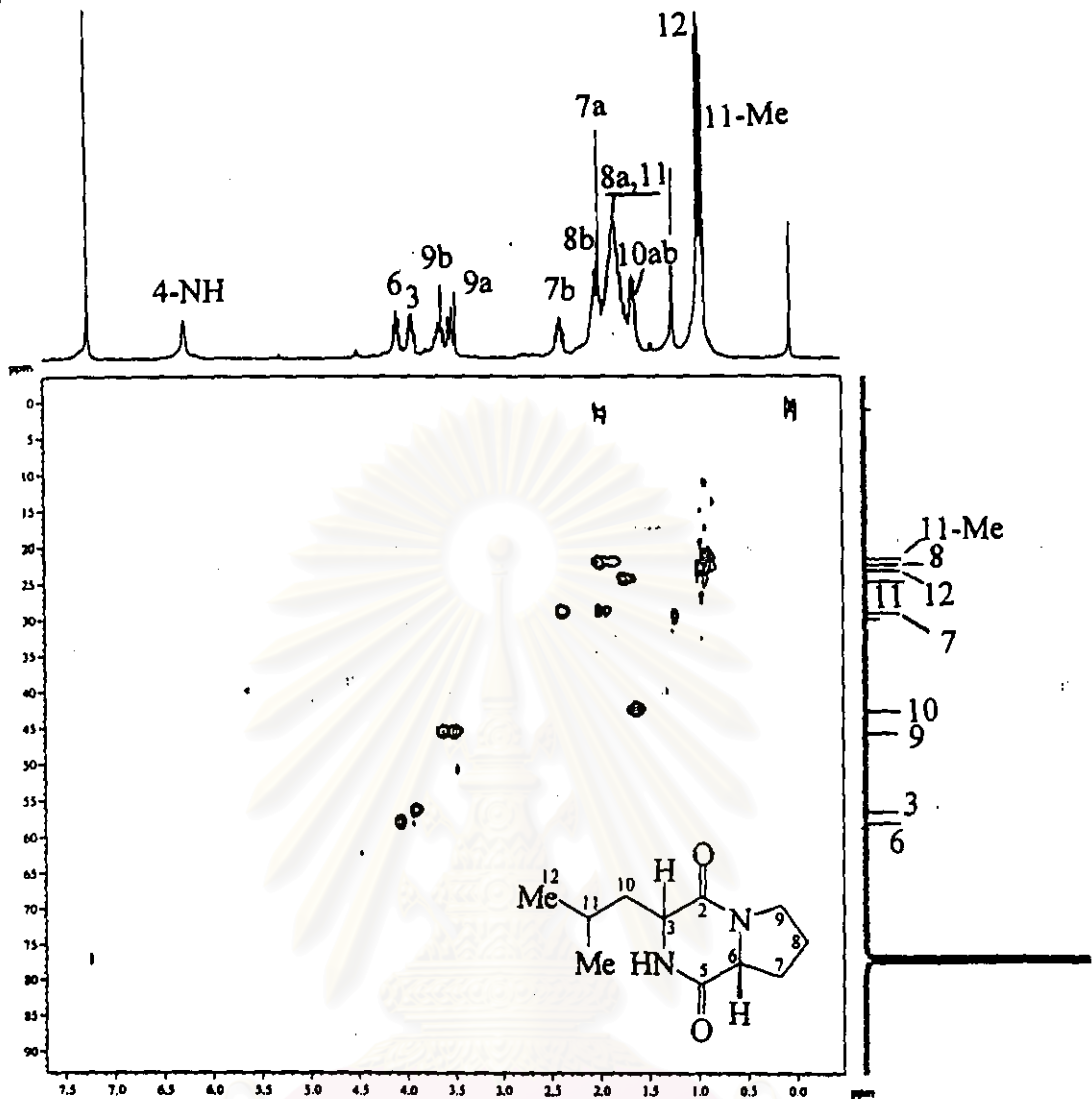


Figure 57. The 300 MHz HMQC spectrum of *cyclo*-(D-prolyl-leucyl) (F019) (in CDCl<sub>3</sub>)

สถาบันวิทยบริการ  
จุฬาลงกรณ์มหาวิทยาลัย

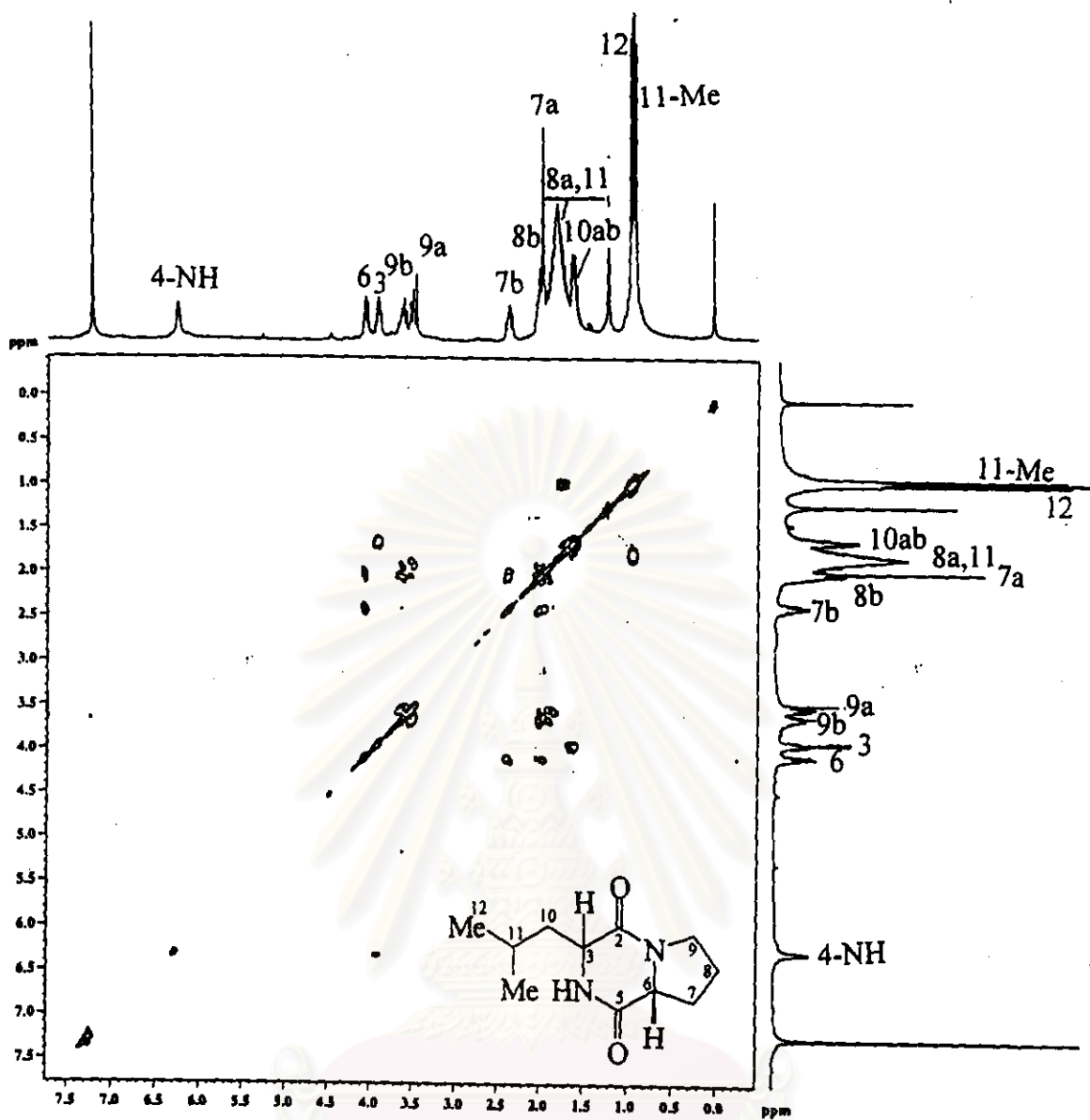


Figure 58. The 300 MHz  $^1\text{H}$ - $^1\text{H}$  COSY spectrum of *cyclo*-(D-prolyl-leucyl) (F019) (in  $\text{CDCl}_3$ )

สถาบันวิทยบริการ  
จุฬาลงกรณ์มหาวิทยาลัย

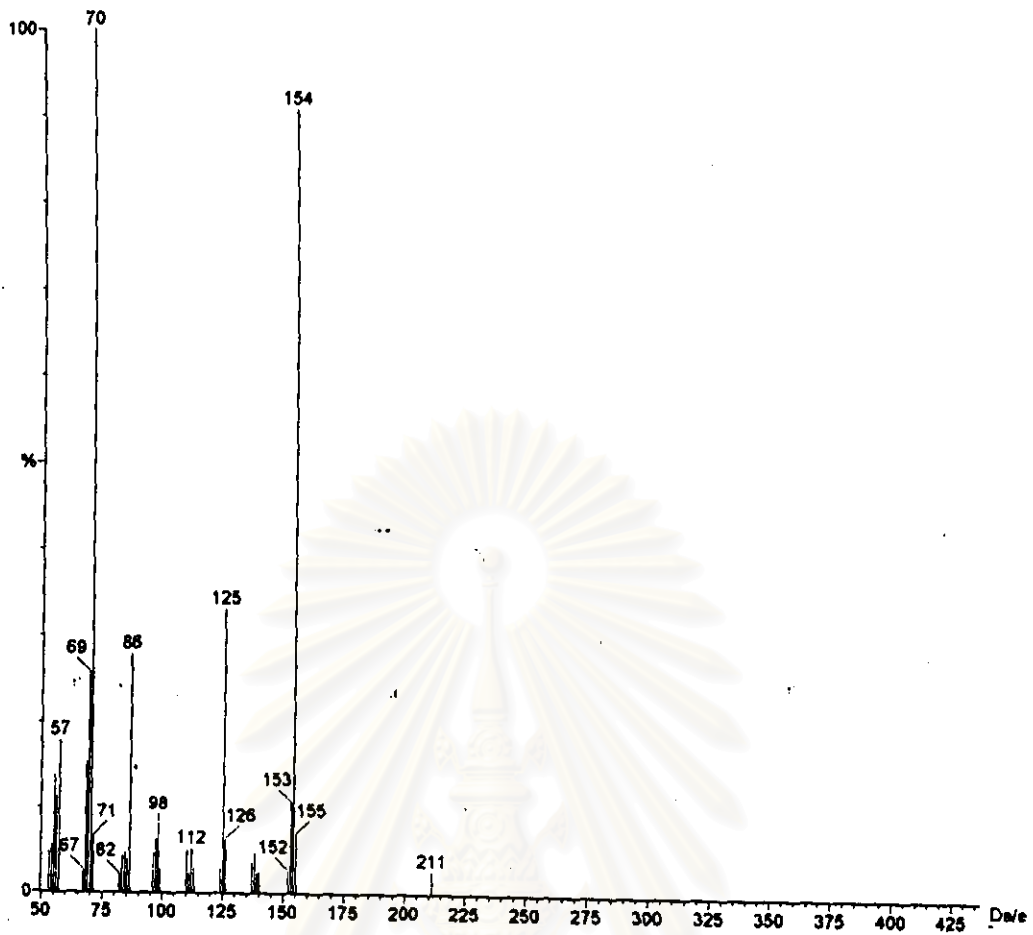


Figure 59. CI mass spectrum of *cyclo*-(D-prolyl-isoleucyl) (F017)

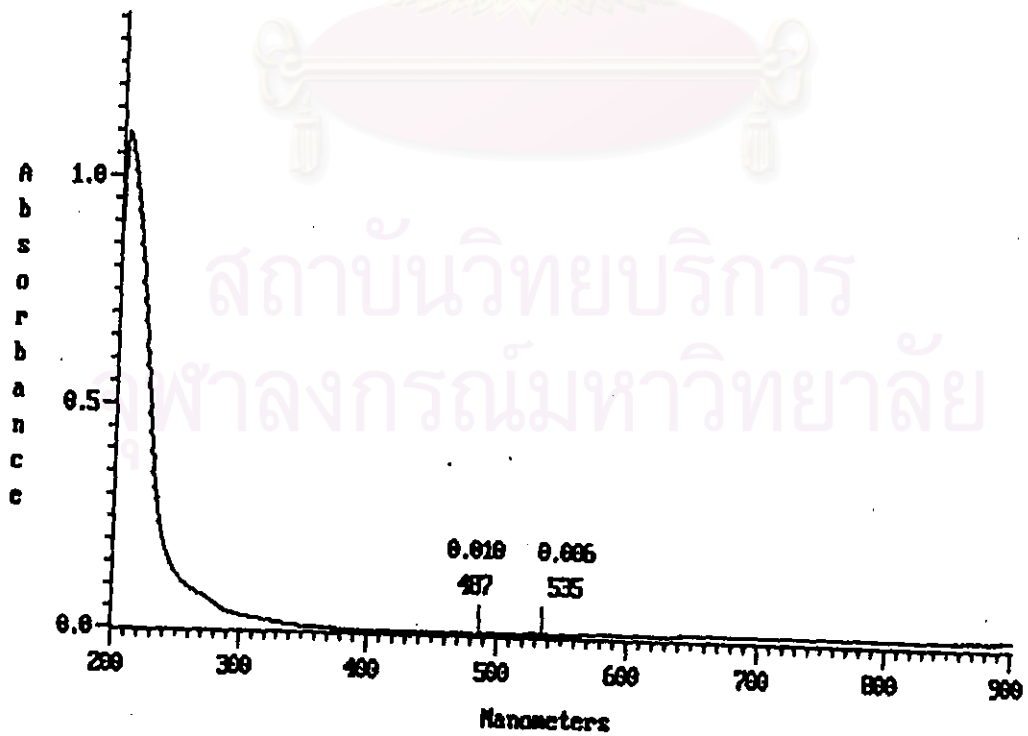


Figure 60. UV spectrum of *cyclo*-(D-prolyl-isoleucyl) (F017) (in MeOH)

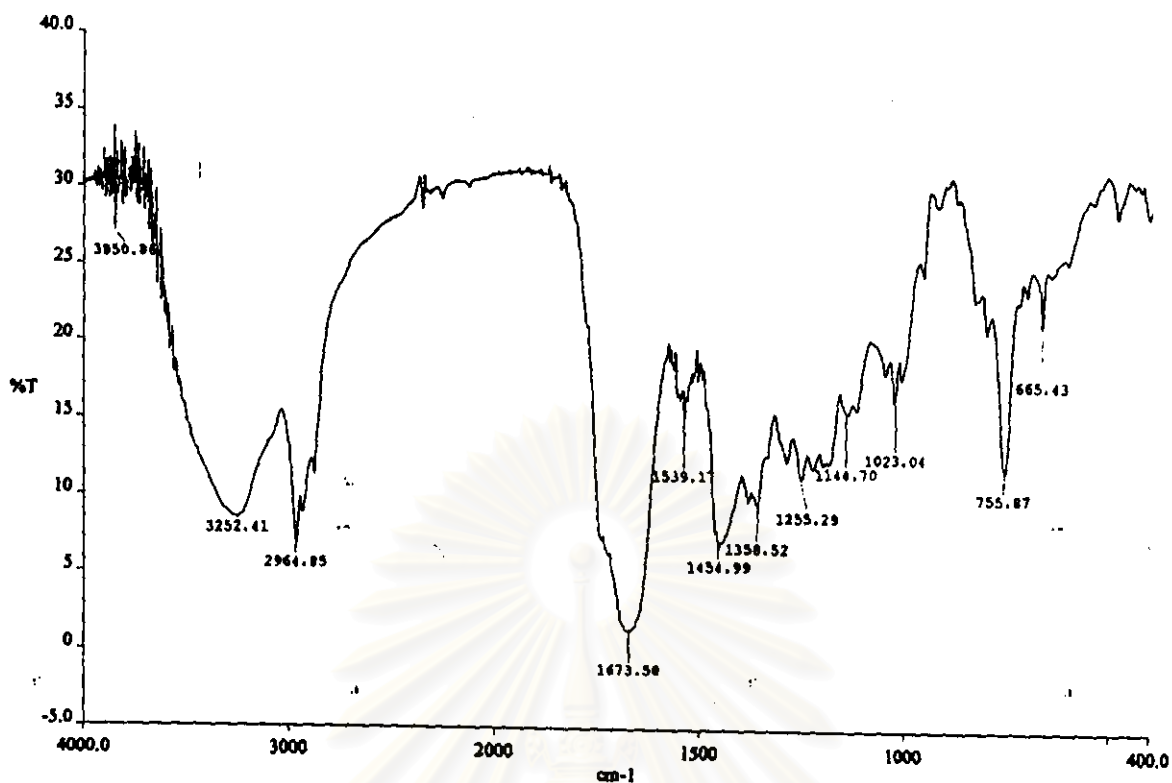


Figure 61. IR spectrum of *cyclo*-(D-prolyl-isoleucyl) (F017) (film)

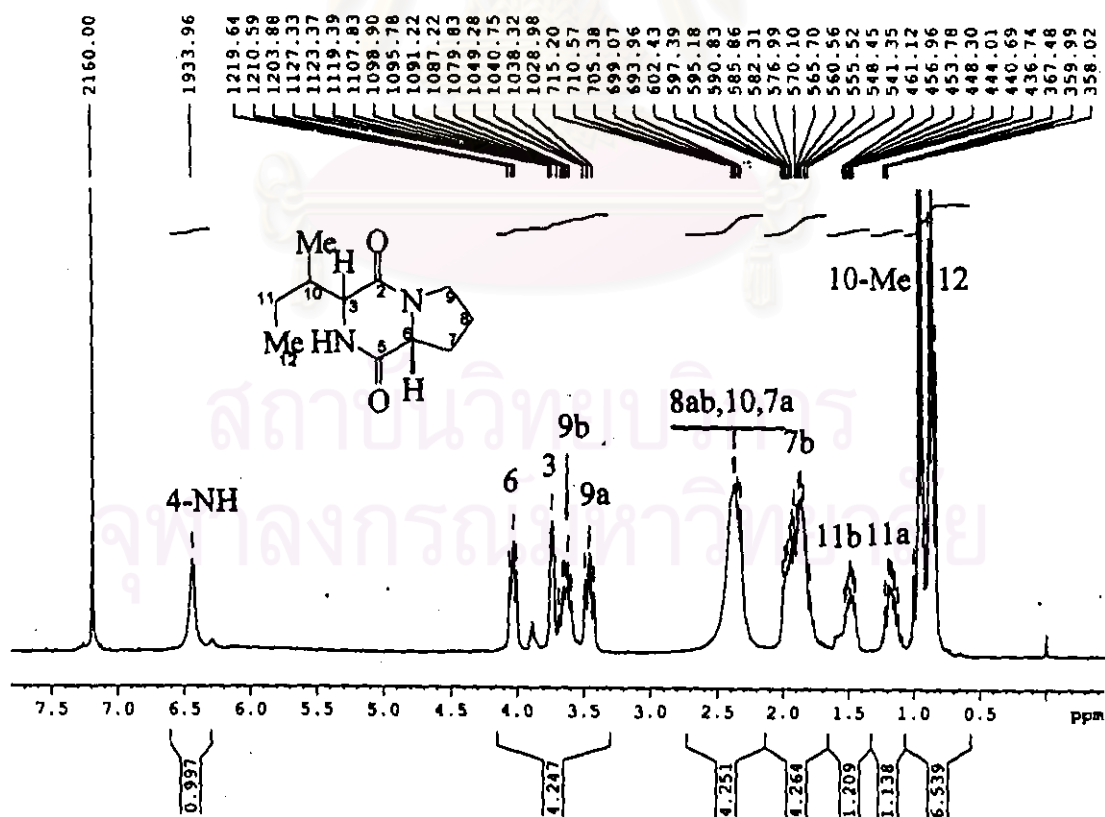


Figure 62. The 300 MHz  $^1\text{H}$  NMR spectrum of *cyclo*-(D-prolyl-isoleucyl) (F017) (in  $\text{CDCl}_3$ )



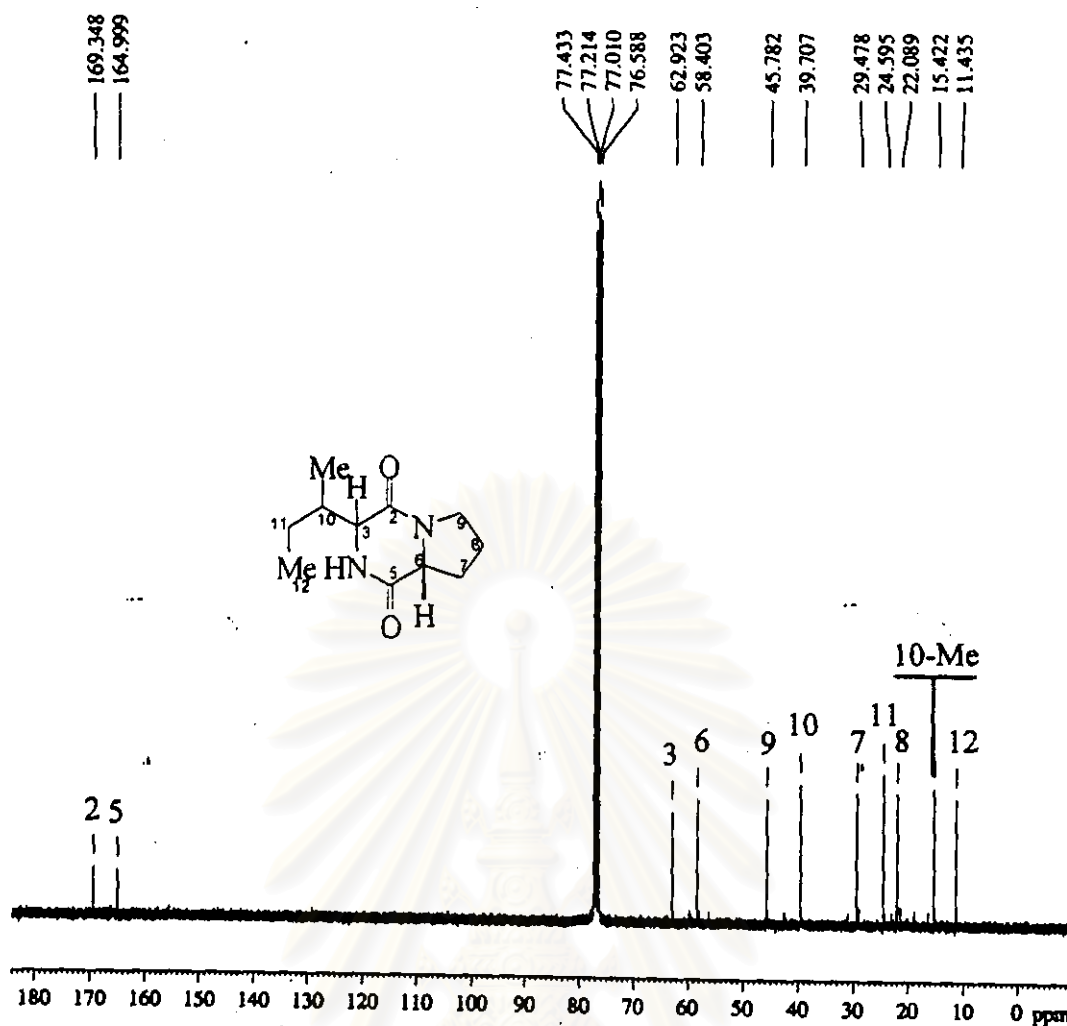


Figure 63. The 75 MHz  $^{13}\text{C}$  NMR spectrum of *cyclo*-(D-prolyl-isoleucyl) (F017) (in  $\text{CDCl}_3$ )

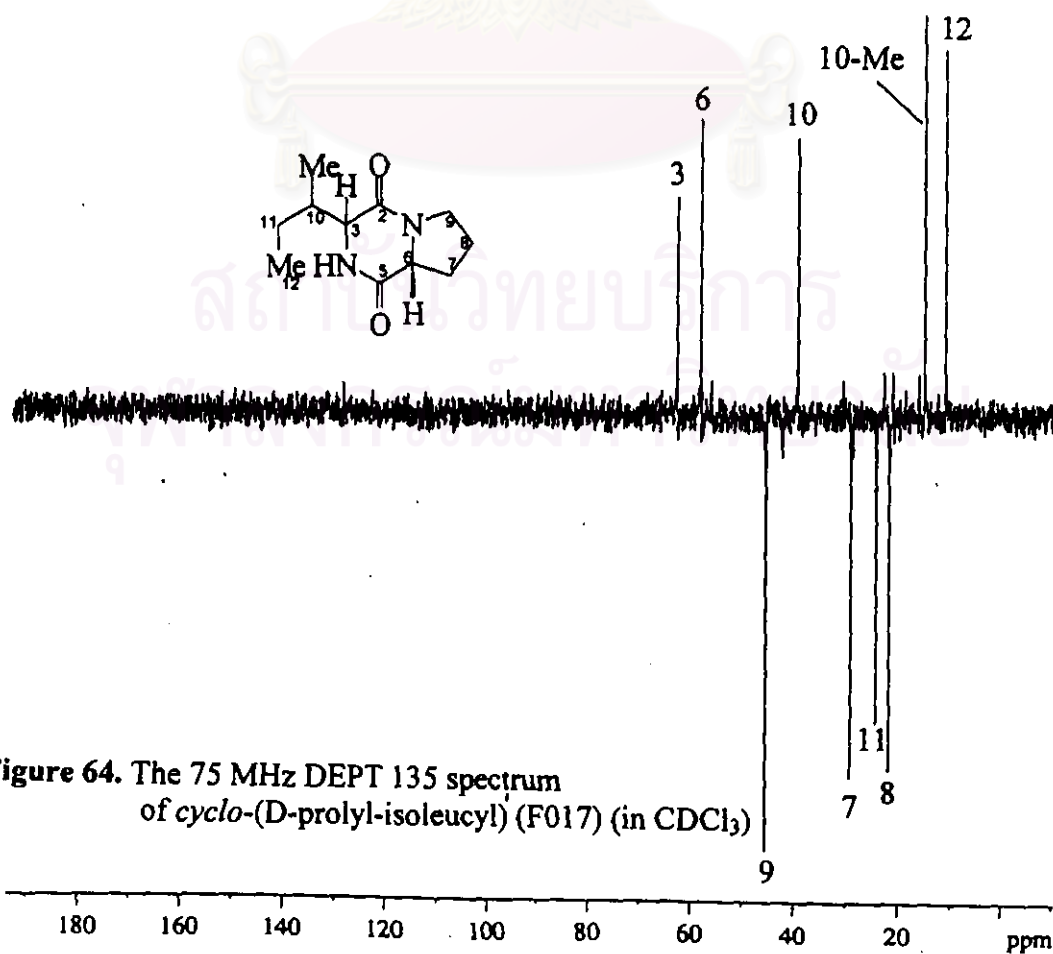


Figure 64. The 75 MHz DEPT 135 spectrum of *cyclo*-(D-prolyl-isoleucyl) (F017) (in  $\text{CDCl}_3$ )

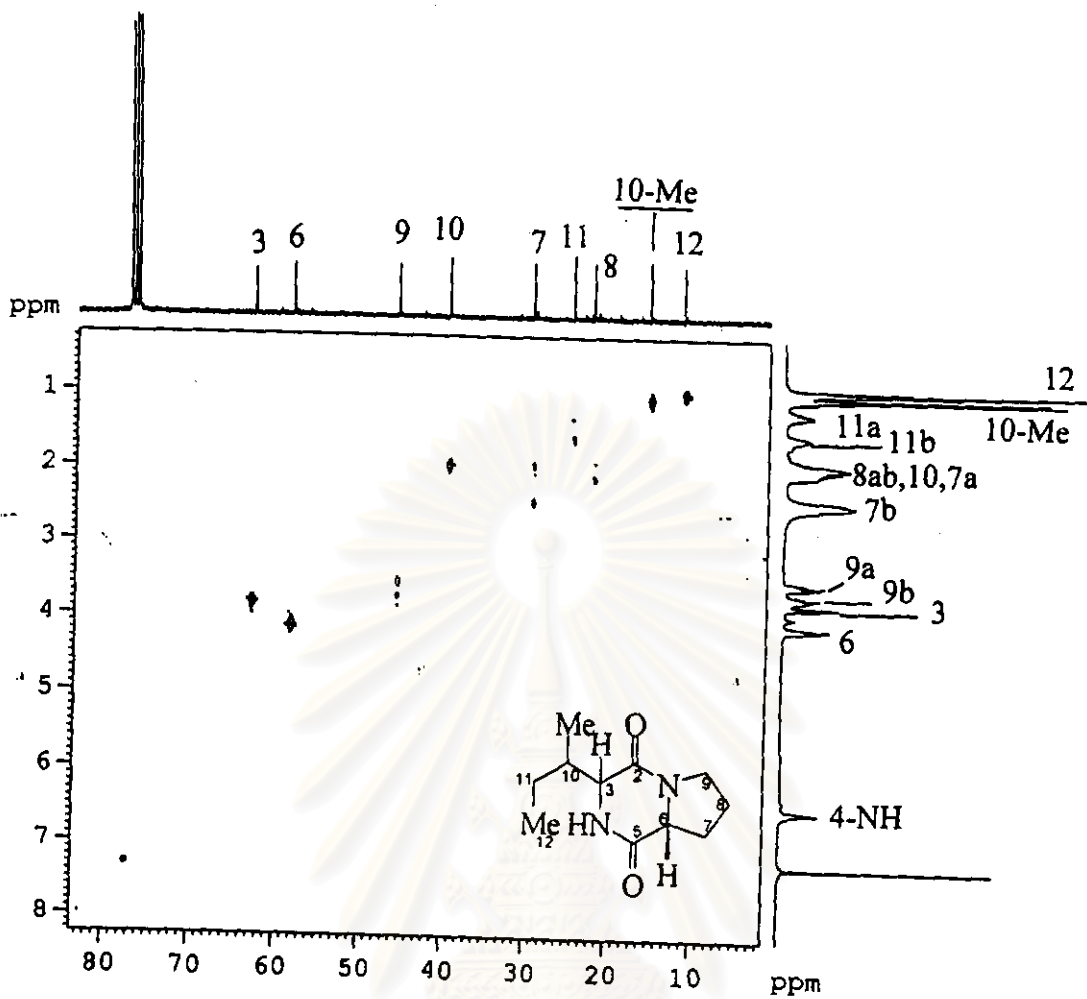


Figure 65. The 75 MHz HETCOR spectrum of *cyclo*-(D-prolyl-isoleucyl) (F017) (in  $\text{CDCl}_3$ )

สถาบันวิทยบริการ  
จุฬาลงกรณ์มหาวิทยาลัย

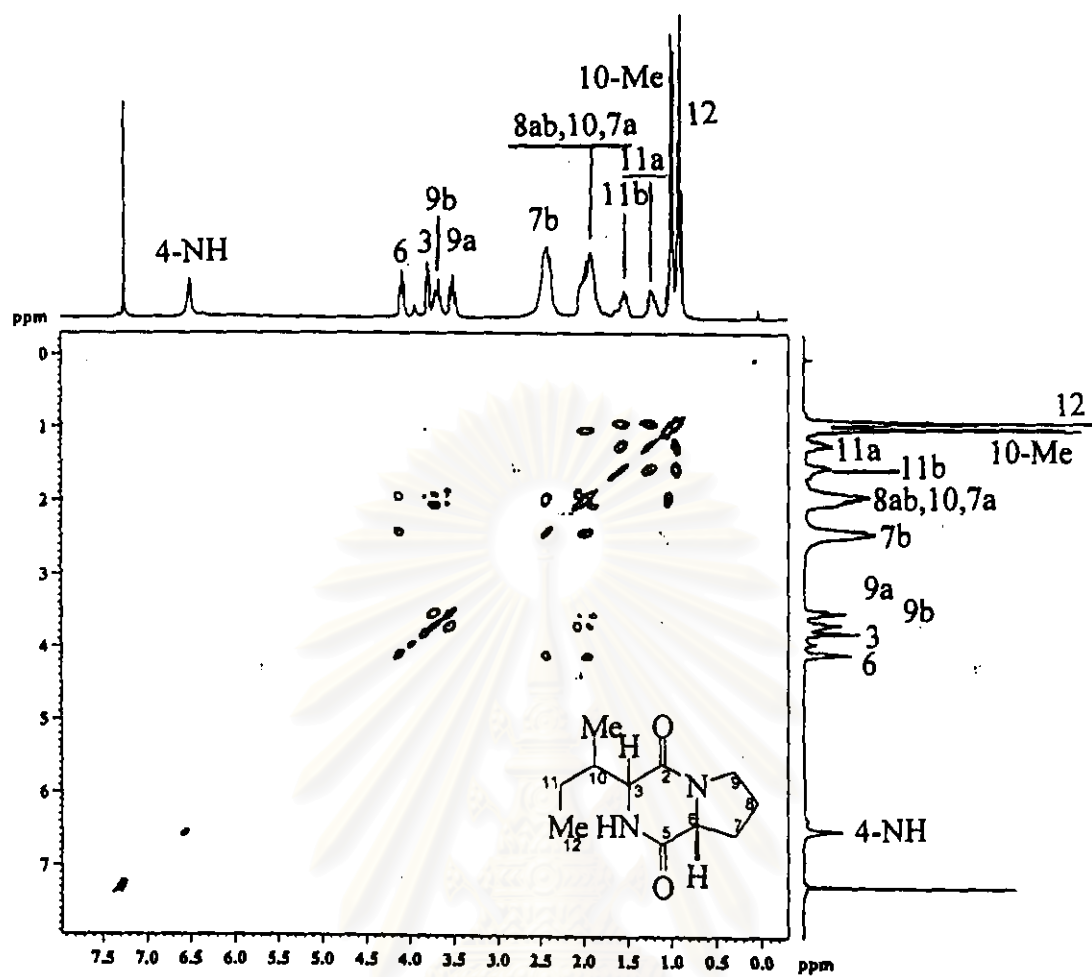


Figure 66. The 300 MHz  $^1\text{H}$ - $^1\text{H}$  COSY spectrum of cyclo-(D-prolyl-isoleucyl) (F017) (in  $\text{CDCl}_3$ )

สถาบันวิทยบริการ  
จุฬาลงกรณ์มหาวิทยาลัย

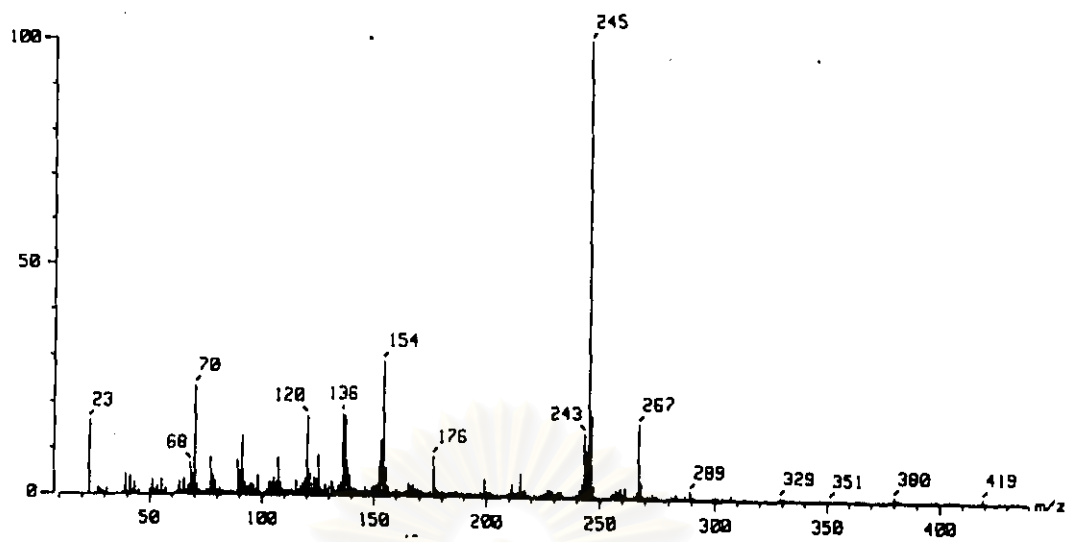


Figure 67. HRFAB mass spectrum of *cyclo*-(D-prolyl-L-phenylalanyl) (P348)

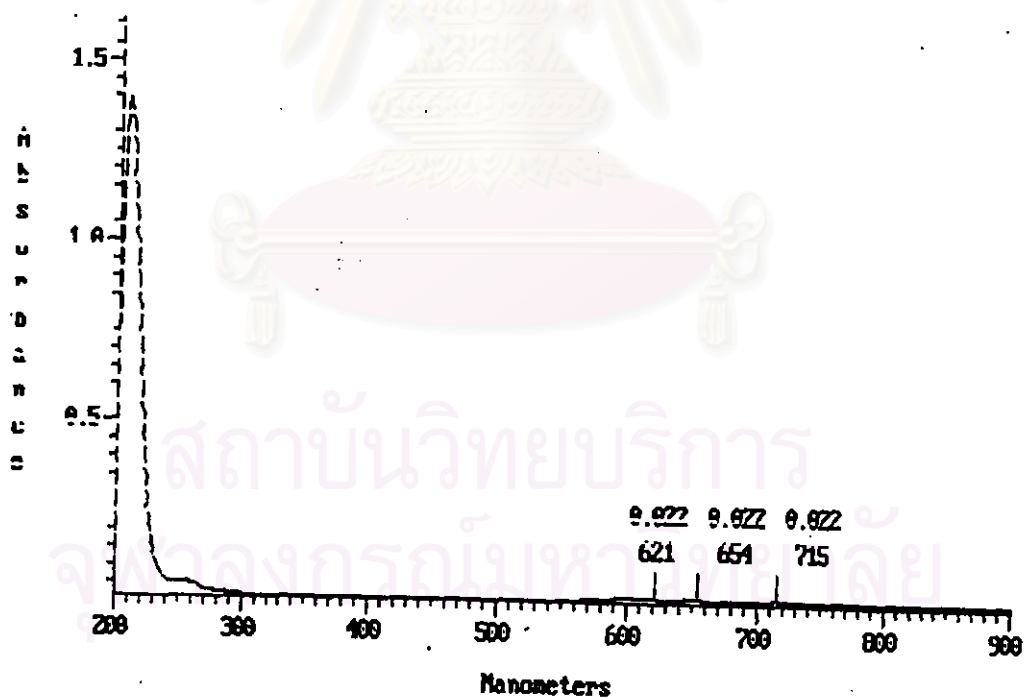


Figure 68. UV spectrum of *cyclo*-(D-prolyl-L-phenylalanyl) (P348) (in MeOH)

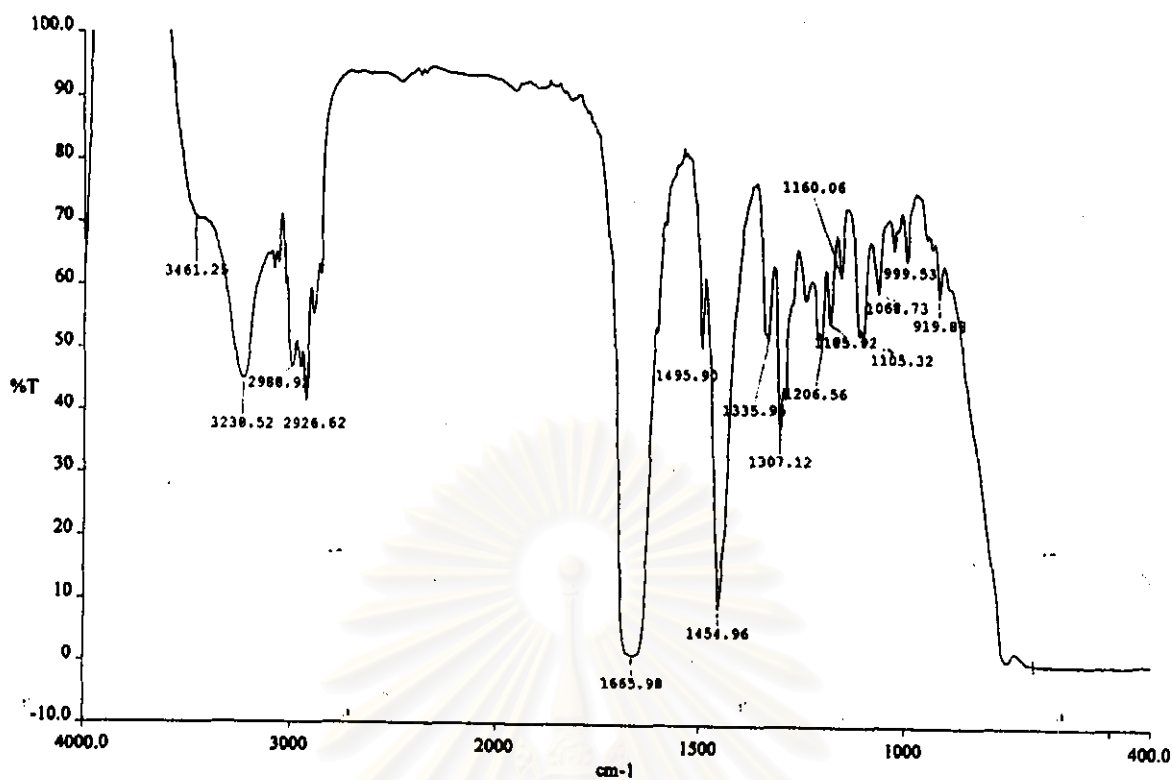


Figure 69. IR spectrum of *cyclo*-(D-prolyl-L-phenylalanyl) (P348) (film)

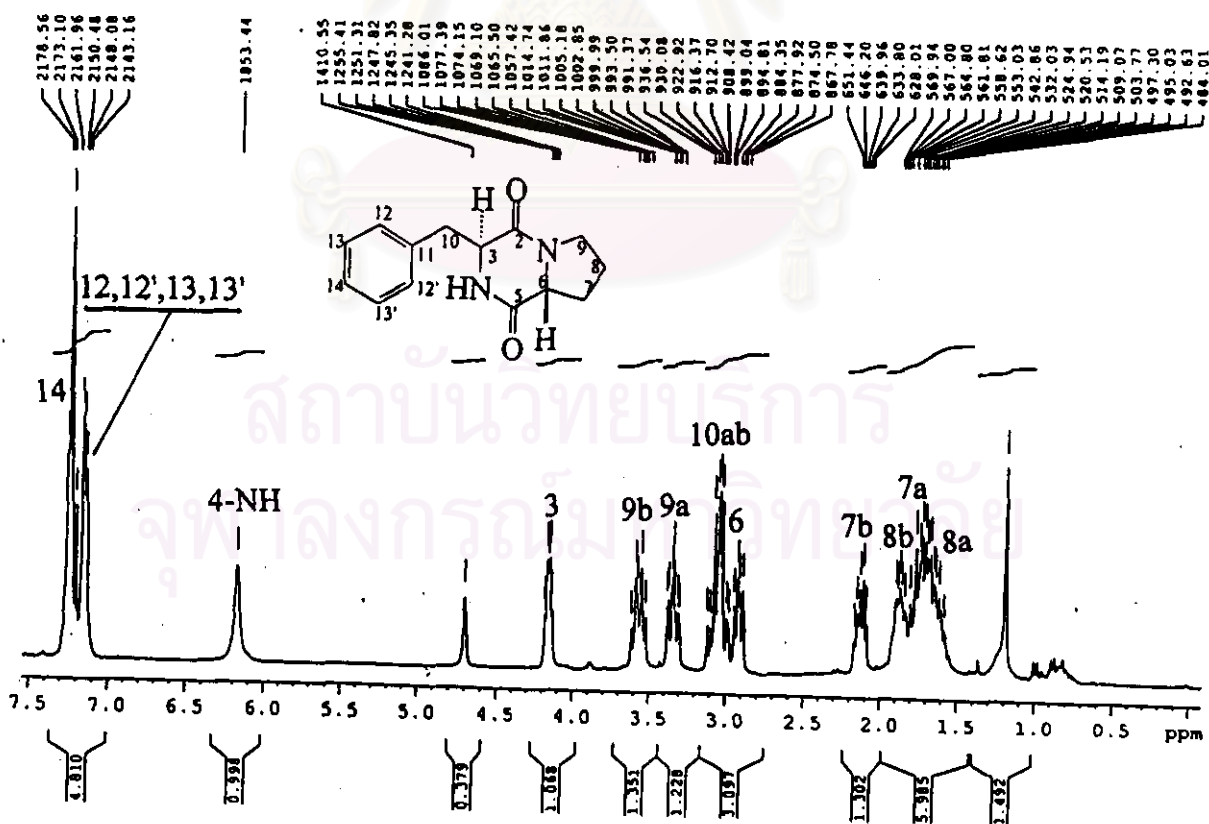
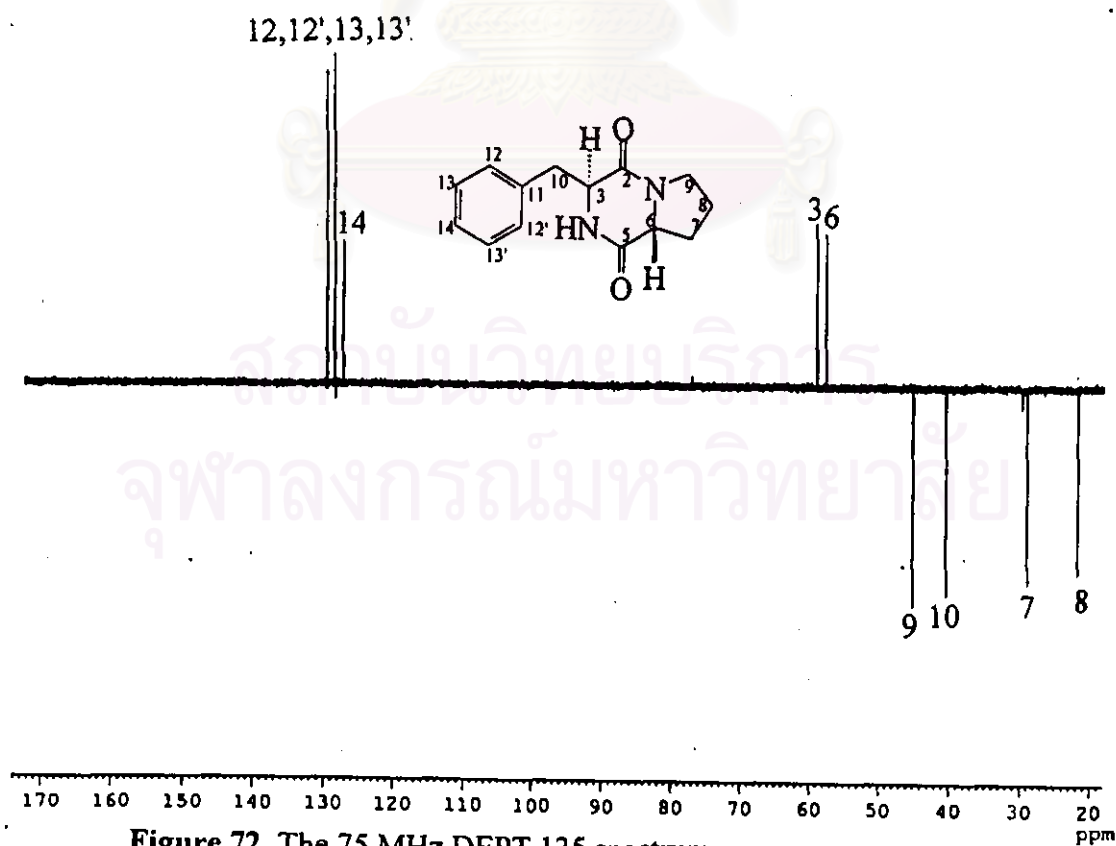
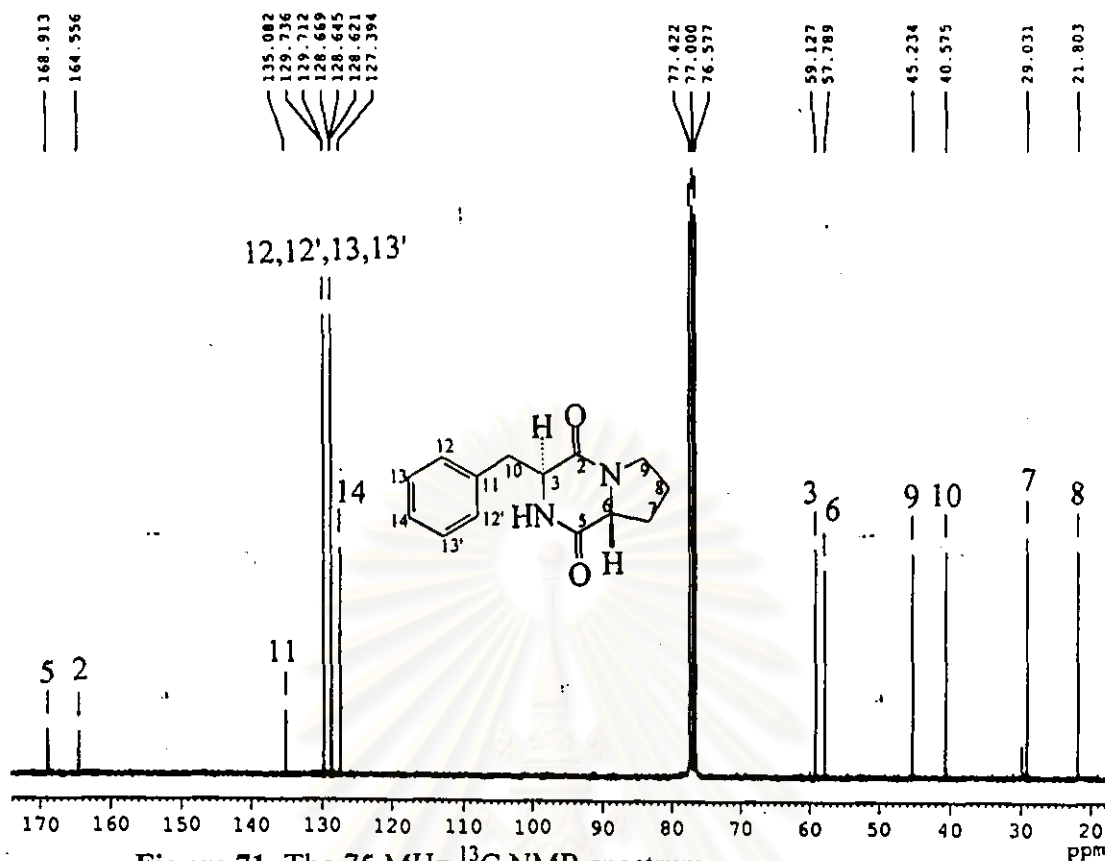


Figure 70. The 300 MHz  $^1\text{H}$  NMR spectrum of *cyclo*-(D-prolyl-L-phenylalanyl) (P348) (in  $\text{CDCl}_3$ )





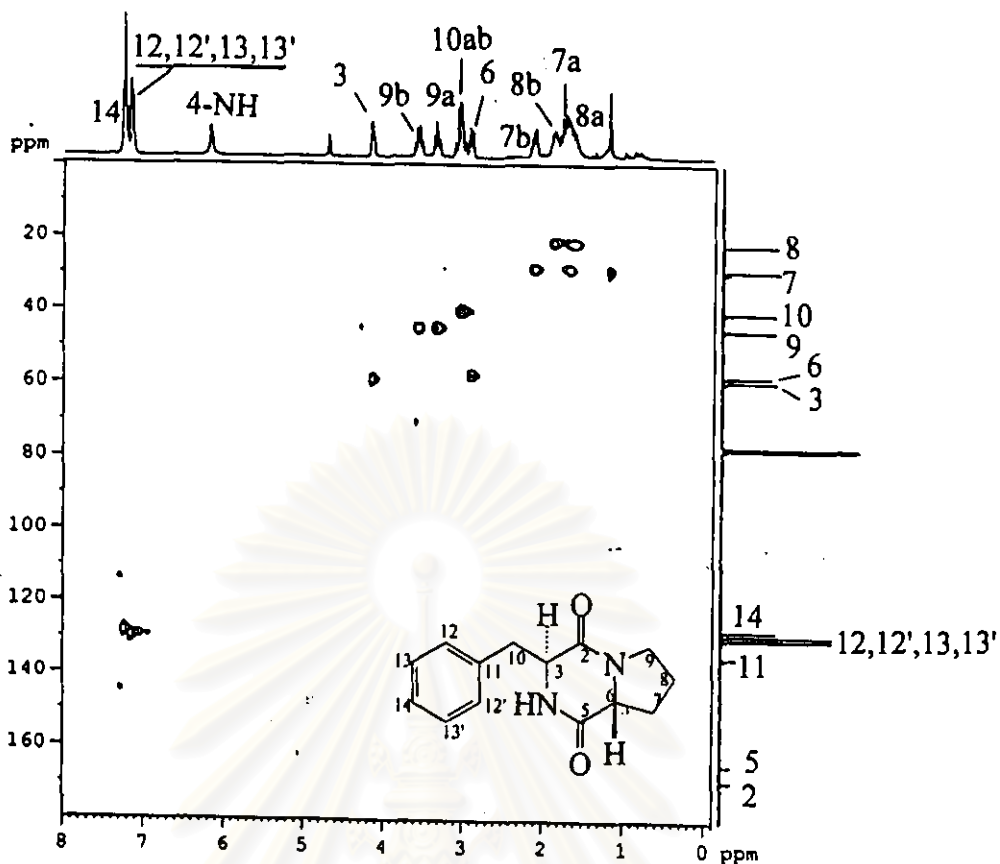


Figure 73. The 300 MHz HMQC spectrum of *cyclo*-(D-prolyl-L-phenylalanyl) (P348) (in  $\text{CDCl}_3$ )

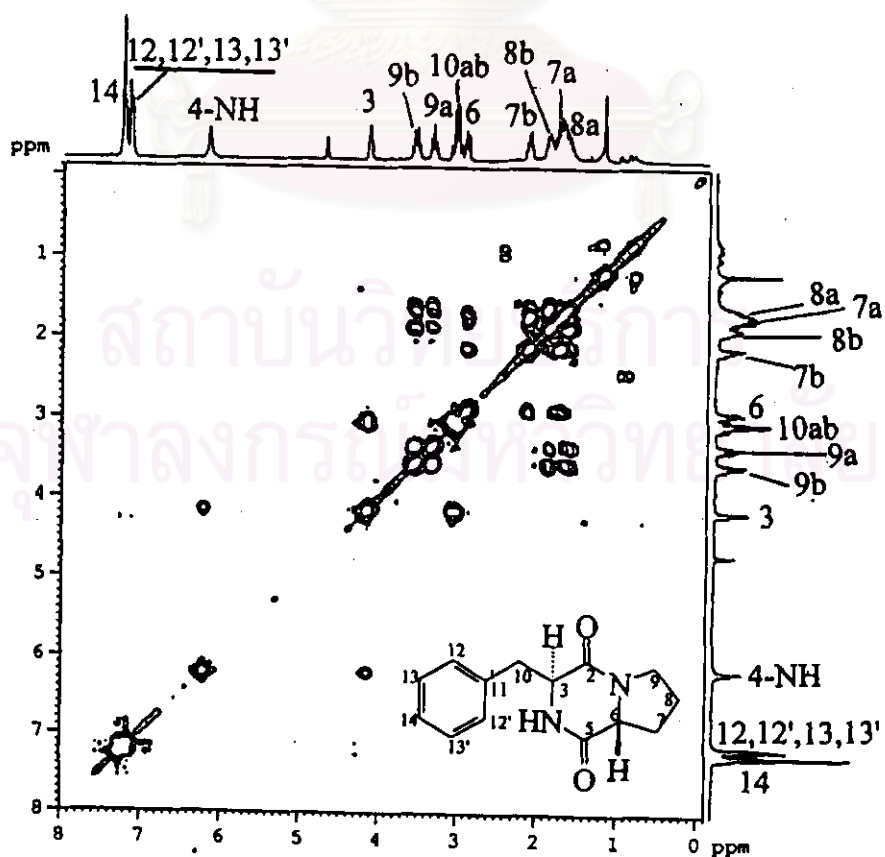
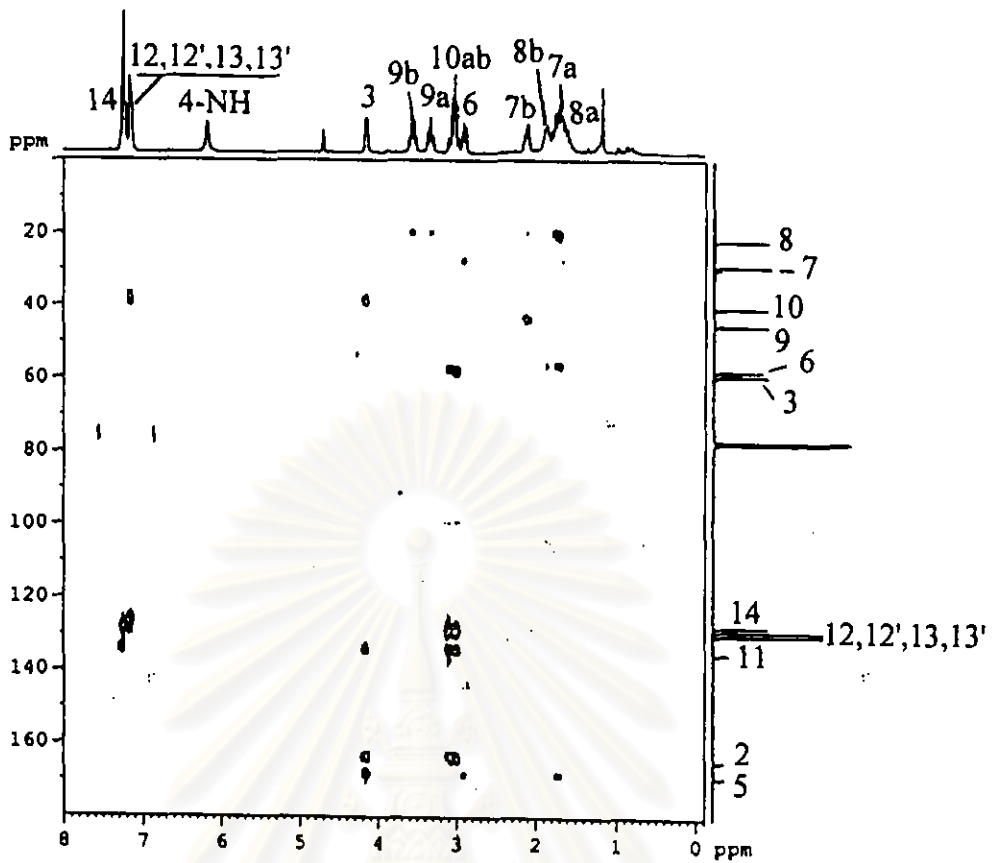
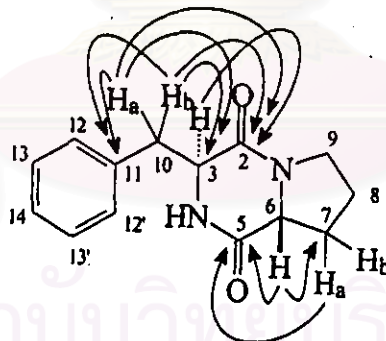


Figure 74. The 300 MHz  $^1\text{H}$ - $^1\text{H}$  COSY spectrum of *cyclo*-(D-prolyl-L-phenylalanyl) (P348) (in  $\text{CDCl}_3$ )



**Figure 75.** The 300 MHz HMBC spectrum of *cyclo*-(D-prolyl-L-phenylalanyl) (P348) (in CDCl<sub>3</sub>)



สถาบันวิทยบริการ  
จุฬาลงกรณ์มหาวิทยาลัย

dkp27 4 (0.082) Cm (2:18)

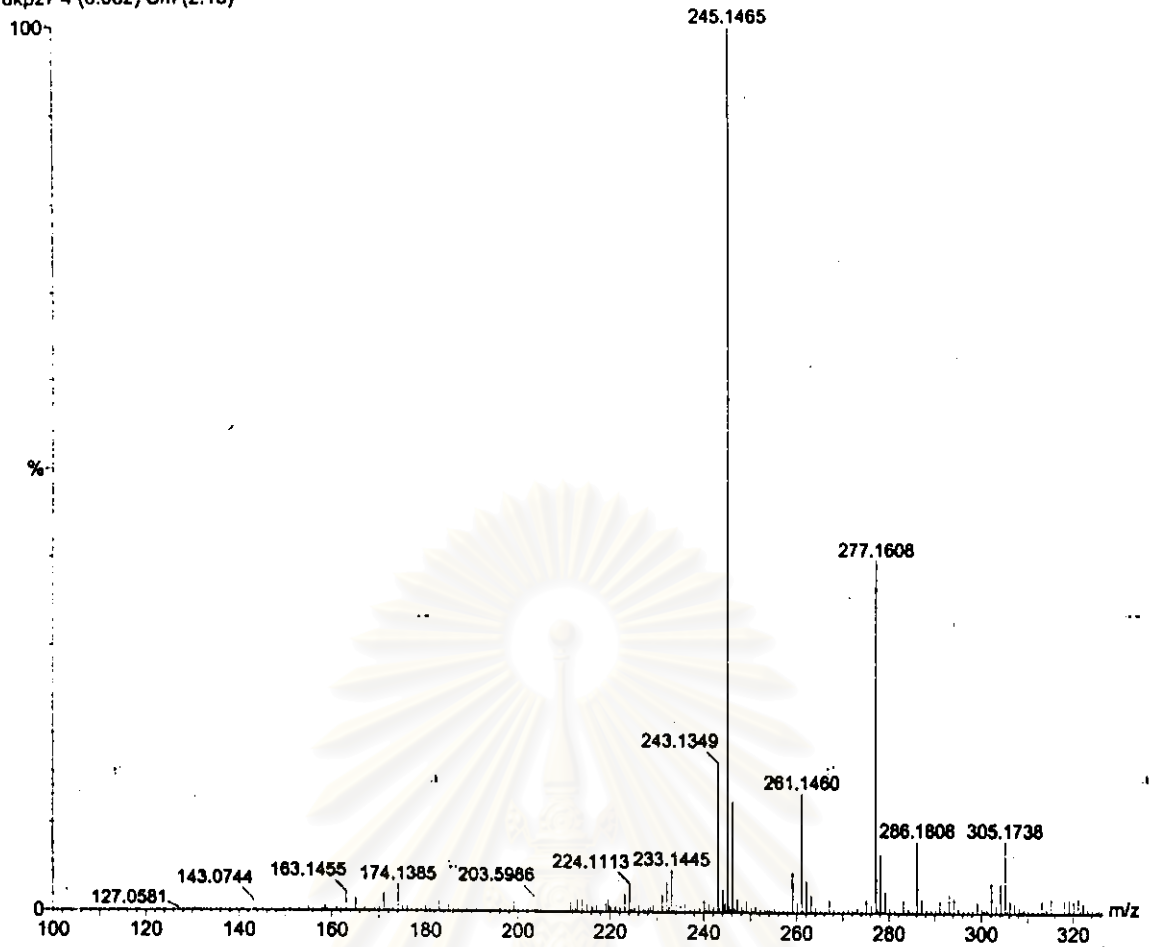


Figure 76. ESITOF mass spectrum of *cyclo*-(L-prolyl-L-phenylalanyl) (dkp27)

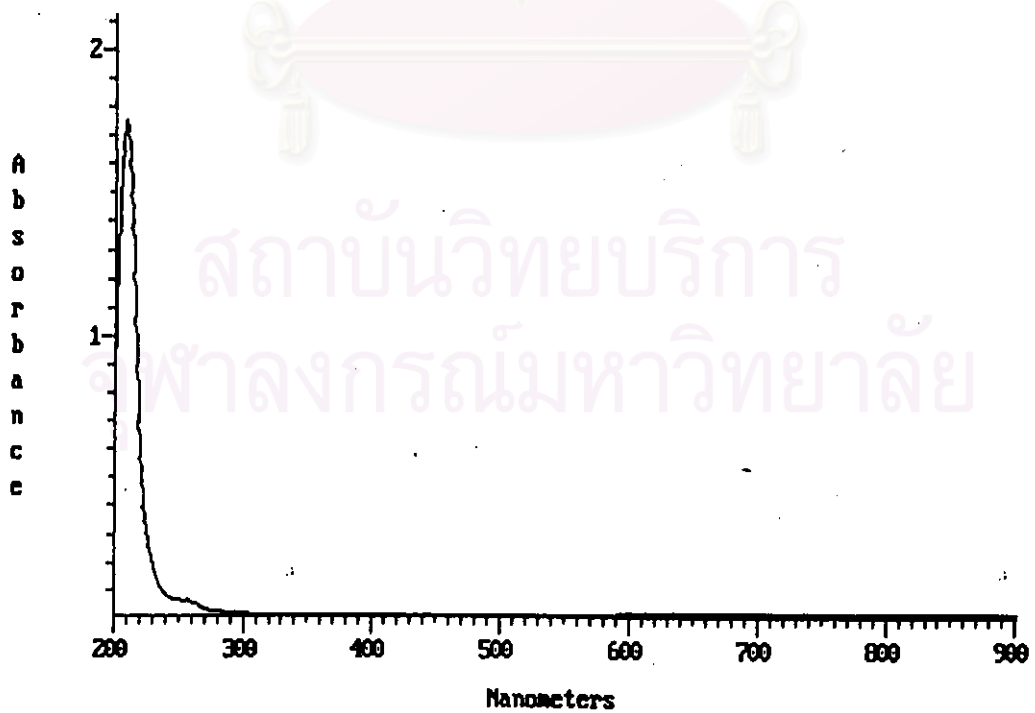


Figure 77. UV spectrum of *cyclo*-(L-prolyl-L-phenylalanyl) (dkp27) (in MeOH)

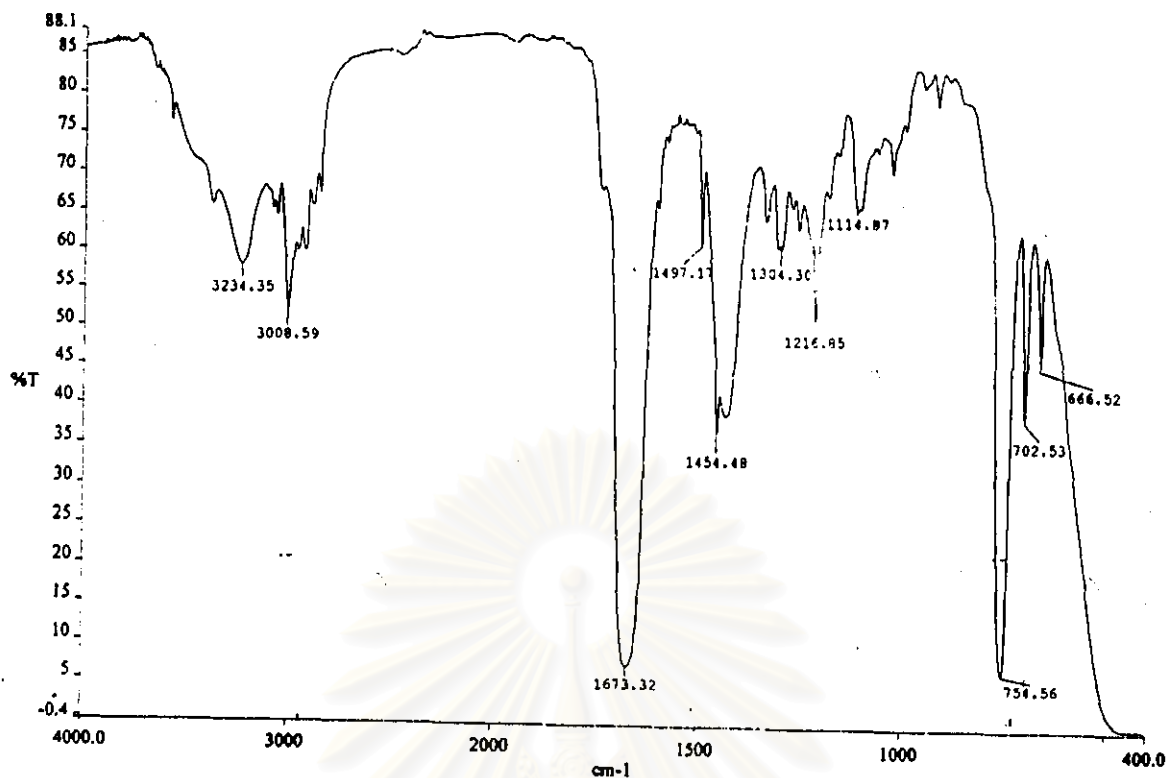


Figure 78. IR spectrum of *cyclo*-(L-prolyl-L-phenylalanyl) (dkp27) (film)

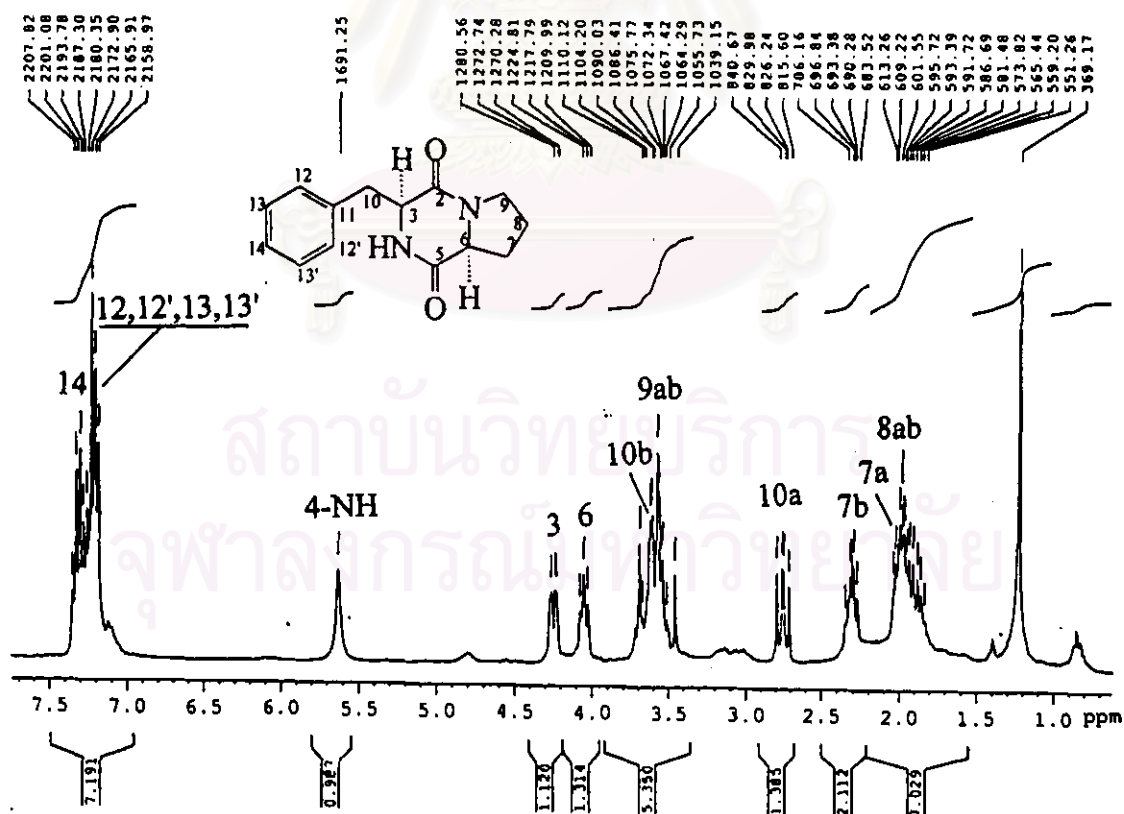


Figure 79. The 300 MHz  $^1\text{H}$  NMR spectrum of *cyclo*-(L-prolyl-L-phenylalanyl) (dkp27) (in  $\text{CDCl}_3$ )

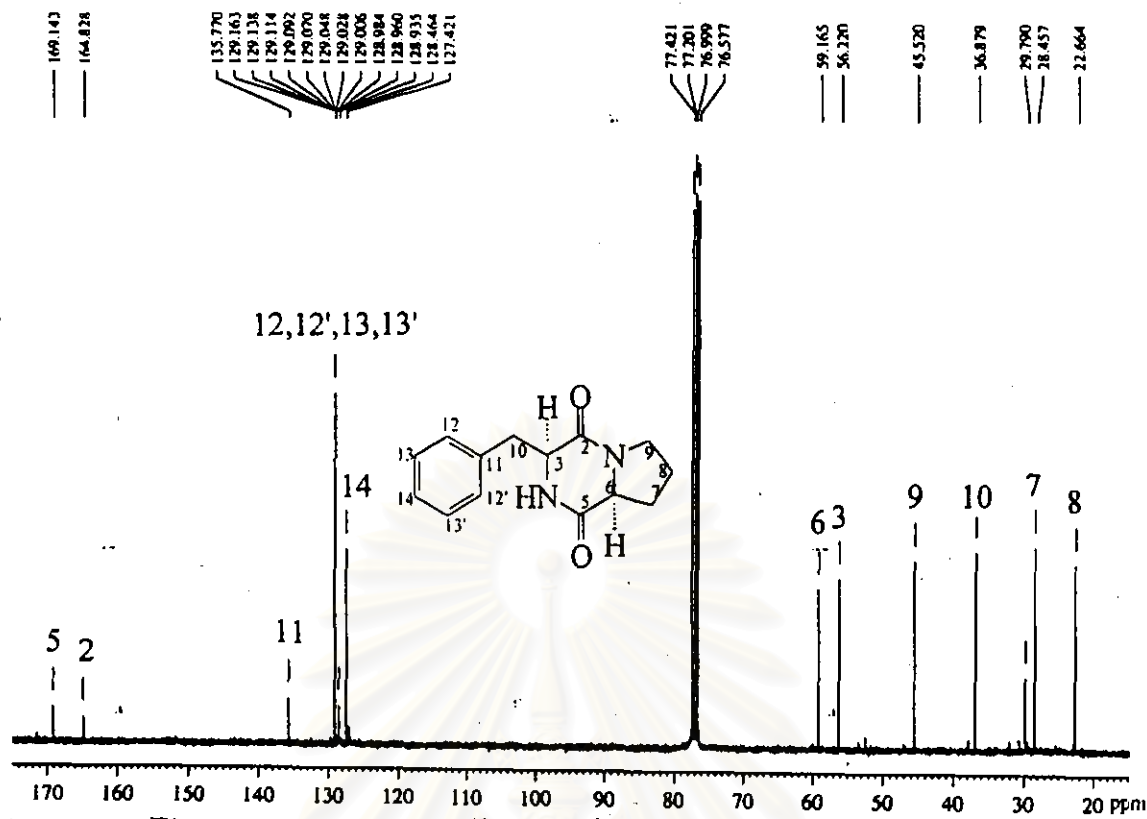


Figure 80. The 75 MHz  $^{13}\text{C}$  NMR spectrum of *cyclo*-(L-prolyl-L-phenylalanyl) (dkp27) (in  $\text{CDCl}_3$ )

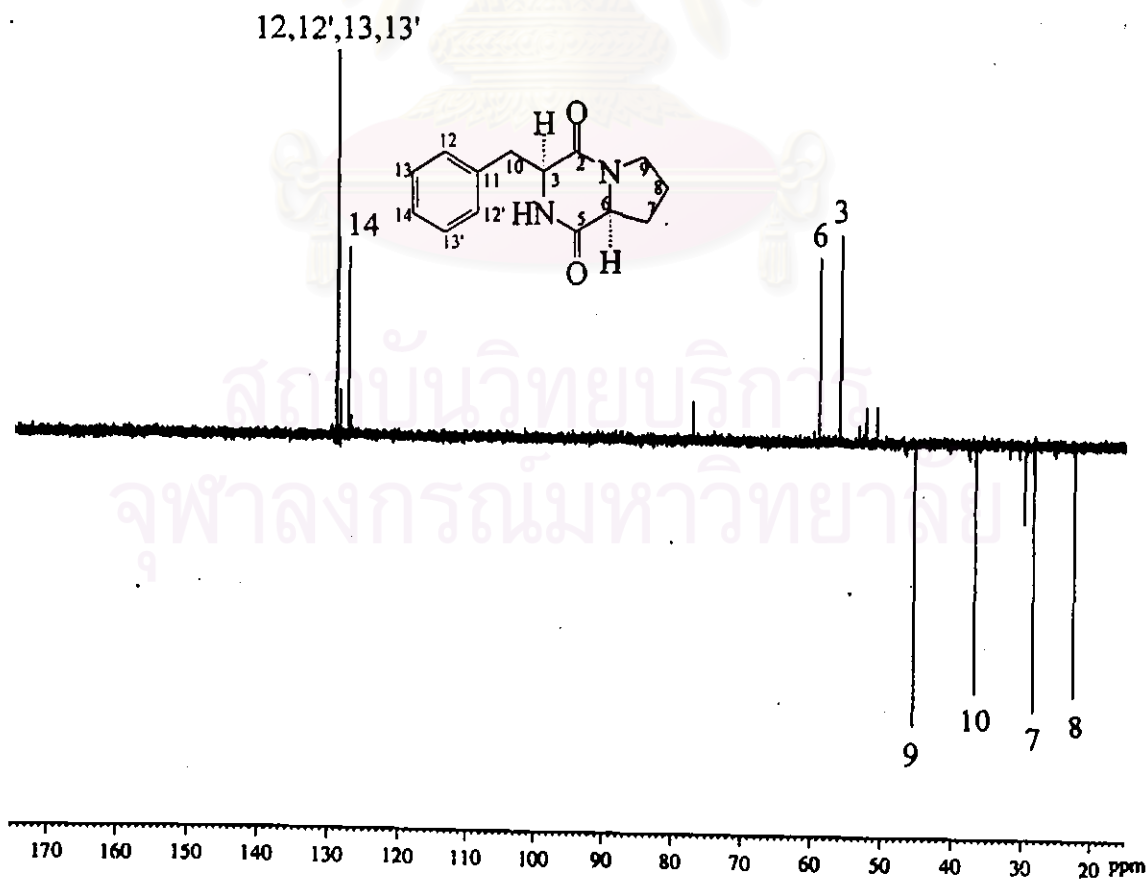


Figure 81. The 75 MHz DEPT 135 spectrum of *cyclo*-(L-prolyl-L-phenylalanyl) (dkp27) (in  $\text{CDCl}_3$ )

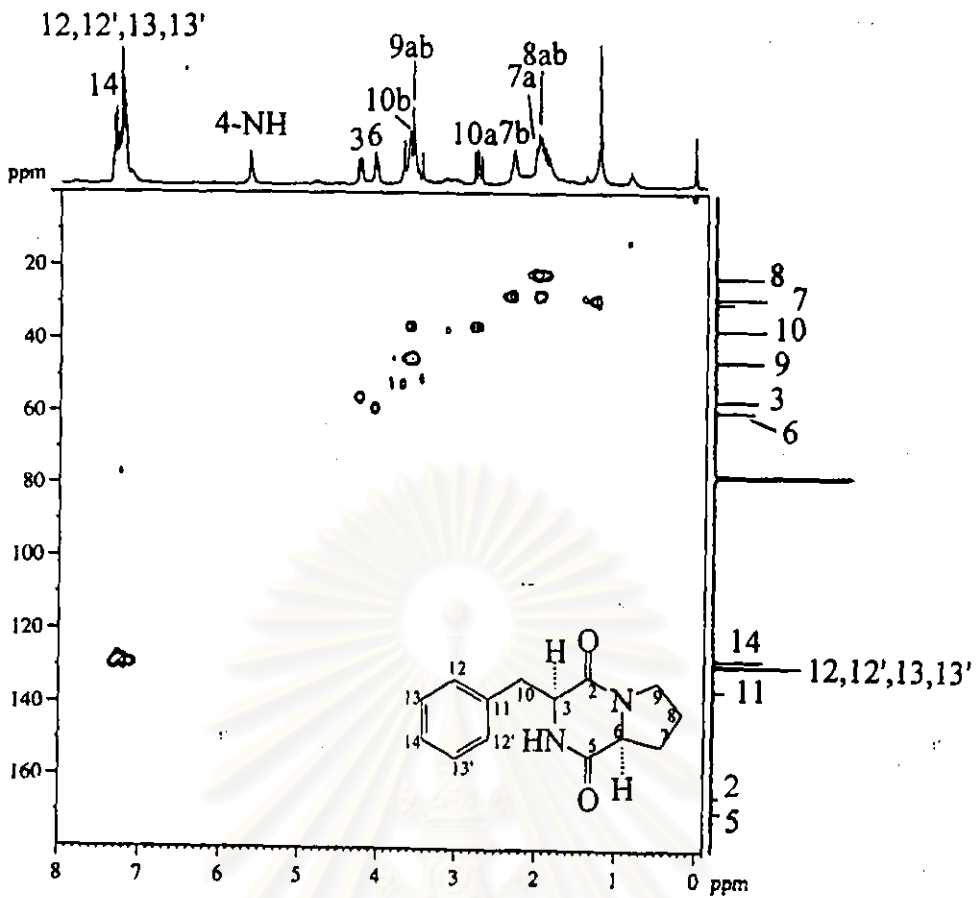


Figure 82. The 300 MHz HMQC spectrum of *cyclo*-(L-prolyl-L-phenylalanyl) (dkp27) (in CDCl<sub>3</sub>)

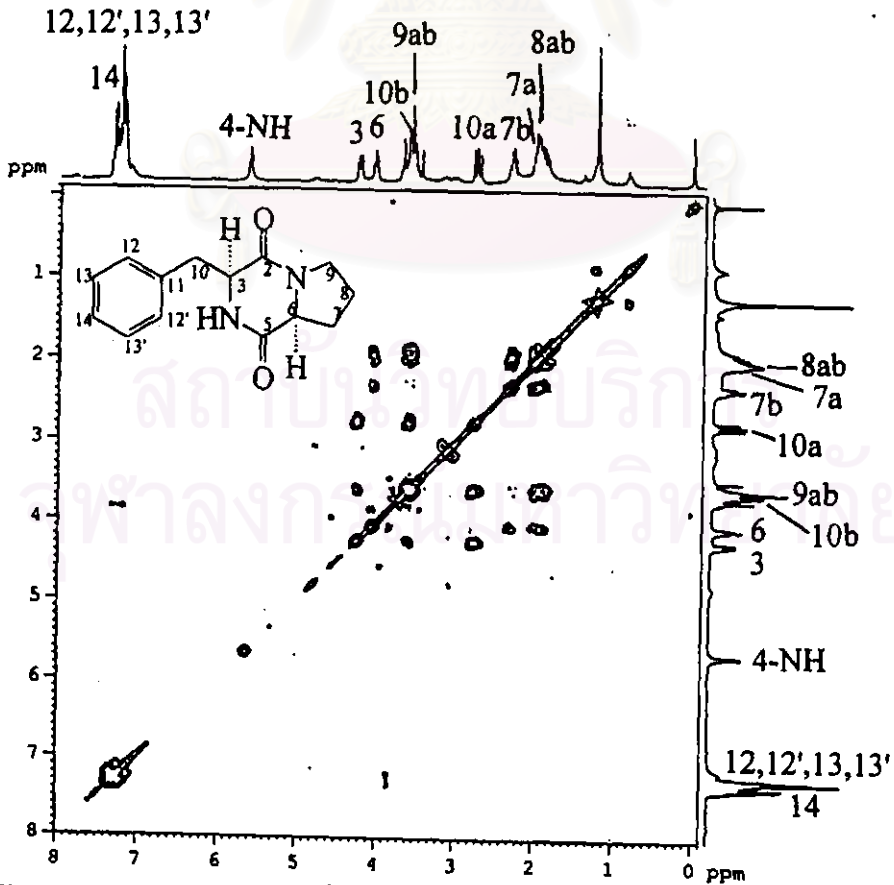
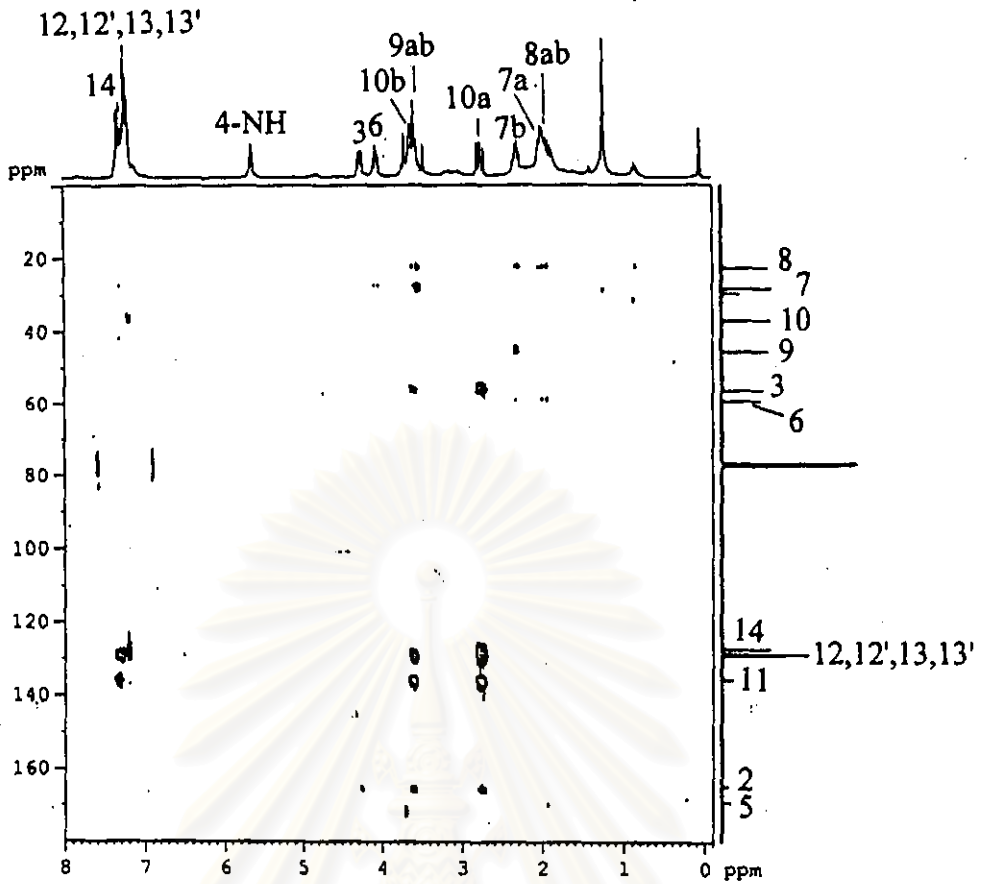
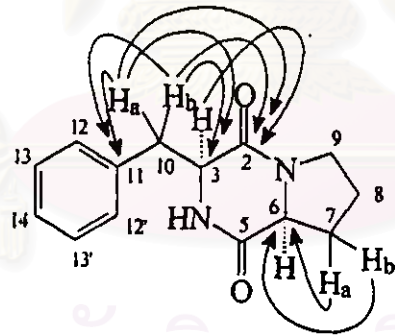


Figure 83. The 300 MHz <sup>1</sup>H-<sup>1</sup>H COSY spectrum of *cyclo*-(L-prolyl-L-phenylalanyl) (dkp27) (in CDCl<sub>3</sub>)





**Figure 84.** The 300 MHz HMBC spectrum of *cyclo*-(L-prolyl-L-phenylalanyl) (dkp27) (in  $\text{CDCl}_3$ )



สถาบันวิทยบริการ  
จุฬาลงกรณ์มหาวิทยาลัย

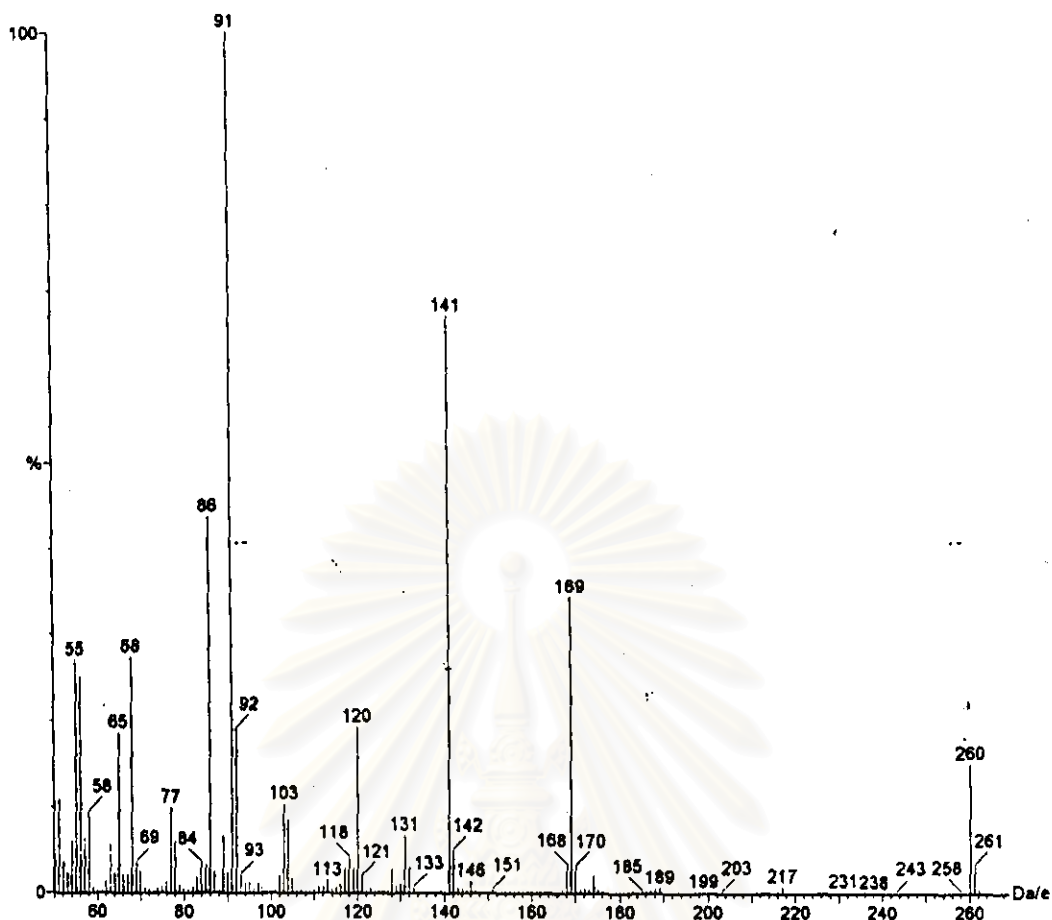


Figure 85. EI mass spectrum of *cyclo-(trans-4-hydroxy-L-prolyl-L-phenylalanyl)* (F018)

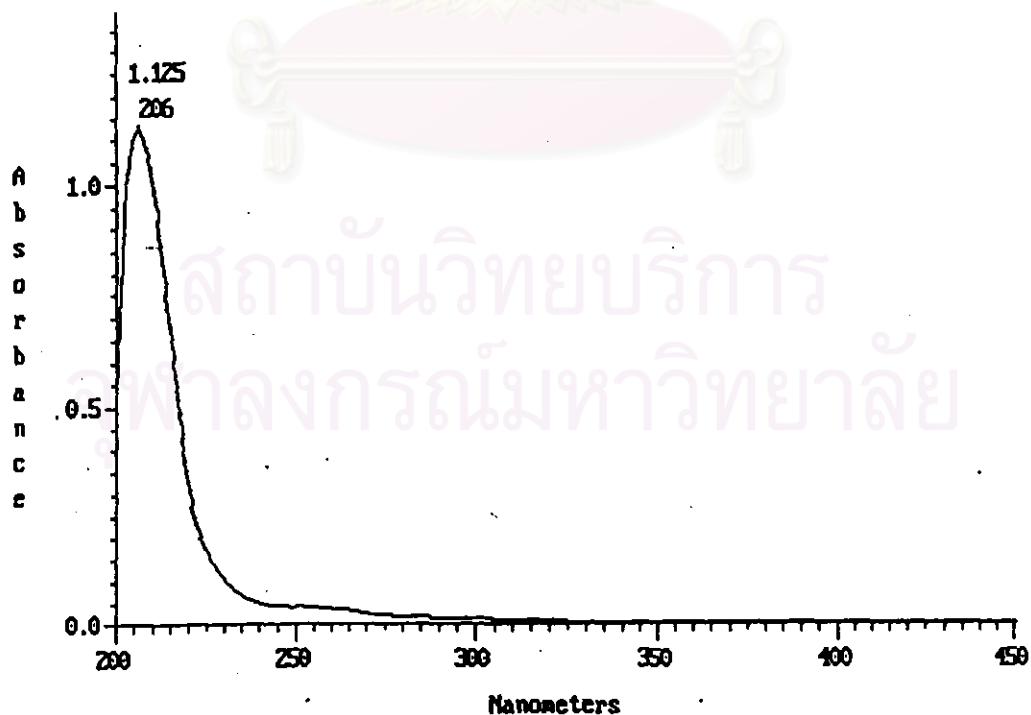


Figure 86. UV spectrum of *cyclo-(trans-4-hydroxy-L-prolyl-L-phenylalanyl)* (F018) (in MeOH)

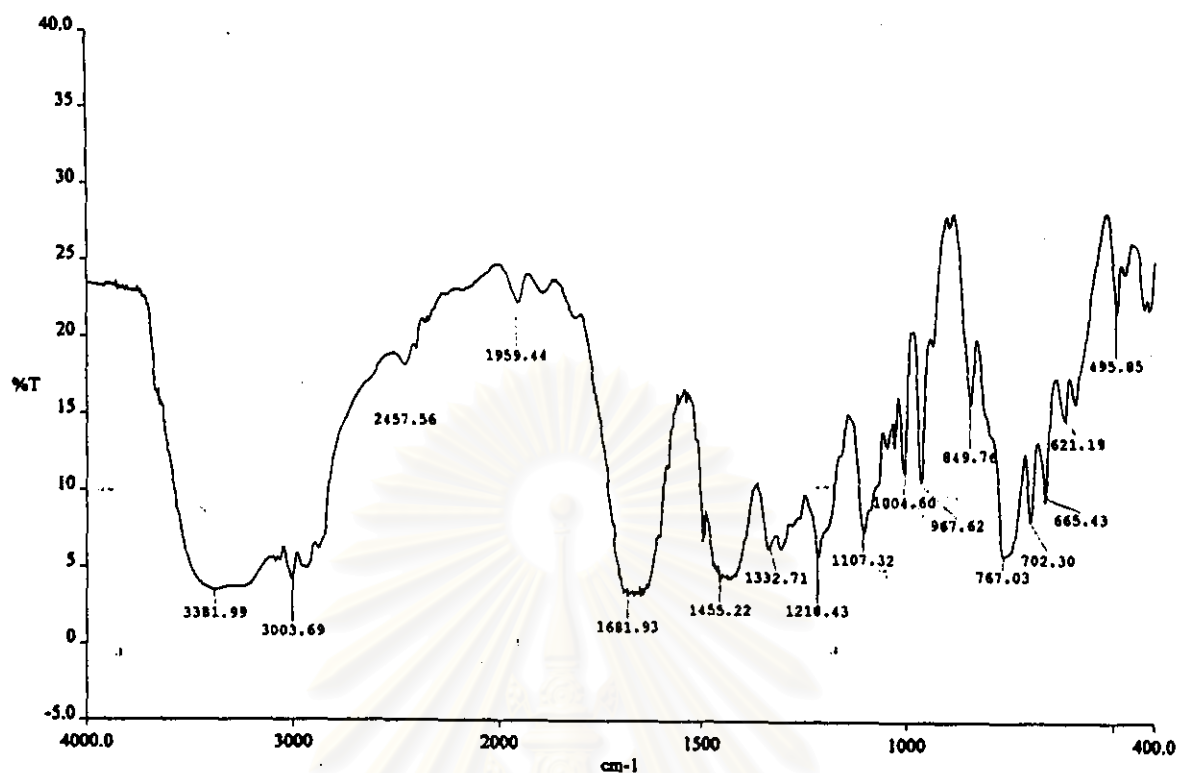


Figure 87. IR spectrum of *cyclo-(trans-4-hydroxy-L-prolyl-L-phenylalanyl)* (F018) (film)

สถาบันวิทยบริการ  
จุฬาลงกรณ์มหาวิทยาลัย

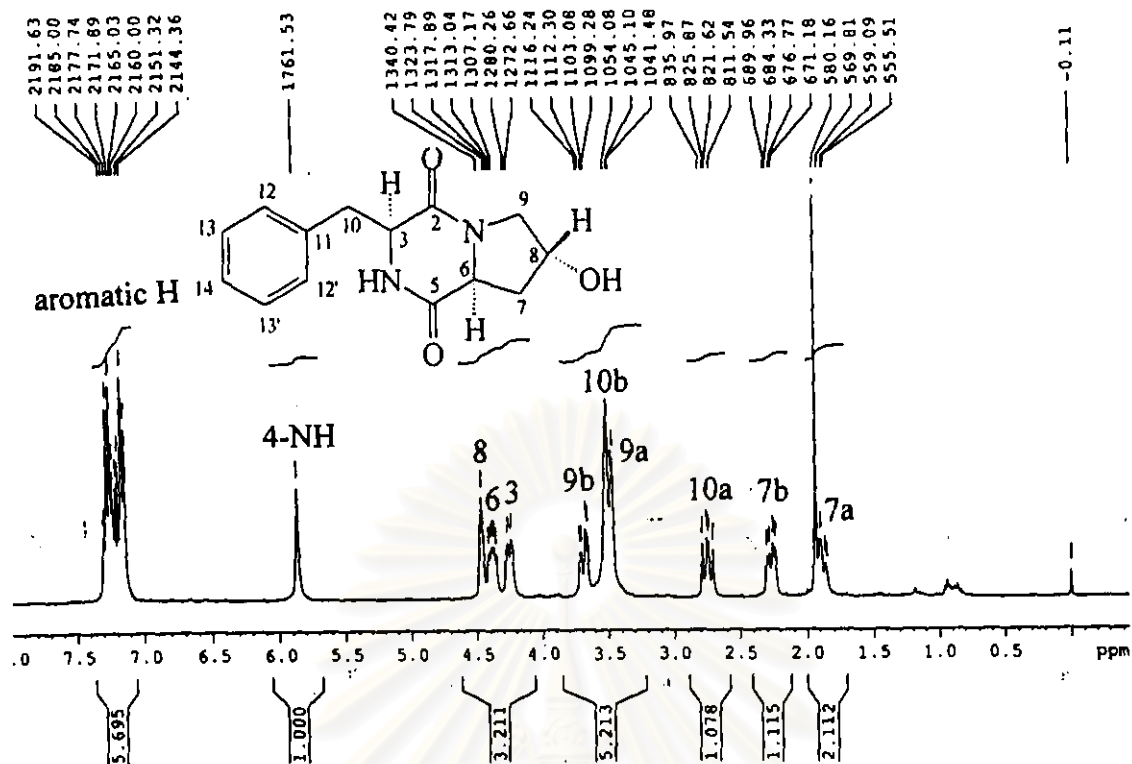


Figure 88. The 300 MHz  $^1\text{H}$  NMR spectrum of *cyclo-(trans-4-hydroxy-L-prolyl-L-phenylalanyl)* (F018) (in  $\text{CDCl}_3$ )

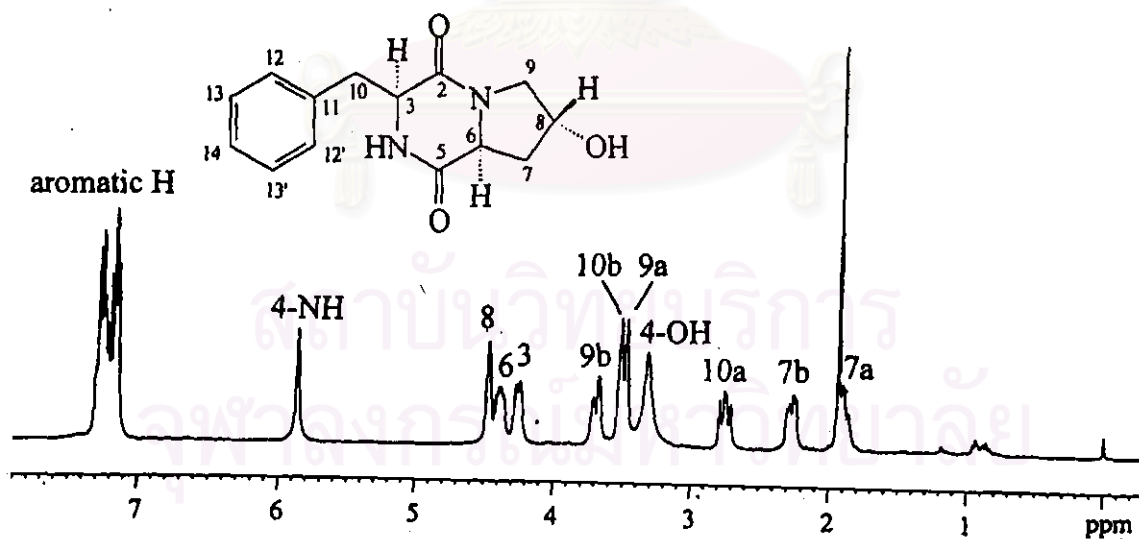


Figure 89. The 300 MHz  $^1\text{H}$  NMR spectrum of *cyclo-(trans-4-hydroxy-L-prolyl-L-phenylalanyl)* (F018) (in  $\text{CDCl}_3$ ) (showed 4-OH signal at 3.34 ppm)

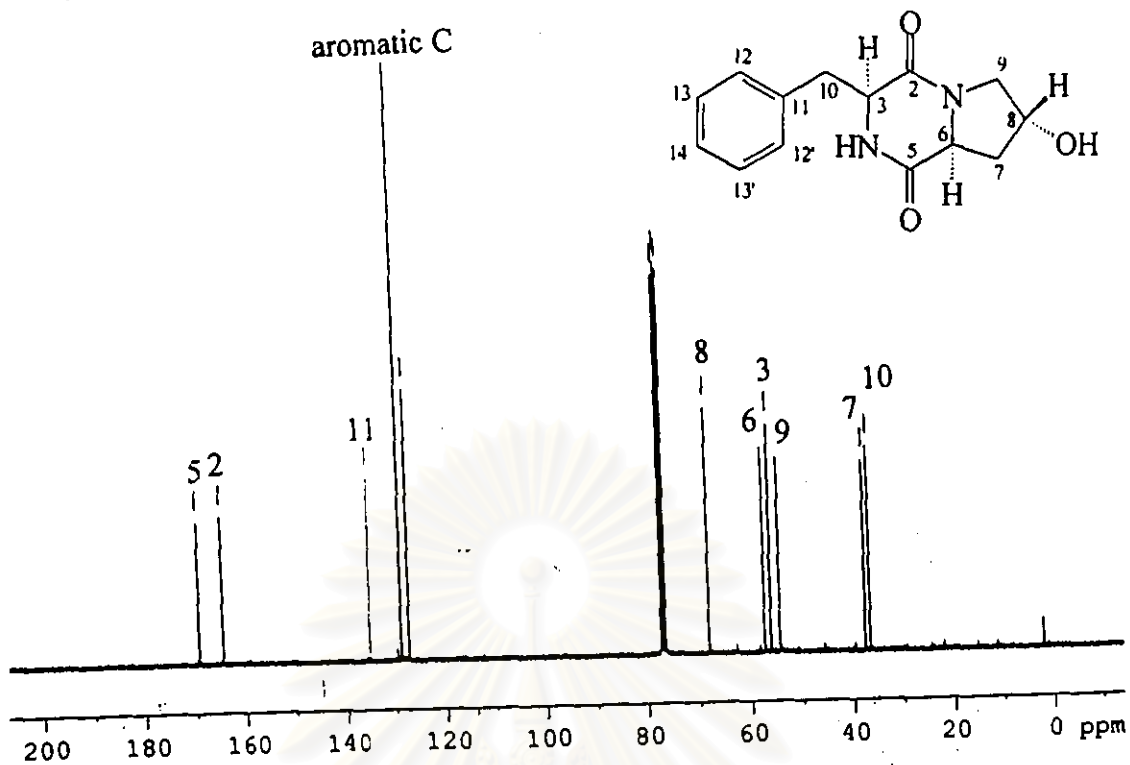


Figure 90. The 75 MHz  $^{13}\text{C}$  NMR spectrum of *cyclo*-(*trans*-4-hydroxy-L-prolyl-L-phenylalanyl) (F018) (in  $\text{CDCl}_3$ )

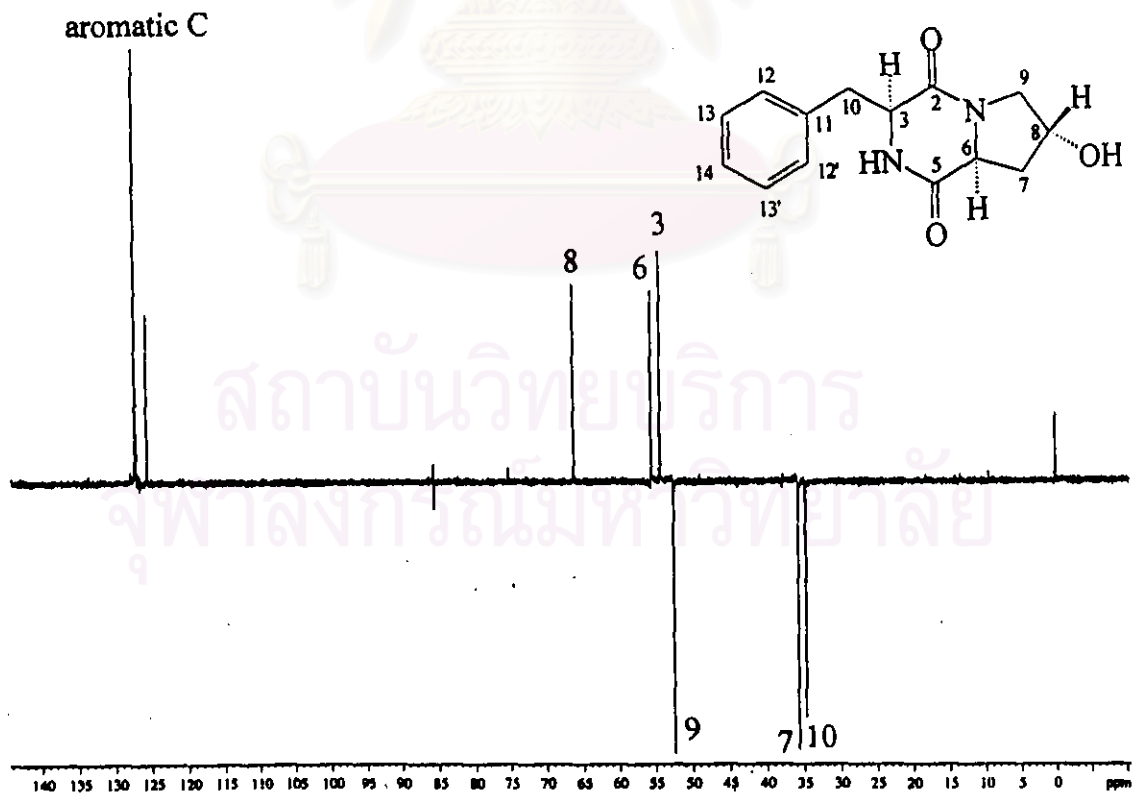
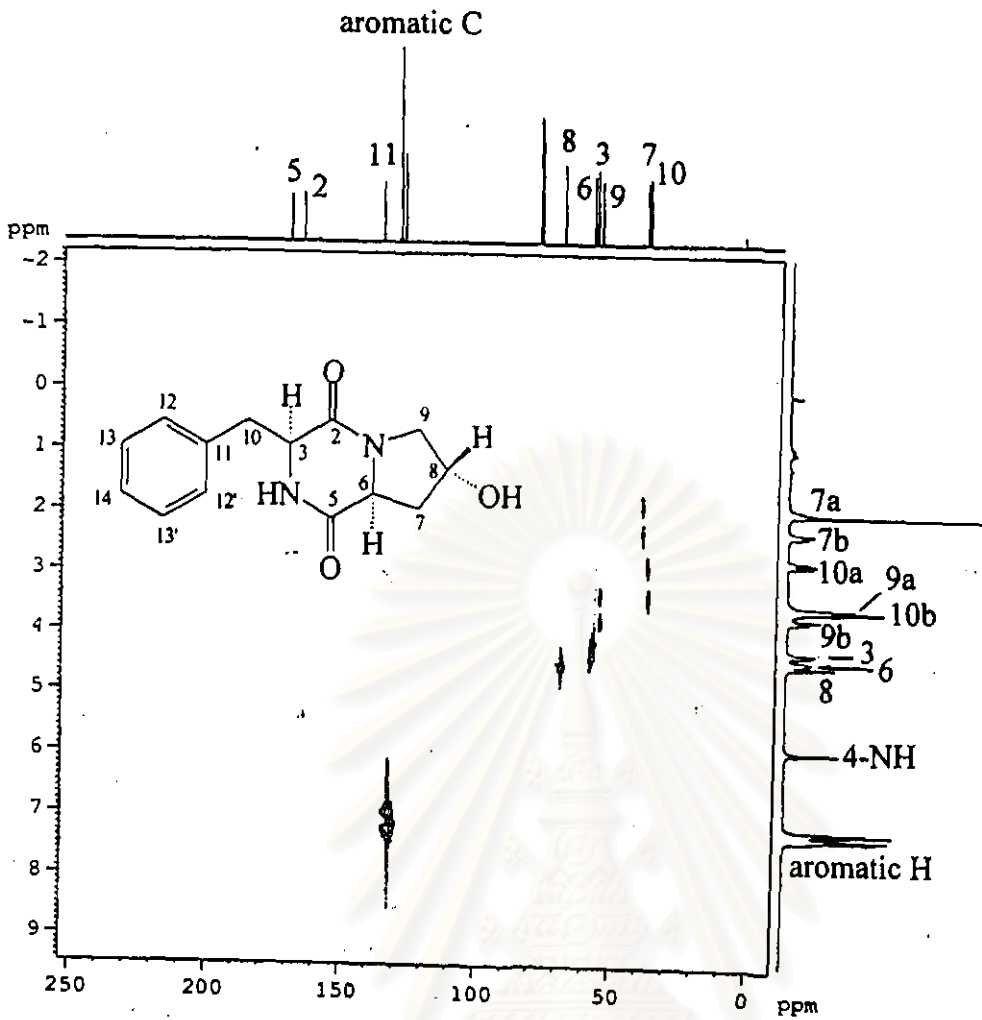


Figure 91. The 75 MHz DEPT 135 spectrum of *cyclo*-(*trans*-4-hydroxy-L-prolyl-L-phenylalanyl) (F018) (in  $\text{CDCl}_3$ )



สถาบันวิทยบริการ  
จุฬาลงกรณ์มหาวิทยาลัย



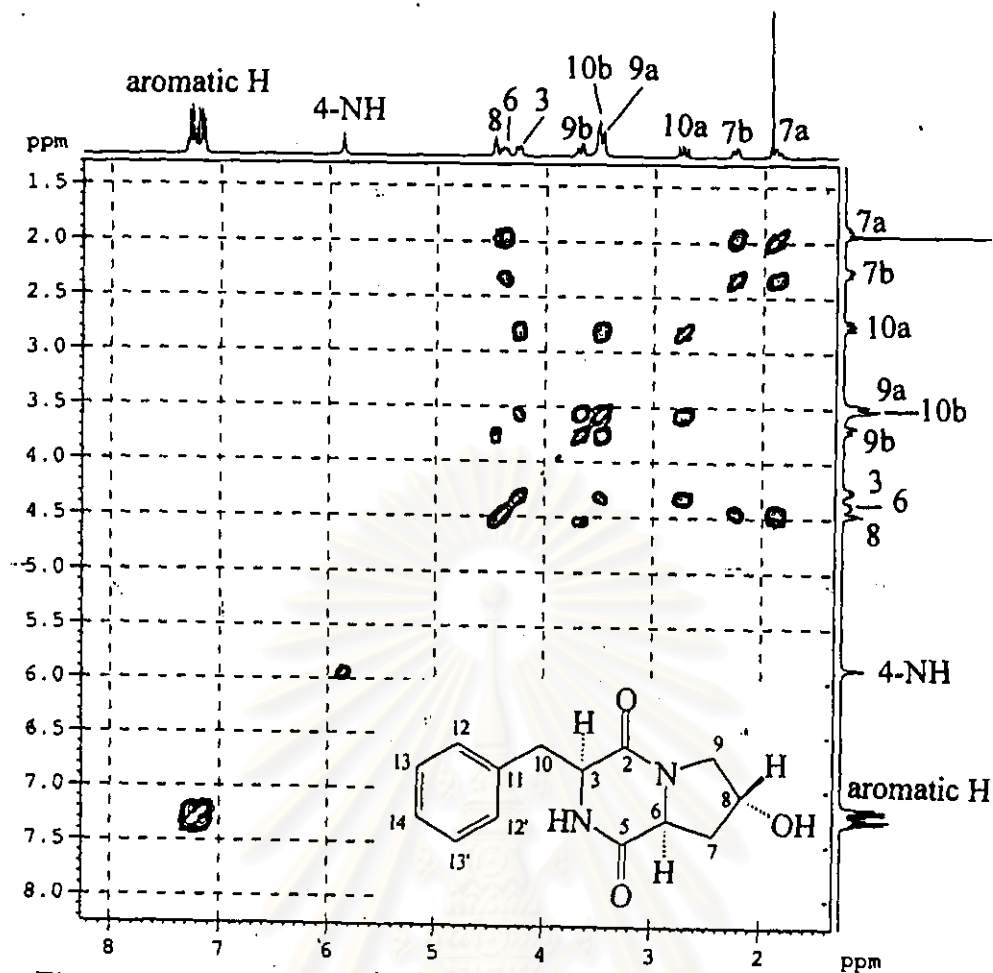


Figure 93. The 300 MHz  $^1\text{H}$ - $^1\text{H}$  COSY spectrum of *cyclo*-(*trans*-4-hydroxy-L-prolyl-L-phenylalanyl) (F018) (in  $\text{CDCl}_3$ )

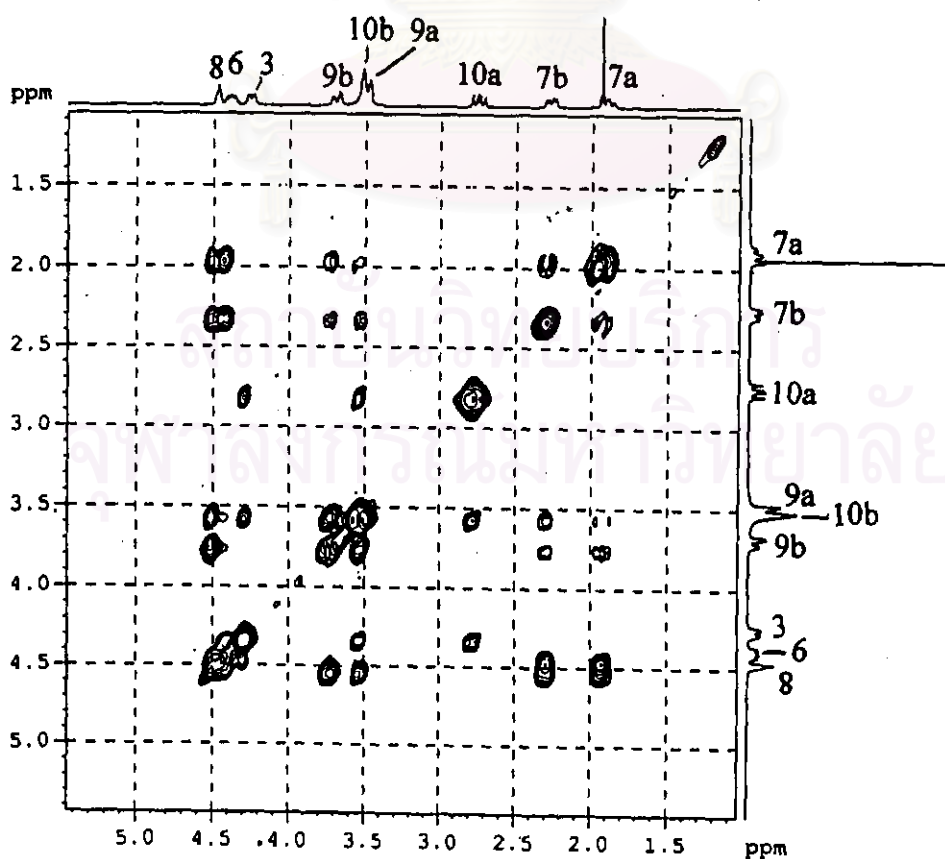


Figure 94. The 300 MHz TOCSY spectrum of *cyclo*-(*trans*-4-hydroxy-L-prolyl-L-phenylalanyl) (F018) (in  $\text{CDCl}_3$ ) (expanded from 1.0-5.5 ppm)

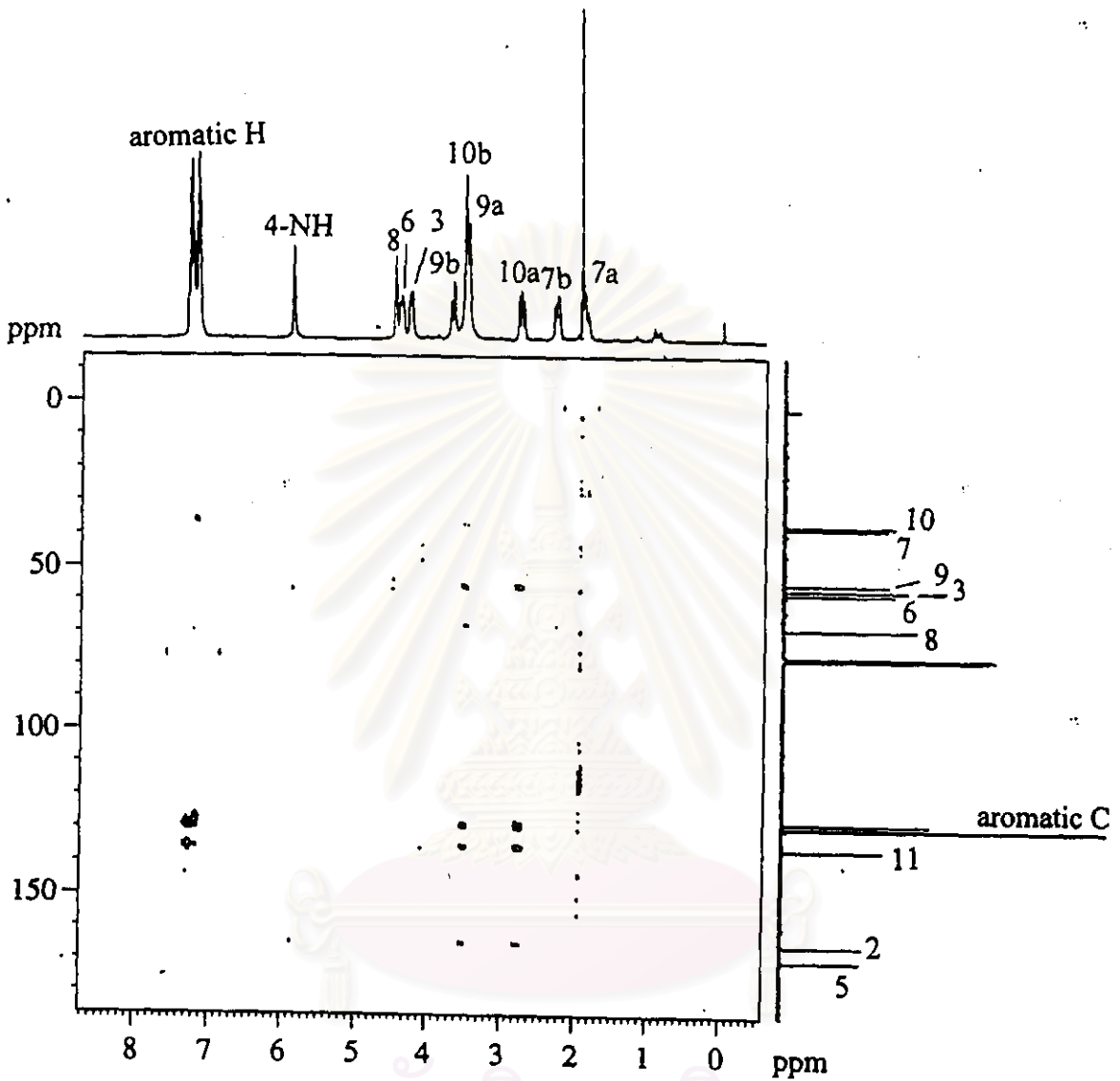
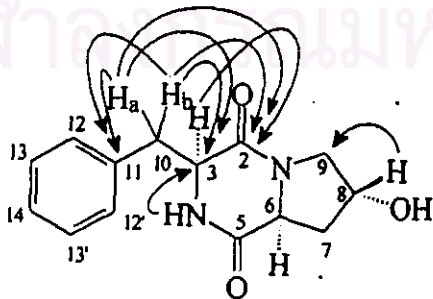


Figure 95. The 300 MHz HMBC spectrum of *cyclo-(trans-4-hydroxy-L-prolyl-L-phenylalanyl)* (F018) (in  $\text{CDCl}_3$ )



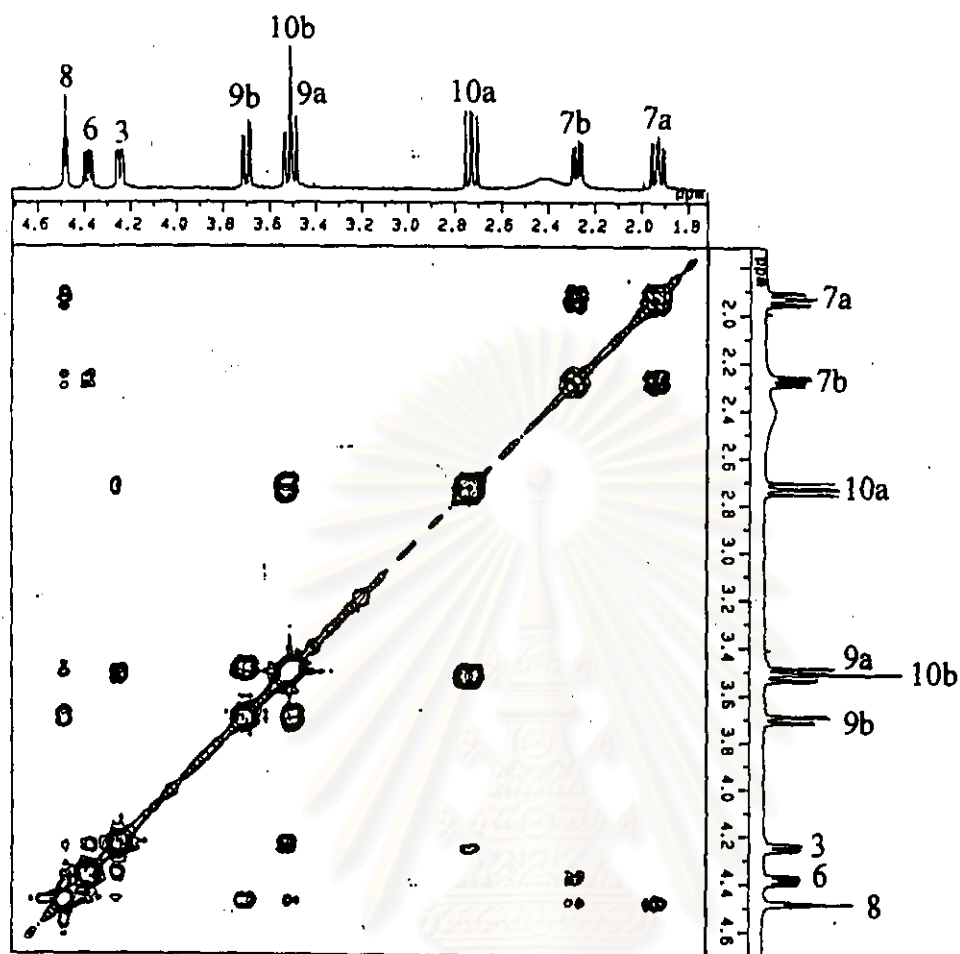
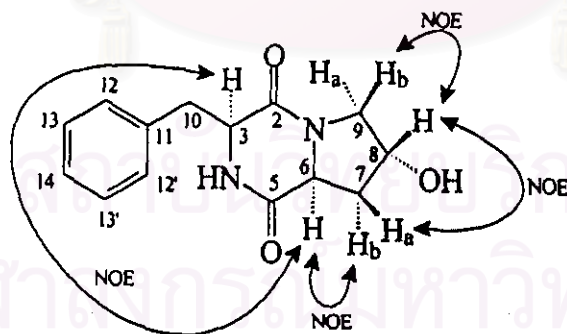


Figure 96. The 500 MHz NOESY spectrum of *cyclo-(trans-4-hydroxy-L-prolyl-L-phenylalanyl)* (F018) (in  $\text{CDCl}_3$ )



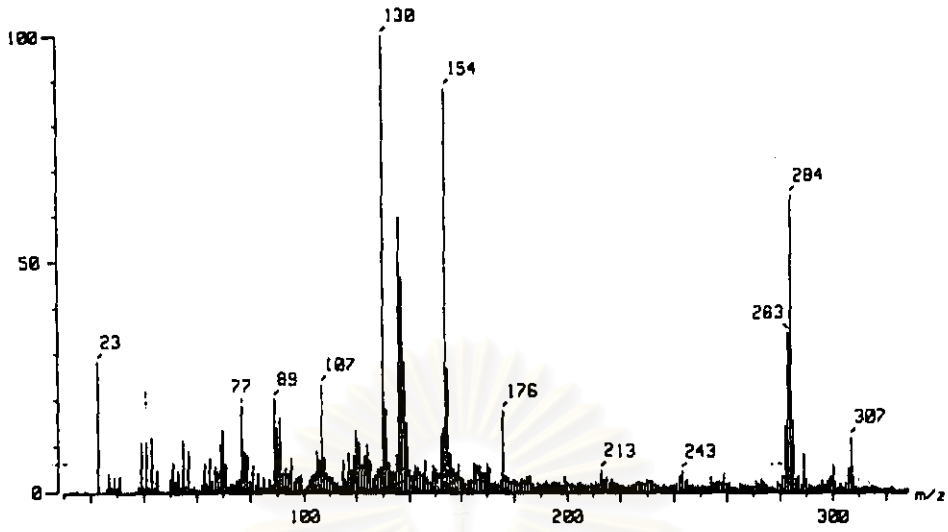


Figure 97. HRFAB mass spectrum of *cyclo*-(L-prolyl-L-tryptophanyl) (P350)

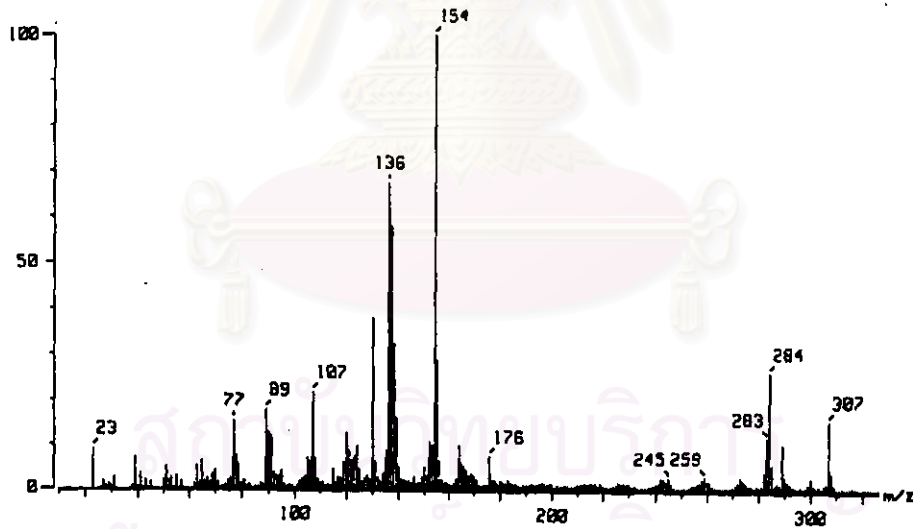


Figure 98. HRFAB mass spectrum of *cyclo*-(D-prolyl-L-tryptophanyl) (P352)

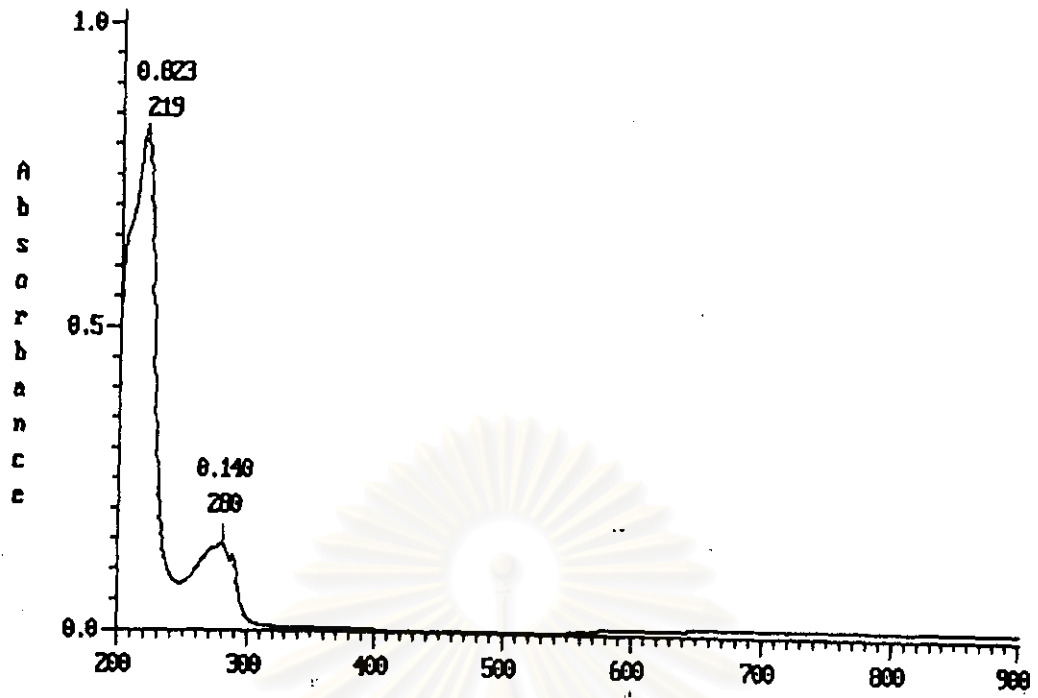


Figure 99. UV spectrum of *cyclo*-(L-prolyl-L-tryptophanyl) (P350) (in MeOH)

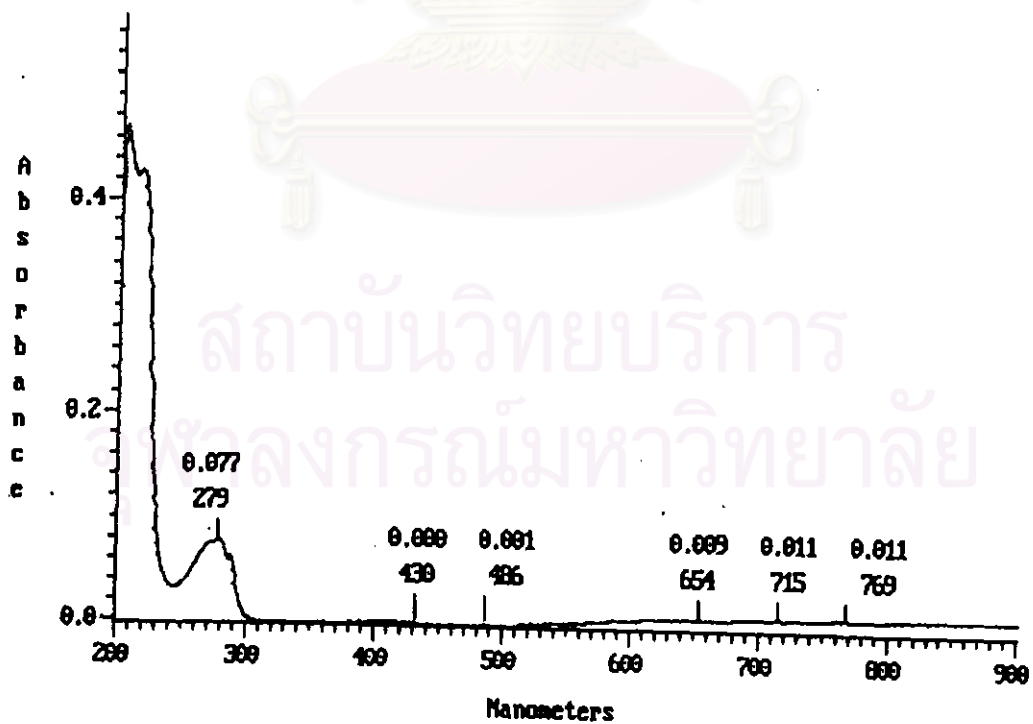


Figure 100. UV spectrum of *cyclo*-(D-prolyl-L-tryptophanyl) (P352) (in MeOH)

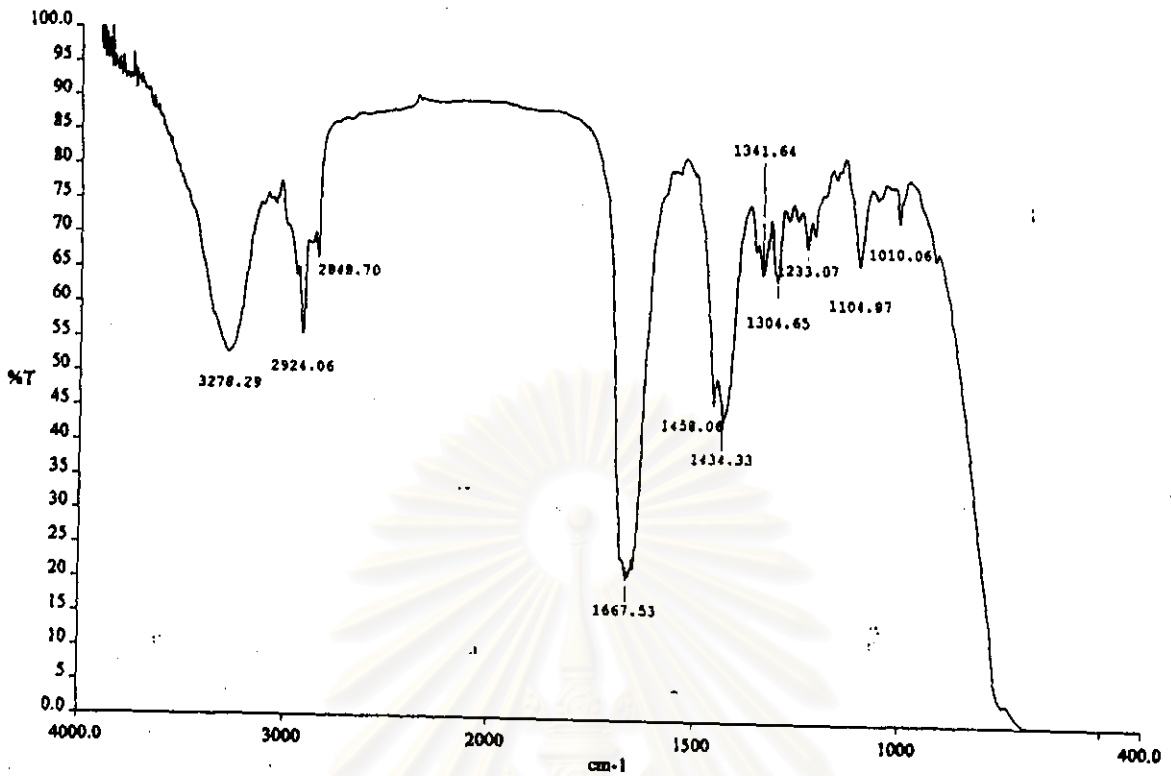


Figure 101. IR spectrum of *cyclo*-(L-prolyl-L-tryptophanyl) (P350) (film)

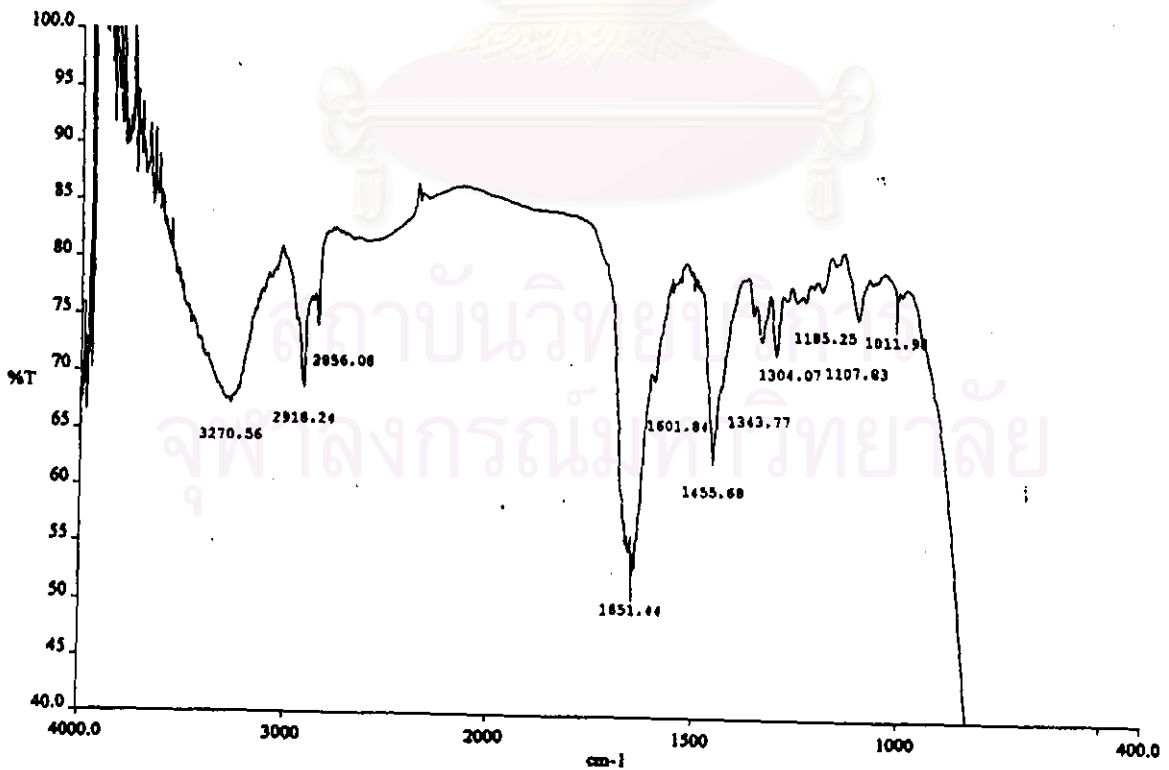
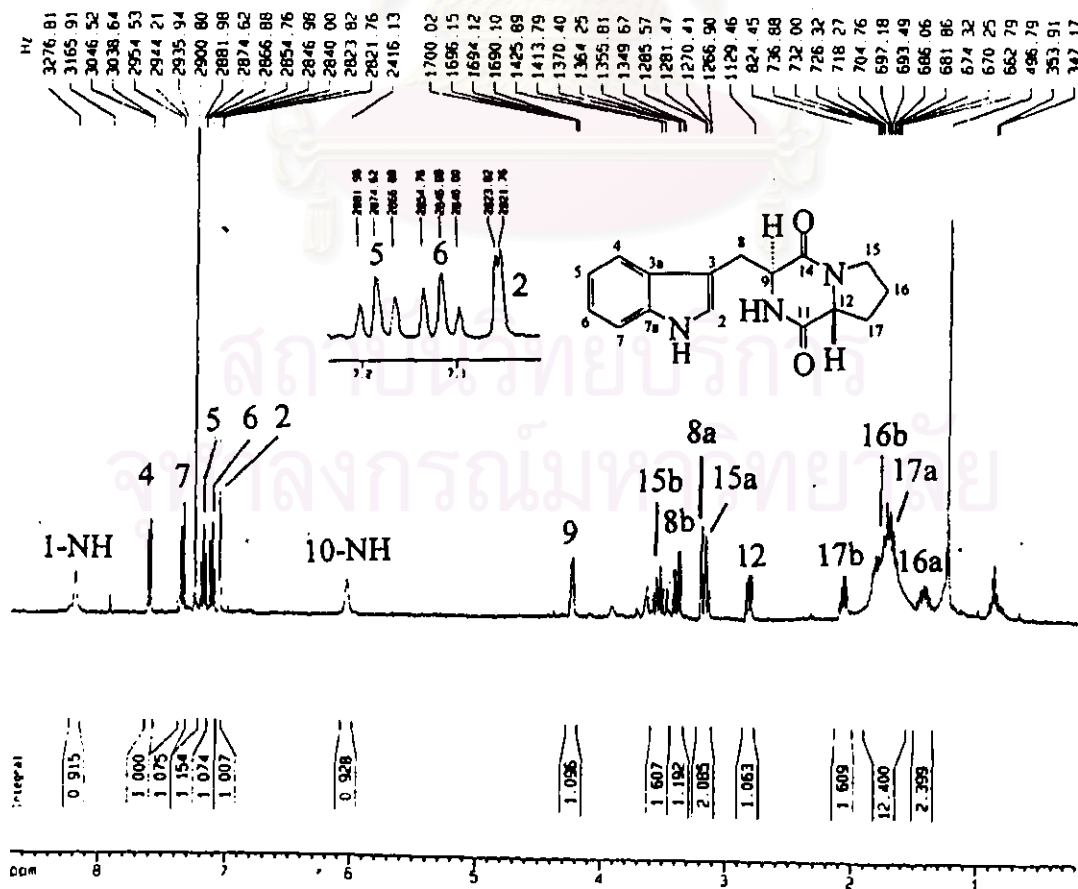
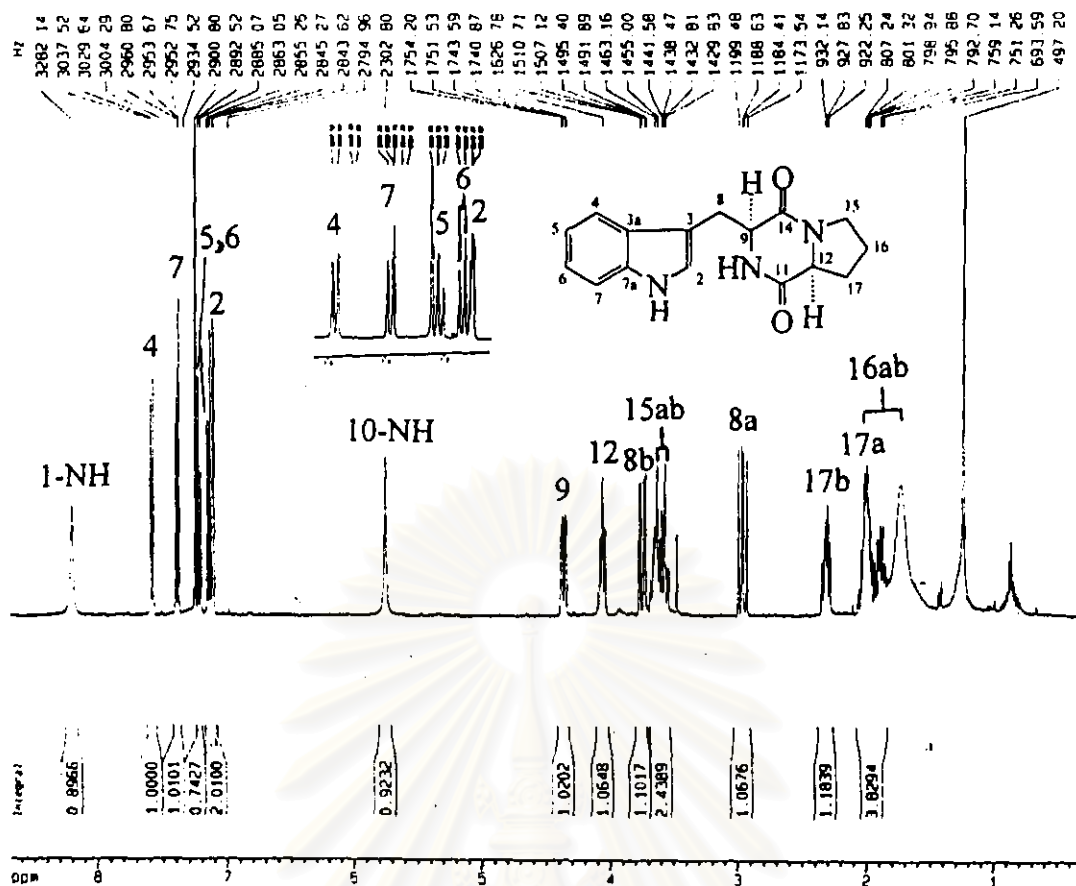


Figure 102. IR spectrum of *cyclo*-(D-prolyl-L-tryptophanyl) (P352) (film)





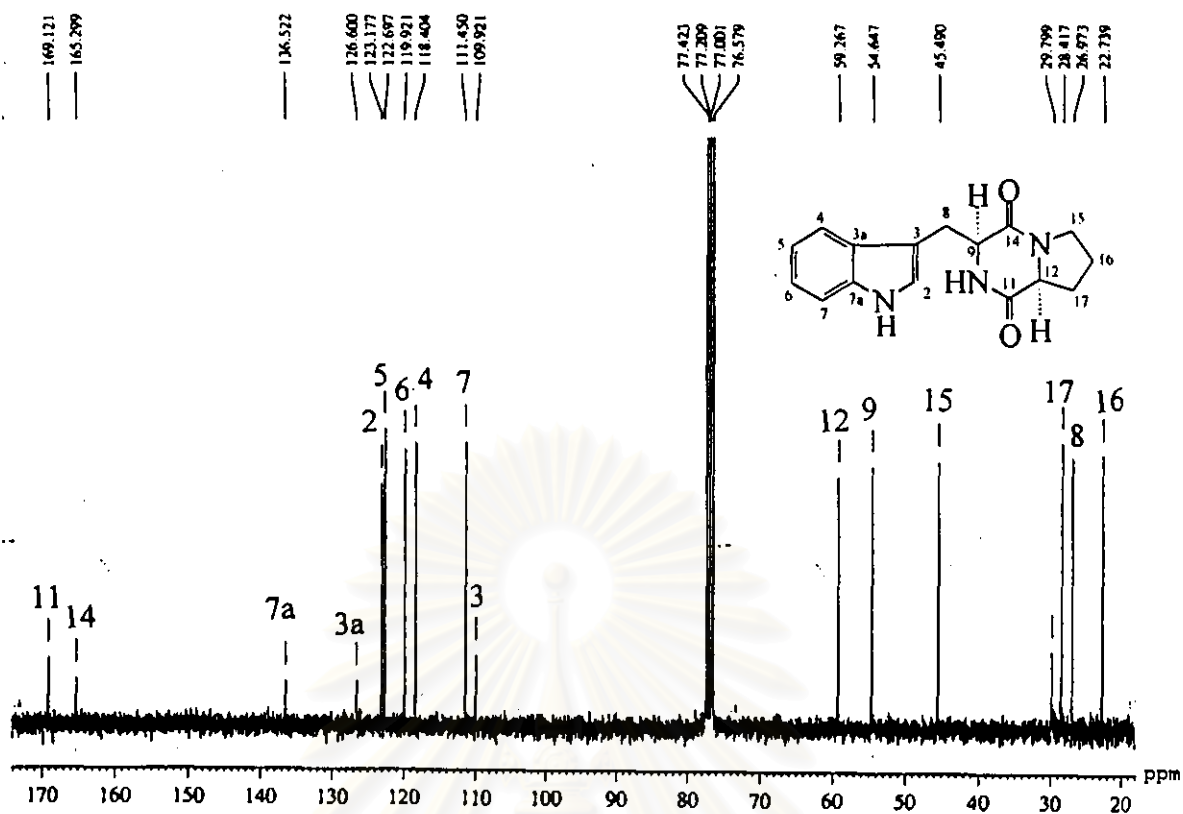


Figure 105. The 75 MHz <sup>13</sup>C NMR spectrum of *cyclo*-(L-prolyl-L-tryptophanyl) (P350) (in CDCl<sub>3</sub>)

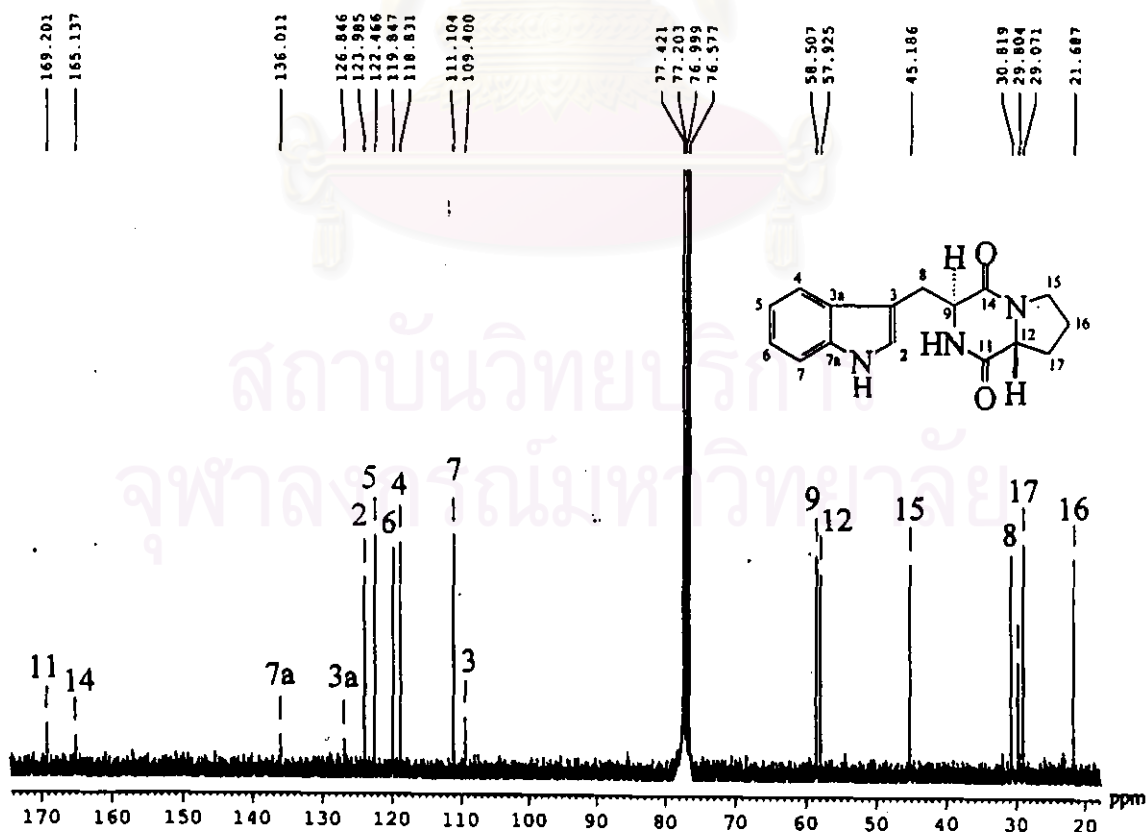
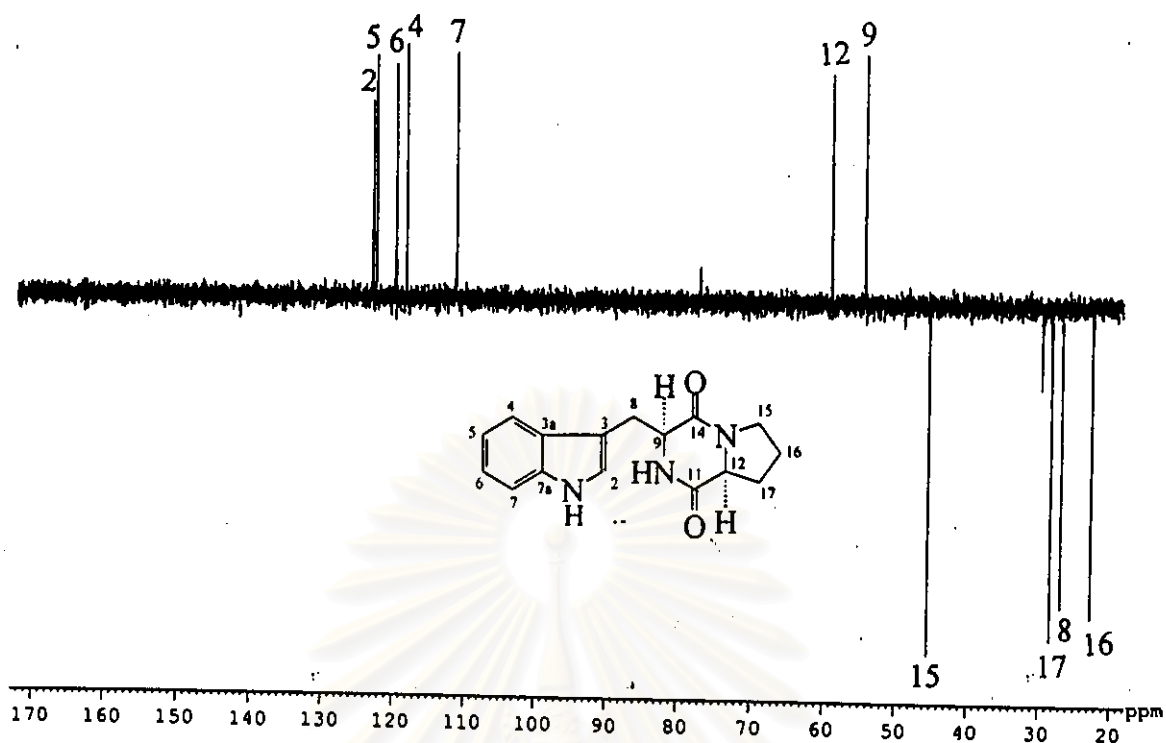
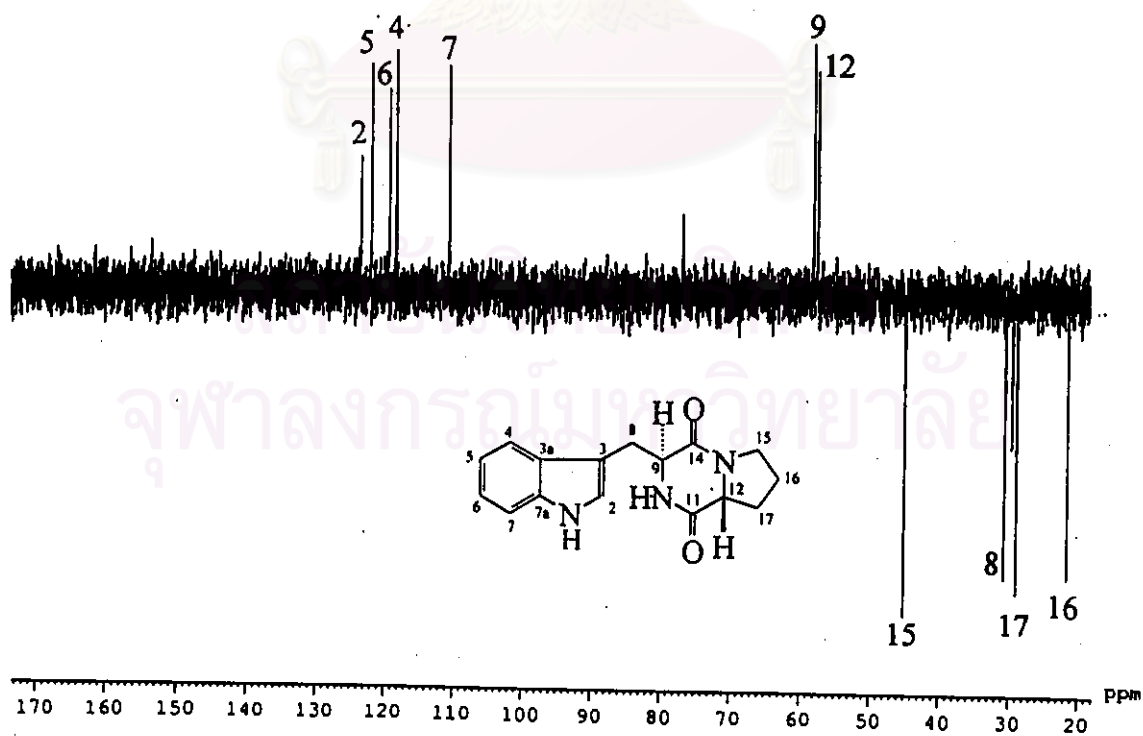


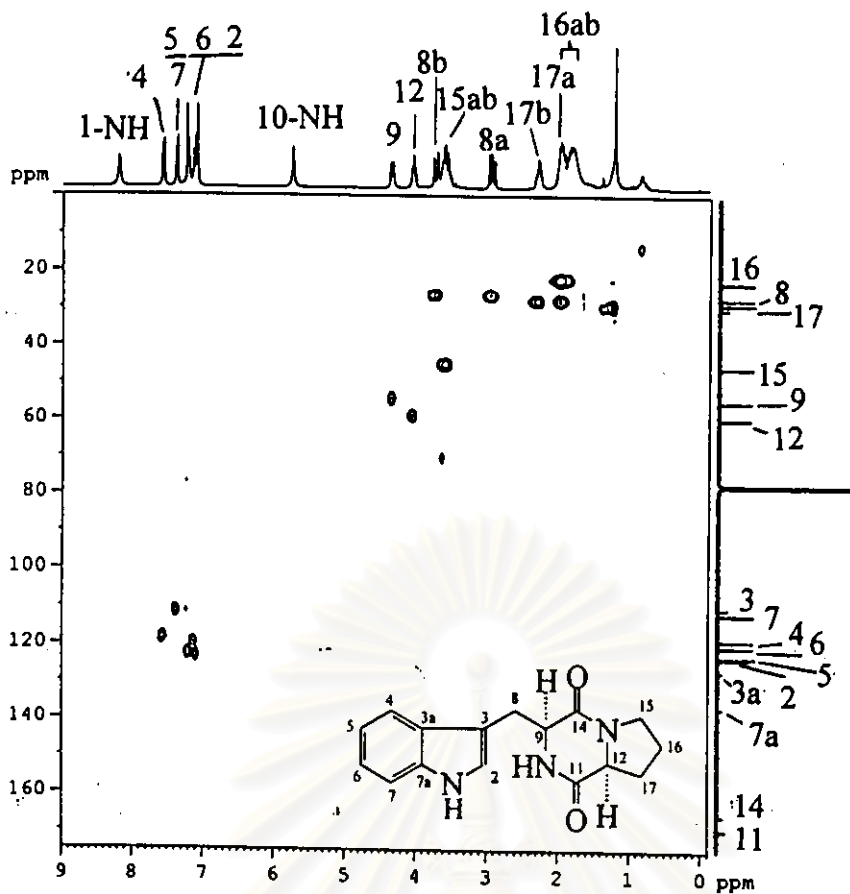
Figure 106. The 75 MHz <sup>13</sup>C NMR spectrum of *cyclo*-(D-prolyl-L-tryptophanyl) (P352) (in CDCl<sub>3</sub>)



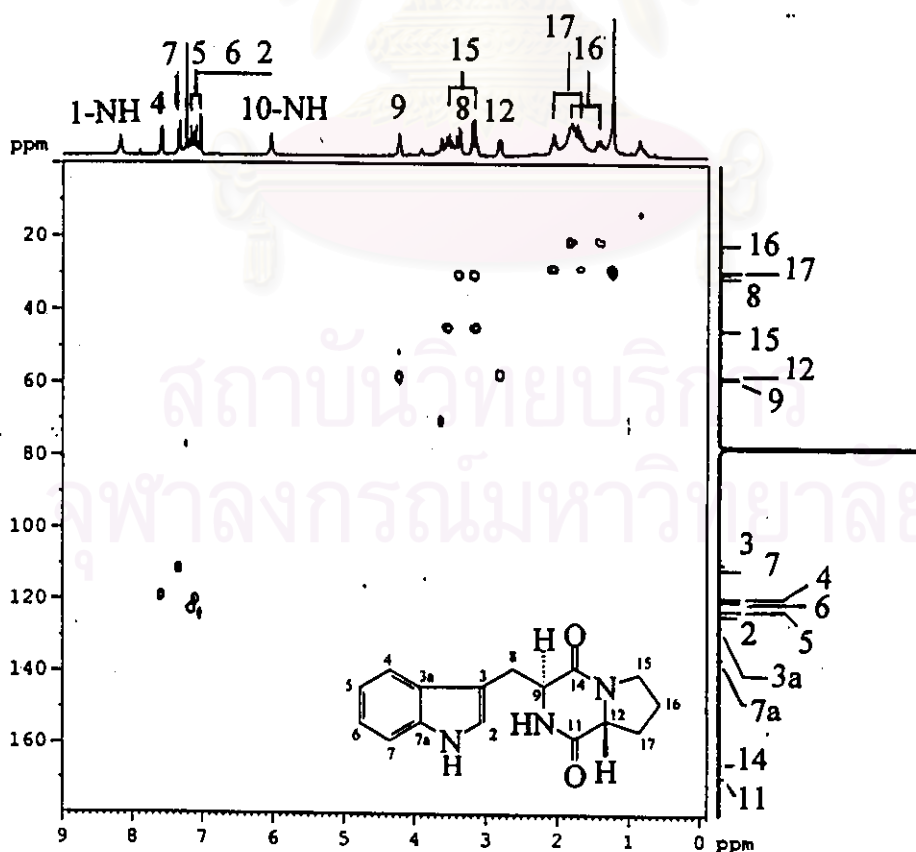
**Figure 107.** The 75 MHz DEPT 135 spectrum of *cyclo*-(L-prolyl-L-tryptophanyl) (P350) (in CDCl<sub>3</sub>)



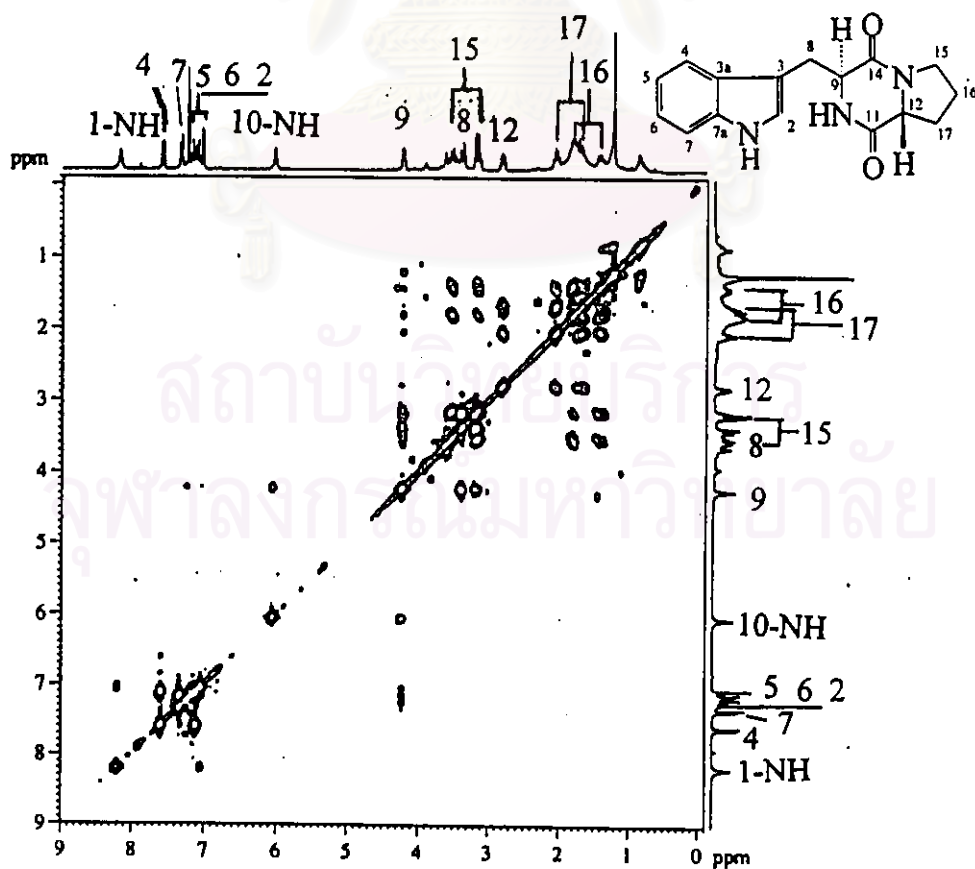
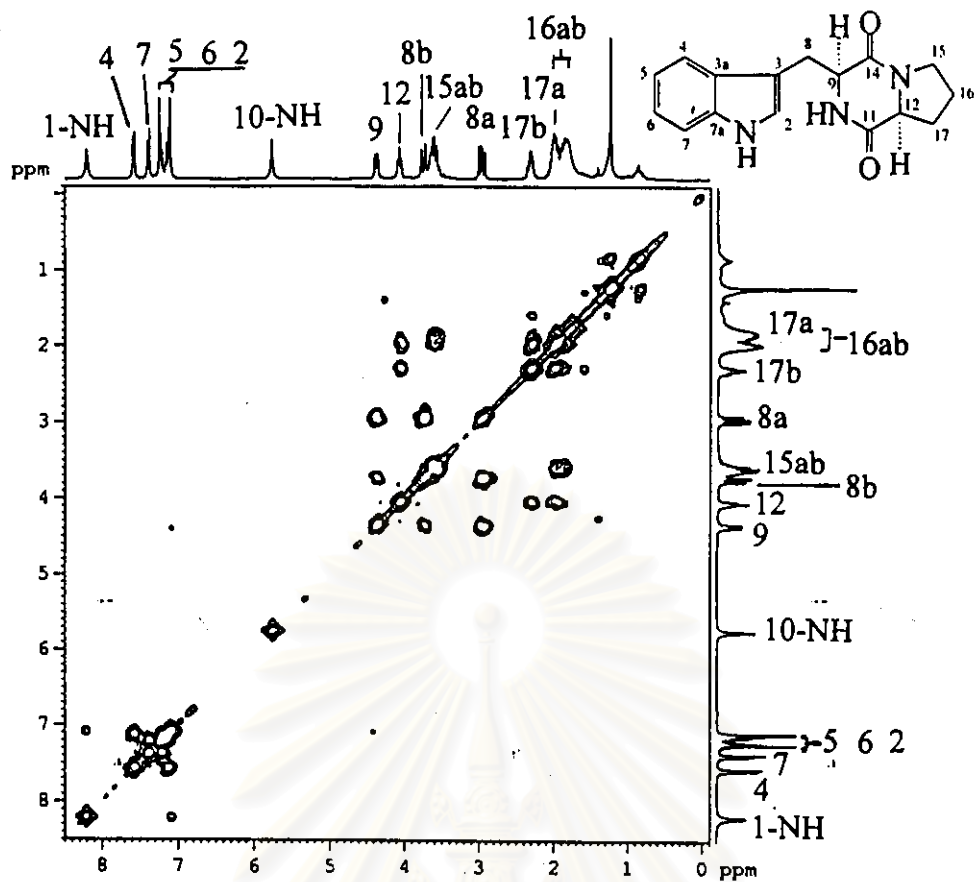
**Figure 108.** The 75 MHz DEPT 135 spectrum of *cyclo*-(D-prolyl-L-tryptophanyl) (P352) (in CDCl<sub>3</sub>)



**Figure 109.** The 300 MHz HMQC spectrum of *cyclo*-(L-prolyl-L-tryptophanyl) (P350) (in  $\text{CDCl}_3$ )



**Figure 110.** The 300 MHz HMQC spectrum of *cyclo*-(D-prolyl-L-tryptophanyl) (P352) (in  $\text{CDCl}_3$ )



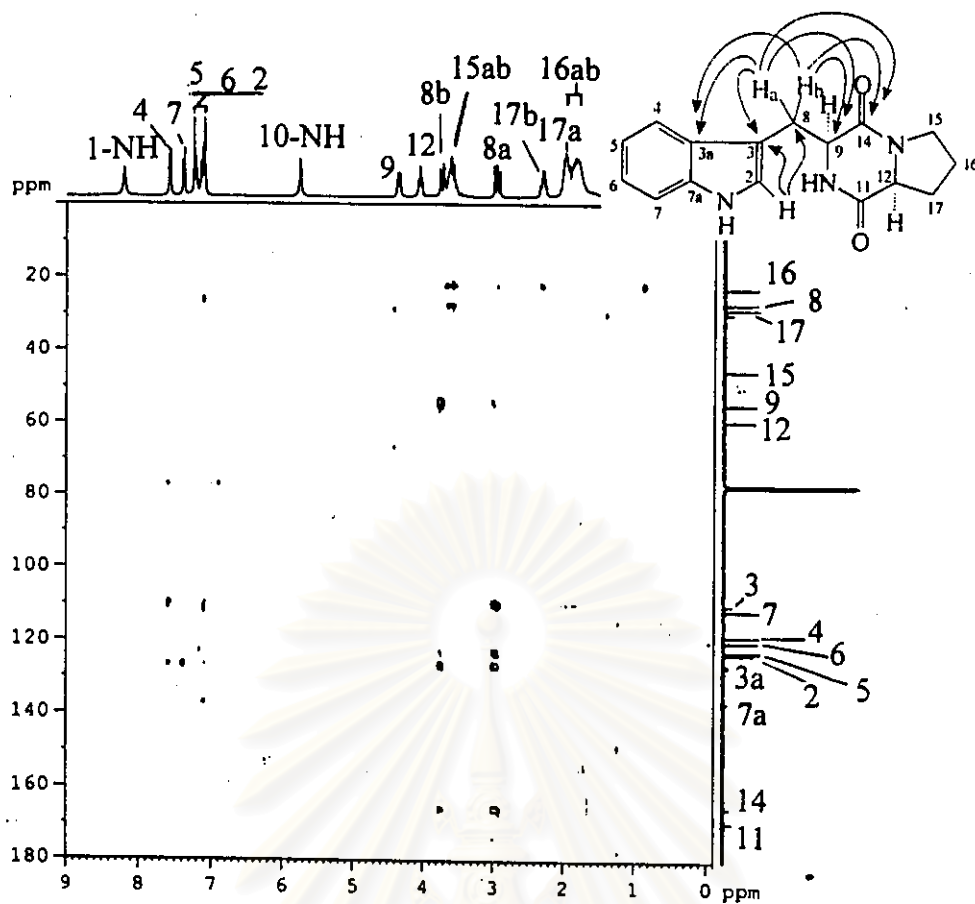


Figure 113. The 300 MHz HMBC spectrum ( $^nJ_{\text{HC}} = 4 \text{ Hz}$ ) of *cyclo*-(L-prolyl-L-tryptophanyl) (P350) (in  $\text{CDCl}_3$ )

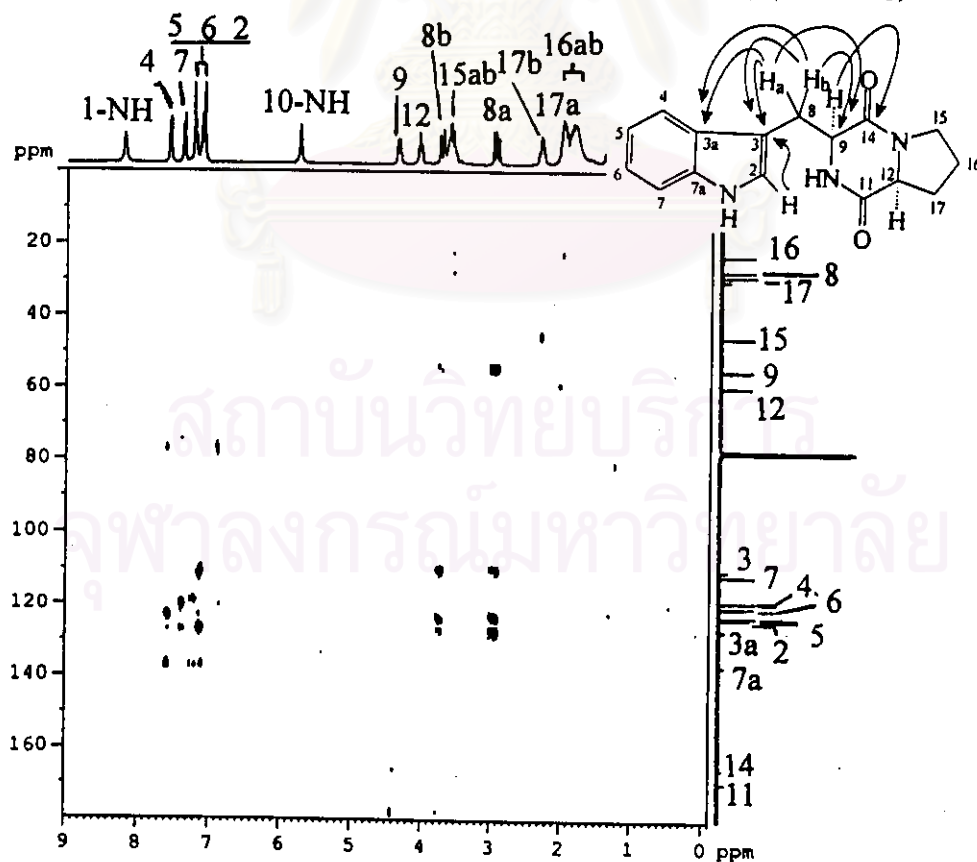
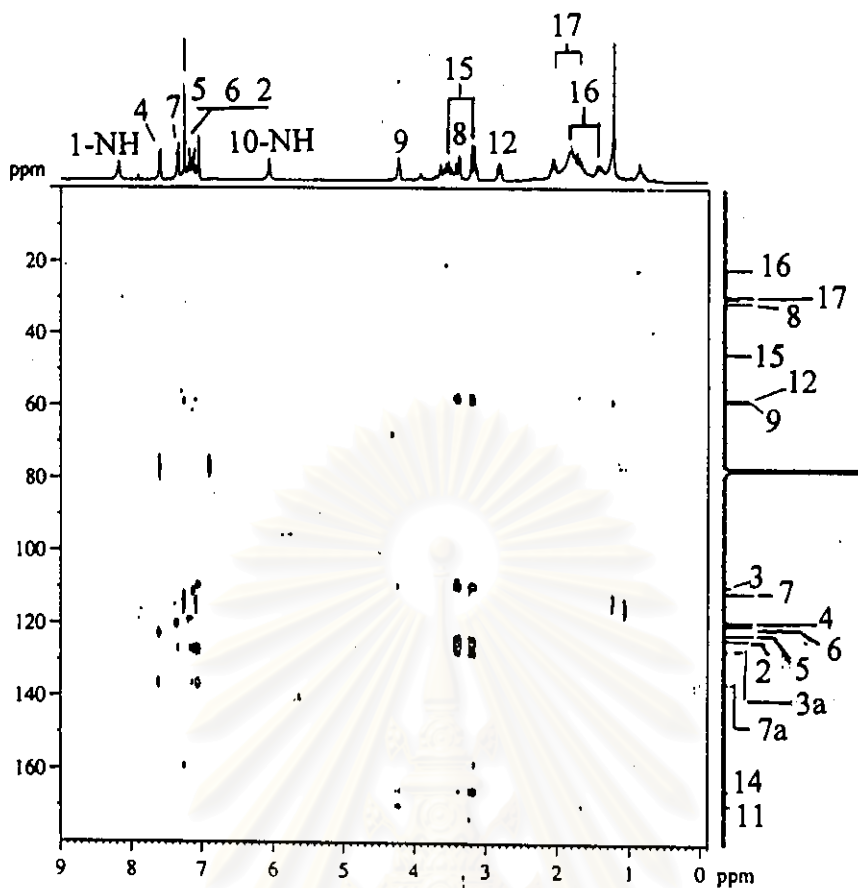
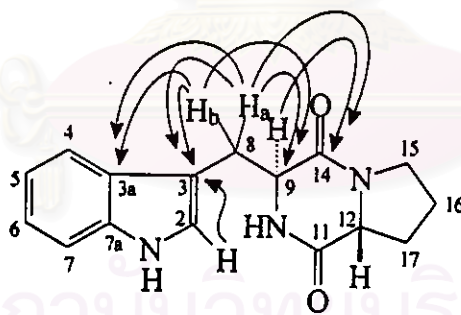


Figure 114. The 300 MHz HMBC spectrum ( $^nJ_{\text{HC}} = 8 \text{ Hz}$ ) of *cyclo*-(L-prolyl-L-tryptophanyl) (P350) (in  $\text{CDCl}_3$ )



**Figure 115.** The 300 MHz HMBC spectrum ( ${}^nJ_{\text{HC}} = 8 \text{ Hz}$ ) of *cyclo*-(D-prolyl-L-tryptophanyl) (P352) (in  $\text{CDCl}_3$ )



สถาบันทชบริการ  
จุฬาลงกรณ์มหาวิทยาลัย

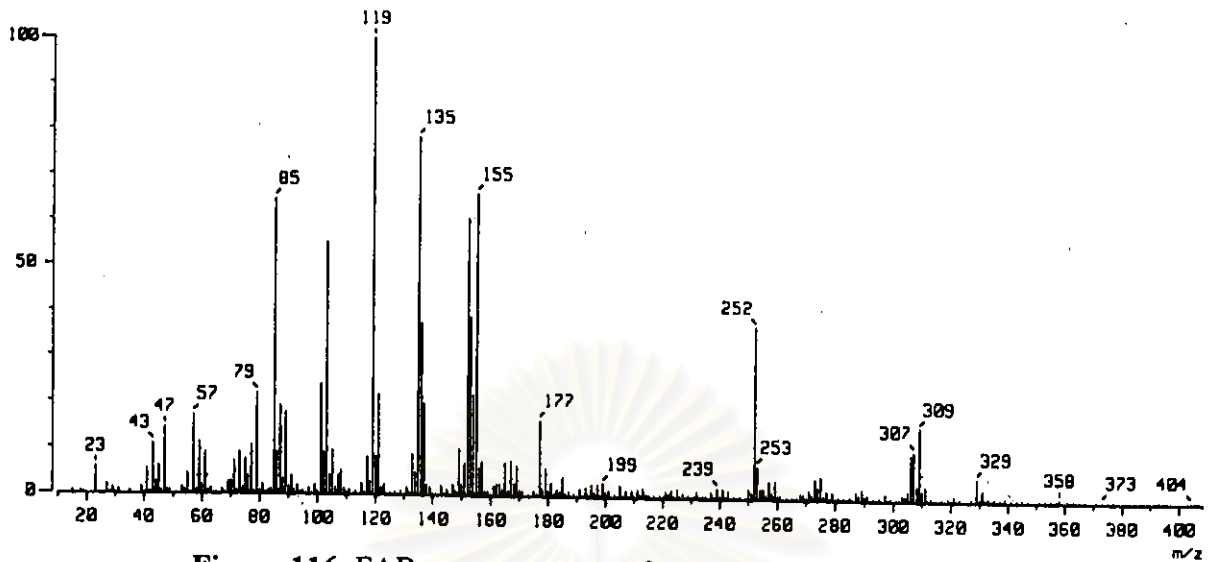


Figure 116. FAB mass spectrum of 2'-deoxyadenosine (S147)

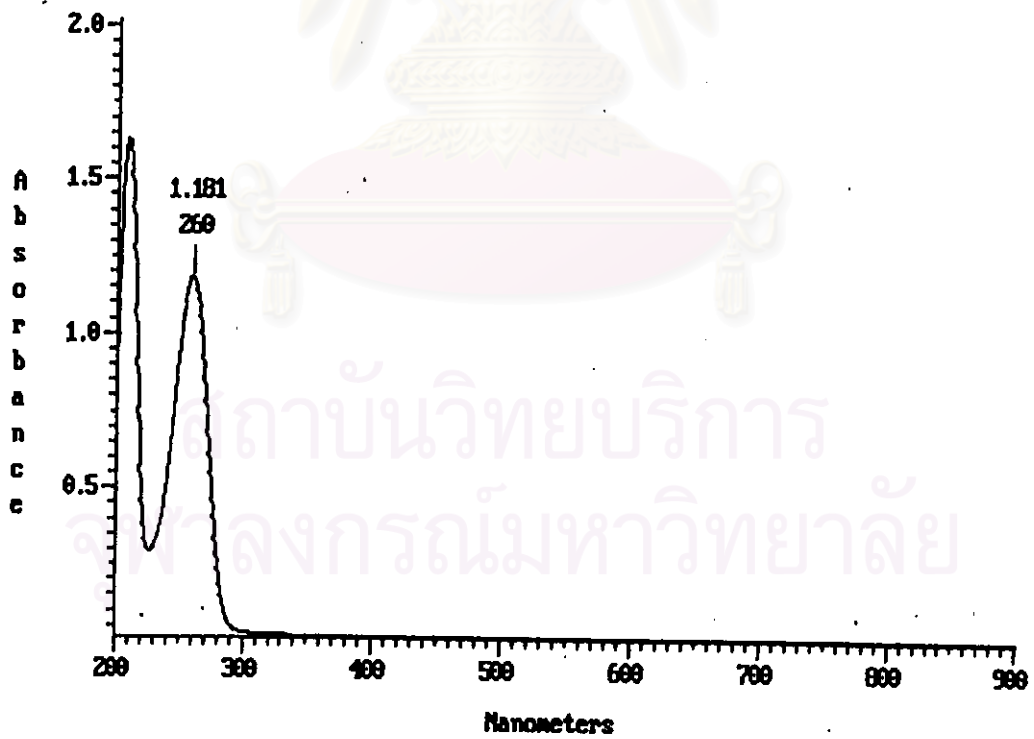


Figure 117. UV spectrum of 2'-deoxyadenosine (S147) (in MeOH)



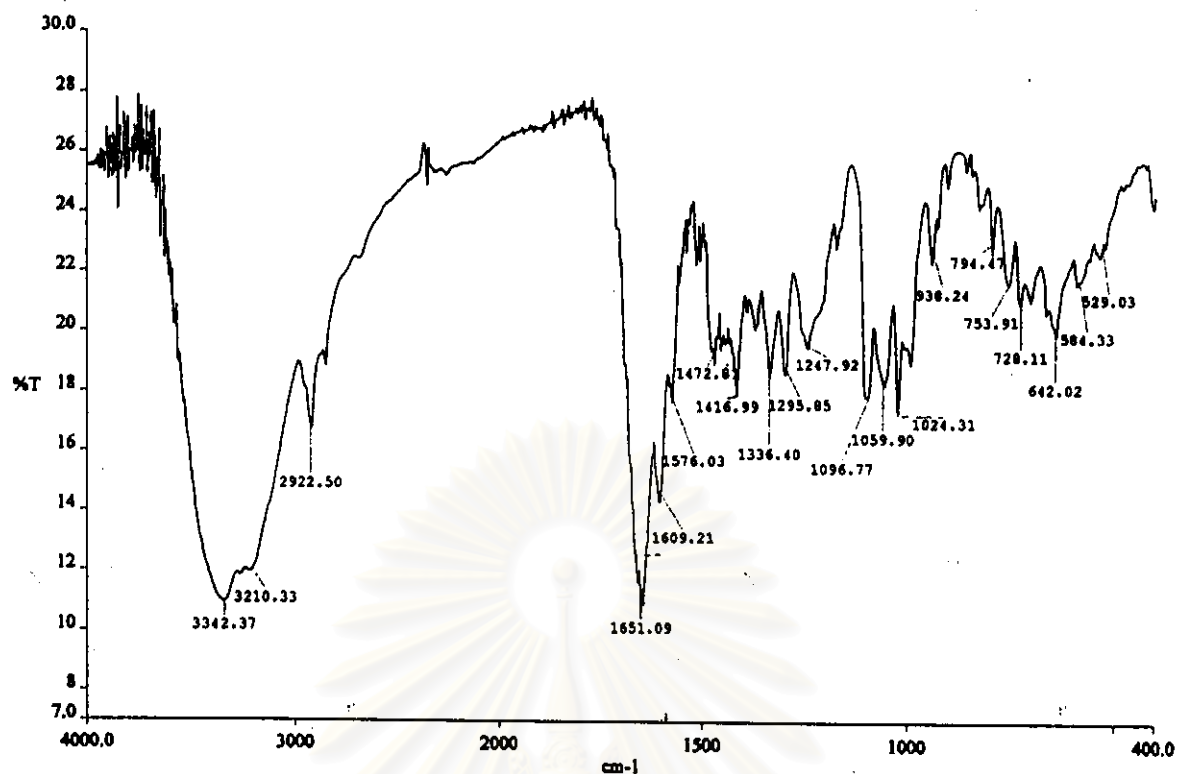


Figure 118. IR spectrum of 2'-deoxyadenosine (S147) (film)

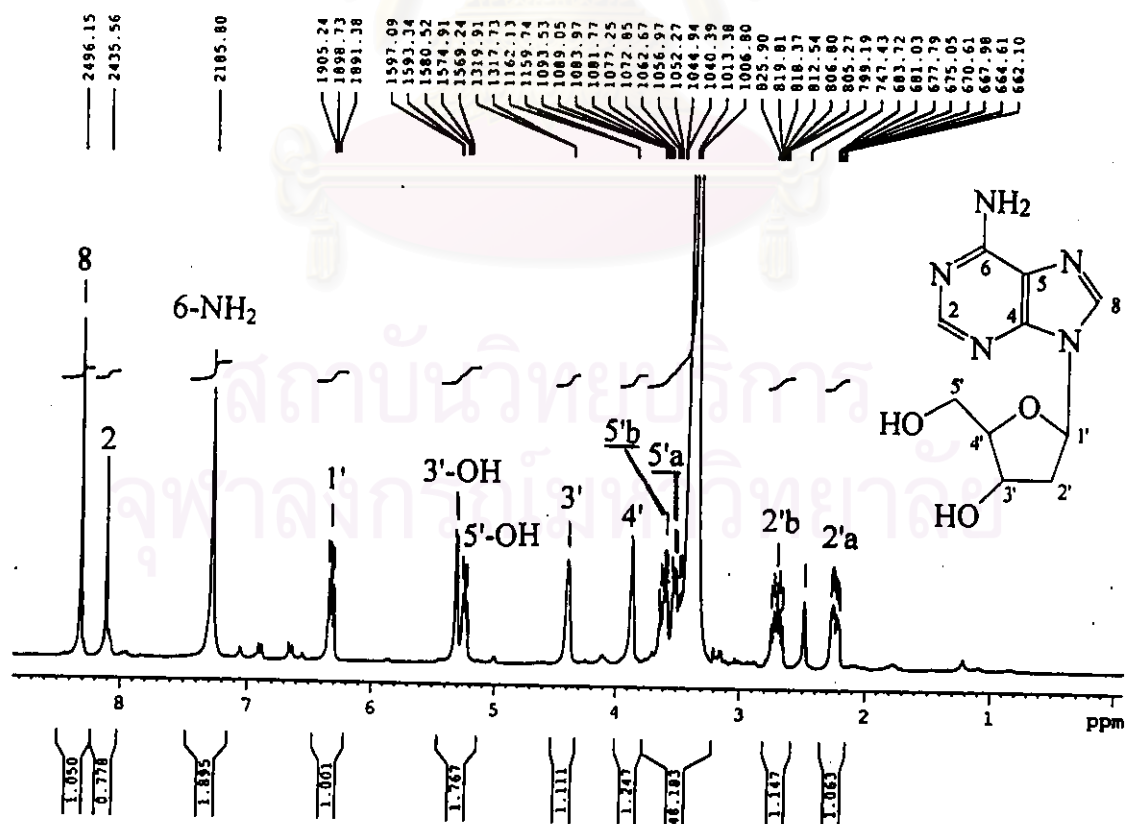


Figure 119. The 300 MHz <sup>1</sup>H NMR spectrum of 2'-deoxyadenosine (S147) (in DMSO-*d*<sub>6</sub>)

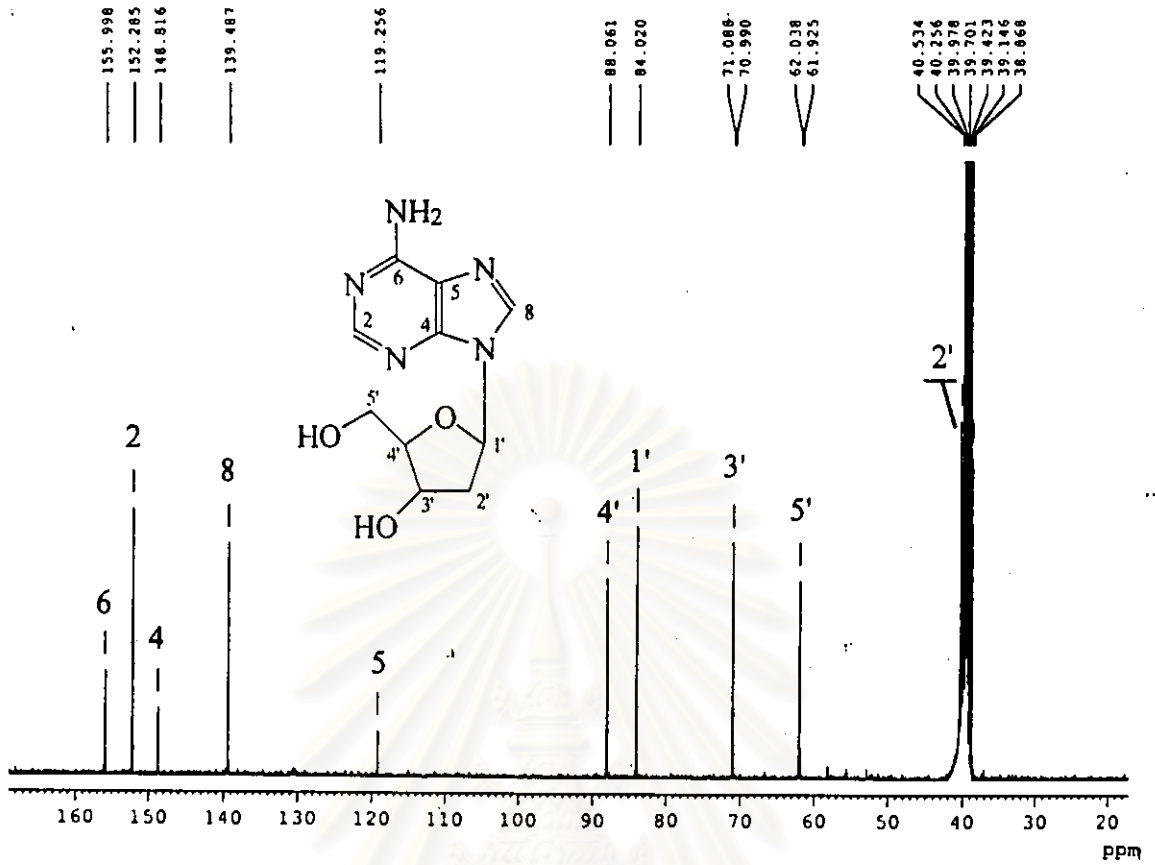


Figure 120. The 75 MHz  $^{13}\text{C}$  NMR spectrum of 2'-deoxyadenosine (S147) (in  $\text{DMSO-}d_6$ )

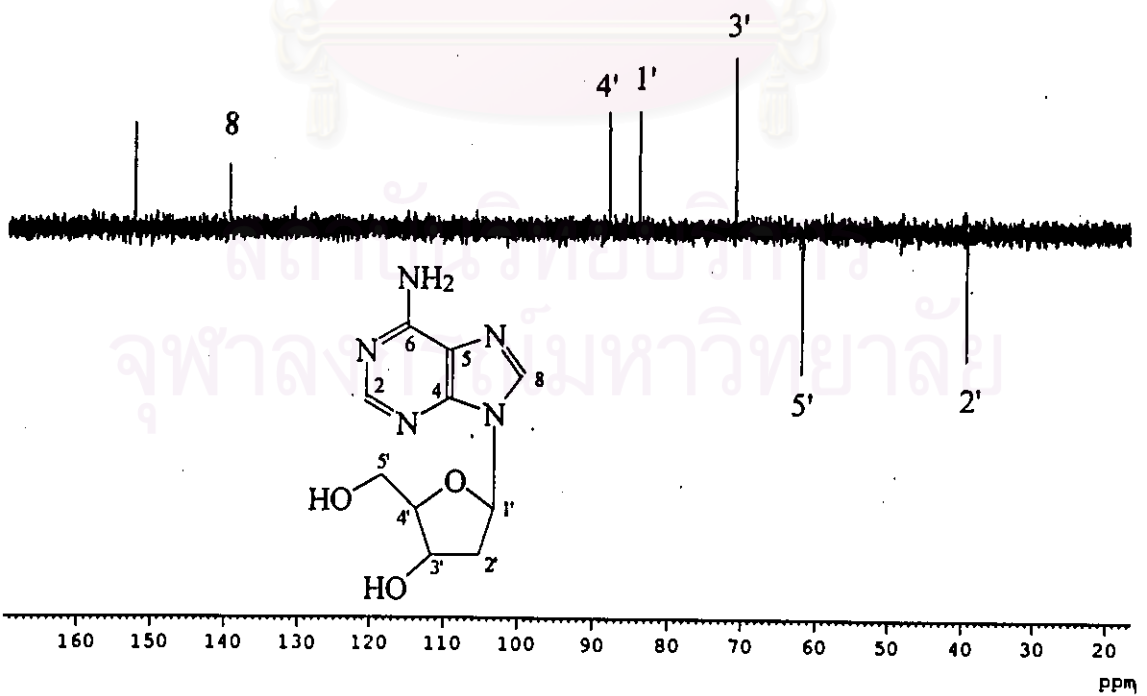


Figure 121. The 75 MHz DEPT 135 spectrum of 2'-deoxyadenosine (S147) (in  $\text{DMSO-}d_6$ )

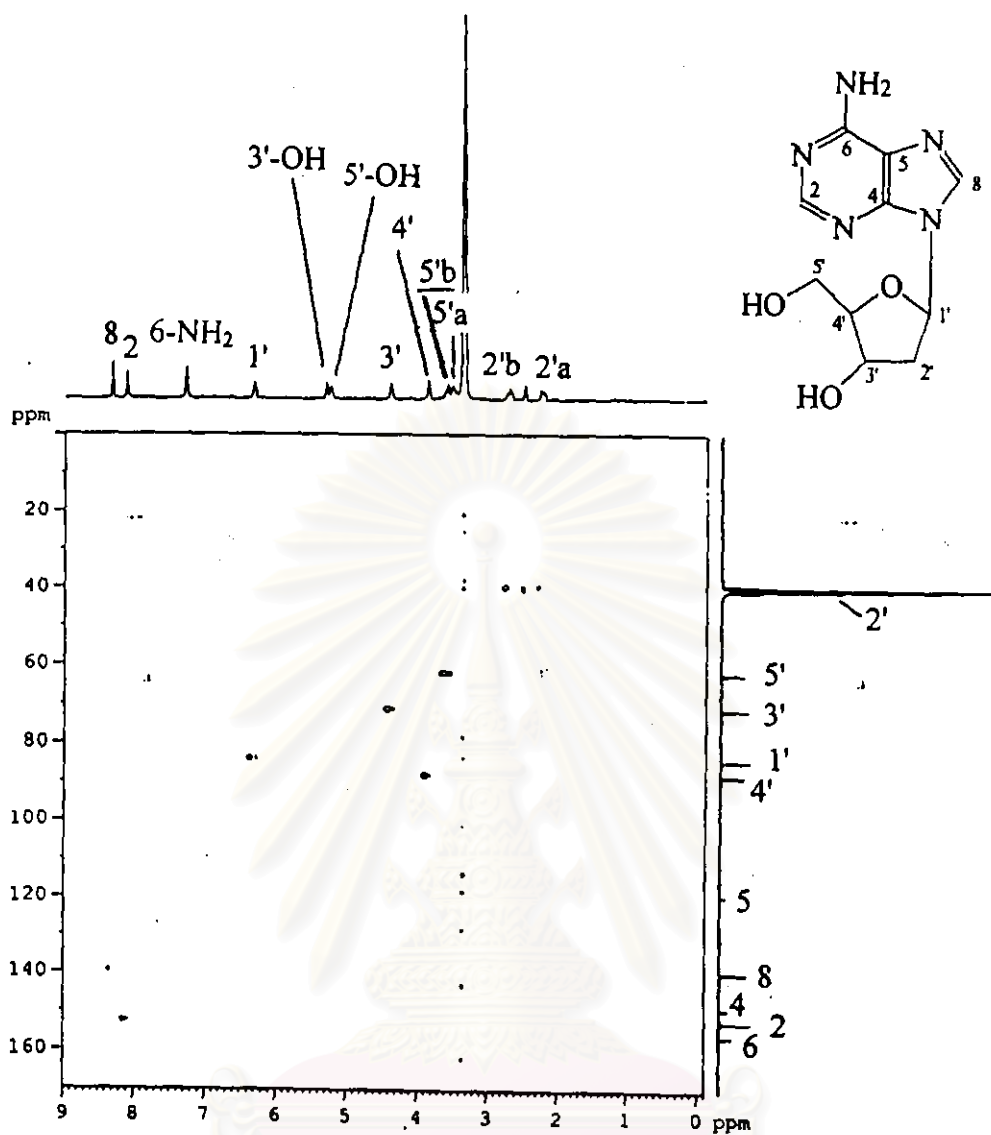


Figure 122. The 300 MHz HMQC spectrum of 2'-deoxyadenosine (S147) (in DMSO- $d_6$ )

สถาบันวิทยบริการ  
จุฬาลงกรณ์มหาวิทยาลัย

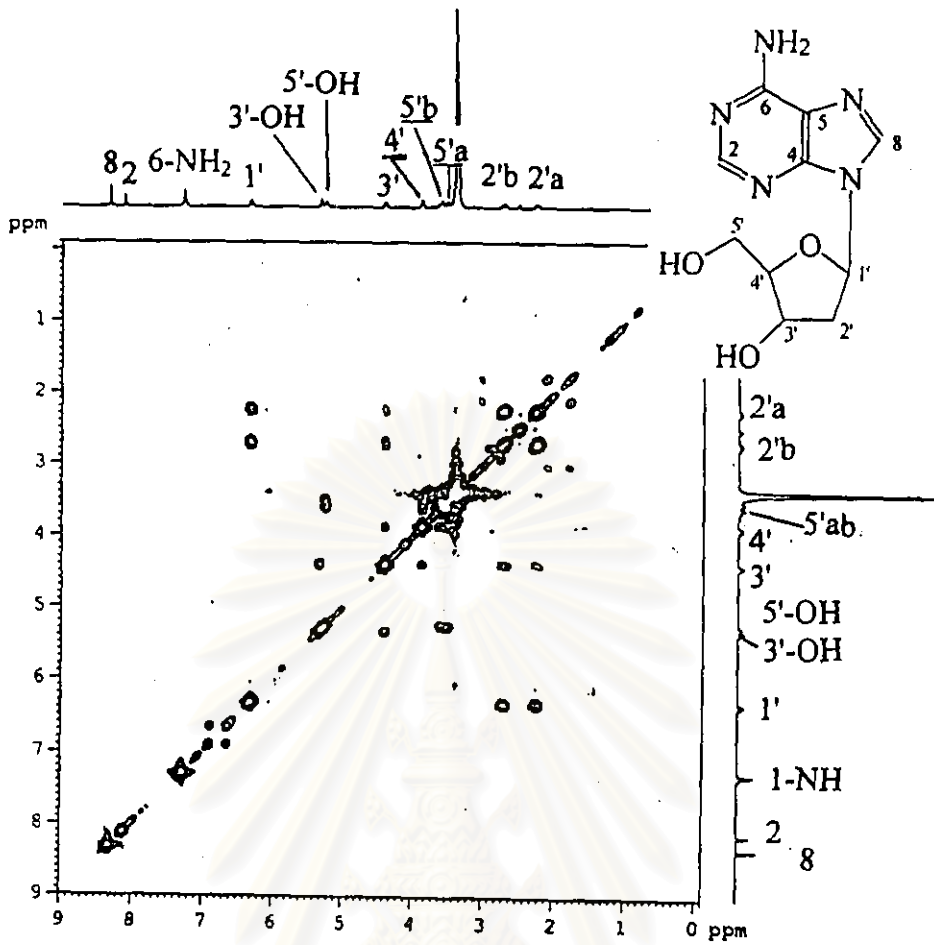
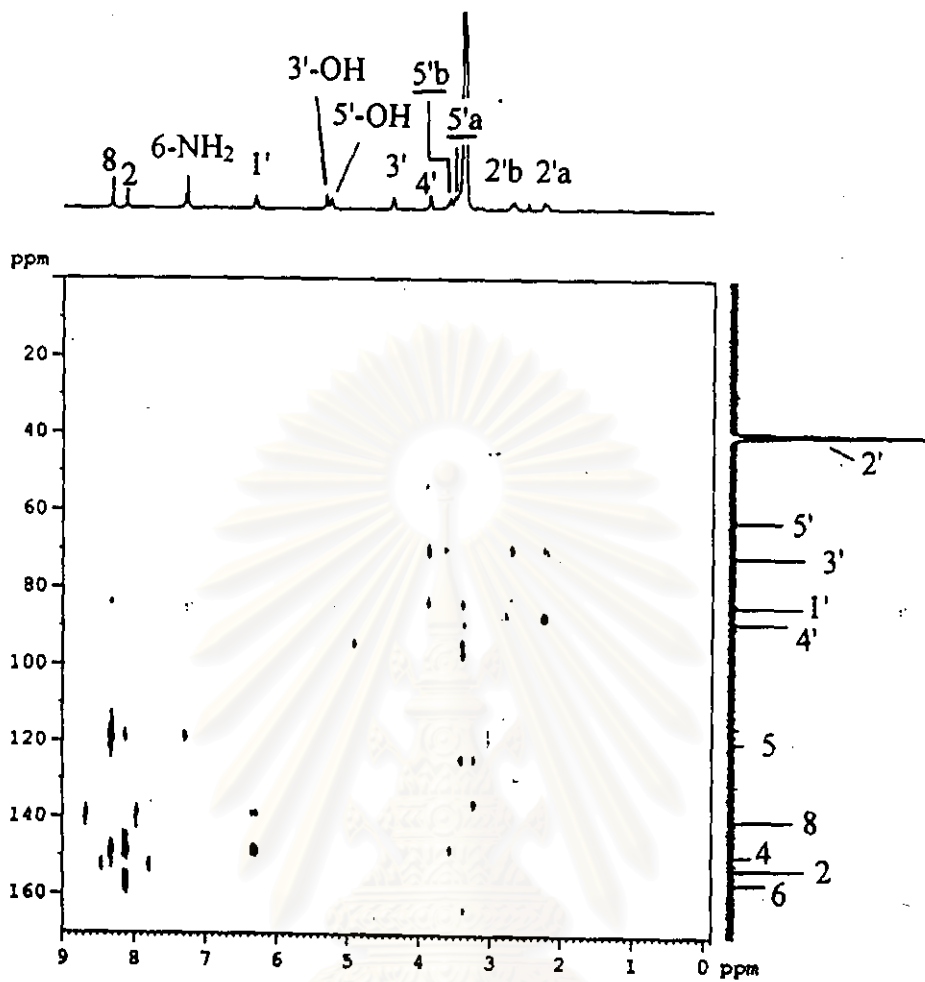
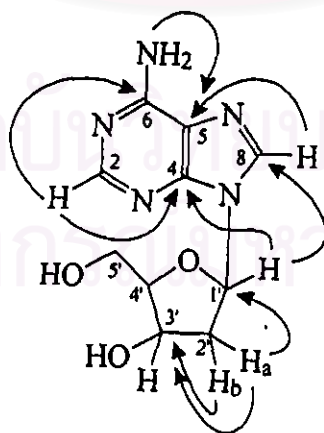


Figure 123. The 300 MHz  $^1\text{H}$ - $^1\text{H}$  COSY spectrum of 2'-deoxyadenosine (S147) (in  $\text{DMSO}-d_6$ )

สถาบันวิทยบริการ  
จุฬาลงกรณ์มหาวิทยาลัย



**Figure 124.** The 300 MHz HMBC NMR spectrum ( ${}^nJ_{\text{HC}} = 4 \text{ Hz}$ ) of 2'-deoxyadenosine (S147) (in  $\text{DMSO-}d_6$ )



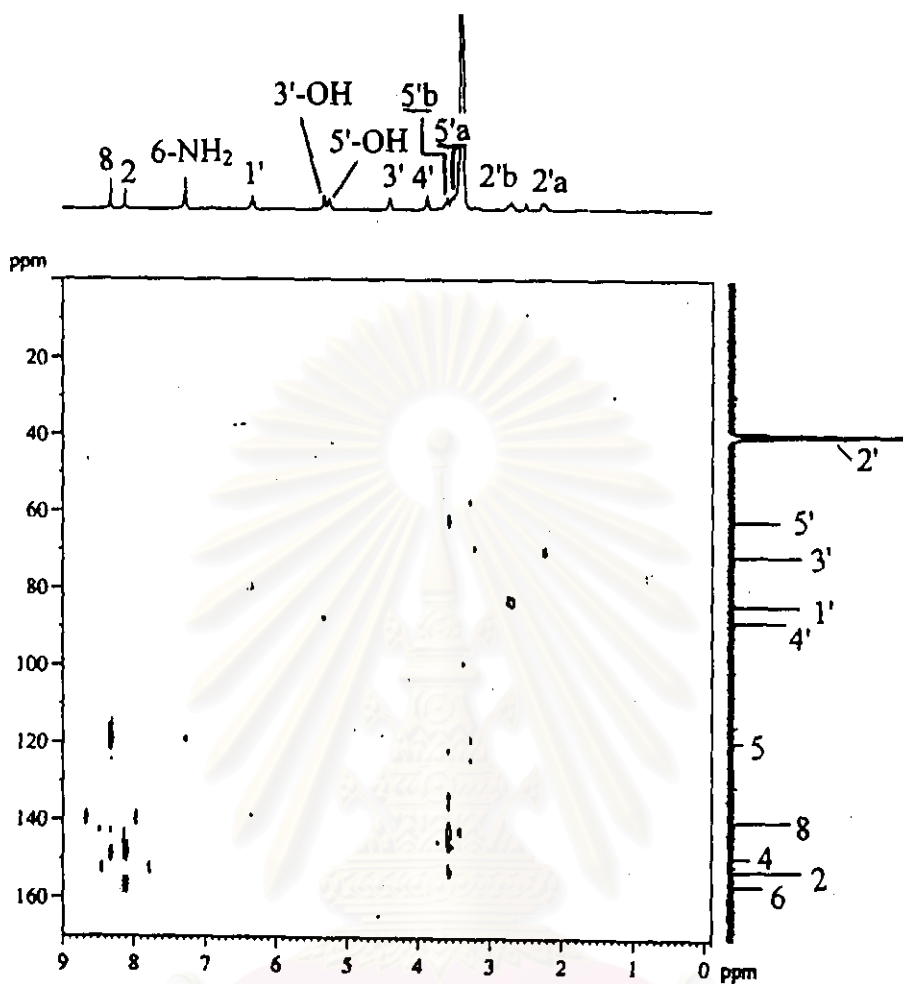
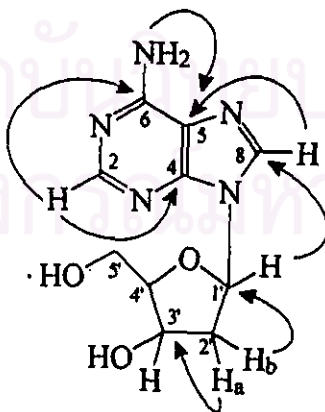


Figure 125. The 300 MHz HMBC NMR spectrum ( $^nJ_{\text{HC}} = 8 \text{ Hz}$ ) of 2'-deoxyadenosine (S147) (in  $\text{DMSO-}d_6$ )



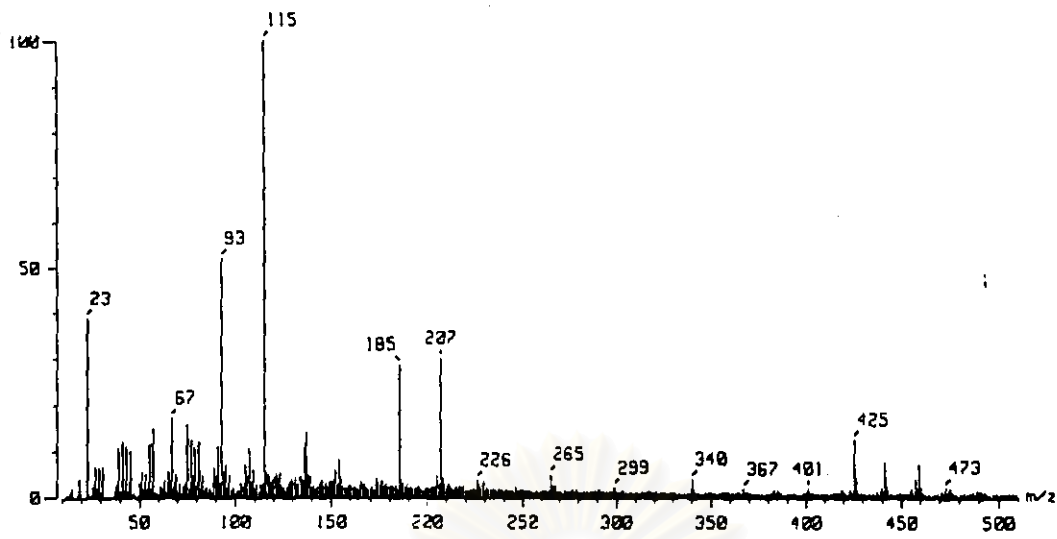


Figure 126. HRFAB mass spectrum of macrolactin F (P035)

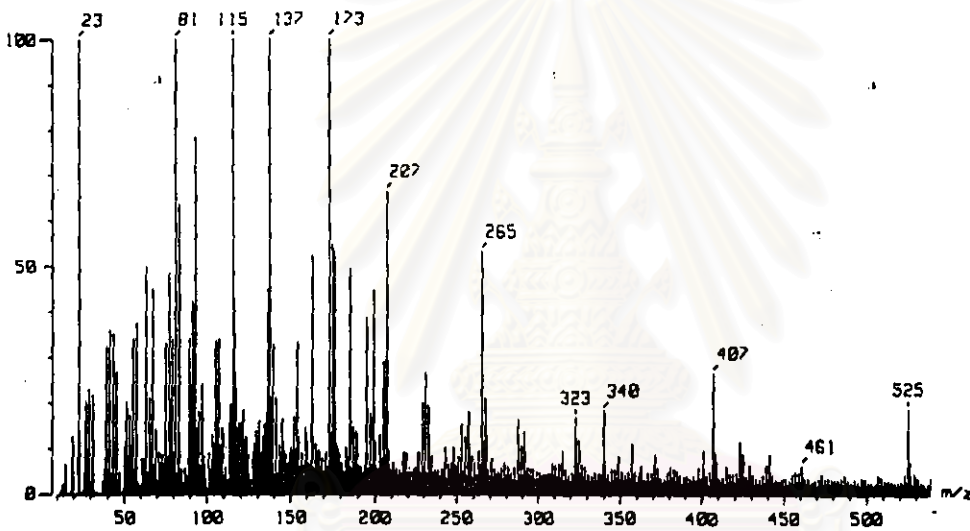


Figure 127. HRFAB mass spectrum of 7-O-succinyl macrolactin F (P129)

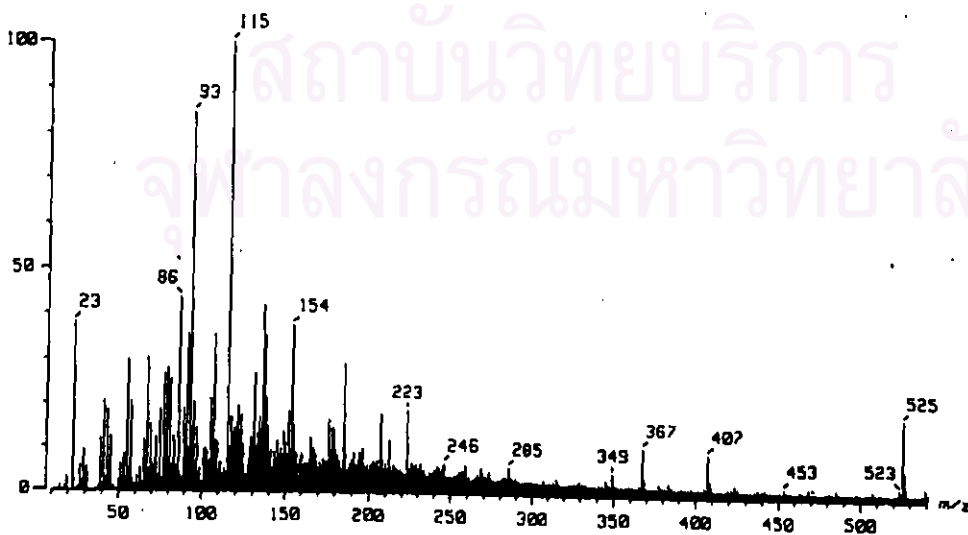


Figure 128. HRFAB mass spectrum of 7-O-succinyl macrolactin A (P103)



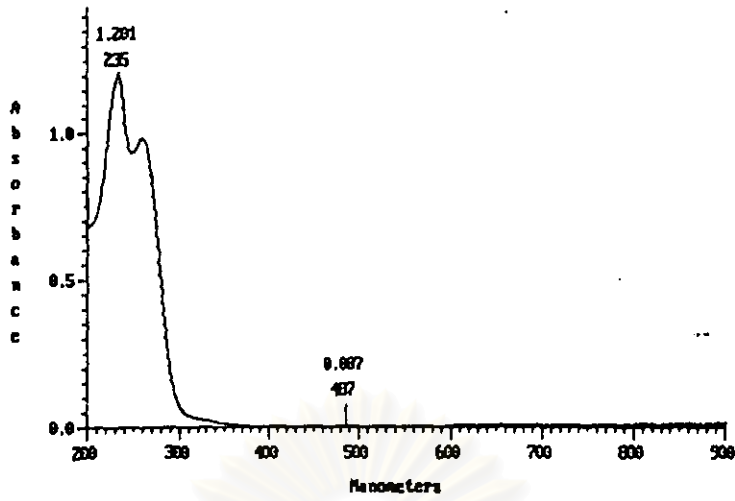


Figure 129. UV spectrum of macrolactin F (P035) (in MeOH)

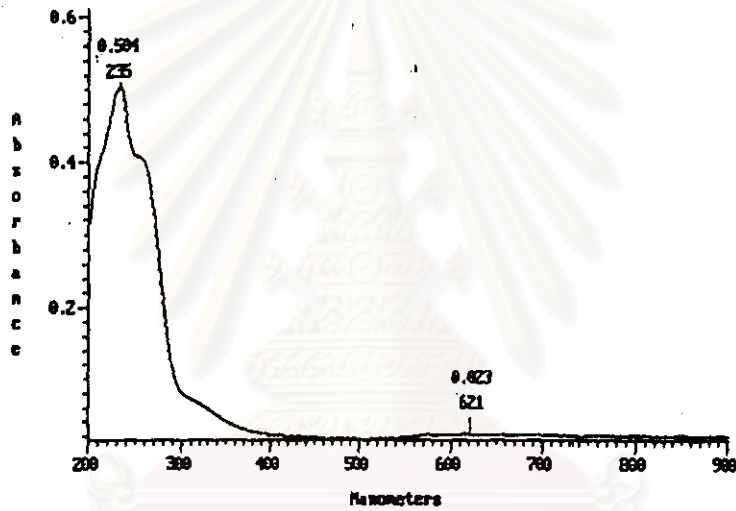


Figure 130. UV spectrum of 7-O-succinyl macrolactin F (P129) (in MeOH)

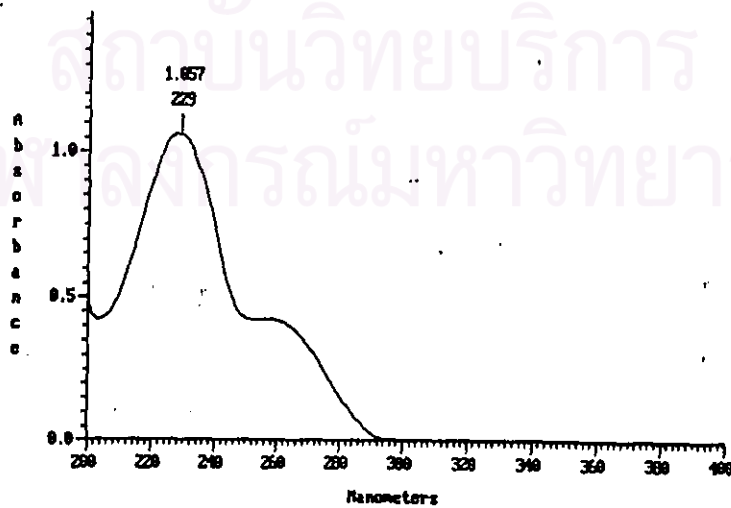


Figure 131. UV spectrum of 7-O-succinyl macrolactin A (P103) (in MeOH)

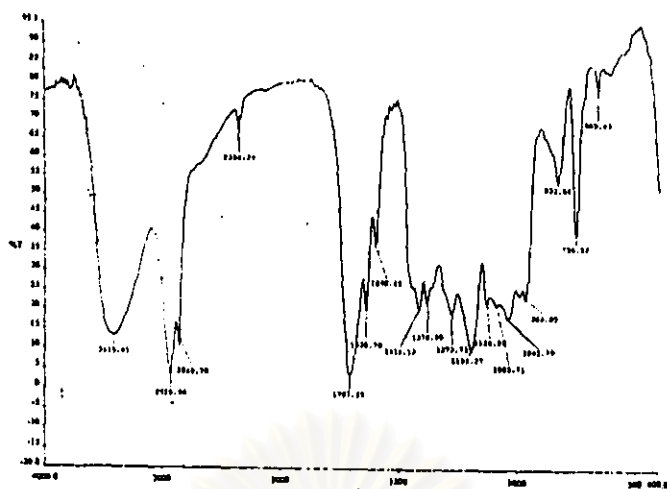


Figure 132. IR spectrum of macrolactin F (P035) (film).

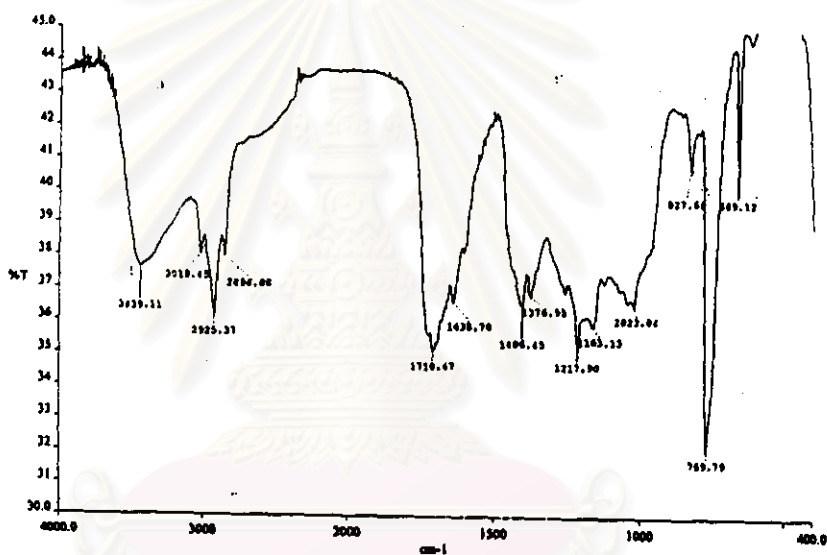


Figure 133 IR spectrum of 7-*O*-succinyl macrolactin F (P129) (film)

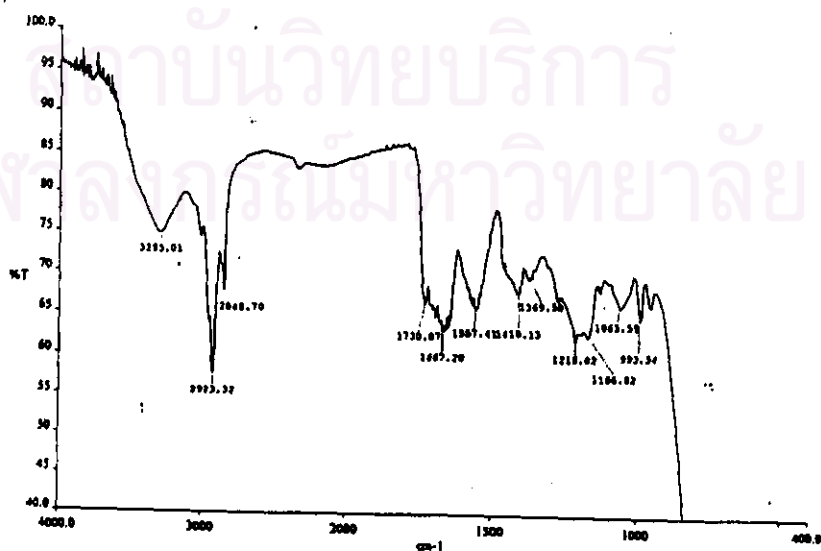
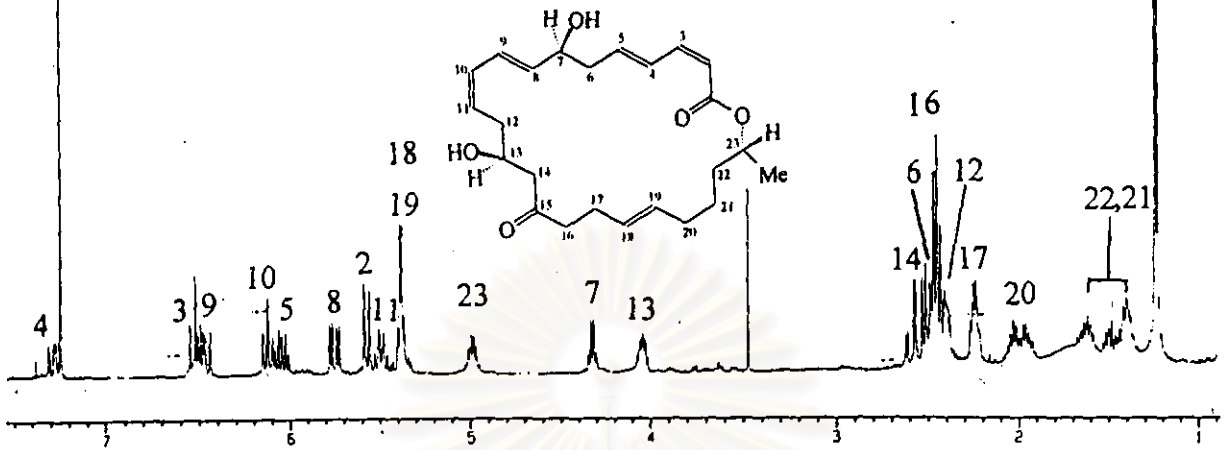
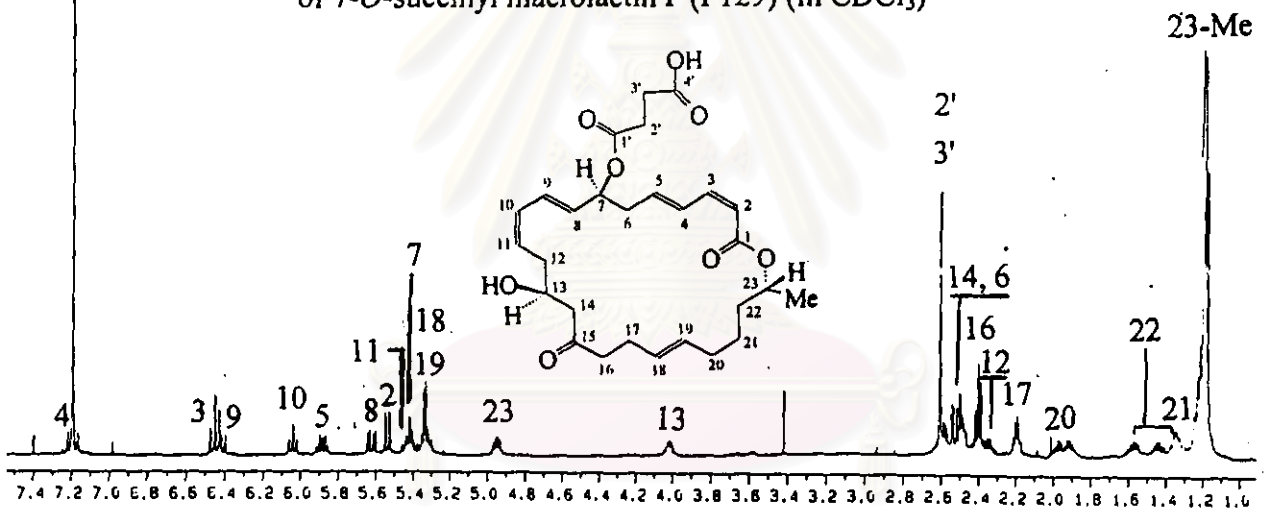
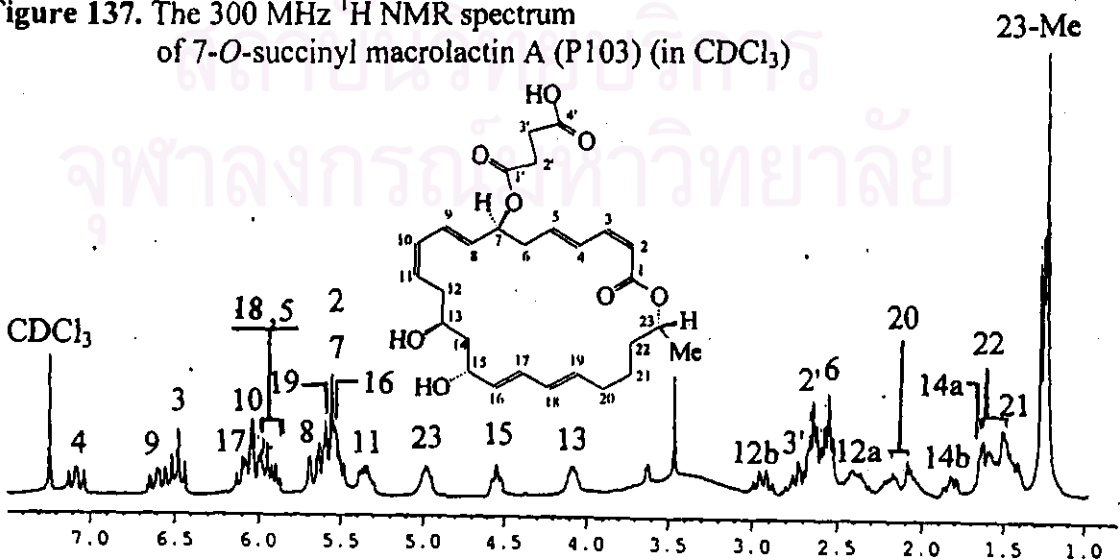


Figure 134. IR spectrum of 7-*O*-succinyl macrolactin A (P103) (film)

23-Me

CDCl<sub>3</sub>Figure 135. The 400 MHz <sup>1</sup>H NMR spectrum of macrolactin F (P035) (in CDCl<sub>3</sub>)CDCl<sub>3</sub>Figure 136. The 500 MHz <sup>1</sup>H NMR spectrum of 7-O-succinyl macrolactin F (P129) (in CDCl<sub>3</sub>)Figure 137. The 300 MHz <sup>1</sup>H NMR spectrum of 7-O-succinyl macrolactin A (P103) (in CDCl<sub>3</sub>)

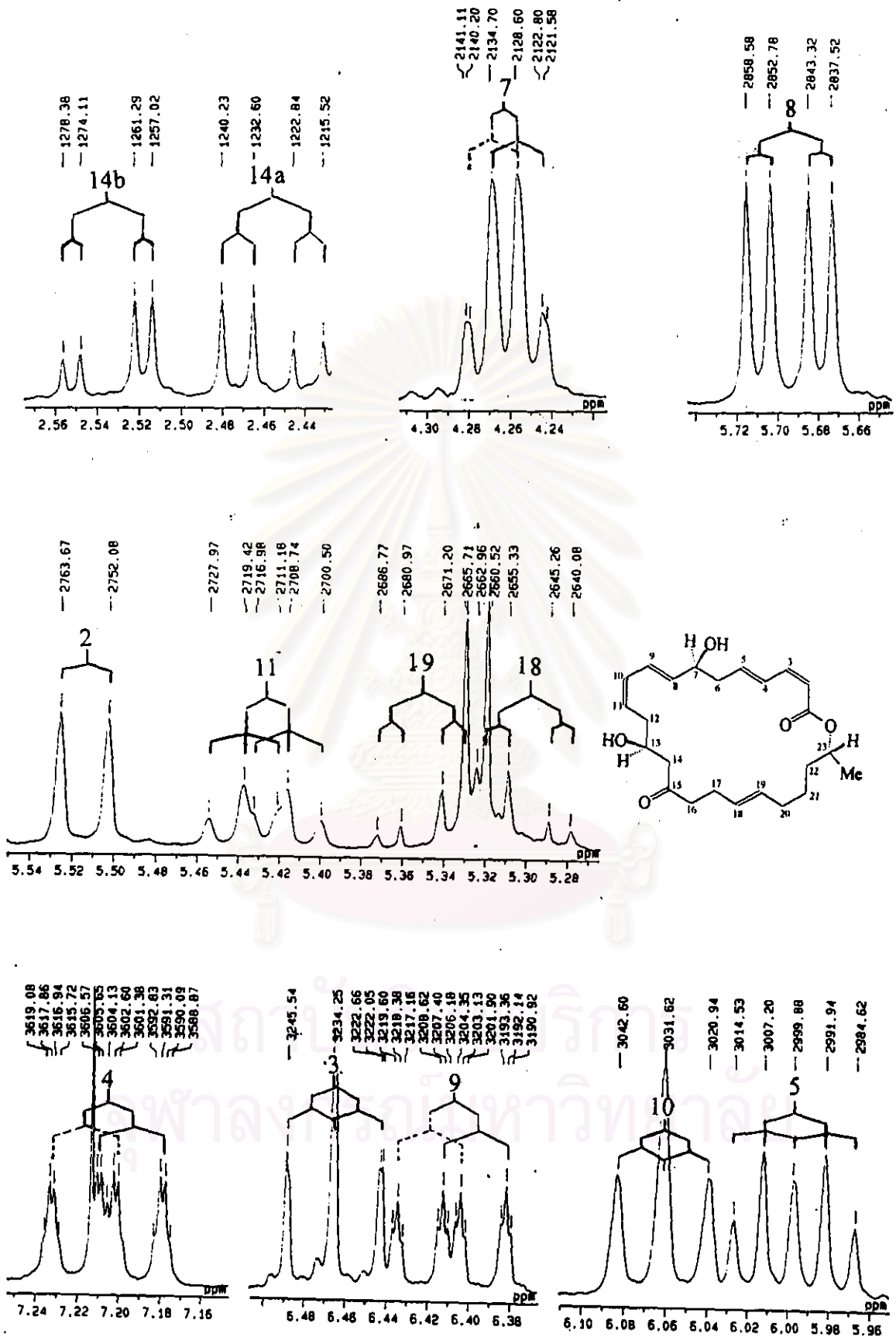


Figure 138. The 400 MHz  $^1\text{H}$  NMR spectrum of macrolactin F (P035) (in  $\text{CDCl}_3$ ) (expanded from 2.44-7.24 ppm)

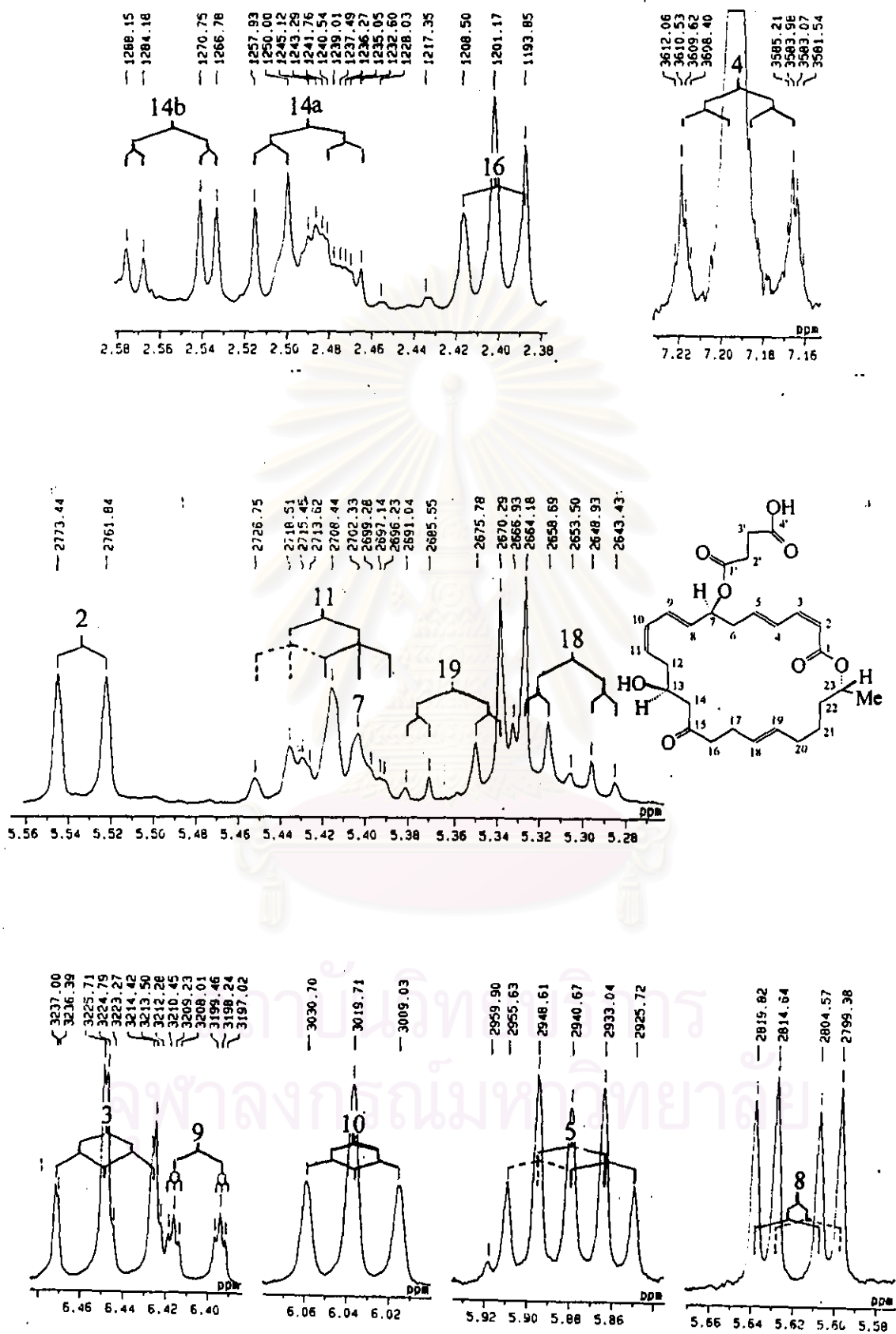


Figure 139. The 500 MHz  $^1\text{H}$  NMR spectrum of 7-O-succinyl macrolactin F (P129) (in  $\text{CDCl}_3$ ) (expanded from 2.38-7.22 ppm)

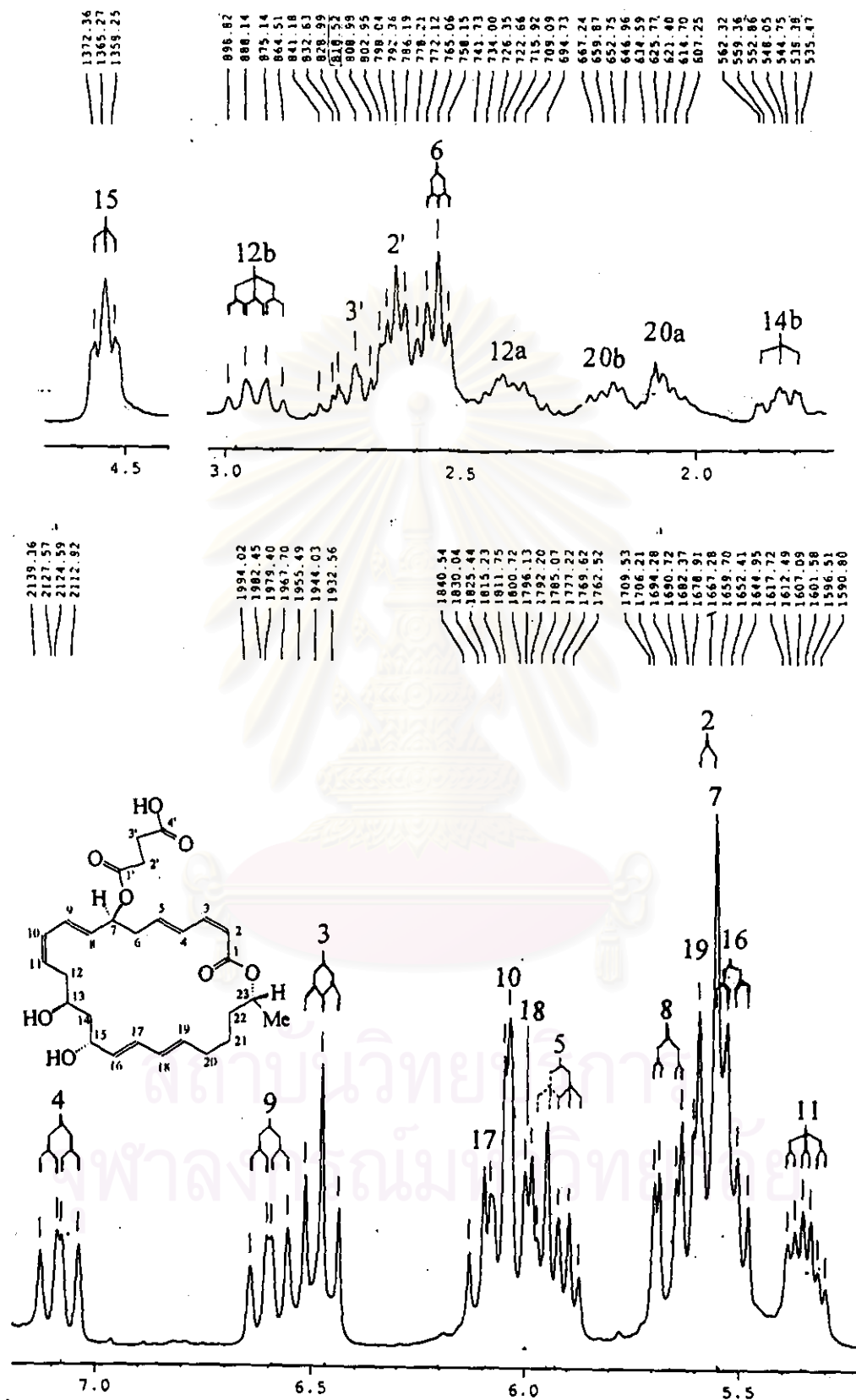


Figure 140. The 300 MHz  $^1\text{H}$  NMR spectrum of 7-O-succinyl macrolactin A (P103) (in  $\text{CDCl}_3$ ) (expanded from 1.70-7.20 ppm)

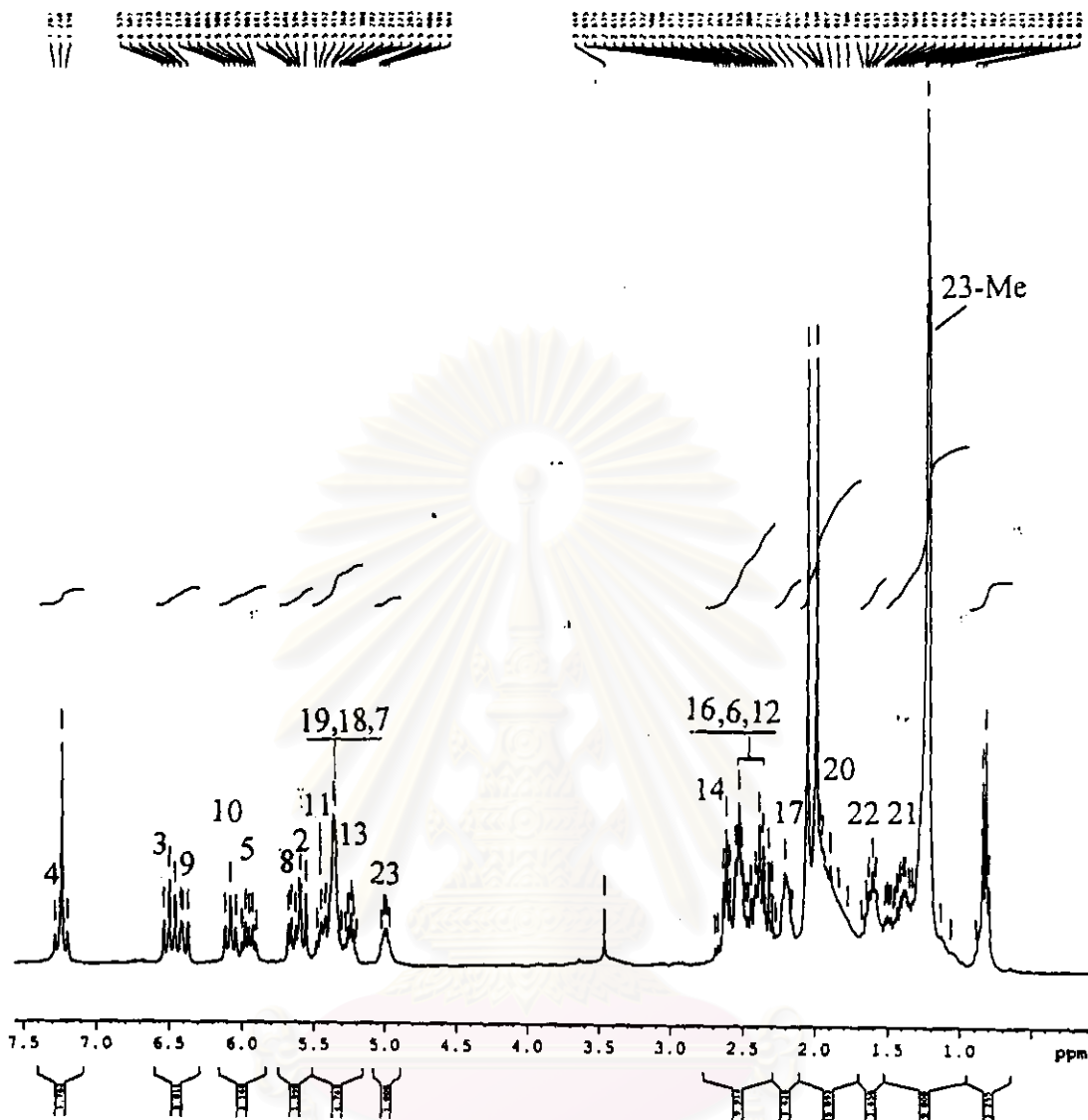


Figure 141. The 300 MHz  $^1\text{H}$  NMR spectrum of diacetylated derivative of macrolactin F (P035) (in  $\text{CDCl}_3$ )

สถาบันวิทยบริการ  
จุฬาลงกรณ์มหาวิทยาลัย



Figure 142. The 100 MHz  $^{13}\text{C}$  NMR spectrum of macrolactin F (P035) (in  $\text{CDCl}_3$ )

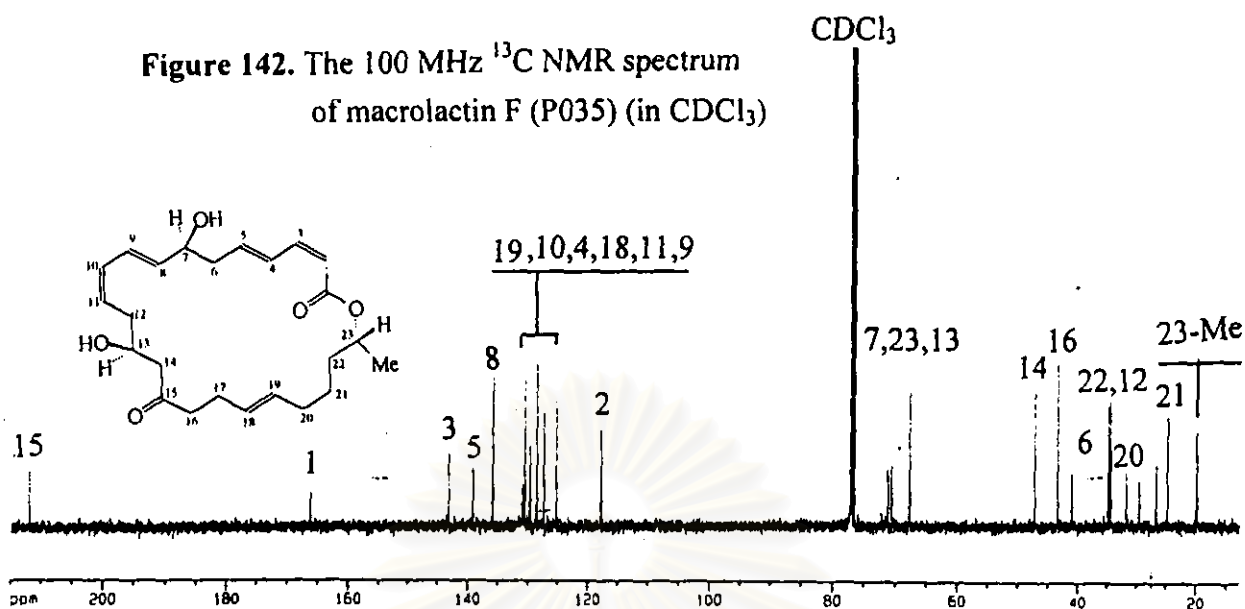


Figure 143. The 75 MHz  $^{13}\text{C}$  NMR spectrum of 7-O-succinyl macrolactin F (P129) (in  $\text{CDCl}_3$ )

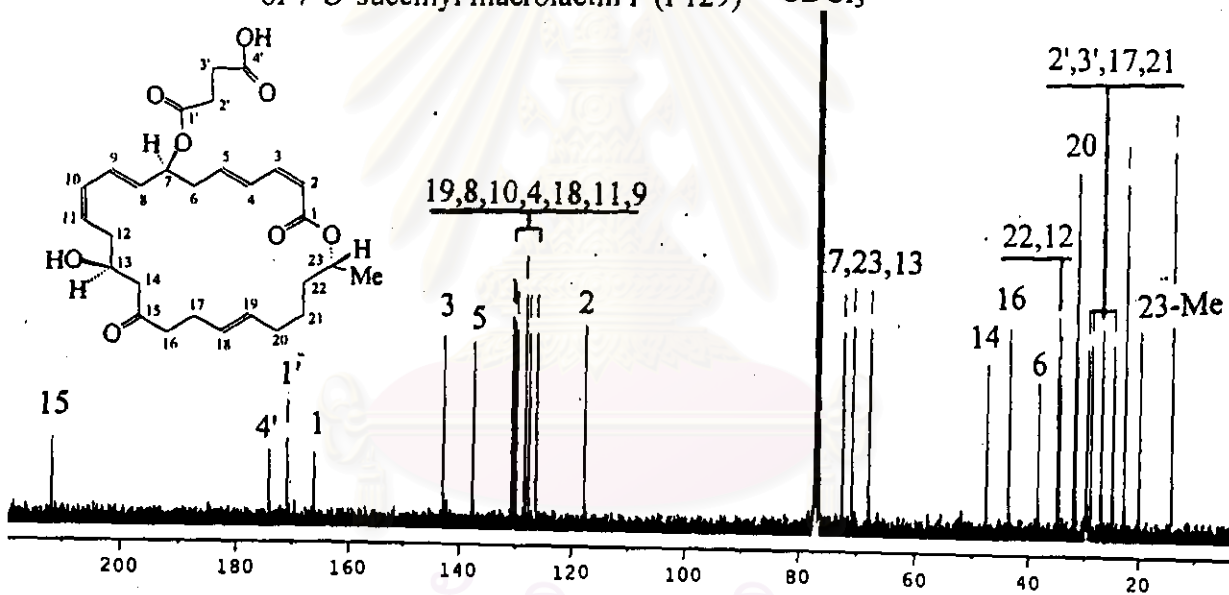
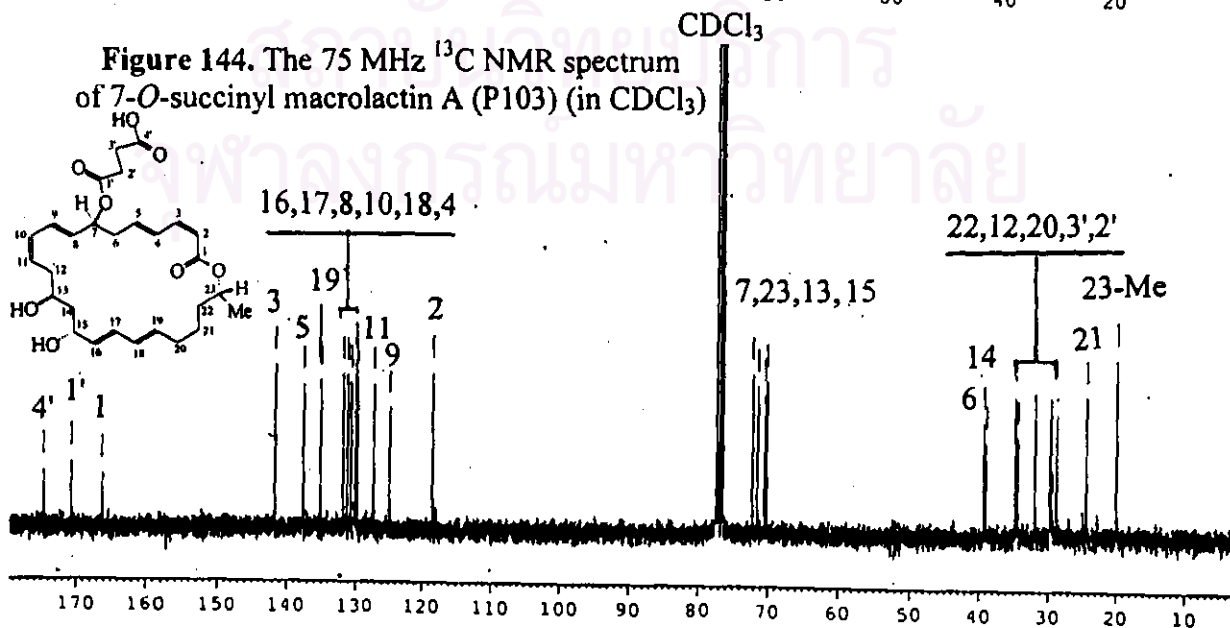
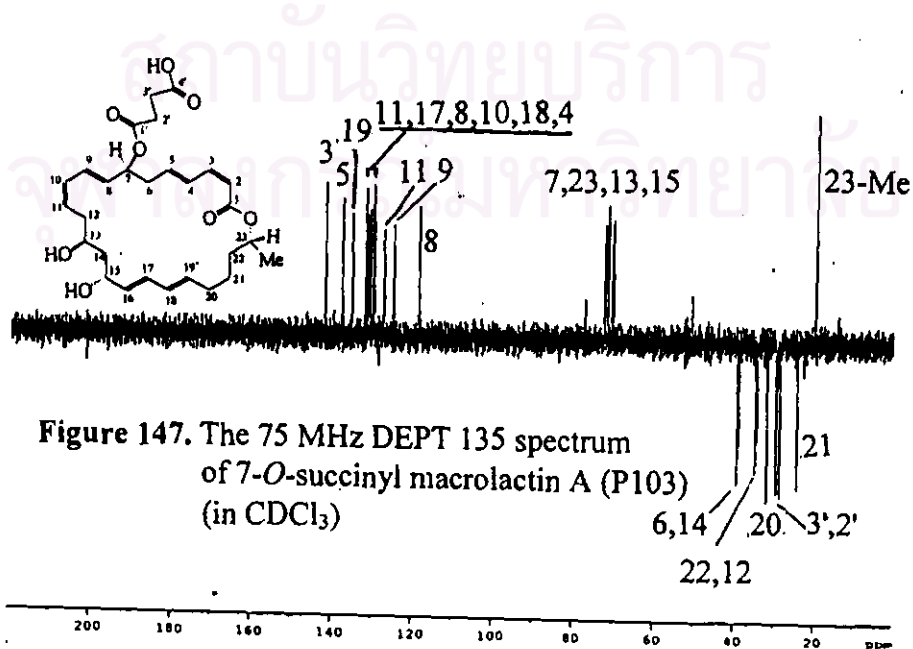
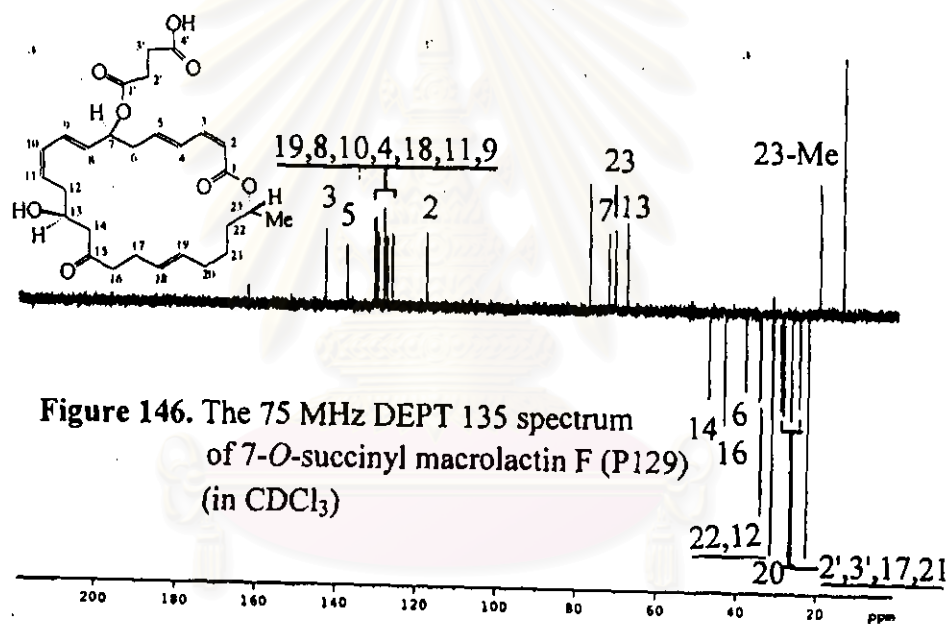
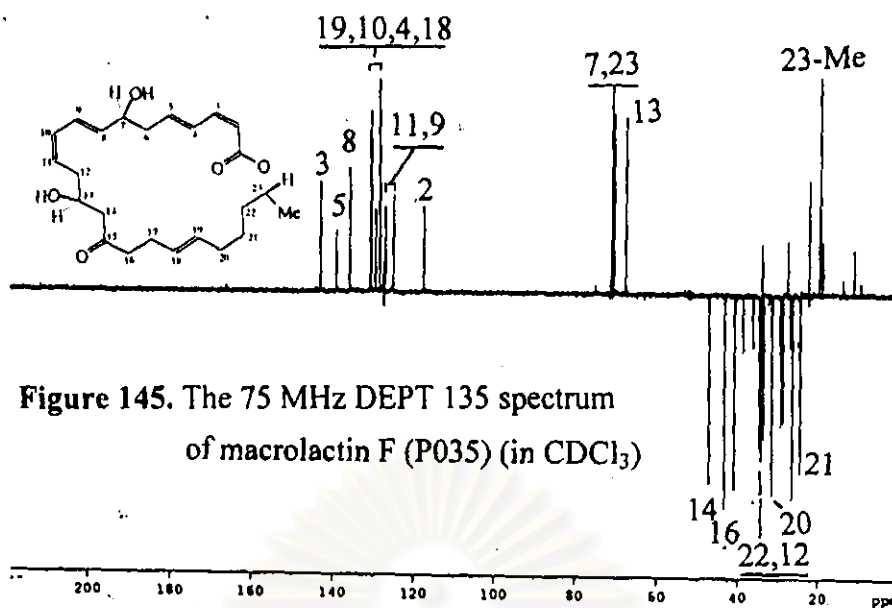


Figure 144. The 75 MHz  $^{13}\text{C}$  NMR spectrum of 7-O-succinyl macrolactin A (P103) (in  $\text{CDCl}_3$ )





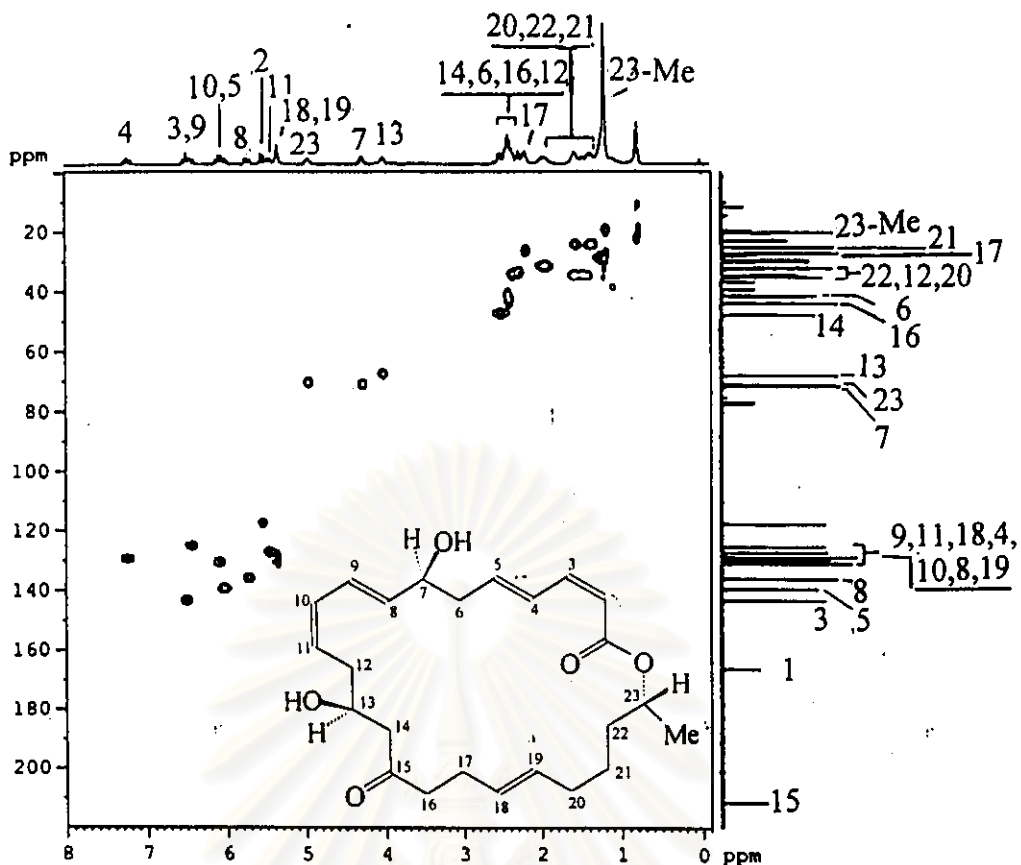


Figure 148. The 300 MHz HMQC spectrum of macrolactin F (P035) (in CDCl<sub>3</sub>)

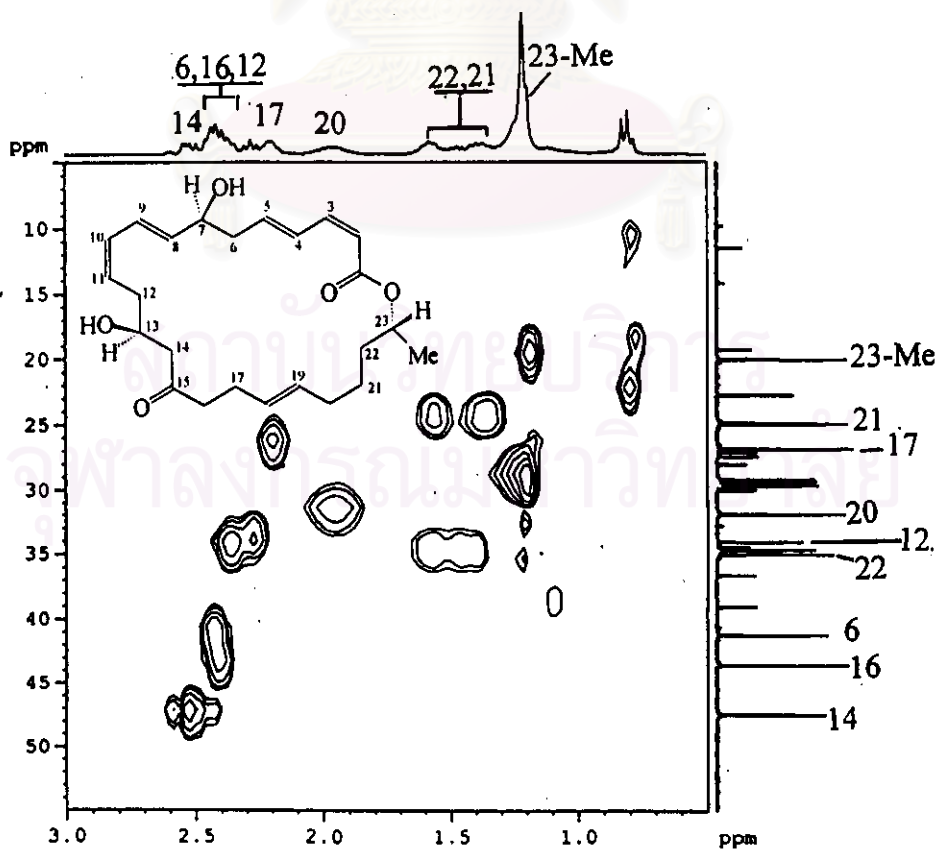
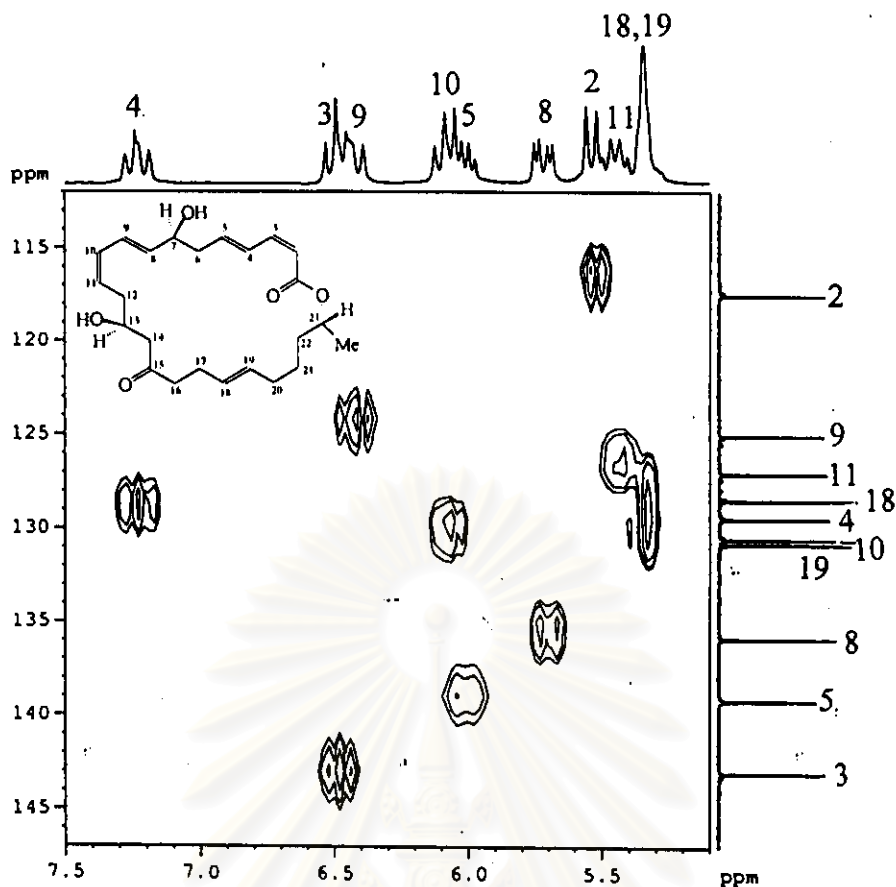
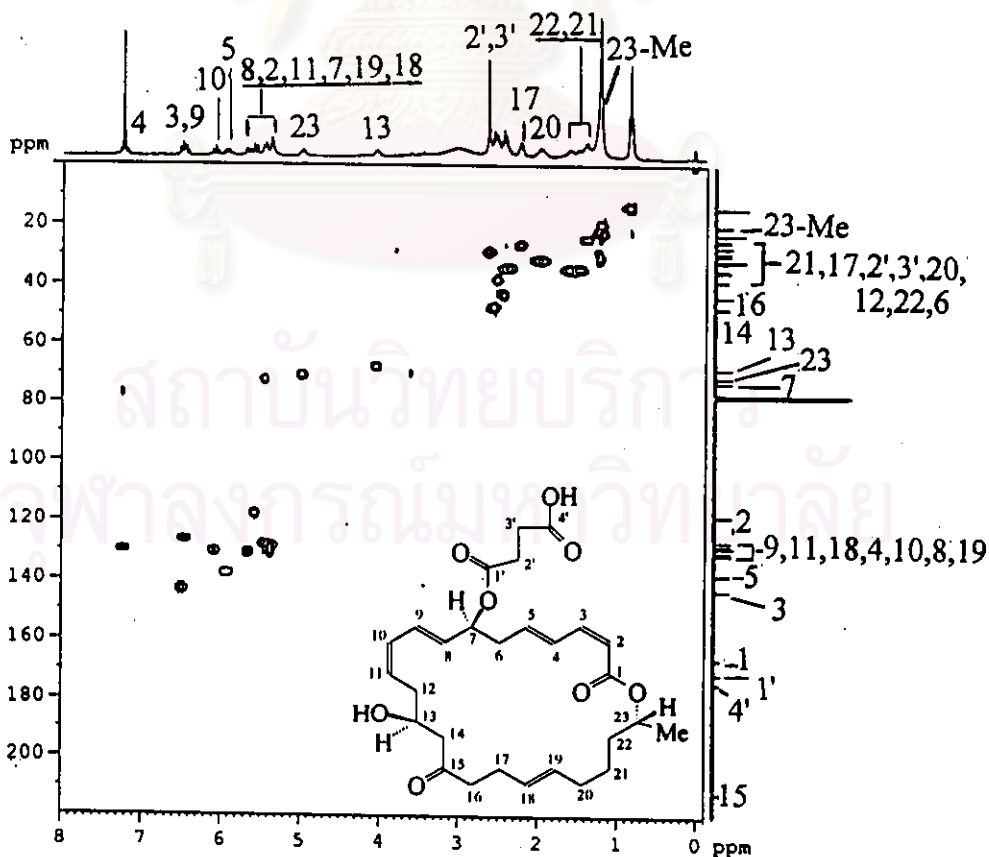


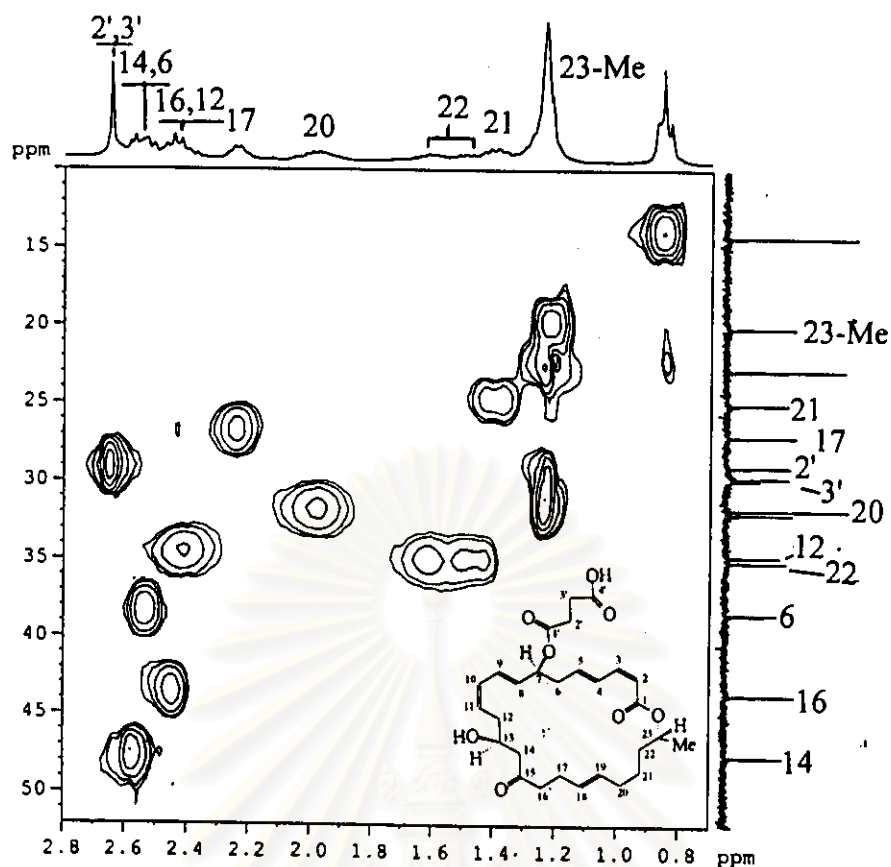
Figure 149. The 300 MHz HMQC spectrum of macrolactin F (P035) (in CDCl<sub>3</sub>) (expanded from 0-3.0 ppm)



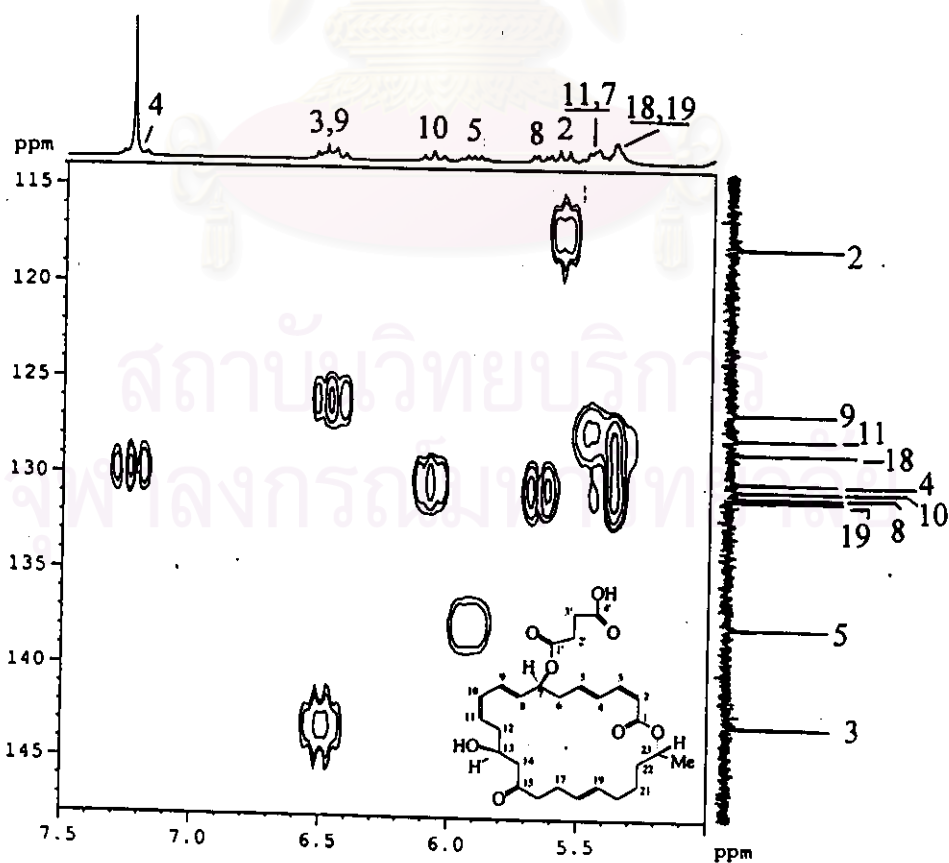
**Figure 150.** The 300 MHz HMQC spectrum of macrolactin F (P035) (in CDCl<sub>3</sub>) (expanded from 5.0-7.5 ppm)



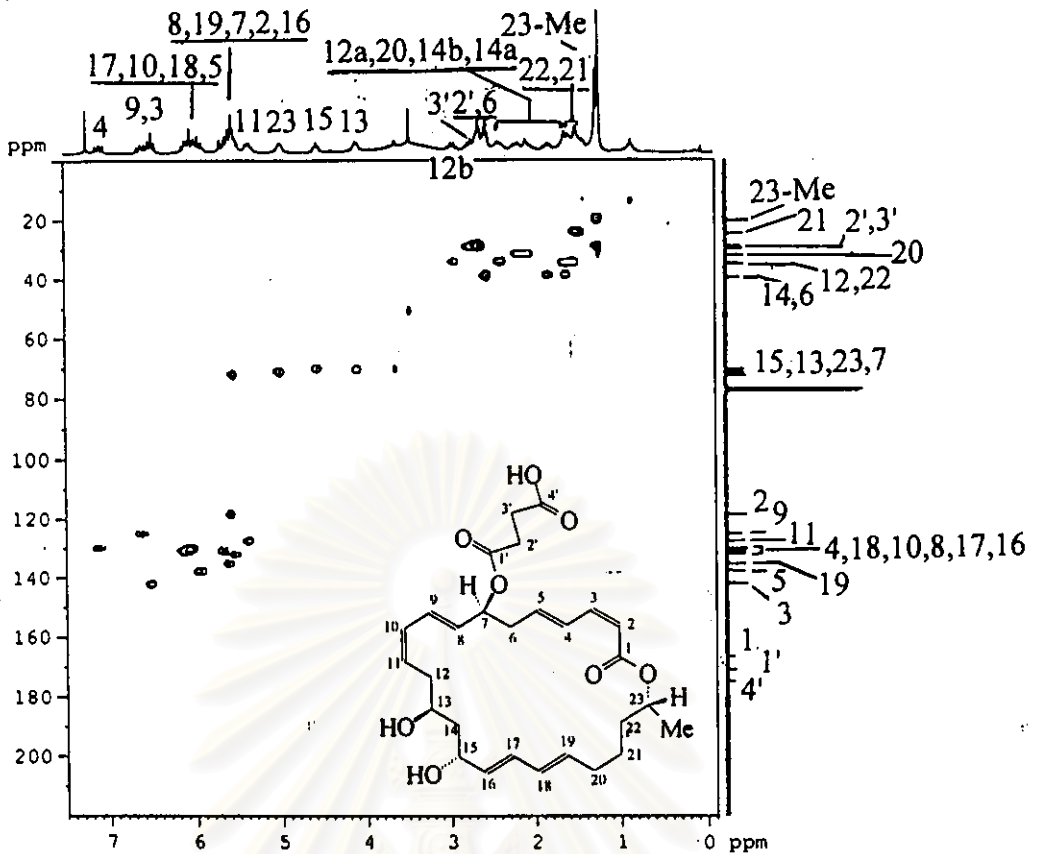
**Figure 151.** The 300 MHz HMQC spectrum of 7-O-succinyl macrolactin F (P129) (in CDCl<sub>3</sub>)



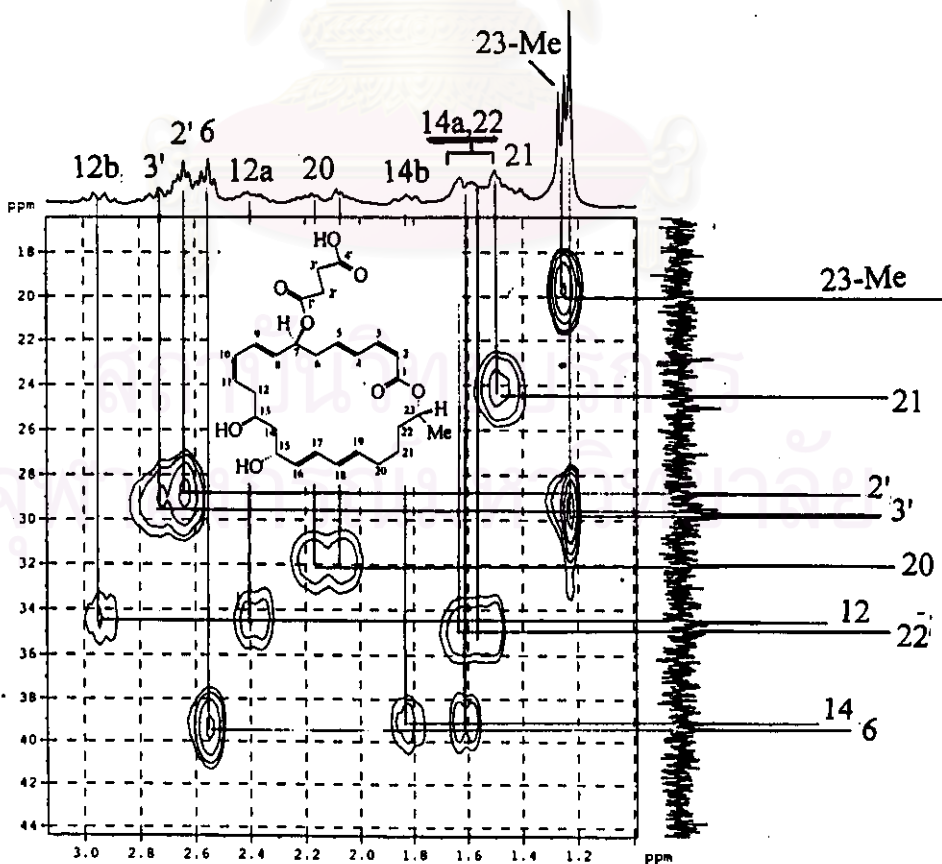
**Figure 152.** The 300 MHz HMQC spectrum of 7-O-succinyl macrolactin F (P129) (in CDCl<sub>3</sub>) (expanded from 0.7-2.8 ppm)



**Figure 153.** The 300 MHz HMQC spectrum of 7-O-succinyl macrolactin F (P129) (in CDCl<sub>3</sub>) (expanded from 5.0-7.5 ppm)



**Figure 154.** The 300 MHz HMQC spectrum of 7-*O*-succinyl macrolactin A (P103) (in CDCl<sub>3</sub>)



**Figure 155.** The 300 MHz HMQC spectrum of 7-*O*-succinyl macrolactin A (P103) (in CDCl<sub>3</sub>) (expanded from 1.0-3.1 ppm)

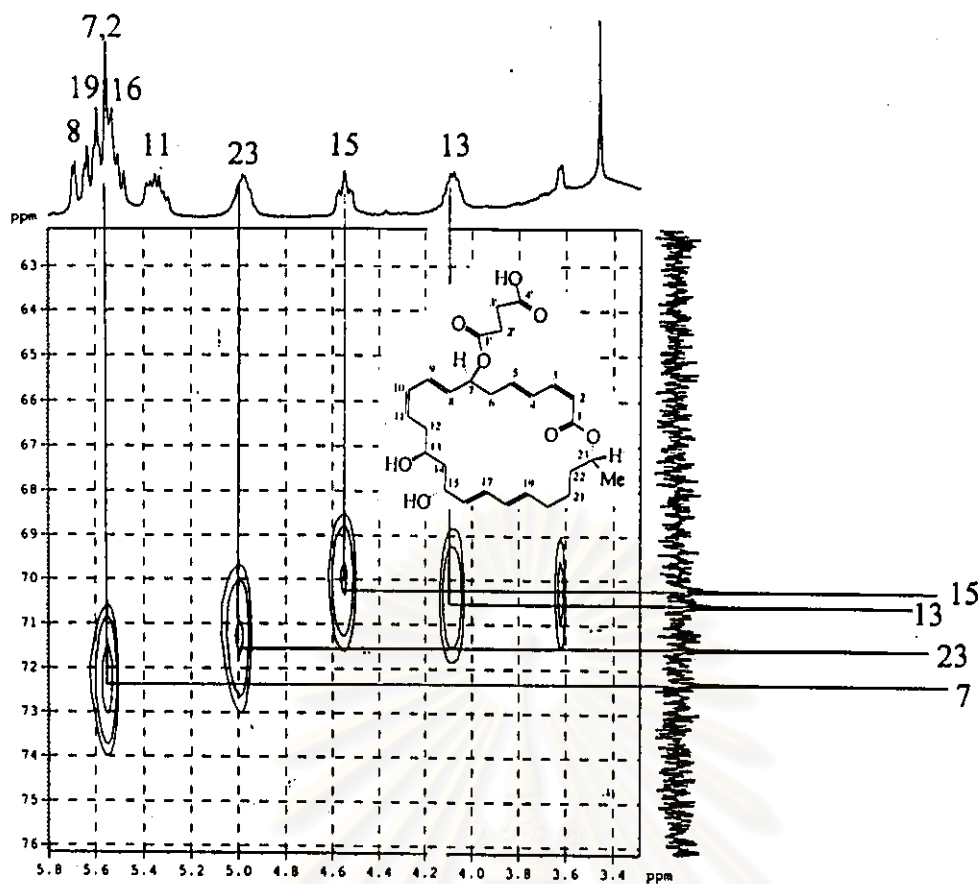


Figure 156. The 300 MHz HMQC spectrum of 7-*O*-succinyl macrolactin A (P103) (in CDCl<sub>3</sub>) (expanded from 3.2-5.8 ppm)

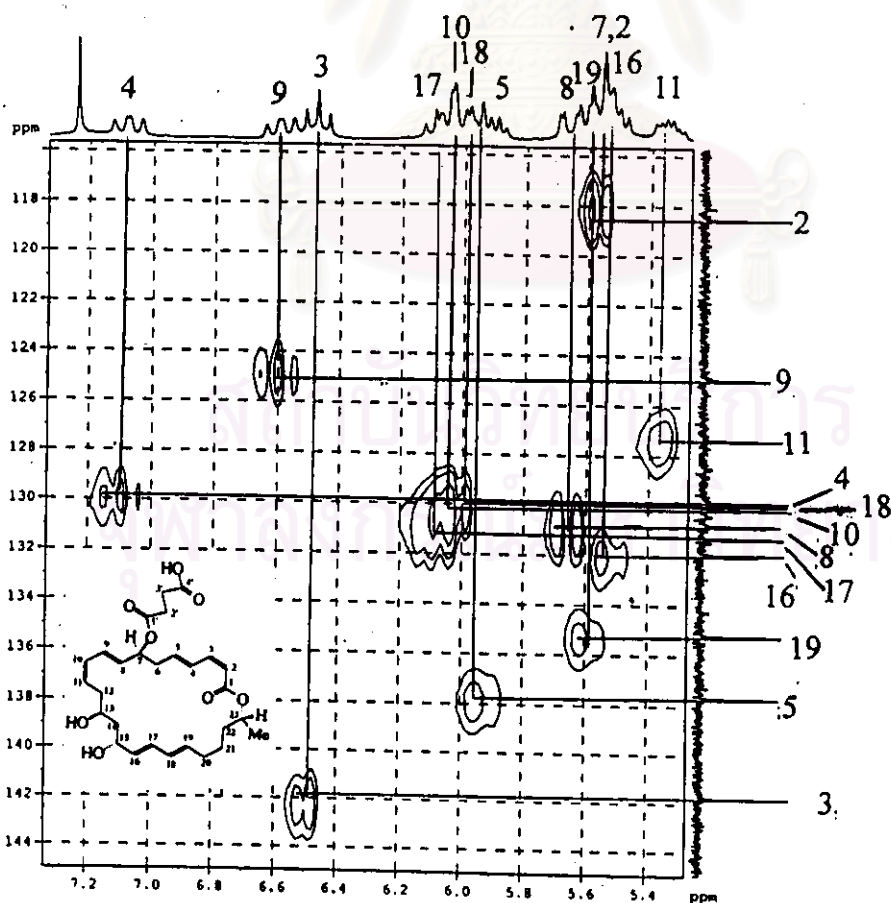


Figure 157. The 300 MHz HMQC spectrum of 7-*O*-succinyl macrolactin A (P103) (in CDCl<sub>3</sub>) (expanded from 5.3-7.3 ppm)



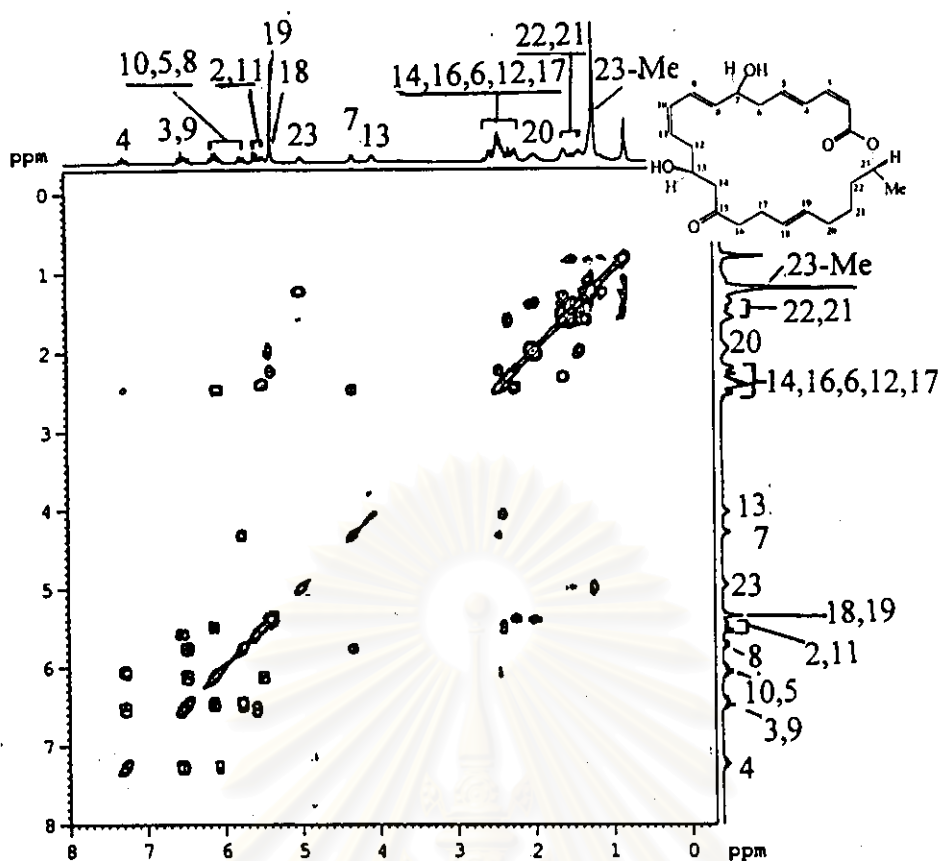


Figure 158. The 300 MHz  $^1\text{H}$ - $^1\text{H}$  COSY spectrum of macrolactin F (P035) (in  $\text{CDCl}_3$ )

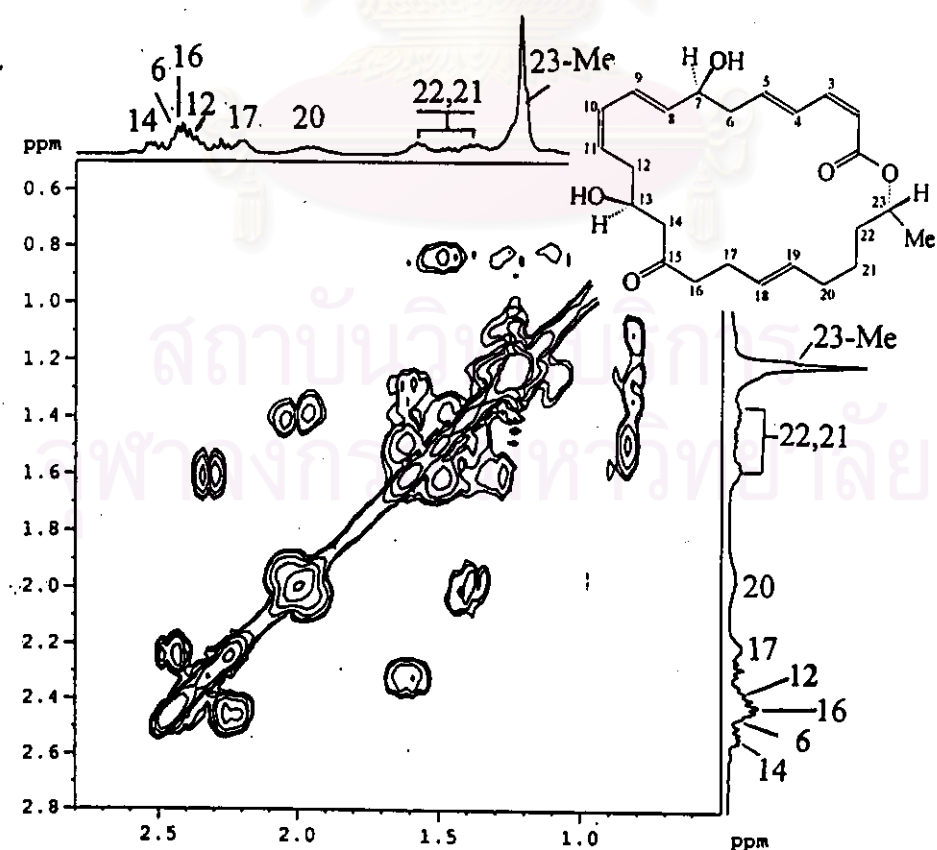


Figure 159. The 300 MHz  $^1\text{H}$ - $^1\text{H}$  COSY spectrum of macrolactin F (P035) (in  $\text{CDCl}_3$ ) (expanded from 0.5-2.8 ppm)

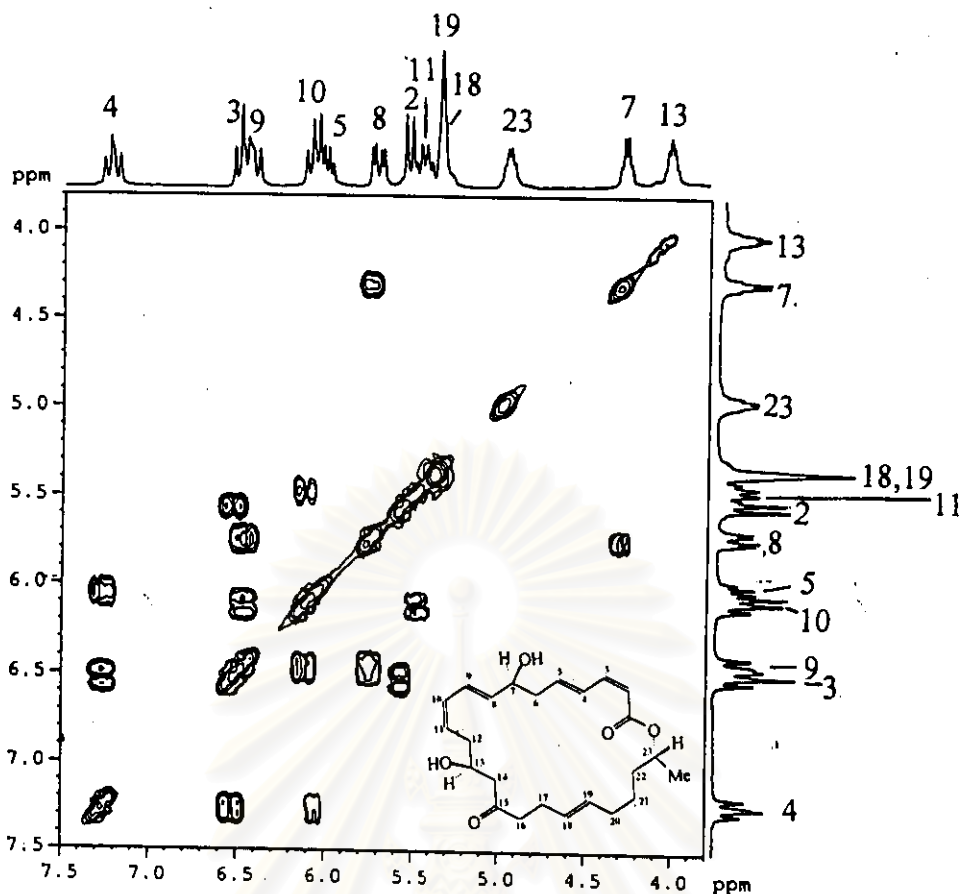


Figure 160. The 300 MHz  $^1\text{H}$ - $^1\text{H}$  COSY spectrum of macrolactin F (P035) (in  $\text{CDCl}_3$ ) (expanded from 3.8-7.5 ppm)

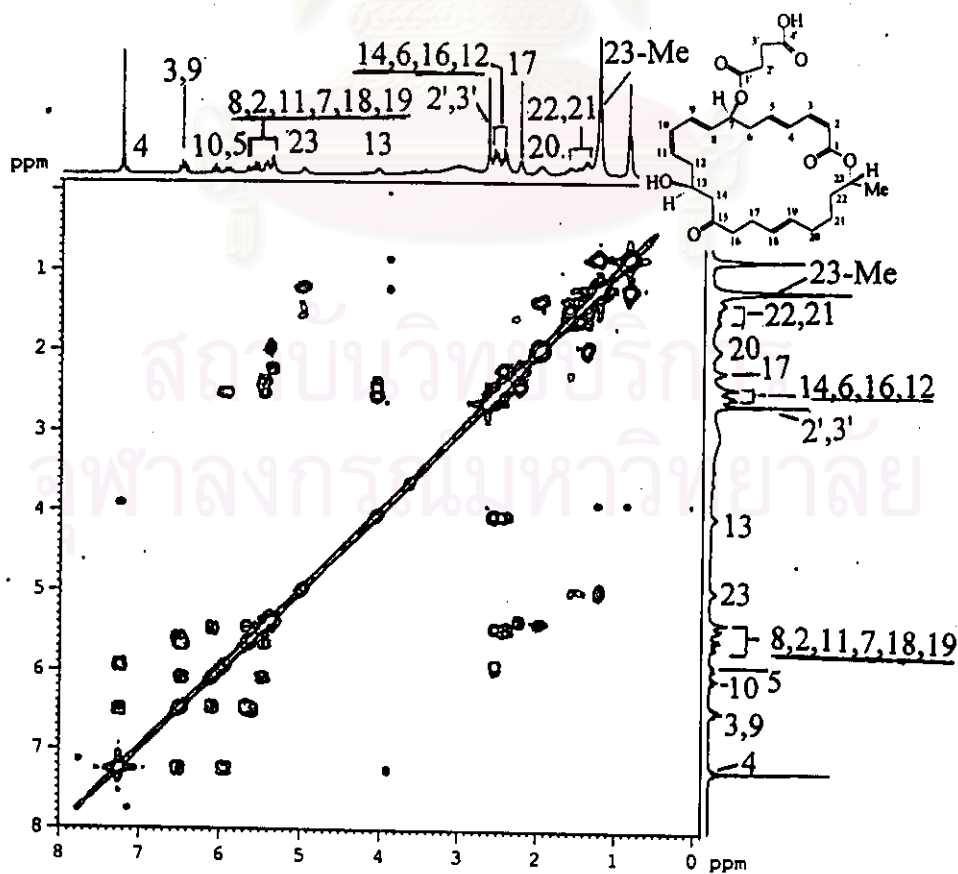
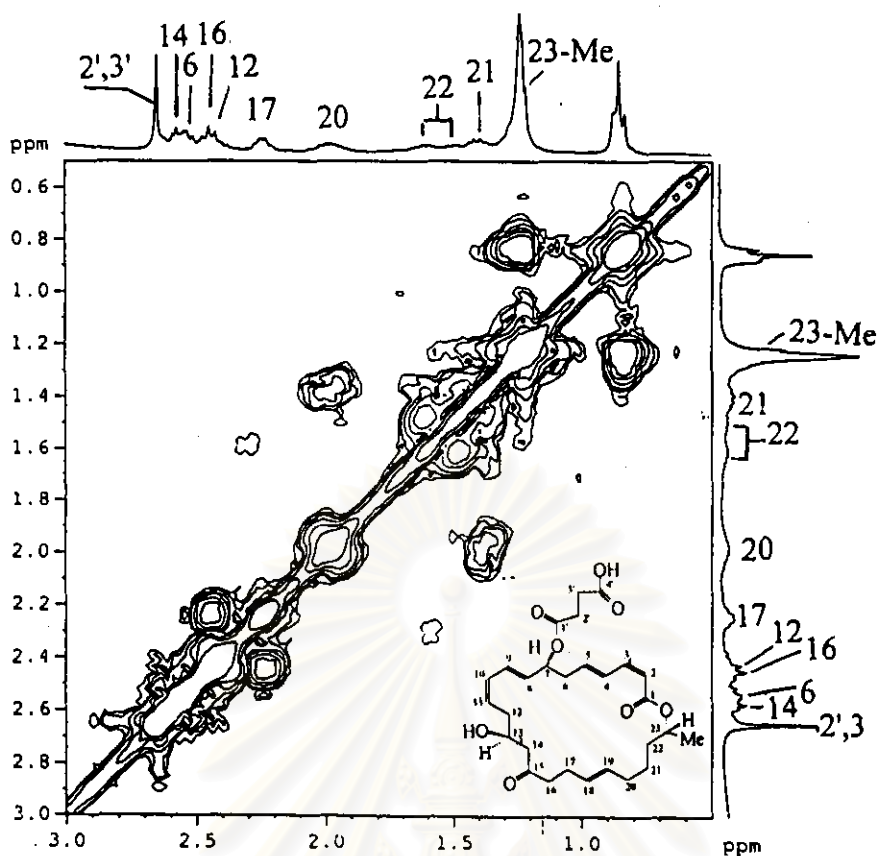
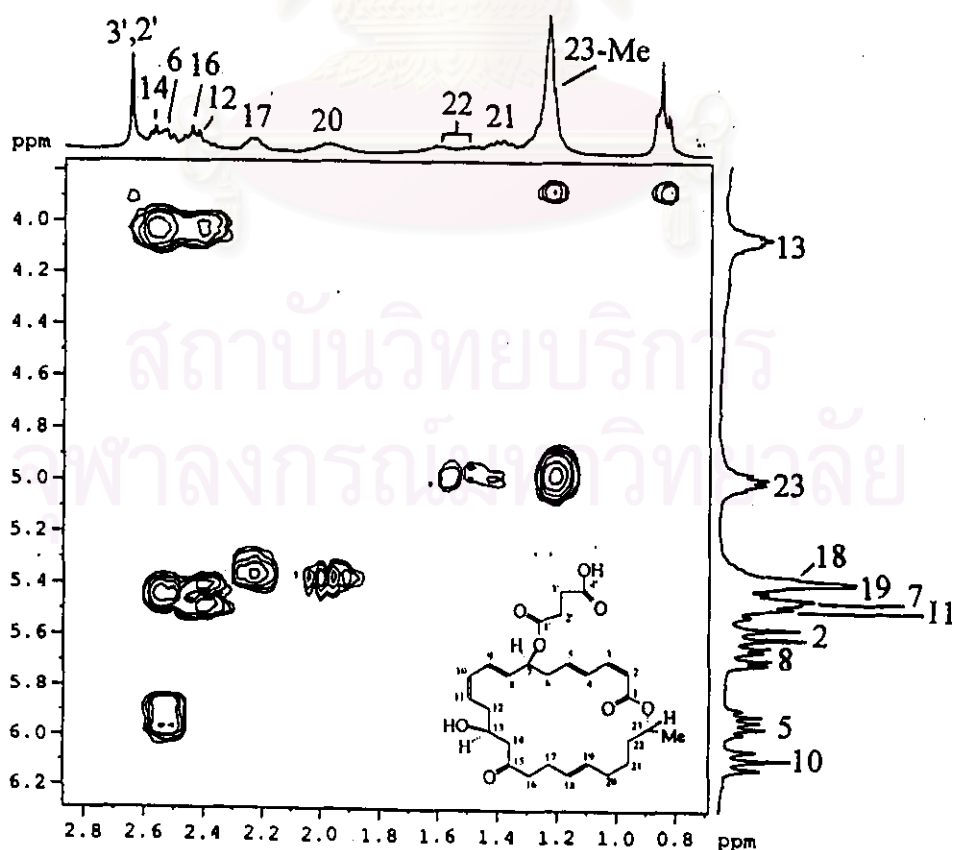


Figure 161. The 300 MHz  $^1\text{H}$ - $^1\text{H}$  COSY spectrum of 7-O-succinyl macrolactin F (P129) (in  $\text{CDCl}_3$ )



**Figure 162.** The 300 MHz  $^1\text{H}$ - $^1\text{H}$  COSY spectrum of 7-*O*-succinyl macrolactin F (P129) (in  $\text{CDCl}_3$ ) (expanded from 0.5-3.0 ppm)



**Figure 163.** The 300 MHz  $^1\text{H}$ - $^1\text{H}$  COSY spectrum of 7-*O*-succinyl macrolactin F (P129) (in  $\text{CDCl}_3$ ) (expanded from 0.7-2.8 ppm)

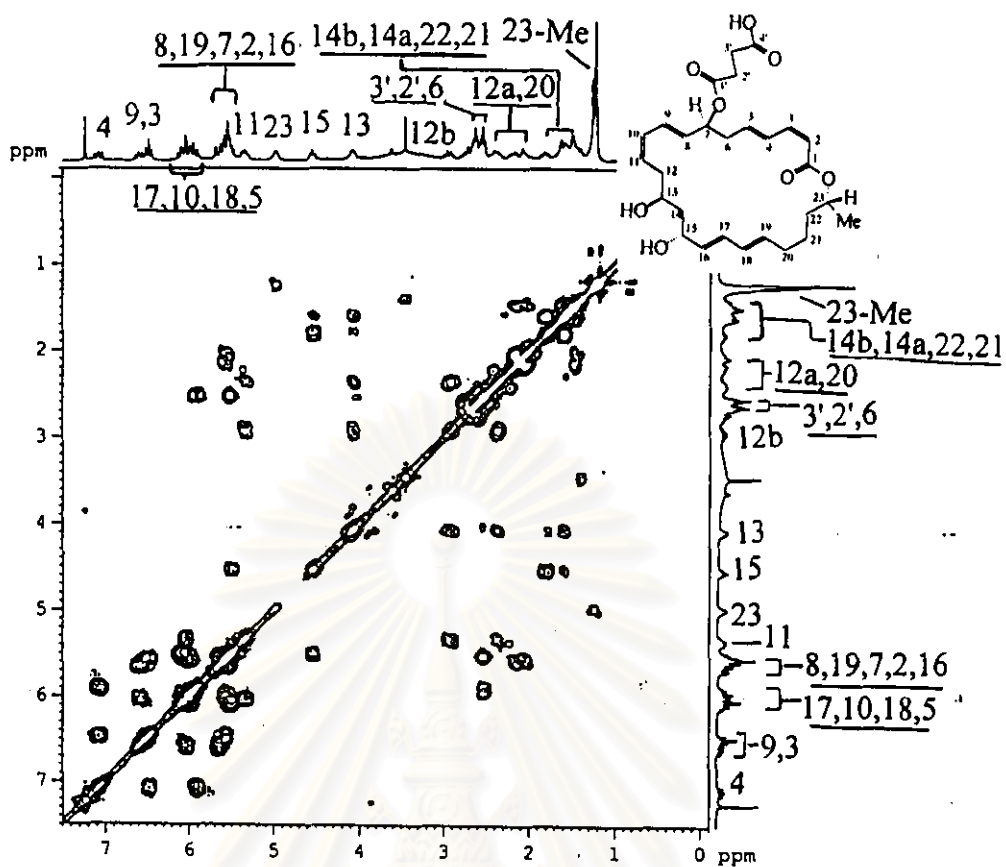


Figure 164. The 300 MHz  $^1\text{H}$ - $^1\text{H}$  COSY spectrum of 7-*O*-succinyl macrolactin A (P103) (in  $\text{CDCl}_3$ )

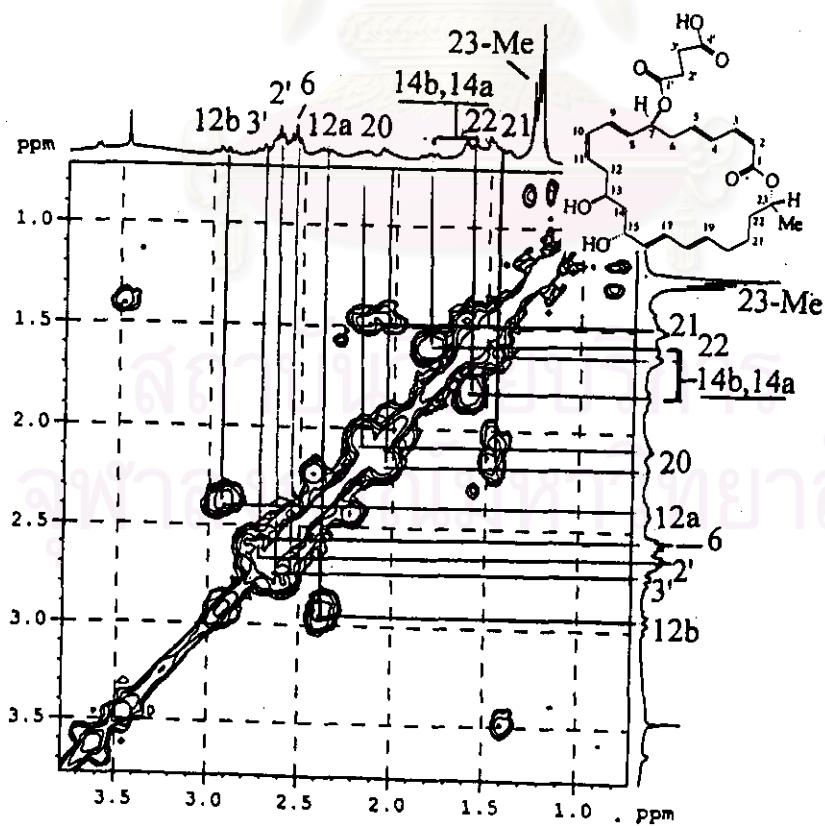


Figure 165. The 300 MHz  $^1\text{H}$ - $^1\text{H}$  COSY spectrum of 7-*O*-succinyl macrolactin A (P103) (in  $\text{CDCl}_3$ ) (expanded from 0.7-3.8 ppm)

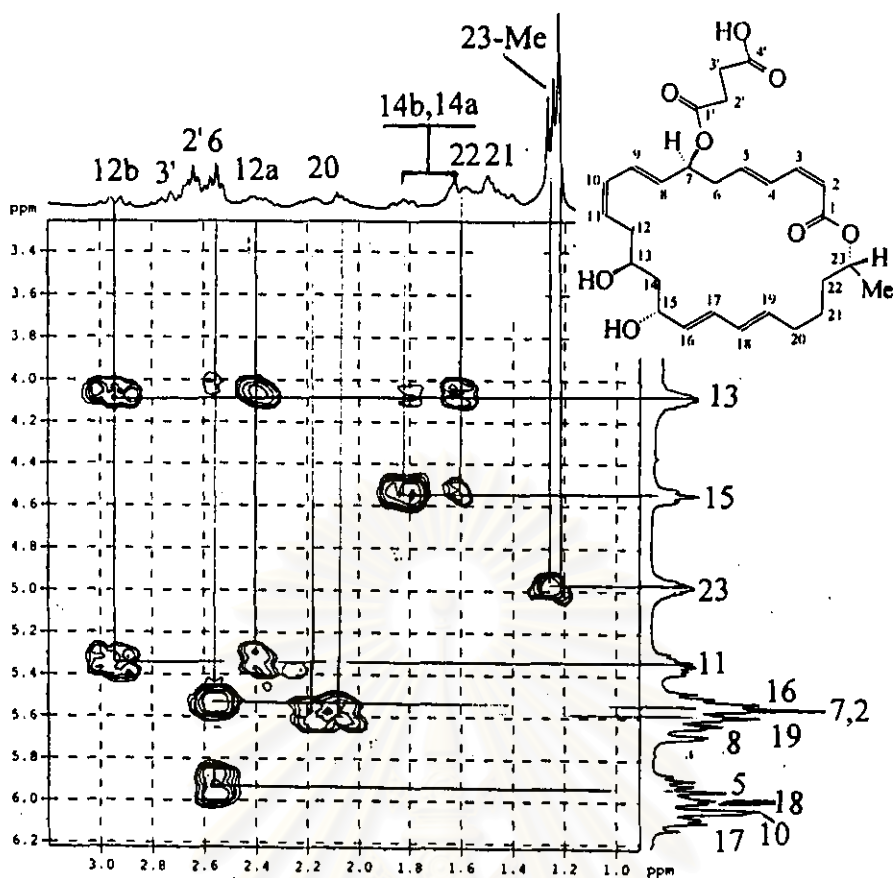


Figure 166. The 300 MHz  $^1\text{H}$ - $^1\text{H}$  COSY spectrum of 7-*O*-succinyl macrolactin A (P103) (in  $\text{CDCl}_3$ ) (expanded from 0.9-3.2 ppm)

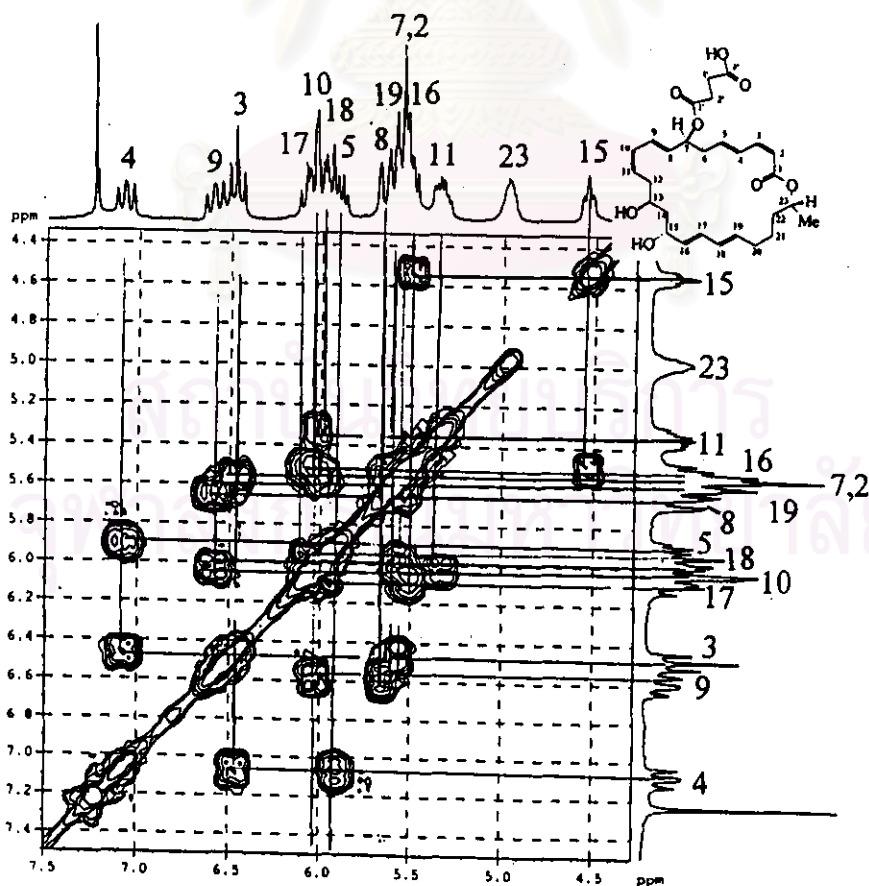


Figure 167. The 300 MHz  $^1\text{H}$ - $^1\text{H}$  COSY spectrum of 7-*O*-succinyl macrolactin A (P103) (in  $\text{CDCl}_3$ ) (expanded from 4.4-7.5 ppm)

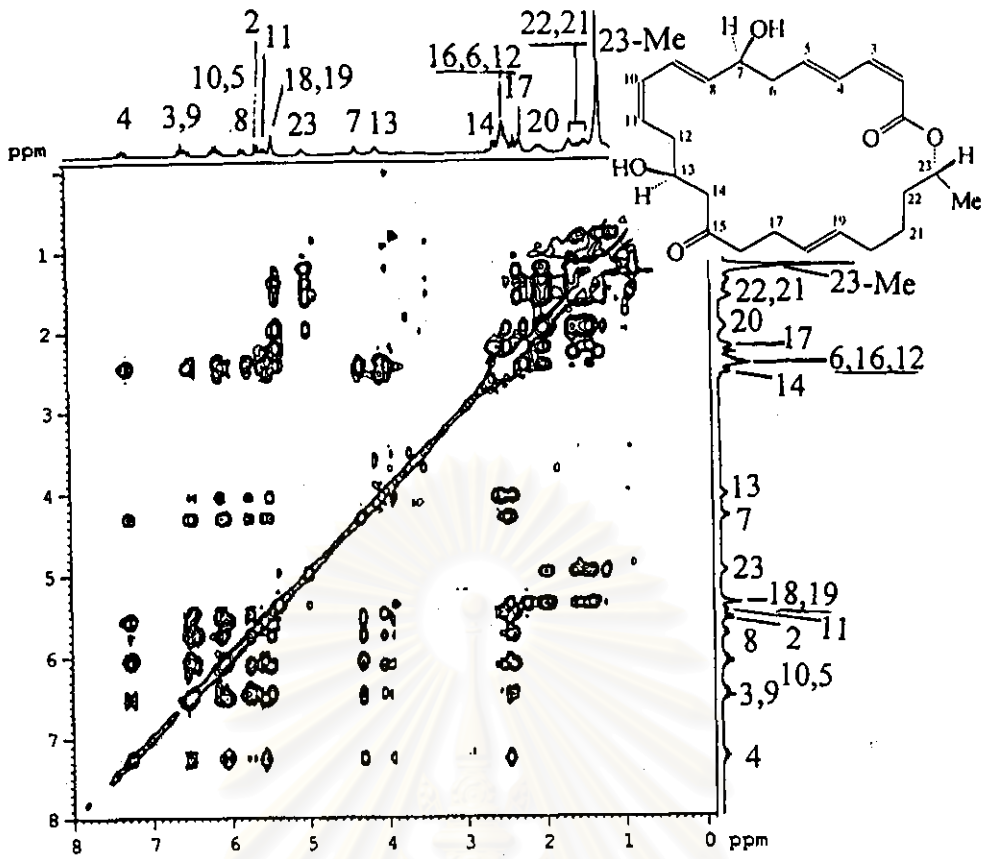


Figure 168. The 300 MHz TOCSY spectrum of macrolactin F (P035) (in  $\text{CDCl}_3$ )

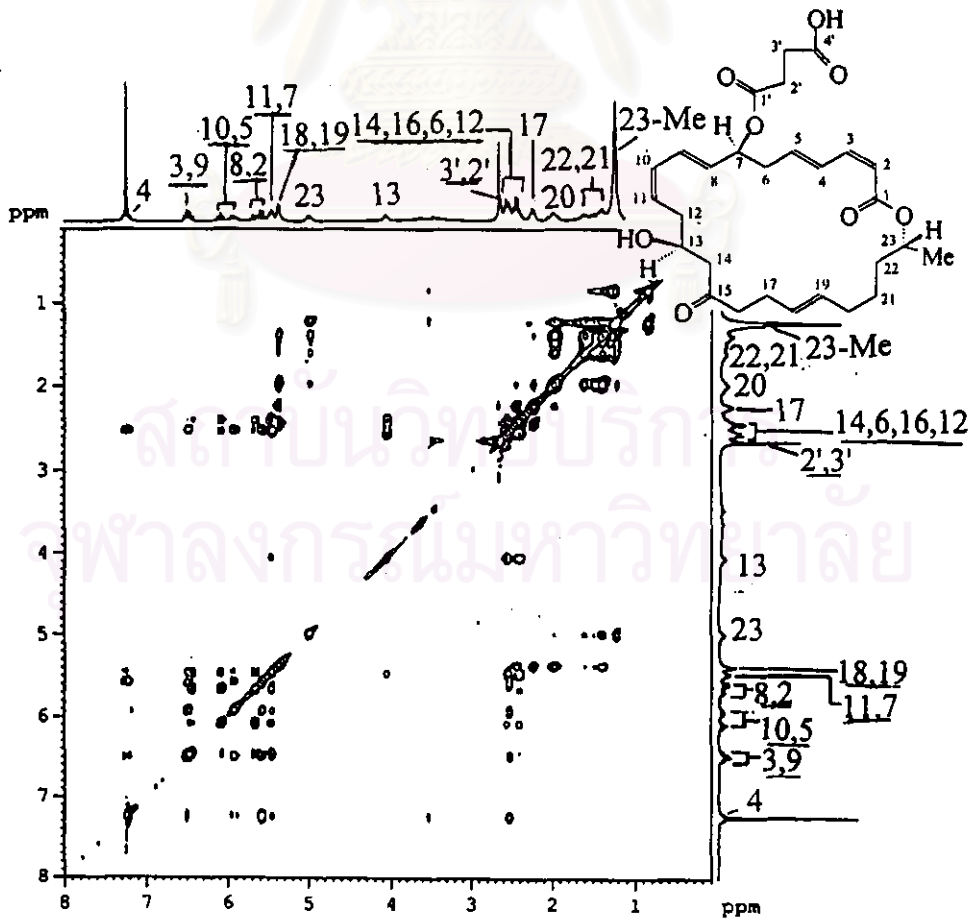


Figure 169. The 300 MHz TOCSY spectrum of 7-*O*-succinyl macrolactin F (P129) (in  $\text{CDCl}_3$ )



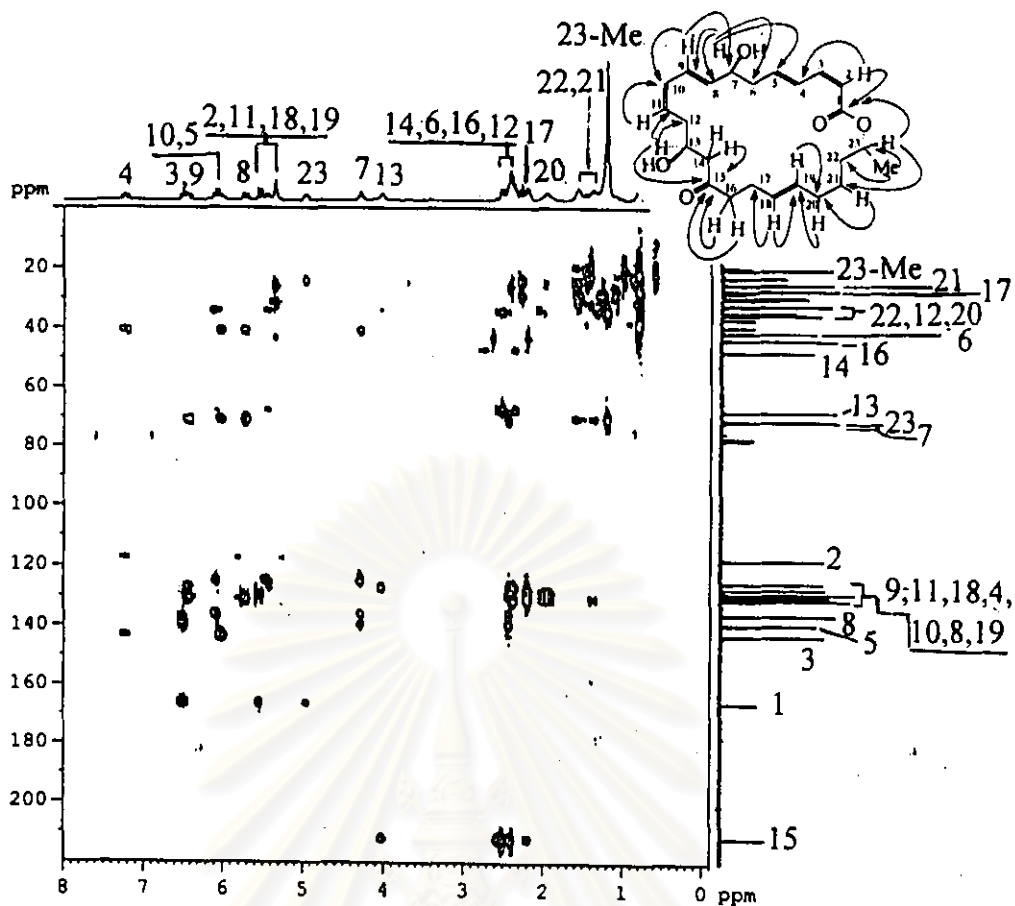


Figure 170. The 300 MHz HMBC spectrum ( $^nJ_{\text{HC}} = 8$  Hz) of macrolactin F (P035) (in  $\text{CDCl}_3$ )

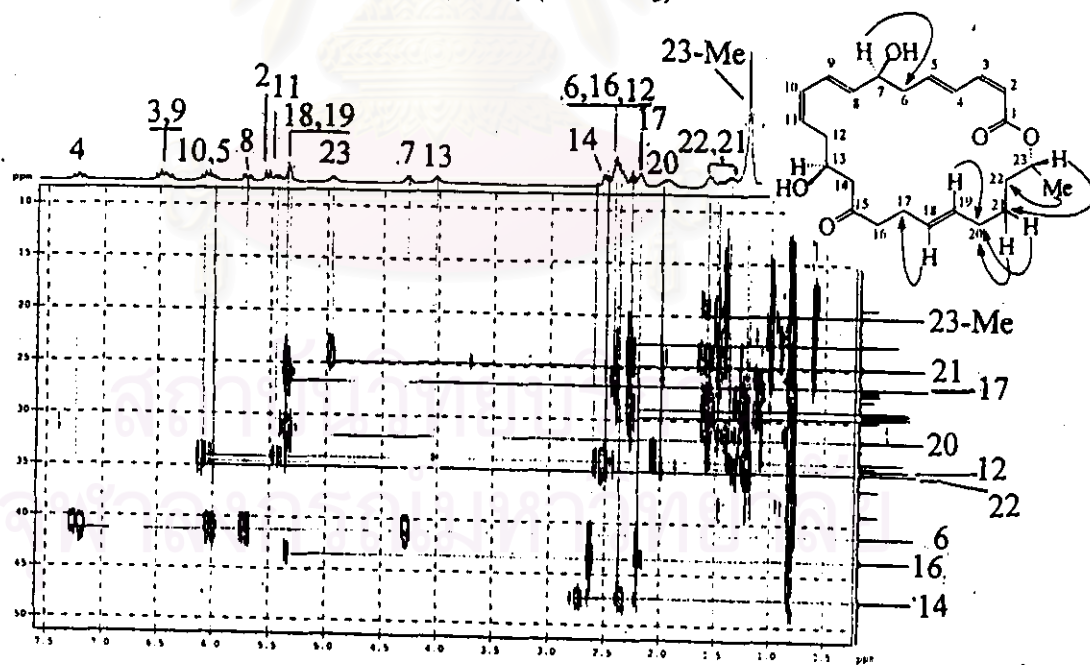


Figure 171. The 300 MHz HMBC spectrum ( $^nJ_{\text{HC}} = 8$  Hz) of macrolactin F (P035) (in  $\text{CDCl}_3$ ) (expanded from 10-50 ppm)



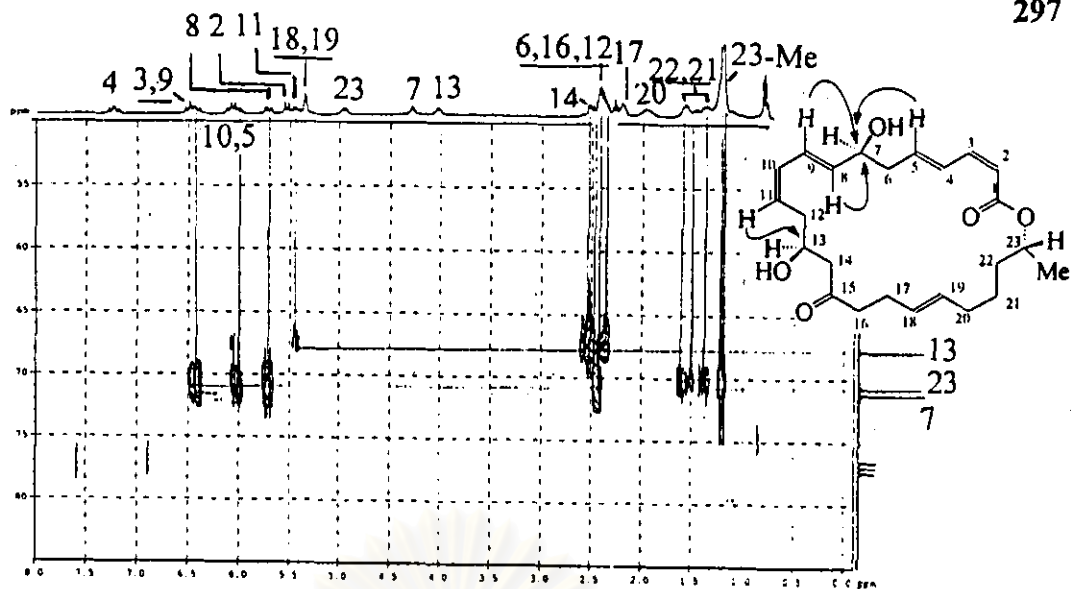


Figure 172. The 300 MHz HMBC spectrum ( $^nJ_{\text{HC}} = 8$  Hz) of macrolactin F (P035) (in  $\text{CDCl}_3$ ) (expanded from 50-85 ppm)

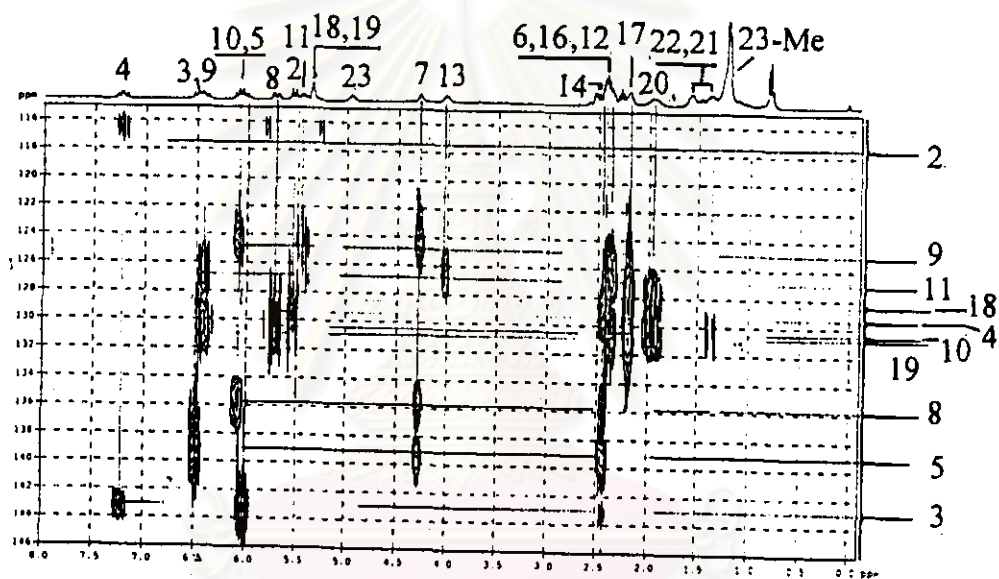


Figure 173. The 300 MHz HMBC spectrum ( $^nJ_{\text{HC}} = 8$  Hz) of macrolactin F (P035) (in  $\text{CDCl}_3$ ) (expanded from 116-146 ppm)

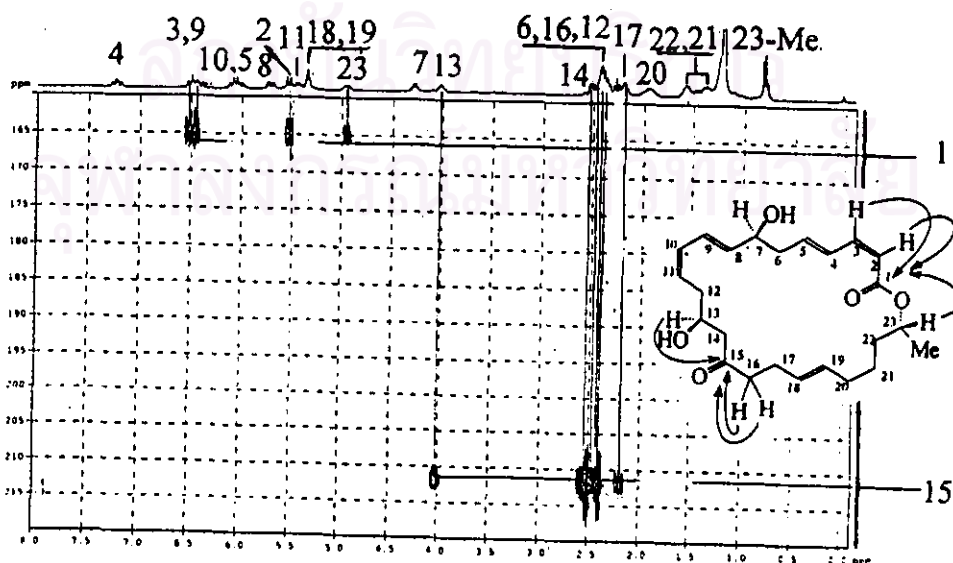
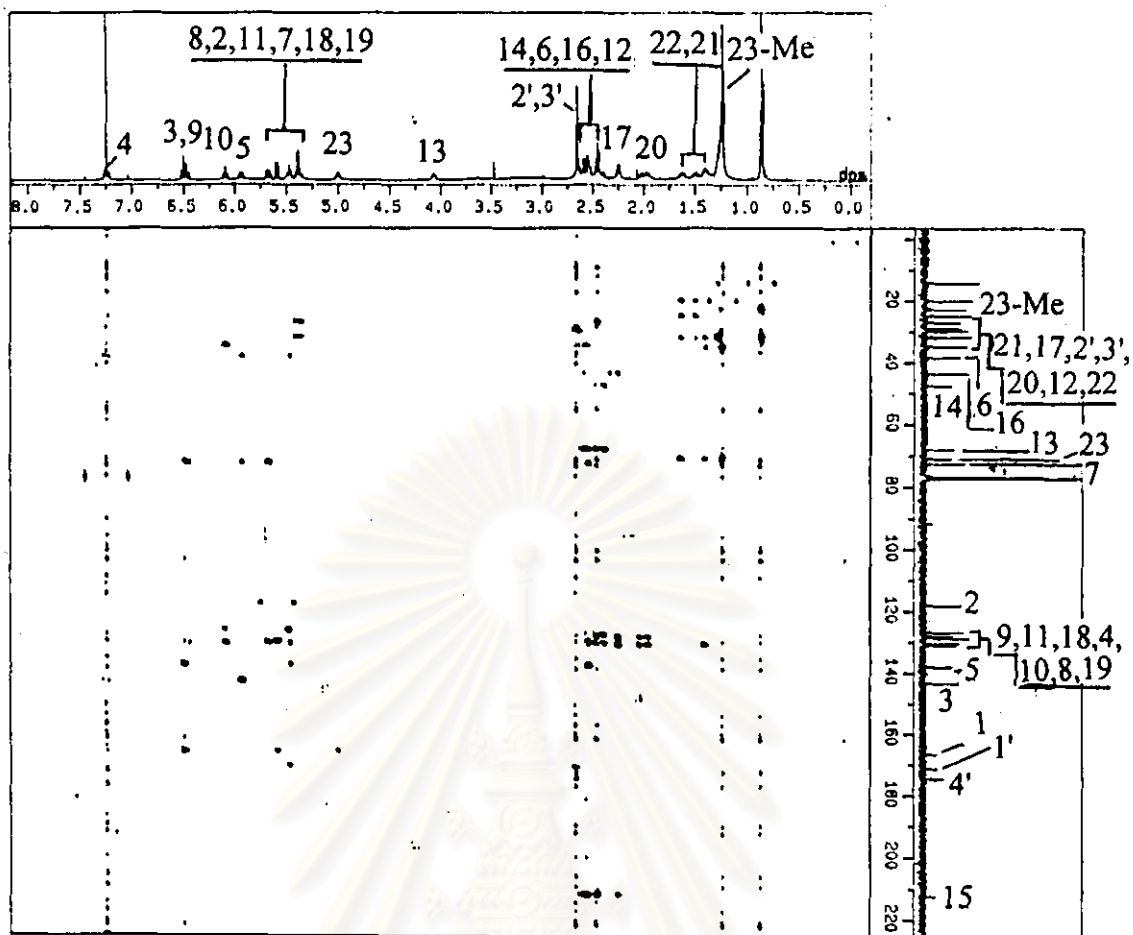
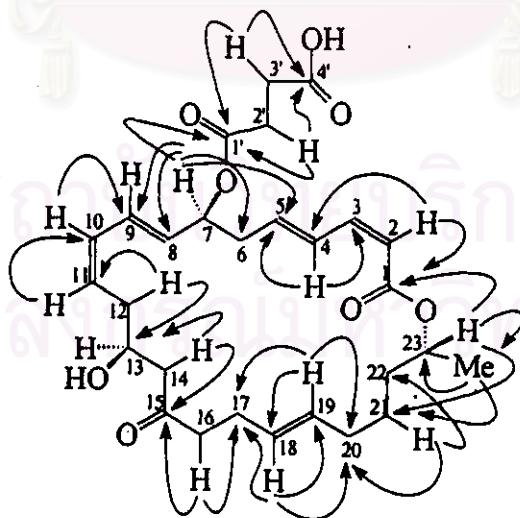
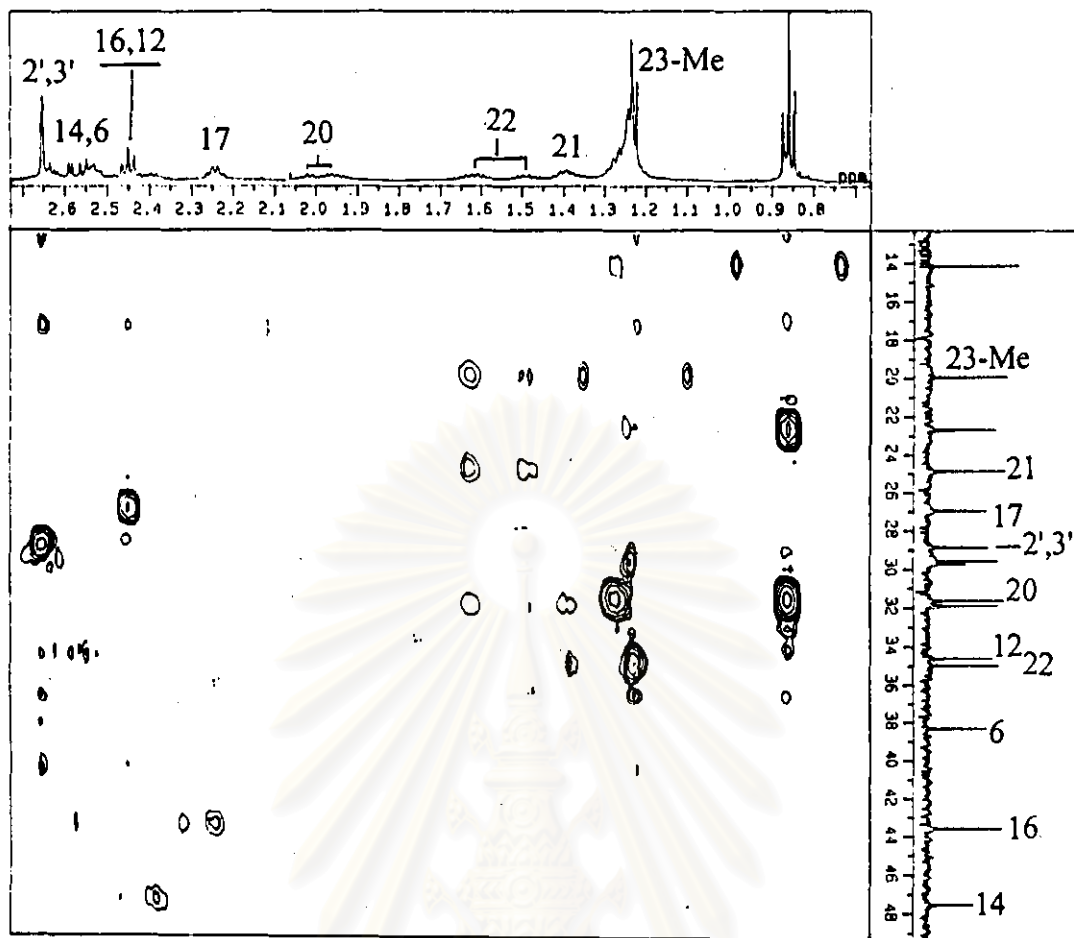


Figure 174. The 300 MHz HMBC spectrum ( $^nJ_{\text{HC}} = 8$  Hz) of macrolactin F (P035) (in  $\text{CDCl}_3$ ) (expanded from 160-220 ppm)

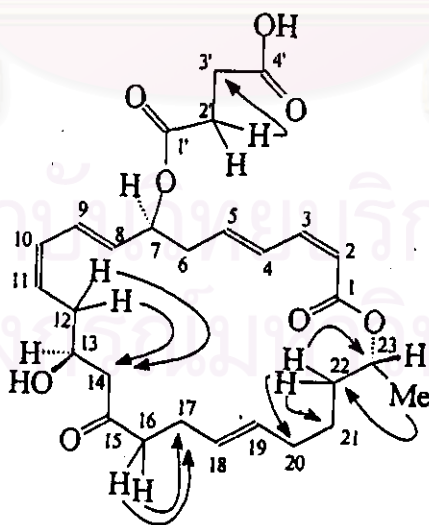


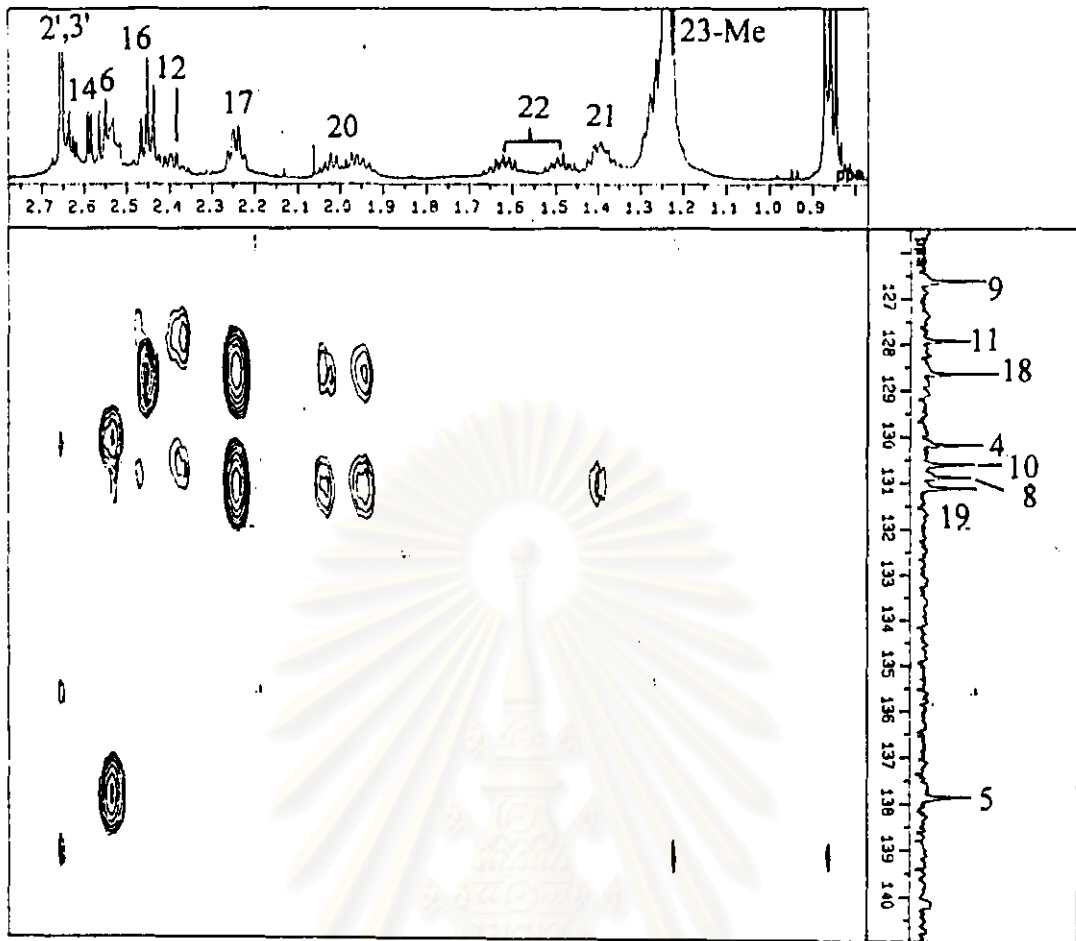
**Figure 175.** The 500 MHz HMBC spectrum ( $^nJ_{\text{HC}} = 8 \text{ Hz}$ ) of 7-O-succinyl macrolactin F (P129) (in CDCl<sub>3</sub>)



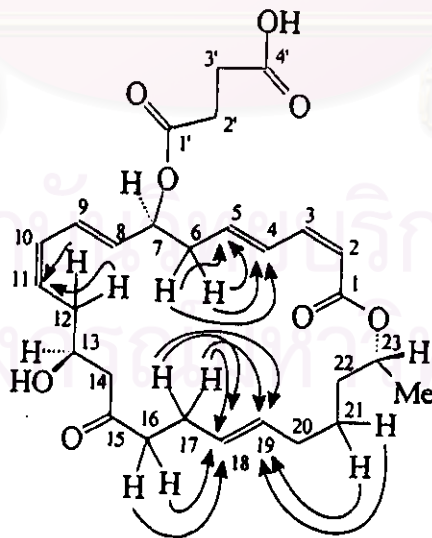


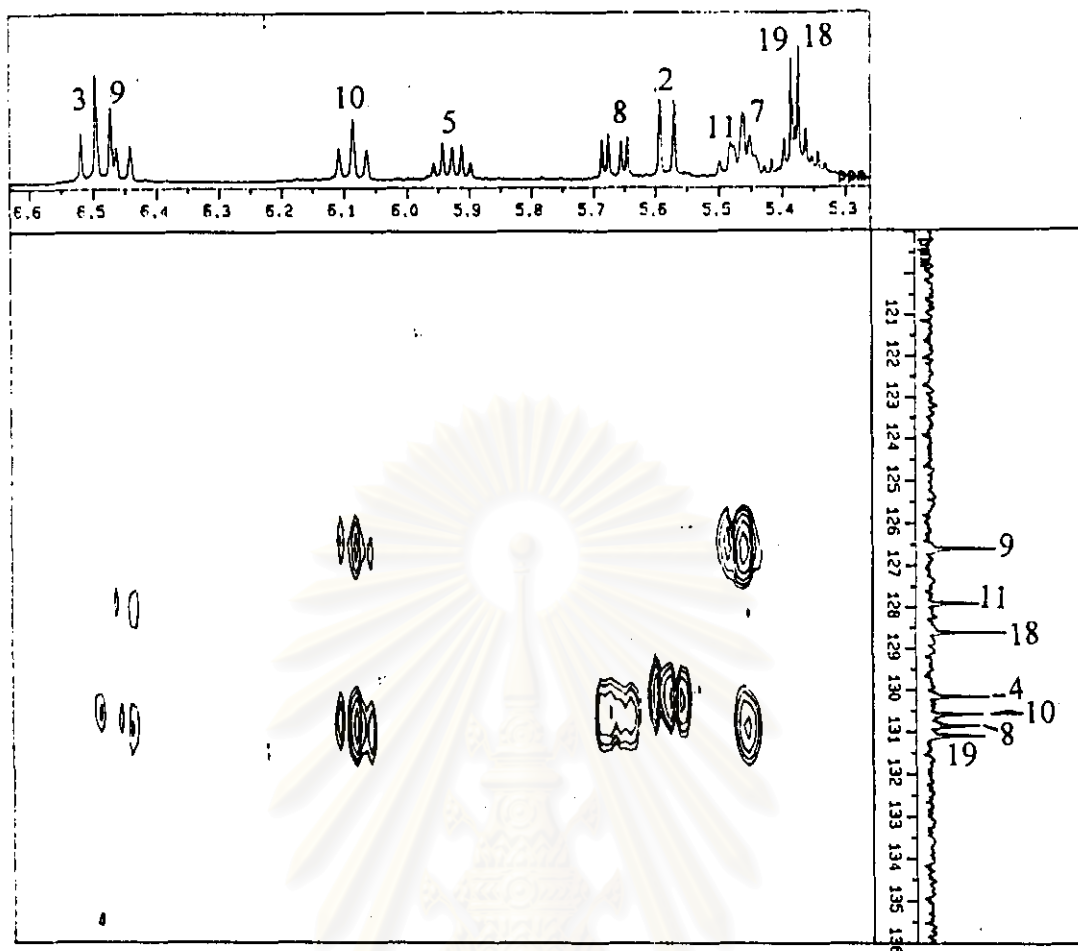
**Figure 176.** The 500 MHz HMBC spectrum ( $^nJ_{\text{HC}} = 8$  Hz) of 7-*O*-succinyl macrolactin F (P129) (in  $\text{CDCl}_3$ ) (expanded from 0.8-2.6 ppm)



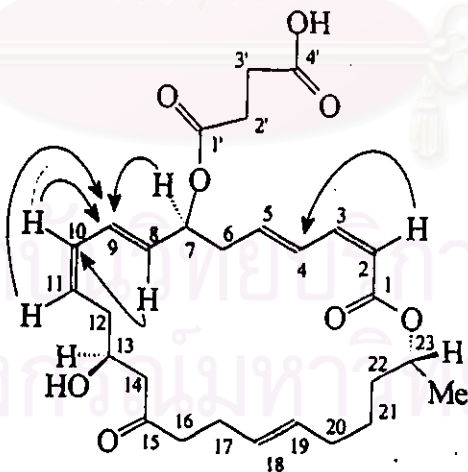


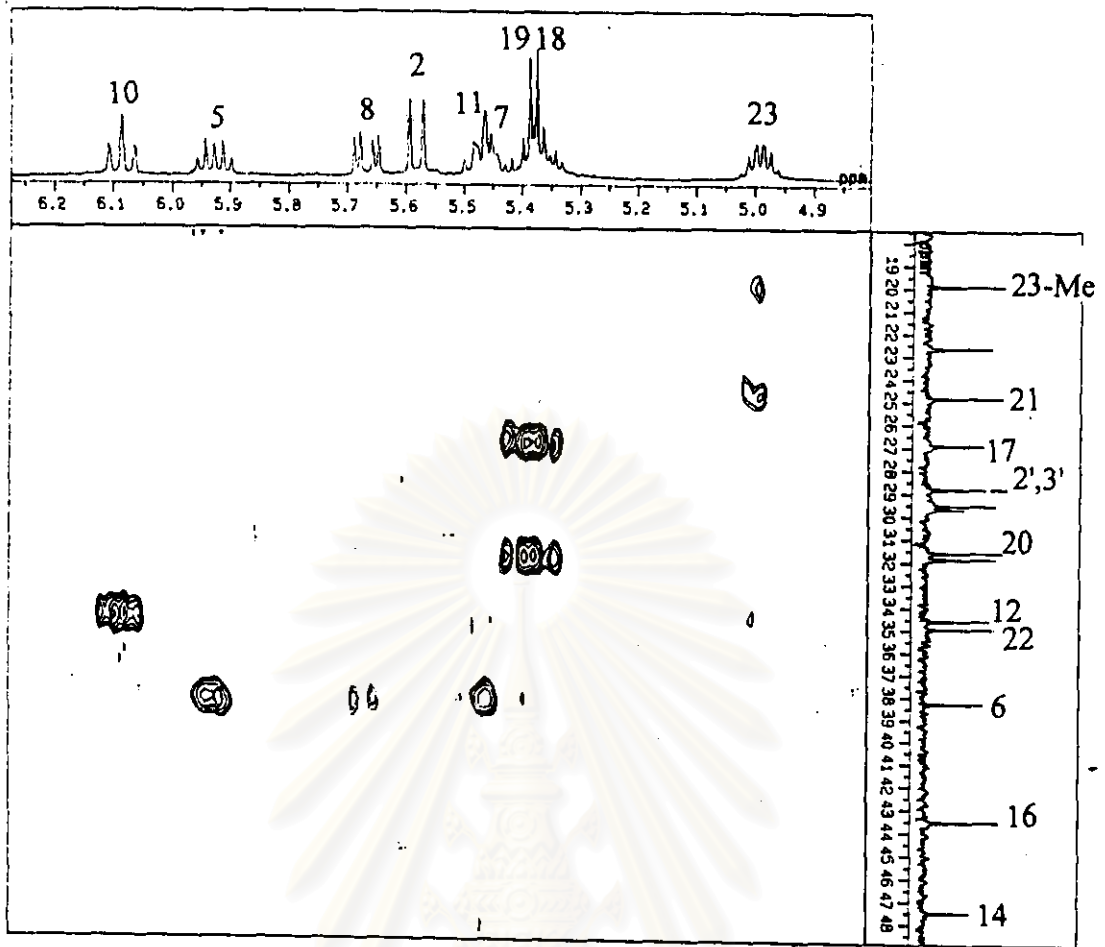
**Figure 177.** The 500 MHz HMBC spectrum ( $^nJ_{\text{HC}} = 8 \text{ Hz}$ ) of 7-*O*-succinyl macrolactin F (P129) (in  $\text{CDCl}_3$ ) (expanded from 0.8-2.8 ppm)



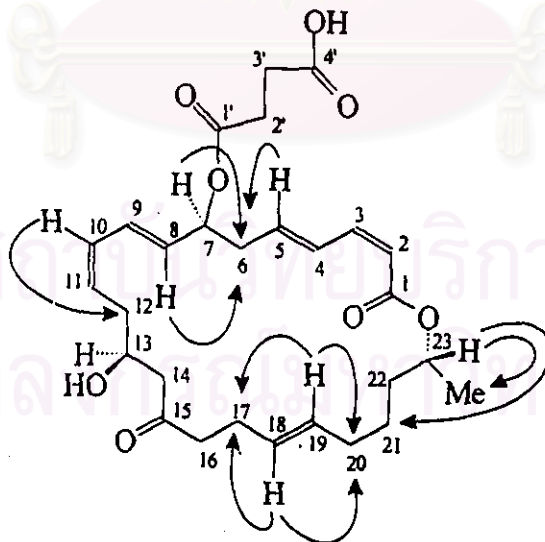


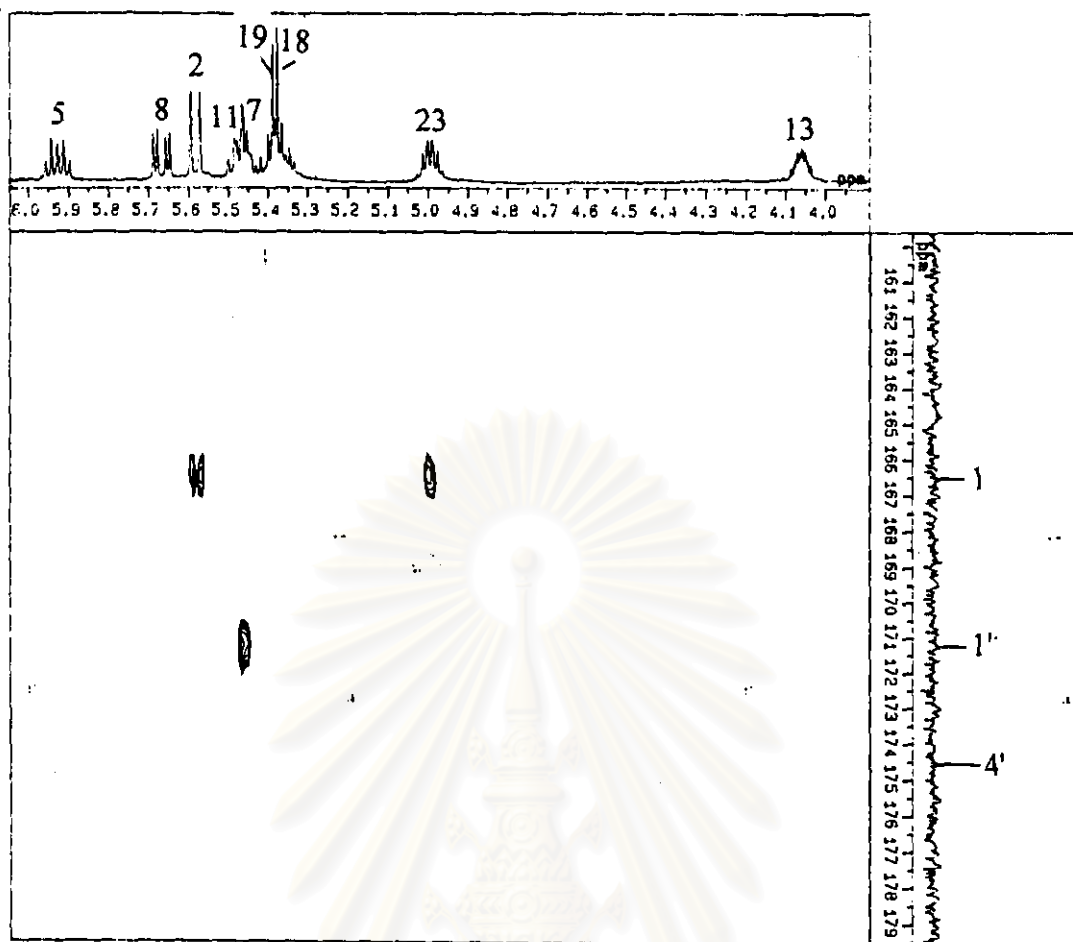
**Figure 178.** The 500 MHz HMBC spectrum ( $^nJ_{\text{HC}} = 8$  Hz) of 7-*O*-succinyl macrolactin F (P129) (in  $\text{CDCl}_3$ ) (expanded from 5.3-6.6 ppm)



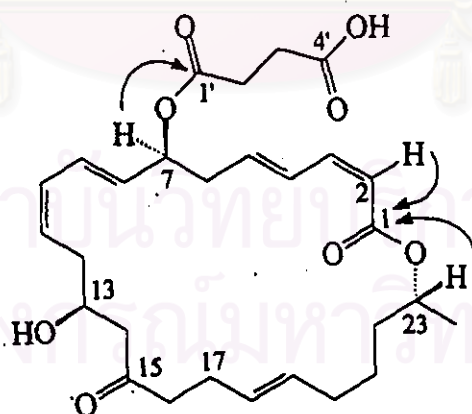


**Figure 179.** The 500 MHz HMBC spectrum ( $^nJ_{\text{HC}} = 8 \text{ Hz}$ ) of 7-*O*-succinyl macrolactin F (P129) (in  $\text{CDCl}_3$ ) (expanded from 4.9–6.2 ppm)

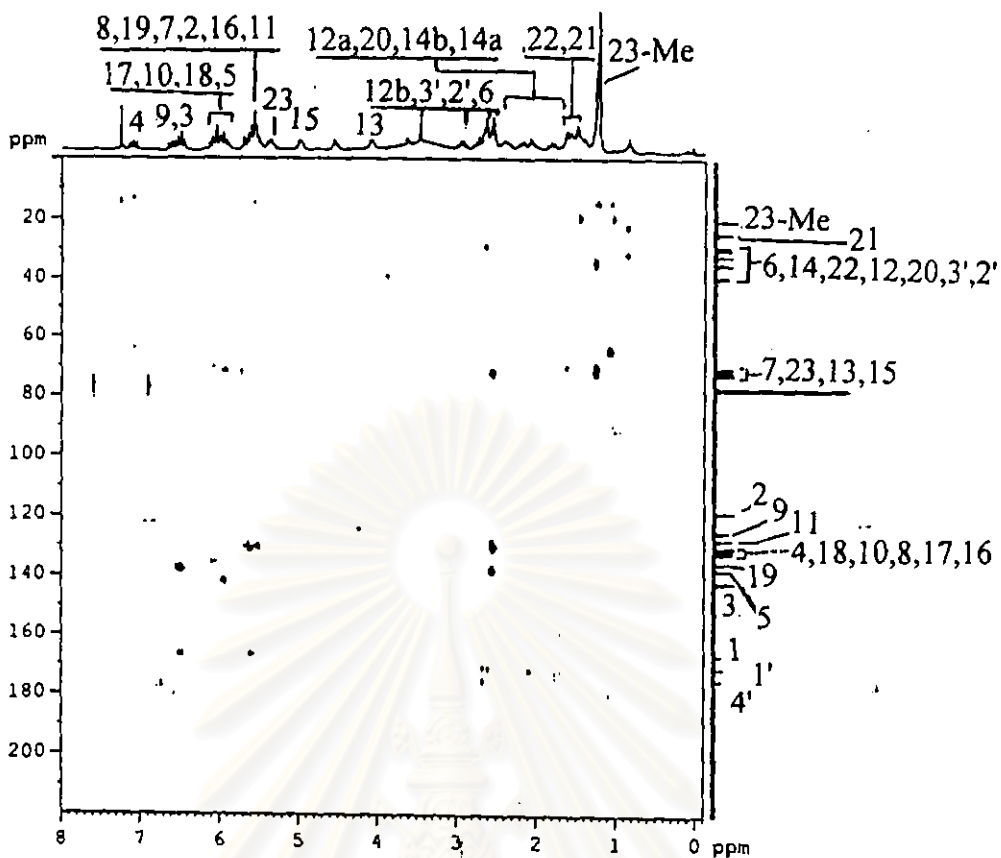




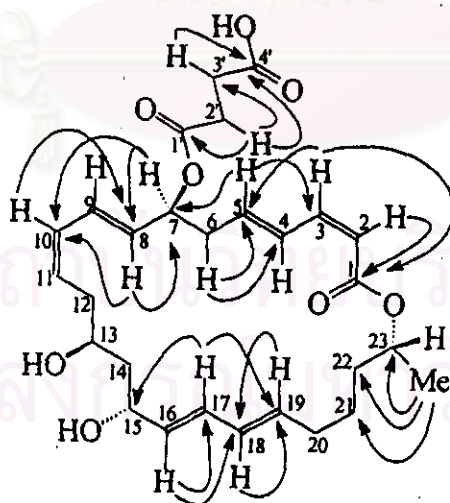
**Figure 180.** The 500 MHz HMBC spectrum ( $^nJ_{\text{HC}} = 8$  Hz) of 7-*O*-succinyl macrolactin F (P129) (in  $\text{CDCl}_3$ ) (expanded from 4.0-6.0 ppm)

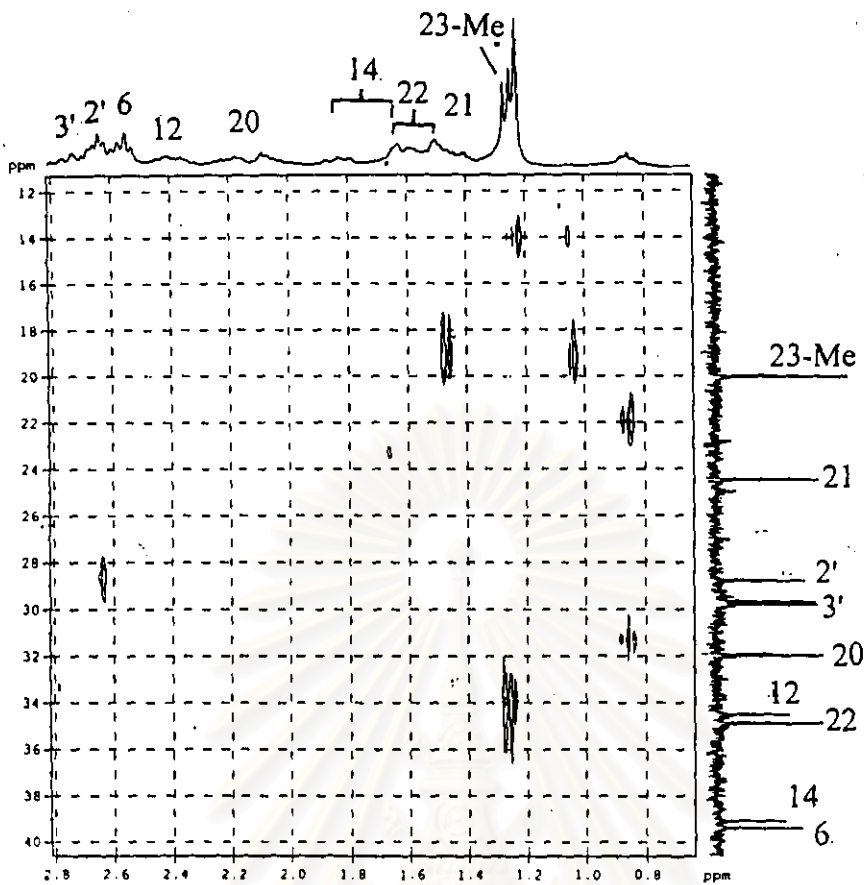




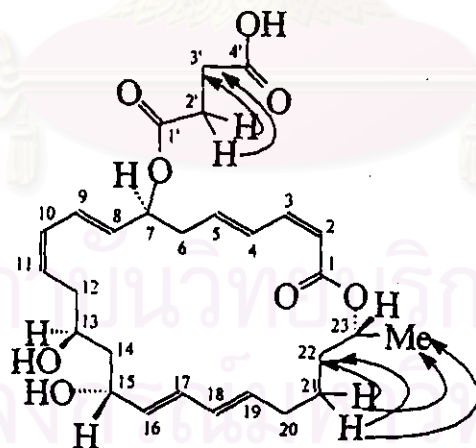


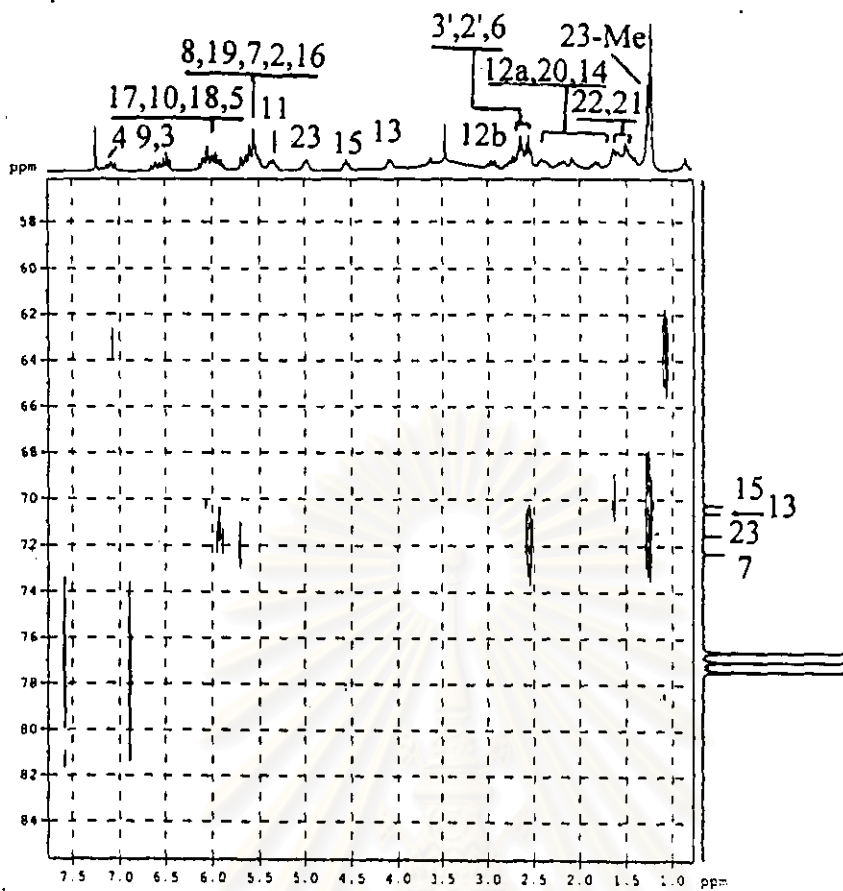
**Figure 181.** The 300 MHz HMBC spectrum ( $^nJ_{\text{HC}} = 8 \text{ Hz}$ ) of 7-*O*-succinyl macrolactin A (P103) (in  $\text{CDCl}_3$ )



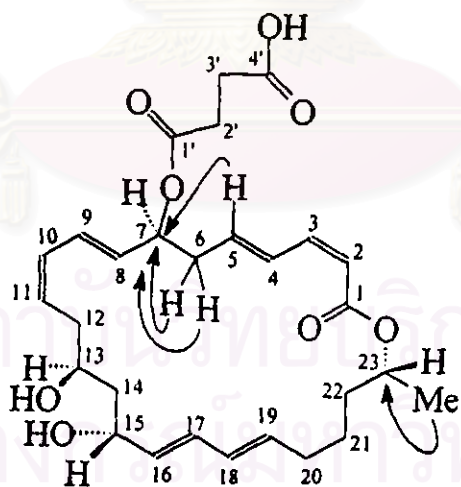


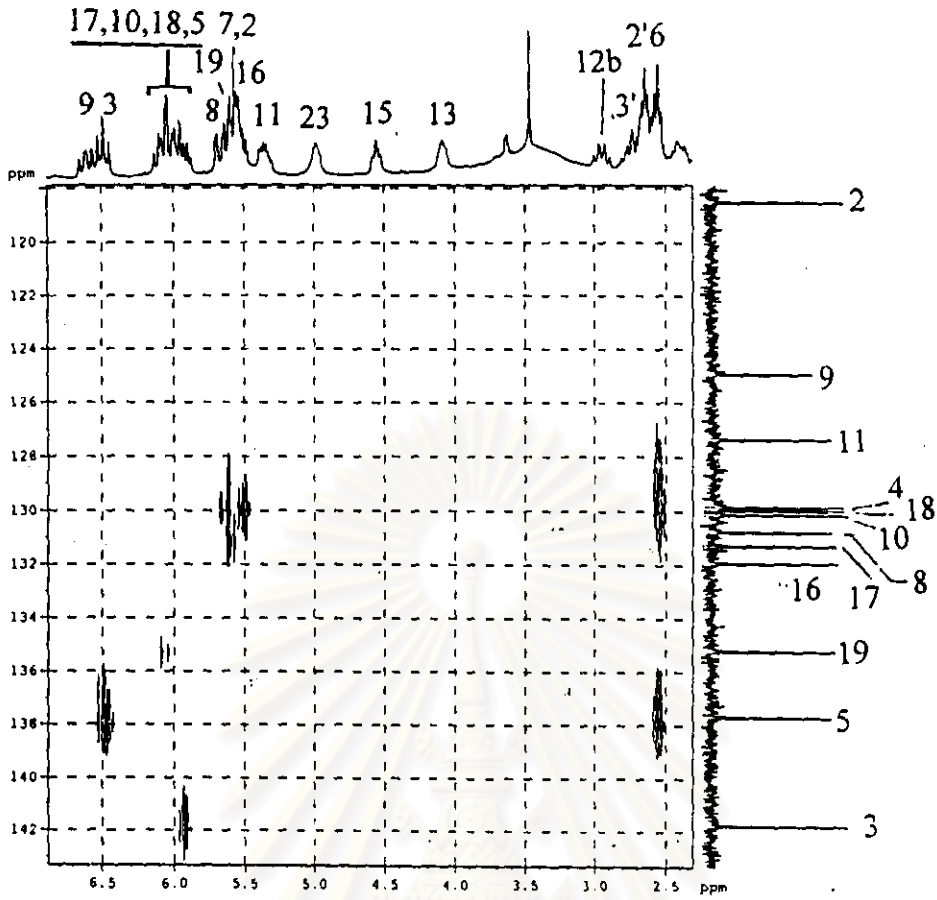
**Figure 182.** The 300 MHz HMBC spectrum ( $^nJ_{\text{HC}} = 8$  Hz) of 7-*O*-succinyl macrolactin A (P103) (in  $\text{CDCl}_3$ ) (expanded from 0.7-2.8 ppm)



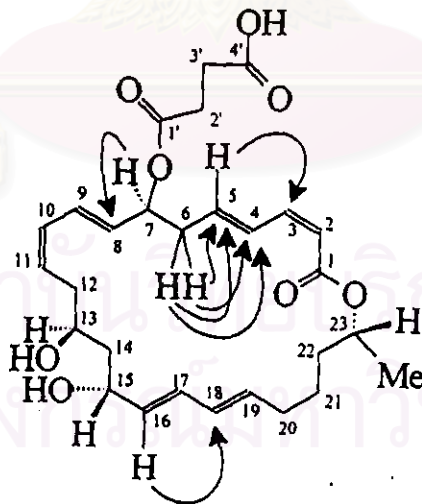


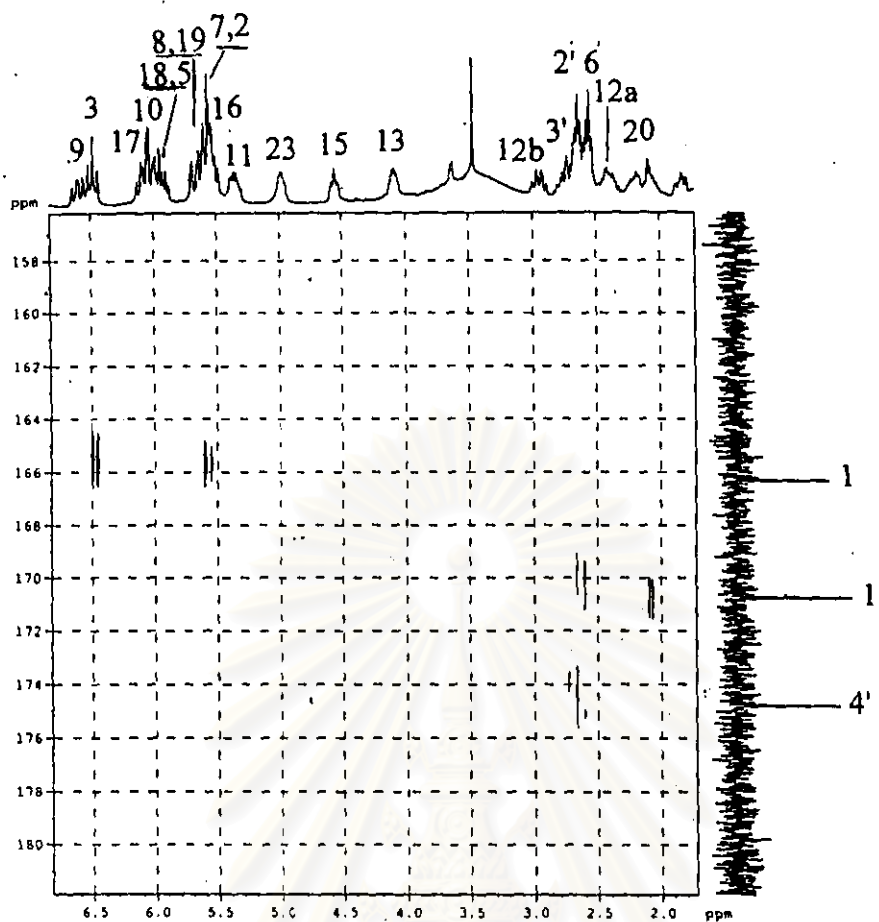
**Figure 183.** The 300 MHz HMBC spectrum ( $^nJ_{\text{HC}} = 8 \text{ Hz}$ ) of 7-*O*-succinyl macrolactin A (P103) (in  $\text{CDCl}_3$ ) (expanded from 1.0-7.5 ppm)



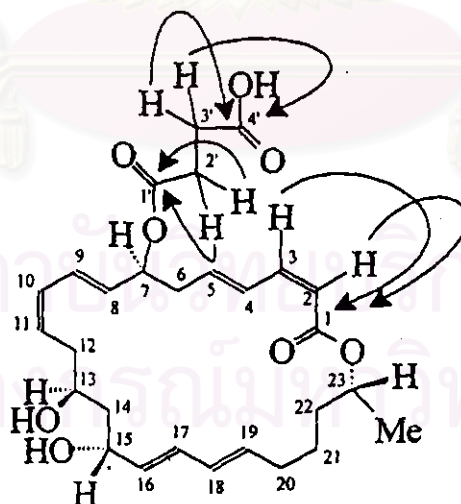


**Figure 184.** The 300 MHz HMBC spectrum ( $^nJ_{\text{HC}} = 8 \text{ Hz}$ ) of 7-*O*-succinyl macrolactin A (P103) (in  $\text{CDCl}_3$ ) (expanded from 2.5-6.6 ppm)





**Figure 185.** The 300 MHz HMBC spectrum ( $^nJ_{\text{HC}} = 8$  Hz) of 7-*O*-succinyl macrolactin A (P103) (in  $\text{CDCl}_3$ ) (expanded from 1.7-6.8 ppm)



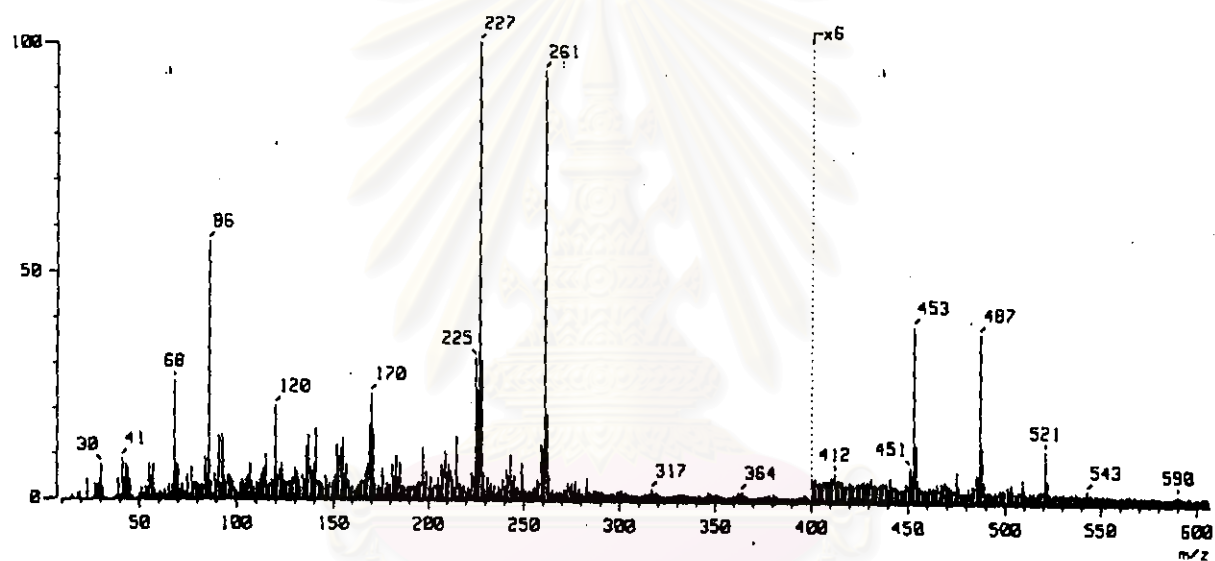


Figure 186. HRFAB mass spectrum of *cyclo*-(4-hydroxy-prolyl-4-hydroxy-prolyl-leucyl-phenylalanyl) (P132)

สถาบันวิทยบริการ  
จุฬาลงกรณ์มหาวิทยาลัย

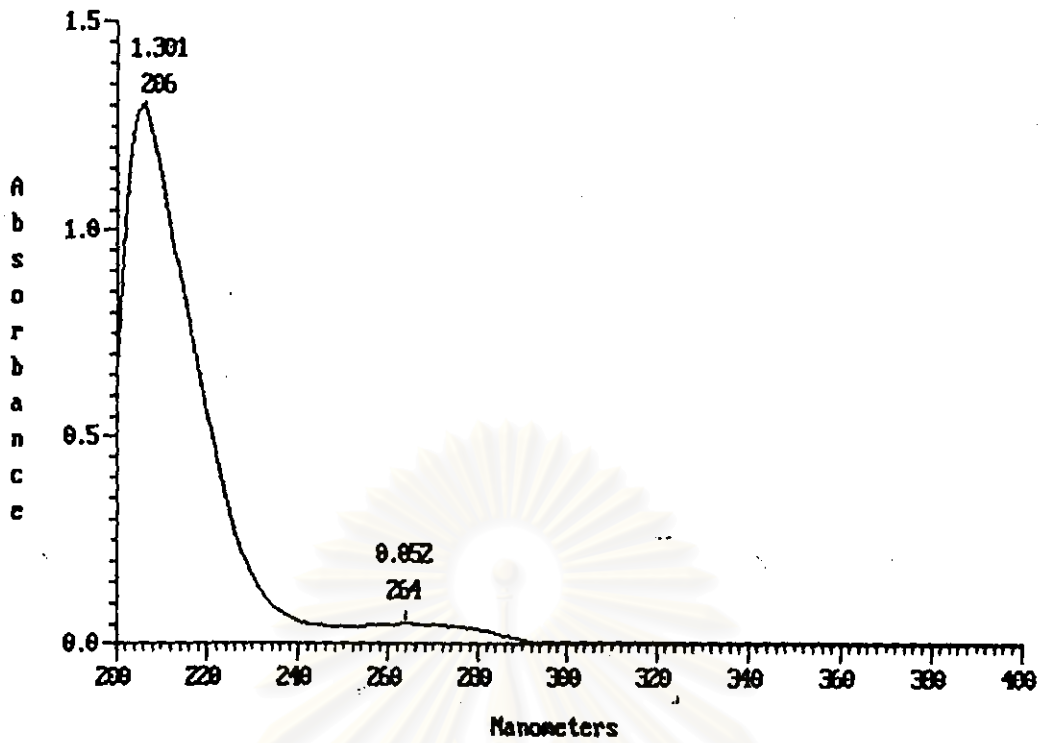


Figure 187. UV spectrum of *cyclo*-(4-hydroxy-prolyl-4-hydroxy-prolyl-leucyl-phenylalanyl) (P132) (in MeOH)

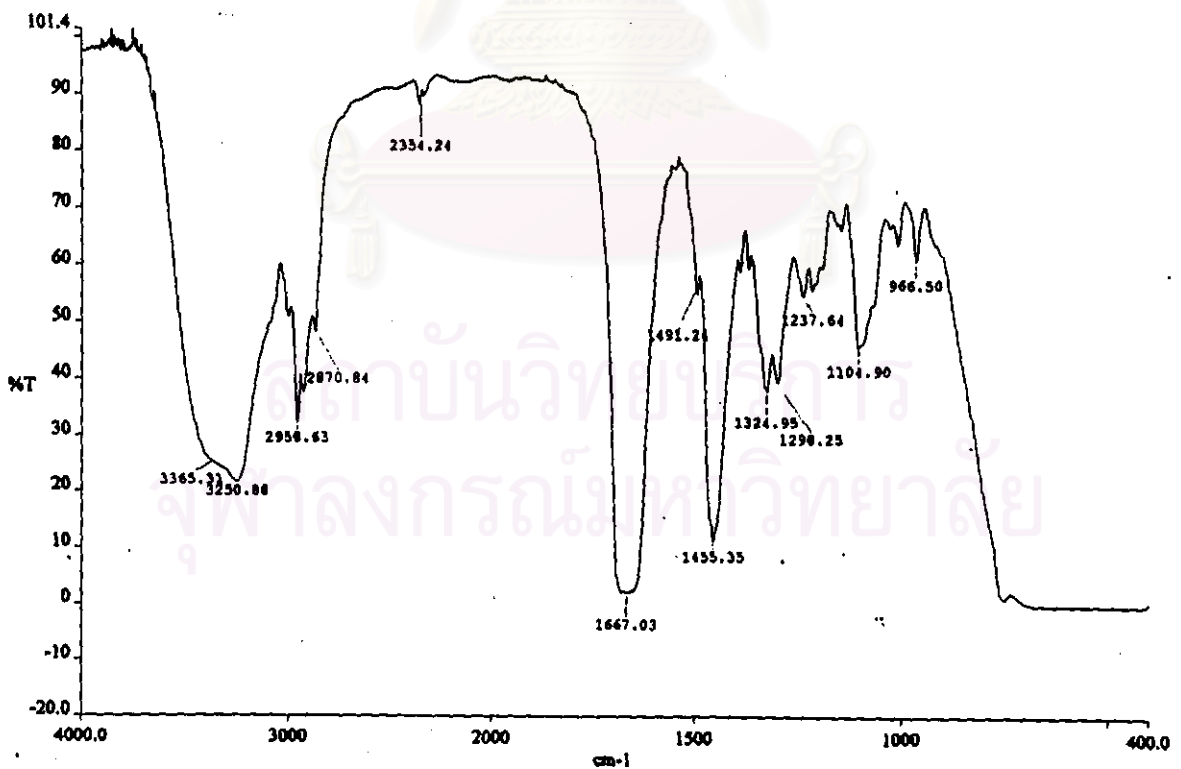


Figure 188. IR spectrum of *cyclo*-(4-hydroxy-prolyl-4-hydroxy-prolyl-leucyl-phenylalanyl) (P132) (film)



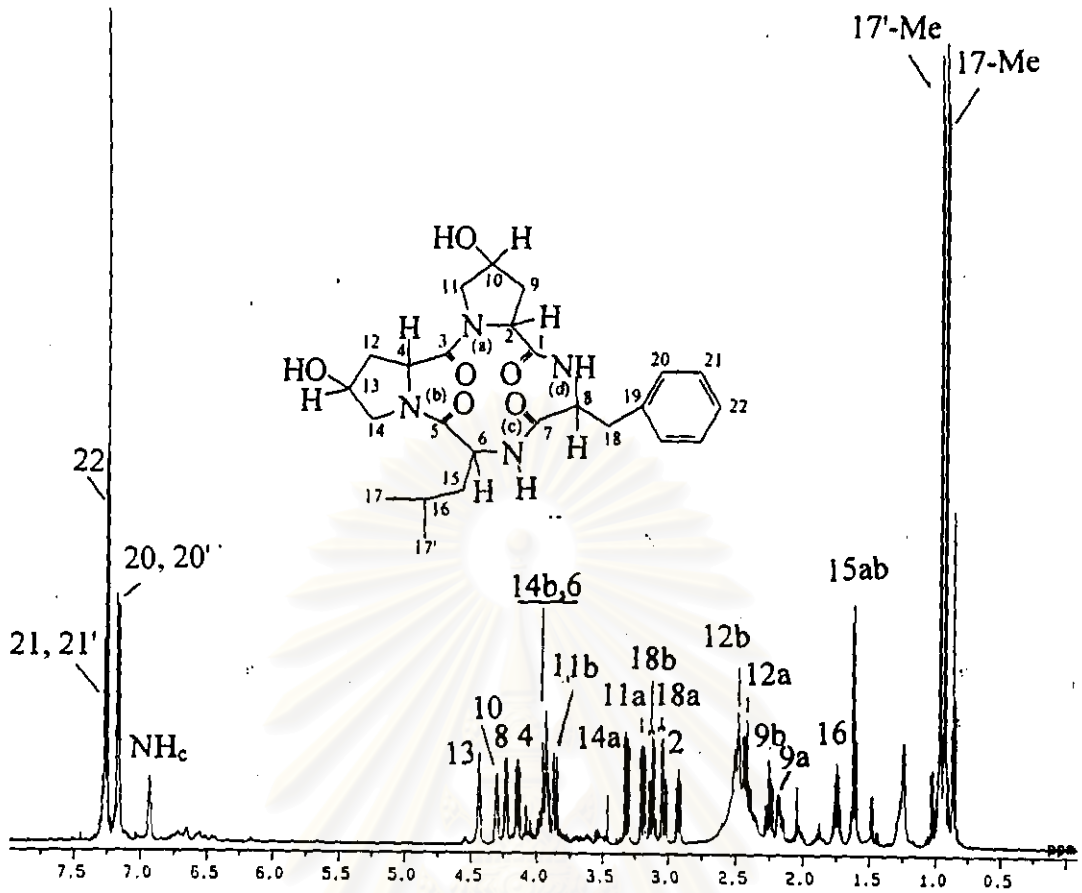


Figure 189. The 500 MHz  $^1\text{H}$  NMR spectrum of *cyclo*-(4-hydroxy-prolyl-4-hydroxy-prolyl-leucyl-phenylalanyl) (P132) (in  $\text{CDCl}_3$ )

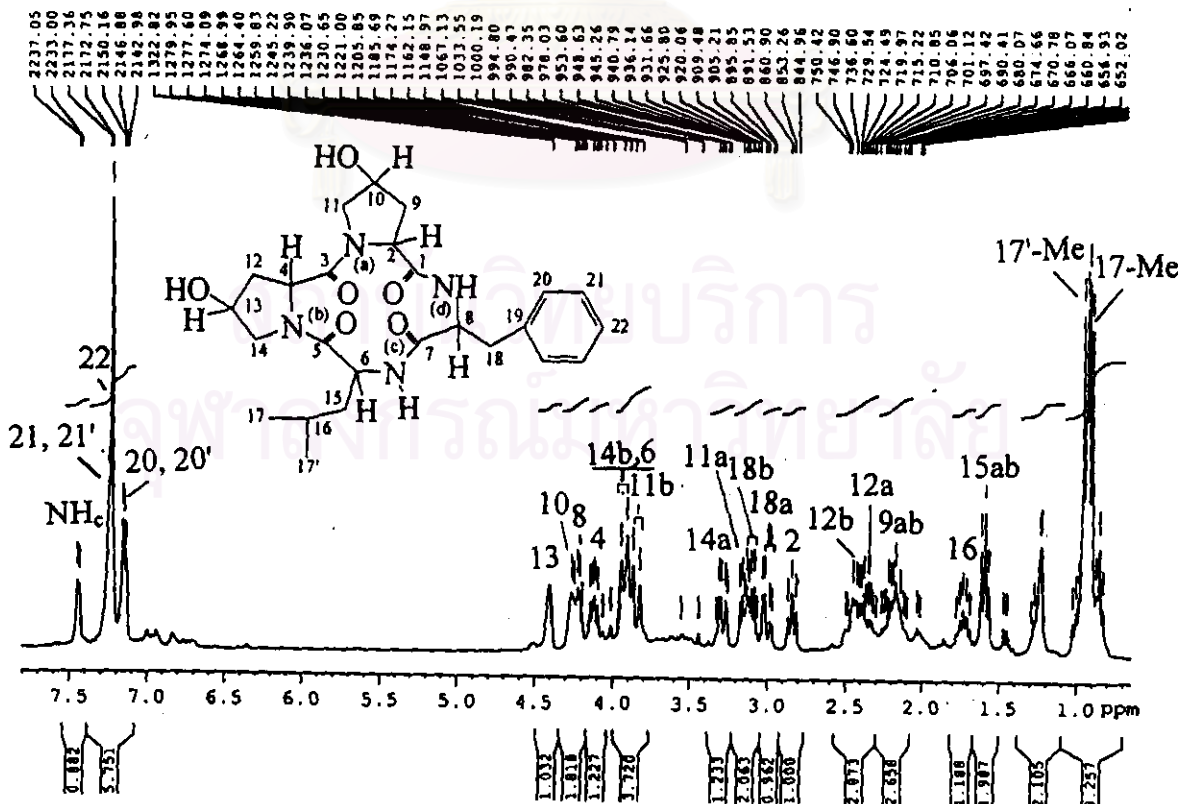


Figure 190. The 300 MHz  $^1\text{H}$  NMR spectrum of *cyclo*-(4-hydroxy-prolyl-4-hydroxy-prolyl-leucyl-phenylalanyl) (P132) (in  $\text{CDCl}_3$ )

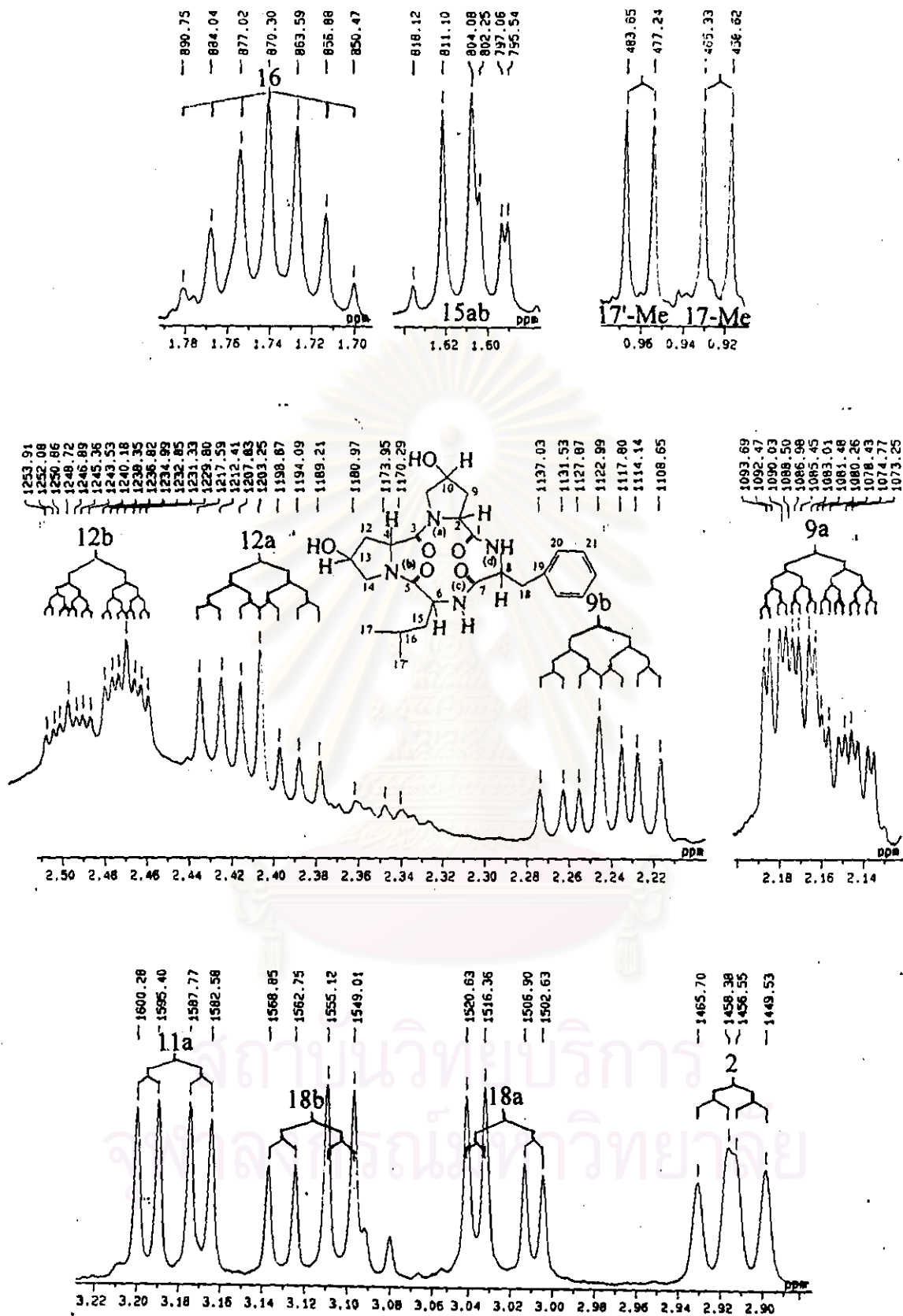


Figure 191. The 500 MHz  $^1\text{H}$  NMR spectrum of *cyclo*-(4-hydroxy-prolyl)-4-hydroxy-prolyl-leucyl-phenylalanyl) (P132) (in  $\text{CDCl}_3$ ) (expanded from 0.92-3.22 ppm)

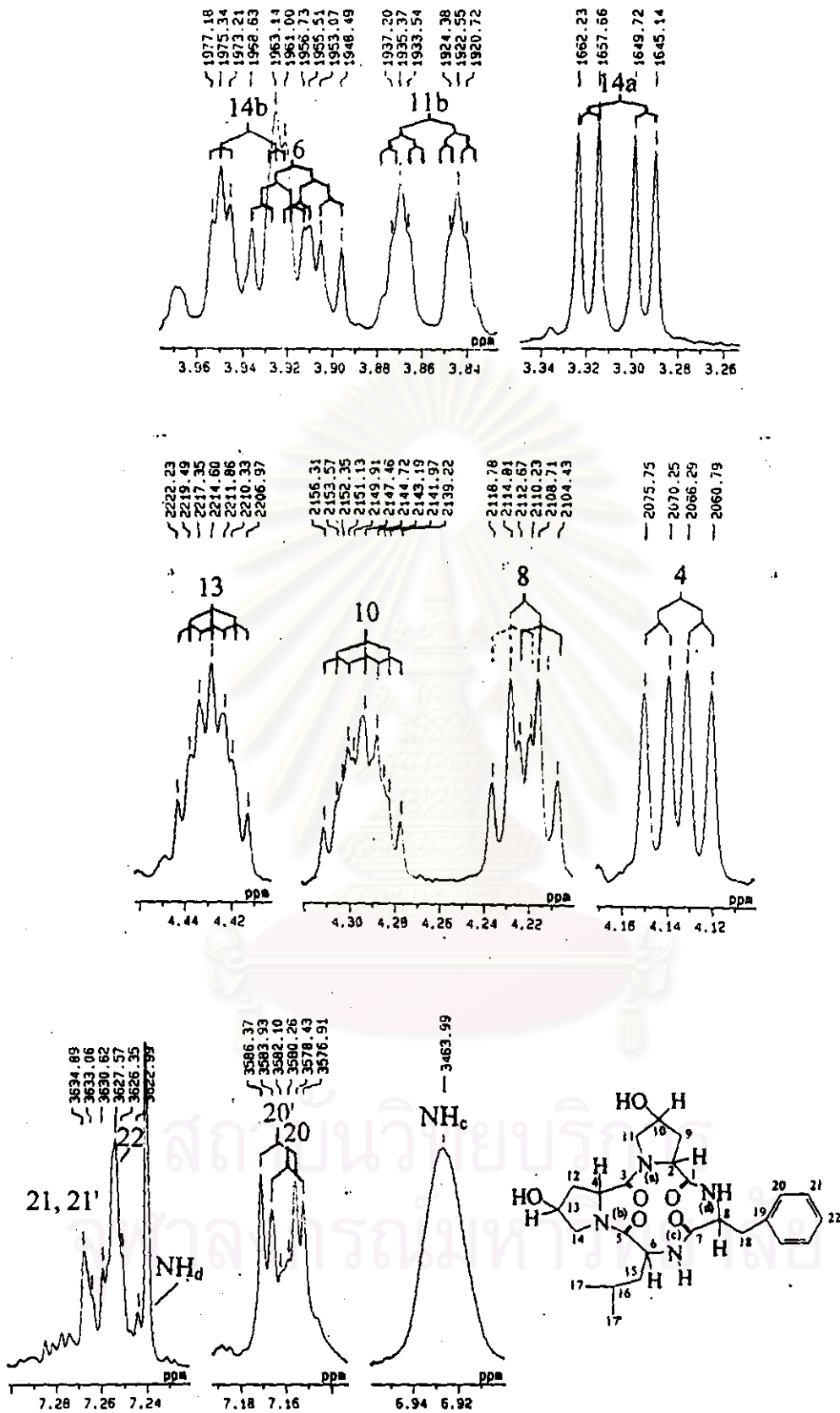


Figure 192. The 500 MHz  $^1\text{H}$  NMR spectrum of *cyclo*-(4-hydroxy-prolyl-4-hydroxy-prolyl-leucyl-phenylalanyl) (P132) (in  $\text{CDCl}_3$ ) (expanded from 3.26-7.28 ppm)

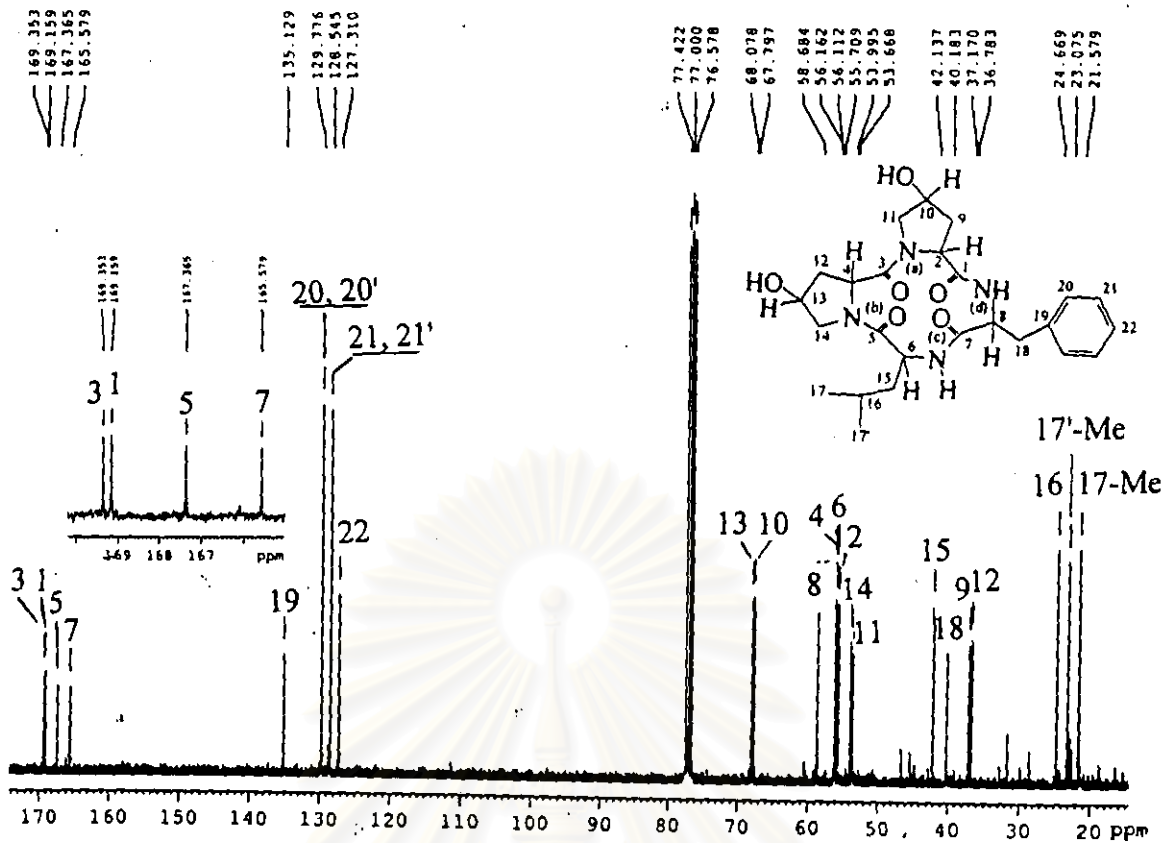


Figure 193. The 75 MHz  $^{13}\text{C}$  NMR spectrum of *cyclo*-(4-hydroxy-prolyl-4-hydroxy-prolyl-leucyl-phenylalanyl) (P132) (in  $\text{CDCl}_3$ )

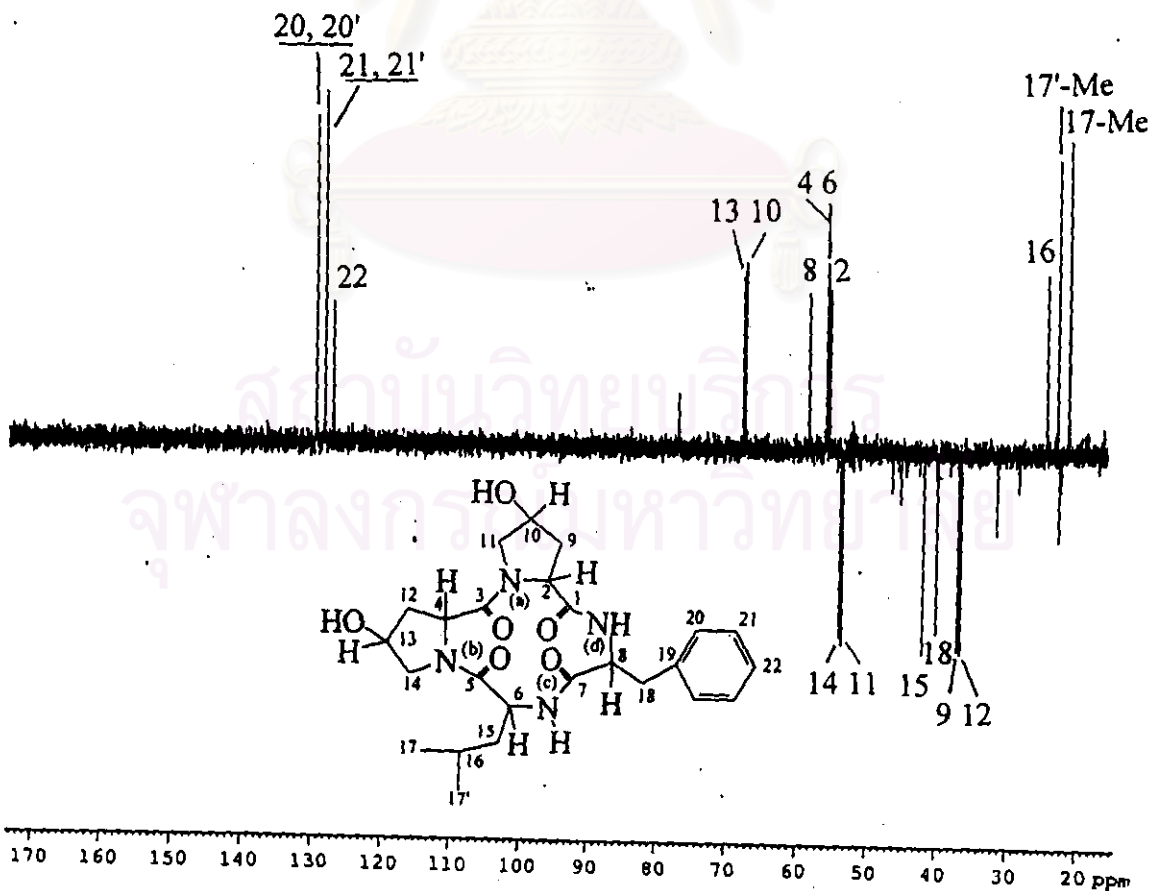
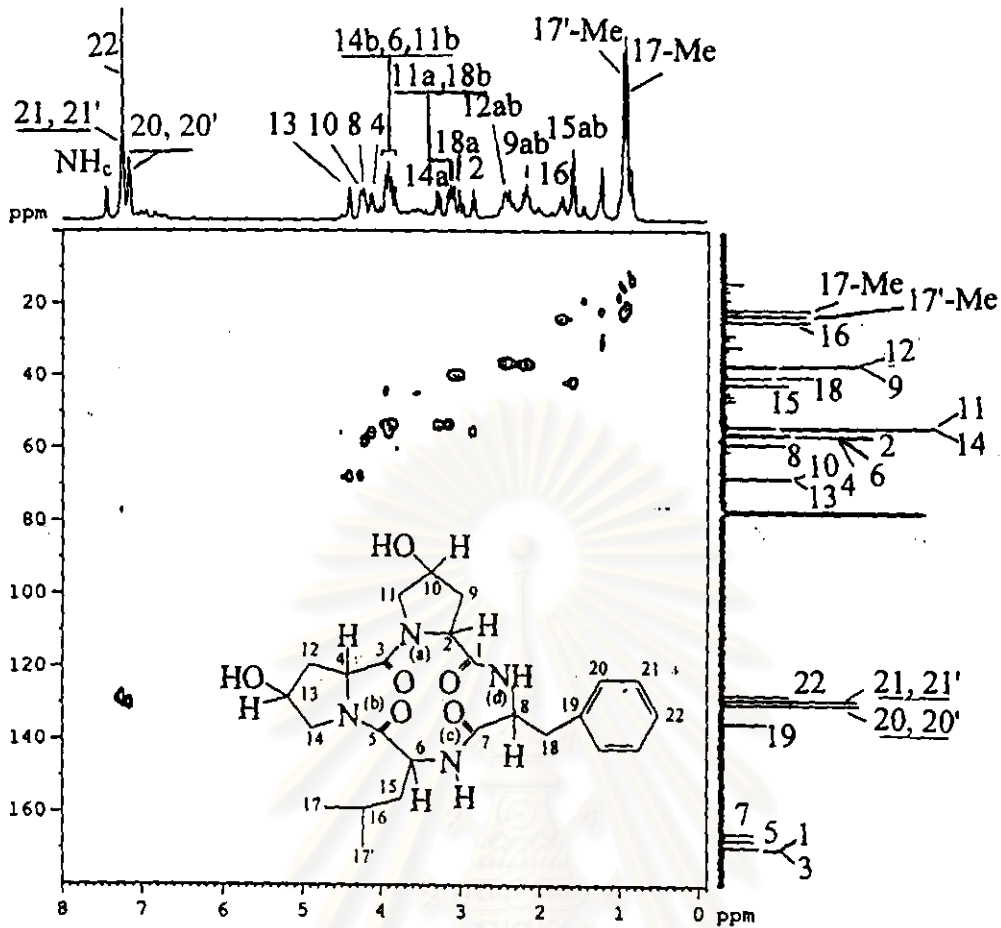
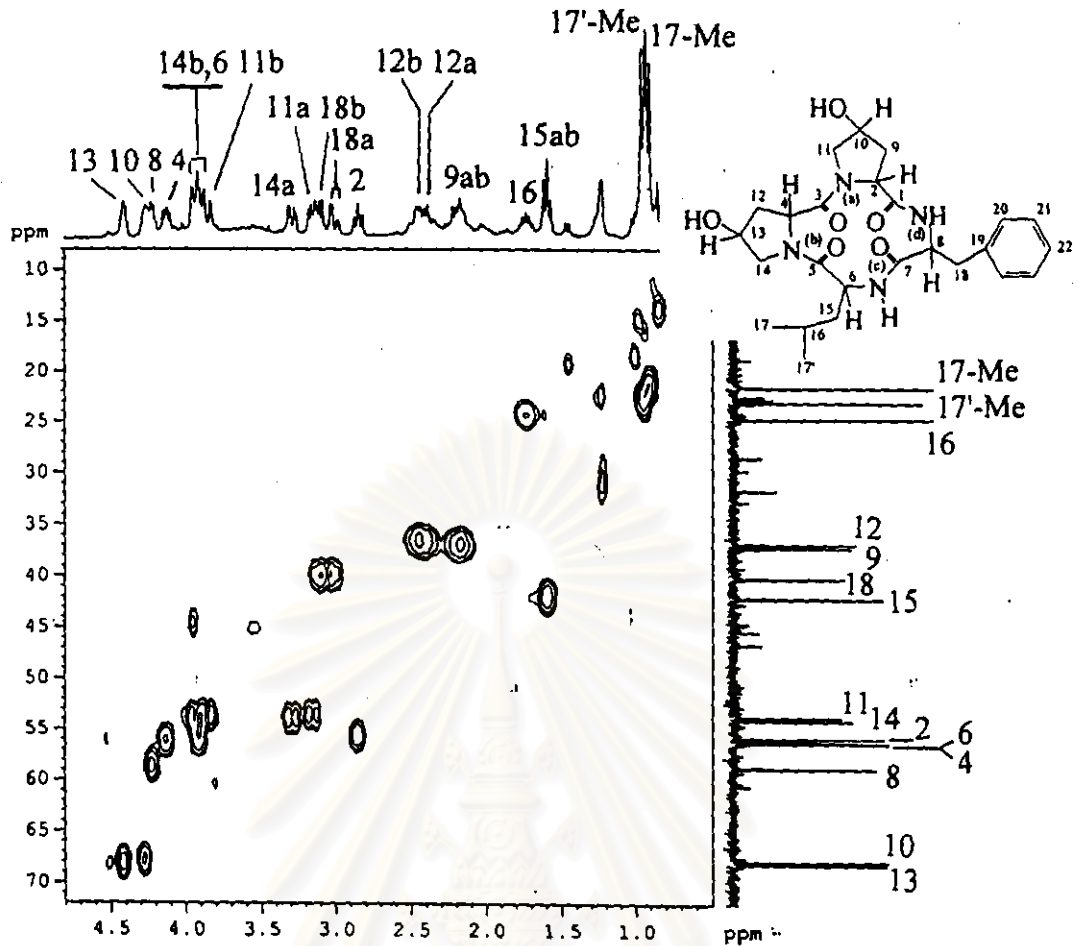


Figure 194. The 75 MHz DEPT 135 spectrum of *cyclo*-(4-hydroxy-prolyl-4-hydroxy-prolyl-leucyl-phenylalanyl) (P132) (in  $\text{CDCl}_3$ )



**Figure 195.** The 300 MHz HMQC spectrum of *cyclo*-(4-hydroxy-prolyl-4-hydroxy-prolyl-leucyl-phenylalanyl) (P132) (in  $\text{CDCl}_3$ )

สถาบันวิทยบริการ  
จุฬาลงกรณ์มหาวิทยาลัย



**Figure 196.** The 300 MHz HMQC spectrum of *cyclo*-(4-hydroxy-prolyl-4-hydroxy-prolyl-leucyl-phenylalanyl) (P132) (in  $\text{CDCl}_3$ ) (expanded from 0.5–4.8 ppm)

สถาบันวิทยบริการ  
จุฬาลงกรณ์มหาวิทยาลัย

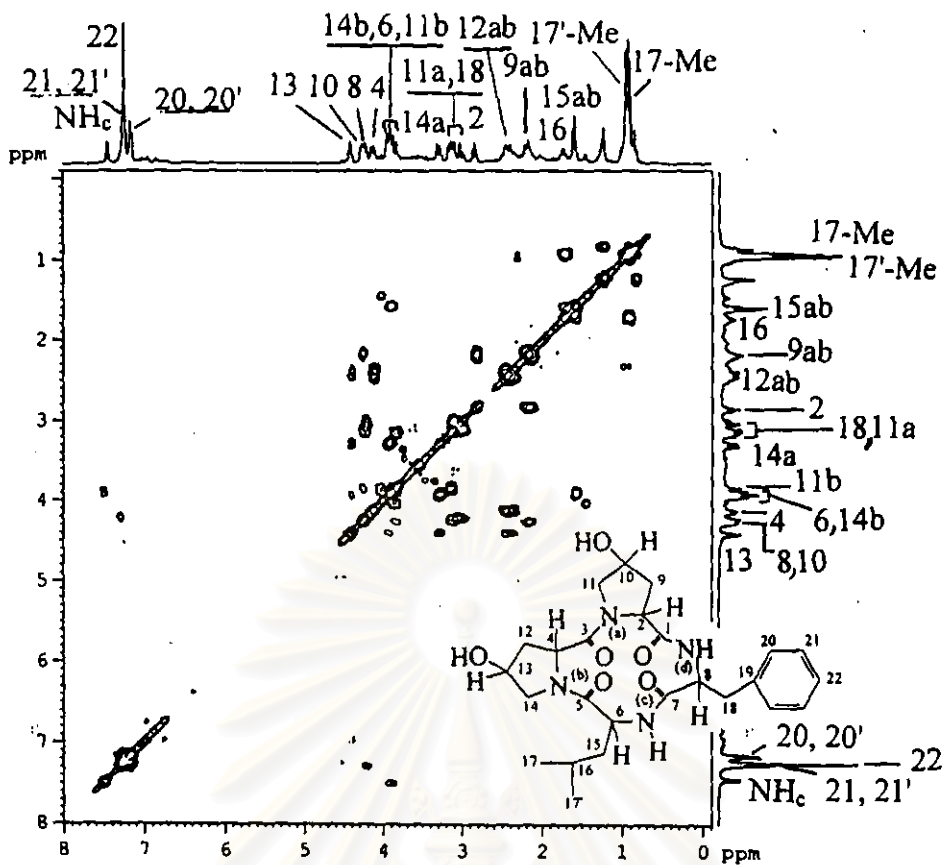


Figure 197. The 300 MHz  $^1\text{H}$ - $^1\text{H}$  COSY spectrum of *cyclo*-(4-hydroxy-prolyl-4-hydroxy-prolyl-leucyl-phenylalanyl) (P132) (in  $\text{CDCl}_3$ )

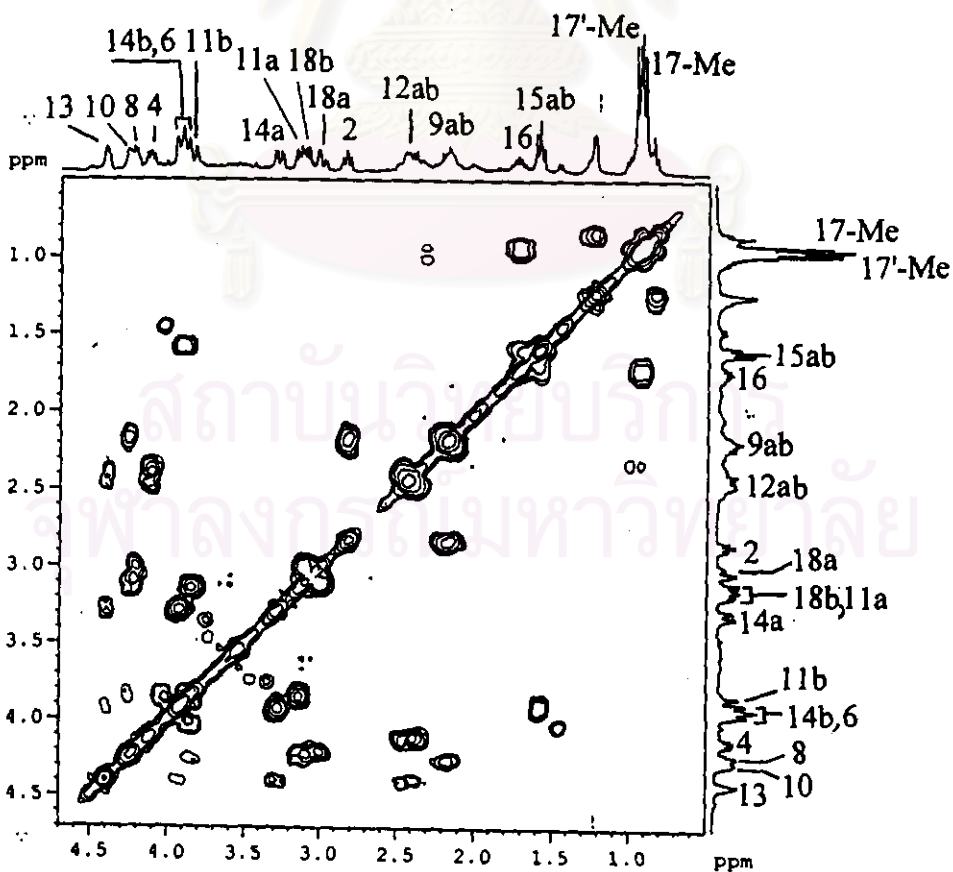


Figure 198. The 300 MHz  $^1\text{H}$ - $^1\text{H}$  COSY spectrum of *cyclo*-(4-hydroxy-prolyl-4-hydroxy-prolyl-leucyl-phenylalanyl) (P132) (in  $\text{CDCl}_3$ ) (expanded from 0-4.7 ppm)



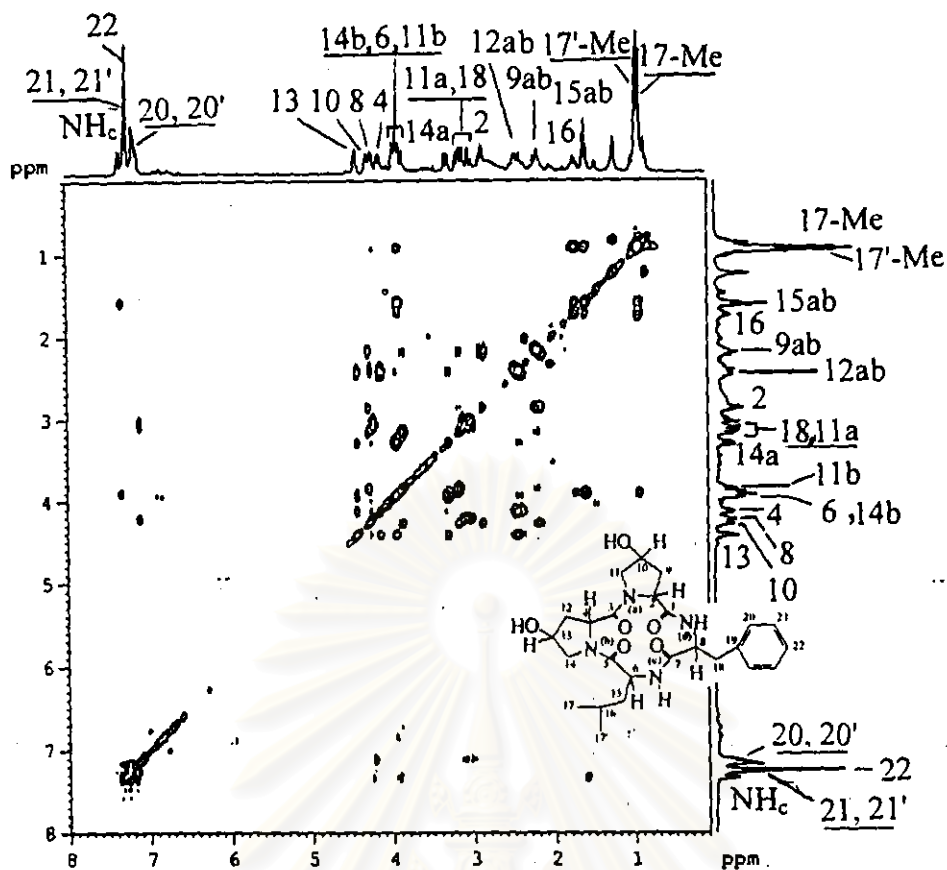


Figure 199. The 300 MHz TOCSY spectrum (mixing time = 23 μsec) of *cyclo*-(4-hydroxyprolyl-4-hydroxyprolyl-leucyl-phenylalanyl) (P132) (in CDCl<sub>3</sub>)

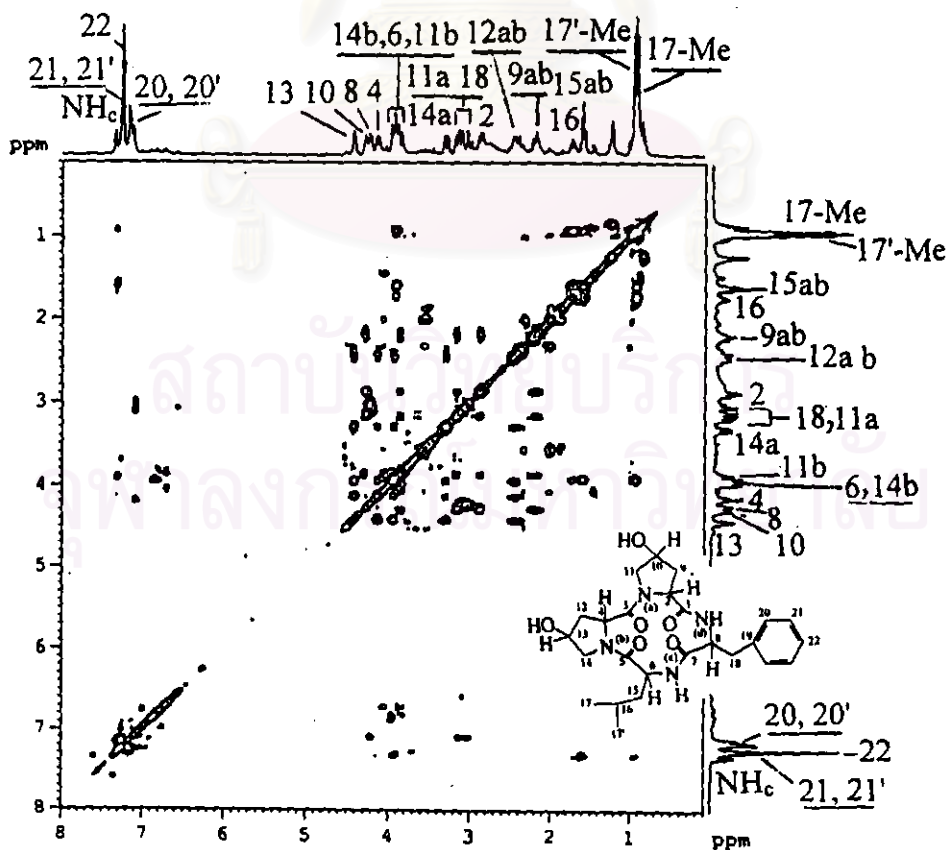
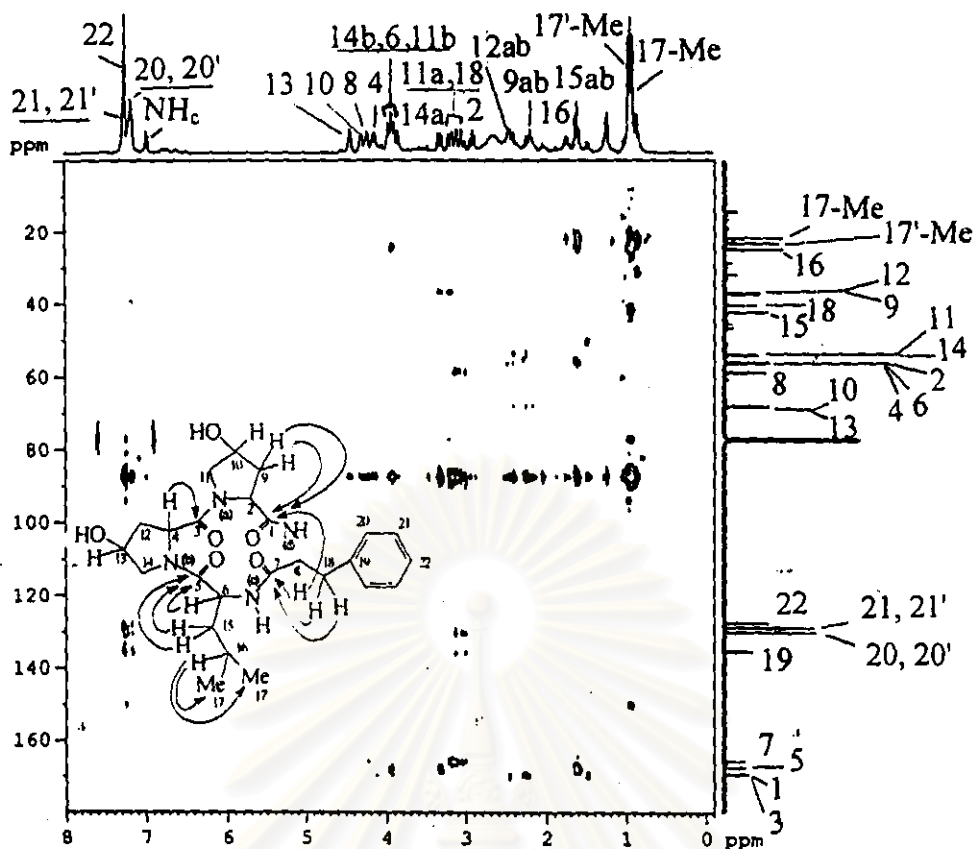
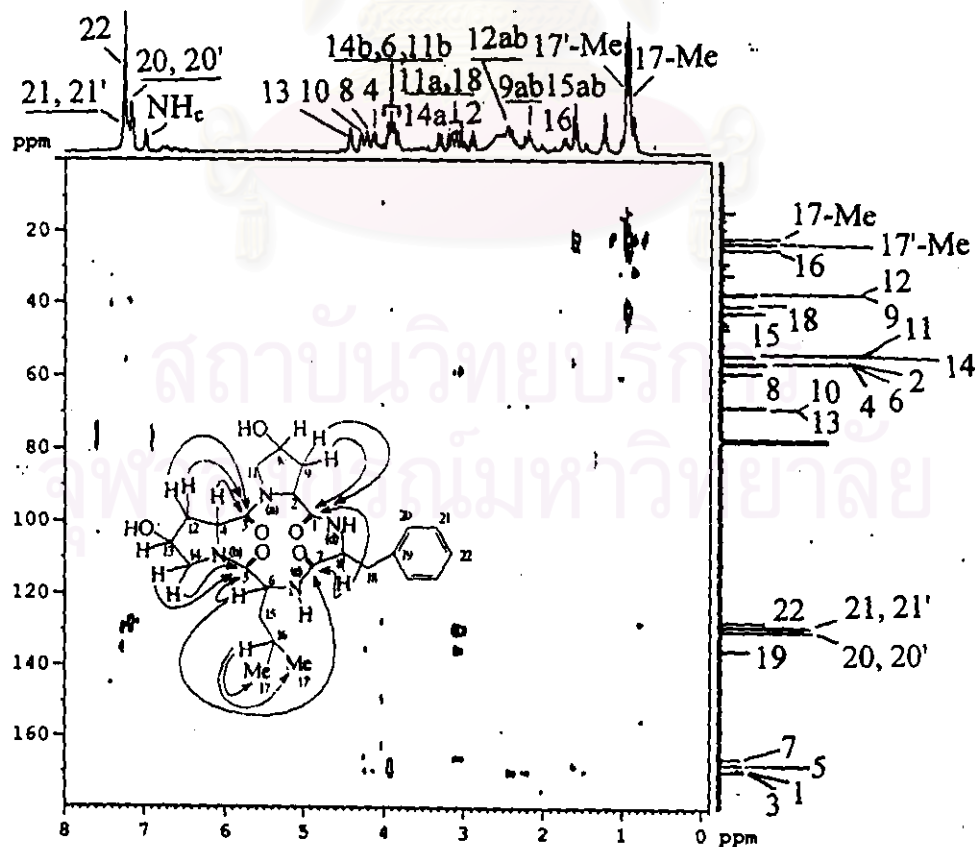


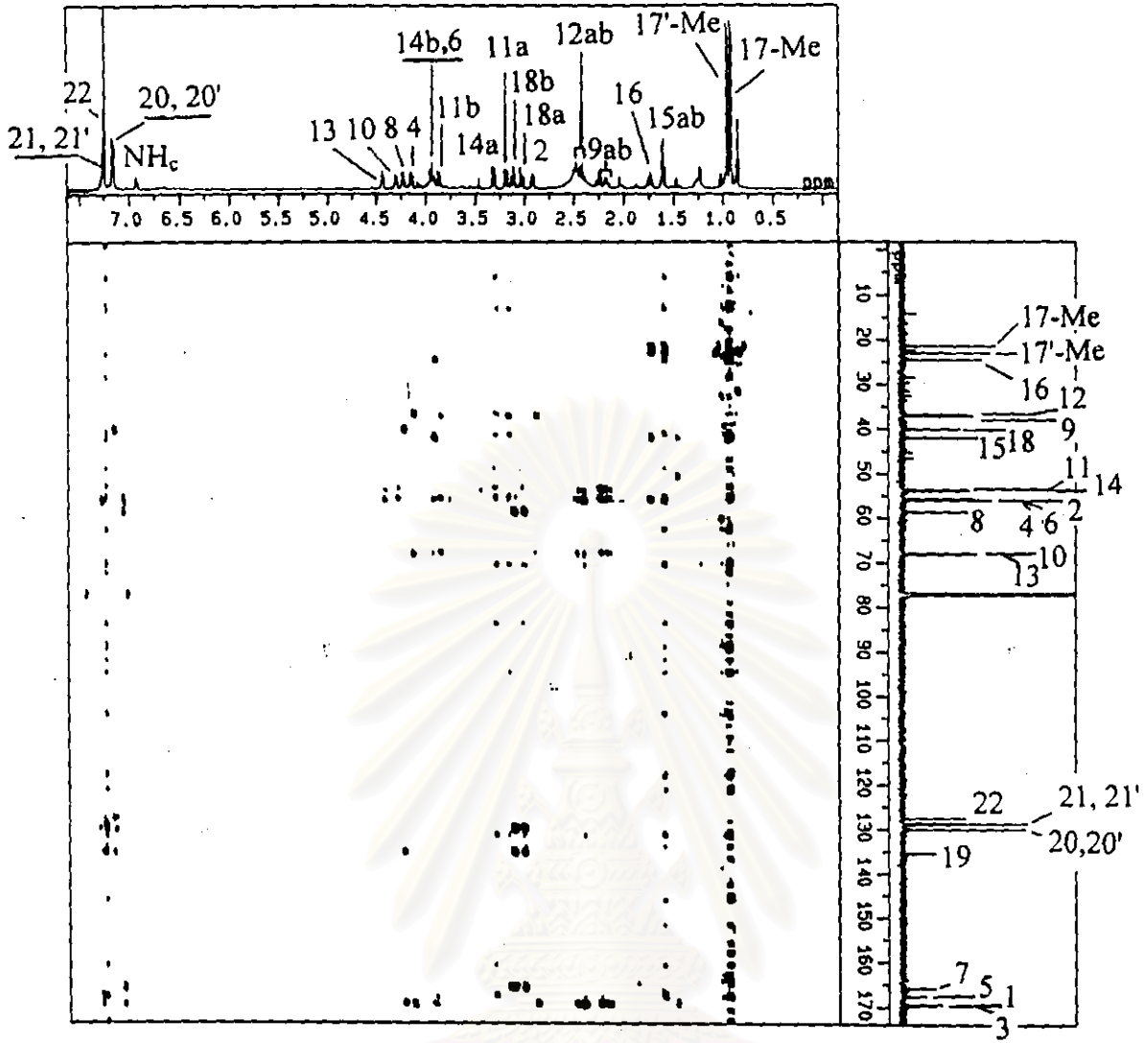
Figure 200. The 300 MHz TOCSY spectrum (mixing time = 35 μsec) of *cyclo*-(4-hydroxyprolyl-4-hydroxyprolyl-leucyl-phenylalanyl) (P132) (in CDCl<sub>3</sub>)



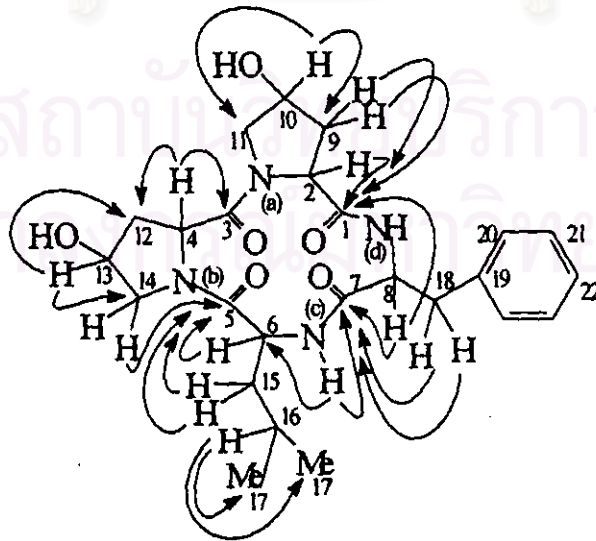
**Figure 201.** The 300 MHz HMBC spectrum ( $^nJ_{\text{HC}} = 3 \text{ Hz}$ ) of *cyclo*-(4-hydroxyprolyl-4-hydroxy-prolyl-leucyl-phenylalanyl) (P132) (in CDCl<sub>3</sub>)

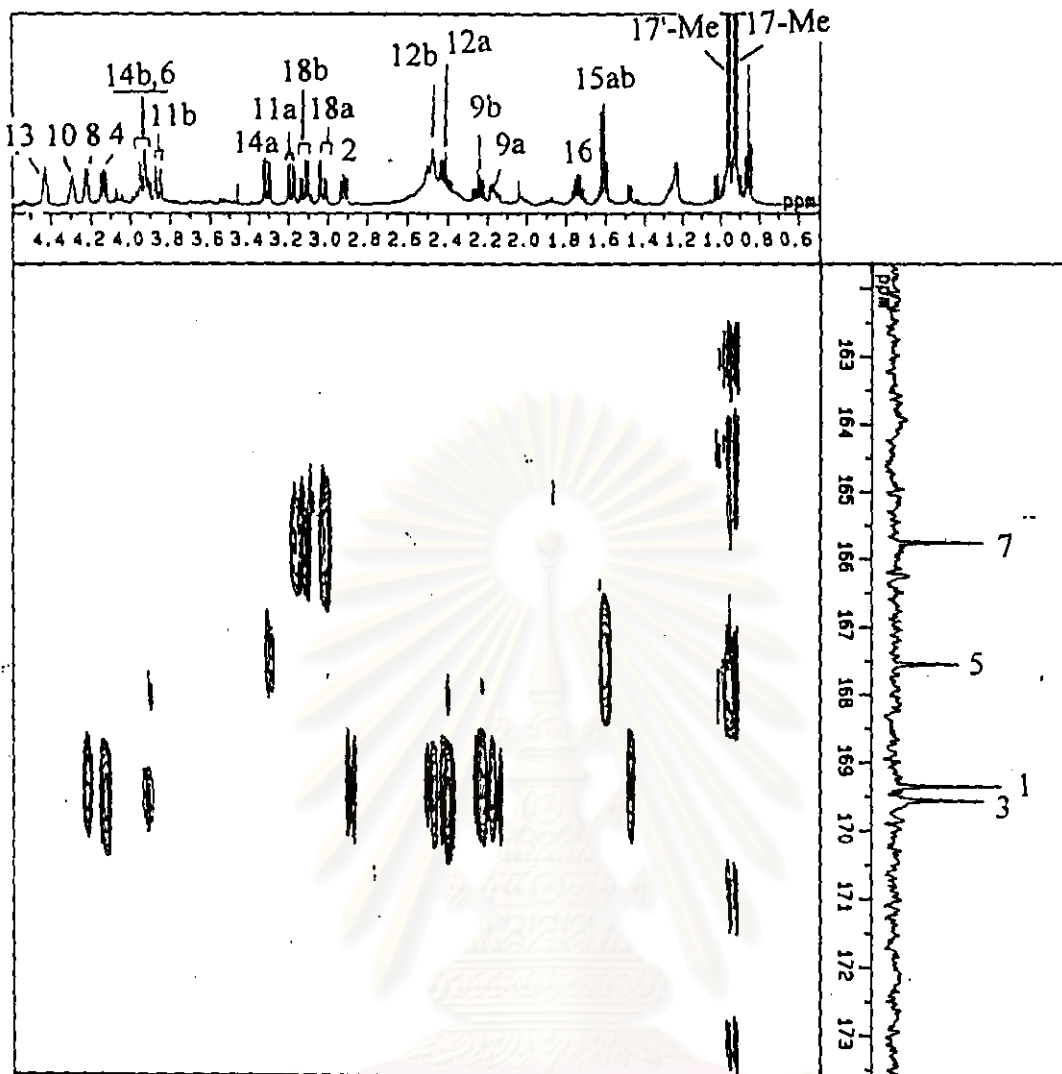


**Figure 202.** The 300 MHz HMBC spectrum ( $^nJ_{\text{HC}} = 8 \text{ Hz}$ ) of *cyclo*-(4-hydroxyprolyl-4-hydroxy-prolyl-leucyl-phenylalanyl) (P132) (in CDCl<sub>3</sub>)

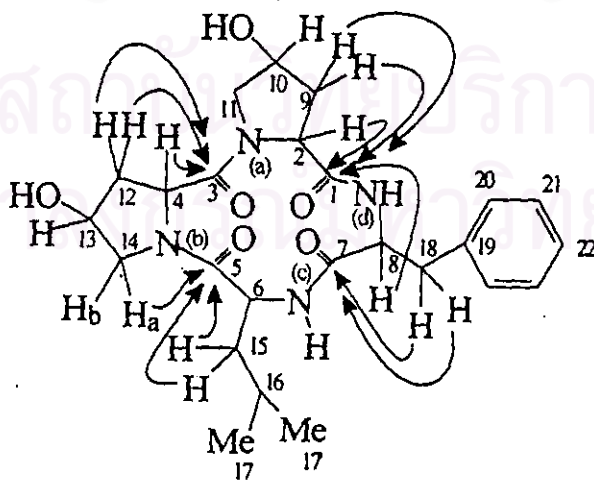


**Figure 203.** The 500 MHz HMBC spectrum ( $^nJ_{\text{HC}} = 4$  Hz) of *cyclo*-(4-hydroxyprolyl-4-hydroxyprolyl-leucyl-phenylalanyl) (P132) (in  $\text{CDCl}_3$ )





**Figure 204.** The 500 MHz HMBC spectrum ( $^1J_{\text{HC}} = 4 \text{ Hz}$ ) of *cyclo*-(4-hydroxy-prolyl-4-hydroxy-prolyl-leucyl-phenylalanyl) (P132) (in  $\text{CDCl}_3$ ) (expanded from 0.6-4.4 ppm)



## VITA

Miss Chutima Jaruchoktaweechai was born on October 18, 1968 in Bangkok, Thailand. She received her Bachelor degree of Science in Pharmacy in 1991 from the Faculty of Pharmacy, Silpakorn University, Thailand. In 1991, she was a pharmacist in Potharam Hospital, Radchaburi, Thailand. In 1992, she transferred to work as a lecturer of Department of Pharmaceutical Chemistry, Faculty of Pharmacy, Silpakorn University, Nakornpathom, Thailand.



สถาบันวิทยบริการ  
จุฬาลงกรณ์มหาวิทยาลัย