

ผลของปริมาณความชื้น รูปร่างและขนาดของอนุภาคประกอบร่วมระหว่างแป้งข้าวเจ้า  
กับไมโครคริสตัลไลน์เซลลูโลสต่อการตอกเม็ด

นางรัชดา พัฒนสมบัติสกุล

วิทยานิพนธ์นี้เป็นส่วนหนึ่งของการศึกษาตามหลักสูตรปริญญาโทศึกษาศาสตร์มหาบัณฑิต  
สาขาวิชาเภสัชอุตสาหกรรม ภาควิชาวิทยาการเภสัชกรรมและเภสัชอุตสาหกรรม  
คณะเภสัชศาสตร์ จุฬาลงกรณ์มหาวิทยาลัย  
ปีการศึกษา 2554

ลิขสิทธิ์ของจุฬาลงกรณ์มหาวิทยาลัย

บทคัดย่อและแฟ้มข้อมูลฉบับเต็มของวิทยานิพนธ์ตั้งแต่ปีการศึกษา 2554 ที่ให้บริการในคลังปัญญาจุฬาฯ (CUIR)  
เป็นแฟ้มข้อมูลของนิสิตเจ้าของวิทยานิพนธ์ที่ส่งผ่านทางบัณฑิตวิทยาลัย

The abstract and full text of theses from the academic year 2011 in Chulalongkorn University Intellectual Repository (CUIR)  
are the thesis authors' files submitted through the Graduate School.



EFFECTS OF MOISTURE CONTENT, SHAPE AND PARTICLE SIZE OF COMPOSITE  
PARTICLES OF RICE STARCH AND MICROCRYSTALLINE CELLULOSE  
ON TABLETTING

Mrs. Ratchada Pattanasombatsakul

A Thesis Submitted in Partial Fulfillment of the Requirements  
for the Degree of Master of Science in Pharmacy Program in Industrial Pharmacy  
Department of Pharmaceutics and Industrial Pharmacy

Faculty of Pharmaceutical Sciences

Chulalongkorn University

Academic Year 2011

Copyright of Chulalongkorn University







รัชดา พัฒนสมบัติสกุล : ผลของปริมาณความชื้น รูปร่างและขนาดของอนุภาคประกอบร่วมระหว่างแป้งข้าวเจ้ากับไมโครคริสตัลลินเซลลูโลสต่อการตอกเม็ด. (EFFECTS OF MOISTURE CONTENT, SHAPE AND PARTICLE SIZE OF COMPOSITE PARTICLES OF RICE STARCH AND MICROCRYSTALLINE CELLULOSE ON TABLETTING) อ. ที่ปรึกษาวิทยานิพนธ์หลัก: รศ.ดร.พจน์ กุลวานิช, 95 หน้า.

การวิจัยนี้มีวัตถุประสงค์เพื่อศึกษาผลของปริมาณความชื้น รูปร่างและขนาดของอนุภาคประกอบร่วมระหว่างแป้งข้าวเจ้ากับไมโครคริสตัลลินเซลลูโลส ต่อคุณสมบัติการตอกอัดเป็นเม็ด โดยทำการเตรียมอนุภาคประกอบร่วมระหว่างแป้งข้าวเจ้ากับไมโครคริสตัลลินเซลลูโลส ในอัตราส่วน 7:3 ด้วยเทคนิคการพ่นแห้ง ทำการศึกษาเปรียบเทียบไมโครคริสตัลลินเซลลูโลสจาก 2 แหล่งผลิต คือ CEOLUS® PH 101 และ COMPRECEL® ทั้งนี้ก่อนใช้ได้นำมาคัดขนาดอนุภาคด้วยตะแกรงขนาด 45 เมชซึ่งมีรูเปิดขนาด 355 ไมครอน (CS) หรือทำการย่อยขนาดด้วยเครื่องบดด้วยลมพ่น (CJM) พบว่าเมื่อใช้ CS จะได้อนุภาคประกอบร่วมที่มีรูปร่างคล้าย ลูกกรักบี้ ขณะที่ใช้ CJM จะได้อนุภาคประกอบร่วมรูปทรงกลม การศึกษาคุณสมบัติของผงอนุภาคประกอบร่วมพบว่าดัชนีสภาพไหลได้ของอนุภาคประกอบร่วมที่เตรียมจากไมโครคริสตัลลินเซลลูโลสทั้ง 2 แหล่งผลิตได้ค่าใกล้เคียงกันแตเมื่อนำมาตอกอัดเป็นเม็ดโดยมีขนาดเม็ด 500 และ 350 มิลลิกรัม พบว่าอนุภาคประกอบร่วมที่ใช้ CEOLUS® PH 101 เป็นส่วนประกอบให้ความแข็งแรงของการตอกอัดมากกว่า COMPRECEL® เมื่อทำการศึกษาผลของอนุภาคประกอบร่วมที่ใช้ CEOLUS® PH 101 ที่มีปริมาณความชื้นร้อยละ 7.01, 10.79 และ 15.73 ต่อคุณสมบัติของการตอกอัดเป็นเม็ดโดยเฉพาะความแข็งแรงของเม็ดยา พบว่าความชื้นที่ระดับร้อยละ 15.73 ทำให้เม็ดยาแตกในลักษณะกะเทาะเป็นแผ่นและยังได้ทำการศึกษาเปรียบเทียบระหว่างอนุภาคประกอบร่วมกับ Eratab® ซึ่งเป็นแป้งข้าวเจ้าที่เตรียมโดยเทคนิคการพ่นแห้ง พบว่าที่ระดับความชื้นร้อยละ 10.79 เม็ดยาที่เตรียมจากอนุภาคประกอบร่วมจะมีความกร่อนที่ต่ำกว่า ความสัมพันธ์ระหว่างขนาดของอนุภาคประกอบร่วมกับการตอกอัดเป็นเม็ดยังสรุปได้ไม่ชัดเจน อาจเกิดจากการเลือกช่วงขนาดของอนุภาคประกอบร่วมที่นำมาทดลองยังไม่เหมาะสม ส่วนรูปร่างของอนุภาคประกอบร่วมจะมีผลต่อความแข็งแรงของเม็ดยาที่มีขนาด 350 มิลลิกรัม และแรงตอกอัดต่ำที่ 1 และ 1.5 เมตริกตัน โดยเม็ดยาที่ตอกจากอนุภาคประกอบร่วมที่ใช้ CJM ซึ่งมีรูปทรงกลมมีความแข็งแรงมากกว่าเม็ดยาที่ตอกจากอนุภาคประกอบร่วมที่ใช้ CS เป็นสารตั้งต้น ซึ่งมีรูปร่างคล้ายลูกกรักบี้

ภาควิชา วิทยาการเภสัชกรรมและเภสัชอุตสาหกรรม ลายมือชื่อนิติ.....

สาขาวิชา .....เภสัชอุตสาหกรรม..... ลายมือชื่อ อ.ที่ปรึกษาวิทยานิพนธ์หลัก.....

ปีการศึกษา.....2554.....

# # 5176582033 : MAJOR INDUSTRIAL PHARMACY

KEYWORDS : COMPOSITE PARTICLES OF RICE STARCH / MOISTURE CONTENT / PARTICLE SIZE / PARTICLE SHAPE / SPRAY DRYING

RATCHADA PATTANASOMBATSAKUL : EFFECTS OF MOISTURE CONTENT, SHAPE AND PARTICLE SIZE OF COMPOSITE PARTICLES OF RICE STARCH AND MICROCRYSTALLINE CELLULOSE ON TABLETTING. ADVISOR: ASSOC.PROF. POJ KULVANICH, 95 pp.

This study was to investigate the effects of moisture content, shape and particle size of composite particles between rice starch (RS) and microcrystalline cellulose (MCC) on tableting properties. The composite particles (RS:MCC) which composed of RS and MCC in the ratio of 7:3 were prepared by spray drying technique. MCC from two sources were used, CEOLUS<sup>®</sup> PH 101 and COMPRECEL<sup>®</sup>. Two groups of MCC were used, that passing through a sieve number 45 having an opening aperture of 355  $\mu\text{m}$  (CS) and that its size was reduced by jet mill (CJM). It was found that using CS produced composite particles in “rugby ball” shape while using CJM gave composite particles of spherical shape. Powder characterizations of RS:MCC prepared by using MCC from two sources gave similar flowability index. However, the hardness of the 500 mg and 350 mg RS:MCC tablets composed of CEOLUS<sup>®</sup> PH 101 was higher than composite particles using COMPRECEL<sup>®</sup>. The composite particles using CEOLUS<sup>®</sup> PH 101 which having 7.01, 10.79 and 15.73 percent moisture content exhibited different tableting properties in particular the hardness of tablet. Capping of tablet was found at 15.73 percent of moisture content level. Moreover, comparing with commercial spray dried rice starch without MCC (Eratab<sup>®</sup>), the Eratab<sup>®</sup> tablets were likely to be friable than RS:MCC tablets at the moisture content of approximately 10.79%. The relationship of particle sizes of RS:MCC composite particles with their tableting properties was unclear. Perhaps, the particle size range of RS:MCC composite particles chosen for the study was inappropriate. Particle shape of RS:MCC composite particles especially affected on the hardness of 350 mg tablet when compressed with lower force as 1 and 1.5 metric tons. Tablets made from spherical shape RS:MCC (using CJM as starting materials) was harder than those of made from “rugby ball” shape RS:MCC (using CS as starting materials).

Department : Pharmaceutics and Industrial Pharmacy

Student's Signature .....

Field of Study : Industrial Pharmacy

Advisor's Signature .....

Academic Year : 2011



## ACKNOWLEDGEMENTS

I would like to express my sincere gratitude to my thesis advisor Associate Professor Poj Kulvanich for the meaningful advices, invaluable guidance, and encouragement throughout my investigation. His patience, kindness, comments, helpful suggestions and understanding are also profoundly appreciated.

I wish to express appreciation to Associate Professor Kraisri Umprayn, Ph.D., Narueporn Sutanthavibul, Ph.D., Jittima Chatchawalsaisin, Ph.D., Vasinee Limwong, Ph.D. to as members of the thesis committee for their valuable suggestion and comments.

The acknowledgement is given to all staffs of Faculty of Pharmaceutical Sciences, Chulalongkorn University, especially the staff of the Department of Manufacturing Pharmacy, for their assistant support.

I would like to acknowledge the CU.GRADUATE SCHOOL THESIS GRANT, Graduate School, Chulalongkorn University for granting the financial support to fulfill this thesis and to express gratitude to Cho Heng Rice Vermicelli Factory Co. Ltd., Nakhon Pathom, Thailand, for providing rice starch

I wish to express thanks are due to Powder Technology Center, Faculty of Engineering, Chulalongkorn University for the use of the powder characteristics tester.

I am thankful to my charming friends for their companionship and other people whose names have not been mentioned for their great help and support.

Finally, I would like to thank my father, my mother, my husband, my sons and my sister for their endless love, understanding, care encouragement continuous support and cheerfulness which carried me through.

# CONTENTS

|  | Page |
|--|------|
| ABSTRACT (THAI).....   | iv   |
| ABSTRACT (ENGLISH).....  | v    |
| ACKNOWLEDGEMENTS.....  | vi   |
| CONTENTS.....  | vii  |
| LIST OF TABLES.....  | viii |
| LIST OF FIGURES.....   | xi   |
| LIST OF ABBREVIATIONS.....   | xv   |
| CHAPTER  |      |
| I    INTRODUCTION.....   | 1    |
| II   LITERATURE REVIEW.....  | 4    |
| III  EXPERIMENTAL.....   | 14   |
| Materials.....   | 14   |
| Apparatus.....   | 15   |
| Methods.....   | 16   |
| 1. Composite particles of rice starch and microcrystalline<br>cellulose.....             | 16   |
| 2. Tableting of composite particles.....   | 19   |
| IV  RESULTS AND DISCUSSION   |      |
| 1. Characterization of microcrystalline cellulose and rice<br>starch.....                | 24   |
| 2. Preparation and characterization of RS:MCC composites<br>particles for tableting..... | 28   |
| 3. Tableting of composite particles.....   | 42   |
| V   CONCLUSION.....  | 78   |
| REFERENCES.....  | 79   |
| APPENDICES.....  | 85   |
| VITAE.....   | 95   |



## LIST OF TABLES

| <b>Table</b>   | <b>Page</b> |
|--|-------------|
| 2-1 Sample size should be used in the Karl Fischer titration.....  | 10          |
| 2-2 Size and Shape parameters (Morphologi G3 <sup>®</sup> ).....   | 13          |
| 3-1 Degree of flowability and flowability index.....   | 19          |
| 4-1 Particle size and size distribution of RS, CJM (jet milled MCC) from two manufacturing sources and commercial spray dried rice starch; average (SD), n =3.....   | 28          |
| 4-2 Particle size and size distribution of composite particles produced from CJM (jet milled MCC) of different sources; average (SD), n =3.....  | 31          |
| 4-3 Yield and flow properties of composite particles produced from CJM (jet milled MCC) of two manufacturing sources; average (SD), n = 3.....   | 32          |
| 4-4 Moisture content of composite particles produced from CJM (jet milled CEOLUS <sup>®</sup> PH 101).....   | 33          |
| 4-5 Moisture content of MCC (CEOLUS <sup>®</sup> PH 101).....  | 33          |
| 4-6 Moisture sorption rate of spray dried rice starch (Eratab <sup>®</sup> ).....  | 34          |
| 4-7 Particle size and size distribution of sieved composite particles produced from CJM (jet milled MCC) of CEOLUS <sup>®</sup> PH 101 and passed through different sieve opening size; average (SD), n =3....                     | 36          |
| 4-8 Shape factors of composite particles using MCC from CEOLUS <sup>®</sup> PH101 which passed through 355 $\mu$ m mesh width (CS) and that the size was reduced by jet mill (CJM).....  | 39          |
| 4-9 Particle size and size distribution of composite particles using MCC from CEOLUS <sup>®</sup> PH101 which passed through 355 $\mu$ m mesh width (CS) and that the size was reduced by jet mill (CJM); average (SD), n = 3..... | 41          |



| <b>Table</b>  | <b>Page</b> |
|---|-------------|
| 4-10 Flow properties of composite particles using MCC from CEOLUS <sup>®</sup> PH101 which passed through 355 $\mu\text{m}$ mesh width (CS) and that the size was reduced by jet mill (CJM); average (SD), n = 3..... | 42          |
| 4-11 Physical properties of 500 mg RS:MCC tablets produced from two manufacturing sources of MCC (CEOLUS <sup>®</sup> PH101 and COMPRECEL <sup>®</sup> ), average (SD).....   | 43          |
| 4-12 Physical properties of 350 mg RS:MCC tablets produced from two manufacturing sources of MCC (CEOLUS <sup>®</sup> PH101 and COMPRECEL <sup>®</sup> ), average (SD).....   | 44          |
| 4-13 Physical properties of 500 mg tablets of RS:MCC containing different moisture contents, average (SD).....  | 49          |
| 4-14 Physical properties of 350 mg tablets of RS:MCC containing different moisture contents, average (SD).....  | 50          |
| 4-15 Physical properties of 500 mg tablets of MCC containing different moisture contents, average (SD).....   | 56          |
| 4-16 Physical properties of 350 mg tablets of MCC containing different moisture contents, average (SD).....   | 57          |
| 4-17 Physical properties of 500 mg tablets of commercial spray dried rice starch (Eratab <sup>®</sup> ) containing different moisture contents, average (SD).....   | 62          |
| 4-18 Physical properties of 350 mg tablets of commercial spray dried rice starch (Eratab <sup>®</sup> ) containing different moisture contents, average (SD).....   | 63          |
| 4-19 Physical properties of 500 mg RS:MCC tablets using RS: MCC composite particles passed through mesh size of 45 $\mu\text{m}$ , 75 $\mu\text{m}$ and 150 $\mu\text{m}$ , average (SD).....                         | 68          |
| 4-20 Physical properties of 350 mg RS:MCC tablets using RS: MCC composite particles passed through mesh size of 45 $\mu\text{m}$ , 75 $\mu\text{m}$ and 150 $\mu\text{m}$ , average (SD).....                         | 69          |

| <b>Table</b> |   | <b>Page</b> |
|--------------|---|-------------|
| 4-21         | Physical properties of 500 mg RS:MCC tablets containing MCC passed through 355 $\mu$ m mesh width (CS), or MCC that the size was reduced by jet mill (CJM); average (SD)..... | 73          |
| 4-22         | Physical properties of 350 mg RS:MCC tablets containing MCC passed through 355 $\mu$ m mesh width (CS), or MCC that the size was reduced by jet mill (CJM); average (SD)..... | 74          |

## LIST OF FIGURES

| <b>Figure</b> |   | <b>Page</b> |
|---------------|---|-------------|
| 2-1           | The polymeric structure of glucose in starch tends to be amorphous.....   | 4           |
| 2-2           | Structural formula of microcrystalline cellulose.....   | 6           |
| 2-3           | Cocurrent spray dryer with rotary atomizer and pneumatic conveying of dried powder.....   | 8           |
| 2-4           | Calculation of CE diameter.....   | 12          |
| 2-5           | Key dimensions of particle size and shape analysis.....   | 13          |
| 3-1           | The Hosokawa Powder Tester for measuring the aerated and packed bulk densities.....   | 18          |
| 3-2           | Image analysis systems capture a 2D image of the 3D particle.....   | 22          |
| 4-1           | SEM photomicrographs of MCC from CEOLUS <sup>®</sup> PH 101: (a-b) CEOLUS <sup>®</sup> PH 101 as received; (c-d) CS, MCC passed through 355 $\mu$ m mesh width; (e-f) CJM, MCC that the size was reduced by jet mill..... | 25          |
| 4-2           | SEM photomicrographs of MCC from COMPRECEL <sup>®</sup> : (a-b) COMPRECEL <sup>®</sup> as received; (c-d) CS, MCC passed through 355 $\mu$ m mesh width; (e-f) CJM, MCC that the size was reduced by jet mill.....        | 26          |
| 4-3           | SEM photomicrographs of RS.....   | 27          |
| 4-4           | SEM photomicrographs of commercial spray dried rice starch (Eratab <sup>®</sup> ).....  | 27          |
| 4-5           | SEM photomicrographs of spray dried product using MCC from CEOLUS <sup>®</sup> PH 101: (a-b) CS, MCC passed through 355 $\mu$ m mesh width; (c-d) CJM, MCC that the size was reduced by jet mill.....                     | 29          |
| 4-6           | SEM photomicrographs of spray dried product using MCC from COMPRECEL <sup>®</sup> : (a-b) CS, MCC passed through 355 $\mu$ m mesh width; (c-d) CJM, MCC that the size was reduced by jet mill.....                        | 30          |

| <b>Figure</b> |  | <b>Page</b> |
|---------------|--|-------------|
| 4-7           | SEM photomicrographs of spray dried product using MCC from CEOLUS <sup>®</sup> PH101. Its size was reduced by jet mill and passed through sieve with mesh width (a-b) 45 $\mu\text{m}$ ; (c-d) 75 $\mu\text{m}$ (e-f) 150 $\mu\text{m}$ .....  | 35          |
| 4-8           | SEM photomicrographs of spray dried product using MCC from CEOLUS <sup>®</sup> PH101: (a-b) CS, MCC passed through 355 $\mu\text{m}$ mesh width; (c-d) CJM, MCC that the size was reduced by jet mill.....   | 37          |
| 4-9           | Examples of automated images of RS:MCC (CS) composite particles.....   | 38          |
| 4-10          | Examples of automated images of RS:MCC (CJM) composite particles.....  | 39          |
| 4-11          | Scattergram showing relationship between CE diameter and circularity of composite particles using MCC from (a) CEOLUS <sup>®</sup> PH101 which passed through 355 $\mu\text{m}$ mesh width (CS) and (b) CEOLUS <sup>®</sup> PH101 which that the size was reduced by jet mill (CJM)..... | 40          |
| 4-12          | Relationship between pressure and hardness of 500 mg RS:MCC tablets produced from two manufacturing sources of MCC (CEOLUS <sup>®</sup> PH101 and COMPRECEL <sup>®</sup> )   | 45          |
| 4-13          | Relationship between pressure and hardness of 350 mg RS:MCC tablets produced from two manufacturing sources of MCC (CEOLUS <sup>®</sup> PH101 and COMPRECEL <sup>®</sup> )   | 45          |
| 4-14          | Relationship between pressure and thickness of 500 mg RS:MCC tablets produced from two manufacturing sources of MCC (CEOLUS <sup>®</sup> PH101 and COMPRECEL <sup>®</sup> )  | 46          |
| 4-15          | Relationship between pressure and thickness of 350 mg RS:MCC tablets produced from two manufacturing sources of MCC (CEOLUS <sup>®</sup> PH101 and COMPRECEL <sup>®</sup> )  | 46          |
| 4-16          | Relationship between pressure and diameter of 500 mg RS:MCC tablets produced from two manufacturing sources of MCC (CEOLUS <sup>®</sup> PH101 and COMPRECEL <sup>®</sup> )   | 47          |

| <b>Figure</b> |  | <b>Page</b> |
|---------------|--|-------------|
| 4-17          | Relationship between pressure and diameter of 350 mg RS:MCC tablets produced from two manufacturing sources of MCC (CEOLUS <sup>®</sup> PH101 and COMPRECEL <sup>®</sup> ) | 47          |
| 4-18          | Capping of RS:MCC (CEOLUS <sup>®</sup> PH101) tablets with 15.73%.....   | 50          |
| 4-19          | Relationship between moisture content and hardness of 500 mg RS:MCC tablets.....   | 51          |
| 4-20          | Relationship between moisture content and hardness of 350 mg RS:MCC tablets.....   | 51          |
| 4-21          | Relationship between moisture content and thickness of 500 mg RS:MCC tablets.....  | 52          |
| 4-22          | Relationship between moisture content and thickness of 350 mg RS:MCC tablets.....  | 52          |
| 4-23          | Relationship between moisture content and diameter of 500 mg RS:MCC tablets.....   | 53          |
| 4-24          | Relationship between moisture content and diameter of 350 mg RS:MCC tablets.....   | 53          |
| 4-25          | Relationship between moisture content and hardness of 500 mg MCC tablets.....  | 58          |
| 4-26          | Relationship between moisture content and hardness of 350 mg MCC tablets.....  | 58          |
| 4-27          | Relationship between moisture content and thickness of 500 mg MCC tablets.....   | 59          |
| 4-28          | Relationship between moisture content and thickness of 350 mg MCC tablets.....   | 59          |
| 4-29          | Relationship between moisture content and diameter of 500 mg MCC tablets.....  | 60          |
| 4-30          | Relationship between moisture content and diameter of 350 mg MCC tablets.....  | 60          |
| 4-31          | Relationship between moisture content and hardness of 500 mg Eratab <sup>®</sup> tablets.....  | 64          |

| <b>Figure</b> |   | <b>Page</b> |
|---------------|---|-------------|
| 4-32          | Relationship between moisture content and hardness of 350 mg Eratab <sup>®</sup> tablets.....   | 64          |
| 4-33          | Relationship between moisture content and thickness of 500 mg Eratab <sup>®</sup> tablets.....  | 65          |
| 4-34          | Relationship between moisture content and thickness of 350 mg Eratab <sup>®</sup> tablets.....  | 65          |
| 4-35          | Relationship between moisture content and diameter of 500 mg Eratab <sup>®</sup> tablets.....   | 66          |
| 4-36          | Relationship between moisture content and diameter of 350 mg Eratab <sup>®</sup> tablets.....   | 66          |
| 4-37          | Relationship between particle size and hardness of 500 mg RS:MCC tablets using RS: MCC composite particles passed through mesh size of 45 $\mu\text{m}$ , 75 $\mu\text{m}$ and 150 $\mu\text{m}$ ...  | 70          |
| 4-38          | Relationship between particle size and hardness of 350 mg RS:MCC tablets using RS: MCC composite particles passed through mesh size of 45 $\mu\text{m}$ , 75 $\mu\text{m}$ and 150 $\mu\text{m}$ ...  | 70          |
| 4-39          | Relationship between particle size and thickness of 500 mg RS:MCC tablets using RS: MCC composite particles passed through mesh size of 45 $\mu\text{m}$ , 75 $\mu\text{m}$ and 150 $\mu\text{m}$ ... | 71          |
| 4-40          | Relationship between particle size and thickness of 350 mg RS:MCC tablets using RS: MCC composite particles passed through mesh size of 45 $\mu\text{m}$ , 75 $\mu\text{m}$ and 150 $\mu\text{m}$ ... | 71          |
| 4-41          | Relationship between particle size and diameter of 500 mg RS:MCC tablets using RS: MCC composite particles passed through mesh size of 45 $\mu\text{m}$ , 75 $\mu\text{m}$ and 150 $\mu\text{m}$ ...  | 72          |
| 4-42          | Relationship between particle size and diameter of 350 mg RS:MCC tablets using RS: MCC composite particles passed through mesh size of 45 $\mu\text{m}$ , 75 $\mu\text{m}$ and 150 $\mu\text{m}$ ...  | 72          |
| 4-43          | Relationship between particle shape and hardness of 500 mg RS:MCC tablets containing MCC passed through 355 $\mu\text{m}$ mesh width (CS), or MCC that the size was reduced by jet mill (CJM).....    | 75          |

| <b>Figure</b> |   | <b>Page</b> |
|---------------|---|-------------|
| 4-44          | Relationship between particle shape and hardness of 350 mg RS:MCC tablets containing MCC passed through 355 $\mu\text{m}$ mesh width (CS), or MCC that the size was reduced by jet mill (CJM).....    | 75          |
| 4-45          | Relationship between moisture content and thickness of 500 mg RS:MCC tablets containing MCC passed through 355 $\mu\text{m}$ mesh width (CS), or MCC that the size was reduced by jet mill (CJM)..... | 76          |
| 4-46          | Relationship between particle shape and thickness of 350 mg RS:MCC tablets containing MCC passed through 355 $\mu\text{m}$ mesh width (CS), or MCC that the size was reduced by jet mill (CJM).....   | 76          |
| 4-47          | Relationship between moisture content and diameter of 500 mg RS:MCC tablets containing MCC passed through 355 $\mu\text{m}$ mesh width (CS), or MCC that the size was reduced by jet mill (CJM).....  | 77          |
| 4-48          | Relationship between particle shape and diameter of 350 mg RS:MCC tablets containing MCC passed through 355 $\mu\text{m}$ mesh width (CS), or MCC that the size was reduced by jet mill (CJM).....    | 77          |

## LIST OF ABBREVIATIONS

|                          |  |
|--------------------------|--|
| %                        | percentage   |
| $\mu\text{m}$            | Micrometer (s)   |
| $\mu\text{m}$            | micrometer (s)   |
| CE diameter              | Circle Equivalence diameter  |
| CJM                      | composite particles was prepared by reduced microcrystalline cellulose by jet mill               |
| CS                       | composite particles was prepared by passing microcrystalline cellulose through a sieve number 45 |
| $D(v,0.1)$               | 10% of the distribution is below this value  |
| $D(v,0.5)$               | 50% of the distribution is below this value  |
| $D(v,0.9)$               | 90% of the distribution is below this value  |
| DT                       | disintegration time  |
| et.al                    | et alli, and other   |
| g                        | gram(s)  |
| HS circularity           | High Sensitivity circularity   |
| i.e.                     | id est   |
| $\text{KNO}_3$           | Potassium nitrate  |
| $\text{Li}_2\text{SO}_4$ | Lithium sulphate   |
| MCC                      | microcrystalline cellulose   |
| mg                       | milligram (s)  |



|                                   |   |
|-----------------------------------|---|
| Mg(NO <sub>3</sub> ) <sub>2</sub> | Magnesium nitrate   |
| MgCl <sub>2</sub>                 | Magnesium chloride  |
| min                               | minute (s)  |
| ml                                | milliliter (s)  |
| mm                                | millimeter (s)  |
| N                                 | newton  |
| NaCl                              | Sodium chloride   |
| No.                               | number  |
| °C                                | degree Celsius (centigrade)                                       |
| RH                                | relative humidity   |
| RS                                | rice starch   |
| RS:MCC                            | composite particles of rice starch and microcrystalline cellulose |
| SD                                | standard deviation  |
| SEM                               | scanning electron microscope                                      |
| temp                              | temperature   |

# CHAPTER I

## INTRODUCTION

Direct compression technique is a tablet production method by which the processing steps are composed of mixing all ingredients including active ingredient(s) and excipients, then compressing the mixed powders without subsection to the granulation step. The important excipient in this process is a directly compressible diluent (DC diluent) which has two main important properties: flowability and compressibility. A number of materials from several sources have been produced to act as DC diluents, for example, lactose, sucrose, starch, cellulose and inorganic material.

DC diluents required in formulation of direct compression tablets usually possess a good flowability, good binding property, a well-designed particle size distribution which is favorable to mixing step, and compatibility with the active ingredient and other excipients. They should also have capacity to take high amounts of the active ingredient. Presently, only a few materials meet the criteria to allow their classification as DC diluents. The physical properties of these DC diluents are critical for their proper use (Zhang et al., 2003).

Principally, starch is an excipient used in oral solid-dosage forms where it is utilized as a binder, diluent, and disintegrant. As a diluent, starch is used for the preparation of standardized triturates of colorants or potent drugs to facilitate subsequent mixing or blending processes in manufacturing process. Comparing among natural starches in their applicability for tablet compression, rice starch provided much better compaction properties than potato, maize and tapioca starches. However, rice starch possessed the worst flowability due to its very fine particle size. A spray-dried rice starch of trade name “Era-Tab<sup>®</sup>” is marketed in Thailand was found to have good flowability and compaction properties. This was because the material particles were in spherical shape and were made up completely of agglomerates of rice starch grains that are moderately uniform in size. Compaction of this spray-dried starch could be created by deaggregation and fixed packing without

requiring high pressure. As a result, the compactibility of spray dried rice starch was excellent and it could be utilized as a good direct compression tablet excipient regarding to dissolution. Spray dried rice starch-based tablets provide fast and complete drugs release regardless of their solubility. In the recent investigation, it was reported that, spray dried, acid-modified tapioca starch helped improving tablet properties even more while of the tablets crushing strength could be increased with extended time of acid hydrolysis (Rowe et al., 2006).

Microcrystalline cellulose (MCC) is considered as the best excipient for direct compression tableting. Various papers have described many preparation methods of a pharmaceutical-grade MCC from a cotton absorbent. Nonetheless, there is a constant search for new sources of MCC because of the cost of commercially usable products are relatively high. Conventionally, MCC can be prepared from bamboo, wood pulp, and viscose rayon. There are attempts to produce MCC from other sources such as newsprint waste, hosiery waste, and corncobs, as well as from fast-growing plants including *Sesbania sesban*, *S roxburghii*, and *Crotalaria juncea*. Also the particle size distribution, packing, and flow properties of MCC, as well as the tableting and disintegration characteristics, are well recognized. In the market, there are several grades of microcrystalline cellulose which are different manufacturing method, particle size, moisture, flow, and other physical properties. Generally, the larger particle-size grades offer better flow properties in tableting process. On the other hand, low moisture grades are utilized with moisture sensitive materials. Higher density grades have improved flowability. Moreover, several coprocessed mixtures of microcrystalline cellulose with other excipients such as carrageenan, carboxymethylcellulose sodium, and guar gum are available commercially. (Rowe et al., 2006)

In recent years, Limwong et al., (2004) evaluated the powder and compression properties of composite particles used as direct compressible excipient produced from spray-drying technique of RS and MCC. The composite particles were mixed in various ratios by using two size fractions of MCC, sieved and jet milled, having volumetric mean diameter ( $D_{50}$ ) of 40.51 and 13.61  $\mu\text{m}$ , respectively, with RS. An increase in MCC proportion formed less spherical particles with rougher surface

resulting in a decrease in the degree of flowability. There was no difference on the compressibility between the composite particles generated from different size fractions of MCC. They also found that using jet milled MCC provided more spherical particles than using sieved MCC. They evaluated the powder properties and compressibility of composite particles between RS and jet milled MCC in ratio of 7:3 (RS-Jet milled MCC-73) and some marketed directly compressible diluents. The results showed that these developed composite particles could be used as a coprocessed direct compression excipient : the compressibility of RS-Jet milled MCC-73 was greater than commercial spray dried RS (Eratab<sup>®</sup>), coprocessed lactose and microcrystalline cellulose (Cellactose<sup>®</sup>), and agglomerated lactose (Tablettose<sup>®</sup>), but lower than microcrystalline cellulose (Vivapur<sup>®</sup> 101). Flowability index of these composite particles was slightly lower than Eratab<sup>®</sup> but higher than Vivapur<sup>®</sup> 101, Cellactose<sup>®</sup>, and Tablettose<sup>®</sup>. Tablets with RS-Jet milled MCC-73 had low friability and good self-disintegrating property. However, this report described only the preparation of the composite particles between rice starch and MCC by using spray-drying technique. The composite particles produced were solely evaluated for their powder and tableting properties. A review of the literature showed no report on the effect of different sources of MCC, moisture content, particle size and shape of composite particles between RS and MCC on tableting properties.

**The purposes of this study were as follows:**

1. To study effects of moisture content, particle size and shape of composite particles between rice starch (RS) and microcrystalline cellulose (MCC) on tableting properties.
2. To study effects of different sources of MCC to prepared composite particles on tableting properties.

# CHAPTER II

## LITERATURE REVIEW

The advantages of direct compression for tablet productions are simplicity, reduced the stages of manufacturing process and required equipments. As a result, the labor and energy cost are lower and the processing time is reduced.

Many excipients have been assessed for safety but due to the development of new chemical entities for use as excipients is not economically feasible. Hence, the development of excipients will take the form of chemical or physical modification of existing materials, or by the use of combinations of exiting materials to improve or extend their functionality.

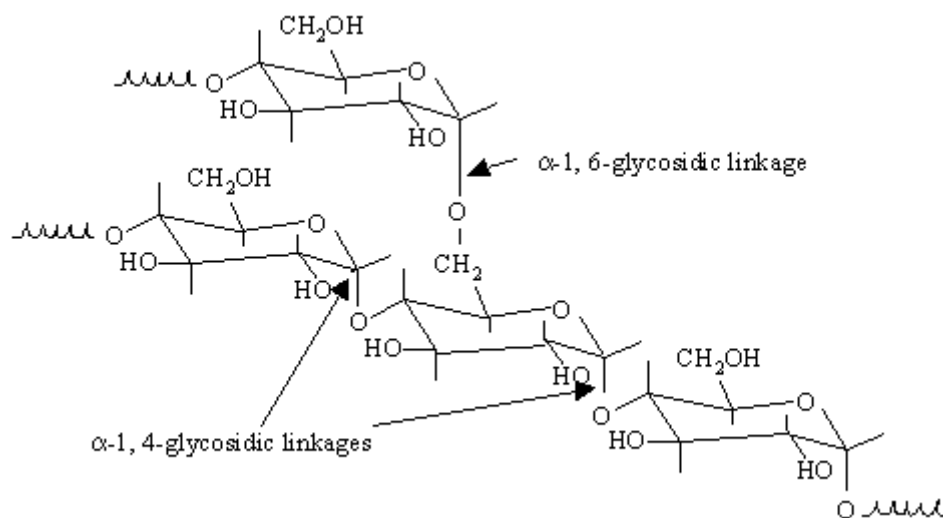

Figure 2-1 The polymeric structure of glucose in starch tends to be amorphous (<http://www.nrel.gov/biomass/glossary.html/27/04/12>)

Hauschild et al., (2004) studied the characteristic of StarLac<sup>®</sup>, a new coprocessed compound for direct compression based on lactose and maize starch. They considered the effects of maize starch and spray-dried lactose and investigated the influence of the spray-drying process by comparing the physical mixture of starch

and spray-dried lactose at the same ratio as StarLac<sup>®</sup>. They found that StarLac<sup>®</sup> demonstrated good compactibility and fast release. For deformation properties, StarLac<sup>®</sup> exhibited deformation behavior with higher parts of plastic and elastic deformation than physical mixture which is of interest for the manufacture of pressure sensitive drugs.

Mitrevej et al., (1996) compared the flowability and tableting properties of Spray-dried rice starch (SDRS), microcrystalline cellulose (MCC), Lactose (L), pregelatinized starch (PS) and dibasic calcium phosphate (DCP). This study showed that SDRS and DCP exhibited excellent flowability. PS flowed moderately while L and MCC exhibited flow problems. The hardness of tablets when increased magnesium stearate for L and DCP was not affected but was reduced for MCC and SDRS while PS tablets were unsatisfactory. Disintegration of SDRS and MCC were found to be independent of the compression force and lubricant level while L tablets was prolonged with the increased lubricant concentration. The disintegration time of PS tablets seemed to be decreased due to softened tablets. Ascorbic acid was added to each filler and found that MCC was the best dilution potential while PS was the worst. SDRS, L and DCP had comparable carrying capacities. This study found that SDRS offered excellent flowability, compactibility and disintegration property with acceptable carrying capacity. Dissolution of the drug from SDRS based regardless of the solubility of active drug was fast and complete. Hence, SDRS possessed desirable properties for direct compression filler.

Pesonen et al., (1990) suggested that MCC is the best binding materials available for direct compression. Extensive hydrogen bonding, large particle surface area and mechanical interlocking of irregular particles have been declared to supply the excellent binding properties of this material, but on the other hand, the effect of crystallinity, particle size and shape on the mechanical properties of cellulose tablets have been difficulty. However, has stated the importance of crystallographic state of material saying, that it affects even more than the chemical nature of the material the tendency of the material to undergo plastic deformation, which is essential in the formation of a strong tablet. Bhimte et al. (2007) suggested that the moisture sorption of the cellulose is related to the crystallinity of the MCC powders and the low values of moisture content are indicative of higher crystallinity.

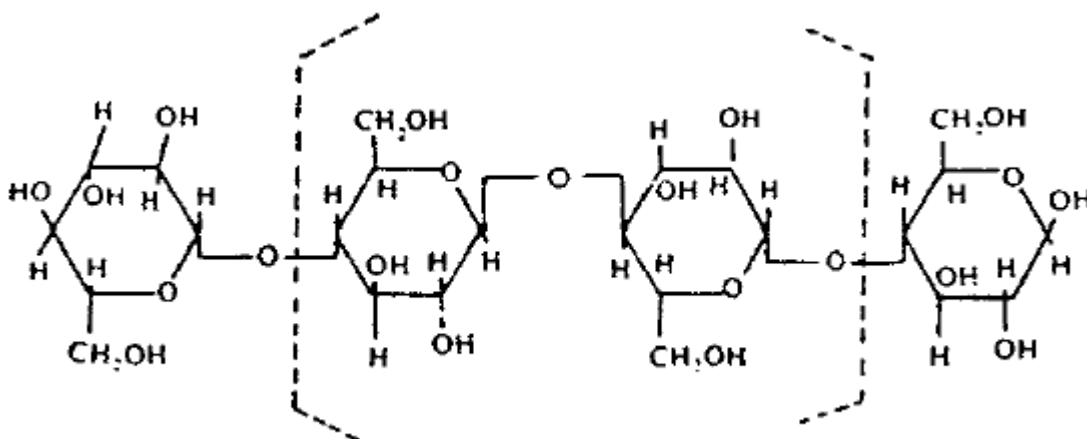

Figure 2-2 Structural formula of microcrystalline cellulose. (Westermarck S., 2000)

Mitrevej et al., (1996) studied the compression behavior of Spray dried rice starch (SDRS), an agglomerated sphere shape rice starch, which is marketed in Thailand under the trade name of Eratab<sup>®</sup> compared with pregelatinized starch (PS) and microcrystalline cellulose (MCC). SDRS was found to undergo plastic deformation with increasing pressure. It exhibited lower elasticity than PS and showed very low fragmentation tendency. Both good compactibility and flowability properties made SDRS a high potential for an excipient of direct compression tableting.

Hsu et al., (1997) evaluated Eratab<sup>®</sup> compared with 4 direct compression (DC) excipients (Avicel PH-101, partially pregelatinized starch (PPS), Super-Tab<sup>®</sup> lactose and Emcompress<sup>®</sup>) in term of physical and compressional properties. They found that the flowability of Eratab<sup>®</sup> was excellent and had more compressibility than other DC excipients except MCC. Tablets prepared by Eratab<sup>®</sup> exhibited good disintegration and dissolution properties. Hence, it can be a good choice for DC excipient in tablet preparation.

Bos et al., (1992) evaluated the compression characteristics of modified rice starch (Primotab<sup>®</sup>ET) which is an agglomerated rice starch product. Its flowability and disintegration properties are excellent. The model tablet containing oxazepam prepared by using Modified rice starch as unique filler-binder or blend of equal parts of modified rice starch and a commonly used filler- binder showed that it was useful

for direct compression either as a unique filler-binder or in combination with other excipients. Combinations with microcrystalline cellulose should be avoided because of the poor flowability of the blends and the slow disintegration of the tablets.

Landin et al., (1992) studied the influence of MCC from various source and batch variation used as filler binders in prednisolone tablet. They evaluated mechanical, microstructural and drug release properties both immediately after preparation and after storage for 2 or 4 months at a relative humidity of 90%. They found that the mechanical and microstructural properties of tablets produced from similar particle size MCC were the same. In the stability study, there were significant changes in mechanical and drug release properties due to the interaction between MCC and water. This study confirmed the importance of characterization the raw materials used in the product to find the effects on the quality of drug preparation from their variation in sources and batches.

Albers et al., (2006) examined the uniformity of Microcrystalline Cellulose (MCC) type 101 in Direct tableting with a pneumohydraulic tablet press from five manufacturers for three batches each. This study was to determine the variation of brand to brand and batch to batch of MCC though they achieved the compendia specifications. The pneumohydraulic tablet press is used due to its flexible adjustability of the compression parameters. From this investigation, the characterizations of the MCC powder different slightly except for the particle size, the specific surface area and the flowability. The study also found that the 15 batches have different tableting behavior and tablet characteristic. Hence, the MCC from different manufacturers and even within a supplier has no uniformity and this should be taken into account for the formulator to adjust the production process when changing the batch or brand of MCC.

Timaroon et al., (1993) investigated the modified rice starch by deproteinization and crosslinking reaction before spray drying technique. They found rice starch which were deproteinized and crosslinked for 6 hours before being spray-dried exhibited the best tableting properties. When compared with other commercial modified starch products, modified rice starch derived by the process in this study gave higher tablet hardness with shorter disintegration time.



Weecharangsan et al., (1995) investigated to examine the powder characteristics and tableting properties of modified rice starch compared with the other direct compression diluents as Eratab<sup>®</sup>, Starch<sup>®</sup> 1500, Avicel<sup>®</sup>PH102 and Emcompress<sup>®</sup>. They found that this modified rice starch had the higher compressibility than other direct compression diluents but lower than Avicel<sup>®</sup>PH102. Tablets containing Isoniazid represented water soluble drug and Hydrochlorothiazide represented water insoluble drug gave the excellent results in physical and dissolution properties.

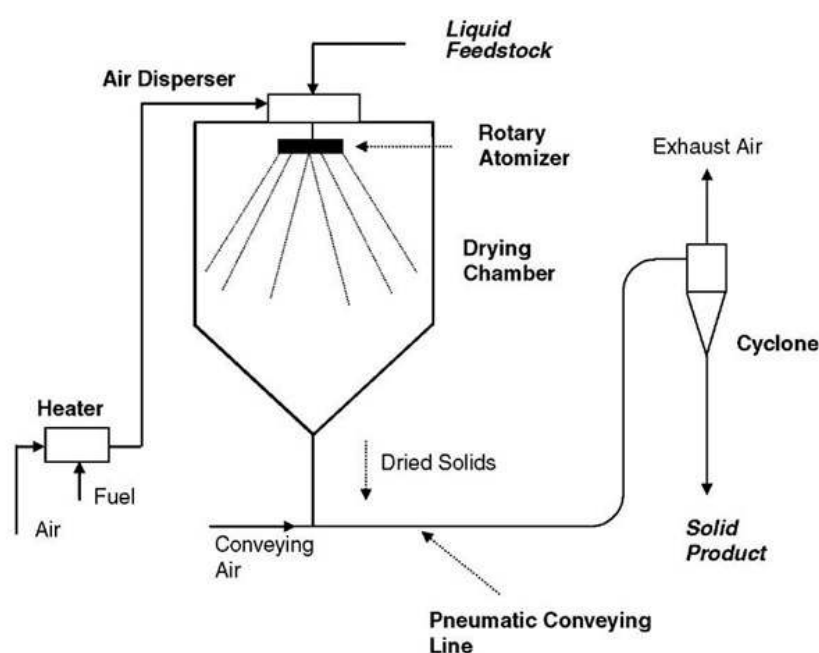

Figure 2-3 Cocurrent spray dryer with rotary atomizer and pneumatic conveying of dried powder. (<http://what-when-how.com/energy-engineering/drying-operations-industrial-energy-engineering/26/04/12>)

Limwong et al., (2004) evaluated the powder and compression properties of composite particles used as direct compressible excipient produced from spray-drying technique of rice starch (RS) and microcrystalline cellulose (MCC). The composite particles were mixed in various ratios by using two size fractions of MCC, sieved (MCS) and jet milled (MCJ), having volumetric mean diameter ( $D_{50}$ ) of 13.61 and 40.51  $\mu\text{m}$ , respectively with RS. An increase in MCC proportion formed less spherical particles with rougher surface resulting in a decrease in the degree of

flowability. There was no difference on the compressibility between the composite particles made from different size fractions of MCC. They also found that using MCJ provided more spherical particles than using MCS. They evaluated the powder properties and compressibility of composite particles between RS and MCJ in ratio of 7:3 (RS-MCJ-73) and compare with some marketed directly compressible diluents. The results showed that these developed composite particles could be used as a new coprocessed direct compression excipient : the compressibility of RS-MCJ-73 was greater than commercial spray-dried RS (Eratab<sup>®</sup>), coprocessed lactose and MCC (Cellactose<sup>®</sup>), and agglomerated lactose (Tabletose<sup>®</sup>), but lower than MCC (Vivapur 101<sup>®</sup>), tablets with used RS-MCJ-73 had low friability and good self-disintegrating property, and flowability index of this new composite particles was slightly lower than Eratab<sup>®</sup> but higher than Vivapur<sup>®</sup> 101, Cellactose<sup>®</sup>, and Tabletose<sup>®</sup>.

Khan et al., (1981) studied the effect of moisture content of MCC on the compression properties of formulation contained 97 % MCC and two MCC based formulations containing 49.5 % paracetamol and 68 % potassium phenethicillin. Moisture level of MCC that were used in this study was ranged from 0.6-7.3%. They suggested that if the dried MCC is used in formulation with moisture sensitive product, the specification of moisture content for MCC should be tighten.

Karl Fischer titration is a widely used analytical method for quantifying water content in a variety of products. The fundamental principle behind it is based on the Bunsen Reaction between iodine and sulfur dioxide in an aqueous medium. Karl Fischer discovered that this reaction could be modified to be used for the determination of water in a non-aqueous system containing an excess of sulphur dioxide. He used a primary alcohol (methanol) as the solvent, and a base (pyridine) as the buffering agent.

### **The Karl Fischer Reaction**

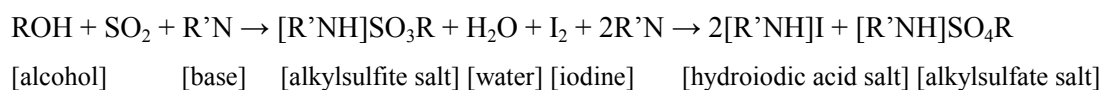

The alcohol reacts with sulfur dioxide (SO<sub>2</sub>) and base to form an intermediate alkylsulfite salt, which is then oxidized by iodine to an alkylsulfate salt. This oxidation reaction consumes water. The reactive alcohol is typically methanol or 2-(2-

Ethoxyethoxy) ethanol, also known as diethylene glycol monoethyl ether (DEGEE), or another suitable alcohol. Classic Karl Fisher reagents contained pyridine, a noxious carcinogen, as the base. The reagents most frequently used today are pyridine-free and contain imidazole or primary amines instead. Water and iodine are consumed in a 1:1 ratio in the above reaction. Once all of the water present is consumed, the presence of excess iodine is detected voltametrically by the titrator's indicator electrode. That signals the end-point of the titration. The amount of water present in the sample is calculated based on the concentration of iodine in the Karl Fisher titrating reagent (i.e., titer) and the amount of Karl Fisher Reagent consumed in the titration. The amount of sample used depends on the anticipated water content and the desired degree of accuracy. Please refer to the following convenient reference table:

Table 2-1 Sample size recommended in the Karl Fischer titration

(<http://sy.zlgc.org/Upload/20080523215352884.pdf/26/04/12>)

| SAMPLE WATER CONTENT | VOLUMETRIC SAMPLE SIZE | COULOMETRIC SAMPLE SIZE |
|----------------------|------------------------|-------------------------|
| 100%                 | 0.02 to 0.05 g         | NOT RECOMMENDED         |
| 50%                  | 0.05 to 0.25 g         | 0.01 g                  |
| 10% (100,000 PPM)    | 0.25 to 0.50 g         | 0.01 to 0.05 g          |
| 5% (50,000 PPM)      | 0.50 to 2.50 g         | 0.05 to 0.10 g          |
| 1% (10,000 PPM)      | 2.50 to 5.00 g         | 0.10 to 0.50 g          |
| 0.5% (5,000 PPM)     | 5.00 to 7.50 g         | 0.20 to 1.00 g          |
| 0.1% (1,000 PPM)     | 7.50 to 10.0 g         | 1.00 to 2.00 g          |
| 0.01% (100 PPM)      | 10.0 to 15.0 g         | 2.00 to 5.00 g          |
| 0.001 (10 PPM)       | 15.0 to 20.0 g         | 5.00 to 10.0 g          |
| 0.0001% (1 PPM)      | NOT RECOMMENDED        | 10.0 g OR MORE          |

Rashid et al., (1999) studied the characteristics of MCC beads affected by process variation. They evaluated on expected yield, mean size, size distribution, shape characteristics (including roundness, circularity, elongation, rectangularity and

modelx) and friability. MCC beads were prepared with a laboratory-scale centrifugal granulating apparatus and five process parameters that had potential importance. This study using a fractional factorial design to evaluate process parameters including rotor rotation speed, slit air, spray air pressure, spray air rate and height of nozzle setting. They found that the selected properties beads were influenced by those process parameters which the effect from rotor rotation speed was the most potent on all parameters.

Sattayawuthipong et al., (2000) studied Fractal analysis program as an applicable technique for evaluating the shape of particle. This work has paid attention to develop the application software of image analyzing particle shape using fractal theory. Furthermore, this software will enhance the analytical work to be faster and make the consistency results. It will be also appropriate for evaluating the feret's diameter of particulate materials.

Podczek et al., (1997) studied Particle shape, and to date there is no general shape factor available which clearly differentiates between all possible kinds of shape. A shape factor for particles has been developed on the basis of two-dimensional particle outlines obtained by image analysis. The proposed shape factor uses the deviations of the two-dimensional particle outline from standard images of a circle, triangle and square, and considers the particle elongation and the number of characteristic comers of the apparent shape. A comparison with standard shape factors such as aspect ratio and circularity has shown that the new shape factor can differentiate between these model shapes. Therefore, five test powders with variable shape have been studied. While aspect ratio and circularity failed to identify the underlying particle shape and the differences in shape between the five powders, the proposed shape factor identified both the shape of each particle batch and the sometimes small differences in shape from batch to batch. Although the new shape factor has some limitations, it could improve the definition of shape characteristics of powders.

Willen., (2008) Product Manager, Analytical Imaging Systems Malvern Instruments. Presented Automation in Image Analysis for Particle Size and Shape Measurement. Knowledge and understanding of particle shape as well as size is now essential for many applications. The advent of automated image analysis-based

particle characterisation systems, with powerful measurement and data analysis capabilities, is allowing the more widespread use of this technique for production and process management and for quality control. Automated sample preparation, integrated as part of the measurement process, is proving to be one of the major keys to even higher throughput, especially for dry powders, and is helping to establish the more widespread and routine use of this technique.

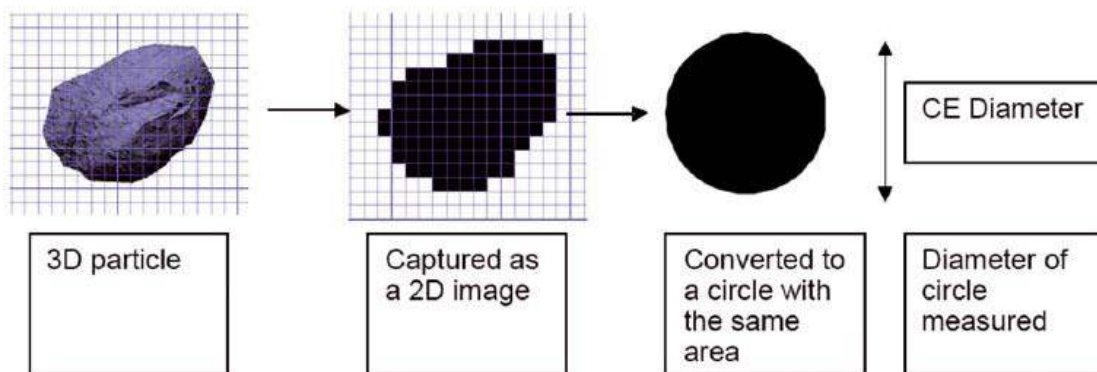

Figure 2-4 Calculation of CE diameter (Willen., 2008)

### Size and Shape Definitions

Describing a 3-dimensional particle can be much more complex than it first appears. While it can be convenient to use a single number, if the particle is not a perfect sphere there are many different ways in which its size could be described. Image analysis captures a 2-dimensional image of a 3-D particle, from which it calculates various size and shape parameters. Principal among these is circle equivalent (CE) diameter, which can be used to calculate particle size. The captured image is converted to a circle of equivalent area and while differently shaped particles will influence the CE figure, it has the virtue of being a single number that becomes larger or smaller as the particle does so. Importantly, it is both objective and repeatable. Particle shape is an even more complex challenge and many parameters may be used to build a complete picture. Figure 2-5 and table 2-2 show just some of the size and shape parameters that can be calculated. The calculation of multiple shape parameters for every particle, and the generation of distributions for each, allows the identification and quantification of even subtle differences.

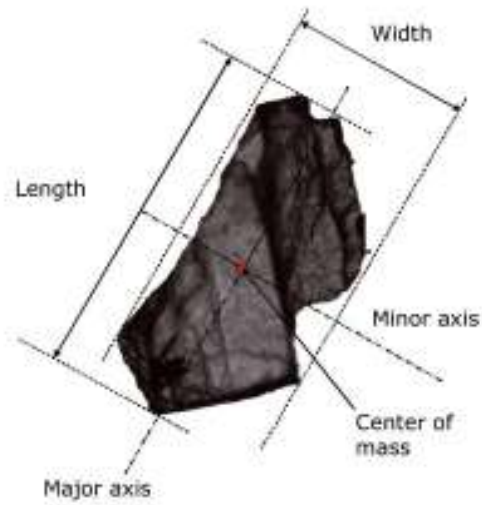

Figure 2-5 Key dimensions of particle size and shape analysis (Willen., 2008)

Table 2-2 Size and Shape parameters (Morphologi G3<sup>®</sup>)

| Parameter      | Definition   |
|----------------|--|
| Aspect ratio   | Width divided by length                                  |
| Elongation     | 1-aspect   |
| CE diameter    | The diameter of circle with similar area as the particle |
| HS circularity | High sensitivity circularity(circularity squared)        |

# CHAPTER III

## EXPERIMENTAL

### Materials

1. Rice Starch (Cho Heng Co.,Ltd, Nakhon Pathom, Thailand)
2. Microcrystalline Cellulose (CEOLUS<sup>®</sup> PH 101, Lot No. 1556, Bag No. 0678, Asahikasei Chemicals Corporation, Tokyo, Japan., COMPRECEL<sup>®</sup>, Lot No.C0912017, Type M101D+, Mingtai Chemical CO., LTD., Taoyuan Hsien, Taiwan R.O.C.)
3. Magnesium Chloride (MgCl<sub>2</sub>) (B/NO. 0711208, Ajax Finechem Pty Ltd, Sydney, Australia)
4. Magnesium Nitrate [Mg(NO<sub>3</sub>)<sub>2</sub>] (B/NO. AF704325, Ajax Finechem Pty Ltd, Sydney, Australia)
5. Sodium Chloride (NaCl) (B/NO. 0709156, Ajax Finechem Pty Ltd, Sydney, Australia)
6. Lithium Sulphate (LiSO<sub>4</sub>) (LOT 0000097778, HiMedia Laboratories Pvt.Ltd., Mumbai, India)
7. Potassium Nitrate (KNO<sub>3</sub>) (B/NO. 0903078, Ajax Finechem Pty Ltd, Sydney, Australia)
8. Karl Fischer Solution (Hydranal<sup>®</sup>-Composite 5, Lot No.SZE9285B, Sigma-Aldric<sup>®</sup>Chemie GmbH, Munich, Germany)
9. Methanol (Lot.I7AG1H, HPLC Grade, SK Chemicals, Gyeonggi-do, Korea)
10. Absolute Ethanol (Merck KGaA, absolute GR for analysis, Darmstadt, Germany)
11. Spray Dried Rice Starch (Eratab<sup>®</sup>) (Lot No.T440219, Erawan Pharmaceutical Research & Laboratory Co., Ltd, Bangkok, Thailand)

## Apparatus

1. Jet Mill (Current Jet Crusher, CJ-10, Isekyu Co.,Ltd., Nagoya, Japan)
2. Spray Drying Apparatus (NIRO ATOMIZER, GEA Niro, Soeborg, Denmark)
3. Homogenizer (Polytron<sup>®</sup> PT 3100, Kinematica AG, Lucerne, Switzerland)
4. Powder Characteristics Tester (Model PT-R, Hosokawa Micron Corporation, Osaka, Japan)
5. Scanning Electron Microscope (SEM, JSM-5410LV Scanning Microscope, JEOL, Ltd., Tokyo, Japan)
6. Laser Particle Size Distribution Analyzer, Model Mastersizer-S long bed Ver.2.19, Malvern Instruments Ltd., Worcestershire, UK)
7. Hydraulic press apparatus (Carver model B&C Hydraulic Unit Model 4356L., Carver Inc., Indiana, USA)
8. Hardness Thickness and Diameter tester (Campbell Electronics Model DHT-250, Campbell Electronics, Maharashtra, India.)
9. Friability Apparatus (ERWEKA TAR10, ERWEGA<sup>®</sup> GmbH, Heusenstamm, Germany)
10. Disintegration Apparatus (ERWEKA ZT 31, ERWEGA<sup>®</sup> GmbH, Heusenstamm, Germany)
11. Karl Fischer apparatus (AF8 TITRATOR, Orion Research Incorporated, Boston, MA, USA.)
12. Hot Air Oven (Type ULSO, Memmert, Germany)
13. Sieve ASTM E11 N<sup>o</sup> 100, 200, 325 i.e. mesh width 0.150 mm, 0.075 mm and 0.045 mm, respectively (FILTRA VIBRACIÓN S.L, Barcelona, USA.)
14. Morphologi<sup>®</sup> G3 Automated Particle Characterization System (Marvern<sup>®</sup> Instruments Limited, Worcestershire, UK.



## Methods

### 1. Composite particles of rice starch and microcrystalline cellulose

#### 1.1 Preparation of composite particles of rice starch and microcrystalline cellulose

Composite particles of rice starch (RS) and microcrystalline cellulose (MCC) were prepared according to a previous study by Limwong et al. (2004). Firstly, the size of MCC, from two manufacturing sources CEOLUS<sup>®</sup> PH 101 from Japan and COMPRECEL<sup>®</sup> from Taiwan, was reduced by using jet mill. Amounts of RS and MCC at a ratio of 7:3 were weighed and suspended in deionized water in order to obtain the final concentration of 20% w/w. The suspension was mixed thoroughly with the aid of homogenizer for 10 minutes, in order to get a homogeneous suspension. Subsequently, the suspension was spray dried. In this study, a co-current flow spray dryer was used and the experimental conditions were as follows:

|                    |              |
|--------------------|--------------|
| inlet temperature  | 130 °C       |
| atomizing pressure | 1 bar        |
| feed rate          | 30-32 g/min. |

The percentage of yield of composite particles was calculated from the weight of dried powder ( $w_1$ ) in the collector and the sum of the initial dry weight of starting material ( $w_2$ ) as the following equation.

$$\text{Percentage of production yield} = \left( \frac{W_1}{W_2} \right) \times 100 \quad (1)$$

#### 1.2 Characterization of composite particles of rice starch and microcrystalline cellulose

##### 1.2.1 Morphology

Particle morphology of all the samples, i.e. composite particles, RS, MCC, Eratab<sup>®</sup> was studied by using scanning electron microscope (JSM-5410LV, Jeol, Ltd., Tokyo, Japan). The samples were mounted on a specimen stub with double-sided adhesive tape and subjected to gold sputter coating to render them electrically conductive.

### 1.2.2 Particle size

Particle size and size distribution of all obtained particles were measured by laser light scattering method (Mastersizer S long bed Ver.2.19, Worcestershire, UK). Small amount of particles was dispersed in 200 ml of absolute ethanol used as a measuring medium and the dispersion was loaded into a stirred sample cell. The particle size was presented in the volume weighted mode and the 50% undersize diameter  $d(v,0.5)$  was referred to as the particle diameter. The size distribution was determined by the span value. Triplicate measurement was conducted.

### 1.2.3 Flowability

Angle of repose, angle of spatula, bulk density, packed density, % compressibility and % cohesiveness of the powders were determined by powder characteristics tester (Model PT-R, Hosokawa Micron Corporation, Osaka, Japan.)

*Angle of repose* was measured from a heap carefully built up by dropping samples about 200 g through a vibrating standard sieve and glass funnel onto a horizontal plate. The angle of repose would be measured automatically by infrared.

*Angel of spatula* could be measured from the angle of samples about 200 g which accumulated at the top of the spatula. This value was generally larger than the angle of repose. The greater angle of spatula, the poorer the powder's flowability.

*Bulk density and packed density* could be measured by sieving sample powders about 200 g through a vibrating chute, filling a measuring cup. After the sample filled up the measuring cup and reached an expected height, it would be tapped at a set number of times under a constant condition. Finally, packed density would be measured after the sample consolidated from tapping.

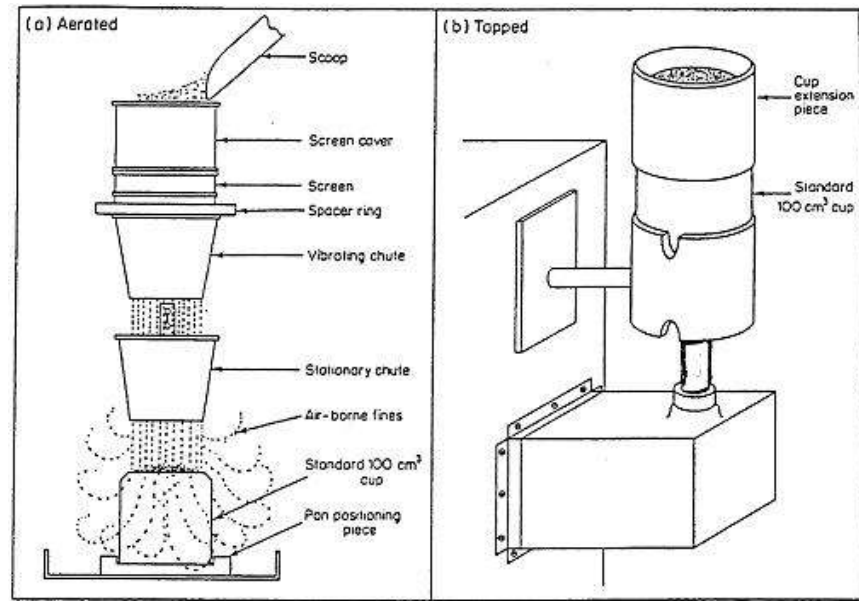

Figure 3-1 The Hosokawa Powder Tester for measuring the aerated and packed bulk densities (Abdullah et al., 1999)

**Compressibility** could be obtained by measuring bulk density and packed density and taking the ratios of these two values.

**Cohesiveness** could be measured by subjecting standard sieves to vibrate for a constant time with a constant force. Then, the cohesiveness was measured from the passed through powder amount. If the powder has a high degree the cohesiveness, it will naturally have poor flowability.

Each determination was assigned an index numbers determined by its measured value (Table 3-1). The summation of these index numbers is **flowability index** which describes degree of flowability. The higher value of the flowability index shows the better flowability of the composites particle as shown in Table 3-1.

Table 3-1 Degree of flowability and flowability index

| Degree of flowability | Flowability index | Angle of Repose |       | Compressibility |       | Angle of Spatula |       | Cohesiveness |       |
|-----------------------|-------------------|-----------------|-------|-----------------|-------|------------------|-------|--------------|-------|
|                       |                   | Degree          | Index | %               | Index | Degree           | Index | %            | Index |
| Very Good             | 90-100            | ≤ 25            | 25    | ≤ 5             | 25    | ≤ 25             | 25    |              |       |
|                       |                   | 26-29           | 24    | 6-9             | 23    | 26-30            | 24    |              |       |
|                       |                   | 30              | 22.5  | 10              | 22.5  | 31               | 22.5  |              |       |
| Fairly Good           | 80-89             | 31              | 22    | 11              | 22    | 32               | 22    |              |       |
|                       |                   | 32-34           | 21    | 12-14           | 21    | 33-37            | 21    |              |       |
|                       |                   | 35              | 20    | 15              | 20    | 38               | 20    |              |       |
| Good                  | 70-79             | 36              | 19.5  | 16              | 19.5  | 39               | 19.5  |              |       |
|                       |                   | 37-39           | 18    | 17-19           | 18    | 40-44            | 18    |              |       |
|                       |                   | 40              | 17.5  | 20              | 17.5  | 45               | 17.5  |              |       |
| Normal                | 60-69             | 41              | 17    | 16              | 19.5  | 39               | 19.5  |              |       |
|                       |                   | 42-44           | 16    | 17-19           | 18    | 40-44            | 18    |              |       |
|                       |                   | 45              | 15    | 20              | 17.5  | 45               | 17.5  | ≤ 6          | 15    |
| Not Good              | 40-59             | 46              | 14.5  | 26              | 14.5  | 61               | 14.5  | 6-9          | 14.5  |
|                       |                   | 47-54           | 12    | 27-30           | 12    | 62-74            | 12    | 10-29        | 12    |
|                       |                   | 55              | 10    | 31              | 10    | 75               | 10    | 30           | 10    |
| Bad                   | 20-39             | 56              | 9.5   | 32              | 9.5   | 76               | 9.5   | 31           | 9.5   |
|                       |                   | 57-64           | 7     | 33-36           | 7     | 77-89            | 7     | 32-54        | 7     |
|                       |                   | 65              | 5     | 37              | 5     | 90               | 5     | 55           | 5     |
| Very Bad              | 0-19              | 66              | 4.5   | 38              | 4.5   | 91               | 4.5   | 56           | 4.5   |
|                       |                   | 67-89           | 2     | 39-45           | 2     | 92-99            | 2     | 57-79        | 2     |
|                       |                   | 90              | 0     | ≥ 45            | 0     | ≥ 99             | 0     | ≥ 79         | 0     |

Source: Operating instruction manual of powder characteristic tester, Hosokawa Micron Corp.

## 2. Tableting of composite particles

The RS:MCC composite particles of  $500 \pm 5$  mg and  $350 \pm 5$  mg was accurately weighed and compressed with a flat- faced punch die assembly of rounded shape, using a hydraulic press. Compression force studied was assigned in three levels of 1, 1.5 and 2 metric ton. Then, the obtained tablets were evaluated physically i.e. hardness, thickness, diameter, % friability and disintegration time. Overall results of tablet properties were evaluated for selection of MCC source in composite particles for further studies.

## 2.1 Effect of moisture content

The composite particle of selected source of MCC (about 15 g) was spread on a petri dish. The dish was placed in the desiccators containing silica gel or a saturated salt solution that created a desired relative humidity. Five saturated salt solutions,  $\text{MgCl}_2$ ,  $\text{Mg}(\text{NO}_3)_2$ ,  $\text{NaCl}$ ,  $\text{LiSO}_4$ , and  $\text{KNO}_3$  were chosen to control various levels of relative humidity. The relative humidity values obtained from the saturated salt solutions were expected to be about 33, 52, 76, 88, and 93% RH, respectively at 25°C (Kuu et al., 1998), while silica gel would give 30% RH at 25 °C (Balkose et al., 1998). In addition, the dish of layered composite particle was placed outside the desiccators with uncontrolled humidity.

All dishes were kept for 24 h and then the moisture content of RS:MCC composite powder was determined by Karl Fischer (KF) method (AF8 titrator; Orion Research Incorporated, Boston, MA, USA).

To determine the moisture content by KF method, first, 35 to 40 ml of methanol was transferred into the titration vessel, and titrated with KF reagent to the endpoint to consume any moisture that may present. In order to calibrate, the precise determination of significant amounts of purified water (1% or more) would be used as the reference substance. After the calibration was done, accurately weighed 0.1 g of RS:MCC composite powders which were kept under various %RH as described in above into the titration vessel. Later on, KF reagent was added directly to the sample. The amount of KF reagent needed was used to determine the moisture content of the sample. One mole of KF reagent is consumed per one mole of water (Huynh-Ba, 2009). The measurement was carried out in triplicate.

For additional information, MCC of selected source and Eratab® was treated under the same RH as the composite particles and kept in a hot air oven at 60 °C for 1 h. The moisture content of the materials was also determined using KF method.

RS: MCC composite samples containing different three levels of moisture content were chosen to make compressed tablets. Then, the obtained tablets were evaluated physically i.e. hardness, thickness, diameter, % friability and disintegration time.

## **2.2 Effect of particle size**

RS:MCC composite samples were gently passed through sieve number 325, 200 and 100 to obtain particles which were smaller size than 45, 75 and 150  $\mu\text{m}$ , respectively. The sieved powders of different size were characterized as described in section 1.2.1-1.2.2 and compressed to tablets. Then, the obtained tablets were evaluated physically i.e. hardness, thickness, diameter, % friability and disintegration time.

## **2.3 Effect of particle shape**

Different shape of composite particles was formed according to the previous work (Limwong et al., 2004). Basically, spray dried composite particles were prepared as above mentioned. Before dispersing and mixing with RS in water, MCC was obtained by two different ways. First, MCC of smaller size than 355  $\mu\text{m}$  obtained by passing through a sieve number 45 is coded here as CS. Second, MCC of which particle size was reduced by jet milling is coded here as CJM. The dispersion of RS with CS or CJM in water was spray dried under the conditions described in section 1.1. According to (Limwong et al., 2004), CS would give “rugby-ball” like particles and CJM would give spherical form.

In the present study, the shape of the spray dried particles were evaluated by Morphologi<sup>®</sup> G3 Automated particle characterization system, connected with optical microscope (Nikon<sup>®</sup> CFI 60), at 5x magnification. The sample was dispersed with an instantaneous pulse of compressed air and measurements were made in an enclosed sample carrier. In the standard operating procedure, fill holes was assigned as “true”; segmentation was assigned as “none” and trash size was assigned as “10”. Each measurement was carried out on 7900-13800 particles. The image of individual particle was captured and the following shape parameters were determined (Malvern<sup>®</sup> Instruments Limited, 2010).

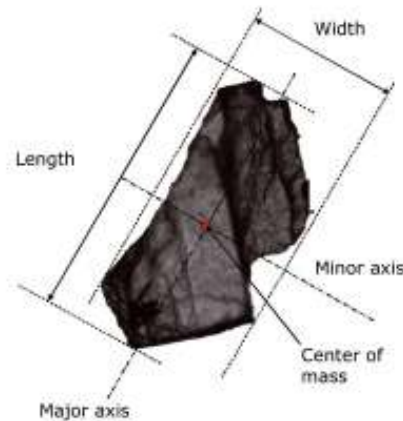

Figure 3-2 Image analysis systems capture a 2D image of the 3D particle (Willen., 2008)

**Circle equivalent (CE) diameter:** the diameter of a circle with the same area as the projected area of the particle image.

**Aspect ratio:** the ratio of the width to the length of the particle. It is calculated from the following equation:

$$\text{Aspect Ratio} = \frac{\text{Width}}{\text{Length}} \quad (2)$$

Where, *length* ( $\mu\text{m}$ ) is all possible lines from one point of the perimeter to another point on the perimeter are projected on the major axis (axis of minimum rotational energy). The maximum length of these projections is the length of the object; *width* ( $\mu\text{m}$ ) all possible lines from one point of the perimeter to another point on the perimeter are projected on the minor axis. The maximum length of these projections is the width of the object.

**Elongation** is calculated as 1- aspect ratio

**High sensitivity (HS) circularity:** the ratio of the object's projected area to the square of the perimeter of the object. This is calculated from the following equation:

$$\text{HS Circularity} = \frac{4 \times \pi \times \text{Area}}{\text{Perimeter}^2} \quad (3)$$

In addition to image analysis, the morphology of the spray dried composite particles was confirmed by SEM

RS:MCC (CS or CJM) composite particles were compressed to tablets. Then, the obtained tablets were evaluated physically i.e. hardness, thickness, diameter, % friability and disintegration time.

## 2.4 Physical characterization of tablets

### 2.4.1 Hardness, Thickness and Diameter

Hardness, thickness and diameter of tablets were determined by tablet hardness tester (Campbell Electronics Model DHT-250, Campbell Electronics, Maharashtra, India). Mean and standard deviation were calculated from ten tablets.

### 2.4.2 Friability

Friability of the tablets was determined using the Erweka friabilator (ERWEKA TAR10, ERWEGA<sup>®</sup> GmbH, Heusenstamm, Germany). Twenty tablets were weighed and put into the drum of friabilator which was set to rotate at 25 rounds per minute for about four minutes. The tablets were then removed and weighed again. Percentage of friability was calculated as the following equation:

$$\text{Percent friability} = \frac{W_i - W_f}{W_i} \times 100 \quad (4)$$

$W_i$  = The first weight of the compression

$W_f$  = The last weight of the compression

### 2.4.3 Disintegration time

Six tablets were located in each compartment of the Erweka disintegration apparatus (ERWEKA ZT 31, ERWEGA<sup>®</sup> GmbH, Heusenstamm, Germany), with deionized water of  $37 \pm 0.50$  °C without disk. Disintegration time was determined from the time that the last tablet disappeared from the viewing screen.



## CHAPTER IV

### RESULTS AND DISCUSSION

#### 1. Characterization of microcrystalline cellulose (MCC) and rice starch (RS)

Particle size of MCC from two different sources, CEOLUS<sup>®</sup> PH 101 (Japan) and COMPRECEL<sup>®</sup> (Taiwan) were either sieved or reduced by jet mill, classified as CS and CJM, respectively. CS was prepared by passing MCC passed through a sieve number 45 having an opening aperture of 355  $\mu\text{m}$ . CJM was MCC that the particle size was reduced by jet mill. CS and CJM were observed using scanning electron microscope (SEM) and photomicrographs were taken at magnifications as shown in Figure 4-1 and Figure 4-2. CJM was used as the raw material for preparing composite particles, unless otherwise stated.

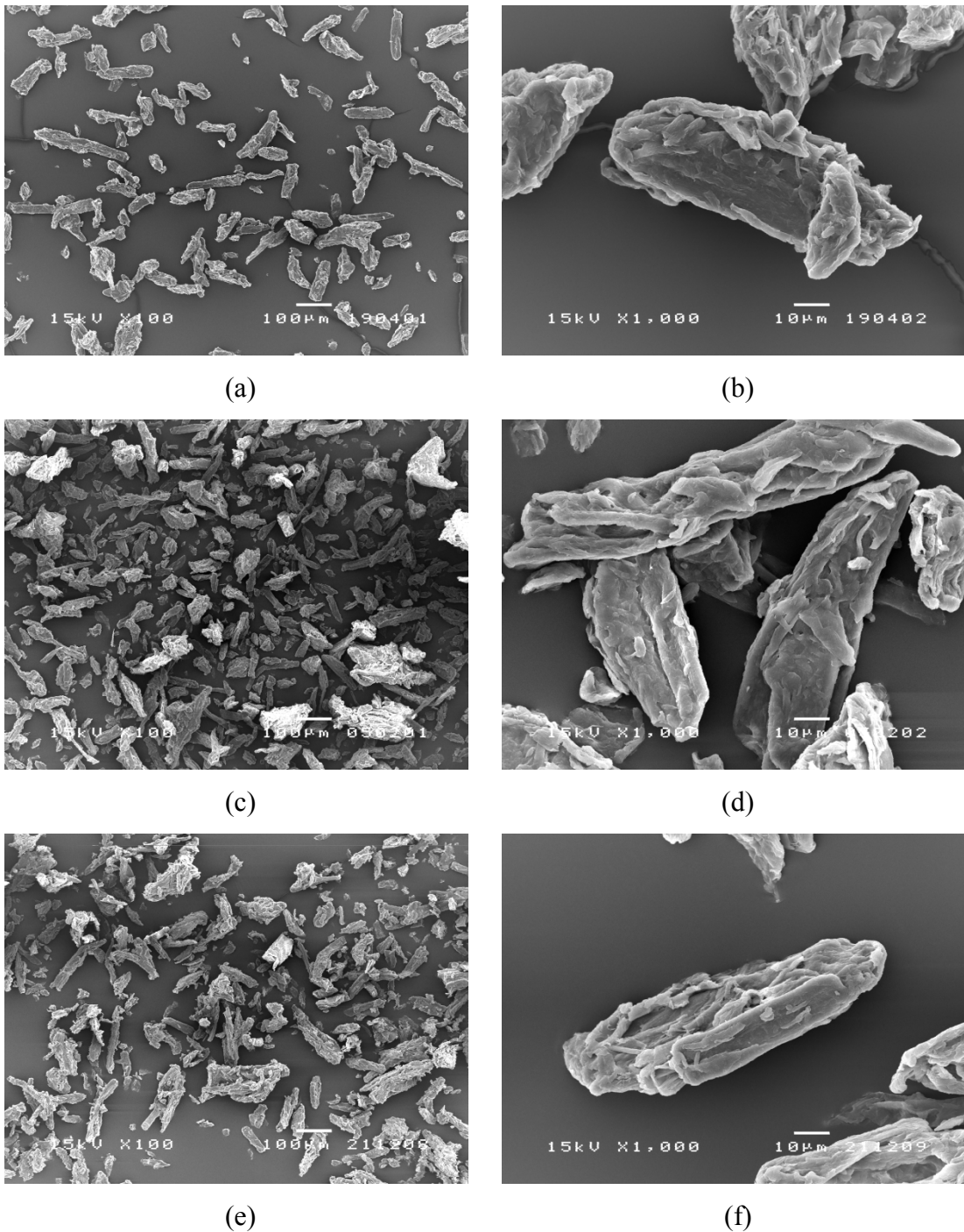

Figure 4-1 SEM photomicrographs of MCC from CEOLUS<sup>®</sup> PH 101: (a-b) CEOLUS<sup>®</sup> PH 101 as received; (c-d) CS, MCC passed through a sieve number 45 having an opening aperture of 355 μm; (e-f) CJM, MCC that the size was reduced by jet mill

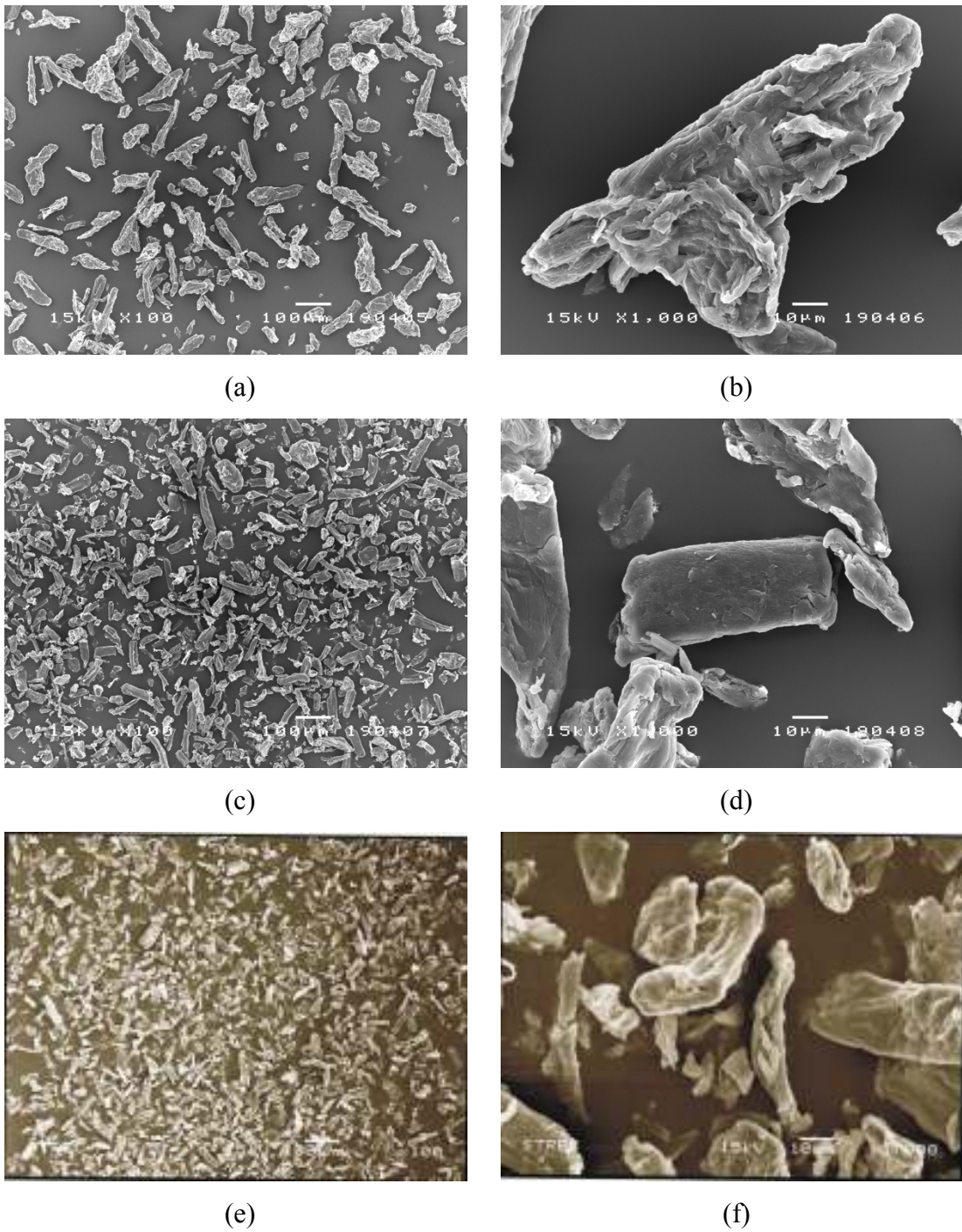

Figure 4-2 SEM photomicrographs of MCC from COMPRECEL<sup>®</sup>: (a-b) COMPRECEL<sup>®</sup> as received; (c-d) CS, MCC passed through a sieve number 45 having an opening aperture of 355  $\mu\text{m}$ ; (e-f) CJM, MCC that the size was reduced by jet mill

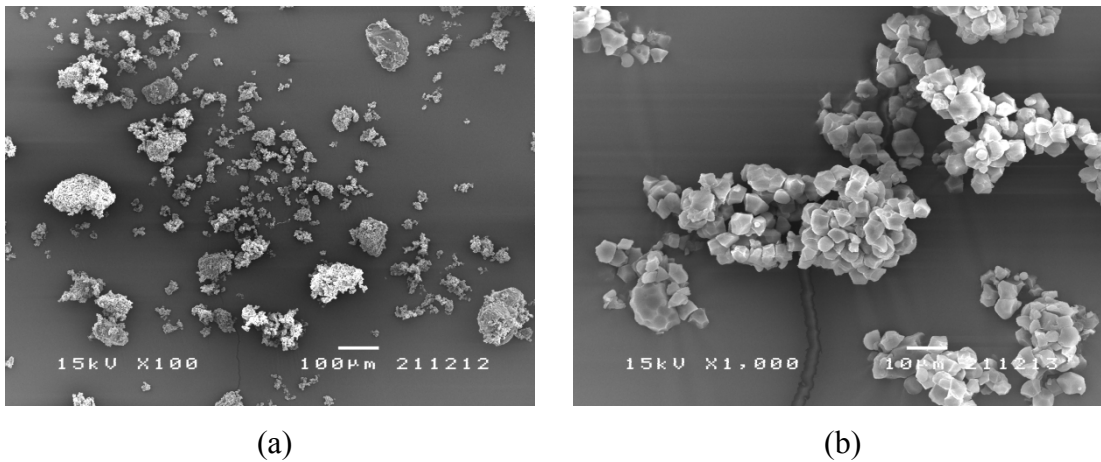

Figure 4-3 SEM photomicrographs of RS

The SEM photomicrographs show that CS and CJM of both MCC sources were quite similar in shape. They were in fibrous shape. Particle size of CJM from COMPRECEL<sup>®</sup> was slightly bigger than that of CEOLUS<sup>®</sup> PH 101 as shown in Table 4-1. Rice starch was in polygonal shape and its size was generally smaller than the size of MCC particles, as shown in Figure 4-3 and Table 4-1.

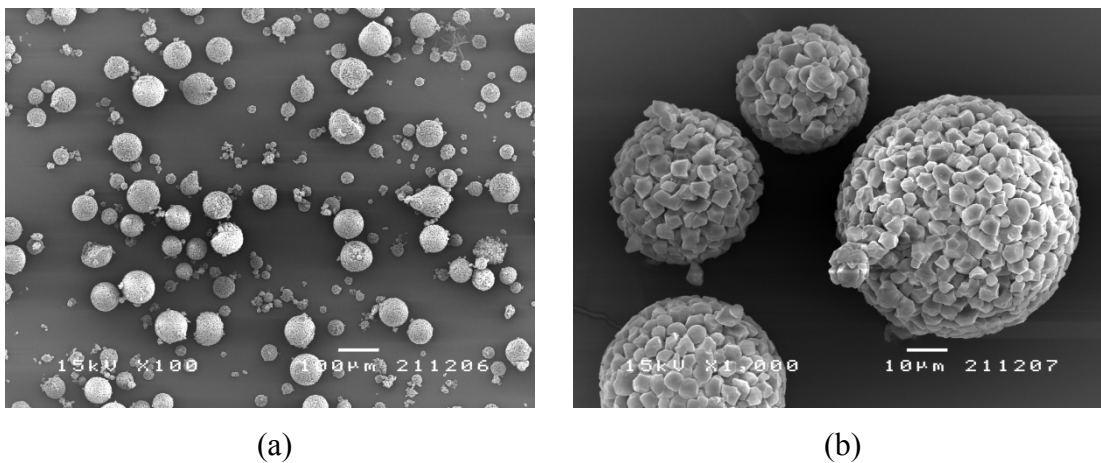

Figure 4-4 SEM photomicrographs of commercial spray dried rice starch (Eratab<sup>®</sup>)

Figure 4-4 showed that Eratab<sup>®</sup> particles were aggregates of spherical particles with a few irregular shapes. This was also reported by Bos, Bolhuis, Lerk and Duineveld (1992). Hsu, Tsai, Chuo and Cham (1997) suggested that the geometric

mean diameter of Eratab<sup>®</sup> was 72  $\mu\text{m}$ . Here, the measured particle size,  $D(v, 0.5)$  was found to be 55.94  $\mu\text{m}$ .

Table 4-1 Particle size and size distribution of RS, CJM (jet milled MCC) from two manufacturing sources and commercial spray dried rice starch; average (SD),  $n = 3$ .

| <b>Material</b>   | <b>D (v,0.1)<br/>(<math>\mu\text{m}</math>)</b> | <b>D(v, 0.5)<br/>(<math>\mu\text{m}</math>)</b> | <b>D(v,0.9)<br/>(<math>\mu\text{m}</math>)</b> | <b>Span<br/>(D90-D10)<br/>/D50(<math>\mu\text{m}</math>)</b> |
|---|---|---|--|--|
| RS  | 1.47(0.01)                                      | 14.89(0.01)                                     | 84.28(1.74)                                    | 5.57(0.11)   |
| CJM (CEOLUS <sup>®</sup> PH 101)                          | 4.47(0.01)                                      | 18.10(0.01)                                     | 42.40(0.07)                                    | 2.09(0.01)   |
| CJM (COMPRECEL <sup>®</sup> )                             | 9.87(0.11)                                      | 23.95(0.06)                                     | 56.56(0.50)                                    | 1.95(0.14)   |
| Commercial spray dried rice starch (Eratab <sup>®</sup> ) | 13.77(0.92)                                     | 55.94(1.49)                                     | 109.38(1.59)                                   | 1.71(0.03)   |

$D(v,0.1)$  = 10% of the distribution is below this value

$D(v,0.5)$  = 50% of the distribution is below this value

$D(v,0.9)$  = 90% of the distribution is below this value

## **2. Preparation and characterization of RS:MCC composites particles for tableting**

### **2.1 MCC from two manufacturing sources**

Limwong et al. (2004) suggested that RS and MCC formulation at 7:3 ratio gave the most suitable results, i.e. highest production yield, good flowability and suitable tablet hardness. Commercial coprocessed excipient with cellulose e.g. Cellactose<sup>®</sup> is usually composed of cellulose of approximately 30%. Therefore, in this study spray dried composite particles of RS and MCC from two manufacturing sources were prepared at 7:3 ratio. The SEM images of raw materials of MCC and RS are shown in Figure 4-1 to 4-3. The obtained spray dried composite particles appeared as fine, white powders of which the SEM photomicrographs are shown in Figure 4-5 to 4-6.

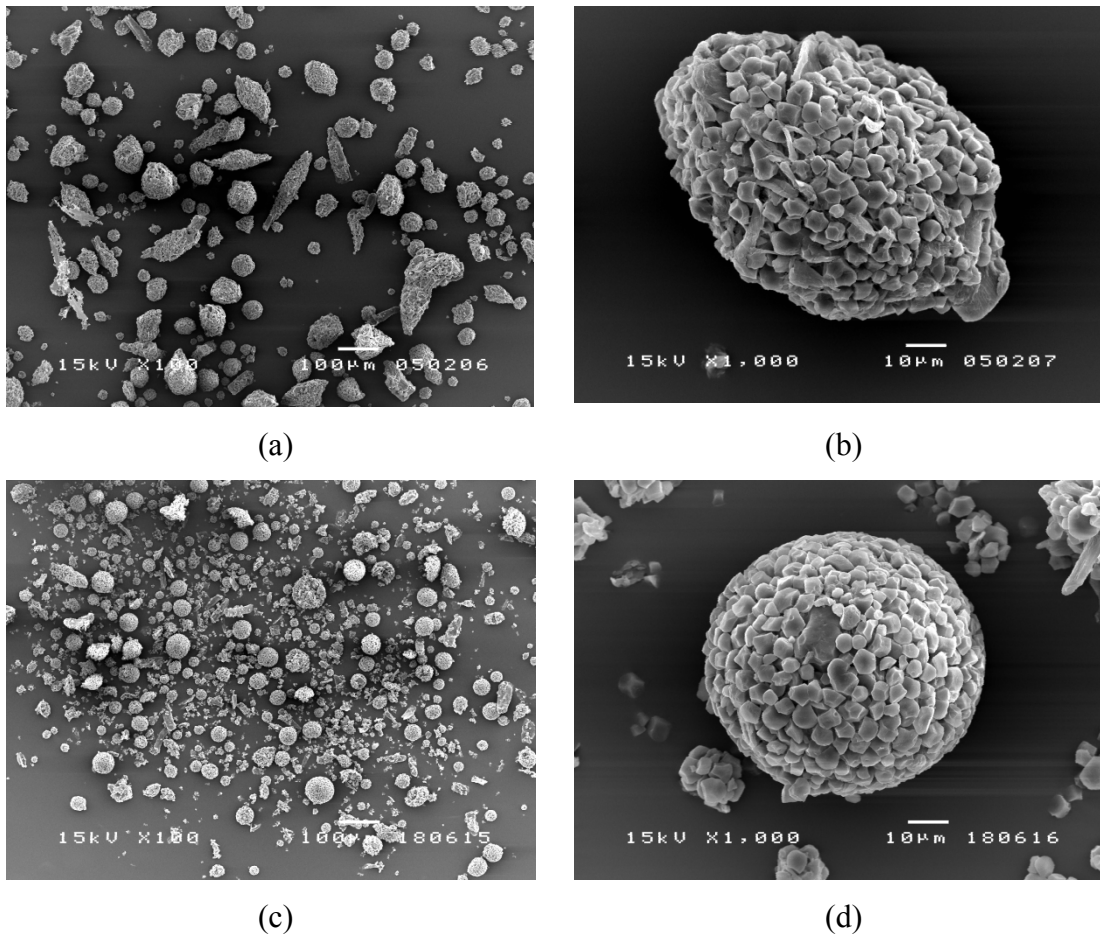

Figure 4-5 SEM photomicrographs of spray dried product using MCC from CEOLUS<sup>®</sup> PH 101: (a-b) CS, MCC passed through a sieve number 45 having an opening aperture of 355  $\mu\text{m}$  ; (c-d) CJM, MCC that the size was reduced by jet mill

It was clearly shown that composite particles of RS and MCC could be produced i.e. RS aggregated with MCC. The SEM photomicrographs of RS:MCC (CEOLUS<sup>®</sup> PH 101) and RS:MCC (COMPRECEL<sup>®</sup>) composite particles show “rugby balls” when CS was used as starting material, while appeared as rounded particles when CJM was used. Therefore, sieving of MCC before preparation of composite particles could provide “rugby ball” like particles as reported earlier (Limwong et al., 2004). The source of MCC did not contribute remarkable difference in shape.



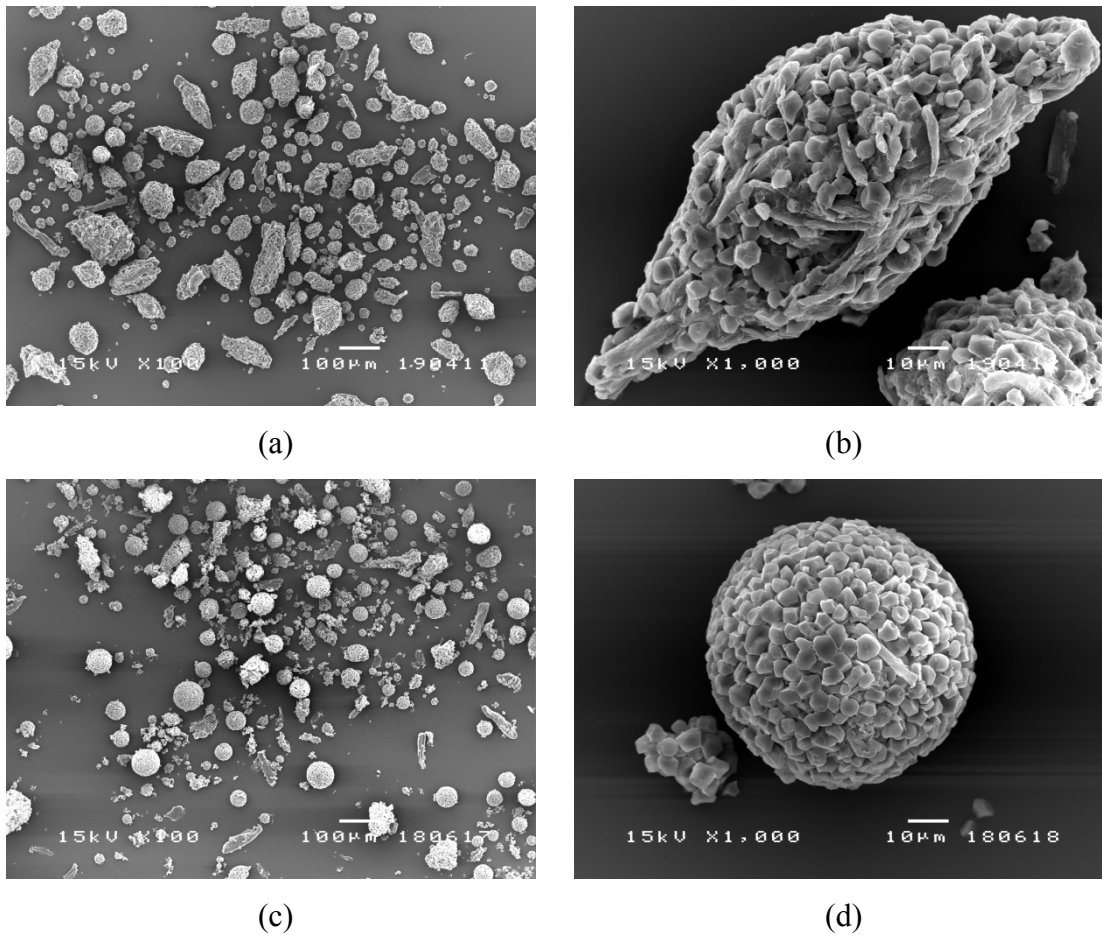

Figure 4-6 SEM photomicrographs of spray dried product using MCC from COMPRECEL<sup>®</sup>: (a-b) CS, MCC passed through a sieve number 45 having an opening aperture of 355 μm; (c-d) CJM, MCC that the size was reduced by jet mill

The size and size distribution of RS: MCC composite particles produced from CJM or jet milled MCC was determined. It was found that RS:MCC (COMPRECEL<sup>®</sup>) composite particles had smaller size than the size of RS:MCC (CEOLUS<sup>®</sup> PH 101) composite particles as presented in Table 4-2, although they were started from CJM of COMPRECEL<sup>®</sup> which was in bigger size.

Table 4-2 Particle size and size distribution of composite particles produced from CJM (jet milled MCC) of different sources; average (SD), n =3.

| <b>Composite particles</b>             | <b>D (v,0.1)<br/>(<math>\mu\text{m}</math>)</b> | <b>D(v, 0.5)<br/>(<math>\mu\text{m}</math>)</b> | <b>D(v,0.9)<br/>(<math>\mu\text{m}</math>)</b> | <b>Span<br/>(D90-D10)<br/>/D50(<math>\mu\text{m}</math>)</b> |
|--|---|---|--|--|
| RS:MCC<br>(CEOLUS <sup>®</sup> PH 101) | 9.47(0.05)                                      | 40.70(0.01)                                     | 82.01(0.14)                                    | 1.78(0.01)   |
| RS:MCC<br>(COMPRECEL <sup>®</sup> )    | 10.24 (0.01)                                    | 25.34(0.05)                                     | 80.55(0.10)                                    | 2.78(0.05)   |

D(v,0.1) = 10% of the distribution is below this value

D(v,0.5) = 50% of the distribution is below this value

D(v,0.9) = 90% of the distribution is below this value

The production yield of RS:MCC (CEOLUS<sup>®</sup> PH 101) was 60.47% which was higher than that of RS:MCC (COMPRECEL<sup>®</sup>), 58.76%, as reported in Table 4-3.

The values of angle of repose, angle of spatula, bulk density, packed density, percent compressibility and cohesiveness which affect on flowability index of RS:MCC composite particles are shown in Table 4-3. The general summation of these numbers yields the flowability index, which could be used as a parameter to forecast relative degree of fluidity for bulk powder. A higher estimation of flowability index, a better flow property of powder. In addition, a flowability index number which are higher than 70 indicates a good degree of flowability. On the contrary, a number below 60 indicates a poor flowability.

The values in Table 4-3 indicated that RS:MCC from both sources did not have good flowability or “not good” due to the flowability index was in the range of 40-59 as described in Table 3-1.



Table 4-3 Yield and flow properties of composite particles produced from CJM (jet milled MCC) of two manufacturing sources; average (SD), n = 3.

| Test                      | RS:MCC<br>(CEOLUS <sup>®</sup> PH 101) | RS:MCC<br>(COMPRECEL <sup>®</sup> ) |
|---------------------------|--|-------------------------------------|
| Yield (%), n = 1          | 60.47 %                                | 58.76%                              |
| Angle of Repose (degree)  | 52.17(3.64)                            | 53.03(2.68)                         |
| Angle of Spatula (degree) | 78.77(2.20)                            | 75.97(5.51)                         |
| Bulk Density (g/ml)       | 0.34(0.01)                             | 0.36(0.01)                          |
| Packed Density (g/ml)     | 0.51(0.00)                             | 0.54(0.01)                          |
| Compressibility (%)       | 33.27(0.91)                            | 33.00(0.70)                         |
| Cohesiveness (%)          | 7.83(1.07)                             | 8.67(2.29)                          |
| Flowability Index         | 39.83(1.15)                            | 42.33(6.33)                         |

Timaroon et al. (1993) suggested that poor flowability was associated to the size and shape of modified RS particles. Most of rice starch had small particle sizes, generally under 30  $\mu\text{m}$  on average, and moreover their shapes were mostly irregular, not round and smooth. These factors create forces such as electrostatic, Van der Waal's force and friction which were large enough to impede flowability. In the present study, RS:MCC composite particles which were produced from CJM were of spherical shape. The poor flowability, therefore, might be caused by their small size. Earlier studies (Limwong et al, 2004), the flowability of RS:MCC composite particles was shown to be better i.e. flowability index of 69.0, perhaps due to larger size of approximately of 52  $\mu\text{m}$ .

## 2.2 Moisture content of composite particles

To study the effect of moisture content in composite particles on tablet properties, the composite particles produced from CEOLUS<sup>®</sup> PH 101 were exposed to various storage conditions and their moisture content were determined by Karl Fischer titration method. Composite particles with selected moisture contents were

used for tableting. The results were compared with that of MCC (CEOLUS<sup>®</sup> PH 101) and commercial spray dried rice starch (Eratab<sup>®</sup>).

Table 4-4 Moisture content of composite particles produced from CJM (jet milled CEOLUS<sup>®</sup> PH 101).

| Storage condition                          | Moisture content (%) |       |       |                |
|--|----------------------|-------|-------|----------------|
|  | 1                    | 2     | 3     | Average (SD)   |
| Silica gel (30 %RH)                        | 7.02                 | 7.34  | 6.67  | 7.01 (0.0034)  |
| MgCl <sub>2</sub> (33 %RH)                 | 8.80                 | 8.87  | 8.98  | 8.89 (0.0009)  |
| Mg(NO <sub>3</sub> ) <sub>2</sub> (52 %RH) | 11.06                | 10.79 | 10.53 | 10.79 (0.0027) |
| Room temp (25°C) (60%RH)                   | 9.43                 | 9.55  | 9.67  | 9.55(0.0012)   |
| NaCl (76 %RH)                              | 13.79                | 13.60 | 13.05 | 13.48 (0.0038) |
| Li <sub>2</sub> SO <sub>4</sub> (88 %RH)   | 14.97                | 15.04 | 14.16 | 14.72 (0.0049) |
| KNO <sub>3</sub> (93 %RH)                  | 16.15                | 15.53 | 15.50 | 15.73 (0.0037) |

Table 4-5 Moisture content of MCC (CEOLUS<sup>®</sup> PH 101).

| Storage condition                          | Moisture content (%) |       |       |                |
|--|----------------------|-------|-------|----------------|
|  | 1                    | 2     | 3     | Average (SD)   |
| Hot air oven (60°C)                        | 3.75                 | 3.49  | 3.55  | 3.60 (0.1361)  |
| Silica gel (30 %RH)                        | 4.93                 | 5.02  | 4.90  | 4.95 (0.0624)  |
| MgCl <sub>2</sub> (33 %RH)                 | 6.13                 | 6.45  | 6.16  | 6.25 (0.1767)  |
| Mg(NO <sub>3</sub> ) <sub>2</sub> (52 %RH) | 6.82                 | 6.39  | 6.52  | 6.57 (0.2205)  |
| NaCl (76 %RH)                              | 8.46                 | 7.81  | 8.05  | 8.11 (0.3287)  |
| Li <sub>2</sub> SO <sub>4</sub> (88 %RH)   | 9.22                 | 8.83  | 8.78  | 8.95 (0.2409)  |
| KNO <sub>3</sub> (93 %RH)                  | 10.93                | 10.78 | 10.64 | 10.78 (0.1450) |

Table 4-6 Moisture content of spray dried rice starch (Eratab<sup>®</sup>).

| Storage condition                          | Moisture content (%) |       |       |                |
|--|----------------------|-------|-------|----------------|
|  | 1                    | 2     | 3     | Average (SD)   |
| Hot air oven (60°C)                        | 6.64                 | 7.48  | 7.59  | 7.24 (0.5196)  |
| Silica gel (30 %RH)                        | 8.84                 | 9.06  | 9.29  | 9.06 (0.2250)  |
| MgCl <sub>2</sub> (33 %RH)                 | 10.84                | 10.62 | 11.17 | 10.88 (0.2768) |
| Mg(NO <sub>3</sub> ) <sub>2</sub> (52 %RH) | 11.49                | 11.29 | 12.07 | 11.62 (0.4051) |
| NaCl (76 %RH)                              | 13.66                | 13.06 | 14.13 | 13.62 (0.5363) |
| Li <sub>2</sub> SO <sub>4</sub> (88 %)     | 14.42                | 15.68 | 15.04 | 15.04 (0.6300) |
| KNO <sub>3</sub> (93 %)                    | 15.61                | 15.78 | 18.41 | 16.60 (1.5698) |

In general, the amount of moisture contents constantly increased with the relative humidity of storage conditions as proposed by Kuu , Chilamkurti and Chen (1998). At any condition after 24 h of storage, it was found that the moisture content of spray dried rice starch (Eratab<sup>®</sup>) was higher than RS:MCC composite particles, whose the moisture content was higher than MCC. In order to study the effect of moisture content of these materials on tablet properties, three levels of moisture content were chosen for tableting. Moisture content levels of RS:MCC composite particles chosen were 7.01%, 10.79% and 15.73%. Moisture content levels of MCC chosen were 3.60 %, 6.57% and 10.78%. Eratab<sup>®</sup> powder moisture contents chosen were 7.24 %, 10.88 % and 16.60%.

### 2.3 Particle size of composite particles

Composite particles produced from CJM (jet milled MCC) of CEOLUS<sup>®</sup> PH 101 were passed through sieve No 325, 200 and 100, having opening size of 45, 75 and 150  $\mu\text{m}$ , respectively, for tableting. Their size was determined and reported in Table 4-7. The results indicated that RS:MCC which passed through 150  $\mu\text{m}$ , 75  $\mu\text{m}$  and 45  $\mu\text{m}$  mesh width had the particle size, D (v, 0.5) of 229.04  $\mu\text{m}$ , 96.76  $\mu\text{m}$  and 58.73  $\mu\text{m}$ , respectively.

The SEM photomicrographs of each sieve fraction are shown in Figure 4-7. They generally appeared in round shape.

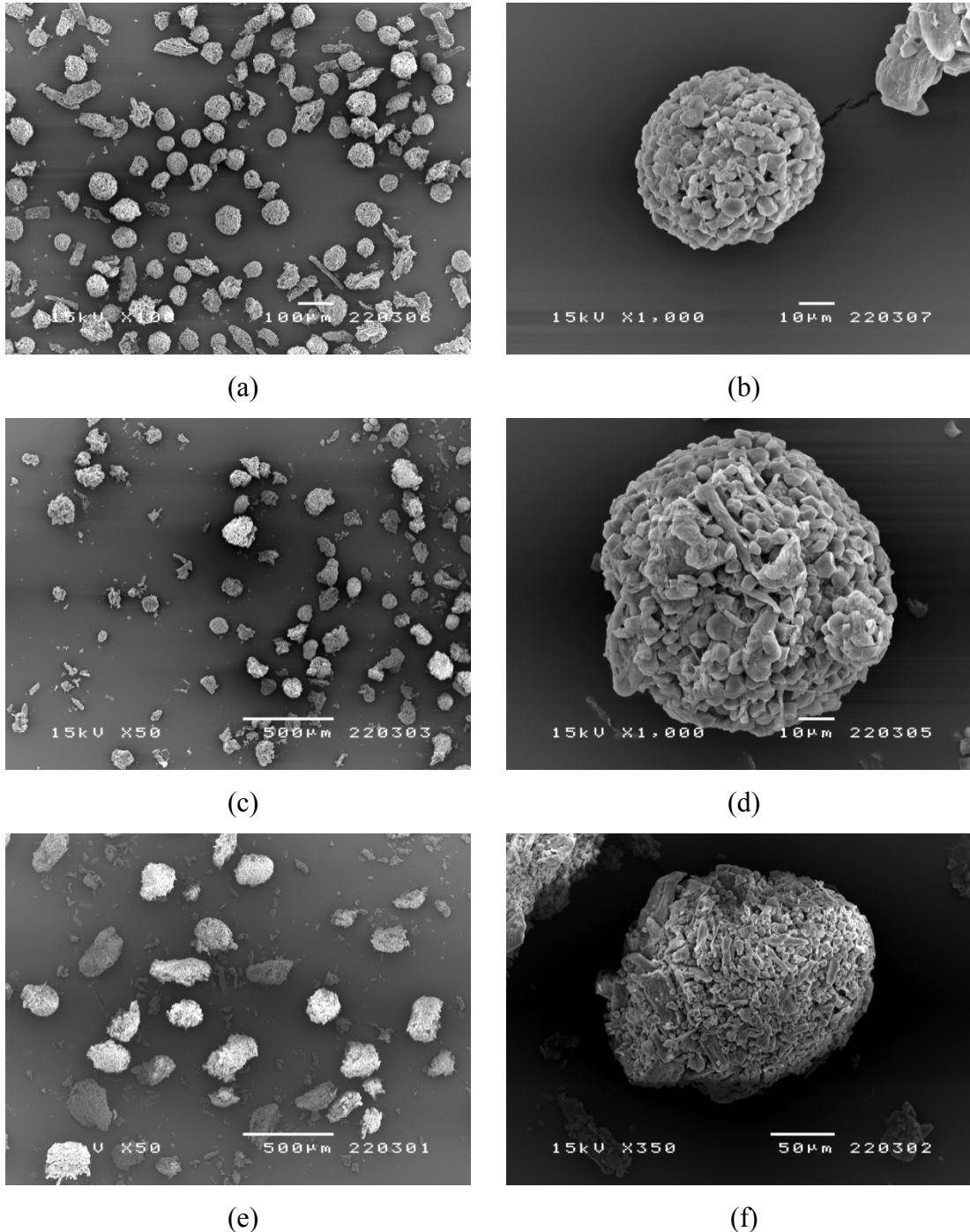

Figure 4-7 SEM photomicrographs of spray dried product using MCC from CEOLUS® PH101. Its size was reduced by jet mill and passed through sieve with mesh width (a-b) 45  $\mu\text{m}$ ; (c-d) 75  $\mu\text{m}$  (e-f) 150  $\mu\text{m}$

Table 4-7 Particle size and size distribution of sieved composite particles produced from CJM (jet milled MCC) of CEOLUS<sup>®</sup> PH 101 and passed through different sieve opening size; average (SD), n =3.

| <b>Composite particles</b> | <b>D (v,0.1)<br/>(<math>\mu\text{m}</math>)</b> | <b>D(v, 0.5)<br/>(<math>\mu\text{m}</math>)</b> | <b>D(v,0.9)<br/>(<math>\mu\text{m}</math>)</b> | <b>Span<br/>(D90-D10)<br/>/D50(<math>\mu\text{m}</math>)</b> |
|----------------------------|---|---|--|--|
| RS:MCC, 45 <sup>*(a)</sup> | 36.51(0.13)                                     | 58.73(0.02)                                     | 80.50(0.03)                                    | 0.75(0.00)   |
| RS:MCC, 75*                | 58.72(0.36)                                     | 96.76(0.03)                                     | 139.39(0.28)                                   | 0.83(0.01)   |
| RS:MCC, 150*               | 105.40(5.04)                                    | 229.04(3.48)                                    | 377.72(3.45)                                   | 1.19(0.03)   |

D(v,0.1) = 10% of the distribution is below this value

D(v,0.5) = 50% of the distribution is below this value

D(v,0.9) = 90% of the distribution is below this value

\*mesh width ( $\mu\text{m}$ )

<sup>(a)</sup> or RS:MCC, (CJM) in Table 4-9

As described earlier, the composite particles which were produced from MCC passed through a sieve number 45 having an opening aperture of 355  $\mu\text{m}$  (CS) showed “rugby ball” shape and those produced from MCC of which the size was reduced by jet mill appeared in spherical shape. Here, a batch of spray dried composite particles were prepared from CEOLUS<sup>®</sup> PH101 to obtain different shape of composite particles for tableting. Their shape factors was determined by Morphologi<sup>®</sup> G3 Automated particle characterization system.

The SEM photomicrographs in Figure 4-8 show that most of RS:MCC (CS) composite particles were of rugby-ball like particles and a few had a spherical shape. Their particle size ranged mostly between 21.68  $\mu\text{m}$  D (v, 0.1) and 113.25  $\mu\text{m}$  D(v, 0.9). On the other hand, the SEM photomicrographs of RS:MCC (CJM) particles showed spherical shaped particles and the particles size ranged between 36.51  $\mu\text{m}$  D(v, 0.1) and 80.50  $\mu\text{m}$ (v, 0.9). Examples of automated images of RS:MCC composite particles produced from CS and CJM are shown in Figure 4-9 to Figure 4-10. It was shown that the size of composite particles of “rugby ball” like shape produced from CS was above 50  $\mu\text{m}$ .

## 2.4 Particle shape of composite particles

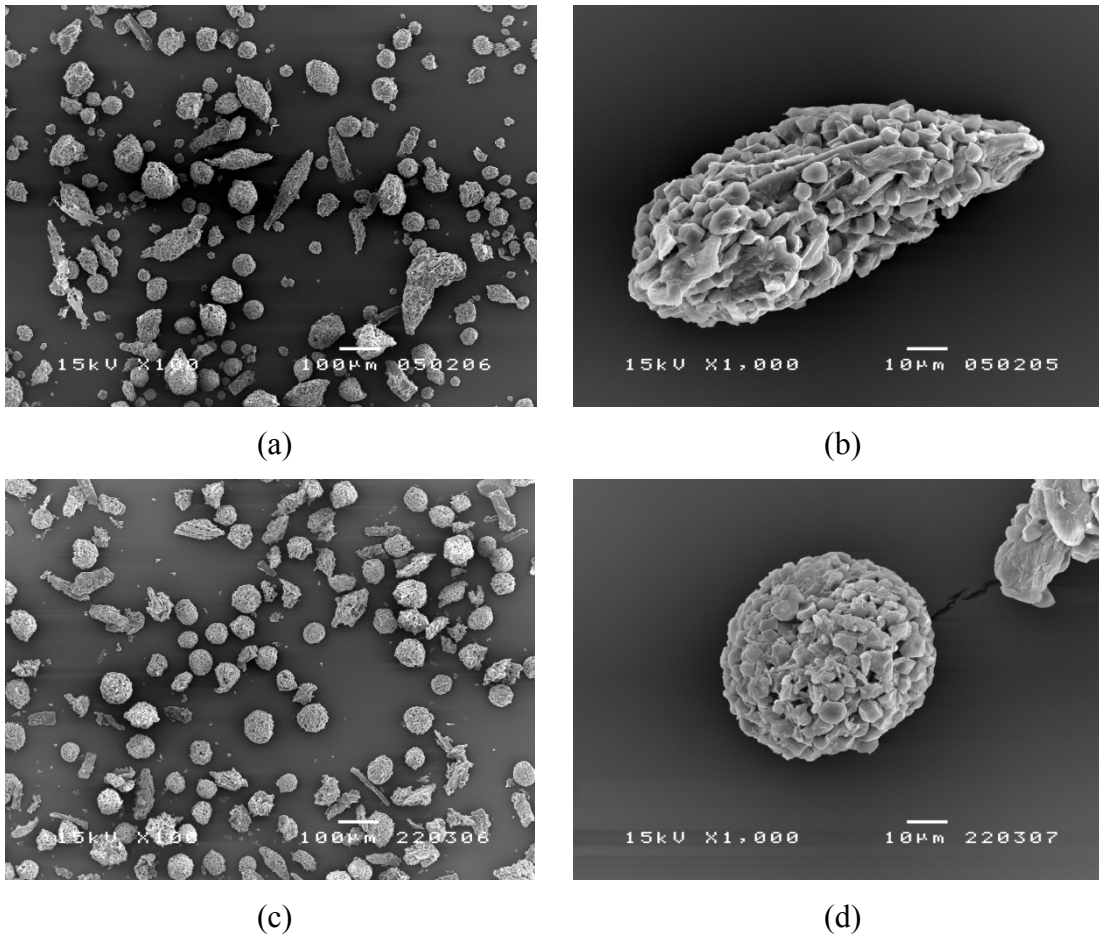

Figure 4-8 SEM photomicrographs of spray dried product using MCC from CEOLUS<sup>®</sup> PH101: (a-b) CS, MCC passed through a sieve number 45 having an opening aperture of 355 μm; (c-d) CJM, MCC that the size was reduced by jet mill

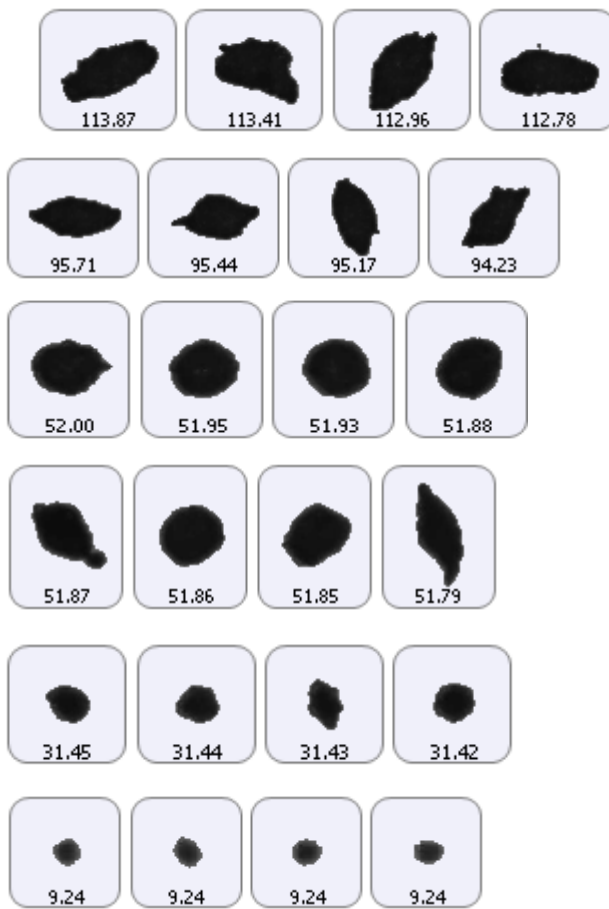

Figure 4-9 Examples of automated images of RS:MCC (CS) composite particles

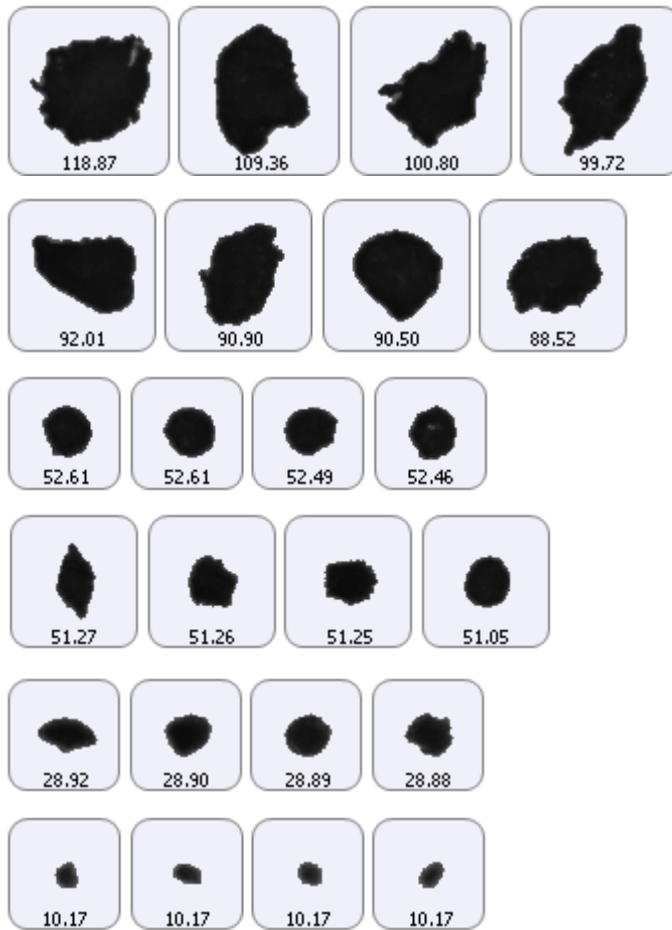

Figure 4-10 Examples of automated images of RS:MCC (CJM) composite particles

Table 4-8 Shape factors of composite particles using MCC from CEOLUS<sup>®</sup> PH101 which passed through a sieve number 45 having an opening aperture of 355  $\mu\text{m}$  (CS) and that the size was reduced by jet mill (CJM)

| Shape factor | Aspect Ratio |           |           | Elongation |           |           | CE Diameter |           |           | HS Circularity |           |           |
|--------------|--------------|-----------|-----------|------------|-----------|-----------|-------------|-----------|-----------|----------------|-----------|-----------|
|              | D [n,0.1]    | D [n,0.5] | D [n,0.9] | D [n,0.1]  | D [n,0.5] | D [n,0.9] | D [n,0.1]   | D [n,0.5] | D [n,0.9] | D [n,0.1]      | D [n,0.5] | D [n,0.9] |
| RS:MCC CS    | 0.57         | 0.86      | 0.95      | 0.05       | 0.15      | 0.47      | 7.33        | 18.22     | 57.22     | 0.69           | 0.94      | 0.98      |
| RS:MCC CJM   | 0.49         | 0.81      | 0.94      | 0.06       | 0.19      | 0.51      | 6.60        | 9.0       | 45.6      | 0.68           | 0.93      | 0.98      |



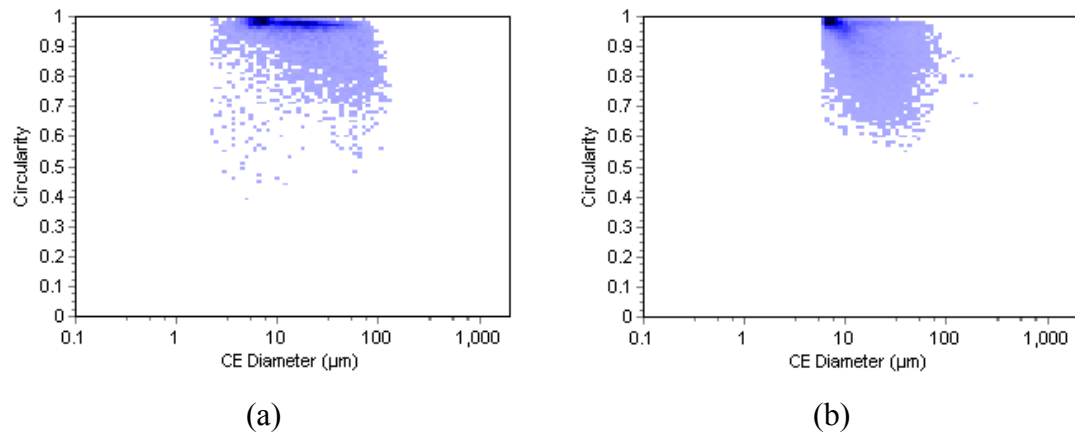

Figure 4-11 Scattergram showing relationship between CE diameter and circularity of composite particles using MCC from (a) CEOLUS<sup>®</sup> PH101 which passed through a sieve number 45 having an opening aperture of 355  $\mu\text{m}$  (CS) and (b) CEOLUS<sup>®</sup> PH101 which that the size was reduced by jet mill (CJM)

Shape factors of RS:MCC (CS) and RS:MCC (CJM) evaluated by using Morphologi<sup>®</sup> G3 Automated Particle Characterization System are shown in Table 4-8. Scattergram, which showed relationship between CE diameter and circularity of RS:MCC(CS) and RS:MCC (CJM) gave broad particles size distribution of RS:MCC (CS) than RS:MCC (CJM) was described in Figure 4-11

The parameters of physical shape of composite particles are demonstrated in Table 4-8. At D(n,0.5), physical shape of RS:MCC (CS) had an aspect ratio of 0.86, elongation of 0.15, CE diameter of 18.22 and HS circularity of 0.94; while the physical shape of RS:MCC (CJM) gave an aspect ratio of 0.81, elongation of 0.19, CE diameter of 9.0 and HS circularity of 0.93. The values indicated that they were almost spherical, with an aspect ratio value near to 1 and a shape symmetrical in all axes when elongation closer to 0. HS circularity closer to 1 also indicated that RS:MCC (CS) and RS:MCC (CJM) particles approached spherical shape, or circularities closer to 0 point to more irregular shapes. However, the CE diameter of RS:MCC (CS) was double value than that of RS:MCC (CJM), signifying that RS:MCC (CS) had a more elongated shape than RS:MCC (CJM). Therefore, difference in shape between the composite particles produced from CS and those produced from CJM was confirmed by the values of CE diameter.

The particle size of RS:MCC (CS) and RS:MCC (CJM) was found to be 57.44  $\mu\text{m}$  and 58.73  $\mu\text{m}$ , respectively and RS:MCC (CS) had smaller size distribution as presented in Table 4-9.

Table 4-9 Particle size and size distribution of composite particles using MCC from CEOLUS<sup>®</sup> PH101 which passed through a sieve number 45 having an opening aperture of 355  $\mu\text{m}$  (CS) and that the size was reduced by jet mill (CJM); average (SD), n = 3.

| <b>Composite particles</b> | <b>D (v,0.1)<br/>(<math>\mu\text{m}</math>)</b> | <b>D(v, 0.5)<br/>(<math>\mu\text{m}</math>)</b> | <b>D(v,0.9)<br/>(<math>\mu\text{m}</math>)</b> | <b>Span<br/>(D90-D10)<br/>/D50(<math>\mu\text{m}</math>)</b> |
|----------------------------|---|---|--|--|
| RS:MCC (CS)                | 21.68(0.14)                                     | 57.44(0.12)                                     | 113.25(0.44)                                   | 1.59(0.01)   |
| RS:MCC (CJM) <sup>a</sup>  | 36.51(0.13)                                     | 58.73(0.02)                                     | 80.50(0.03)                                    | 0.75(0.00)   |

<sup>a</sup>or RS:MCC, 45\* in Table 4-7

RS:MCC (CS) had an angle of repose of 46.17 degree, angle of spatula of 76.27 degree, bulk density of 0.37 g/ml, tapped density of 0.47 g/ml, compressibility percentage of 21.80 %, cohesion percentage of 8.67 % and flowability index of 53.00. These values indicated that RS:MCC (CS) did not show good flowability. RS:MCC (CJM) had an angle of repose of 51.80 degree, angle of spatula of 74.27 degree, bulk density of 0.31 g/ml, tapped density of 0.45 g/ml, compressibility percentage of 31.40 %, cohesion percentage of 2.30 % and flowability index of 44.33. This also indicated that RS:MCC (CJM) did not have good flowability.

Table 4-10 Flow properties of composite particles using MCC from CEOLUS<sup>®</sup> PH101 which passed through a sieve number 45 having an opening aperture of 355  $\mu\text{m}$  (CS) and that the size was reduced by jet mill (CJM); average (SD), n = 3.

| Test                      | RS:MCC (CS) | RS:MCC (CJM) <sup>a</sup> |
|---------------------------|-------------|---------------------------|
| Angle of Repose (degree)  | 46.17(2.43) | 51.80(2.93)               |
| Angle of Spatula (degree) | 76.27(1.80) | 74.27(1.94)               |
| Bulk Density (g/ml)       | 0.37(0.00)  | 0.31(0.01)                |
| Tapped Density (g/ml)     | 0.47(0.00)  | 0.45(0.01)                |
| Compressibility (%)       | 21.80(0.56) | 31.40(0.82)               |
| Cohesiveness (%)          | 8.67(2.63)  | 2.30(2.84)                |
| Flowability Index         | 53.00(5.29) | 44.33(4.01)               |

<sup>a</sup> or RS:MCC, 45\* in Table 4-7

### 3. Tableting of composite particles

#### 3.1 Effect of manufacturing sources of MCC

Tablets properties of RS:MCC tablets using MCC from two manufacturing sources were presented in Table 4-11. An increase in hardness with enlarged pressure level was observed from tableting of composite particles produced with CEOLUS<sup>®</sup> PH 101 and COMPRECEL<sup>®</sup>. For 500 mg tableting, at compression pressure of 1 metric ton, RS:MCC (COMPRECEL<sup>®</sup>) composite particles gave higher tablet hardness than RS:MCC (CEOLUS<sup>®</sup> PH 101) composite particles. While, at the force of 1.5 and 2 metric ton, RS:MCC (CEOLUS<sup>®</sup> PH 101) composite particles gave higher hardness of tablets than that of RS:MCC (COMPRECEL<sup>®</sup>) tablets. For 350 mg tablets compressed at the force of 1, 1.5 and 2 metric ton, RS:MCC (CEOLUS<sup>®</sup> PH 101) composite particles always gave harder tablets. It has been reported that MCC of various sources gave varied hardness (Albers, Knop, and Kleinebudde, 2006)

Size of tablets in terms of thickness and diameter are given by dimension of punch and die. Thickness of the 500 mg tablets compressed at three forces was in the range of 2.87 - 3.24 mm and diameters were in the range of 12.90 – 13.03 mm as reported in Table 4-11. Thickness of the 350 mg tablets compressed at three force were 3.51 - 3.85 mm. and diameter were 9.36 – 9.51 mm as presented in Table 4-12 .

Friability of both RS:MCC composite particle 500 mg and 350 mg tablets compressed with different forces were similar. The values of % friability were less than 1%. These values were corresponding to tablet hardness; the harder tablet, the less friability.

Table 4-11 Physical properties of 500 mg RS:MCC tablets produced from two manufacturing sources of MCC (CEOLUS<sup>®</sup> PH101 and COMPRECEL<sup>®</sup>), average SD).

| Source of MCC              | Pressure (Metric ton) | Hardness (N) (n =10) | Thickness (mm) (n =10) | Diameter (mm) (n =10) | Friability (%) | DT (min) |
|----------------------------|-----------------------|----------------------|------------------------|-----------------------|----------------|----------|
| COMPRE-CEL <sup>®</sup>    | 1                     | 191.48<br>(16.63)    | 3.09<br>(0.08)         | 12.90<br>(0.02)       | 0.44           | 2.47     |
|                            | 1.5                   | 249.54<br>(14.89)    | 2.93<br>(0.04)         | 12.99<br>(0.01)       | 0.24           | 1.80     |
|                            | 2                     | 287.68<br>(10.63)    | 2.87<br>(0.05)         | 12.96<br>(0.01)       | 0.17           | 2.58     |
| CEOLUS <sup>®</sup> PH 101 | 1                     | 169.49<br>(11.18)    | 3.24<br>(0.03)         | 13.03<br>(0.01)       | 0.24           | 2.67     |
|                            | 1.5                   | 278.32<br>(8.15)     | 3.03<br>(0.03)         | 12.99<br>(0.02)       | 0.09           | 3.87     |
|                            | 2                     | 302.50<br>(6.41)     | 3.02<br>(0.03)         | 12.99<br>(0.01)       | 0.03           | 2.46     |

Table 4-12 Physical properties of 350 mg RS:MCC tablets produced from two manufacturing sources of MCC (CEOLUS<sup>®</sup> PH101 and COMPRECEL<sup>®</sup>), average (SD)

| Source of MCC              | Pressure (Metric ton) | Hardness (N) (n =10) | Thickness (mm) (n =10) | Diameter (mm) (n =10) | Friability (%) | DT (min) |
|----------------------------|-----------------------|----------------------|------------------------|-----------------------|----------------|----------|
| COMPRECEL <sup>®</sup>     | 1                     | 252.17<br>(20.90)    | 3.68<br>(0.10)         | 9.38<br>(0.05)        | 0.16           | 2.56     |
|                            | 1.5                   | 272.20<br>(16.02)    | 3.66<br>(0.08)         | 9.42<br>(0.03)        | 0.20           | 2.54     |
|                            | 2                     | 284.03<br>(16.39)    | 3.51<br>(0.09)         | 9.36<br>(0.06)        | 0.21           | 2.59     |
| CEOLUS <sup>®</sup> PH 101 | 1                     | 276.22<br>(26.83)    | 3.85<br>(0.05)         | 9.51<br>(0.01)        | 0.10           | 2.58     |
|                            | 1.5                   | 305.14<br>(8.80)     | 3.79<br>(0.04)         | 9.51<br>(0.01)        | 0.10           | 3.46     |
|                            | 2                     | 328.77<br>(8.41)     | 3.74<br>(0.05)         | 9.51<br>(0.02)        | 0.01           | 3.45     |

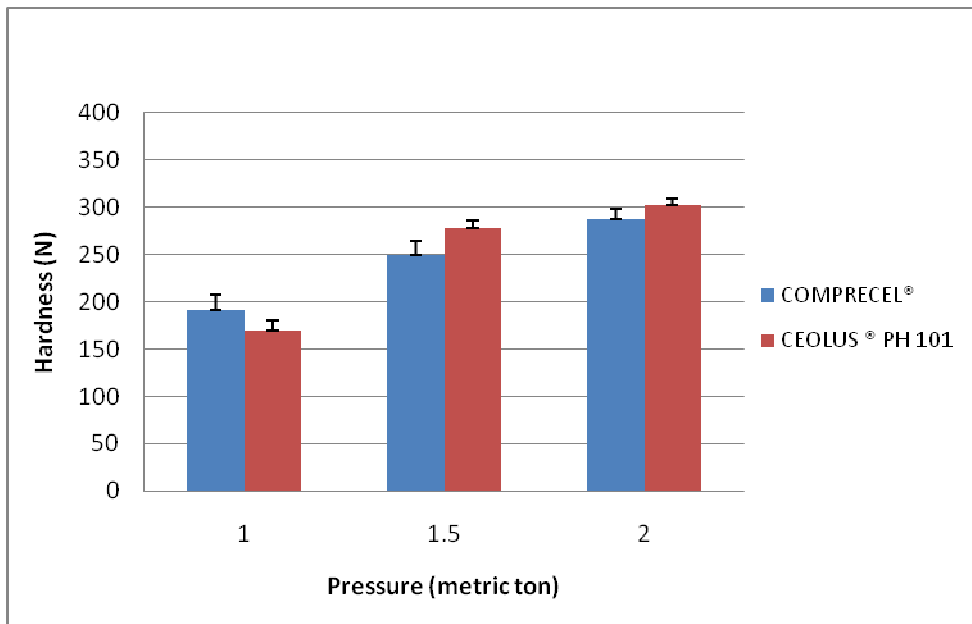

Figure 4-12 Relationship between pressure and hardness of 500 mg RS:MCC tablets produced from two manufacturing sources of MCC (CEOLUS® PH101 and COMPRECEL®)

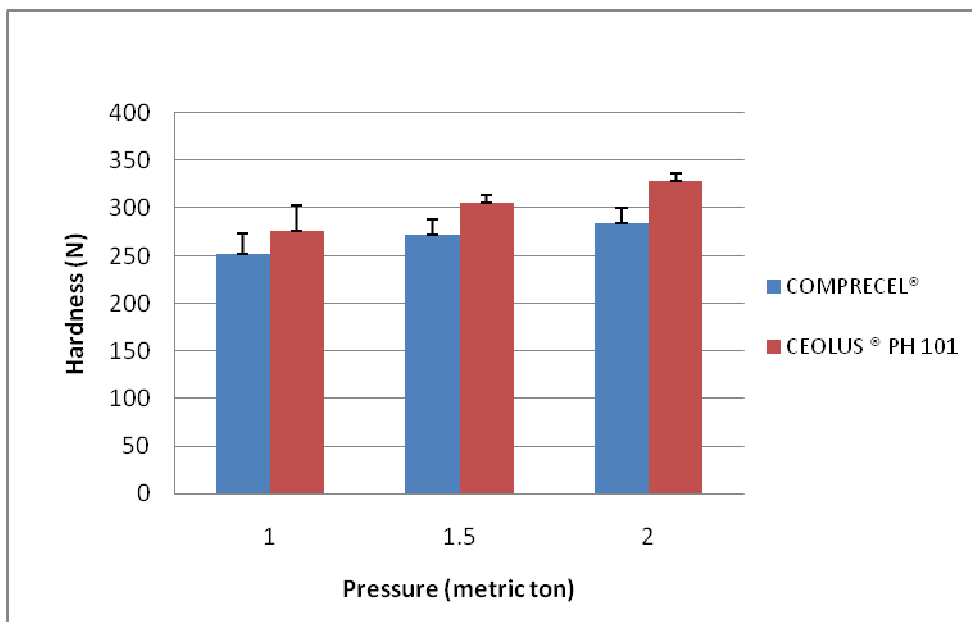

Figure 4-13 Relationship between pressure and hardness of 350 mg RS:MCC tablets produced from two manufacturing sources of MCC (CEOLUS® PH101 and COMPRECEL®)

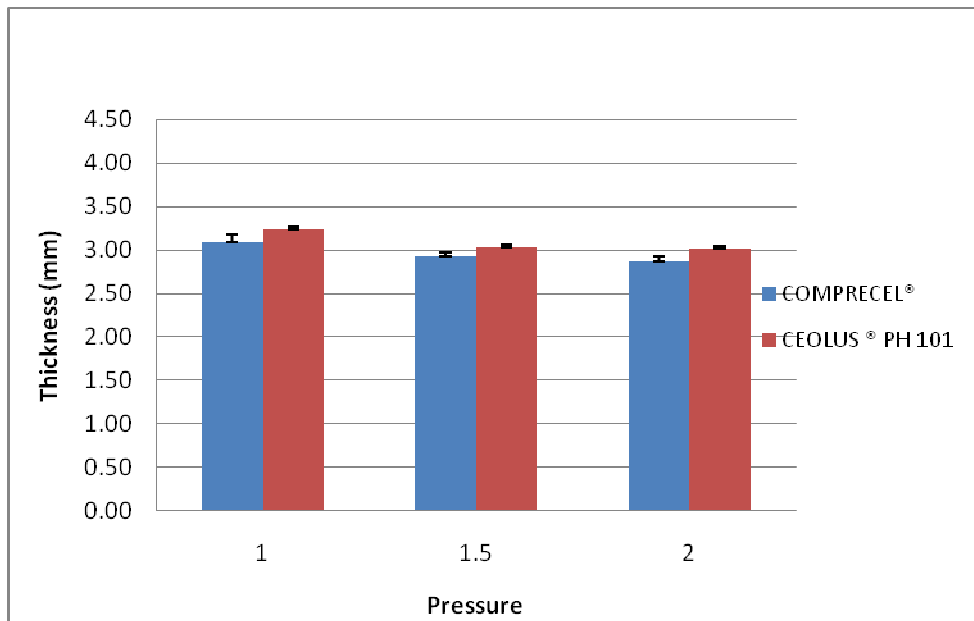

Figure 4-14 Relationship between pressure and thickness of 500 mg RS:MCC tablets produced from two manufacturing sources of MCC (CEOLUS® PH101 and COMPRECEL®)

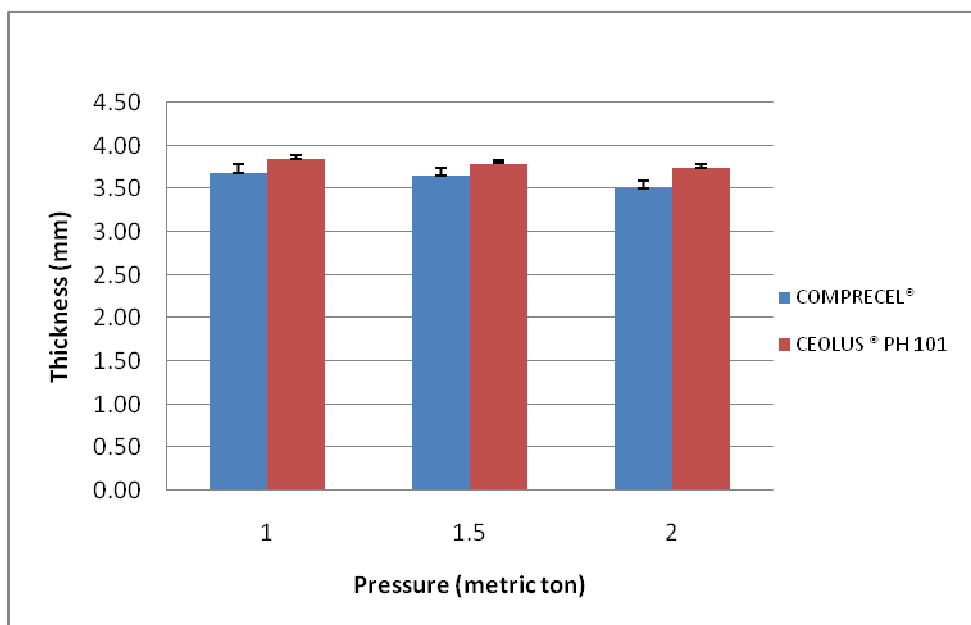

Figure 4-15 Relationship between pressure and thickness of 350 mg RS:MCC tablets produced from two manufacturing sources of MCC (CEOLUS® PH101 and COMPRECEL®)

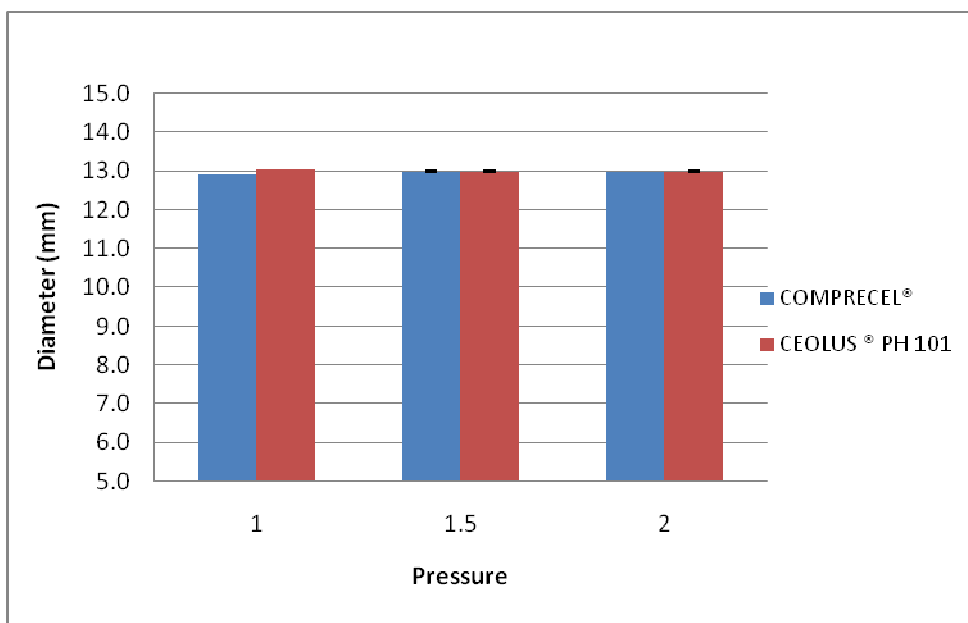

Figure 4-16 Relationship between pressure and diameter of 500 mg RS:MCC tablets produced from two manufacturing sources of MCC (CEOLUS® PH101 and COMPRECEL®)

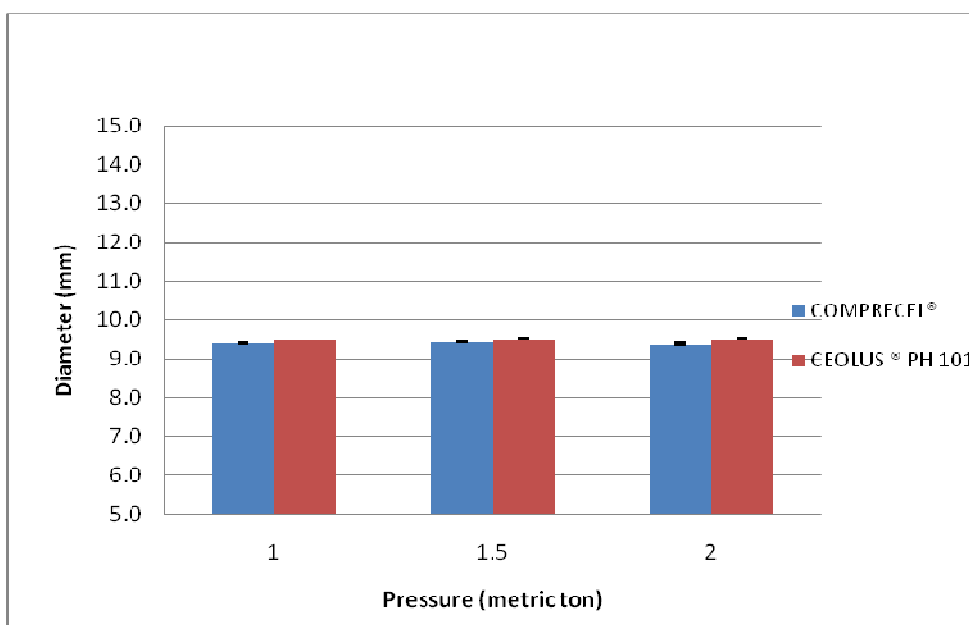

Figure 4-17 Relationship between pressure and diameter of 350 mg RS:MCC tablets produced from two manufacturing sources of MCC (CEOLUS® PH101 and COMPRECEL®)



Disintegration time of 500 mg and 350 mg tablets of RS:MCC (CEOLUS<sup>®</sup> PH 101) and RS:MCC (COMPRECEL<sup>®</sup>) compressed with different forces were not markedly different.

According to the experimental results, the RS:MCC formulation using CEOLUS<sup>®</sup> PH 101 were chosen for further studies due to that it gave prominent tablet hardness.

### **3.2 Effect of moisture content of composite powders**

Physical properties of 500 mg and 350 mg RS:MCC tablets prepared using RS:MCC composite particle powder contains difference moisture contents, 7.01%, 10.79% and 15.73% are presented in Table 4-13 to Table 4-14. Graphical displays of relationship between moisture content and hardness, thickness and diameter are shown in Figure 4-19 to 4-24, respectively.

Experimental results showed that an increase in hardness of RS:MCC tablets with increased pressure levels was apparent. The levels of moisture content significantly affected hardness of 500 mg and 350 mg tablets at any compression forces ( $p < 0.05$ ). The hardness of the 500 mg RS:MCC tablets with 7.01% moisture content, compressed at the force of 1, 1.5 and 2 metric ton, was lower than 10.79 % water content but much higher than 15.73 % water content. Hence, there seemed to be optimum moisture content for compression of tablet with good hardness.

In addition, it was found that the hardness of the 350 mg RS:MCC tablets with 7.01% moisture content compressed at the force of 1 metric ton was lower than the tablets with 10.79 % moisture content, but they were harder than the tablets with 15.73 % moisture content. The hardness of 350 mg RS:MCC tablets with 7.01 % moisture content compressed at the force of 1.5 and 2 metric ton was higher than those with 10.79 % and 15.73 % moisture content. Thus, the effect of moisture content on tablet hardness may be interacted with levels of compression force, depending on tablet size.

Table 4-13 Physical properties of 500 mg tablets of RS:MCC containing different moisture contents, average (SD)

| <b>Moisture content (%)</b> | <b>Pressure (Metric ton)</b> | <b>Hardness (N) (n =10)</b> | <b>Thickness (mm) (n =10)</b> | <b>Diameter (mm) (n =10)</b> | <b>Friability (%)</b> | <b>DT (min)</b> |
|-----------------------------|------------------------------|-----------------------------|-------------------------------|------------------------------|-----------------------|-----------------|
| <b>7.01</b>                 | 1                            | 186.64<br>(18.55)           | 3.36<br>(0.09)                | 13.12<br>(0.05)              | 0.23                  | 2.13            |
|                             | 1.5                          | 253.87<br>(13.87)           | 3.21<br>(0.11)                | 13.10<br>(0.02)              | 0.10                  | 1.44            |
|                             | 2                            | 286.38<br>(11.65)           | 3.09<br>(0.02)                | 13.08<br>(0.01)              | 0.05                  | 1.56            |
| <b>10.79</b>                | 1                            | 257.09<br>(12.99)           | 3.10<br>(0.03)                | 13.03<br>(0.01)              | 0.31                  | 2.46            |
|                             | 1.5                          | 294.88<br>(6.32)            | 3.02<br>(0.03)                | 13.03<br>(0.01)              | 0.15                  | 1.47            |
|                             | 2                            | 303.21<br>(5.52)            | 3.02<br>(0.02)                | 13.03<br>(0.01)              | 0.25                  | 2.12            |
| <b>15.73</b>                | 1                            | 85.87<br>(8.52)             | 3.27<br>(0.05)                | 13.05<br>(0.02)              | NA                    | 1.41            |
|                             | 1.5                          | 116.02<br>(7.60)            | 3.22<br>(0.05)                | 13.04<br>(0.01)              | NA                    | 3.28            |
|                             | 2                            | 145.76<br>(12.04)           | 3.20<br>(0.05)                | 13.06<br>(0.02)              | NA                    | 6.34            |

Note : NA = not applicable (capping of tablets)

Table 4-14 Physical properties of 350 mg tablets of RS:MCC containing different moisture contents, average (SD).

| Moisture content (%) | Pressure (Metric ton) | Hardness (N) (n =10) | Thickness (mm) (n =10) | Diameter (mm) (n =10) | Friability (%) | DT (min) |
|----------------------|-----------------------|----------------------|------------------------|-----------------------|----------------|----------|
| 7.01                 | 1                     | 303.53<br>(16.90)    | 3.68<br>(0.10)         | 9.38<br>(0.05)        | 0.30           | 1.57     |
|                      | 1.5                   | 324.24<br>(10.45)    | 3.80<br>(0.06)         | 9.46<br>(0.05)        | 0.04           | 3.11     |
|                      | 2                     | 330.27<br>(8.50)     | 3.17<br>(0.16)         | 9.44<br>(0.16)        | 0.14           | 1.59     |
| 10.79                | 1                     | 313.01<br>(11.06)    | 3.72<br>(0.04)         | 9.52<br>(0.02)        | 0.23           | 2.34     |
|                      | 1.5                   | 300.75<br>(6.36)     | 3.79<br>(0.06)         | 9.51<br>(0.02)        | 0.16           | 2.37     |
|                      | 2                     | 309.48<br>(4.62)     | 3.71<br>(0.08)         | 9.57<br>(0.08)        | 0.20           | 2.47     |
| 15.73                | 1                     | 88.15<br>(8.54)      | 3.77<br>(0.13)         | 9.50<br>(0.02)        | capping        | 4.15     |
|                      | 1.5                   | 100.00<br>(5.58)     | 3.81<br>(0.08)         | 9.50<br>(0.01)        | capping        | 3.41     |
|                      | 2                     | 117.90<br>(7.92)     | 3.77<br>(0.09)         | 9.35<br>(0.03)        | capping        | 5.01     |



Figure 4-18 Capping of RS:MCC (CEOLUS<sup>®</sup> PH101) tablets with 15.73%

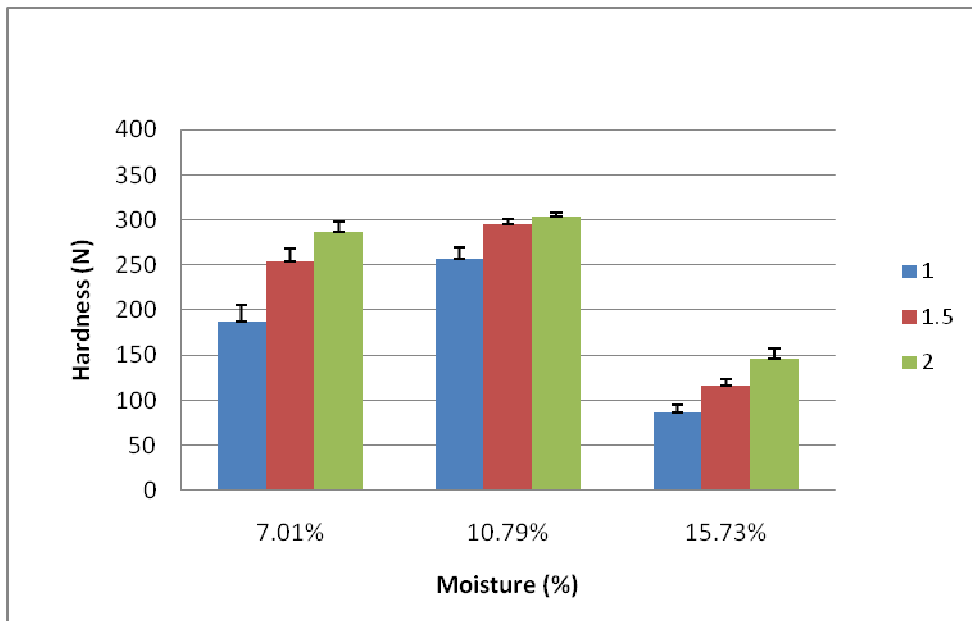

**Figure 4-19** Relationship between moisture content and hardness of 500 mg RS:MCC tablets

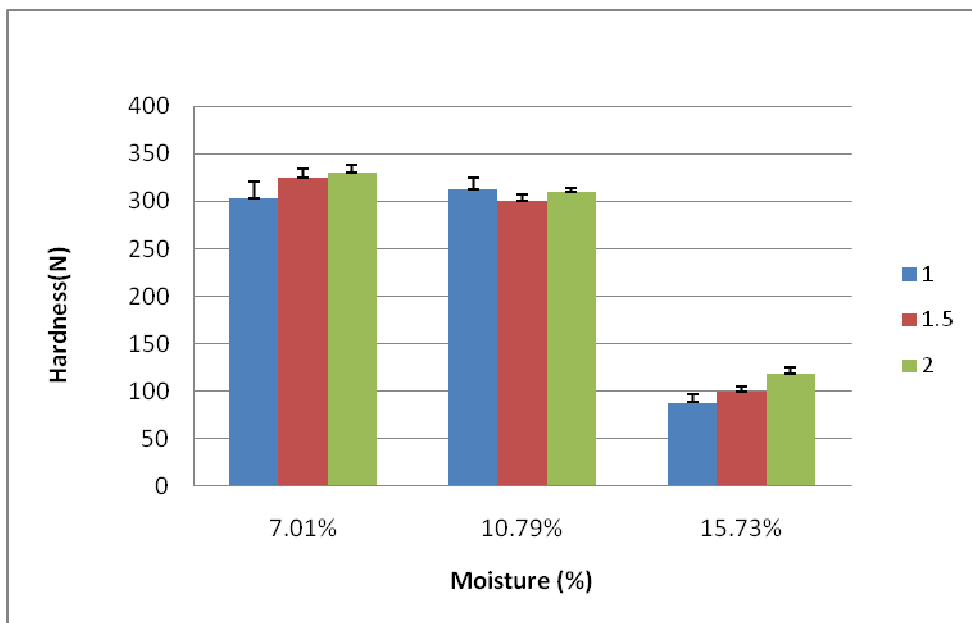

**Figure 4-20** Relationship between moisture content and hardness of 350 mg RS:MCC tablets

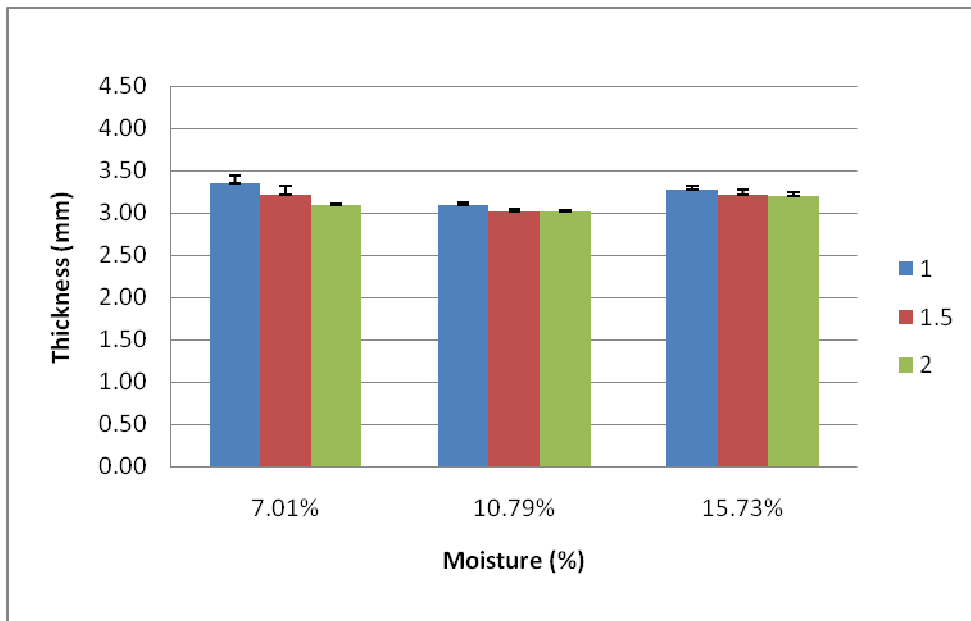

**Figure 4-21** Relationship between moisture content and thickness of 500 mg RS:MCC tablets

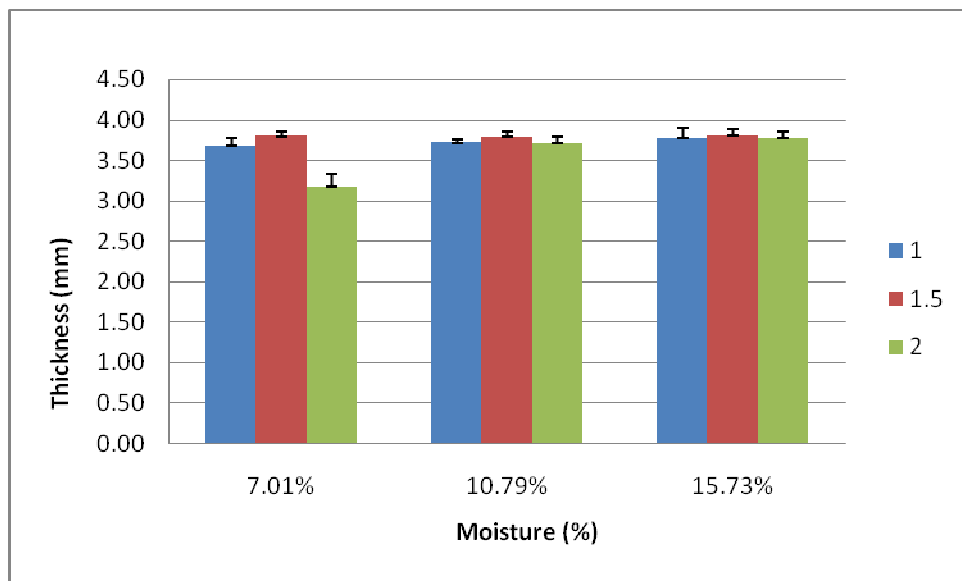

**Figure 4-22** Relationship between moisture content and thickness of 350 mg RS:MCC tablets.

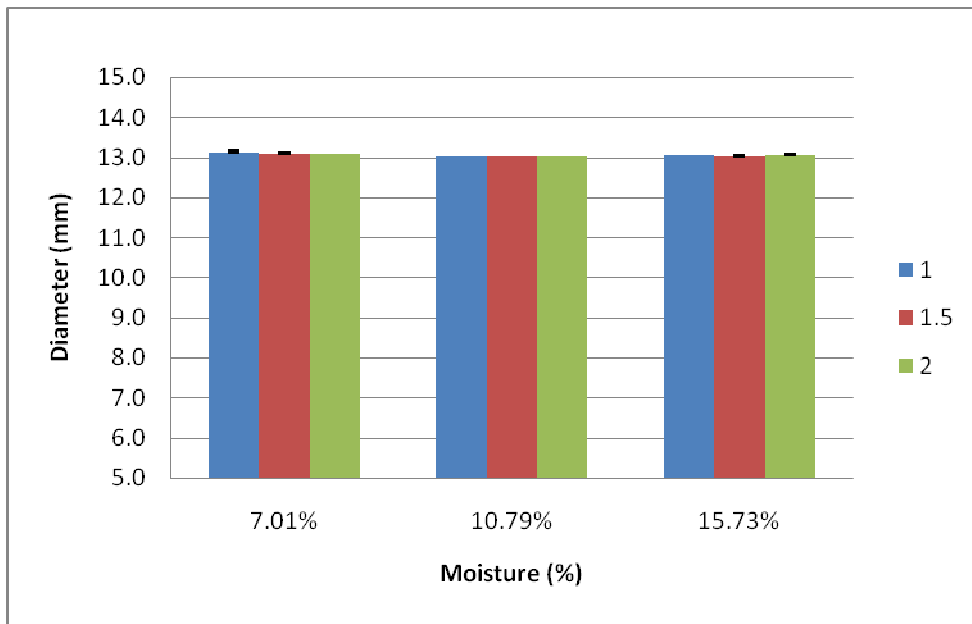

**Figure 4-23** Relationship between moisture content and diameter of 500 mg RS:MCC tablets.

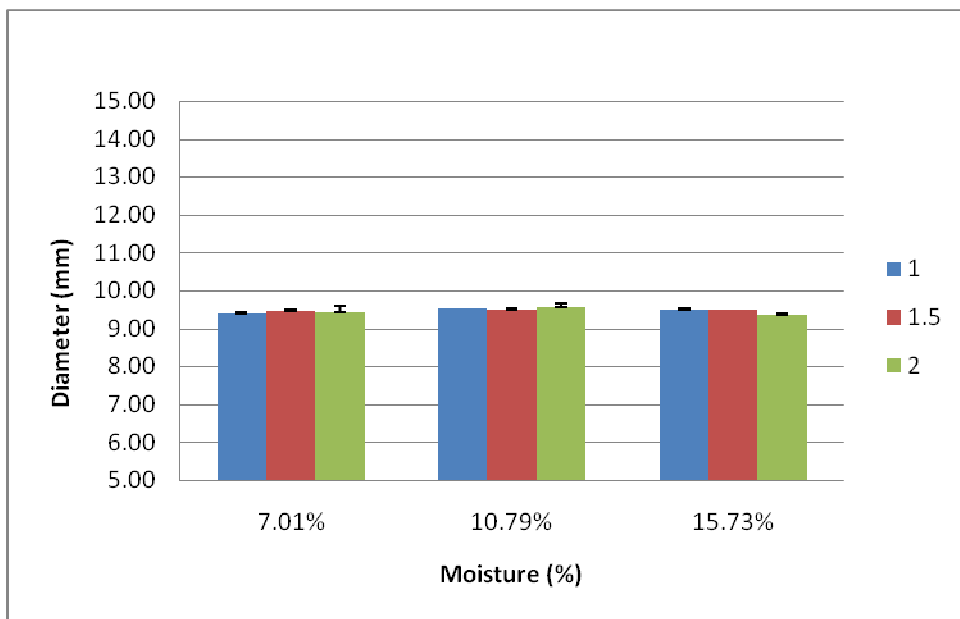

**Figure 4-24** Relationship between moisture content and diameter of 350 mg RS:MCC tablets

According to Zhang et al., (2003) hydrogen bonding showed a large responsibility in condensed hardness. Hydrogen bonding is important because MCC endure significant plastic deformation during compression. In addition, the existence of moisture inside the porous structure of MCC acts as an internal lubricant. This assists slippage and flow within the individual microcrystals in plastic deformation, which implements the formation of hydrogen bond bridges and gives MCC an excellent hardness. Moisture content of MCC is typically less than 5% w/w and different grades may contain varying amounts of water (Callahan et al., 1982). All starches, including rice starch are hygroscopic and rapidly absorb atmospheric moisture. The significant moisture sorption of rice starch in RS:MCC may give adverse effect to compression as tablet hardness was reduced markedly at 15.73% moisture content.

Thickness of the 500 mg tablets compressed with three different forces were between 3.02 to 3.36 mm; the higher thickness tablet could be due to swelling of the RS:MCC composite particles. Their diameters ranged from 13.03 to 13.12 corresponding to the size of punch and die. (Table 4-13, Figure 4-21 and Figure 4-23). The tests on RS:MCC 350 mg tablet gave the similar results as the tests on 500 mg tablet which showed 3.17 - 3.81 mm in tablets thickness and 9.35-9.57 mm. in tablets diameter (Table 4-14 , Figure 4-22 and Figure 4-24).

Percent friability of tablets prepared from RS:MCC containing various water content were not difference. The values of % friability of 500 mg tablets were 0.05% to 0.31% (Table 4-13). Percent friability of 350 mg RS:MCC tablets containing various water content was not different. The values of percent friability of these tablets were very small, between 0.04% and 0.3%, regardless tablet hardness. Capping was found in the RS:MCC tablets containing 15.73% moisture content as shown in Figure 4-18 due to that these tablets had less binding property of excessive moisture content in the composite particles. The amount of rice starch which was able to absorb high amount of moisture in RS:MCC was greater than that of MCC, therefore, the effect of moisture content on compactibility from starch would then be dominant (Gohel et al., 2005).

Overall disintegration time (DT) of 500 mg and 350 mg RS:MCC tablets at 15.73 % moisture content gave slightly longer DT than RS:MCC tablets with 7.01% and 10.79% moisture content. This indicated moisture content in RS:MCC composite particles affecting on the strength of tablets. Although hardness of RS:MCC tablets with 15.73 % moisture content was reduced, DT was shown to be longer RS:MCC tablets of higher moisture content might be due to gel formation during tableting; the gelatinous layer obstructed water diffusion into the tablets and thus prolonged the disintegration time.

Physical properties i.e. hardness, thickness and diameter of 500 mg and 350 MCC tablets are shown in Table 4-15 to 4-16, Figure 4-25 to 4-30.

For both tablet sizes, at the compression force of 1 metric ton, there was significant difference in the hardness of MCC tablets with 3.60% or 6.57% moisture content comparing with that with 10.78% moisture content ( $p < 0.05$ ). At higher compression force levels, the effect of moisture content was clearly shown. The hardness of MCC tablets with all different levels of moisture content showed significant difference ( $p < 0.05$ ). Generally, at all levels of compression force, MCC tablets with 3.60 % moisture content gave the highest hardness when compared with MCC tablets of 6.57 % moisture content and 10.78 % water contents. A decrease in the MCC tablet hardness was observed when the moisture content was increased. This might be due to that bridges formation between MCC particles was hindered with excessive moisture content. Khan et al., (1981) reported that moisture uptake could alter the microporous structure of the tablets, as was reflected by the increase in total porosity values. This process was attributed to the adsorbed water breaking hydrogen bonds between MCC fibres and so creating more open structures, caused serious deterioration in the mechanical properties of the tablets. Other authors have also noted the harmful effect of humidity on the mechanical properties of MCC tablets (Nyquist and Nicklasson, 1983; Khan et al., 1981).

Thickness of the 500 mg MCC tablets, compressed with three different pressures, ranged from 2.77 to 3.07 mm. Furthermore, tablets thickness derived from applying these three pressure levels were slightly difference. Their diameter ranged from 12.96 to 13.28 mm. Percent friability of the tablets prepared from MCC contained various water contents were similar, ranging between 0.00% to 0.33%.



Thickness of the 350 mg MCC tablets compressed at three forces were 3.61 to 3.95 mm and diameter of these tablets were in the range of 9.50 to 9.55 mm. Percent friability of these tablets which contained various moisture content did not show much difference, ranging between 0.01 % to 0.37 %.

Disintegration time (DT) of 500 mg and 350 mg MCC tablets at any moisture content level gave longer DT than the tablets produced from RS:MCC. This may be attributed to that MCC tablets were generally harder than RS:MCC and that MCC tablets without other excipient may absorb water, forming swollen network of cellulose fibre which entrapped water but the structure itself did not disintegrate.

Table 4-15 Physical properties of 500 mg tablets of MCC containing different moisture contents, average (SD)

| <b>Moisture content (%)</b> | <b>Pressure (Metric ton)</b> | <b>Hardness (N) (n =10)</b> | <b>Thickness (mm) (n =10)</b> | <b>Diameter (mm) (n =10)</b> | <b>Friability (%)</b> | <b>DT (min)</b> |
|-----------------------------|------------------------------|-----------------------------|-------------------------------|------------------------------|-----------------------|-----------------|
| 3.60                        | 1                            | 308.28<br>(7.41)            | 3.07<br>(0.07)                | 12.97<br>(0.01)              | 0.15                  | >15             |
|                             | 1.5                          | 317.05<br>(4.83)            | 2.88<br>(0.04)                | 12.97<br>(0.02)              | 0.00                  | >15             |
|                             | 2                            | 323.35<br>(7.33)            | 2.77<br>(0.04)                | 12.97<br>(0.01)              | 0.09                  | >15             |
| 6.57                        | 1                            | 299.99<br>(9.75)            | 2.98<br>(0.03)                | 13.02<br>(0.01)              | 0.06                  | >15             |
|                             | 1.5                          | 299.85<br>(14.58)           | 3.06<br>(0.26)                | 13.28<br>(0.24)              | 0.11                  | >15             |
|                             | 2                            | 311.33<br>(5.41)            | 2.77<br>(0.05)                | 13.01<br>(0.02)              | 0.03                  | >15             |
| 10.78                       | 1                            | 285.51<br>(11.73)           | 2.93<br>(0.03)                | 13.04<br>(0.01)              | 0.25                  | >15             |
|                             | 1.5                          | 274.20<br>(4.97)            | 2.80<br>(0.03)                | 12.97<br>(0.01)              | 0.24                  | >15             |
|                             | 2                            | 263.70<br>(11.04)           | 2.86<br>(0.03)                | 12.96<br>(0.11)              | 0.33                  | >15             |

Table 4-16 Physical properties of 350 mg tablets of MCC containing different moisture contents, average (SD).

| <b>Moisture content (%)</b> | <b>Pressure (Metric ton)</b> | <b>Hardness (N) (n =10)</b> | <b>Thickness (mm) (n =10)</b> | <b>Diameter (mm) (n =10)</b> | <b>Friability (%)</b> | <b>DT (min)</b> |
|-----------------------------|------------------------------|-----------------------------|-------------------------------|------------------------------|-----------------------|-----------------|
| 3.60                        | 1                            | 339.03<br>(5.61)            | 3.95<br>(0.08)                | 9.55<br>(0.01)               | 0.04                  | >15             |
|                             | 1.5                          | 345.96<br>(4.72)            | 3.72<br>(0.05)                | 9.54<br>(0.01)               | 0.12                  | >15             |
|                             | 2                            | 352.31<br>(7.42)            | 3.72<br>(0.05)                | 9.53<br>(0.01)               | 0.02                  | >15             |
| 6.57                        | 1                            | 330.15<br>(7.31)            | 3.65<br>(0.06)                | 9.53<br>(0.02)               | 0.29                  | >15             |
|                             | 1.5                          | 331.69<br>(5.20)            | 3.61<br>(0.05)                | 9.51<br>(0.00)               | 0.37                  | >15             |
|                             | 2                            | 341.36<br>(6.05)            | 3.66<br>(0.11)                | 9.50<br>(0.02)               | 0.33                  | >15             |
| 10.78                       | 1                            | 287.04<br>(12.37)           | 3.66<br>(0.09)                | 9.52<br>(0.02)               | 0.08                  | >15             |
|                             | 1.5                          | 303.27<br>(7.82)            | 3.72<br>(0.07)                | 9.50<br>(0.06)               | 0.07                  | >15             |
|                             | 2                            | 302.68<br>(9.41)            | 3.78<br>(0.21)                | 9.50<br>(0.04)               | 0.01                  | >15             |

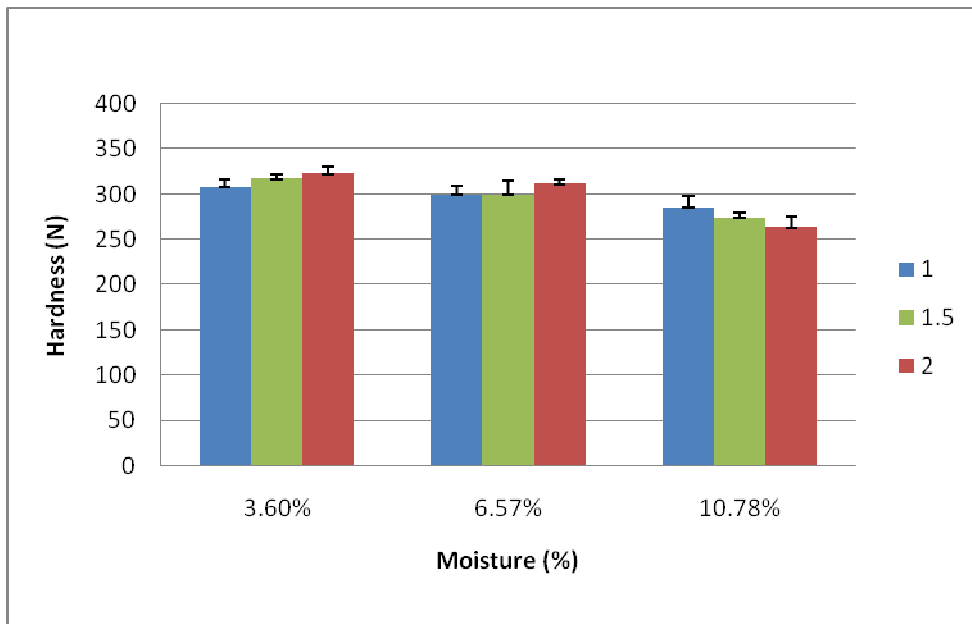

Figure 4-25 Relationship between moisture content and hardness of 500 mg MCC tablets.

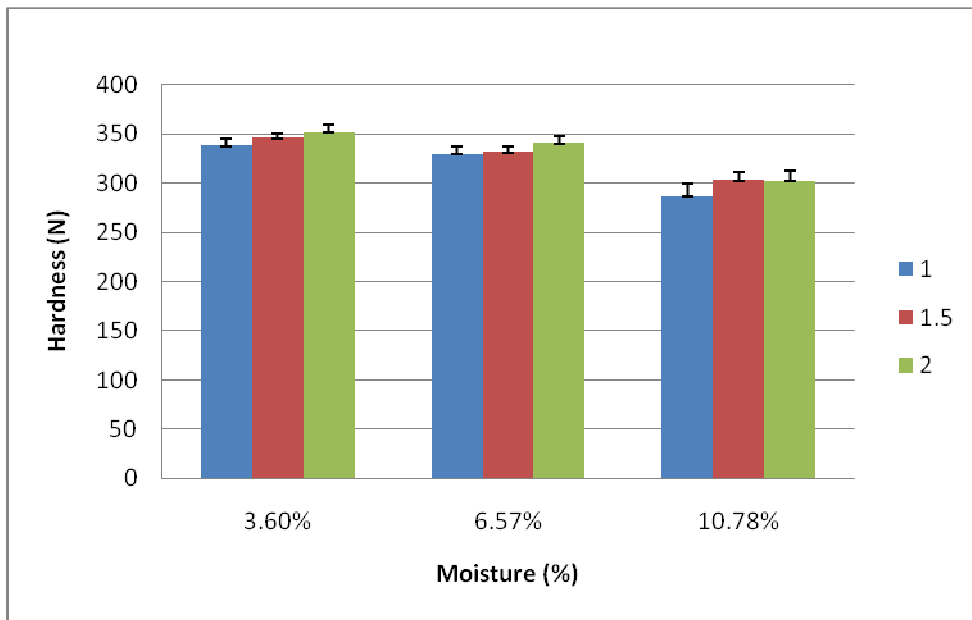

Figure 4-26 Relationship between moisture content and hardness of 350 mg MCC tablets.

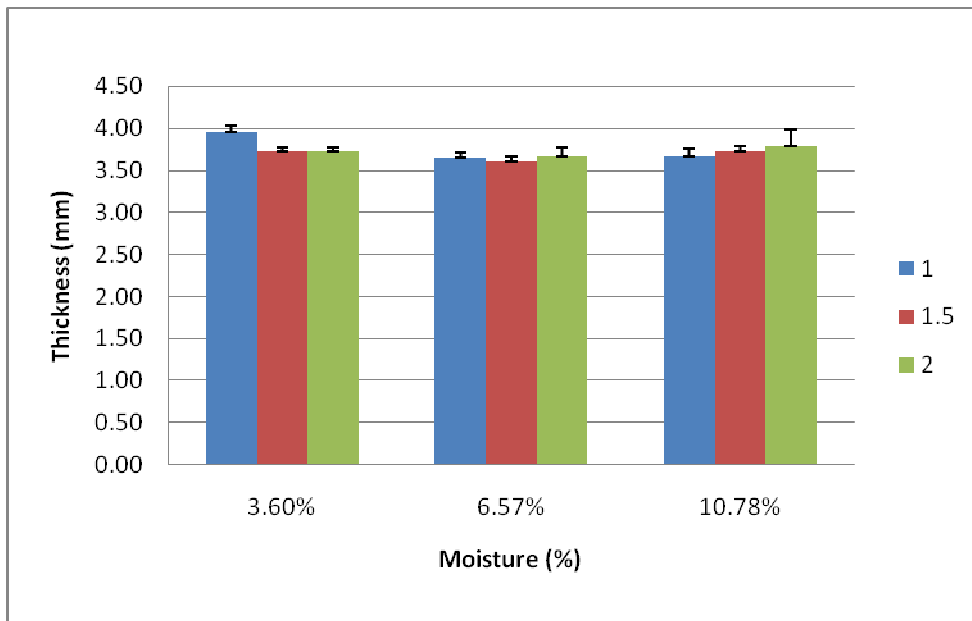

Figure 4-27 Relationship between moisture content and thickness of 500 mg MCC tablets.

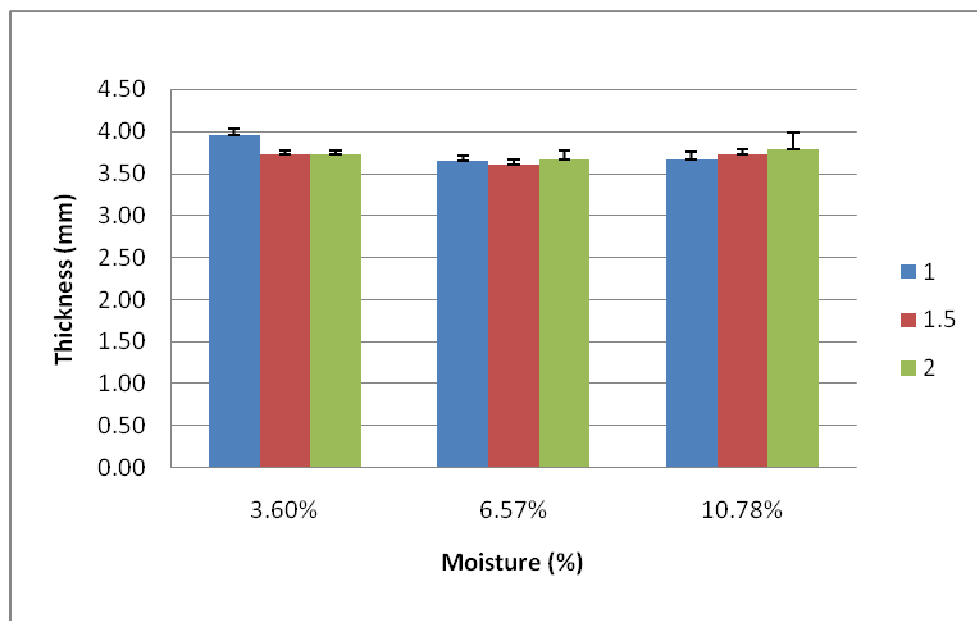

Figure 4-28 Relationship between moisture content and thickness of 350 mg MCC tablets.

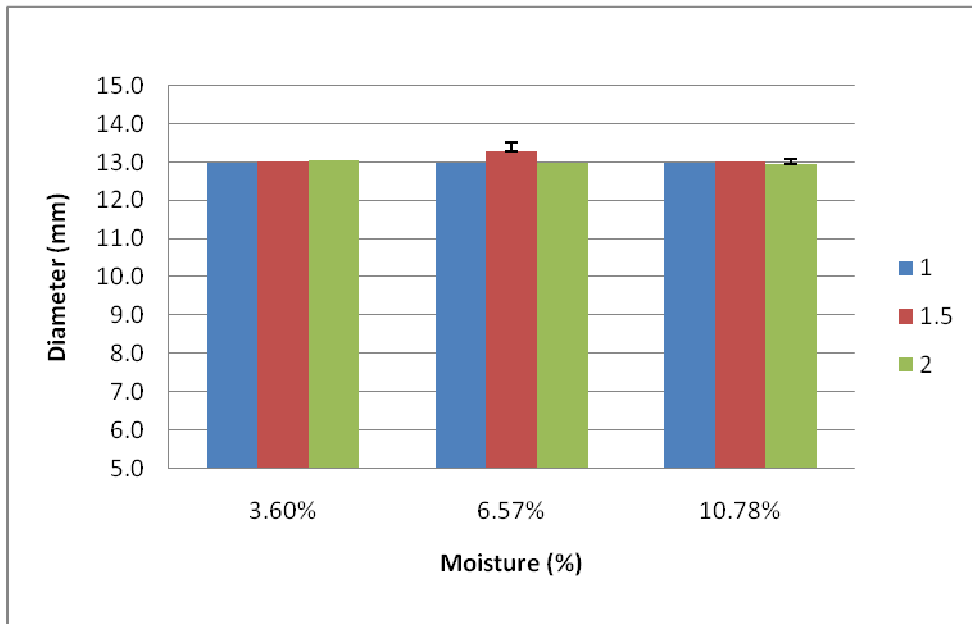

Figure 4-29 Relationship between moisture content and diameter of 500 mg MCC tablets.

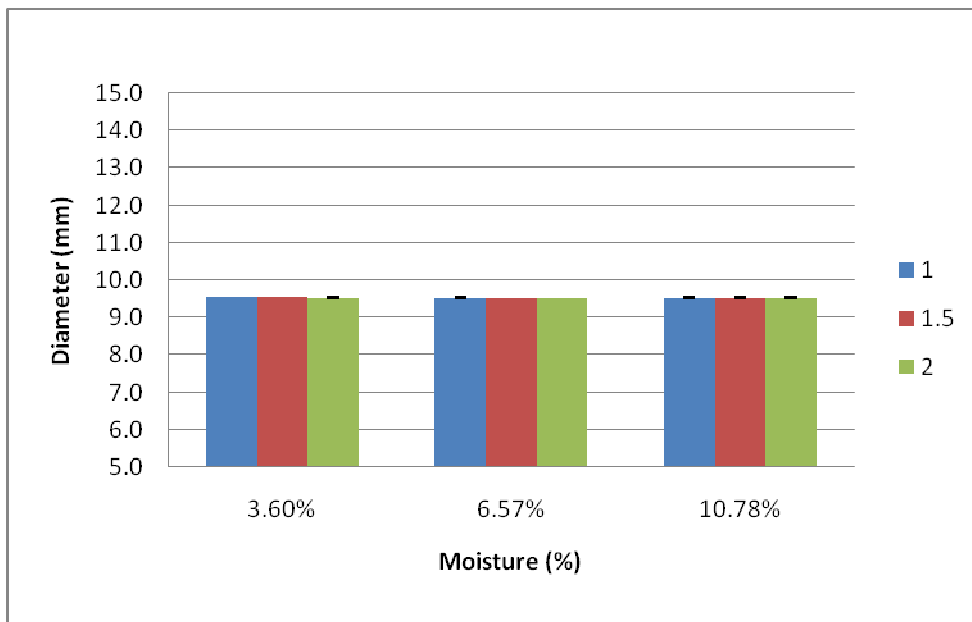

Figure 4-30 Relationship between moisture content and diameter of 350 mg MCC tablets.

The effect of moisture content on tableting was also investigated on commercial spray dried rice starch (Eratab<sup>®</sup>). Three levels of Eratab<sup>®</sup> moisture content chosen for compressed tablets making were 7.24 %, 10.88 % and 16.60%.

In general, an increase of Eratab<sup>®</sup> tablets hardness with increased compression force was shown. However, there was some influence from moisture content level. The hardness of the Eratab<sup>®</sup> 500 mg tablets with 10.88 % moisture content, compressed at the force of 1.5 metric ton was insignificantly lower than that of Eratab<sup>®</sup> tablets with 7.24 % moisture content ( $p > 0.05$ ) and significantly higher than that of Eratab<sup>®</sup> tablets with 16.60 % water content ( $p < 0.05$ ). On the other hand, other Eratab<sup>®</sup> tablets hardness of 7.24 % moisture content compressed with 1 metric ton pressure was significantly lower than that of 10.88 % moisture content and higher than that of 16.60% water content ( $p < 0.05$ ). Moreover, at 2 metric ton pressure the Eratab<sup>®</sup> tablet with 7.24 % moisture contents had the highest hardness, when compared with 10.88 % and 16.60% moisture contents ( $p < 0.05$ ).

The Eratab<sup>®</sup> 350 mg tablets hardness compressed at the force of 1 metric ton with 7.24 % moisture content was significantly lower than that of 10.88 % moisture content but higher than 16.60% moisture content ( $p < 0.05$ ). Moreover, the hardness of 350 mg Eratab<sup>®</sup> tablets with 7.24 % moisture content compressed at the force of 1.5 and 2 metric ton was not significantly different from the tablet with 10.88 % ( $p > 0.05$ ), while the hardness of Eratab<sup>®</sup> tablets with 16.60 % moisture contents was significantly lower than the others ( $p < 0.05$ ).

Zografi and Kontny (1986) suggested that the tablet strength of starch relied on their moisture content and maximum tablet strength of various starches were attained at 60-70% relative humidity which provided the equilibrium moisture content of all starch was about 10% w/w. In this experiment at 10.88% moisture content the hardness of Eratab<sup>®</sup> tablets was shown to be higher than other moisture contents when compression force of 1 metric ton was applied.

The thickness of 500 mg Eratab<sup>®</sup> tablets was between 2.15 to 3.05 mm and their diameters were in the range of 12.08 to 13.03 mm. For 350 mg tablets, the tablet thickness ranged from 3.59 to 3.88 mm and the diameter was from 9.32 to 9.57 mm in diameter.

Table 4-17 Physical properties of 500 mg tablets of commercial spray dried rice starch (Eratab<sup>®</sup>) containing different moisture contents, average (SD).

| <b>Moisture content (%)</b> | <b>Pressure (Metric ton)</b> | <b>Hardness (N) n =10</b> | <b>Thickness (mm) n =10</b> | <b>Diameter (mm) n =10</b> | <b>Friability (%)</b> | <b>DT (min)</b> |
|-----------------------------|------------------------------|---------------------------|-----------------------------|----------------------------|-----------------------|-----------------|
| 7.24                        | 1                            | 172.21<br>(14.19)         | 2.15<br>(0.10)              | 12.08<br>(0.07)            | 1.19                  | 2.51            |
|                             | 1.5                          | 234.92<br>(0.29)          | 2.68<br>(0.29)              | 12.69<br>(0.29)            | 0.70                  | 3.00            |
|                             | 2                            | 296.68<br>(8.44)          | 2.89<br>(0.04)              | 13.01<br>(0.05)            | 1.57                  | 3.10            |
| 10.88                       | 1                            | 190.24<br>(12.83)         | 2.59<br>(0.06)              | 12.56<br>(0.01)            | 1.67                  | 2.24            |
|                             | 1.5                          | 222.29<br>(22.79)         | 2.39<br>(0.06)              | 12.53<br>(0.01)            | 3.42                  | 2.48            |
|                             | 2                            | 267.93<br>(13.44)         | 2.40<br>(0.04)              | 12.56<br>(0.01)            | 1.10                  | 2.08            |
| 16.60                       | 1                            | 92.16<br>(11.22)          | 3.00<br>(0.09)              | 13.03<br>(0.03)            | 2.88                  | 2.02            |
|                             | 1.5                          | 90.50<br>(7.70)           | 3.05<br>(0.07)              | 13.02<br>(0.04)            | 2.84                  | 2.05            |
|                             | 2                            | 91.11<br>(11.31)          | 3.01<br>(0.08)              | 13.02<br>(0.03)            | 1.72                  | 1.48            |

Table 4-18 Physical properties of 350 mg tablets of commercial spray dried rice starch (Eratab<sup>®</sup>) containing different moisture contents, average (SD).

| <b>Moisture content (%)</b> | <b>Pressure (Metric ton)</b> | <b>Hardness (N) n =10</b> | <b>Thickness (mm) n =10</b> | <b>Diameter (mm) n =10</b> | <b>Friability (%)</b> | <b>DT (min)</b> |
|-----------------------------|------------------------------|---------------------------|-----------------------------|----------------------------|-----------------------|-----------------|
| 7.24                        | 1                            | 183.02<br>(19.16)         | 3.70<br>(0.06)              | 9.33<br>(0.01)             | 0.07                  | 3.06            |
|                             | 1.5                          | 224.71<br>(19.56)         | 3.88<br>(0.05)              | 9.54<br>(0.01)             | 0.22                  | 3.16            |
|                             | 2                            | 221.18<br>(8.64)          | 3.69<br>(0.08)              | 9.40<br>(0.07)             | 0.34                  | 4.31            |
| 10.88                       | 1                            | 218.22<br>(20.08)         | 3.70<br>(0.05)              | 9.42<br>(0.06)             | 0.42                  | 2.51            |
|                             | 1.5                          | 215.72<br>(12.00)         | 3.59<br>(0.05)              | 9.32<br>(0.02)             | 0.78                  | 5.18            |
|                             | 2                            | 223.71<br>(17.85)         | 3.66<br>(0.01)              | 9.41<br>(0.06)             | 0.12                  | 6.56            |
| 16.60                       | 1                            | 141.07<br>(14.44)         | 3.77<br>(0.16)              | 9.44<br>(0.16)             | 3.62                  | 1.59            |
|                             | 1.5                          | 151.04<br>(14.01)         | 3.81<br>(0.08)              | 9.57<br>(0.08)             | 2.72                  | 3.50            |
|                             | 2                            | 126.93<br>(21.00)         | 3.77<br>(0.09)              | 9.35<br>(0.03)             | 2.00                  | 1.57            |



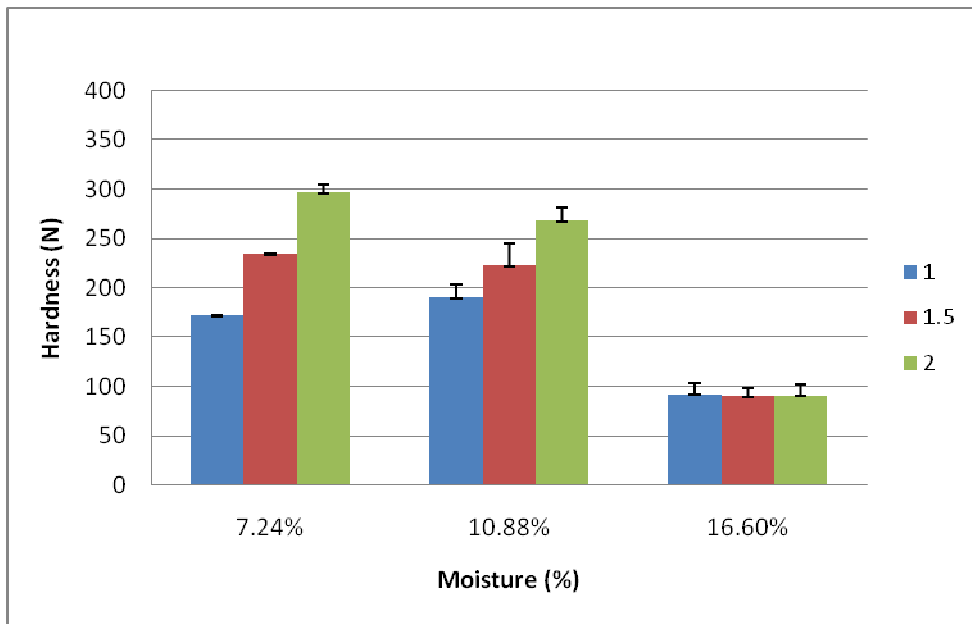

Figure 4-31 Relationship between moisture content and hardness of 500 mg Eratab<sup>®</sup> tablets

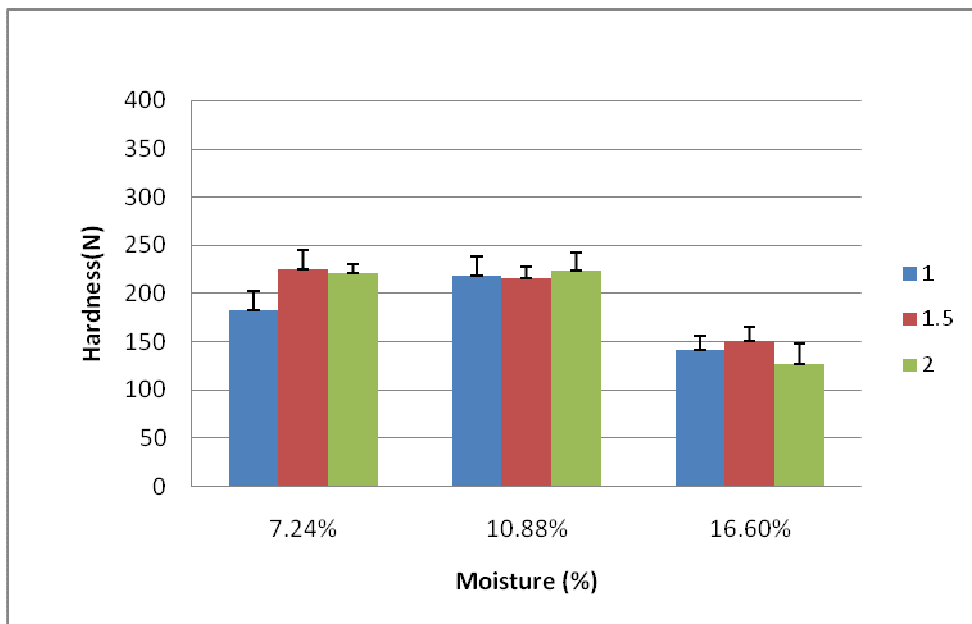

Figure 4-32 Relationship between moisture content and hardness of 350 mg Eratab<sup>®</sup> tablets.

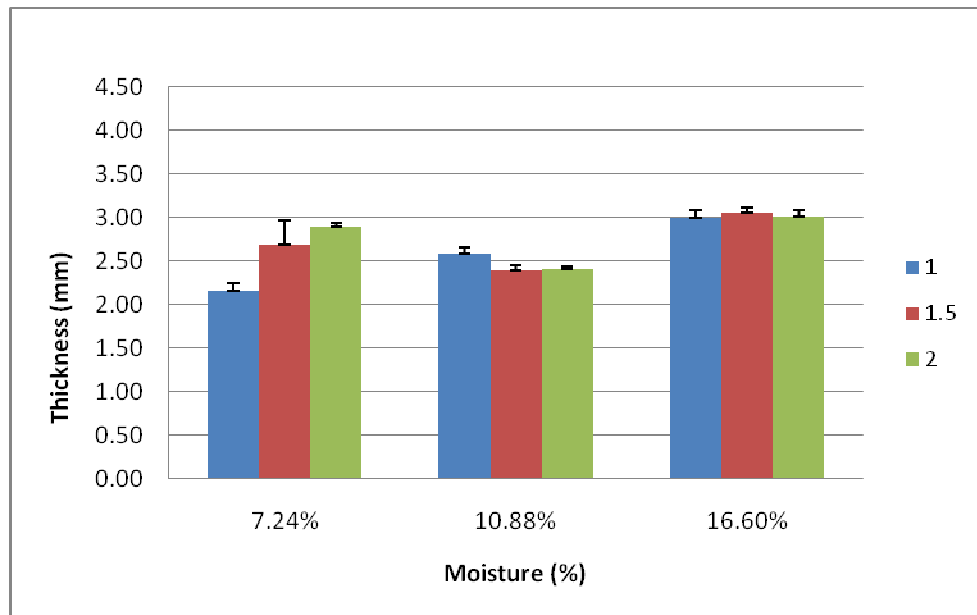

Figure 4-33 Relationship between moisture content and thickness of 500 mg Eratab® tablets.

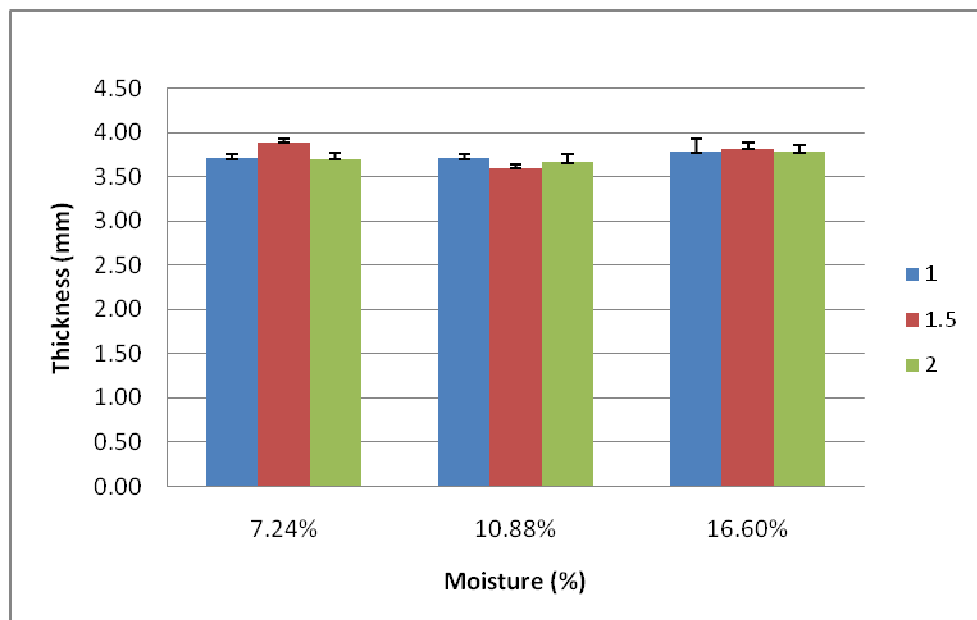

Figure 4-34 Relationship between moisture content and thickness of 350 mg Eratab® tablets.

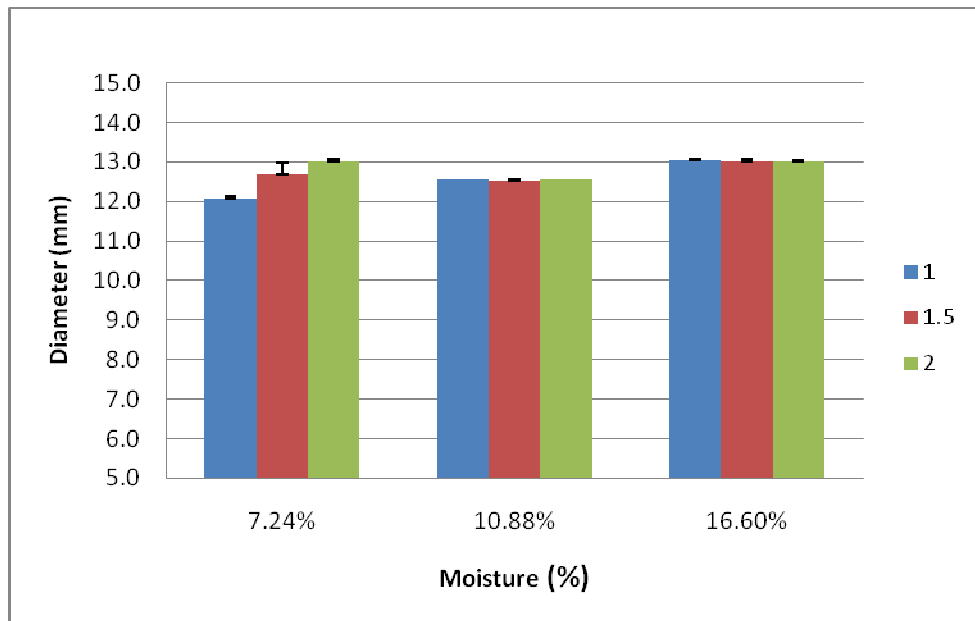

Figure 4-35 Relationship between moisture content and diameter of 500 mg Eratab<sup>®</sup> tablets.

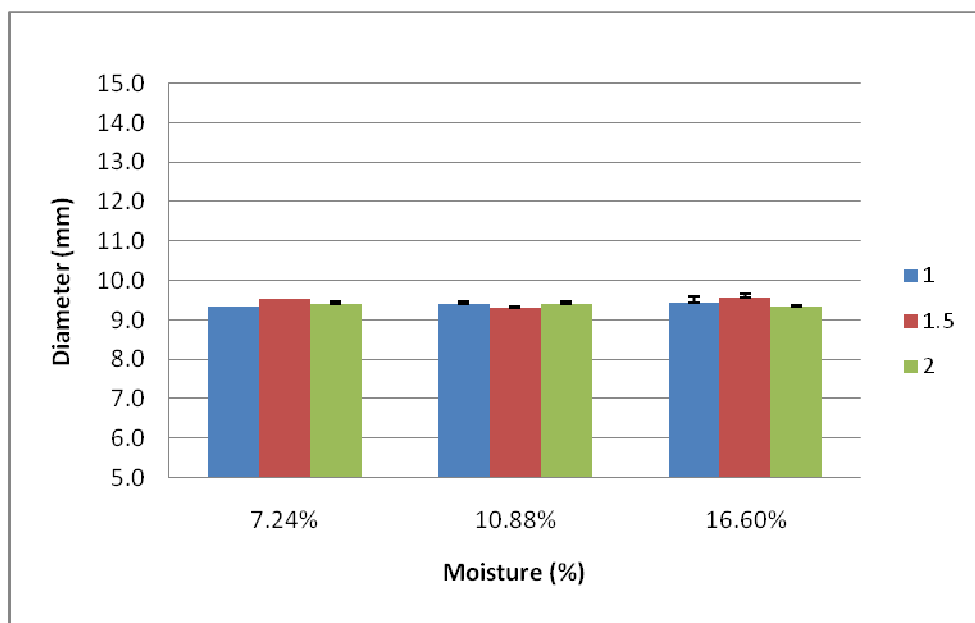

Figure 4-36 Relationship between moisture content and diameter of 350 mg Eratab<sup>®</sup> tablets.

Percent friability of 500 mg tablets, which were prepared from Eratab<sup>®</sup> were between 0.07% and 3.62% while for 350 mg tablets, percent friability were between 0.70 % and 3.42 %. The Eratab<sup>®</sup> tablets tended to be friable than RS:MCC tablets which corresponded to their hardness which were generally lower, particularly at moisture content of approximately 10% in 500 mg tablets as well as at 7% and 10% in 350 mg tablets. Disintegration time (DT) of 500 mg and 350 mg Eratab<sup>®</sup> tablets which contained varying water contents were not much difference.

### **3.3 Effect of particle size of composite powders**

The effect of particle size of composite particles on the tablet hardness was shown depending on compression force. The hardness of RS:MCC 500 mg tablets using composite particles with particle size smaller than 45  $\mu\text{m}$ , 75  $\mu\text{m}$  and 150  $\mu\text{m}$ , compressed at 1 metric ton was significantly different ( $p < 0.05$ ). The smaller particle size gave harder tablets, perhaps due to more surface area of smaller sized particles for close contact and forming bridges. When compressed at 1.5 metric ton using composite particles of particle size smaller than 45  $\mu\text{m}$ , the tablet hardness was significantly lower than the tablet hardness of composite particles which had particle size smaller than 150  $\mu\text{m}$  ( $p < 0.05$ ); while there was no significant difference between the tablet hardness of 45  $\mu\text{m}$  composite particles and that of 75  $\mu\text{m}$  composite particles. The higher compression forces might cause random fragmentation of the composite particles and make new surfaces. Therefore, at 2 metric ton, there was no significant difference between the tablet hardness of 45  $\mu\text{m}$  and 150  $\mu\text{m}$  composite particles ( $p > 0.05$ ).

On the other hands, the effect of particle size of composite particles on hardness of 350 mg tablets was observed for relatively higher compression forces. There was significance difference in tablet hardness when using 75  $\mu\text{m}$  and 150  $\mu\text{m}$  composite particles compressed at 1.5 metric ton, and when as using 45  $\mu\text{m}$  and 75  $\mu\text{m}$  composite particles compressed at 2 metric ton.

This study aimed to examine the effect of the particle size on physical properties of tablets. The hardness of tablet in general not only depends on the particle size, but also relies on plastic flow degree and particle fragmentation. Particle size

effect during tableting was not observed for material high fragmentation, e.g. dibasic calcium phosphate (Albers, Knop and Kleinebudde, 2006). Overall, there were no significant correlations between particle size and hardness in this study.

Percent friability of 500 mg and 350 tablets, derived from RS:MCC which contained difference particle size were in the acceptable range which was less than 1% as shown in Table 4-19 to 4-20. The size of composite particles did not affect the disintegration time (DT) of RS:MCC tablets as their values were between 0.17 to 1.34 minutes, regardless of tablet size.

Table 4-19 Physical properties of 500 mg RS:MCC tablets using RS: MCC composite particles passed through mesh size of 45  $\mu\text{m}$ , 75  $\mu\text{m}$  and 150  $\mu\text{m}$ , average (SD)

| <b>Material</b>               | <b>Pressure<br/>(Metric<br/>ton)</b> | <b>Hardness<br/>(N)<br/>(n=10)</b> | <b>Thickness<br/>(mm)<br/>(n=10)</b> | <b>Diameter<br/>(mm)<br/>(n=10)</b> | <b>Friability<br/>(%)</b> | <b>DT<br/>(min)</b> |
|-------------------------------|--------------------------------------|------------------------------------|--------------------------------------|-------------------------------------|---------------------------|---------------------|
| RS:MCC,<br>45 <sup>*(a)</sup> | 1                                    | 297.91<br>(11.04)                  | 3.05<br>(0.04)                       | 13.08<br>(0.01)                     | 0.15                      | 0.43                |
|                               | 1.5                                  | 308.13<br>(5.35)                   | 3.01<br>(0.05)                       | 13.05<br>(0.01)                     | 0.14                      | 0.54                |
|                               | 2                                    | 313.38<br>(6.35)                   | 2.88<br>(0.03)                       | 13.04<br>(0.01)                     | 0.11                      | 1.34                |
| RS:MCC,<br>75*                | 1                                    | 284.19<br>(8.78)                   | 3.15<br>(0.02)                       | 13.06<br>(0.00)                     | 0.01                      | 0.36                |
|                               | 1.5                                  | 311.18<br>(6.87)                   | 2.90<br>(0.02)                       | 13.02<br>(0.03)                     | 0.01                      | 0.41                |
|                               | 2                                    | 319.75<br>(3.71)                   | 2.88<br>(0.03)                       | 13.04<br>(0.01)                     | 0.02                      | 0.45                |
| RS:MCC,<br>150*               | 1                                    | 268.36<br>(11.81)                  | 2.82<br>(0.03)                       | 12.97<br>(0.01)                     | 0.15                      | 0.17                |
|                               | 1.5                                  | 317.25<br>(4.68)                   | 2.82<br>(0.03)                       | 13.04<br>(0.01)                     | 0.06                      | 0.26                |
|                               | 2                                    | 310.77<br>(7.55)                   | 2.87<br>(0.08)                       | 13.05<br>(0.01)                     | 0.07                      | 0.27                |

\*mesh width ( $\mu\text{m}$ )

<sup>(a)</sup> or RS:MCC, (CJM) in Table 4-21

Table 4-20 Physical properties of 350 mg RS:MCC tablets using RS: MCC composite particles passed through mesh size of 45  $\mu\text{m}$ , 75  $\mu\text{m}$  and 150  $\mu\text{m}$ , average (SD)

| <b>Material</b>               | <b>Pressure<br/>(Metric<br/>ton)</b> | <b>Hardness<br/>(N)<br/>(n =10)</b> | <b>Thickness<br/>(mm)<br/>(n =10)</b> | <b>Diameter<br/>(mm)<br/>(n =10)</b> | <b>Friability<br/>(%)</b> | <b>DT<br/>(min)</b> |
|-------------------------------|--------------------------------------|-------------------------------------|---------------------------------------|--------------------------------------|---------------------------|---------------------|
| RS:MCC,<br>45 <sup>*(a)</sup> | 1                                    | 317.53<br>(6.06)                    | 3.74<br>(0.05)                        | 9.53<br>(0.01)                       | 0.06                      | 1.28                |
|                               | 1.5                                  | 324.49<br>(5.81)                    | 3.73<br>(0.04)                        | 9.53<br>(0.01)                       | 0.04                      | 1.34                |
|                               | 2                                    | 322.79<br>(7.94)                    | 3.69<br>(0.04)                        | 9.53<br>(0.01)                       | 0.10                      | 1.23                |
| RS:MCC,<br>75*                | 1                                    | 323.87<br>(7.17)                    | 3.68<br>(0.06)                        | 9.53<br>(0.00)                       | 0.03                      | 0.45                |
|                               | 1.5                                  | 331.01<br>(7.56)                    | 3.67<br>(0.05)                        | 9.53<br>(0.01)                       | 0.01                      | 0.51                |
|                               | 2                                    | 333.66<br>(6.58)                    | 3.66<br>(0.05)                        | 9.53<br>(0.01)                       | 0.04                      | 0.59                |
| RS:MCC,<br>150*               | 1                                    | 318.98<br>(6.23)                    | 3.69<br>(0.05)                        | 9.53<br>(0.00)                       | 0.01                      | 0.31                |
|                               | 1.5                                  | 319.39<br>(8.57)                    | 3.69<br>(0.05)                        | 9.52<br>(0.02)                       | 0.08                      | 0.37                |
|                               | 2                                    | 328.14<br>(7.52)                    | 3.63<br>(0.06)                        | 9.50<br>(0.01)                       | 0.07                      | 0.44                |

\*mesh width ( $\mu\text{m}$ )

<sup>(a)</sup> or RS:MCC, (CJM) in Table 4-22

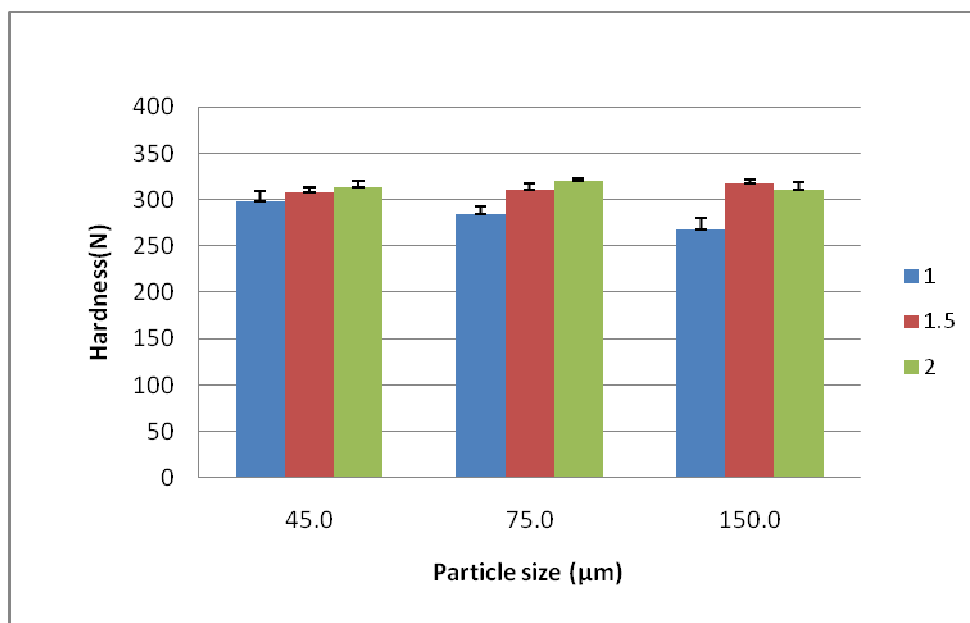

Figure 4-37 Relationship between particle size and hardness of 500 mg RS:MCC tablets using RS: MCC composite particles passed through mesh size of 45  $\mu\text{m}$ , 75  $\mu\text{m}$  and 150  $\mu\text{m}$

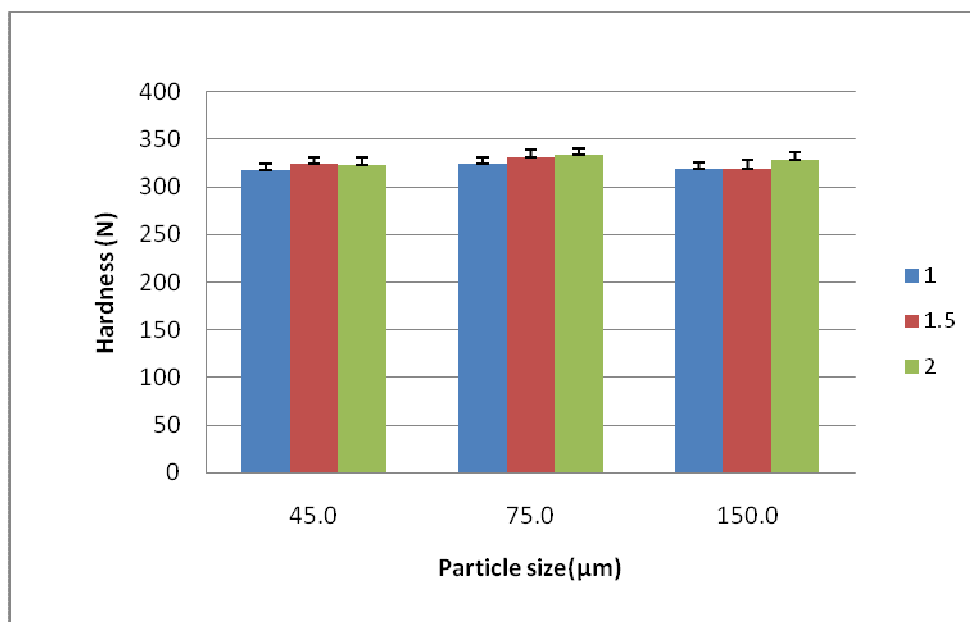

Figure 4-38 Relationship between particle size and hardness of 350 mg RS:MCC tablets using RS: MCC composite particles passed through mesh size of 45  $\mu\text{m}$ , 75  $\mu\text{m}$  and 150  $\mu\text{m}$

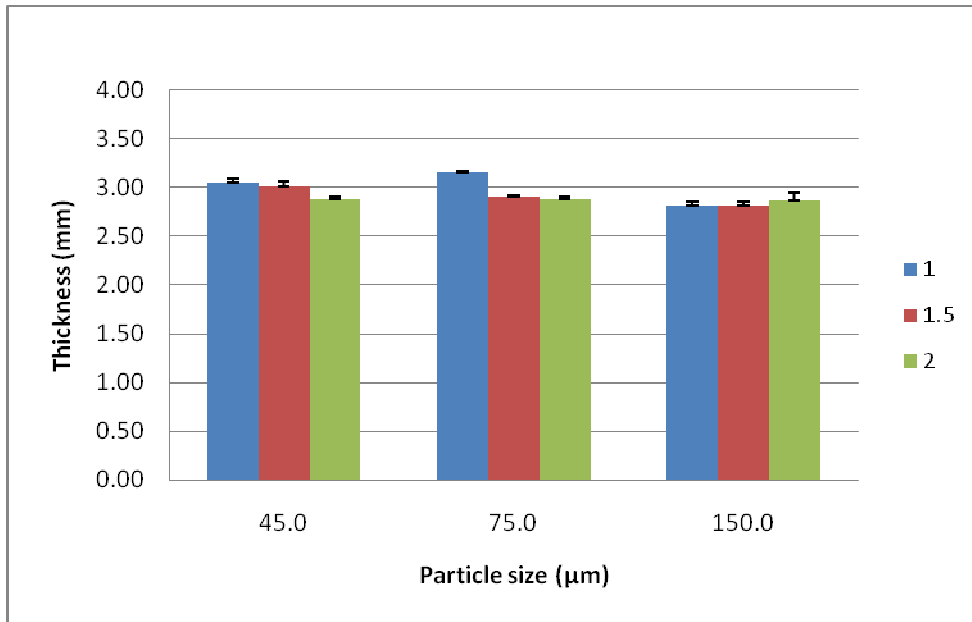

Figure 4-39 Relationship between particle size and thickness of 500 mg RS:MCC tablets using RS: MCC composite particles passed through mesh size of 45  $\mu\text{m}$ , 75  $\mu\text{m}$  and 150  $\mu\text{m}$

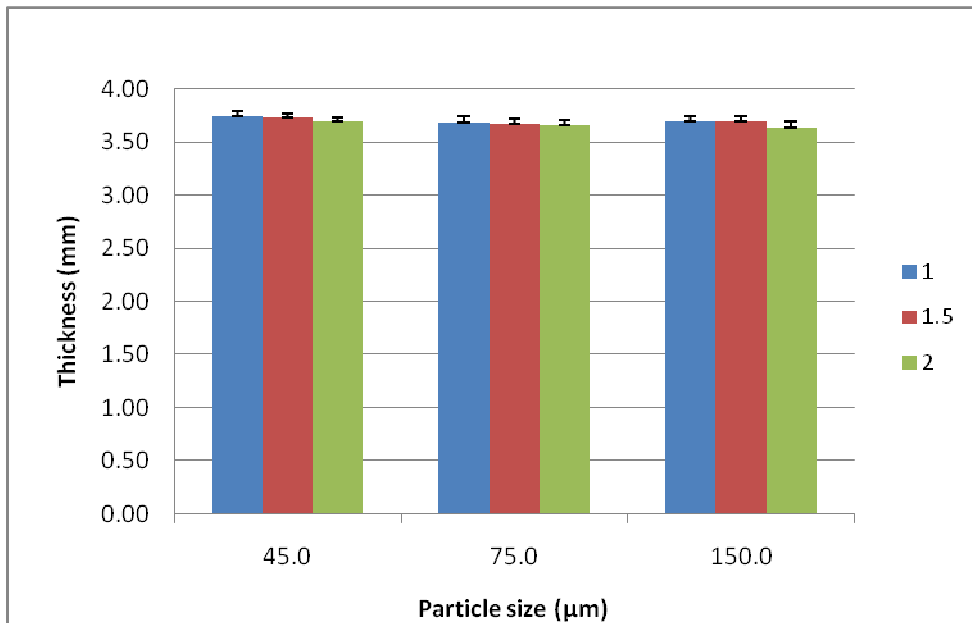

Figure 4-40 Relationship between particle size and thickness of 350 mg RS:MCC tablets using RS: MCC composite particles passed through mesh size of 45  $\mu\text{m}$ , 75  $\mu\text{m}$  and 150  $\mu\text{m}$



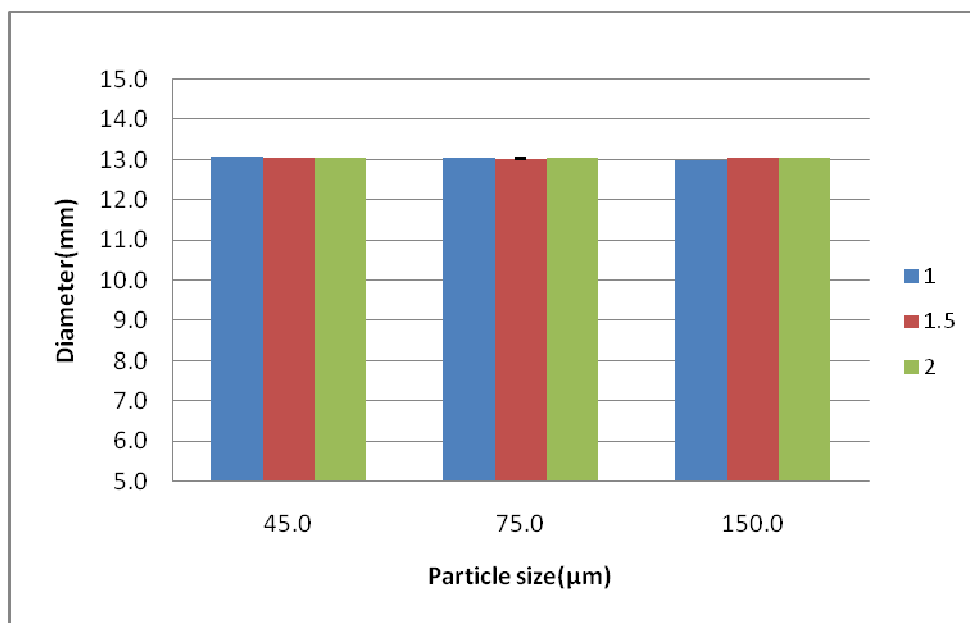

Figure 4-41 Relationship between particle size and diameter of 500 mg RS:MCC tablets using RS: MCC composite particles passed through mesh size of 45  $\mu\text{m}$ , 75  $\mu\text{m}$  and 150  $\mu\text{m}$

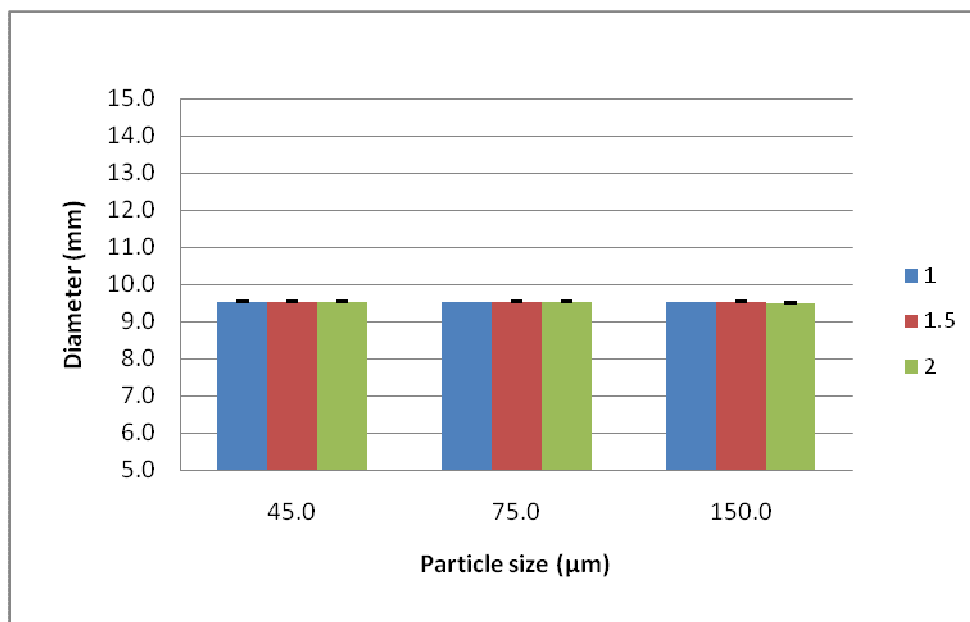

Figure 4-42 Relationship between particle size and diameter of 350 mg RS:MCC tablets using RS: MCC composite particles passed through mesh size of 45  $\mu\text{m}$ , 75  $\mu\text{m}$  and 150  $\mu\text{m}$

### 3.4 Effect of particle shape of composite powders

Particle shape of composite powders was unlikely to affect the hardness of 500 mg tablets. However, particle shape of RS:MCC composite particles especially affected on the hardness of 350 mg tablet when compressed with lower force as 1 and 1.5 metric tons. RS:MCC tablets using CJM of spherical shape was harder than those using CS of “rugby ball” shape as the starting material as shown in Table 4-21 to 4-22. CJM tablets were harder than CS tablets ( $p < 0.05$ ). The tablets thickness of 500 mg RS:MCC (CS) and RS:MCC (CJM) ranged from 2.79 to 3.05 mm and their diameter was in the range of 12.99 to 13.08 mm. The tablets thickness of 350 mg RS:MCC (CS) and RS:MCC (CJM) ranged from 3.62 to 3.74 mm and their diameter was in the range of 9.51 to 9.53 mm.

% Friability of RS:MCC(CS) and RS:MCC(CJM) tablets of both size which was in the acceptable range that was less than 1%. On the other hand, DT of 350 mg tablets compressed from CJM was longer than those from CS. It was due to RS:MCC (CS) had more CE diameter and surface area than RS:MCC (CJM). The values of DT were between 0.35 to 1.34 minutes.

Table 4-21 Physical properties of 500 mg RS:MCC tablets containing MCC passed through a sieve number 45 having an opening aperture of 355  $\mu\text{m}$  (CS), or MCC that the size was reduced by jet mill (CJM); average (SD)

| Material                     | Pressure<br>(Metric<br>ton) | Hardness<br>(N)<br>(n =10) | Thickness<br>(mm)<br>(n =10) | Diameter<br>(mm)<br>(n =10) | Friability<br>(%) | DT<br>(min) |
|------------------------------|-----------------------------|----------------------------|------------------------------|-----------------------------|-------------------|-------------|
| RS:MCC<br>(CS)               | 1                           | 288.54<br>(15.71)          | 2.84<br>(0.08)               | 12.99<br>(0.04)             | 0.12              | 0.35        |
|                              | 1.5                         | 310.58<br>(7.99)           | 2.85<br>(0.07)               | 13.01<br>(0.01)             | 0.13              | 0.40        |
|                              | 2                           | 314.65<br>(5.61)           | 2.79<br>(0.06)               | 13.03<br>(0.01)             | 0.06              | 0.40        |
| RS:MCC<br>(CJM) <sup>a</sup> | 1                           | 297.91<br>(11.04)          | 3.05<br>(0.04)               | 13.08<br>(0.01)             | 0.15              | 0.43        |
|                              | 1.5                         | 308.13<br>(5.35)           | 3.01<br>(0.05)               | 13.05<br>(0.01)             | 0.14              | 0.54        |
|                              | 2                           | 313.38<br>(6.35)           | 2.88<br>(0.03)               | 13.04<br>(0.01)             | 0.11              | 1.34        |

<sup>a</sup> or RS:MCC, 45\* in Table 4-19

Table 4-22 Physical properties of 350 mg RS:MCC tablets containing MCC passed through a sieve number 45 having an opening aperture of 355  $\mu\text{m}$  (CS), or MCC that the size was reduced by jet mill (CJM); average (SD)

| Material                     | Pressure<br>(Metric<br>ton) | Hardness<br>(N)<br>(n =10) | Thickness<br>(mm)<br>(n =10) | Diameter<br>(mm)<br>(n =10) | Friability<br>(%) | DT<br>(min) |
|------------------------------|-----------------------------|----------------------------|------------------------------|-----------------------------|-------------------|-------------|
| RS:MCC<br>(CS)               | 1                           | 298.79<br>(15.32)          | 3.69<br>(0.07)               | 9.52<br>(0.01)              | 0.15              | 0.51        |
|                              | 1.5                         | 315.59<br>(7.98)           | 3.62<br>(0.06)               | 9.51<br>(0.02)              | 0.02              | 0.55        |
|                              | 2                           | 323.97<br>(6.29)           | 3.64<br>(0.05)               | 9.52<br>(0.02)              | 0.22              | 0.56        |
| RS:MCC<br>(CJM) <sup>a</sup> | 1                           | 317.53<br>(6.06)           | 3.74<br>(0.05)               | 9.53<br>(0.01)              | 0.06              | 1.28        |
|                              | 1.5                         | 324.49<br>(5.81)           | 3.73<br>(0.04)               | 9.53<br>(0.01)              | 0.04              | 1.34        |
|                              | 2                           | 322.79<br>(7.94)           | 3.69<br>(0.04)               | 9.53<br>(0.01)              | 0.10              | 1.23        |

<sup>a</sup> or RS:MCC, 45\* in Table 4-20

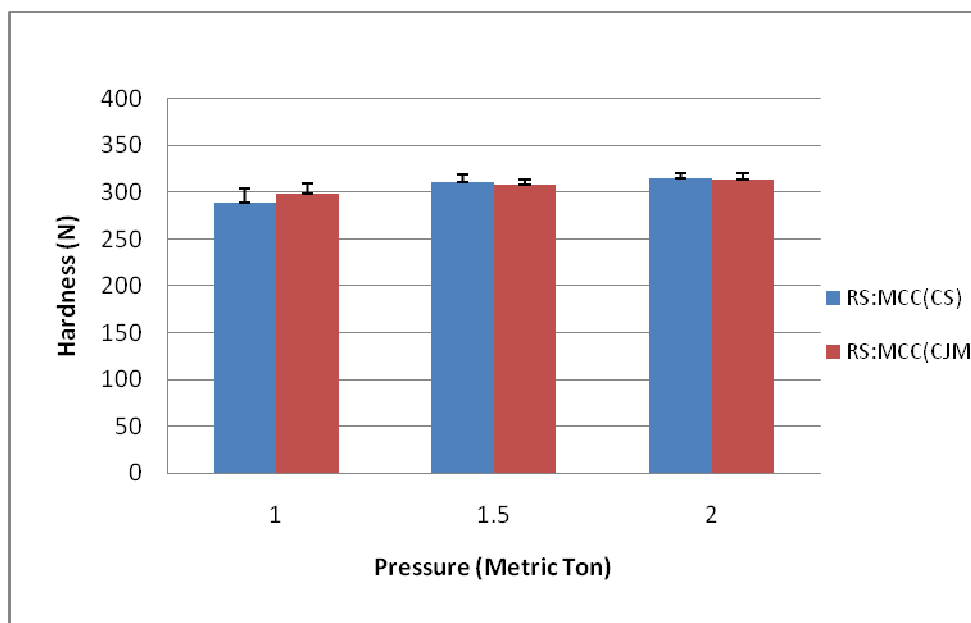

Figure 4-43 Relationship between particle shape and hardness of 500 mg RS:MCC tablets containing MCC passed through a sieve number 45 having an opening aperture of 355  $\mu\text{m}$  (CS), or MCC that the size was reduced by jet mill (CJM)

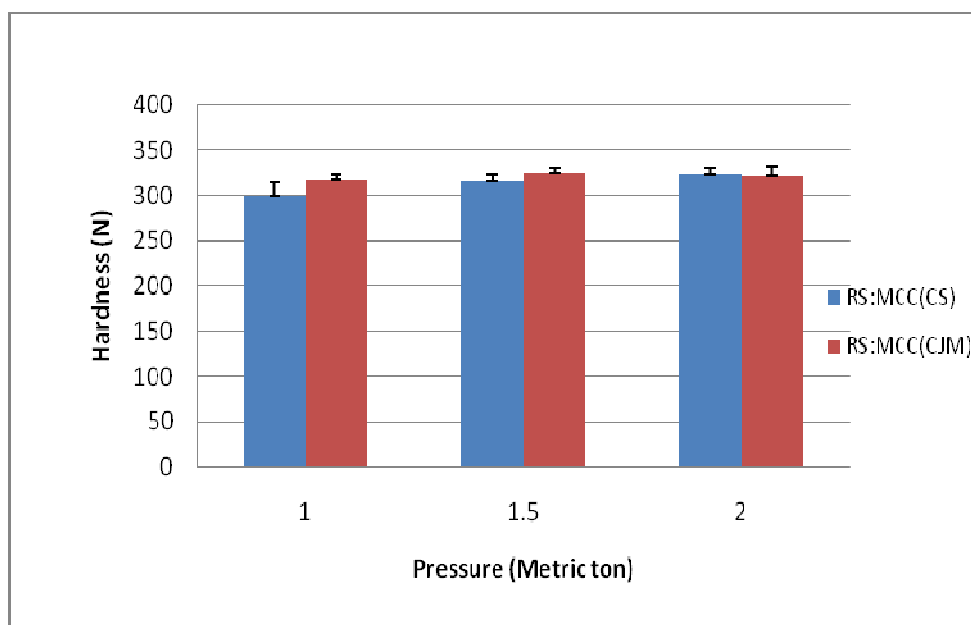

Figure 4-44 Relationship between particle shape and hardness of 350 mg RS:MCC tablets containing MCC passed through a sieve number 45 having an opening aperture of 355  $\mu\text{m}$  (CS), or MCC that the size was reduced by jet mill (CJM)

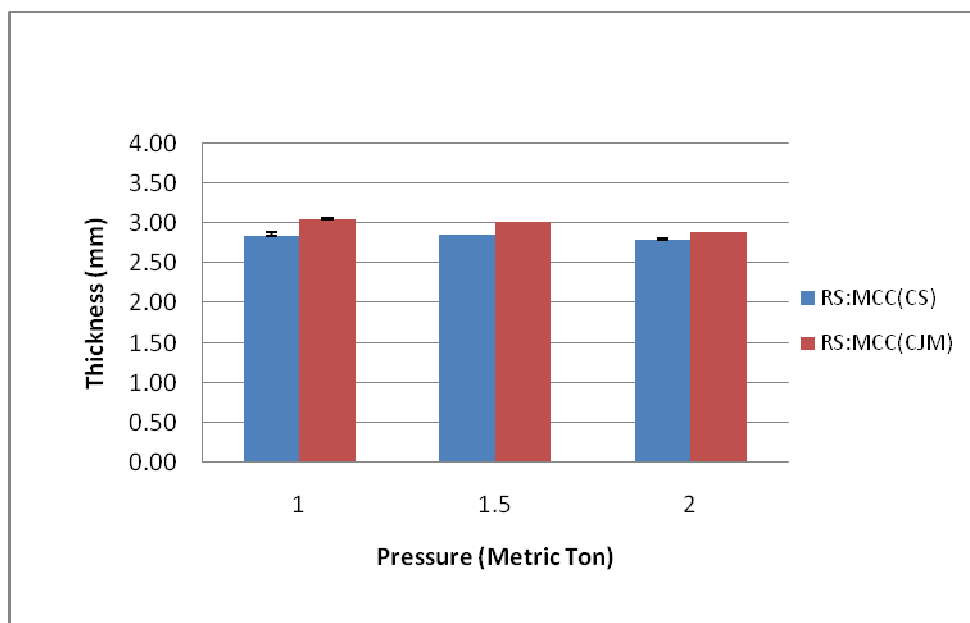

Figure 4-45 Relationship between moisture content and thickness of 500 mg RS:MCC tablets containing MCC passed through a sieve number 45 having an opening aperture of 355  $\mu\text{m}$  (CS), or MCC that the size was reduced by jet mill (CJM)

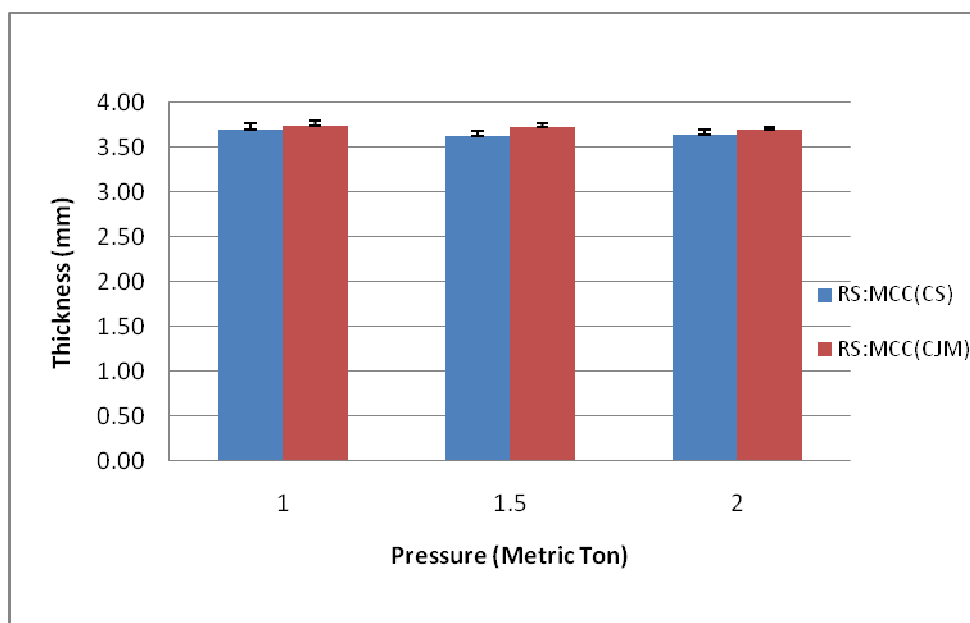

Figure 4-46 Relationship between particle shape and thickness of 350 mg RS:MCC tablets containing MCC passed through a sieve number 45 having an opening aperture of 355  $\mu\text{m}$  (CS), or MCC that the size was reduced by jet mill (CJM)

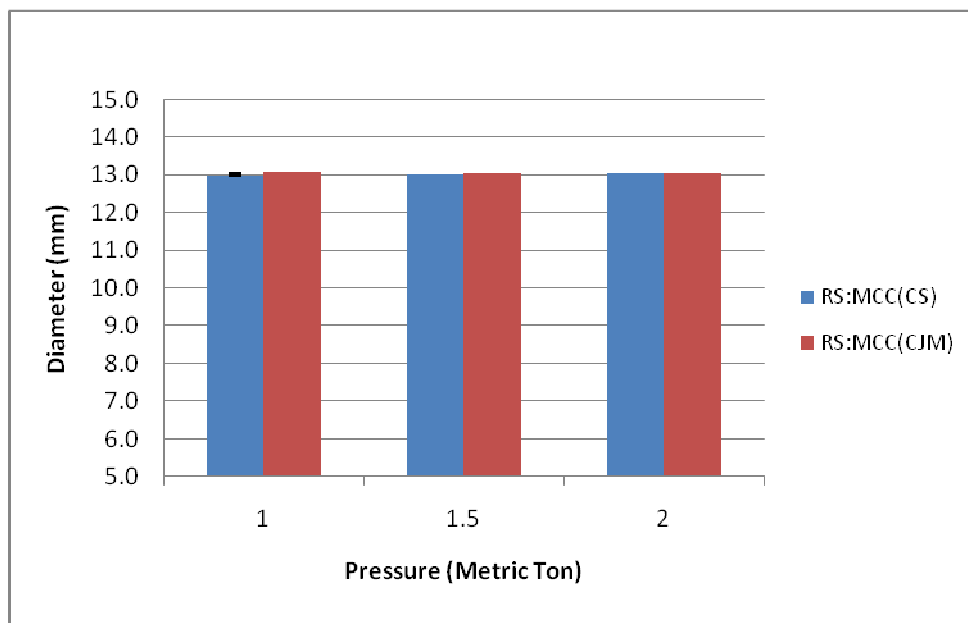

Figure 4-47 Relationship between moisture content and diameter of 500 mg RS:MCC tablets containing MCC passed through a sieve number 45 having an opening aperture of 355  $\mu\text{m}$  (CS), or MCC that the size was reduced by jet mill (CJM)

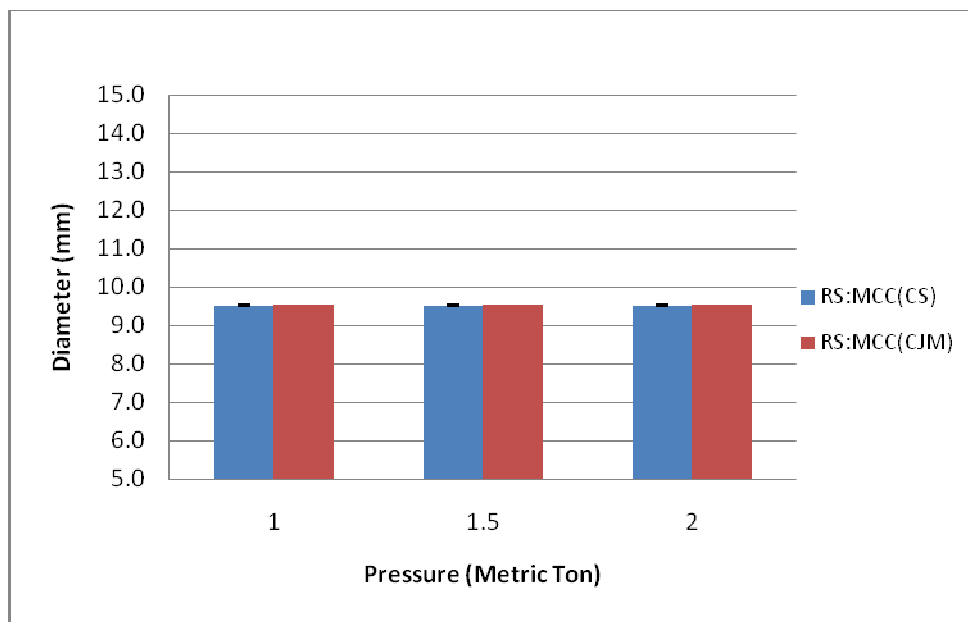

Figure 4-48 Relationship between particle shape and diameter of 350 mg RS:MCC tablets containing MCC passed through a sieve number 45 having an opening aperture of 355  $\mu\text{m}$  (CS), or MCC that the size was reduced by jet mill (CJM)

## CHAPTER V

### CONCLUSIONS

MCC from two sources, CEOLUS<sup>®</sup> pH 101 (Japan) and COMPRECEL<sup>®</sup> (Taiwan) which particle size was reduced by jet mill to produce spray dried composites particle of RS and MCC showed similar flowability index but hardness of the tablets composed of CEOLUS<sup>®</sup> PH 101 (Japan) was higher than those comprising COMPRECEL<sup>®</sup> (Taiwan).

Moisture content of RS:MCC composites particle had effects on tableting properties. The effect of moisture content on tablet hardness may be interacted with levels of compression force and dependent on tablet weight. Also, there seemed to be optimum moisture content for compression of tablet with good hardness. Tablet hardness was dramatically decreased and capping of tablets was found at the moisture content of 15-16%. Comparing with commercial spray dried rice starch without MCC (Eratab<sup>®</sup>), the Eratab<sup>®</sup> tablets were likely to be more friable than RS:MCC tablets with the moisture content of approximately 10%.

The effect of difference particle size of RS:MCC composites particle apparently on tableting properties was unclear. Perhaps, the range of particle size of RS:MCC composite particles chosen for the study was inappropriate.

Particle shape of RS:MCC composite particles especially affected on the hardness of 350 mg tablet when compressed with lower force as 1 and 1.5 metric tons. Tablets made from spherical shape RS:MCC (using CJM as starting materials) was harder than those of made from “rugby ball” shape RS:MCC (using CS as starting materials).

## REFERENCES

- Abdullah, E.C., Geldart, D. The use of bulk density measurements as flowability indicators. Powder Technology 102 (1999): 151–165.
- Albers, J., Knop, K. and Kleinebudde, P. Brand-to-brand and batch-to-batch uniformity of microcrystalline cellulose in direct tableting with a pneumohydraulic tablet press. Pharmaceutical Industrials. 68(12) (2006): 1420-1428.
- Balkose, D., Ulutan, S., Ozkan F., C., Celebi, S., Ulku, S., Dynamics of water vapor adsorption on humidity-indicating silica gel. Applied Surface Science 134 (1998): 39–46.
- Bhimte, N.A. and Tayade, P.T. Evaluation of microcrystalline cellulose prepared from sisal fibers as a tablet excipient: A Technical Note. AAPS PharmSciTech 8(1) (2007): Article 8.
- Bolhuis, G.K., and Armstrong, N.A. Excipients for direct compaction an update., Pharmaceutical Development Technology 11(1), (2006): 111-124.
- Bolhuis, G.K., Materials for direct compaction. In: Alderborn, G. and Nystrom, C., eds. Pharmaceutical Powder Compaction Technology (1996): 419-478. New York : Marcel Dekker Inc.
- Bos, C.E., Bolhuis, G.K., Lerk, C.F. and Duineveld, C.A.A. Evaluation of modified rice starch, a new excipient for direct compression. Drug Development and Industrial Pharmacy 18(1), (1992): 93-106.



- Callahan, J.C., Cleary, G.W. and Elefant, M. Equilibrium moisture content of pharmaceutical excipients. Drug Development and Industrial Pharmacy 8 (1982): 355–369.
- Carr, R.L. Evaluating flow properties of solids. Chemical Engineering 28 (1965): 163-168.
- Fua X., Huckb D., Makeinb L., Armstronga B., Willen U. and Freeman T., Effect of particle shape and size on flow properties of lactose powders, Particuology 10 (2012): 203– 208.
- Gohel, M.C., Jogani P.D., A review of co-processed directly compressible excipients. Journal of Pharmaceutical Sciences, 8(1) (2005): 76-93.
- Hauschild, K. and Picker, K.M. Evaluation of a new coprocessed compound based on lactose and maize starch for tablet formulation. AAPS PharmSciTech 6(2) (2004): Article 16.
- Hsu, S., Tsai, T., Chuo, W. and Cham, T. Evaluation of era-tab as a direct compression excipient. Drug Development and Industrial Pharmacy 23(7), (1997): 711-716.
- Hsu, S.H., Tsai, T.R., Chuo, W.H. and Cham, T.M. Evaluation of Eratab<sup>®</sup> as a direct compression excipient. Drug Development and Industrial Pharmacy 23(7) (1997): 711-716.
- <http://what-when-how.com/energy-engineering/drying-operations-industrial-energy-engineering/26/04/12>.
- <http://sy.zlgc.org/Upload/20080523215352884.pdf/26/04/12>.
- <http://www.nrel.gov/biomass/glossary.html/27/04/12>.

- Khan, K.A., Musikabhumma, P., and Warr, J.P. The effect of moisture content of microcrystalline cellulose on the compressional properties of some formulations. Drug Development and Industrial Pharmacy 7(5) (1981): 525-538.
- Kim Huynh-Ba, Karl Fischer Titration, Handbook of Stability Testing in Pharmaceutical Development: Regulations, Methodologies, and best practices. (Springer Science Business Media, LLC, 2009), 209.
- Kuu, W., Chilamkurti, R. and Chen, Chi. Effect of relative humidity and temperature on moisture sorption and stability of sodium bicarbonate powder. International Journal of Pharmaceutics 166, (1998): 167–175.
- Landin, M., Martinez-Pacheco, R., Gomez-Amoza, J.L., Souto, C., Concheiro, A., and Rowe, R.C. Influence of microcrystalline cellulose source and batch variation on the tableting behavior and stability of prednisolone formulations. International Journal of Pharmaceutics 91 (1993): 143-149.
- Lee, Y.S.L., Poynter, R., Podczeck, F. and Newton, J.M. Development of a dual approach to assess powder flow from avalanching behaviour. AAPS PharmSciTech 1(3) (2000): Article 21.
- Limwong, V., Sutanthavibul, N. and Kulvanich, P. Spherical composite particles of rice starch and microcrystalline cellulose: a new coprocessed excipient for direct compression. AAPS PharmSciTech (2004): 5(2) Article 30
- Mitrevej, A., Faroongsarng, D. and Sinchaipanid, N. Compression behaviour of spray dried rice starch. International Journal of Pharmaceutics 140 (1996): 61-68.
- Mitrevej, A., Sinchaipanid, N. and Faroongsarng, D. Spray-dried rice starch: comparative evaluation of direct compression fillers. Drug Development and Industrial Pharmacy 22(7) (1996): 587-594.

- Nyquist, H. and Nicklasson, M., The effect of water sorption on physical properties of tablets containing microcrystalline cellulose. International Journal of Pharmaceutic. (1983): 67-73.
- Oyi A.R., Allagh, T.S. and Olayemi, O.J. Comparative binding effects of wheat, rice and maize starches in chloroquine phosphate tablet formulations. Applied Sciences, Engineering and Technology (2009): 77-80.
- Patel, R.P., Patel, M.P. and Suthar, A.M. Spray drying technology: an overview. Indian Journal of Science and Technology 2(10) (2009): 45-47.
- Pesonen, T. and Paronen, P. The effect of particle and powder properties on the mechanical properties of directly compressed cellulose tablets. Drug Development and Industrial Pharmacy 16(1) (1990): 31-54.
- Rashid, Ar.H., Heinamaki, J., Antikainen, O. and Yliruusi, J.. Effects of process variables on the size, shape, and surface characteristics of microcrystalline cellulose beads prepared in a centrifugal granulator. Drug Development and Industrial Pharmacy 25(5) (1999): 605–611.
- Ritter, A. and Sucker, H.B. Methods of measuring tablet capping. Part 2. Pharmaceutical Technology (1980): 109.
- Rowe, R.C., Sheskey, P.J. and Owen, S.C. Handbook of Pharmaceutical Excipients 5 th edition. (2006): 725-730. Royal Pharmaceutical Society of Great Britain London, UK.
- Sattayawuthipong, K. 2000. Evaluation of Size and Shape of Particulate Materials Ground by a Pin Mill using the Image Analysis Tecnique. Master's Thesis. Faculty of Engineering Chulalongkorn University.

- Stubberud, L., Arwidsson, G.H., and Graffner, C. Water-solid interactions: I. A technique for studying moisture sorption/desorption. International Journal of Pharmaceutic 114(1) (1995): 55-64.
- The United States Pharmacopeia Convention. The United States Pharmacopeia 31<sup>st</sup> ed. and The National Formulary 26<sup>th</sup> ed. (USP 31 & NF 26) (2008): 363-369. Rockville, MD.
- Timaroon, S. 1993. Study of tableting properties of modified rice starch prepared by spray drying technique and crosslinking reaction. Master's Thesis, Department of Industrial Pharmacy, Graduate school, Chulalongkorn University.
- Tsai, T., Wu, J.S., Ho, H.O. and Sheu, M.T. Modification of physical characteristics of microcrystalline cellulose by codrying with  $\beta$ -cyclodextrins. Journal of Pharmaceutical Sciences 87(1) (1998):117-122.
- Weecharangsan, W. 1995 The production and evaluations of modified rice starch as directly compressible diluents. Master's Thesis, Department of Industrial Pharmacy, Graduate school, Chulalongkorn University.
- Westermarck, S. 2000 Use of mercury porosimetry and nitrogen adsorption in characterisation of the pore structure of mannitol and microcrystalline cellulose powders, granules and tablets. Pharmaceutical Technology Division, Department of Pharmacy, University of Helsinki, Finland.
- Willen, U. 2008 Automation in image analysis for particle size and shape measurement, G.I.T. Laboratory Journal 7-8, pp 34–36.
- Wurster D.E., Peck G.E. and Kildsig, D.O. A comparison of the moisture adsorption desorption properties of corn starch, USP, and directly compressible starch. Drug Development and Industrial Pharmacy 8 (1982): 343–354.

Zhang, Y., Law, Y. and Chakrabarti, S. Physical properties and compact analysis of commonly used direct compression binders. AAPS PharmSciTech 4 (4) (2003): Article 62.

Zografi, G. and Kontny, M., J. The interactions of water with cellulose and starch derived pharmaceutical excipients. Pharmaceutical Research 3(4) (1986): 187-194.

## **APPENDICES**

# APPENDIX

## Automated images of RS: MCC composite particles

Examples of automated images of RS:MCC composite particles were determined by the Morphologi<sup>®</sup> G3 particle characterization system. The images of RS:MCC (CS) composite particles are present in Figure 1(A) and the images of RS:MCC (CJM) composite particles are present in Figure 2(A).

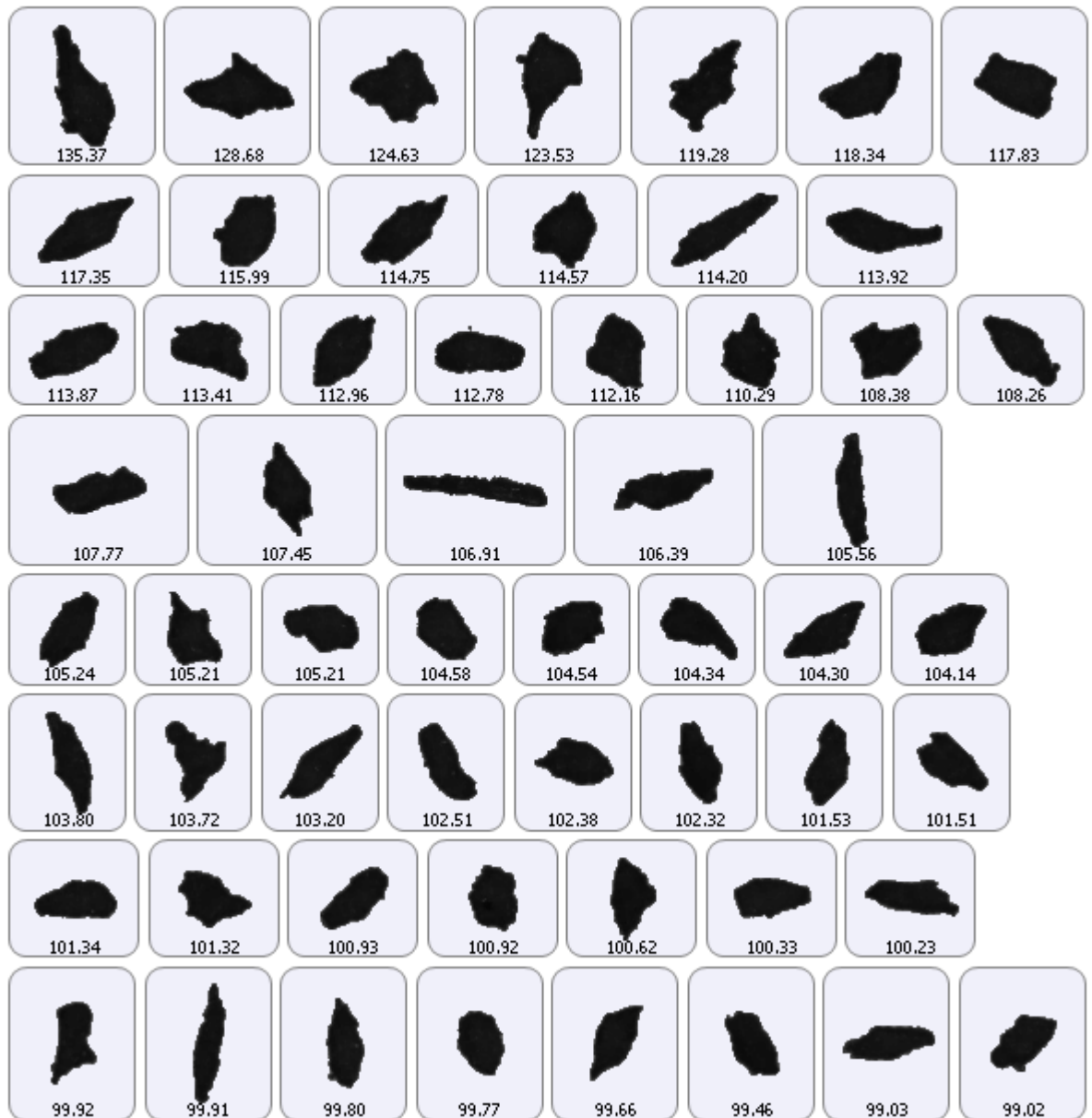

Figure 1(A) Examples of automated images of RS:MCC (CS) composite particles

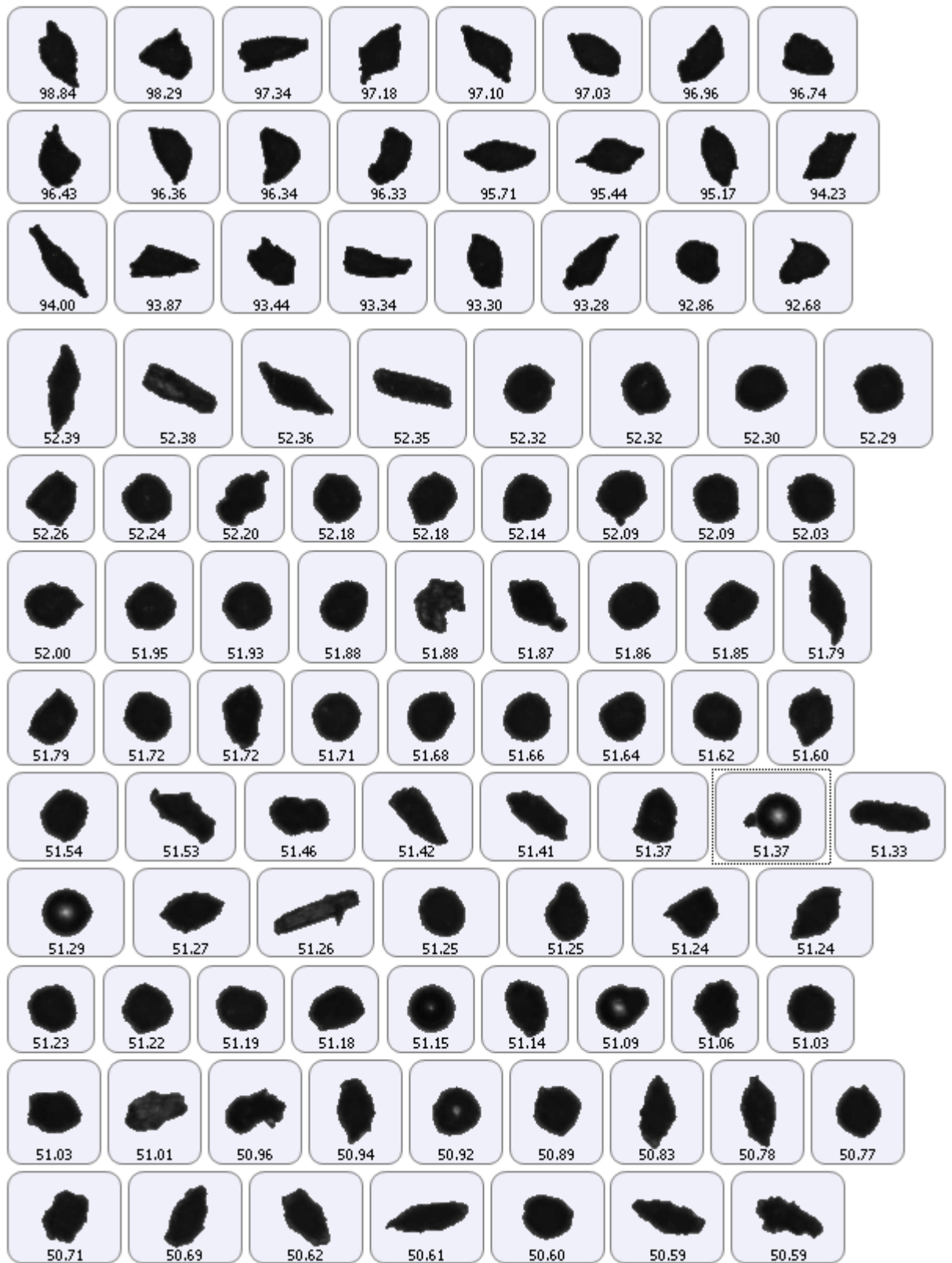

Figure 1(A) Examples of automated images of RS:MCC (CS) composite particles (cont.)



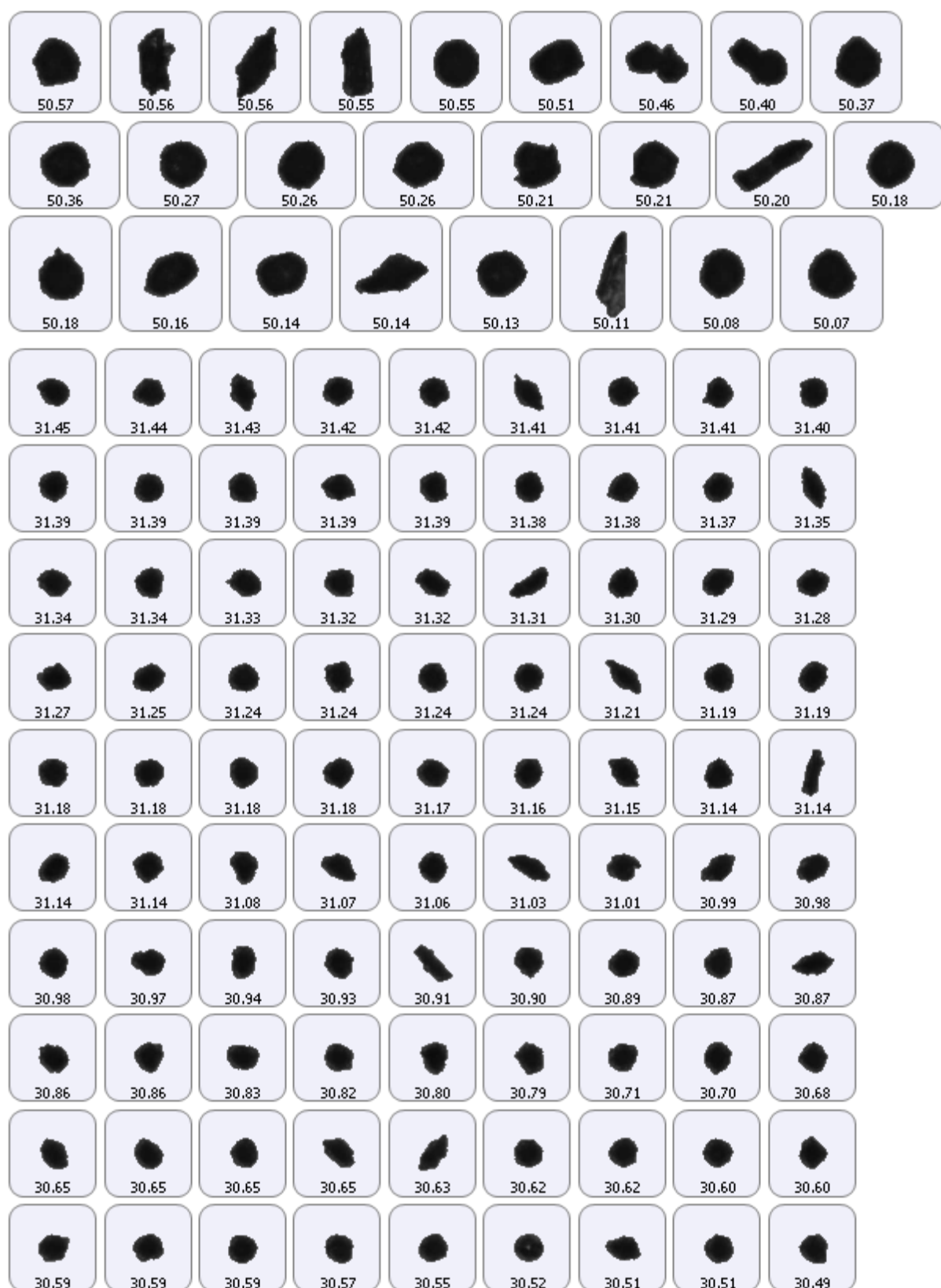

Figure 1(A) Examples of automated images of RS:MCC (CS) composite particles (cont.)

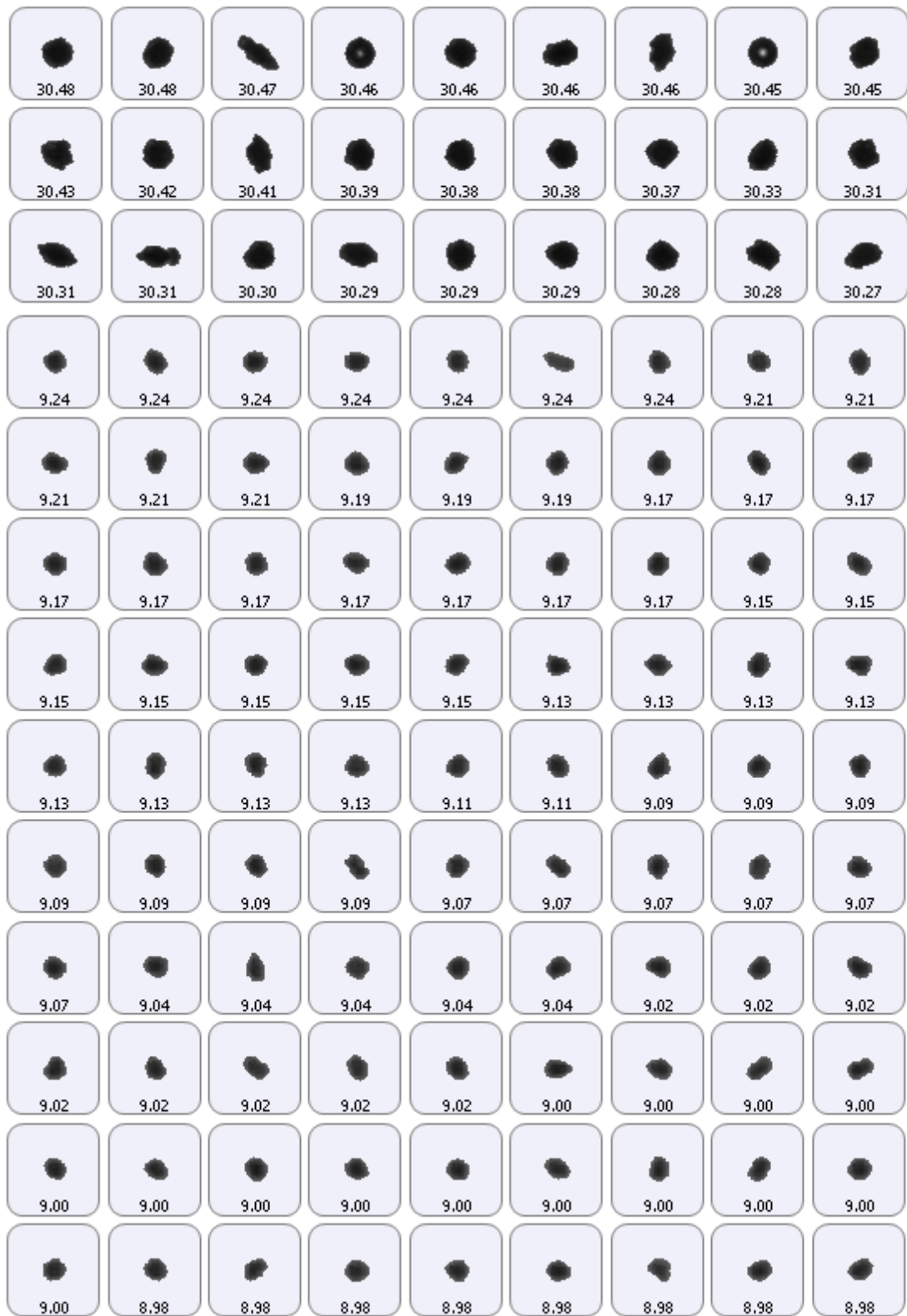

Figure 1(A) Examples of automated images of RS:MCC (CS) composite particles (cont.)

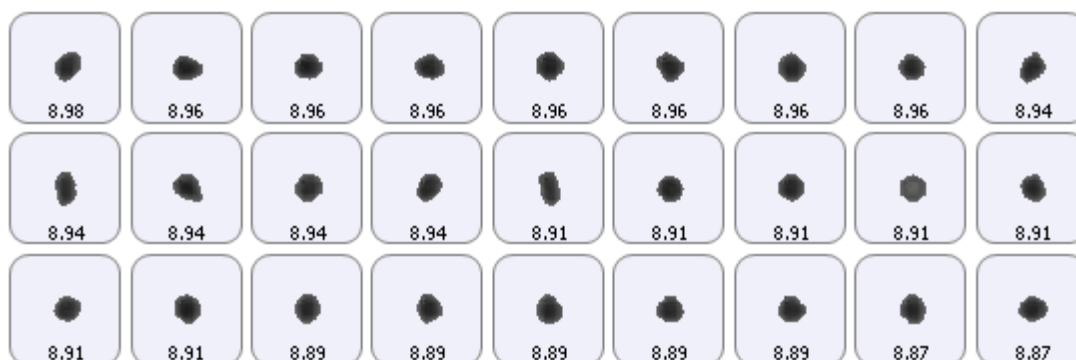

Figure 1(A) Examples of automated images of RS:MCC (CS) composite particles (cont.)

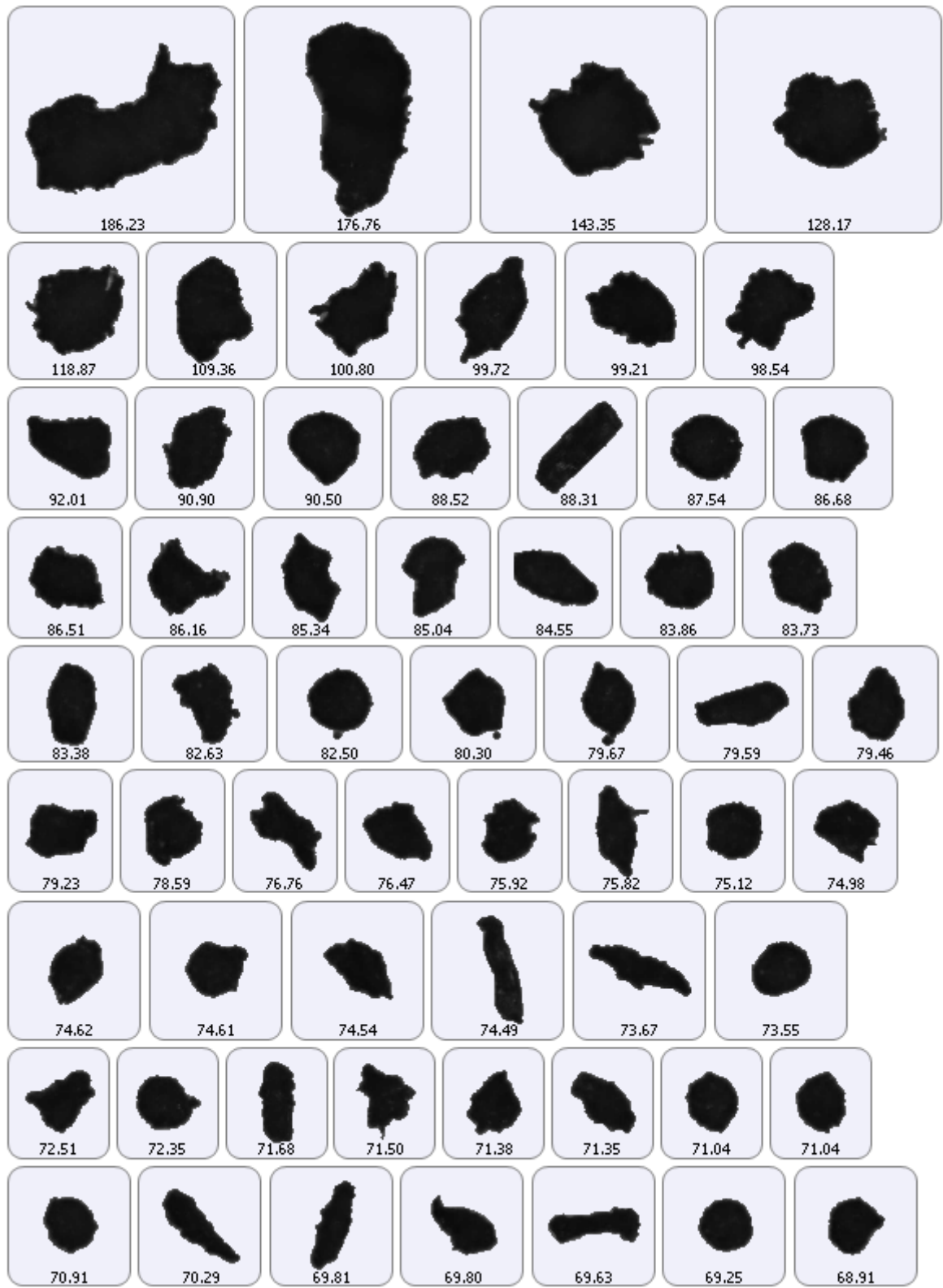

Figure 2(A) Examples of automated images of RS:MCC (CJM) composite particles

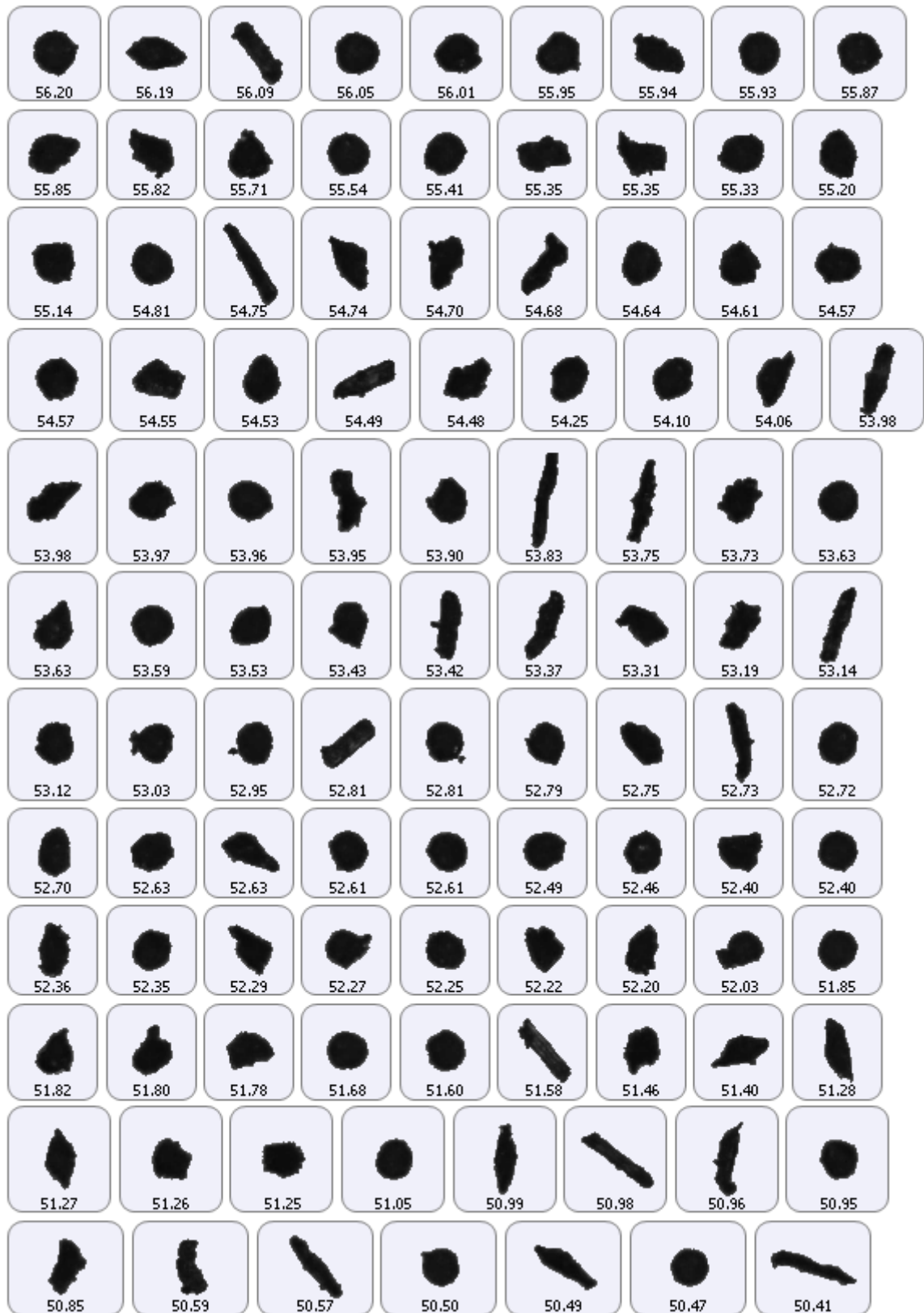

Figure 2(A) Examples of automated images of RS:MCC (CJM) composite particles (cont.)

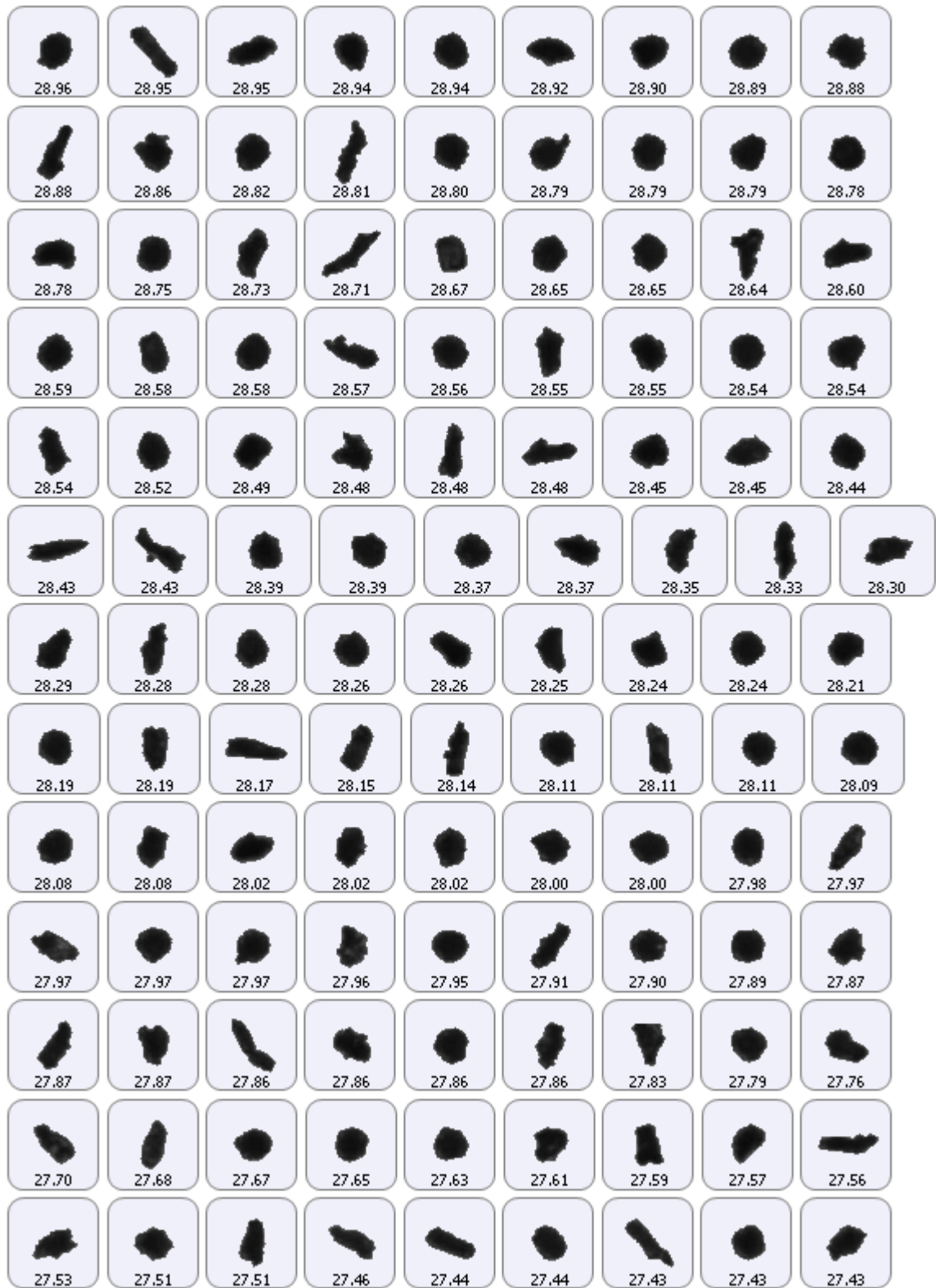

Figure 2(A) Examples of automated images of RS:MCC (CJM) composite particles (cont.)

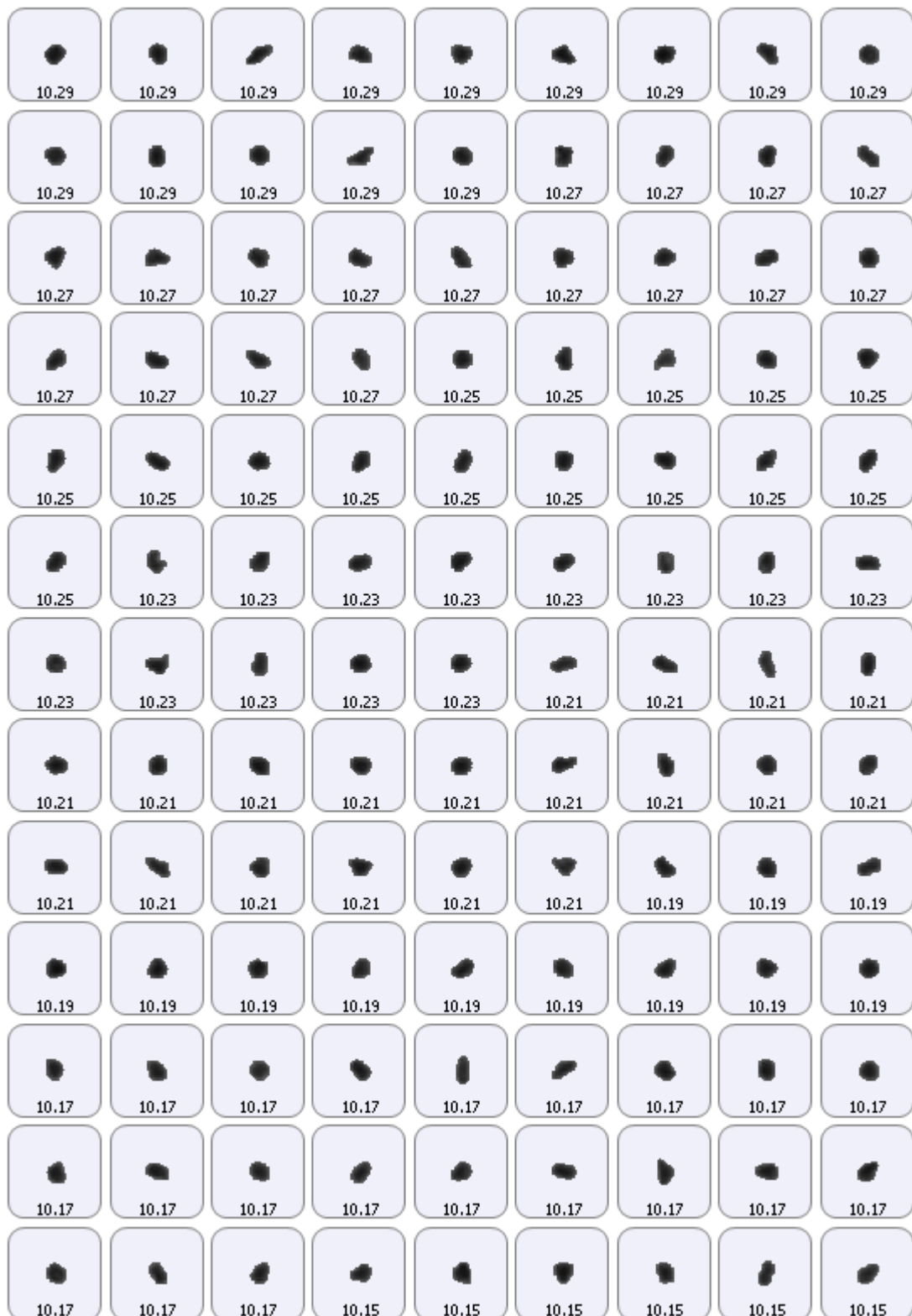

Figure 2(A) Examples of automated images of RS:MCC (CJM) composite particles (cont.)

## **VITAE**

Mrs.Ratchada Pattanasombatsakul was born on June 6, 1971. She received the Bachelor of Science in Pharmacy in 1995 from the faculty of Pharmaceutical Sciences, Rangsit University, Thailand. She entered studying in the Master's Degree in Industrial Pharmacy Program in the Faculty of Pharmaceutical Sciences, Chulalongkorn University, Thailand in 2008.