

## CHAPTER IV

### POLYPYRROLE-LITHIUM BATTERY

#### Introduction

In the development of rechargeable battery, the researchers are always exploring new batteries in hopes of finding one that has high energy density and can be mass produced into reliable products of low manufacturing cost. Lithium-polymer battery offers obvious advantages. Lithium is the lightest metal on the atomic chart and the polymer plastics have relatively low density.

It was known that a polypyrrole-lithium battery was developed and tested by BASF and VARTA A.G. of West Germany. Eppy was used as positive electrode with lithium negative electrode and the electrolyte was a solution of lithiumperchlorate ( $\text{LiClO}_4$ ) in PC [2].

From the measurements of electrode properties of Eppy and Cppy in rechargeable battery by cyclic voltammetry in chapter III, Cppy showed good electrode properties similar to Eppy. They can repeatedly driven between conducting and insulating states, from doped and undoped processes, with relatively low degradation so that it is possible to use Cppy as positive electrode in rechargeable battery.

In this research, polypyrrole-lithium batteries with either Eppy or Cppy as the positive electrode coupled with lithium negative electrode were constructed. Their electrical properties were studied by discharging and charging. Finally, the performances between both types of batteries using Cppy and Eppy as positive electrodes were compared.

## Reagents

Reagents used in experiments are listed below.

- |                               |         |
|-------------------------------|---------|
| 1. Aluminium metal            |         |
| 2. Lithium metal              | Aldrich |
| 3. Lithiumperchlorate         | Fluka   |
| 4. Propylene carbonate        | Fluka   |
| 5. Argon gas, 99.999 % purity | TIG     |



ศูนย์วิทยทรัพยากร  
จุฬาลงกรณ์มหาวิทยาลัย

## Experimental

### Polypyrrole-Lithium Battery Construction

Many types of polypyrrole-lithium batteries were constructed. Main components of each type are shown in Table 4.1

**Table 4.1** Components of polypyrrole-lithium battery

Type	Component			Approximate Distance between positive and negative electrodes (cm)
	Positive electrode	Negative electrode	Electrolyte solution	
A	Eppy surface area 6 cm <sup>2</sup>	Al	0.5 M LiClO <sub>4</sub> PC	1
B	Cppy surface area 2 cm <sup>2</sup>	Al	1 M LiClO <sub>4</sub> PC	1
C	Eppy surface area 6 cm <sup>2</sup>	Li	0.5 M LiClO <sub>4</sub> PC	1
D	Cppy surface area 2 cm <sup>2</sup>	Li	1 M LiClO <sub>4</sub> PC	1
E	Cppy surface area 6 cm <sup>2</sup>	Li	1 M LiClO <sub>4</sub> PC	0.3
F	Cppy surface area 12 cm <sup>2</sup>	Li	1 M LiClO <sub>4</sub> PC	0.2

Battery cells with lithium as negative electrodes must be dried and sealed since traces of moisture in solution and absorption of moisture from the environment results in strong corrosion of lithium. The requirement for using dried solvent in battery cells was essential.



PC was used as a solvent, it must be distilled under reduced pressure before use. The distilled solvent was collected after 10 percent of main bulk has passed over and then stored with molecular sieve type 4 A.

It was known that Eppy-lithium battery was developed by BASF and VATAR. The cell voltage was 3-4 V. In the battery cell, the starting electrolyte is 0.5 M solution of  $\text{LiClO}_4$  in PC. During the discharging process the electrochemical reactions proceed as Equation 4.1-4.2 [2].

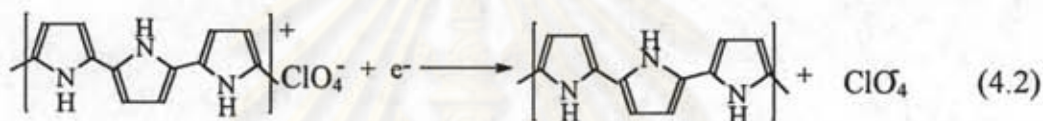

The electron from the oxidation reaction of lithium metal moved along a circuit to replace  $\text{ClO}_4^-$  in the polypyrrole positive electrode and the counterion  $\text{ClO}_4^-$  was released from polypyrrole to the electrolyte. During the charging process, a reversible electrochemical reactions operated.

Since lithium metal is very reactive to moisture in atmosphere, the experimental procedure is thus difficult to handle. Therefore, aluminium, a weaker reducing agent, was used in order to replace lithium metal. Battery cell with aluminium negative electrode can constructed without much difficulty. The cell voltage should be decreased to 1-2 V and the electrochemical reaction should be similar to Equations 4.1-4.2. That was the reaction of the first discharging process occurred from oxidation of aluminium to give electrons which move along the circuit to replace  $\text{ClO}_4^-$  in polypyrrole positive electrode. For the charging process, both of  $\text{Li}^+$  and  $\text{Al}^{3+}$  in the electrolyte associated with electrons from oxidation of polypyrrole resulted Li and Al plating on aluminium electrode. The quantity of Li plated on negative electrode should be more than that of Al because the  $\text{Li}^+$  in the electrolyte was large in number. The battery voltage should be increased to 3-4 V in

other following cycles. With the discharging process, the reversible reaction of charging should be operated. Consequently, battery type A and B should be performed. The polypyrrole-lithium battery using Al as negative electrode, can be constructed.

### Polypyrrole-Lithium Battery type A

Polypyrrole-lithium battery type A construction was performed by firstly electrochemical synthesis of polypyrrole onto a platinum plate for 30 min of reaction time. After the polymerization, polypyrrole was rinsed with PC and mounted as positive electrode in battery cell using aluminium metal as negative electrode. Electrolyte solution was a 0.5 M  $\text{LiClO}_4$  in PC. An argon gas was bubbled through the solution for 30 min, battery cell was then sealed. Figure 4.1 showed polypyrrole-lithium battery type A and the electrochemical cell current was shown in Table 4.2.

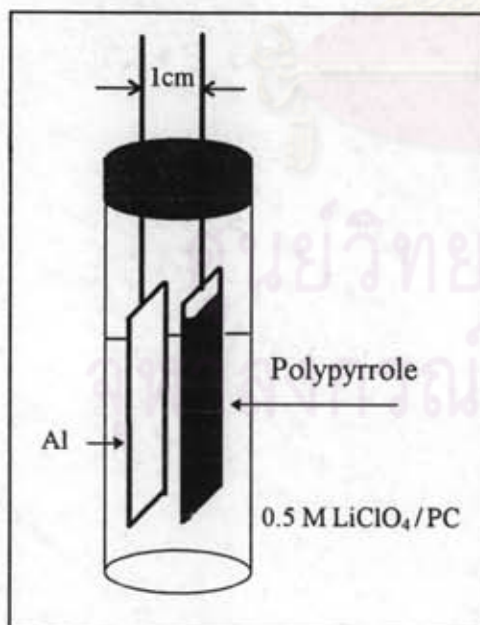

**Figure 4.1** Construction details of polypyrrole-lithium battery type A

**Table 4.2** Electrochemical cell current of polypyrrole synthesis

Time (min)	Current (mA)
0	4.93
2	4.92
4	4.92
6	4.91
8	4.91
10	4.90
12	4.90
14	4.89
16	4.89
18	4.89
20	4.88
22	4.88
24	4.88
26	4.87
28	4.87
30	4.86

After the battery construction was completed, the battery was repeatedly discharged and charged. The discharging and charging circuits were shown in Figure 4.2. The experimental results were shown in Tables 4.3-4.4.



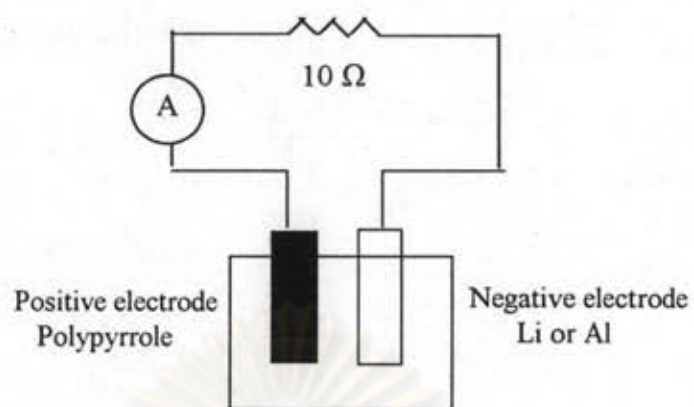

Discharging Circuit

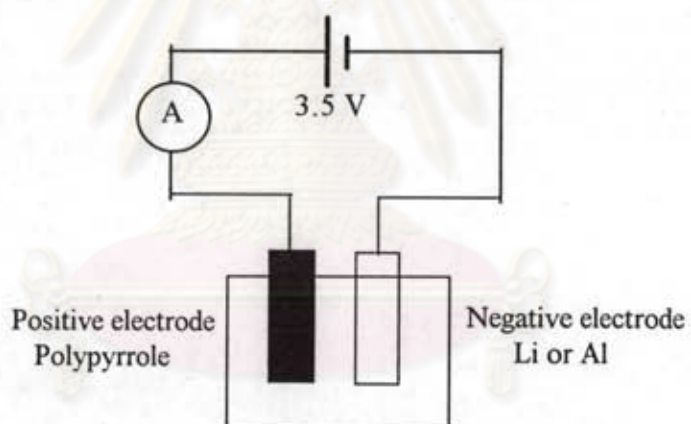

Charging Circuit

Figure 4.2 Discharging and charging circuits

**Table 4.3** Discharging current in each cycle of battery type A

Time (min)	Discharging Current (mA)				
	Cycle 1	Cycle 2	Cycle 3	Cycle 4	Cycle 5
0	0.284	18.5	17.64	17.48	16.54
1	0.301	0.129	0.089	0.132	0.263
2	0.330	0.249	0.124	0.085	0.122
3	0.351	0.332	0.218	0.181	0.209
4	0.360	0.374	0.303	0.272	0.265
5	0.360	0.357	0.337	0.311	0.287
6	0.351	0.338	0.345	0.322	0.283
7	0.340	0.315	0.340	0.319	0.274
8	0.321	0.292	0.327	0.308	0.257
9	0.302	0.270	0.313	0.296	0.241
10	0.289	0.251	0.297	0.281	0.224
11	0.268	0.236	0.281	0.266	0.210
12	0.246	0.221	0.262	0.251	0.196
13	0.238	0.208	0.244	0.237	0.186
14	0.230	0.202	0.227	0.233	0.176
15	0.222	0.189	0.213	0.213	0.166
16	0.213	0.180	0.198	0.197	0.159
17	0.206	0.173	0.185	0.185	0.151
18	0.199	0.166	0.173	0.173	0.144
19	0.193	0.159	0.162	0.162	0.136
20	0.186	0.154	0.152	0.152	0.129
21	0.181	0.148	0.142	0.142	0.123
22	0.176	0.142	0.132	0.132	0.118
23	0.170	0.139	0.124	0.124	0.111
24	0.167	0.134	0.116	0.116	0.106
25	0.161	0.129	0.109	0.109	0.101
26	0.157	0.125	0.102	0.103	0.096
27	0.153	0.121	0.096	0.096	0.092
28	0.148	0.118	0.090	0.09	0.088
29	0.145	0.114	0.085	0.085	0.084
30	0.141	0.111	0.081	0.080	0.081



**Table 4.4** The open-circuit voltage (o.c.v.) of battery type A

Discharging cycle	open-circuit voltage (V)	
	before discharging	after discharging
1	0.91	0.26
2	3.08	0.24
3	3.08	0.24
4	3.08	0.24
5	3.07	0.25

With the results in Table 4.3, the total electrical charge supplied from battery in the first cycle was 430.59 mC. It was calculated from the equation as follows.

$$Q = It \quad (4.3)$$

Q = electrical charge, I = electrical current, t = time

Total of electrical charge ( $\Sigma Q$ ) is

$$\Sigma Q = Q_1 + Q_2 + Q_3 + \dots + Q_i \quad (4.4)$$

$$Q_1 = [(I_0 + I_1)/2](t_1 - t_0) \quad (4.5)$$

$$Q_2 = [(I_1 + I_2)/2](t_2 - t_1) \quad (4.6)$$

$$Q_3 = [(I_2 + I_3)/2](t_3 - t_2) \quad (4.7)$$

$$Q_i = [(I_{i-1} + I_i)/2](t_i - t_{i-1}) \quad (4.8)$$

Hence:  $\Sigma Q = [(I_0 + I_1)/2](t_1 - t_0) + [(I_1 + I_2)/2](t_2 - t_1) + [(I_2 + I_3)/2](t_3 - t_2) + \dots + [(I_{i-1} + I_i)/2](t_i - t_{i-1}) \quad (4.9)$

If  $(t_1 - t_0) = (t_2 - t_1) = (t_3 - t_2) = \dots = (t_i - t_{i-1}) = \Delta t \quad (4.10)$

so that:  $\Sigma Q = [(I_0/2) + I_1 + I_2 + I_3 + \dots + I_{i-1} + (I_i/2)](\Delta t) \quad (4.11)$

From the data in Table 4.3, the total electrical charge in the first cycle was:

$$\Sigma Q = [(I_0/2)+I_1+I_2+\dots+I_{29}+(I_{30}/2)](\Delta t) \quad (4.12)$$

$$\begin{aligned} \Sigma Q = & [(0.284/2)+0.301+0.330+0.351+0.360+0.360+0.351 \\ & +0.340+0.321+0.302+0.289+0.268+0.246+0.238 \\ & +0.230+0.222+0.213+0.206+0.199+0.193+0.186 \\ & +0.181+0.176+0.170+0.167+0.161+0.157+0.153 \\ & +0.148+0.145+(0.141/2)](60) \end{aligned}$$

$$\Sigma Q = 430.59 \text{ mC}$$

The open circuit voltage (o.c.v.) of battery cell before discharging was shown in Table 4.4. The o.c.v. is the different potential between positive and negative electrodes with no current flowing in the external circuits so that a 0.91 V is the different potential between polypyrrole and aluminium electrodes before the first discharging cycle. From Figure 4.3 and Figure 4.4, they showed the plotting between the discharging current and time with different scales. The clear observation was a different performance between the first discharging cycle and the others in the first minute of discharging time.

The first discharging cycle showed a low current which gradually increased to a maximum and then decreased. This current resulted from discharging process which proceeds as the Equations 4.13-4.14.

The first discharging process : at the negative electrode



at the positive electrode

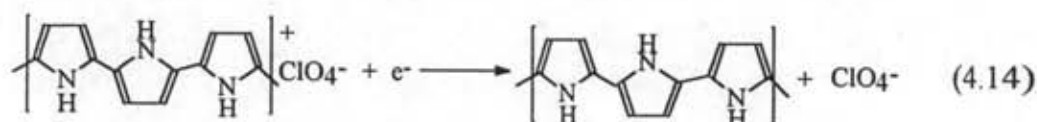

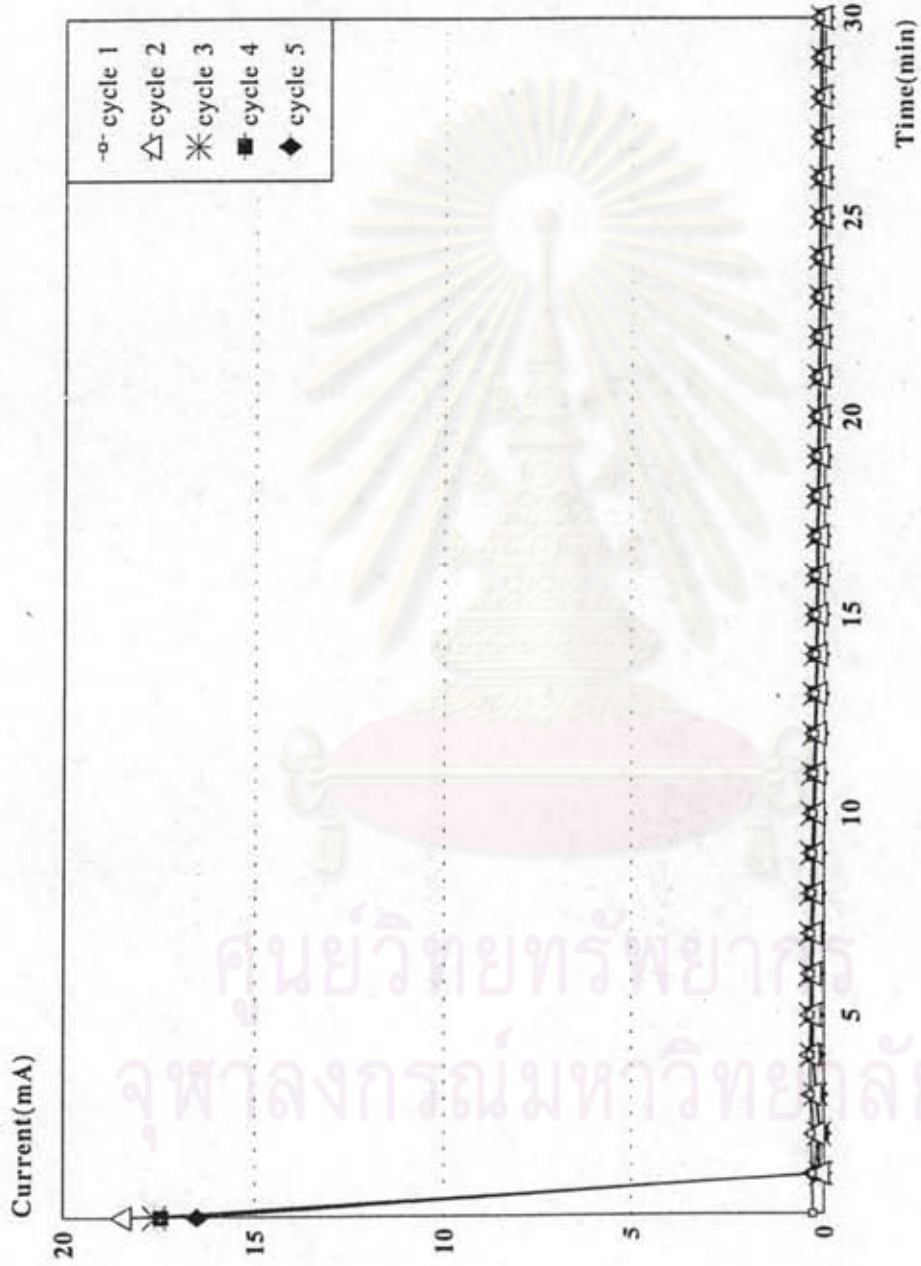

Figure 4.3 Discharging current curve of battery type A



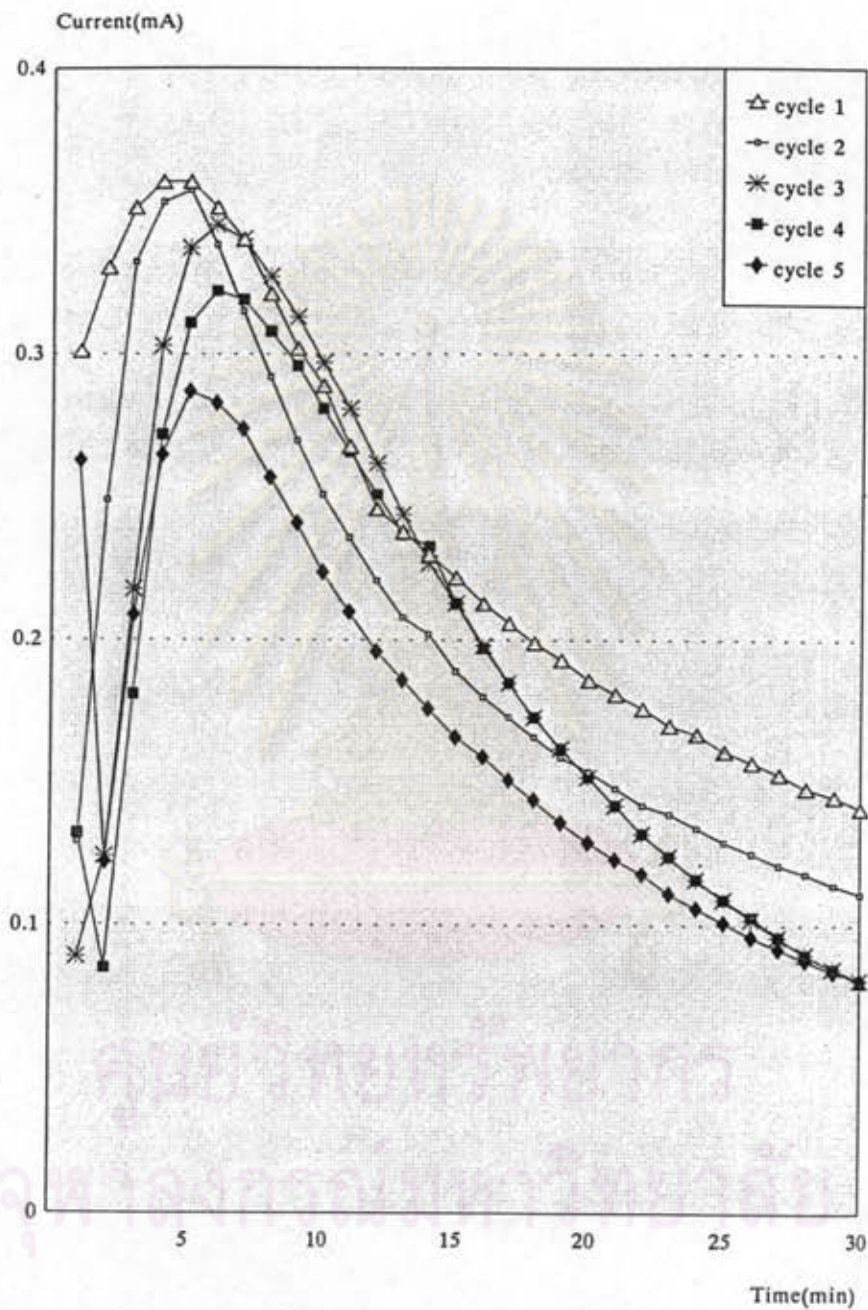

Figure 4.4 Discharging current curve of battery type A after the first minute of discharge time

The electron from the negative aluminium electrodes moves along a circuit to replace  $\text{ClO}_4^-$  in polypyrrole positive electrode and the counterion  $\text{ClO}_4^-$  was released from polypyrrole into the electrolyte.

When discharging was stopped, the o.c.v. was measured. It decreased to 0.26 V. Afterwards, the fully electrical energy of battery was returned by charging with approximately 3.5 V from power supply. The supplied electrical charges quantity, equalized to the total charges from discharging in each cycles. Table 4.5 is the example of battery charging in the first cycle. The fully charging time is 29 min. After charging, the o.c.v. increased to 3.08 V since the nature of the negative electrode was changed. During the charging process, the electrochemical reactions proceed as the Equations 4.15-4.17.

The charging process: at the negative electrode



at the positive electrode

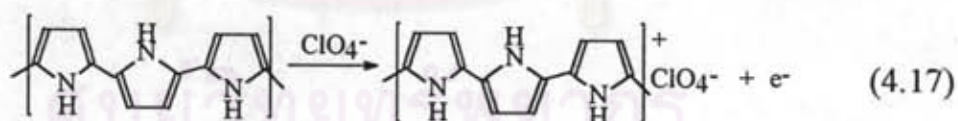

The released electron by the oxidation reaction of polypyrrole associated with  $\text{Al}^{3+}$  and  $\text{Li}^+$  in the electrolyte solution, resulted Al and Li plating on negative electrode. The  $\text{Li}^+$  can gain the electron since the quantity of  $\text{Li}^+$  in the electrolyte was large. The more quantity of  $\text{Li}^+$  in electrolyte, the more Li plating on aluminium electrode was expected. To maintain charge neutrality in the oxidized polypyrrole there must be an affiliation of a  $\text{ClO}_4^-$  which came from the electrolyte.

**Table 4.5** Charging current in the first cycle  
of battery type A

Time (min)	Current (mA)
0	0.740
1	0.483
2	0.396
3	0.352
4	0.323
5	0.314
6	0.285
7	0.272
8	0.262
9	0.252
10	0.245
11	0.238
12	0.231
13	0.224
14	0.220
15	0.214
16	0.209
17	0.204
18	0.199
19	0.195
20	0.192
21	0.189
22	0.185
23	0.182
24	0.179
25	0.176
26	0.173
27	0.170
28	0.168
29	0.166
<b>Total electrical charge (mC)</b>	<b>431.04</b>



When the battery was discharged in the second cycle, the reversible charging reactions were operated. The discharging current in this cycle was high but rapidly decreased to a low current in a short time, afterwards a low current was gradually increased until maximum and decreased again. These results affected from reactivities of Li and Al electrodes in the oxidation process. The Li electrode which produced higher voltage supplied the high current. The Al electrode produced low voltage thus resulted in low current afterward. Since the period of high current was very short, this indicated that  $\text{Li}^+$  was plated on Al electrode in very small amount compared with  $\text{Al}^{3+}$  which is opposite to what was expected at the beginning of this experiment.

Finally, the internal resistance of battery in each cycle was calculated. The results were shown in Table 4.6.

**Table 4.6** Internal resistance before and after discharging in each cycles of battery type A

Cycle	Internal resistance ( $\Omega$ )	
	before discharged	after discharged
1	3194	1834
2	157	2152
3	165	2953
4	166	2990
5	176	3076

The method for internal resistance calculation was presented from the equation as follows.

$$E = I(R+r) \quad (4.18)$$

$E$  = different potential,  $I$  = current,  $R$  = external resistance,  $r$  = internal resistance

For example: The internal resistance before the first discharging cycle was

$$r = (E/I) - R \quad (4.19)$$

$E$  = o.c.v. before the first discharging cycle = 0.91 V

$I = I_0 = 0.284 \times 10^{-3}$  A,  $R = 10 \Omega$

hence:  $r = (0.91/0.284 \times 10^{-3}) - 10$

$$r = 3194 \Omega$$

and internal resistance after the first discharging cycle was

$E$  = o.c.v. after the first discharging cycle = 0.26 V

$I = I_{30} = 0.141 \times 10^{-3}$  A,  $R = 10 \Omega$

hence:  $r = (0.26/0.141 \times 10^{-3}) - 10$

$$r = 1834 \Omega$$

In summary, the construction of polypyrrole-lithium battery type A using aluminium metal replaced lithium metal as negative electrode is easy to handle. Though battery is rechargeable but impracticable since the discharging current is not regular and the resistance is too high.

### Polypyrrole-Lithium Battery type B

A 200 mg of polypyrrole powder from chemical synthesis was pressed into a disc with 2 tons of hydraulic force in evacuable die for 10 min ( $\phi = 1.2$  cm). Afterwards, polypyrrole disc was mounted as positive electrode in battery cell using aluminium metal as negative electrode. Electrolyte solution was 1 M  $\text{LiClO}_4$  in PC. An argon gas was bubbled through the electrolyte solution for 30 min before the cell was sealed. Figure 4.5 showed polypyrrole-lithium battery type B.

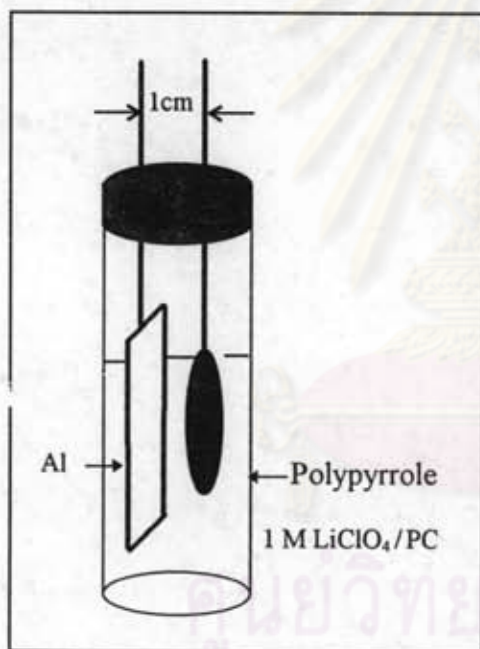

**Figure 4.5** Construction details of polypyrrole-lithium battery type B

ศูนย์วิทยุทรัพยากร  
จุฬาลงกรณ์มหาวิทยาลัย



After the battery cell construction was completed, the battery was repeatedly discharged and charged. The experimental results showed in Tables 4.7-4.8.

**Table 4.7** The open-circuit voltage of battery type B

Discharging cycle	open-circuit voltage (V)	
	before discharging	after discharging
1	0.70	0.38
2	3.02	0.46
3	3.01	0.46
4	3.02	0.47
5	3.02	0.48

With the o.c.v. of battery cell in Table 4.7, the different potential between polypyrrole and lithium electrodes was 0.70 V in the first cycle. From the discharging current, the plot between discharging current and time is shown in Figure 4.6. In Figure 4.7, the scale of current is much enlarged and the current is shown only after  $t = 1$  min. It is clear that there was a different current of the first discharging cycle and the others.

The first discharging cycle showed a low current which gradually increased to a maximum and then decreased. This current was resulted from discharging process which proceeds as the Equations 4.20-4.21.

จุฬาลงกรณ์มหาวิทยาลัย

**Table 4.8** Discharging current in each cycle of battery type B

Time (min)	Discharging Current (mA)				
	Cycle 1	Cycle 2	Cycle 3	Cycle 4	Cycle 5
0	0.082	12.68	12.60	12.58	12.48
1	0.091	0.048	2.43	1.41	0.056
2	0.115	0.050	0.076	0.089	0.058
3	0.138	0.052	0.05	0.101	0.071
4	0.158	0.055	0.054	0.110	0.081
5	0.179	0.063	0.062	0.117	0.089
6	0.196	0.074	0.072	0.122	0.096
7	0.210	0.084	0.082	0.126	0.102
8	0.222	0.093	0.091	0.129	0.108
9	0.232	0.100	0.100	0.131	0.113
10	0.240	0.107	0.110	0.133	0.117
11	0.249	0.113	0.122	0.133	0.119
12	0.255	0.117	0.129	0.135	0.120
13	0.260	0.120	0.136	0.136	0.122
14	0.264	0.122	0.142	0.137	0.123
15	0.267	0.124	0.146	0.138	0.124
16	0.269	0.125	0.148	0.138	0.124
17	0.271	0.126	0.150	0.139	0.125
18	0.272	0.127	0.152	0.139	0.125
19	0.273	0.128	0.154	0.140	0.126
20	0.273	0.128	0.156	0.140	0.126
21	0.272	0.128	0.157	0.141	0.125
22	0.271	0.127	0.158	0.141	0.125
23	0.27	0.127	0.159	0.142	0.124
24	0.268	0.127	0.160	0.141	0.124
25	0.265	0.126	0.161	0.141	0.123
26	0.262	0.126	0.160	0.141	0.123
27	0.259	0.125	0.158	0.140	0.122
28	0.256	0.124	0.157	0.139	0.122
29	0.253	0.123	0.156	0.138	0.121
30	0.250	0.123	0.154	0.137	0.121

continued

Time (min)	Discharging Current (mA)				
	1	2	3	4	5
31	0.246	0.122	0.153	0.137	0.120
32	0.242	0.122	0.152	0.136	0.120
33	0.238	0.121	0.150	0.136	0.119
34	0.234	0.121	0.148	0.135	0.119
35	0.230	0.120	0.147	0.135	0.118
36	0.226	0.120	0.145	0.135	0.118
37	0.223	0.119	0.143	0.134	0.118
38	0.220	0.119	0.141	0.134	0.117
39	0.217	0.119	0.139	0.133	0.117
40	0.214	0.118	0.138	0.133	0.116
41	0.211	0.118	0.137	0.132	0.115
42	0.209	0.118	0.136	0.132	0.115
43	0.207	0.117	0.135	0.131	0.114
44	0.205	0.117	0.134	0.131	0.114
45	0.204	0.117	0.134	0.131	0.114
46	0.203	0.116	0.133	0.130	0.113
47	0.202	0.116	0.133	0.130	0.113
48	0.201	0.116	0.132	0.130	0.113
49	0.200	0.115	0.132	0.129	0.112
50	0.199	0.115	0.131	0.129	0.112
51	0.199	0.115	0.131	0.129	0.111
52	0.198	0.115	0.131	0.128	0.111
53	0.198	0.114	0.130	0.128	0.111
54	0.197	0.114	0.130	0.128	0.110
55	0.197	0.114	0.130	0.127	0.110
56	0.197	0.114	0.129	0.127	0.110
57	0.196	0.114	0.129	0.127	0.110
58	0.196	0.113	0.129	0.126	0.109
59	0.196	0.113	0.129	0.126	0.109
60	0.195	0.112	0.128	0.125	0.109



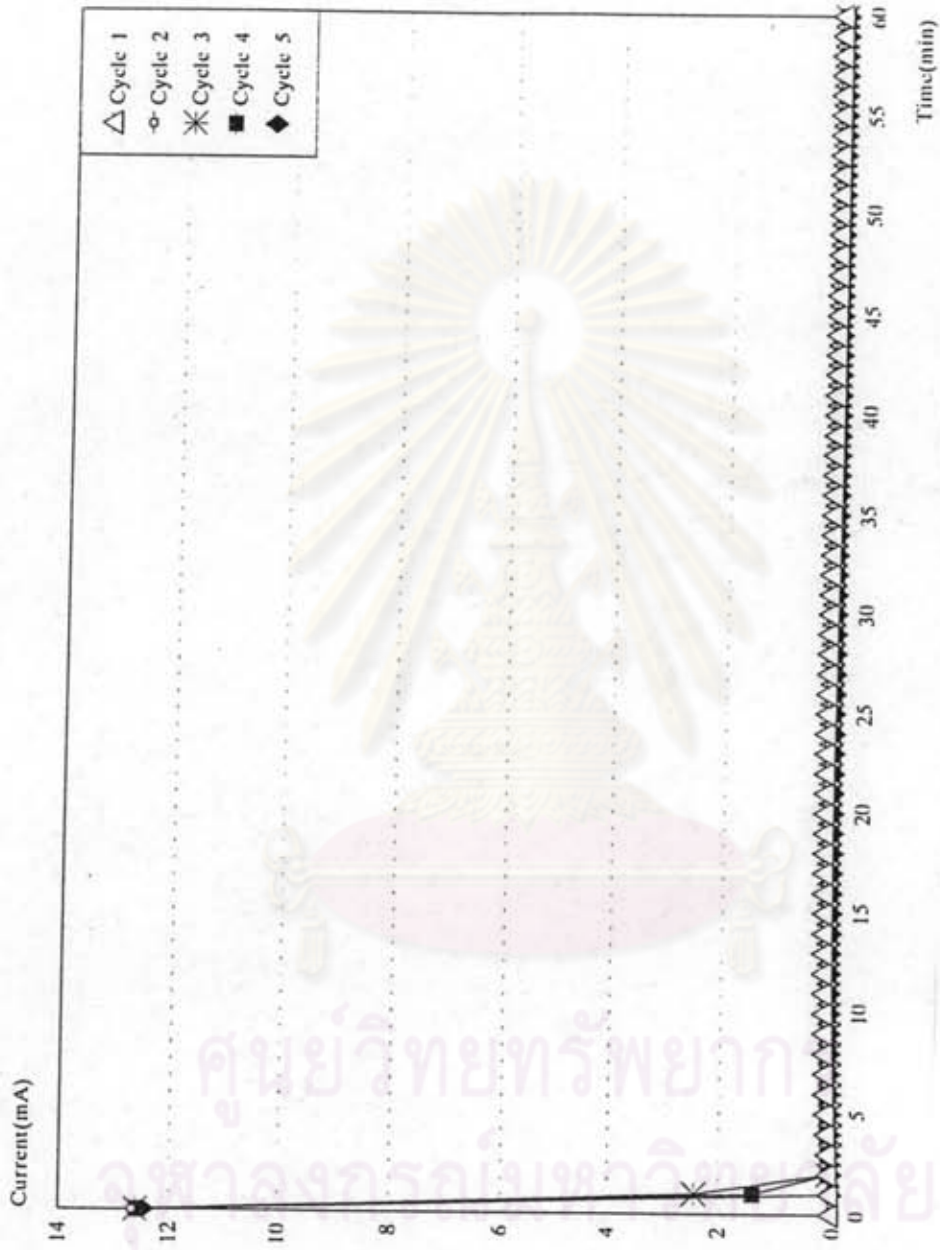

Figure 4.6 Discharging current curve of battery type B

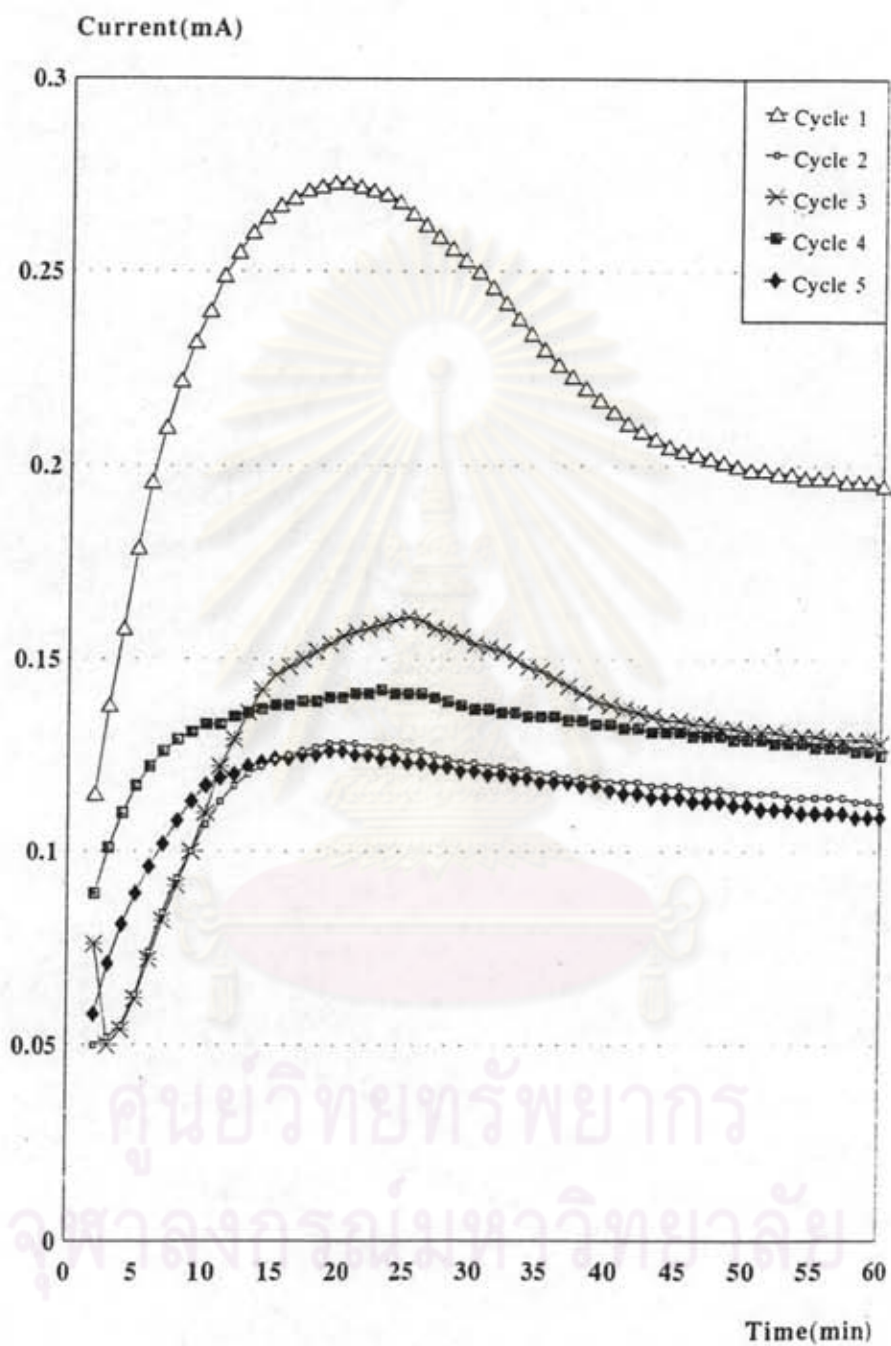
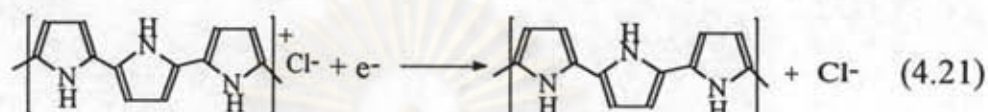

Figure 4.7 Discharging current curve of battery type B after the first minute of discharge time

The first discharging process: at the negative electrode



at the positive electrode



The electron from the negative aluminium electrode moves along a circuit to replace  $\text{Cl}^-$  in the polypyrrole positive electrode and the counterion  $\text{Cl}^-$  was released from polypyrrole to the electrolyte.

When discharging was stopped, the o.c.v. was measured. It decreased to 0.46 V. Afterwards, the fully charge of the battery was returned by charging with 3.5 V from power supply. The o.c.v. of battery increased to 3.02 V. During the charging process, the electrochemical reactions proceed as the Equations 4.22-4.24.

The charging process: at the negative electrode



at the positive electrode

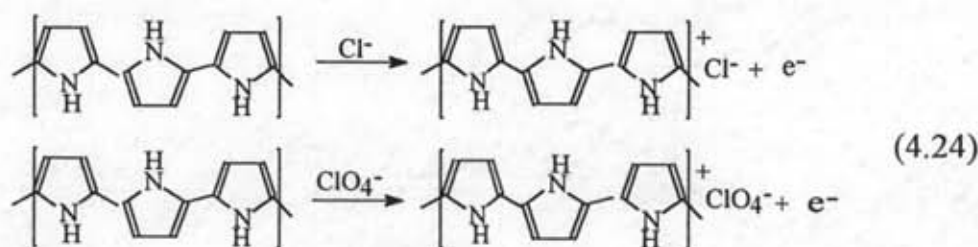



The released electron by the oxidation reaction of polypyrrole associated with  $\text{Al}^{3+}$  and  $\text{Li}^+$  in the electrolyte solution, resulted Al and Li plating on negative electrode. The  $\text{Li}^+$  can gain the electrode since the quantity of  $\text{Li}^+$  in the electrolyte was large. The more quantity of  $\text{Li}^+$  in electrolyte, the more Li plating on aluminium electrode was expected. To maintain charge neutrality in the oxidized polypyrrole, there must be an affiliation of anions both  $\text{ClO}_4^-$  and  $\text{Cl}^-$  which came from the electrolyte. For other discharging cycles, the discharging current characteristics were the same as battery type A.

In summary, the construction of polypyrrole-lithium battery type B using aluminium metal replaced lithium metal as negative electrode is also easy to handle. Similarly, the battery type B is rechargeable but impracticable since the discharging current is not regular and the internal resistance (Table 4.9) is too high. It must use lithium metal as electrode.

**Table 4.9** Internal resistance before and after charging in each cycles of battery type B

Cycle	Internal resistance ( $\Omega$ )	
	before discharged	after discharged
1	8526	1938
2	228	3561
3	229	3584
4	230	3750
5	232	4394

### Polypyrrole-Lithium Battery type C

In battery cell type C, lithium metal was used as negative electrode. It must be done in argon atmosphere in glove box since lithium is very reactive to the moisture in the atmosphere. Glove box in Figure 4.8 constructed in this experiment was made of transparent plastic and equipped with a pair of rubber gloves which was fitted through air-tight seals at the front side of the box. Electrical switches, inlet tap, outlet tap fitted with the long rubber tube and air-locked door were also provided.

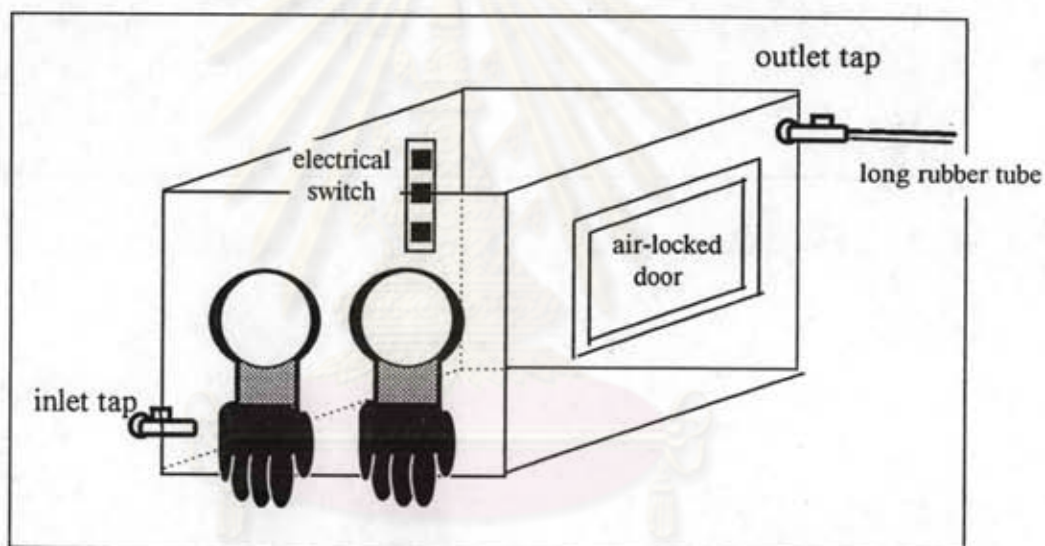
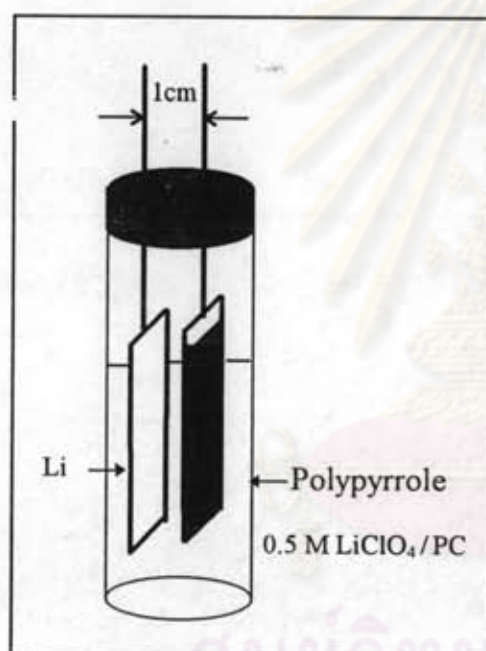

Figure 4.8 Glove box

Battery construction was first proceeded by placing apparatus and materials involved in the glove box. A 99.999 % argon gas of volume 11 time of the volume of the box was ejected into this glove box through the inlet tap. This argon gas mixed with air inside the box and then passed out through the outlet tap to the outer atmosphere. The long rubber tube protected the air to diffuse back to the box. Theoretically, only about  $e^{-11}$  of the air originally filled up the box still remained in the box. Thus the purity of argon reduced to 99.997 % which was still

acceptable. During the reaction, a supply of argon flowing into the box was continuously operated. Then, polypyrrole was electrochemically polymerized inside the box with reaction time for 45 min to obtain a thick film of polypyrrole covered on platinum plate. After polymerization, polypyrrole film was rinsed with PC and mounted as positive electrode in battery cell using lithium metal as negative electrode. Electrolyte solution was a 0.5 M  $\text{LiClO}_4$  in PC. The battery cell was then sealed. Figure 4.9 showed polypyrrole-lithium battery type C and electrochemical cell current of polypyrrole synthesis was shown in Table 4.10.



**Figure 4.9** Construction details of polypyrrole-lithium battery type C

ศูนย์วิจัยทรัพยากร  
จุฬาลงกรณ์มหาวิทยาลัย



**Table 4.10** Electrochemical cell current of polypyrrole synthesis

Time (min)	Current (mA)
0	5.74
5	5.73
10	5.72
15	5.71
20	5.70
25	5.69
30	5.68
35	5.67
40	5.66
45	5.66
50	5.65
55	5.65
60	5.65

After the battery cell construction was completed, the battery was repeatedly discharged and charged. The experimental results were shown in Tables 4.11-4.12.

ศูนย์วิทยทรัพยากร  
จุฬาลงกรณ์มหาวิทยาลัย

**Table 4.11** The open-circuit voltage (o.c.v.) of battery type C

Discharging cycle	open-circuit voltage (V)	
	before discharging	after discharging
1	3.15	2.10
2	3.16	2.21
3	3.17	2.21
4	3.16	2.18
5	3.16	2.23

**Table 4.12** Discharging current and total electrical charge in each cycle of battery type C

Time (min)	Discharging Current (mA)				
	Cycle 1	Cycle 2	Cycle 3	Cycle 4	Cycle 5
0	11.4	9.45	8.84	7.43	6.57
1	6.81	4.92	4.46	4.94	3.65
2	4.47	3.5	3.15	3.22	3.04
3	3.27	2.72	2.40	2.47	2.62
4	2.74	1.95	1.80	1.97	2.18
5	2.30	1.52	1.45	1.62	1.85
6	1.90	1.24	1.21	1.42	1.53
7	1.44	0.97	1.10	1.24	1.34
8	1.06	0.78	0.98	1.06	1.23
9	0.84	0.60	0.88	0.92	1.13
10	0.79	0.50	0.79	0.80	1.02
11	0.63	0.41	0.70	0.71	0.94
12	0.57	0.32	0.61	0.65	0.88
13	0.46	0.27	0.53	0.60	0.82
14	0.34	0.25	0.47	0.56	0.72
15	0.31	0.23	0.43	0.52	0.68
<b>Total electrical charge (mC)</b>	<b>2008.5</b>	<b>1487.4</b>	<b>1509.9</b>	<b>1569.3</b>	<b>1594.5</b>

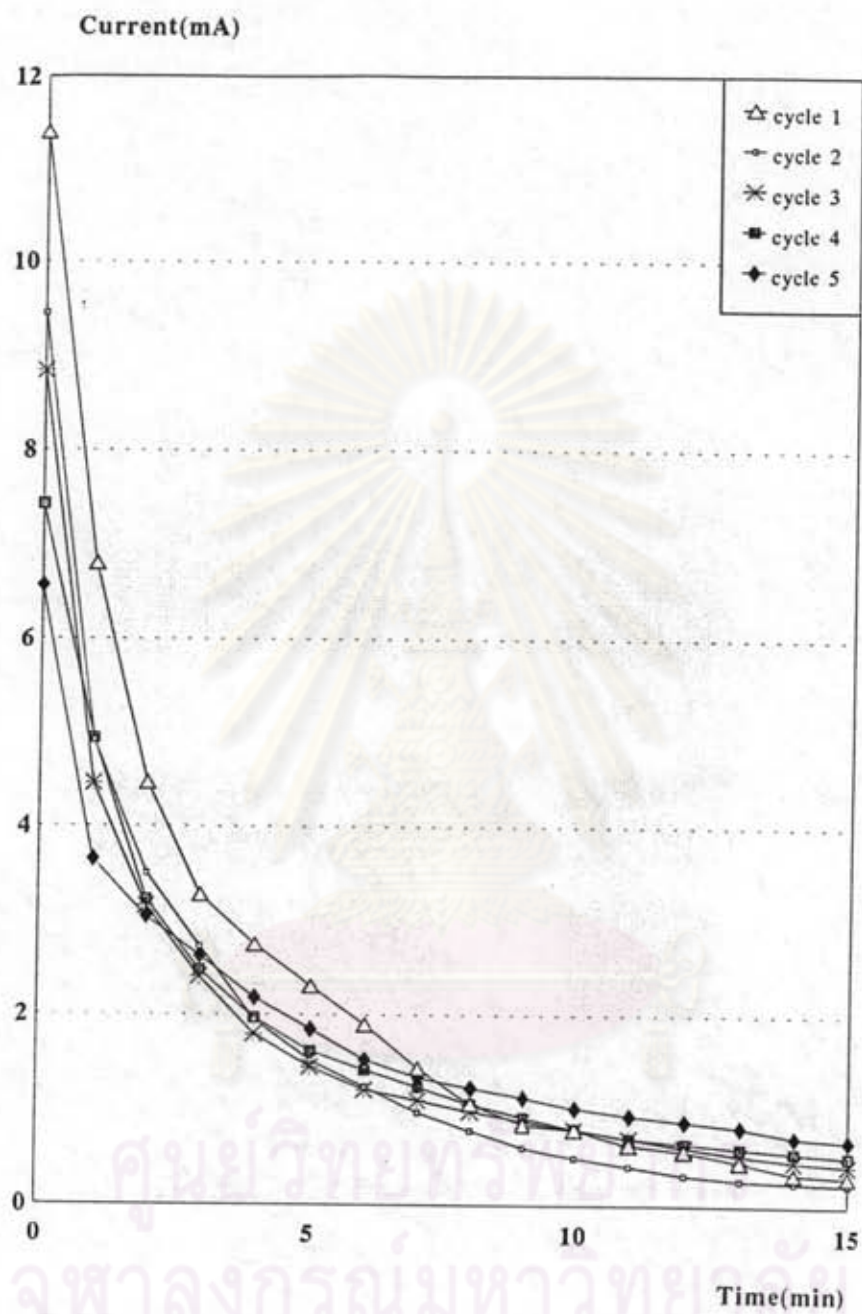

Figure 4.10 Discharging current curve of battery type C



With the o.c.v. of battery cell in Table 4.11, the different potential between polypyrrole and lithium electrodes was 3.15 V. The discharging characteristic in Figure 4.10 showed that the current of all cycles was decreased with time. It resulted from discharging process which proceeded as the Equations 4.25-4.26.

The discharging process: at the negative electrode



at the positive electrode

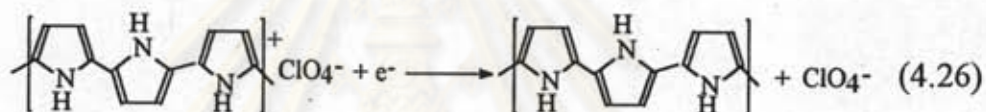

The electron from the negative lithium electrode moves along a circuit to replace  $\text{ClO}_4^-$  in the polypyrrole positive electrode, and the counterion  $\text{ClO}_4^-$  was released from polypyrrole to the electrolyte.

When the discharging was stopped, the o.c.v. was measured. It decreased to 2.10 V. Afterwards, the fully charged battery was returned by charging with 3.5 V power supply. The o.c.v. increased to 3.16 V. During the charging process, the reversible discharging reactions were operated.

When all discharging current curves were compared, it was found that the early current curves were decreased with more discharging cycle and the later current curves were decreased in the second cycle and increased in the third, fourth and fifth cycles. These behaviors indicated that.

(1) The inner part of polypyrrole did not participate in the redox process in the early cycle. More and more inner part of polypyrrole participated in the reaction in the later cycle.

(2) The neutral form of polypyrrole near the surface was easily damaged by oxidation reaction probably with remained oxygen in electrolyte solution.

(3) Motion of  $\text{ClO}_4^-$  from the inner part of polypyrrole contributed to high internal resistance of the cell.

In summary, battery using polypyrrole synthesized from electrochemical method as electrode is rechargeable but impracticable since the internal resistance shown in Table 4.13 is still too high. The damage of neutral polypyrrole by remained oxygen also contributed to the problem of cyclability of the battery.

**Table 4.13** Internal resistance before and after charging in each cycle of battery type C

Cycle	Internal resistance ( $\Omega$ )	
	before discharging	after discharging
1	266	6764
2	333	3599
3	347	5060
4	415	4240
5	471	3269

### Polypyrrole-Lithium Battery type D

Battery type D was first construction by supplied a 99.999 % purity of argon gas through the glove box for 11 times of box volume. An argon atmosphere was maintained whilst the experiment is in used by continuously supplying a slow current of argon gas to the box. Afterwards, a 200 mg of Cppy disc ( $\phi = 1.2$  cm) obtained from pressing Cppy with 2 tons of hydraulic force in evacuable die for 10 min was mounted as positive electrode in battery cell, lithium metal was used as negative electrode. Electrolyte solution was 1 M  $\text{LiClO}_4$  in PC. The battery was then sealed. Figure 4.11 showed polypyrrole-lithium battery type D.

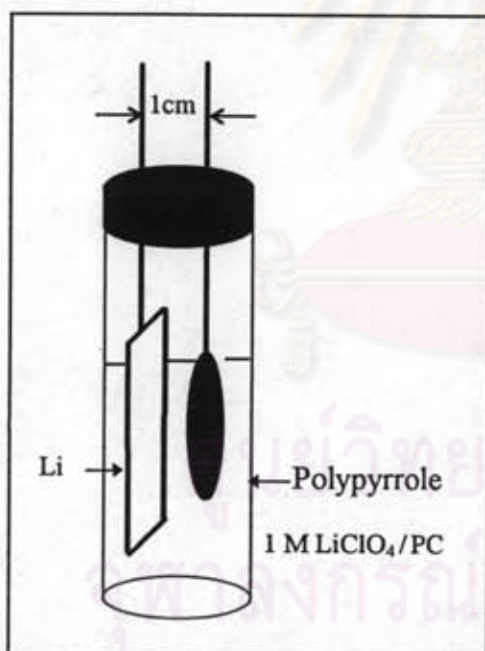

**Figure 4.11** Construction details of polypyrrole-lithium battery type D

After the battery cell construction was completed, the battery was repeatedly discharged and charged. The experimental results were shown in Tables 4.14-4.15.



**Table 4.14** The open-circuit voltage (o.c.v.) of battery type D

Discharging cycle	open-circuit voltage (V)	
	before discharging	after discharging
1	3.06	2.50
2	3.18	2.51
3	3.18	2.51
4	3.16	2.50
5	3.18	2.51

**Table 4.15** The discharging current and total electrical charge in each cycle of battery type D

Time (min)	Discharging Current (mA)				
	Cycle 1	Cycle 2	Cycle 3	Cycle 4	Cycle 5
0	1.69	3.26	3.12	2.79	2.73
1	2.45	3.04	2.82	2.48	2.53
2	2.81	2.77	2.50	2.23	2.31
3	2.55	2.51	2.26	2.05	2.10
4	2.29	2.24	2.05	1.83	1.87
5	2.09	2.01	1.86	1.67	1.70
6	1.93	1.83	1.70	1.53	1.55
7	1.80	1.67	1.55	1.41	1.42
8	1.69	1.54	1.42	1.31	1.32
9	1.58	1.42	1.29	1.22	1.23
10	1.51	1.32	1.24	1.14	1.15
11	1.43	1.22	1.16	1.06	1.08
12	1.36	1.14	1.08	0.99	1.01
13	1.28	1.07	1.02	0.93	0.96
14	1.20	1.01	0.96	0.88	0.90
15	1.13	0.95	0.90	0.83	0.85
16	1.08	0.90	0.85	0.79	0.81
17	1.03	0.85	0.8	0.75	0.78
18	0.99	0.81	0.76	0.72	0.74
19	0.95	0.77	0.73	0.69	0.70
20	0.92	0.73	0.71	0.67	0.67
<b>Total electrical charge (mC)</b>	<b>1947.3</b>	<b>1863.9</b>	<b>1731.9</b>	<b>1574.4</b>	<b>1602.6</b>

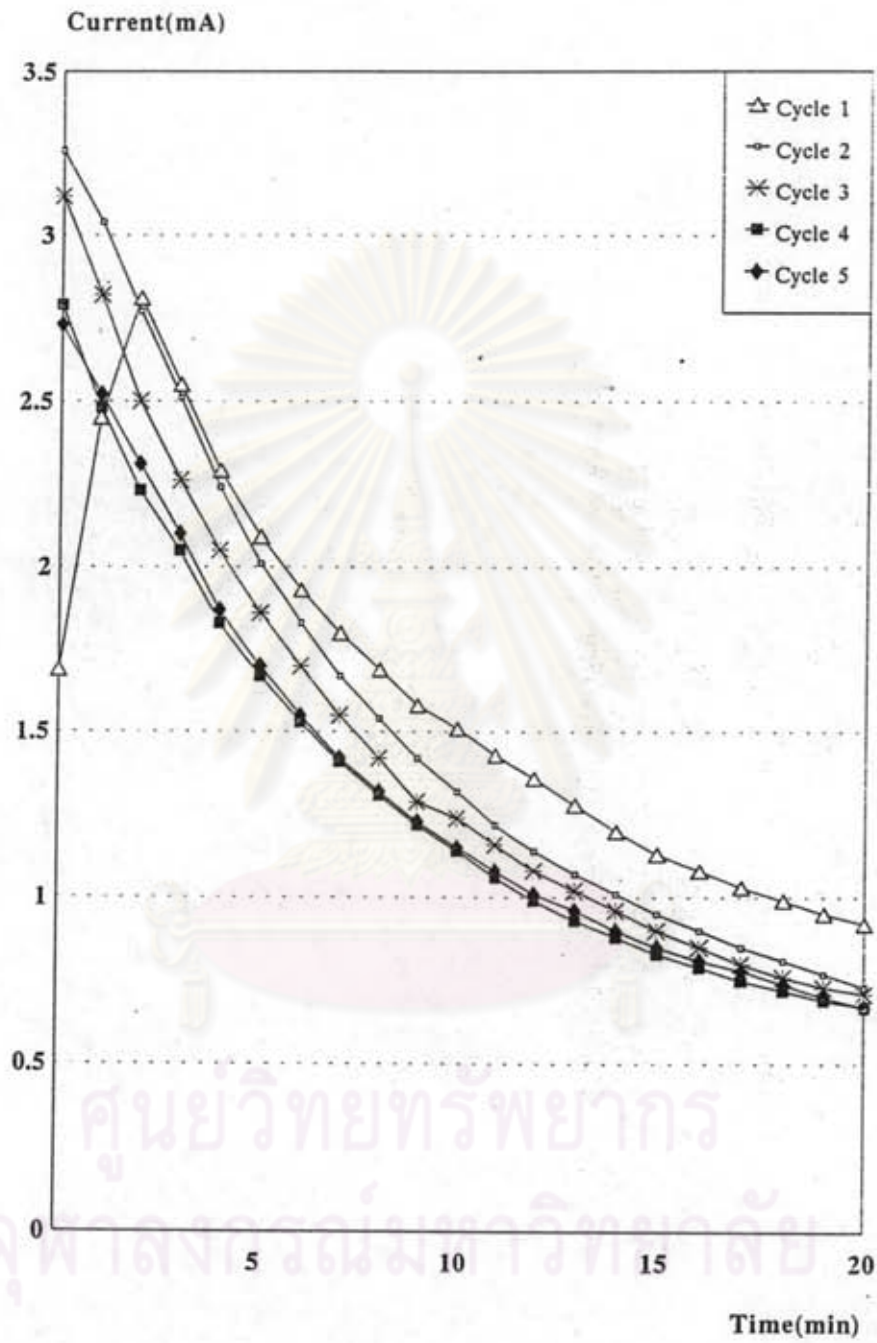

Figure 4.12 Discharging current curve of battery type D

The o.c.v. of battery was shown in Table 4.14, From the discharging characteristic in Figure 4.12, the discharging current of the first cycle was different to that of other cycles, especially at the early discharging time.

For the first discharging cycle, the current was increased until maximum and decreased. This current resulted from the discharging process which proceeded as the Equations 4.27-4.28

The first discharging process: at the negative electrode



at the positive electrode

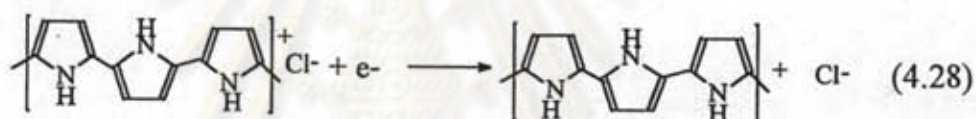

The electron from the negative lithium electrode moves along a circuit to replace  $\text{Cl}^-$  in the polypyrrole positive electrode, and the counterion  $\text{Cl}^-$  was released from polypyrrole to the electrolyte.

When the discharging was stopped, the o.c.v. was measured. It decreased to 2.50 V. Afterwards, the fully charged battery was returned by charging with 3.5 V from power supply. The o.c.v. increased to 3.18 V. During the charging process, the electron from oxidation of polypyrrole associated with  $\text{Li}^+$  resulting Li to plate on the negative electrode. To maintain charge neutrality in the oxidized polypyrrole there must be an affiliation of both counterions  $\text{Cl}^-$  and  $\text{ClO}_4^-$  which came from the electrolyte. The charging reactions were shown in the Equations 4.29-4.30.



The charging process: at the negative electrode



at the positive electrode

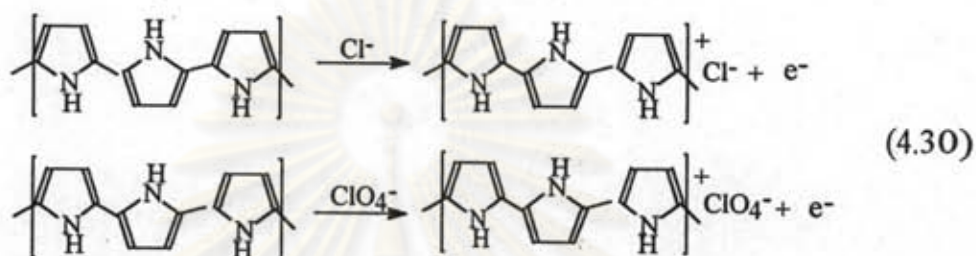

When the battery was discharged in the second cycle, the reversible charging reactions were operated and the decrease in current was observed. For the following cycles, the discharging and charging reactions were proceeded as the reactions in the second cycle.

Since the electrical conduction of polypyrrole was damaged by the oxidation of polypyrrole in the neutral form with oxygen in electrolyte solution. This oxidation occurred firstly from the surface to the inner of polypyrrole so the current in the early time was decreased with more discharging cycle. The oxidative of the surface of polypyrrole electrode could be observed as revealed in Figure 4.12. The current in the later period of battery type D, it largely decreased in the second cycle and gradually decreased in the others. At the fourth and fifth cycles this decreased was rather saturated.

In summary, the battery type D is rechargeable indicating that polypyrrole synthesized from chemical method can be used as the lectrode. However the battery is impracticable since the internal resistances are, too high as well, shown in Table 4.16.

**Table 4.13** Internal resistance before and after charging in each cycle of battery type D

Cycle	Internal resistance ( $\Omega$ )	
	before discharging	after discharging
1	1780	2707
2	966	3428
3	1009	3525
4	1123	3721
5	1155	3736

#### Comparing the Battery Performances between Battery using Polypyrrole Electrode from Chemical Synthesis and Electrochemical Synthesis

Battery type C using Eppy as positive electrode and the battery type D using Cppy as positive electrode. When the characteristic of both batteries were compared, the different performance in the first discharging cycle and the similar in the other cycles could be observed.

The first discharging cycle of battery type C showed the decrease in the high current but the current of battery type D increased until maximum and then decreased. The behavior occurred from the delay discharging reactions in battery type D since the polypyrrole electrode was not passed the electrochemical process so that reactions of polypyrrole synthesized from chemical method were difficultly excited. For the following cycles, the reactions on polypyrrole electrode more easily reacted so that the current characteristics of the both batteries were the same.

This means that Cppy can be used as positive electrode of rechargeable batteries in the same way as Eppy.



### **Polypyrrole-Lithium Battery type E and type F**

Batteries type E and F were designed in order to lower the internal resistance by increasing the surface area and decreasing the distance between positive and negative electrodes. These batteries were assembled under an argon atmosphere which was operated in the same manner as described before. In these experiments, a 99.999 % of argon gas was supplied through the box for 11 times of the box volume. An argon atmosphere was maintained by continuously supplying a slow current of argon gas to the box. After that, polypyrrole plate (1x4 cm), obtained from pressing Cppy powder with a 8 tons of hydraulic force for 10 min, was mounted as positive electrode in battery cell. One polypyrrole plate used in battery type E and two polypyrrole plates used in battery type F. The distance between positive and negative electrodes of battery type E and F were 0.3 cm and 0.2 cm, respectively. The negative electrode was lithium metal and electrolyte solution was a 1 M  $\text{LiClO}_4$  in PC. The construction details were shown in Figure 4.13. After the battery cell constructions were completed, they were repeatedly discharged and charged and the results were shown in Tables 4.17-4.20.

ศูนย์วิทยทรัพยากร  
จุฬาลงกรณ์มหาวิทยาลัย



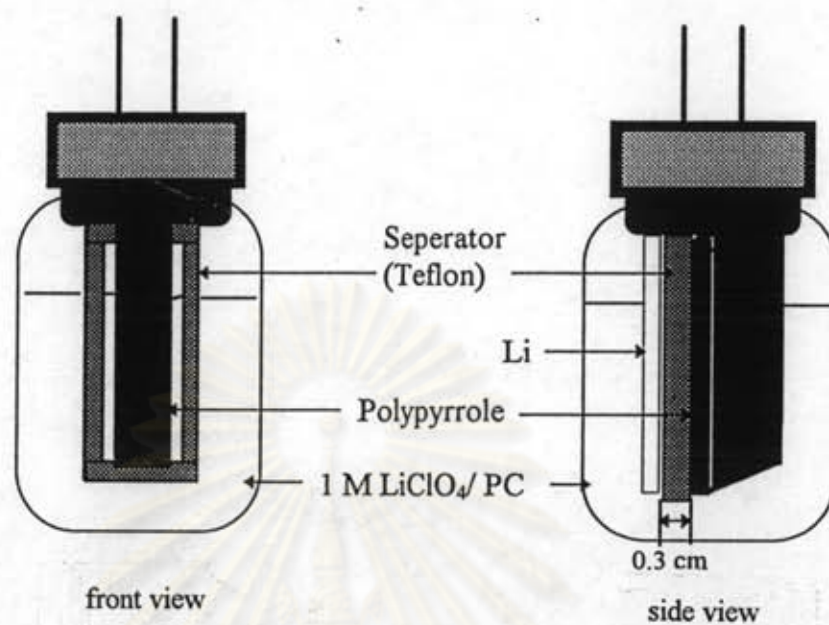

polypyrrole-lithium battery type E

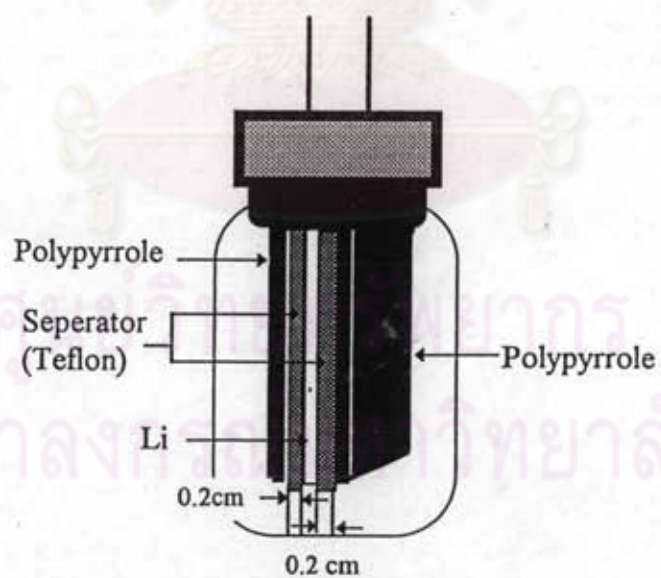

polypyrrole-lithium battery type F

Figure 4.13 Construction details of polypyrrole-lithium type E and F

**Table 4.17** The open-circuit voltage of battery type E

Discharging cycle	open-circuit voltage (V)	
	before discharging	after discharging
1	3.06	2.59
2	3.18	2.60
3	3.18	2.60
4	3.18	2.60
5	3.19	2.60

**Table 4.18** The open-circuit voltage of battery type F

Discharging cycle	open-circuit voltage (V)	
	before discharging	after discharging
1	3.06	2.61
2	3.19	2.62
3	3.20	2.62
4	3.20	2.63
5	3.19	2.61

The o.c.v. of battery cells type E and F in Tables 4.17-4.18 and the current curves in Figures 4.14-4.15 revealed that their performances of the discharging and charging processes were similar to that of battery D. Their first discharging current curve was gradually increased until maximum and then decreased. This is because of the delay discharging reaction, since polypyrrole electrode from chemical synthesis was not experienced the electrochemical process before so the first reaction was difficult to initiate. The other discharging current curves can be interpreted that the high current was decreased because polypyrrole electrode reacted easier.

**Table 4.19** The discharging current and total electrical charge of battery type E

Time (min)	Discharging Current (mA)				
	Cycle 1	Cycle 2	Cycle 3	Cycle 4	Cycle 5
0	15.0	81.4	73.6	68.5	65.7
1	46.1	68.2	61.6	58.3	50.8
2	51.3	62.3	56.8	54.2	47.2
3	51.0	57.9	53.3	50.8	44.3
4	47.6	54.0	50.1	47.7	41.8
5	44.7	50.9	47.5	45.2	39.7
6	41.4	48.3	45.6	42.9	38.3
7	38.4	45.9	43.6	40.8	36.8
8	35.3	43.7	41.6	39.1	35.4
9	33.1	41.7	39.7	37.4	33.9
10	31.1	39.9	37.8	36.2	32.5
11	29.2	37.2	36.2	35.0	31.0
12	27.4	36.7	34.8	33.7	29.6
13	25.8	35.2	32.5	32.5	28.7
14	24.1	33.7	31.1	31.5	28.1
15	23.1	32.3	30.4	30.4	27.3
16	22.1	30.9	29.4	29.4	26.8
17	21.1	29.5	28.5	28.5	26.1
18	20.2	28.1	27.6	27.6	25.5
19	19.4	26.7	26.7	26.7	25.0
20	18.7	25.4	25.9	25.9	24.4
21	18.1	24.1	25.1	25.1	23.8
22	17.5	22.8	24.3	24.3	23.3
23	17.0	21.5	23.5	23.5	22.8
24	16.5	20.2	22.1	22.7	22.2
25	16.0	18.9	21.2	21.9	21.8
26	15.5	17.6	20.3	21.6	21.3
27	15.1	16.3	19.4	21.1	20.8
28	14.7	15.0	18.5	20.3	20.2
29	14.3	13.7	17.8	19.5	19.7
30	14.0	12.4	17.0	18.7	19.2
<b>Total electrical charge (C)</b>	<b>48.62</b>	<b>62.79</b>	<b>61.09</b>	<b>59.84</b>	<b>54.69</b>



Table 4.20 The discharging current and total electrical charge of battery type F

Time (min)	Discharging Current (mA)				
	Cycle 1	Cycle 2	Cycle 3	Cycle 4	Cycle 5
0	54.2	265.2	244.3	236.3	201.6
1	112.2	240.2	202.3	204.1	180.6
2	144.2	205.2	185.2	174.1	161.3
3	152.4	186.7	166.7	160.7	151.7
4	150.1	172.5	156.5	150.5	143.4
5	143.0	162.7	150.0	144.0	137.1
6	136.8	157.5	145.5	139.5	131.2
7	131.1	152.0	140.0	135.3	128.3
8	125.9	147.7	136.0	131.3	125.3
9	120.9	143.1	132.2	127.5	122.2
10	116.0	138.7	128.6	123.9	119.0
11	111.2	134.5	125.2	120.5	116.5
12	106.5	130.6	122.0	117.3	114.0
13	101.9	126.8	119.0	114.3	111.8
14	97.4	123.1	116.2	111.5	109.6
15	93.0	119.5	113.6	108.9	107.2
16	88.7	116.4	111.1	106.5	105.0
17	86.5	112.6	108.7	104.3	103.4
18	84.4	109.3	106.4	102.3	100.7
19	82.3	106.1	104.2	100.5	99.5
20	80.1	103.5	102.1	97.1	97.3
21	79.2	100.4	100.1	95.6	95.3
22	77.3	97.1	98.2	94.2	93.8
23	76.5	94.3	96.4	92.9	92.6
24	75.0	91.6	94.7	91.8	91.7
25	73.5	89.1	93.1	89.9	91.2
26	72.0	86.5	91.6	89.1	90.8
27	71.0	84.1	90.2	88.4	90.5
28	70.2	81.8	88.8	87.8	90.2
29	69.3	79.6	87.4	87.3	89.9
30	68.2	77.5	86.1	86.9	89.6
31	67.9	75.5	84.9	86.6	89.4
32	65.8	73.6	83.8	86.4	89.2
33	65.0	71.8	82.8	86.3	79.0
34	64.2	70.1	81.9	86.2	88.8
35	62.8	68.5	81.1	86.1	88.6
36	62.2	67.0	80.4	86.0	88.4
37	61.3	65.6	79.8	86.0	88.3
38	60.5	64.3	79.3	85.9	88.2
39	59.8	63.1	78.9	85.9	88.2
40	59.1	62.0	78.7	85.8	88.2
41	58.6	61.0	78.6	85.8	88.0
42	56.0	60.1	78.5	85.7	88.0
43	55.5	59.3	78.4	85.7	87.9
44	55.0	58.6	78.3	85.6	87.9
45	54.6	58.0	78.3	85.6	87.8
<b>Total electrical charge (C)</b>	<b>234.29</b>	<b>294.17</b>	<b>293.09</b>	<b>290.58</b>	<b>285.80</b>

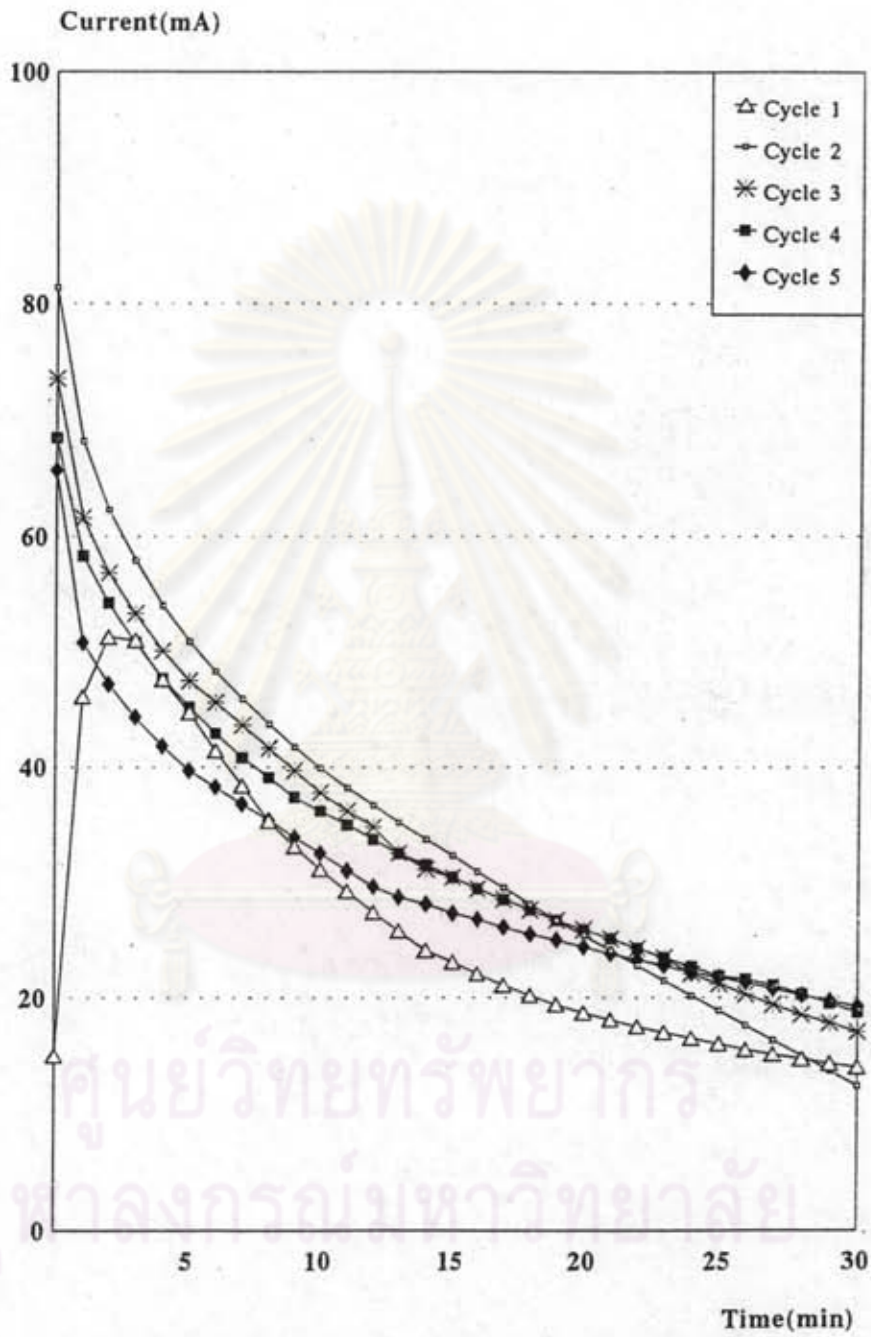

Figure 4.14 Discharging current curve of battery type E

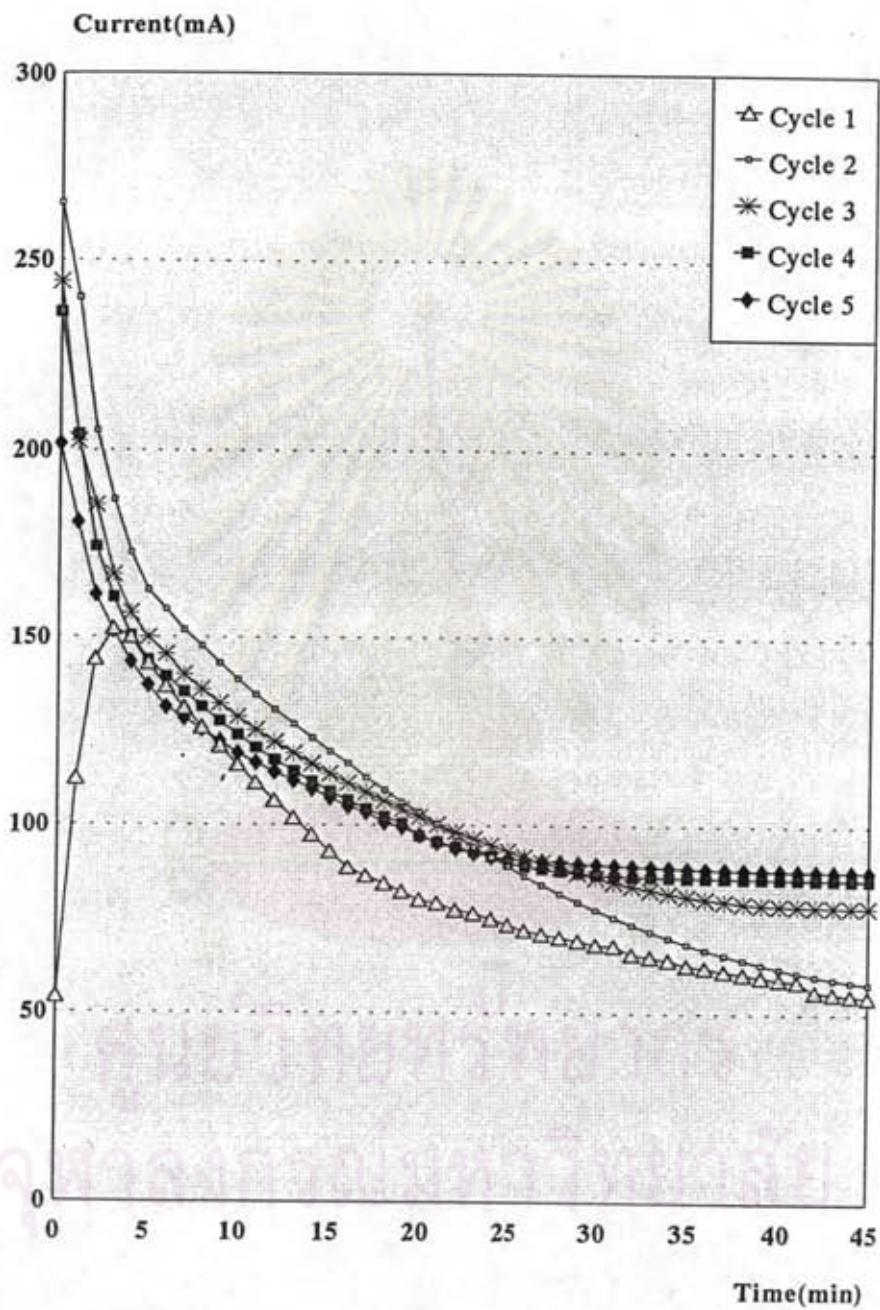

Figure 4.15 Discharging current curve of battery type F



For the other discharging cycles, the decreasing of current in the early time of battery type E and F occurred from the damage of polypyrrole at the surface of electrode. In later discharging cycles, the current at long discharging time gradually increased. This may be because more and more inner polypyrrole was participated in electrochemical process.

From internal resistance Tables 4.21-4.22, It is clear that the internal resistance could be largely reduced by increasing surface area of polypyrrole electrode by decreasing the distance between the positive and negative electrodes of batteries.

**Table 4.21** The internal resistance before discharging in each cycle of battery type D, E and F

Cycle	Internal resistance ( $\Omega$ )		
	D	E	F
1	1789	191	46.1
2	966	29	2.0
3	1009	33	3.1
4	1123	46	3.5
5	1155	49	5.8

**Table 4.22** The internal resistance after discharging in each cycle of battery type D, E and F

Cycle	Internal resistance ( $\Omega$ )		
	D	E	F
1	2707	175	37.8
2	3428	200	35.2
3	3525	143	23.5
4	3721	129	20.7
5	3736	125	19.7

### The Charge Quantity of Polypyrrole-Lithium Battery

For the battery type F, the weight of two polypyrrole electrodes was 1.01 g. The 3/4 of polypyrrole electrodes were dipped in the electrolyte solution so that 0.76 g [= (3/4) x 1.01] of polypyrrole concerned with the charge supply. With the discharging process, one electron is given by three units of pyrrole and one unit of Cl<sup>-</sup>. The molecular weight of the three pyrrole units and one Cl<sup>-</sup> was 236.5. A 1.6x10<sup>-19</sup> C of charge given by one electron so the charge from 0.76 g of polypyrrole was 308 C [= (0.76g x 1.6x10<sup>-19</sup>C)/(237.5x1.66x10<sup>-24</sup>g)]. From the first discharging curve of battery type F, the charge supplied was 234 C, approximately 76 percent [= (234/308) x 100] of the maximum charge supplied of electrode.

### Some Problems of Polypyrrole-Lithium Battery

From the performance of polypyrrole-lithium rechargeable battery, several problems were found. When the battery was repeatedly discharged and charged several times, the shape of chemical synthesized polypyrrole electrode was distorted and the lithium plate was swelled up. Therefore, when the distance between positive and negative electrodes was decreased, both electrodes may become in contact causing the shorted circuit of battery finally. The distorted figure of polypyrrole occurred from the association to polypyrrole by the ClO<sub>4</sub><sup>-</sup> which has a larger structure than the Cl<sup>-</sup>. The lithium plate was swelled since the lithium metal formed the crystal.

## Conclusion

In this research, polypyrrole synthesized by both the electrochemical and the chemical methods could be used as a positive electrode in a rechargeable batteries, lithium metal and lithium perchlorate in propylene carbonate were used as a negative electrode and electrolyte solution, respectively. From the results, both types of batteries are rechargeable so that polypyrrole synthesized from chemical method can use as electrode material in rechargeable battery similarly to polypyrrole synthesized from electrochemical method. In comparison, the battery-performances of both types is different only in the first discharging cycle but similarly in subsequence runs. The high internal resistance of these batteries can be lowered by increasing surface area of polypyrrole electrode and decreasing the distance between positive and negative electrodes. However, there was a damage of polypyrrole electrode due to the oxidation by remained oxygen in electrolyte solution which causes the deformation of polypyrrole and lithium electrodes.



ศูนย์วิทยทรัพยากร  
จุฬาลงกรณ์มหาวิทยาลัย