

การตัดแปรพื้นผิวของนอนนุฟเวนพอลิโพรพิลีนด้วยเครื่องพลาสมาโฟกัส
เพื่อการลามีเนตกับนอนนุฟเวนพอลิเอสเตอร์และฝ้าย



นายเจษฎางค์ ศรีสวัสดิ์

สถาบันวิทยบริการ

จุฬาลงกรณ์มหาวิทยาลัย

วิทยานิพนธ์นี้เป็นส่วนหนึ่งของการศึกษาตามหลักสูตรปริญญาวิทยาศาสตรมหาบัณฑิต
สาขาวิชาวิทยาศาสตร์พอลิเมอร์ประยุกต์และเทคโนโลยีสิ่งทอ ภาควิชาวัสดุศาสตร์

คณะวิทยาศาสตร์ จุฬาลงกรณ์มหาวิทยาลัย

ปีการศึกษา 2547

ISBN 974-53-1589-3

ลิขสิทธิ์ของจุฬาลงกรณ์มหาวิทยาลัย

SURFACE MODIFICATION OF POLYPROPYLENE NONWOVEN USING A PLASMA FOCUS DEVICE
FOR LAMINATION WITH POLYESTER AND COTTON NONWOVEN

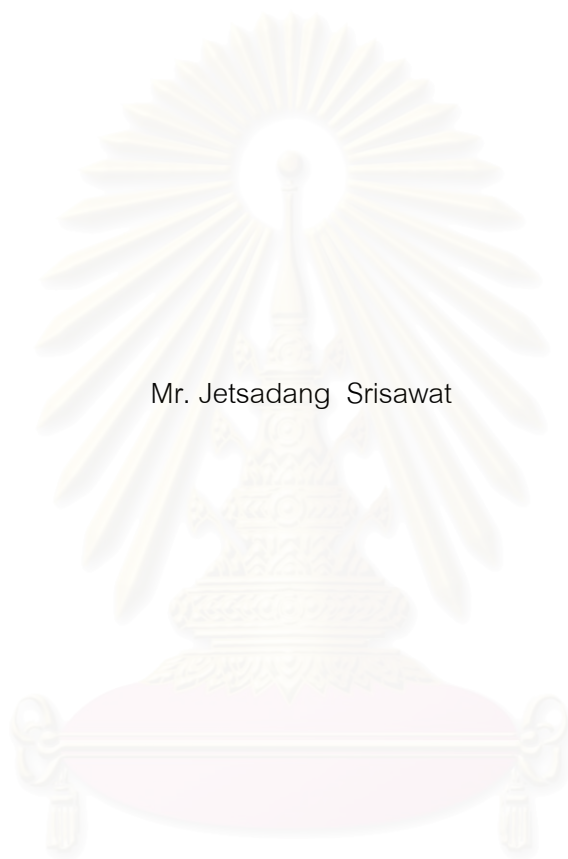

Mr. Jetsadang Srisawat

สถาบันวิทยบริการ
จุฬาลงกรณ์มหาวิทยาลัย
A Thesis Submitted in Partial Fulfillment of the Requirements
for the Degree of Master of Science in Applied Polymer Science and Textile Technology

Department of Materials Science

Faculty of Science

Chulalongkorn University

Academic year 2004

ISBN 974-53-1589-3

นาย เจษฎางค์ ศรีสวัสดิ์ : การดัดแปรพื้นผิวของนอนวูฟเวนพอลิโพรพิลีนด้วยเครื่องพลาสมาโฟกัสเพื่อการลามิเนตกับนอนวูฟเวนพอลิเอสเตอร์และฝ้าย. (SURFACE MODIFICATION OF POLYPROPYLENE NONWOVEN USING A PLASMA FOCUS DEVICE FOR LAMINATION WITH POLYESTER AND COTTON NONWOVEN) อ. ที่ปรึกษา : ผศ.ดร.วิมลวรรณ พิมพ์พันธุ์, อ.ที่ปรึกษาร่วม : ผศ.ดร.รัฐชาติ มงคลนาวิน 96 หน้า. ISBN 974-53-1589-3.

งานวิจัยนี้เสนอแนวทางใหม่ในการประยุกต์เครื่องพลาสมาโฟกัสแบบ UNU/ICTP มาใช้ดัดแปรพื้นผิวของพอลิเมอร์ เพื่อเพิ่มความสามารถในการยึดติดระหว่างองค์ประกอบของวัสดุเชิงประกอบ โดยนำนอนวูฟเวนพอลิโพรพิลีนมาดัดแปรพื้นผิวด้วยเครื่องพลาสมาโฟกัส ซึ่งทำงานภายใต้บรรยากาศของแก๊สไนโตรเจน ที่ความดัน 1.5 มิลลิบาร์ โดยเปลี่ยนแปลงจำนวนครั้งของการยิงพลาสมาตั้งแต่ 1 ถึง 5 ครั้ง เครื่องพลาสมาโฟกัสทำให้เกิดพลาสมาไนโตรเจนที่ว่องไวต่อปฏิกิริยา ซึ่งเคลื่อนเข้าชนพื้นผิวของผ้าด้วยอัตราเร็วเหนือเสียง จากการวิเคราะห์ด้วยค่ามุมสัมผัสของน้ำและสมบัติการดูดซับน้ำของนอนวูฟเวนพอลิโพรพิลีนพบว่า การดัดแปรพื้นผิวทำให้สมบัติความชอบน้ำของพอลิโพรพิลีนเพิ่มขึ้น เมื่อนำนอนวูฟเวนพอลิโพรพิลีนกับนอนวูฟเวนพอลิเอสเตอร์และฝ้าย มาลามิเนตด้วยกระบวนการอัดแบบ ณ อุณหภูมิ 190 องศาเซลเซียส เป็นเวลา 12 นาที โดยใช้อัตราส่วนของนอนวูฟเวนพอลิโพรพิลีนต่อนอนวูฟเวน พอลิเอสเตอร์และฝ้ายเป็น 95:5, 90:10, 85:15 และ 80:20 ตามลำดับ ได้วัสดุเชิงประกอบพอลิโพรพิลีน-พอลิเอสเตอร์/ฝ้าย จากการศึกษาพบว่า สมบัติด้านแรงดึงและสมบัติด้านแรงดัดโค้งของวัสดุเชิงประกอบซึ่งเตรียมจากพอลิโพรพิลีนที่ผ่านการดัดแปรพื้นผิวมีค่าสูงกว่าของวัสดุเชิงประกอบซึ่งเตรียมจากพอลิโพรพิลีนที่ไม่ผ่านการดัดแปรพื้นผิว ในขณะที่ความทนแรงกระแทกของวัสดุเชิงประกอบทั้งสองกลุ่มมีค่าใกล้เคียงกัน นอกจากนี้ยังพบว่า วัสดุเชิงประกอบที่เตรียมจากนอนวูฟเวนพอลิโพรพิลีนซึ่งดัดแปรพื้นผิวด้วยการยิงพลาสมา 4 ครั้ง และนอนวูฟเวนพอลิเอสเตอร์/ฝ้าย 20 เปอร์เซ็นต์โดยน้ำหนัก มีสมบัติเชิงกลดีที่สุด

ภาควิชาวัสดุศาสตร์

สาขาวิชาวิทยาศาสตร์พอลิเมอร์ประยุกต์ฯ

ปีการศึกษา 2547

ลายมือชื่อนิสิต.....

ลายมือชื่ออาจารย์ที่ปรึกษา.....

ลายมือชื่ออาจารย์ที่ปรึกษาร่วม.....

4672237023 : MAJOR APPLIED POLYMER SCIENCE AND TEXTILE TECHNOLOGY

KEY WORD: SURFACE MODIFICATION / PLASMA FOCUS / POLYPROPYLENE / POLYESTER/COTTON / LAMINATION

JETSADANG SRISAWAT: SURFACE MODIFICATION OF POLYPROPYLENE NONWOVEN USING A PLASMA FOCUS DEVICE FOR LAMINATION WITH POLYESTER AND COTTON NONWOVEN. THESIS ADVISOR : ASST.PROF. VIMOLVAN PIMPAN, Ph.D. THESIS COADVISOR : ASST.PROF. RATTACHAT MONGKOLNAVIN, Ph.D. 96 pp. ISBN 974-53-1589-3.

The research presents a novel application of a UNU/ICTP plasma focus device for modifying the surface of a polymer in order to improve the adhesion between the components of a composite material. Polypropylene (PP) nonwoven was surface-modified using a plasma focus device operated with nitrogen gas at a pressure of 1.5 mbar. The number of plasma shots was varied from 1 to 5 shots. The plasma focus device produced reactive nitrogen plasma which bombarded the surface of the fabric at a supersonic speed. From water contact angle analysis and water absorption of PP nonwoven, it was found that surface modification by plasma caused an increase in hydrophilicity of PP. The lamination of PP and polyester/cotton (PET/C) nonwovens were carried out by compression molding at 190°C for 12 minutes to obtain PP-PET/C composites. The weight ratios of PP nonwoven to PET/C nonwoven were varied from 95:5, 90:10, 85:15 to 80:20. It was found that tensile and flexural properties prepared from surface-modified PP were higher than those of the composites prepared from the unmodified one. However, impact strength of both composites was comparable. The results also revealed that the composite prepared from PP nonwoven surface-modified with 4 plasma shots and PET/C nonwoven 20% by weight exhibited the optimum mechanical properties.

Department Materials Science

Student's signature.....

Field of study Applied Polymer Science and Textile Technology Advisor's signature.....

Academic year 2004

Co-advisor's signature.....

ACKNOWLEDGEMENTS

The author would like to express his deep gratitude to his thesis advisor, Assistant Professor Dr. Vimolvann Pimphan, thesis coadvisor and Assistant Professor Dr. Rattachat Mongkolnavin for their kindly reviewing this manuscript, moreover, for their motivation, understanding, and chances giving to the author. Without them, this research could not be complete.

The author also would like to extend his respectfully gratitude to Associate Professor Saowaroj Chuayjuljit, Associate Professor Paiparn Santisuk, and Associate Professor Werasak Udomkichdecha for their kindly participation as thesis committee and for their valuable comments, suggestions and time to read this thesis.

The author also grateful to Mr. Dusit Ngamrungraj and Mr. Pairud Kamsing for their help in operation of plasma focus device.

The author sincerely thank to Mölnlycke Health Care (Thailand) Limited for providing polypropylene nonwoven and polyester nonwoven.

Thanks go towards staffs at Scientific and Technological Research Equipment Center (STREC) and Silpakorn University for their assistance in SEM and Impact test, respectively.

The author wishes to extend his heartfelt gratefulness and appreciation to all lecturers and staffs at the Department of Materials Science, Faculty of Science, Chulalongkorn University. Their kindness will be impressed so far.

Special thanks to all his friends and everyone whose names are not mentioned here for their friendship, love, assistance, motivation and also inspiration. These are much valuable and meant a lot to his.

Finally, and the most of all, the author would like to express his appreciation to his family for their unconditionally love, moral support and understanding in the author self. His family impresses in his mind always and forever.

CONTENTS

	Page
ABSTRACT (THAI).....	iv
ABSTRACT (ENGLISH).....	v
ACKNOWLEDGEMENTS.....	vi
CONTENTS.....	vii
LIST OF TABLES.....	x
LIST OF FIGURES.....	xi
CHAPTER I INTRODUCTION.....	1
CHAPTER II THEORY AND LITERATURE SURVEY.....	3
2.1 Composite Materials.....	3
2.1.1 Classification of Composite Materials.....	3
2.1.1.1 Particulate-reinforced Composites.....	3
2.1.1.2 Fiber-reinforced Composites.....	4
2.1.1.3 Laminar Composites.....	4
2.1.2 Matrix Materials.....	4
2.1.2.1 Polypropylene.....	5
2.1.3 Reinforcing Fillers.....	7
2.1.3.1 Polyester Fibers.....	12
2.1.3.2 Cotton.....	14
2.1.4 Literature Survey on Polypropylene Composites.....	16
2.2 Surface Modification of Polymeric Materials.....	18
2.2.1 Surface Modification by Chemical Methods.....	18
2.2.2 Surface Modification by Physical Methods.....	22
2.3 Plasma Technology for Surface Modification of Polymeric Materials.....	23
2.3.1 Plasma State.....	23
2.3.2 Classification of Plasma.....	24
2.3.2.1 Cold Plasmas (Non-equilibrium Plasmas).....	24
2.3.2.2 Hot Plasmas.....	25

	Page
2.3.3 Plasma Focus.....	25
2.3.3.1 The Dynamic of the Plasma Focus.....	26
2.3.4 Literature Survey on Surface Modification of Polymer by Plasma Treatment.....	27
 CHAPTER III EXPERIMENT.....	31
3.1 Materials.....	31
3.1.1 Polypropylene (PP) Nonwoven.....	31
3.1.2 Polyester and Cotton (PET/C) Nonwoven.....	31
3.2 Machines and Equipments.....	32
3.3 Methodology.....	33
3.3.1 Surface Modification of Polypropylene Nonwovens.....	34
3.3.2 Characterization of Surface-modified and Unmodified Polypropylene Nonwovens.....	35
3.3.2.1 Morphological Analysis.....	35
3.3.2.2 Contact Angle Measurement.....	35
3.3.2.3 Determination of Water Absorption.....	35
3.3.2.4 Chemical Structural Analysis.....	36
3.3.3 Preparation of Polypropylene-Polyester/Cotton Composites.....	37
3.3.4 Mechanical Testing of Polypropylene-Polyester/Cotton Composites.....	37
3.3.4.1 Tensile Properties.....	37
3.3.4.2 Flexural Properties.....	39
3.3.4.3 Impact Strength.....	40
3.3.5 Morphological Analysis of Polypropylene-Polyester/Cotton Composites.....	41

	Page
CHAPTER IV RESULTS AND DISCUSSION	42
4.1 Characteristics of Surface-modified and Unmodified Polypropylene Nonwovens.....	42
4.1.1 Morphology.....	42
4.1.2 Water Contact Angle.....	46
4.1.3 Water Absorption.....	47
4.1.4 Chemical Structure.....	48
4.2 Mechanical Properties of Polypropylene-Polyester/Cotton Composites.....	50
4.2.1 Tensile Properties.....	50
4.2.2 Flexural Properties.....	53
4.2.3 Impact Strength.....	56
4.3 Morphology Studies of Polypropylene-Polyester/Cotton Composites.....	56
CHAPTER V CONCLUSIONS AND RECOMMENDATIONS.....	58
5.1 Conclusions.....	58
5.2 Recommendations.....	59
REFERENCES.....	60
APPENDICES	63
Appendix A.....	64
Appendix B.....	92
BIOGRAPHY.....	96

LIST OF TABLES

Table	Page
2.1 Mechanical properties of natural fibers and glass fiber.....	11
2.2 Chemical treatment used for modification of natural fibers.....	20
4.1 Water contact angles of unmodified and modified polypropylene nonwovens.....	46



สถาบันวิทยบริการ
จุฬาลงกรณ์มหาวิทยาลัย

LIST OF FIGURES

Figure	Page
2.1 Polypropylene structure (a) Isotactic (b) Syndiotactic (C) Atactic.....	7
2.2 Chemical structure of Kevlar.....	10
2.3 Cotton fibers (a) Cross-section, (b) Longitudinal section.....	15
2.4 Plasma – the 4 th state of matter.....	24
2.5 Diagrams showing four phases of plasma focus formation.....	27
3.1 Polypropylene nonwoven.....	31
3.2 Polyester and cotton nonwoven.....	31
3.3 Flow chart of experimental procedure	33
3.4 UNU/ICTP plasma focus device.....	34
3.5 Sample position in the chamber of UNU/ICTP plasma focus device.....	34
3.6 Cam-Plus Tantac contact angle meter.....	35
3.7 Attenuated total reflection/fourier transform infrared spectroscopy.....	36
3.8 Compression molding machine	37
3.9 A LLOYD Universal testing machine model LR 100K.....	38
3.10 Schematic of tensile test specimen (type IV).....	38
3.11 A LLOYD Universal testing machine model 500.....	39
3.12 Schematic of flexural test specimen.....	39
3.13 A Zwick 5102 Pendulum impact tester (Izod-type).....	40
3.14 Schematic of Izod-type test specimen.....	40
3.15 A Joel JSM-6400 scanning electron microscope.....	41
4.1 Surfaces of unmodified polypropylene nonwoven (a) and modified polypropylene nonwovens using plasma focus at 1 shot (b), 2 shots (c), 3 shots (d), 4 shots (e) and 5 shots (f).....	43
4.2 SEM photographs at 50X of the surfaces of unmodified polypropylene nonwoven (a) and modified polypropylene nonwovens using plasma focus at 1 shot (b), 2 shots (c), 3 shots (d), 4 shots (e) and 5 shots (f).....	44
4.3 SEM photographs at 500X of the surfaces of unmodified polypropylene nonwoven (a) and modified polypropylene nonwovens using plasma focus at 1 shot (b), 2 shots (c), 3 shots (d), 4 shots (e) and 5 shots (f).....	45

Figure	Page
4.4	Water absorption of unmodified polypropylene nonwoven and modified polypropylene nonwovens using plasma focus at 1, 3 and 4 shots.....47
4.5	ATR/FT-IR spectra of unmodified polypropylene nonwoven (a) and modified polypropylene nonwovens using plasma focus at 1 shot (b), 3 shots (c) and 4 shots (d).....49
4.6	Tensile strength of pure polypropylene and polypropylene-polyester/cotton composites.....50
4.7	% Elongation of pure polypropylene and polypropylene-polyester/cotton composites.....51
4.8	Young's modulus of pure polypropylene and polypropylene-polyester/cotton composites.....52
4.9	Flexural strength of pure polypropylene and polypropylene-polyester/cotton composites.....53
4.10	Deformation at maximum load of pure polypropylene and polypropylene-polyester/cotton composites.....54
4.11	Flexural modulus of pure polypropylene and polypropylene-polyester/cotton composites.....55
4.12	Impact strength of pure polypropylene and polypropylene-polyester/cotton composites..... 56
4.13	SEM micrographs of impact fractured surface of 20% PET/C-filled composites prepared from unmodified PP nonwoven (a) and modified polypropylene nonwovens using plasma focus at 1 shot (b), 3 shots (c) and 4 shots (d).....57

CHAPTER I

INTRODUCTION

The utilization of plastics and plastic-based composites has tremendously increased in recent years. Many materials such as metal, glass and wood have been replaced by plastics and plastic-based composites due to their superior properties including processing varieties, light-weight and durable in environment. Furthermore, their properties can be easily modified as desired by adding appropriate additives. For example, to improve the mechanical properties of a plastic, reinforcing fillers such as synthetic or natural fibers are added and a fiber-reinforced composite is formed.

However, the most important consideration in preparation of a fiber-reinforced composite is the fiber-matrix adhesion. The role of the matrix in a fiber-reinforced composite is to transfer the load to the stiff fibers through shear stresses at the interface. This process requires a good adhesion between the polymeric matrix and the fibers. Poor adhesion at the interface means that the full capabilities of the composite cannot be exploited and leaves it vulnerable to environmental attacks that may weaken it, thus reducing its life span. Insufficient adhesion between hydrophobic polymer and hydrophilic fiber results in poor mechanical properties of the fiber reinforced polymer composites. Therefore, surface modification of the matrix or the reinforcing fibers before incorporation in a composite is necessary in order to improve the fiber-matrix adhesion and consequently, enhance the mechanical properties of that composite. Many reports have shown that surface modification can be done by many methods.

Plasma treatment is one of the frequently used methods for the improvement of adhesion and wettability of polymeric materials. Plasma generators permit good control of the treatment process, low-cost treatments and low environmental pollution. Plasma can be divided into cold plasma and hot plasma. Previous researches generally have emphasized on using cold plasma generated from several devices for surface modification of the polymers. Since the plasma producing processes of these devices

normally continuous and difficult to control, it is often that the polymers are overexposed and this results in polymer degradation.

Therefore, in this research, an application of hot plasma discontinuously generated as a plasma shot is studied. Polypropylene in a form of nonwoven fabric is surface-modified using a plasma focus device before laminating with polyester/cotton nonwoven by compression molding to form polypropylene-polyester/cotton composites. The principle of plasma focus is that the inner gas is ionized into ions due to the difference in voltage between anode and cathodes of 13 kV. Then generated plasma moves to the surface of a material. Plasma focus device releases high energy plasma in shots and it differs from other plasma generators which produce continuous and lower energy plasma. This research also focus on the effects of surface modification of polypropylene nonwoven and polyester/cotton nonwoven content on the mechanical properties of the prepared composites by varying the numbers of plasma shots in modification process and the ratios of those nonwovens in the composites, respectively.



สถาบันวิทยบริการ
จุฬาลงกรณ์มหาวิทยาลัย

CHAPTER II

THEORY AND LITERATURE SURVEY

2.1 Composite Materials

Composite materials can be defined as a complex solid material consisting of two constituent materials, generally divided as a continuous phase called a matrix and a discontinuous phase called reinforcing filler [1]. Composites are generally used because they have desirable properties which could not be achieved by either of the constituent materials acting alone.

The matrix generally performs the function of a binder to transfer stress to the reinforcing filler and ensure their cooperative interaction. The matrix may be metals, ceramics and polymers. Both thermosets and thermoplastics can be used as the matrix for polymer-based composites. Reinforcing fillers give strength and stiffness to the composites.

2.1.1 Classification of Composite Materials

Composites can be divided into classes in many manners. One simple classification is based on the forms of the reinforcing fillers [2-3].

2.1.1.1 Particulate-reinforced Composites

Particulate-reinforced composites consist of reinforcing filler particles dispersed in a matrix. The form of a reinforcing filler is considered to be a "particle" if all of its dimensions are roughly equal. Particulates may have any shape, configuration, or size. They may be powder, beads or rods, etc. They may be metallic, ceramic, or natural materials. Concrete and wood particle boards are two familiar examples of particulate composites. Pieces of ceramic particles are placed in a metallic matrix and used as tough, abrasion resistant cutting tools. Metallic flakes have been added to improve

electrical properties and provide some degree of radiation shielding in polymer composites.

2.1.1.2 Fiber-reinforced Composites

Fiber-reinforced composites compose of fibrous reinforcing filler in a matrix. This type of reinforcing fillers has its length greater than its cross-sectional dimension. These composites can be further divided into those containing discontinuous and continuous fibers. In the case of discontinuous fiber, the interaction between the fiber and the matrix is broken at the fiber's ends, which thus carry less stress than at the middle part of the fiber. Therefore, continuous fiber can carry stress along its length.

2.1.1.3 Laminar Composites

Laminar composites consist of the layers of materials held together by matrix. Complicating the definition of a composite as having both continuous and discontinuous phases is the fact that in a laminar composite, neither of these phases may be regarded as truly continuous in these dimensions.

2.1.2 Matrix Materials

Widely used matrix materials for composites are polymeric materials. For example, in fiber-reinforced composites, the purpose of using a polymer as a matrix is to hold the fibers together so that mechanical loads can transferred from the weak matrix to the strong fibers. In addition, polymer matrix protects the fibers from handling damages and environmental degradation and, in many cases, contributes some properties such as ductility, toughness, or electrical insulation. Service temperature is often the main consideration in the selection of a matrix material as well as processing temperature during fabrication.

Polymer matrices can be either thermosets (e.g. epoxy, polyester and phenolic resins) or thermoplastics (e.g. polyimide, polysulfone, polyetherketone and polypropylene sulfide). Epoxy and polyester resins have been the most commonly used matrices for several decades, such as in fiberglass-based composites. These thermosetting resins offer a combination of low cost, versatility in many processes, and good property performance.

However, thermoplastics offer many advantages over thermosetting polymers such as flexibility, ease of molding complex parts and ease of processing. Simple methods including extrusion, injection, and compression molding can be used for processing of the thermoplastic-based composites. The forms of materials used can be pellet, bead, film, etc., depending on the processing methods. When natural fibers are used as reinforcing fillers, polyethylene (PE), polypropylene (PP), polystyrene (PS), and poly(vinyl chloride) (PVC) are often used as matrix materials because the processing temperature is restricted to the temperatures below 200°C to avoid thermal degradation of the natural fibers.

In this research, polypropylene was selected to be used as a matrix since the selected reinforcing fillers contained a natural fiber as will be discussed hereafter. General details in its synthesis and properties are given as follows. Polypropylene used was in the form of nonwoven fabric (PP nonwoven) because of its ease to process by compression molding. However, the information for preparation of PP nonwoven cannot be disclosed due to the policy of the company.

2.1.2.1 Polypropylene

Polypropylene is a thermoplastic polymer with low specific gravity, excellent chemical resistance, high melting point (relative to volume plastics), good stiffness/toughness balance, adaptability to many converting method, great range of special purpose grades, excellent dielectric properties, and low cost (especially per unit volume). It has gained wide acceptance in applications ranging from fibers and films to injection-molded parts for automobiles and food packaging [4]. More than 7 billion

pounds of polypropylene are produced annually in the United States. About 20% of this volume consists of copolymer, mostly copolymers containing 2–5% ethylene into the polymerization reactor. The resulting polymer has increased clarity, toughness and flexibility [5].

Although polypropylene has many useful properties, it is not intrinsically tough especially below its glass transition temperature. However, its impact resistance can be improved by adding elastomers usually ethylene/propylene rubber [6]. Numerous studies have been carried out that aim at improving PP toughness, stiffness, and strength balance. The addition of mineral fillers and reinforcing agents to the polymeric matrix reduces the cost of the material and enhances some of the mechanical properties.

Polypropylene is synthesized by placing propylene monomer under controlled conditions of heat and pressure in the presence of organometallic, stereospecific catalysts (Ziegler-Natta type) [5].

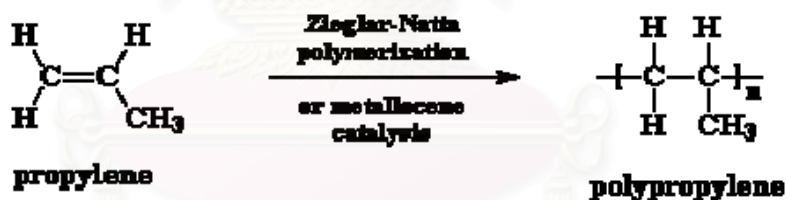

Depending on catalysts and polymerization processes used, the molecular structures of the resulting polypropylene consist of three different types of stereochemical configurations in varying amounts. As shown in Figure 2.1, these configurations are isotactic, syndiotactic, and atactic.

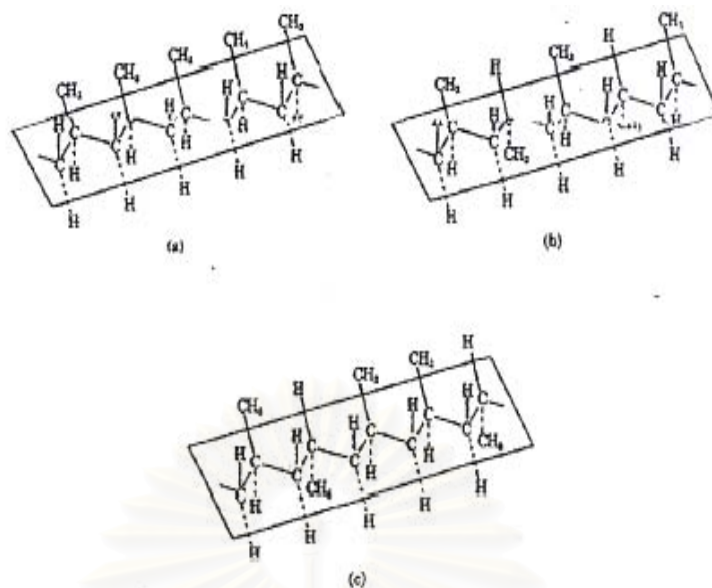

Figure 2.1 Polypropylene structures [7].

(a) Isotactic (b) Syndiotactic (c) Atactic

Commercial polypropylene usually contains 90-95% isotactic structure. In the products, atactic and syndiotactic structures may be present either as complete molecules or as blocks of varying length in chains of isotactic molecules. Isotactic structure is stiff, highly crystalline and has high melting point. Within the range of commercial polymers, the higher the amount of isotactic structure, the higher the crystalline content and, hence, the higher the mechanical properties including stiffness, tensile strength, modulus and hardness.

2.1.3 Reinforcing Fillers

The extensive uses of the fillers nowadays are mainly for two objectives which are to lower the cost of a molding compound and to selective modify the properties of a specific plastic. Inert or extender fillers increase the bulk and lower the price while active fillers produce specific improvements in certain mechanical or physical properties and are thus also known as reinforcing fillers [8].

The use of extender fillers can result in the following changes in the properties of thermoplastics: increase in density; increase in modulus of elasticity, as well as in compressive and flexural strength (stiffening); lower shrinkage; increase in hardness and improvement in surface quality; increase in heat deflection temperature and cost reduction.

Reinforcing fillers, on the other hand, produce the following improvement in thermoplastics: increase in tensile strength and tensile stress at break, as well as in compressive and shear strengths; increase in modulus of elasticity and stiffness of a composite material; increase in heat deflection temperature and lowering of the temperature dependence of the mechanical values; lower shrinkage; improvement in creep behavior and bend-creep modulus, reduction in the viscoelastic yield under load; and also a partial improvement in impact strength. Reinforcing fillers can be fibers, whiskers or particles. In the case of fiber-reinforced composites which are the type of composites studied in this research, they consist of the fibers of high strength and modulus embedded in a matrix with distinct interfaces between them. Several types of fibers having those properties can be used as reinforcing fillers in fiber-reinforced composites. For example, carbon fibers have a combination of very high strength, low density, and high elastic modulus. With these unique properties, carbon fibers are suitable for critical uses such as in advanced composites and aerospace applications. Carbon fibers are produced mainly from two sources, polyacrylonitrile (PAN) and pitch, which usually called precursors [9]. In general, carbon fibers are produced from PAN precursor by three processing stages. The first stage is stabilization. In this stage, the PAN fibers are stretched to align the fibrillar network within each fiber parallel to the fiber axis, then they are oxidized in air about 200–220°C while held in tension in order to provide crosslinking between the fibers to avoid melting at the next stage. In the second stage called carbonization, the crosslinked fibrils are pyrolyzed until they become transformed into carbon fibers by the elimination of O, H and N from the PAN fibers. The third stage namely graphitization, involves complete conversion of the fiber to oriented graphite crystal form by heating to 2000 °C while under tension. A surface treatment is

applied in order to improve the fiber mechanical properties. Carbon fibers have very high specific strengths and moduli.

Another type of widely used fibers is glass fibers. Glass fibers are the most widely used of all reinforcing fillers for plastic matrices. Glass fibers are produced by drawing monofilament of glass from a furnace containing molten glass, coating the monofilament with a polymer to "dull" any surface cracking and gathering a large number of this filament to form a strand of glass fibers [9]. Advantages of glass fibers over other reinforcing fillers include a favorable cost/performance ratio with respect to dimensional stability, corrosion resistance, heat resistance, and ease of processing. The major types of glass fibers are E-glass, S-glass and C-glass. Fiber strength decreases greatly with surface defects and with moisture absorption. The surface of glass fiber can be treated with a size finish or coupling agent to improve the mechanical properties. Glass fibers are mainly used for non-critical applications.

In addition to glass fibers, other types of ceramic fibers used in composites include alumina, boron, silicon carbide, alumina-silica, and other metal oxide-silica fibers. Boron and silicon carbide continuous fibers are made by chemical vapor deposition using other high modulus fibers, such as tungsten and carbon, as the substrates. The high cost of these fibers limited their uses even though they have very high modulus and strength. The other physical properties of these reinforcing fillers in matrices compared with glass fibers and other fibers are high compressive strength and retention of properties at elevated temperatures.

Mineral fibers such as asbestos although have an excellent high strength and is a low cost reinforcing filler; however, it has been the subject of much legislation, regulation, and litigation in view of the potentially adverse health effects resulting from excess inhalation of free fibers. As a result, material suppliers and fabricators no longer utilize asbestos in composites [10].

Metal fibers including stainless steel, aluminium, and nickel-plated glass or carbon fibers are typically used in composites intended for applications requiring electrostatic charge dissipation or electromagnetic frequency shielding. They are not

optimal for reinforcing since they tend to curl up during processing. However, low content of these fibers at about 5-10% is required in order to achieve satisfactory shielding performance but not decrease the mechanical properties of the composites to unacceptable levels. Stainless steel fibers are the most widely used at present.

Besides inorganic fibers mentioned above, organic fibers both synthetic and natural fibers can also be used as reinforcing fillers for composites. The most common organic fibers for composite reinforcing fillers are the aramids and the most common brand name is Kevlar produced by DuPont Corporation. Aramid fibers are tougher than glass or carbon fibers and are often used in ballistic applications and damage control. The chemical structure of the Kevlar polymeric chain is that of an aromatic polyamide as shown in Figure 2.2



Figure 2.2 Chemical structure of Kevlar [9].

Kevlar aramid is used for high performance composite applications where light weight, high strength, stiffness, impact and fatigue resistance are important.

Polyethylene (PE) fibers, known as Spectra, are produced by solution spinning a high molecular weight PE. Two outstanding features of these fibers are low moisture absorption (1% compare to 5-6% for Kevlar 49) and high abrasion resistance, which make them very useful in marine composites, such as boat hulls and water skis. However, their use at high temperatures (beyond 120°C) is limited due to lose their strength.

Natural fibers are used almost exclusively in low-severity applications for thermoset composites. Some examples are cotton, ramie, jute, flax, sisal and abaca fibers. Of these fibers, jute, ramie, flax and sisal are the most commonly used fibers for polymer composites.

Natural fibers themselves are cellulose fiber-reinforced materials as they consist of microfibrils of cellulose in an amorphous matrix of lignin and hemicellulose. The chemical composition of natural fibers varies depending upon the type of fibers. Primarily, fibers contain cellulose, hemicellulose, pectin and lignin. Hemicellulose is responsible for biodegradation, moisture absorption and thermal degradation of the fibers whereas lignin is thermally stable but is responsible for ultraviolet degradation. Generally, the fibers contain 60-80% cellulose, 5-20% lignin, and up to 20% moisture. The hydrogen bonds and other linkages provide the strength and stiffness to the fibers. The properties of several natural fibers compared to one type of glass fiber are shown in Table 2.1

Table 2.1 Mechanical properties of natural fibers and glass fiber [11]

Fiber	Specific Gravity	Tensile Strength (MPa)	Modulus (GPa)	Specific Modulus (GPa)
Jute	1.3	393	55	38
Sisal	1.3	510	28	22
Flax	1.5	344	27	50
Sunhemp	1.07	389	35	32
Pineapple	1.56	170	62	40
E-glass	2.5	3400	72	28

As can be seen from Table 2.1, the tensile strength and modulus of E-glass fiber are substantially higher than those of natural fibers. But when considering the specific modulus of these fibers (modulus/specific gravity), the natural fibers exhibit this property

that is comparable to or better than that of E-glass fiber. The higher specific properties are one of the major benefits of using natural fiber composites for applications where in the desired properties also include weight reduction. Other advantages of using natural fibers are low cost, biodegradable and nonabrasive, unlike other reinforcing fibers. However, they have undesirable properties such as dimensional instability as a result of moisture absorption and low heat resistance, i.e. strength loss sets at around 124°C and thermal degradation commences at around 163°C.

In this research, mixed polyester and cotton fibers in the form of nonwoven fabric (T/C nonwoven) were used as reinforcing fillers. Details in synthesis and properties of each fiber are given as follows. However, the information for preparation of T/C nonwoven cannot be disclosed due to the policy of the company.

2.1.3.1 Polyester Fibers

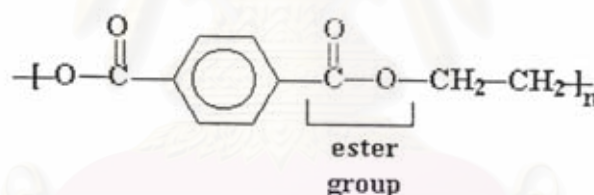

Polyesters have hydrocarbon backbones, which contain ester linkages [5]. The ester groups in the polyester chain are polar, with the carbonyl oxygen atom having a somewhat negative charge and the carbonyl carbon atom having a somewhat positive charge. The positive and negative charges of different ester groups are attracted to each other. This allows the ester groups of nearby chains to line up with each other in crystal form.

Poly(ethylene terephthalate), widely known as PET, is the most commercially manufactured polyester. Some of the more recent commercial processes for synthesis of PET involves the following procedure. Terephthalic acid and an excess of ethylene glycol are used to produce the bis (2-hydroxy-ethyl) terephthalate [5],

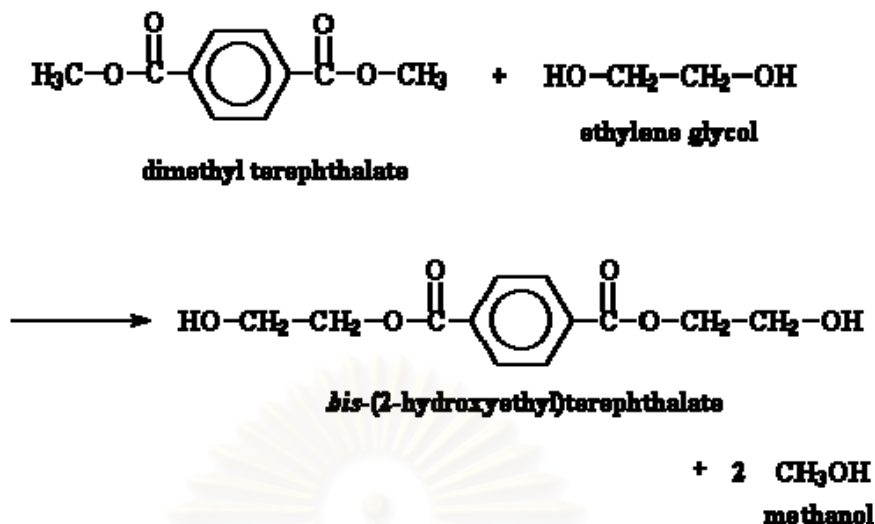

Then the bis-(2-hydroxyethyl) terephthalate is heated up to a balmy 270°C, and it reacts to give the poly (ethylene terephthalate) and oddly, ethylene glycol as a byproduct [5].

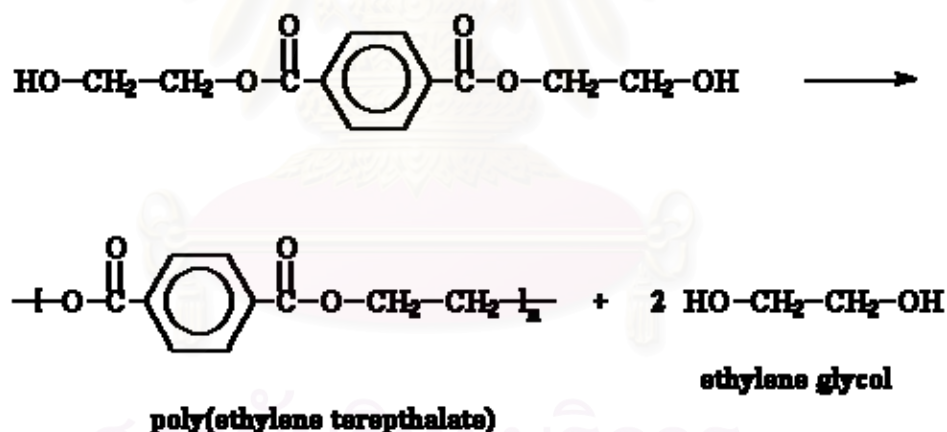

Poly(ethylene terephthalate), known by the trade names Mylar, Dacron and Terylene is a very high volume polymer. PET has good mechanical strength, toughness and fatigue resistance up to 150-175°C as well as good chemical, hydrolytic and solvent resistance. Poly(ethylene terephthalate) fiber has outstanding crease resistance has good abrasion resistance, can be treated with crosslinking resins to impart permanent-press (wash and wear) properties and can be blended with cotton and other cellulosic fibers to give better feel and moisture permeation [5].

2.1.3.2 Cotton

The most important constituent of vegetable fibers is cellulose, which is hydrophilic and hygroscopic. Apart from cellulose, vegetable fibers also consist of several other substances which affect their properties. Cotton is the most important vegetable fiber used to produce nonwoven fabrics [12].

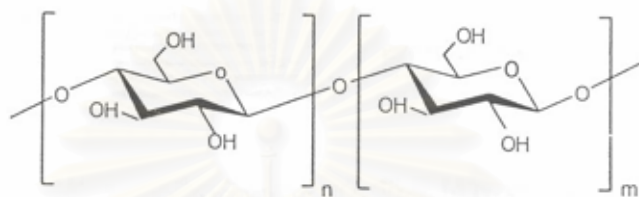

The properties of the cellulose obtained from cotton short fibers and wood are such that it cannot be directly formed into useful products. It is highly crystalline and insoluble and decomposes at high temperatures without flowing or melting—all a consequence of the extremely strong hydrogen-bonding present [5].

All varieties of cotton belong to the mallow family. To grow properly, the plants need moisture as well as dry heat alternately at the right times. Cotton is an annual plant and grows to a height of approximately 1 m to 2 m. It grows fruit the size of walnuts which contain seeds covered with cotton fiber. The ripe fruit shells burst open and the cotton swells out in thick white flocks. The crop is usually harvested by machine, so that the cotton fibers are more likely to become contaminated than if harvested by hand. After harvesting, the seeds are removed with cotton gins and the cotton is packed into bales. The short fibers are removed by means of specialized machines and are used to produce a wide range of products, including the raw material for the production of cupro and acetate fibers. In fact, short fibers are also used in the production of nonwoven bonded fabrics.

Raw cotton contains

- Cellulose (80% to 90%)
- Water (6% to 8%)
- Waxes and fats (0.5% to 1.0%)
- Proteins (0% to 1.5%)
- Hemicelluloses and pectins (4% to 6%)
- Ash (1% to 1.8%)

The cotton fibers have to be scoured in an alkaline solution and/or have to be bleached to obtain the proper qualities and purity standard required for various purposes. To develop their typical fine sheen, the fibers have to be mercerized hot or cold. One of the most important characteristics of wet cotton is that it is some 10% stronger than dry cotton. Its good mechanical properties and serviceability are due to its structure.



Figure 2.3 Cotton fibers [12]. (a) Cross-section

(b) Longitudinal section

As shown in Figure 2.3 (a) and (b), cotton shape and structure make it suitable for use for the production of nonwoven bonded fabric: cotton has a ribbon-shaped cross-sectional form, a spiral twist, a hollow structure, a high wet strength for a high module and it is hygroscopic.

Thus its use for the production of nonwoven bonded fabrics met with a fair degree of success in the early years. Its success, however, faded quickly because of the impurities which affected the production and even the quality of the finished product. This problem could not be solved, for it is impossible to remove all impurities during the production process or counteract their effect. This technical problem caused the noted decline of cotton usage in the production of nonwoven bonded fabrics.

2.1.4 Literature Survey on Polypropylene Composites

Studies on composites based on polypropylene matrix and/or cellulose-reinforced have been reported. In 2002 Hattotuwa et al. studied the comparison of the mechanical properties of rice husk powder filled polypropylene and those of talc filled polypropylene composites [13]. Unmodified and ground talc and rice husk (RHP) fillers were compounded with polypropylene separately in a Brabender plasticorder internal mixer at 180°C and 50 rpm in order to obtain composites, which contain 0-60% php (per 100 part of polymer) of filler at 15% intervals. The Brabender torque development and the mechanical properties of the composites with reference to filler type and filler loading were investigated (talc). In terms of mechanical properties, Young's modulus and flexural modulus increased, whereas yield strength and elongation at break decreased with the increase in filler loading for both types of composite. Of these polypropylene composites, the RHP composites exhibited lower yield strength, Young's modulus, flexural modulus, and higher elongation at break than talc composites. Scanning electron microscopy (SEM) was used to examine the structure of the fracture surface and to justify the variation of the measured mechanical properties.

Later on, in 2003 Wambua et al. demonstrated that the natural fibers could replace glass fibers in fiber-reinforced plastics [14]. In this work, natural fibers (sisal, kenaf, hemp, jute and coir) reinforced polypropylene composites were processed by compression molding using a film stacking method. The mechanical properties of the different natural fiber composites were tested and compared. A further composition was made with the corresponding properties of glass mat reinforced polypropylene composites from the open literature. Kenaf, hemp and sisal composites showed

comparable tensile strength and modulus result but in impact properties hemp appeared to out-perform kenaf. The tensile modulus, impact strength and the ultimate tensile stress of kenaf reinforced polypropylene composites were found to increase with increasing fiber weight fraction. Coir fiber composites displayed the lowest mechanical properties. But their impact strength was higher than that of jute and kenaf composites. In most cases, the specific properties of the natural fiber composites were found to compare favorably with those of glass fiber.

Also in 2003, Santos et al. reported on the mechanical properties of polypropylene reinforced with recycled-PET fibers [15]. They presented an experimental study of the incorporation of fiber of recycled poly(ethylene terephthalate) (PET) in polypropylene (PP). Composites of PP/PET with 3, 5, and 7% of PET fiber (w/w) were prepared by monoscrew extrusion followed by injection molding and the mechanical behavior was estimated by the measurement of the tensile strength, the Izod impact strength and the surface hardness (Shore D). The morphology was determined by scanning electron microscopy (SEM), showing good dispersion of the fibers but no interaction between the polymer phases. It was observed that the incorporation of recycled-PET fiber in PP was an efficient way to recycle PET with increasing significantly the mechanical properties of PP.

However, the most important consideration in preparation of a composite is the fiber-matrix adhesion. The role of the matrix in a fiber-reinforced composite is to transfer the load to the stiff fibers through shear stresses at the interface. [16] This process requires a good adhesion between the polymeric matrix and the fibers. Poor adhesion at the interface means that the full capabilities of the composite cannot be exploited and leaves it vulnerable to environmental attacks that may weaken it, thus reducing its life span. Insufficient adhesion between hydrophobic polymer and hydrophilic fiber results in poor mechanical properties of the fiber reinforced polymer composites. Therefore, surface modification of the matrix or the reinforcing fibers before incorporation in a composite is necessary in order to improve the fiber-matrix adhesion and consequently, enhance the mechanical properties of that composite. Many reports have shown that

surface modification can be done by many methods as presented in the following section.

2.2 Surface Modification of Polymeric Materials

The incorporation of hydrophilic natural fiber in hydrophobic polymer leads to a heterogeneous system whose properties are inferior owing to lack of adhesion and compatibility between the fiber and the matrix. To achieve compatibility between the two components, surface modifications of these components by either chemical or physical methods can be applied. Chemical methods provide a bridge of chemical bonds between the fiber and the matrix. Physical methods generally change structural and surface characteristics of the fiber and by influencing the mechanical bonding to polymer matrix.

2.2.1 Surface Modification by Chemical Methods

Surface of polymeric materials can be modified by many chemical reactions such as etherification, esterification, etc. For fiber-reinforced composites, chemical modification is usually applied on the reinforcing fibers. Chemical treatments such as delignification, bleaching, acetylation and chemical grafting are generally used for modifying the fiber surface in order to enhance its properties.

Delignification is generally carried out by extracting with alcohol or benzene, followed by treating with NaOH and drying at room temperature. Bleaching process results in loss of weight and tensile strength by using many oxidative bleaching agents such as hydrogen peroxide, alkaline calcium or sodium hypochlorite. These losses are mainly attributed to the action of the bleaching agent on the noncellulosic constituents of fiber such as hemicellulose and lignin.

Acetylation of jute is reported to impart resistance to fungal attack and hydrophobicity. The change in properties is attributed to the decrease in moisture absorption in the cell wall and blocking of the hydroxyl group of the wall components in such a way those enzymes of the wood-degrading microorganism cannot recognize them as attachable substrates. Acetylated jute is considerably more hydrophobic than unmodified jute [17].

Chemical grafting involves attaching to the surface of a fiber/filler a suitable polymer with a solubility parameter similar to the polymer matrix. It acts as an interfacial agent and improves the bonding between the fiber and the matrix. Moreover, it can alter the physical and mechanical properties of the composites. Graft copolymerization of vinyl monomers such as methyl methacrylate, acrylamide and acrylonitrile on to cellulose, cellulose derivatives and lignocellulosic fibers have been extensively studied [17]. Impregnation with monomer followed by its polymerization has also been the common method used for treatment of the fibers. Another method that graft copolymerization onto cellulose takes place through an initiation reaction involving attack by macrocellulosic radicals on the monomer to be grafted. The generation of the macrocellulosic radicals is accomplished by many methods such as diazotization, chain transfer reaction, redox reaction, photochemical initiation and radiation-induced synthesis.

The chemical treatment using sodium alginate and sodium hydroxide have been reported for coir, banana and sisal fibers. The treatment resulted in an increase in debonding stress and thus improved the ultimate tensile strength [17]. Table 2.2 lists some examples of chemical treatments used for modification of natural fibers.

Table 2.2 Chemical treatments used for modification of natural fibers [17]

Fiber	Chemical Treatment	Coupling Agent
Wood flour	Succinic acid, styrene, urea-formaldehyde, <i>m</i> -phenylene bismaleimide, acetic anhydride, maleic anhydride, itaconic anhydride, polyisocyanate, linoleic acid, oxalic acid, rosin	Maleated PP, acrylic acid, graft PP, silane, zirconate, titanate
Jute	Phenol-formaldehyde, melamine-formaldehyde, cardonol-formaldehyde	
Sisal	NaOH, isocyanate, sodium alginate, <i>N</i> -substituted mathacrylamide	
Pineapple	<i>p</i> -phenylene diamine	
Banana	Sodium alginate	
Coir	Sodium alginate, sodium carbonate	

Strongly polarized cellulose fibers are incompatible with hydrophobic polymers. When two materials are incompatible, it is often possible to bring intermediate between the two components. The addition of proper compatibilizer or a coupling agent was an another method of the surface treatment that can be used for lowering the interfacial tension and stress transfer across the interface, and promoting the adhesion, dispersion, and compatibilization between the components. Coupling agents are usually (but not limited) used in system of an inorganic filler and organic polymer.

In 1991, Felix et al. studied the nature of adhesion in composite of modified cellulose fibers and polypropylene [18]. Cellulose fibers were surface-modified with polypropylene-maleic anhydride copolymer. The physical properties of such fibers were characterized by contact angle measurements, and the chemical structure was identified with ESCA and FT-IR. ESCA showed that the modifying agent was localized at

the surface of the fibers. The modified fibers were compounded with polypropylene, and composites with various amount of fibers were manufactured by injection molding. All mechanical properties were improved when treated fibers were used. SEM showed improved dispersion, wetting of fibers, and adhesion. The nature of adhesion was studied using FT-IR. It was found that the surface-modifying agent is covalently bonded to the fibers through esterification. The degree of esterification is enhanced by activating the modifying agent before fiber treatment. This study had shown the effects of treatment conditions on activation of reactive species and chemical reaction between fiber and modifying agent. Moreover, a better understanding has been achieved of the nature of adhesion for the system.

Later on, 1996 Bledzki et al. studied on structure and properties of natural vegetable fibers (NVF) [19]. They found that the composites made of NVF combined good mechanical properties with a low specific mass. The high level of moisture absorption by the fiber, its poor wettability, as well as the insufficient adhesion between untreated fibers and the polymer matrix led to debonding with age. To build composites with high mechanical properties, therefore, a surface modification of the fibers was necessary. The existing physical and chemical NVF modification methods such as plasma treatment or graft copolymerization used for improving the properties of NVF-polymer composite were discussed. It was shown that modified cellulose fiber-polymer interaction mechanisms were complex and specific to every definite system. By using an coupling agent such as silanes or stearin acid, Young's modulus and the tensile strength increased, dependent on the resin, until 50%. Simultaneously, the moisture absorption of the composites decreased for about 60%. With other surface modifications, similar results were obtained.

Three years later, Jingshen et al. investigated the effects of fiber surface pretreatment on the interfacial strength and mechanical properties of wood fiber/polypropylene composite [20]. The results indicated that fiber surface conditions significantly influence the fiber-matrix interfacial bond, which, in turn, determined the mechanical properties of the composites. The WF/PP composite containing fibers pretreated with an acid-silane aqueous solution exhibited the highest tensile properties

among the materials studied. This observation was a direct result of the strong interfacial bond caused by the acid/water condition used in the fiber pretreatment. Evidence from coupling chemistry, rheological and electron microscopic studies supported the above conclusion. When maleated styrene-ethylene-butylene-styrene (SEBS-g-MA) copolymer was used, a synergistic toughening effect between the wood fiber and the copolymer was observed. The V-notch Charpy impact strength of the WF/PP/SEBS-g-MA composite was substantially higher than that of the WF/PP composite. The synergistic toughening mechanisms were discussed with respect to the interfacial bond strength, fiber-matrix debonding, and matrix plastic deformation.

2.2.2 Surface Modification by Physical Methods

Polymeric materials can be modified by physical methods such as stretching, calendaring, thermotreatment, and electric discharge such as corona and plasma. The first three methods generally modify not only on the surface but sometimes also the whole structure of the fibers. On the other hand, the implantation process that occurs in plasma treatment is one of the most effective methods for surface modification of polymeric materials. Gas molecules such as oxygen and nitrogen, are activated by the plasma. The activated species interact with the polymer's surfaces, and then special function, such as hydroxyl, carbonyl, carboxyl, amino groups are formed at the surface of the polymers [16]. As a result, the implantation reactions lead to large changes in the surface properties of the polymer, for example, the polymers change from hydrophobic to hydrophilic.

In recent years, plasma technology has been diffused because it is possible to improve the superficial characteristics either of metallic or of polymeric materials. Plasma generators permit good control of the treatment process, low-cost treatments and low environmental pollution. The field of material surface modification by corona and plasma has undergone enormous expansion, particularly in the surface modification of polymeric materials for improving adhesion. This is because undesirable physical characteristics of polymer which is low surface energy resulting in intrinsically poor

adhesion. The following section will emphasize on plasma technology for surface modification especially for polymeric materials.

2.3 Plasma Technology for Surface Modification of Polymeric Materials

Plasma treatment is frequently used for the improvement of adhesion and wettability of polymeric materials. The mechanisms of surface functionalization of polymeric substrates are different from the gas-phase processes. While electrons play the most important role in the plasma state, positive ions also play a significant role in the surface chemistry during the interactions of plasma species with polymers [21]. The resulting valence-ionized polymer chains undergo neutralization reactions leading to sufficiently intense localized internal energy concentrations (electronically excited states), which can induce hemolytic bond cleavages. The development of free radicals and unsaturated-bonds can result in crosslinking of polymeric layers. Free radicals can further induce chemical reactions controlled by specific chemical environments (gas-phase or condensed-phase compounds, including, oxygen, monomer molecules, etc.) in the absence of plasma.

2.3.1 Plasma State

The plasma state can be broadly considered to be a gaseous mixture of oppositely-charged particles with a roughly zero net electrical charge. Ionization processes can occur when for instance molecules of a gas are subjected to high – energy radiation, electric fields. During these processes the energy levels of particles composing the gas increase significantly and as a result electrons are released and charged heavy particles are produced.

Sir William Crooks suggested the concept of the 'fourth state of matter' (1879). [21]. Figure 2.4 for electrically discharged matter and Irving Langmuir first used the term 'plasma' to denote the state of gases in discharge tubes.

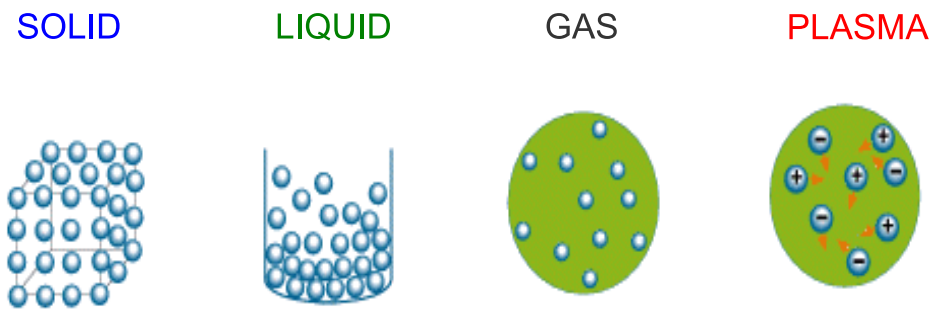

Figure 2.4 Plasma – the 4th state of matter

2.3.2 Classification of Plasma

Plasma states can be divided in two main categories: Hot Plasmas (near-equilibrium plasmas) and Cold Plasmas (non-equilibrium plasmas) [21]. Hot plasmas include electrical arcs, plasma focus, plasma jets of rocket engines, thermonuclear reaction generated plasmas, etc. while cold plasmas include low-pressure direct current (DC) and radio frequency (RF) discharges (silent discharges), discharges from fluorescent (neon) illuminating tubes. Corona discharges are also identified as cold plasmas. Corona treatment is one of the most interesting techniques for surface oxidation activation. This process changes the surface energy of the fibers. Electrical discharge (corona and plasma) methods are known to be very effective for nonactive polymer substrates such as PS, PE and PP.

2.3.2.1 Cold Plasmas (Non-equilibrium Plasmas)

Plasma may be defined as a partially ionized gas with equal number densities of electron and positives ions, in which the charged particles are “free” and possess collective behavior [22]. Cold plasmas occur at low pressure, 13 to 133 Pa, the heavy particles (gas molecules and ions) and relatively high temperature electrons and they are combined with low degrees of ionization (10^{-4} -10%). Accelerated electrons (energetic electrons) induce ionization, excitation and molecular fragmentation processes leading to a complex mixture of active species. Chemically reactive species

thus created can partake in homogeneous (gas-phase), or heterogeneous reactions with solid surface in contact with plasma.

2.3.2.2 Hot Plasmas

Hot plasmas have a greatly high energy content, which induces fragmentation of all organic molecules to atomic levels and as an outcome, hot plasma approaches considered for materials processing have been initiated with the use of plasma arc heaters and later on, three distinct application areas emerged: synthesis, melting and deposition. Progress in thermal plasma processing has been limited by a not enough understanding of the greatly complex reaction kinetics, transport properties and heat transfer during gas-solid, gas-gas and solid-gas interactions. As a result, thermal plasma processing has only in a few instances promoted beyond laboratory

2.3.3 Plasma Focus

Plasma focus is one example of hot plasma processes. Plasma focus device is a high power pulsed discharge in which a dense, magnetically compressed plasma is produced at the end of coaxial electrodes. This device is an intense source of neutron, X-ray, ion and electron beams [23].

Studies of the ion emission from the plasma focus device give useful information about the ion source and mechanisms of the ion acceleration. Ion emission characteristics are also of interest for applied research. Therefore, extensive experimental and theoretical studies of ion emission were carried out in various laboratories. In particular, the use of the ion beam generated from the plasma focus device to produce ion implantation, thermal surface treatment, and ion-assisted coating has received much attention in recent years.

2.3.3.1 The Dynamic of the Plasma Focus

The process of plasma focus begins when a charged capacitor bank at a voltage V_0 discharges to plasma focus tube. The high voltage causes a breakdown, initially, on the surface of the glass insulator at the base of the anode. A current sheath (plasma sheath) is formed symmetrically along the electrode axis. It lifts off from the glass insulator and is then propelled by $\vec{J} \times \vec{B}$ force or usually known as Lorentz force. Here, \vec{J} is the current density and \vec{B} is the self-induced magnetic field. This phase is called "breakdown or surface discharge" phase as shown in Figure 2.5a.

Next phase starts when the current sheath lift-off is completed and the current flows radially outward from the inner anode to the outer cathodes. As this happens, it builds up a thicker current sheath. When the current sheath is moving out with speed, it will form a shock front in front of the current sheath. The current sheath sweeps up all the charged particles it encountered leaving behind a vacuum immersed in the magnetic field of the current sheath. Between the shock front and the current sheath, the gas is shock heated to a highly ionized state and a plasma slug will be formed. Ahead of the shock front, the ambient gas is assumed to be undisturbed. The $\vec{J} \times \vec{B}$ force pushes the current sheath towards the end of the inner electrode along the Z-direction. This phase is called the "axial acceleration phase". Figure 2.5b

When the current sheath reaches the end of the anode, the radial phase starts. During the radial phase the current sheath slides along the surface of the anode in the radial direction by the $\vec{J} \times \vec{B}$ force. The current sheath collapses radially. This phase is called "radial collapse phase". as shown in Figure 2.5c. At the end of the radial phase, a dense plasma column is formed on the axis of the focus tube just off the face of the anode. During this dense plasma phase, soft X-ray and other types of radiations can be emitted from the plasma. This final phase is the focusing phase. Figure 2.5d

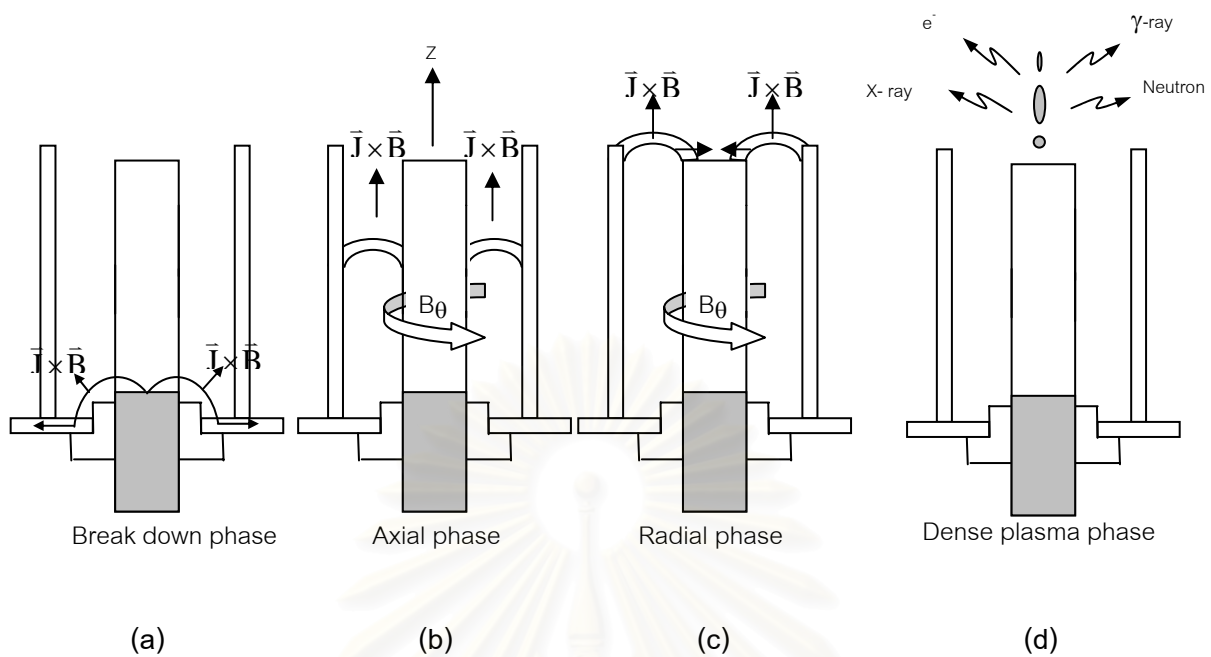

Figure 2.5 Diagrams showing four phases of plasma focus formation. [24]

2.3.4 Literature Survey on Surface Modification of Polymers by Plasma Treatment

In 1994 Caiazza et al. studied the electrode discharge for plasma surface treatment of polymeric materials [25]. A cold plasma prototype electrode discharge apparatus to perform polymer surface treatment is described. The plasma generator, operating with oxygen and/or nitrogen, works in glow regime at low pressure (10 mbar) and at relatively high gas flow rate, in the 110–340 l/h range. The effects of treatments on PET monopolyester and glass fiber reinforced plastics (GFRP) surfaces are analyzed. The treatment points out, in all operating conditions, an increase of both wettability (PET) and adhesivity (GFRP). The treatment times obtained are one order of magnitude lower than those of the traditional treatment apparatus.

In 1996 Inagaki., et. al. [16] studied the polyethylene film that was treated with oxygen and nitrogen plasma. The activated species interact with the polymer's surface and then special function, such as hydroxyl, carbonyl, carboxyl, amino and amido groups are formed at the surface of the polymers. As result, the implantation reactions

lead to large changes in the surface properties of the polymer, for example, the polymers change from hydrophobic to hydrophilic

In 1997 Kan et al. reported that the surface properties (such as surface luster, wettability, surface electrostatic and dyeability) of low-temperature plasma treated wool fabrics [26]. After the low-temperature plasma treatment, the treated wool fabric specimens exhibited better hydrophilicity and surface electrostatic properties at room temperature, together with improved dyeing rate. Study on the surface of the specimens showed that low-temperature plasma treatment did not effect any changes in the glossiness of the specimen. Scanning electron microscope observation illustrated the occurrence of some grooves on the fiber specimens that might possibly provide a pathway for a faster dyeing rate.

Three years later, the influence of AC electrical discharge cold plasma parameters on wettability and adhesion of polymeric surfaces was studied by Carrino et al [27]. A set of process variables (voltage, time and air flow rate) was identified and used to conduct some experimental tests on the basis of design of experiment techniques. The experimental results show that the proposed plasma process may considerably increase polypropylene wettability and adhesion properties. These outcomes represent the first step in trying to optimize the polymeric adhesion by means of this non-conventional manufacturing process.

After that, in 2003 Simor et al. reported that the atmospheric-pressure nitrogen plasma treatment of polyester nonwoven fabrics for electroless plating [28]. The plasma was produced in a surface barrier discharge generating a thin plasma layer in good contact with the fabric fibers. The optimum quality nickel coating was obtained for a 1 s treatment time. Treatment times in excess of 1 s resulted in a reduction of the nickel plating deposition rate, uniformity and adhesion values. The plasma-induced surface changes were characterized by liquid strike-through time measurements, X-ray photoelectron spectroscopy, and scanning electron microscopy. Because of atmospheric-pressure operation, very short treatment times, and its robustness the method has the potential to be used in line with standard metal plating lines.

In 2003, Rahel et al. studied on hydrophilization of polypropylene nonwoven fabric using surface barrier discharge [29]. Surface dielectric barrier discharges (SDBD), which find widespread industrial applications in ozone production, were used to hydrophilize light-weight polypropylene nonwoven fabric (PPNF) samples. The samples were treated in nitrogen plasma generated by SDBD at atmospheric pressure. The hydrophilicity of the samples was examined as a function of the storage time using a standard strike-through test. The surface chemical composition was characterized by X-ray photoelectron spectroscopy. Because of very short treatment times obtained (~1 s) and its simplicity the method has the potential to be used in-line with standard high-speed PPNF production lines, laminating, printing and metal plating lines, etc

Also in 2004, Wei et al. studied on surface characterization of plasma-treated polypropylene fibers [30]. The chemical nature of the fiber surfaces has been investigated by X-ray photoelectron spectroscopy (XPS). The XPS examination indicated the presence of oxygen-containing functional groups on fiber surfaces after plasma treatment. The Atomic Force Microscopy (AFM) scans revealed the evolution of surface morphology under different experimental conditions. A Philips Environmental Scanning Electron Microscopy (ESEM) was also used to study the wetting behavior of the fibers. In the ESEM, relative humidity can be raised to 100% to facilitate the water condensation onto fiber surfaces for wetting observation. The ESEM observation revealed that the plasma treatment significantly altered the surface wettability of polypropylene fibers.

Effects of plasma treatment in enhancing the performance of wood fiber-polypropylene composites were investigated by Yuan et al. in 2004 [31]. Argon and air plasma treatments were used to modify the surface of wood fibers under suitable treatment parameters to improve the compatibility between wood fibers and polypropylene (PP). Wood fibers and PP fibers were blended together to form a random mat, which was then vacuum hot-pressed into a preimpregnated composite sheet. The tensile strength and tensile modulus of the composite sheet improved to some extent after plasma treatment. The storage modulus in the dynamic mechanical properties of wood fiber-PP composites also showed improvement after treatment. Furthermore, scanning electron microscopic analyses revealed the improved morphologies of the

fractured surfaces of the composites. Surface characterization, by X-ray photoelectron spectroscopy, showed an increase in oxygen/carbon ratios of wood fibers after treatment.



สถาบันวิทยบริการ
จุฬาลงกรณ์มหาวิทยาลัย

CHAPTER III

EXPERIMENT

3.1 Materials

3.1.1 Polypropylene (PP) nonwoven

Polypropylene (PP) nonwoven was provided by Mölnycke Health Care (Thailand) Limited.



Figure 3.1 Polypropylene nonwoven

3.1.2 Polyester and cotton (PET/C) nonwoven

Polyester and cotton (PET/C) nonwoven was provided by Mölnycke Health Care (Thailand) Limited.



Figure 3.2 Polyester and cotton nonwoven

3.2 Machines and Equipments

3.2.1 Plasma Focus Device: UNU/ICTP (United Nation University/International Center for Theoretical Physics)

3.2.2 Compression Molding

3.2.3 Contact Angle Meters: Cam-Plus Tantac.

3.2.4 ATR/FT-IR Testing Machine: Thermo Nicolet Nexus 670

3.2.5 Scanning Electron Microscope (SEM): JSM-6400, Jeol Co, Ltd

3.2.6 Universal Testing Machine: A LLOYD model LR 100K

3.2.7 Universal Testing Machine: A LLOYD model 500

3.2.8 Impact Tester: A Zwick 5102 Pendulum



สถาบันวิทยบริการ
จุฬาลงกรณ์มหาวิทยาลัย

3.3 Methodology

The flow chart of the entire experimental procedure is shown below in Figure 3.3.

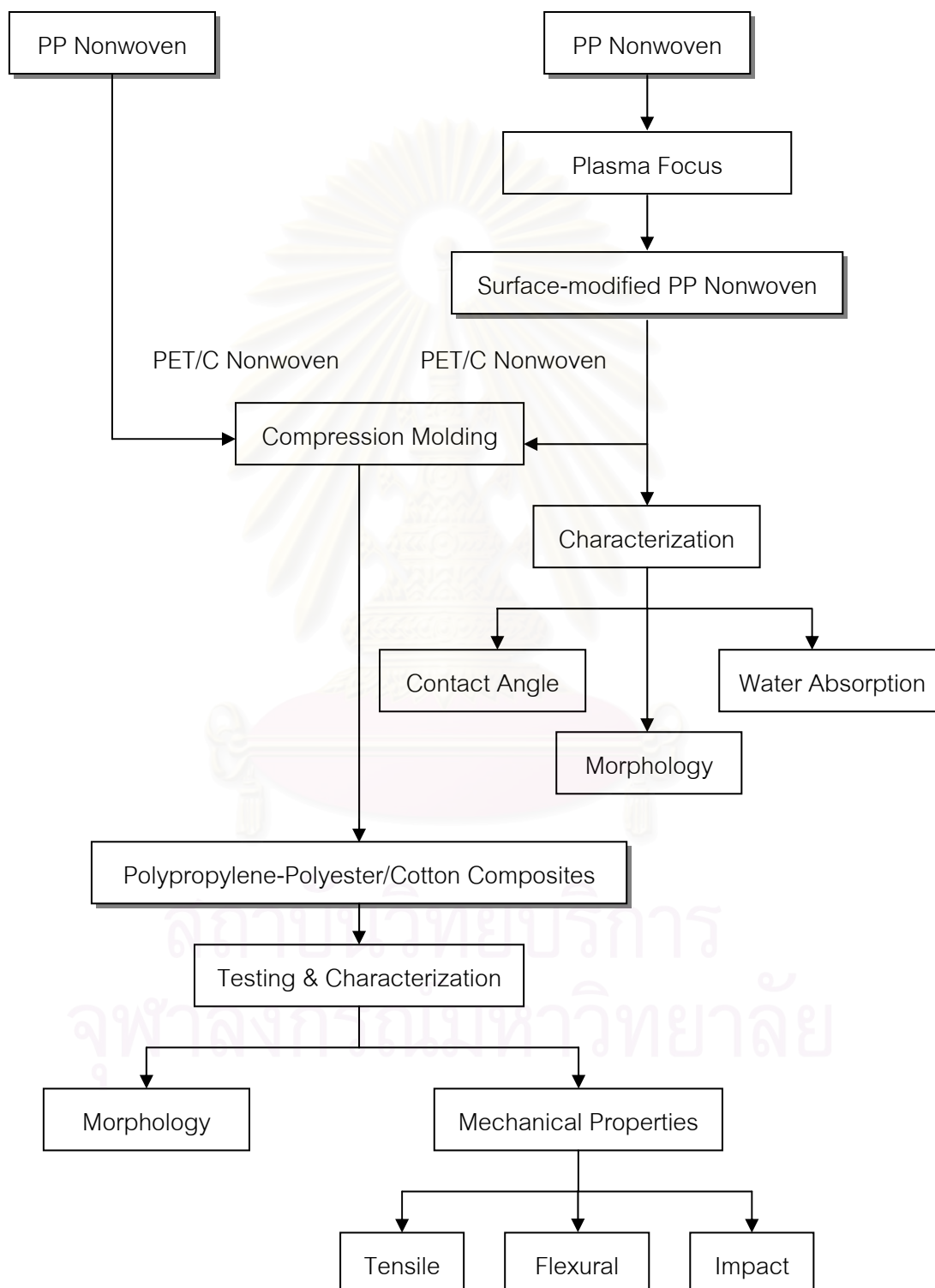

Figure 3.3 Flow chart of experimental procedure

3.3.1 Surface Modification of Polypropylene Nonwoven



Figure 3.4 UNU/ICTP plasma focus device

Polypropylene (PP) nonwoven having dimensions of 13 cm x 9 cm was placed on the cover in vacuum chamber of a plasma focus device as shown in Figure 3.5. The plasma focus device was then operated with nitrogen gas at a pressure of 1.5 mbar and discharge at 12.5 kV. In order to study the plasma effect on the properties of PP nonwoven and its composites, the number of plasma shot was varied from 1, 2, 3, 4 to 5 shots. After the process completed, PP nonwoven was removed from the chamber and subjected to further characterization.

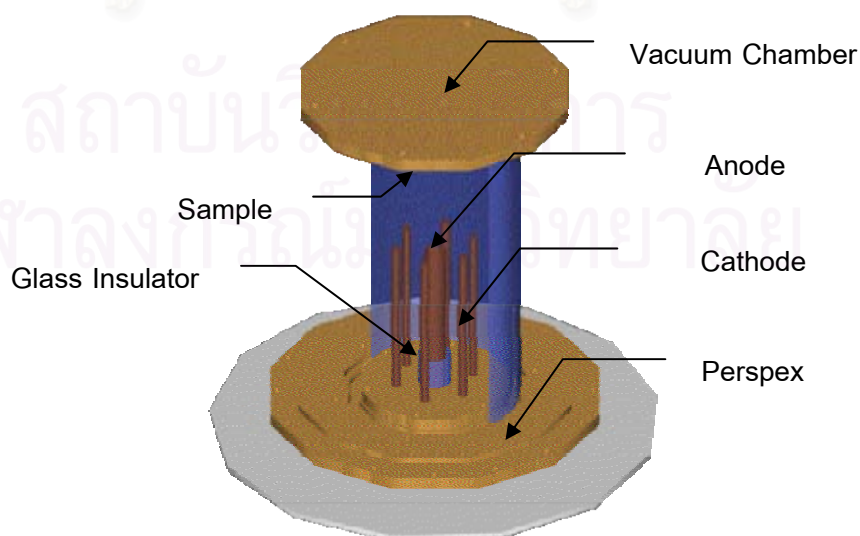

Figure 3.5 Sample position in the chamber of UNU/ICTP plasma focus device

3.3.2 Characterization of Surface-modified and Unmodified Polypropylene Nonwovens

3.3.2.1 Morphological Analysis

Morphology of surface-modified and unmodified PP nonwovens was verified using A Joel JSM-6400 scanning electron microscope (SEM). The sample was coated with gold before being scanned.

3.3.2.2 Contact Angle Measurement

Water contact angles of surface-modified and unmodified PP nonwovens were determined according to ASTM D5725-99 using Cam-Plus Tantac contact angle meter.



Figure 3.6 Cam-Plus Tantac contact angle meter

3.3.2.3 Determination of Water Absorption

Water absorption of PP nonwoven was measured according to ASTM D570. Both surface-modified and unmodified PP nonwovens were dried in an oven for 24 hours at 60°C, cooled in a desiccator and immediately weighed. The dried weight was designated as W_1 . After that, they were immersed in distilled water for a set time

and temperature. The specimens were removed, wiped dried, weighed and immediately returned to the water bath. The procedure was repeatedly performed until no weight changes were observed. The final weight was designated as W_2 . Water absorption of each sample was calculated as the weight difference and was reported as percent increase of the initial weight, according to equation (3.1) as follows:

$$\% \text{ Water Absorption} = \frac{W_2 - W_1}{W_1} \times 100 \quad (3.1)$$

When W_1 = initial or dried weight

W_2 = final or wet weight

3.3.2.4 Chemical Structural Analysis

Attenuated Total Reflection/Fourier transform infrared spectroscopy was performed using a Thermo Nicolet Nexus 670 Spectrophotometer to characterize chemical structures of the samples. The samples were scanned at the frequency range of $4000\text{-}600 \text{ cm}^{-1}$ with 32 consecutive scans and 4 cm^{-1} resolution.



Figure 3.7 Attenuated total reflection/fourier transform infrared spectroscopy

3.3.3 Preparation of Polypropylene-Polyester/Cotton Composites

As already mentioned, the two components were in the form of nonwoven fabric. Both PP and polyester/cotton (PET/C) nonwovens were laminated by compression molding at 190°C for 12 minutes and PP-PET/C composites were obtained. The weight ratios of PP nonwoven to PET/C nonwoven were varied from 95:5, 90:10, 85:15 and 80:20 but 75:25 ratio could not laminated by compression molding since amount of PP no enough



Figure 3.8 Compression molding machine

3.3.4 Mechanical Testing of Polypropylene-Polyester/Cotton Composites

3.3.4.1 Tensile Properties

Tensile properties of the composite sample were measured according to ASTM D638-82a (type IV) using a Universal Testing Machine model LR 100K.

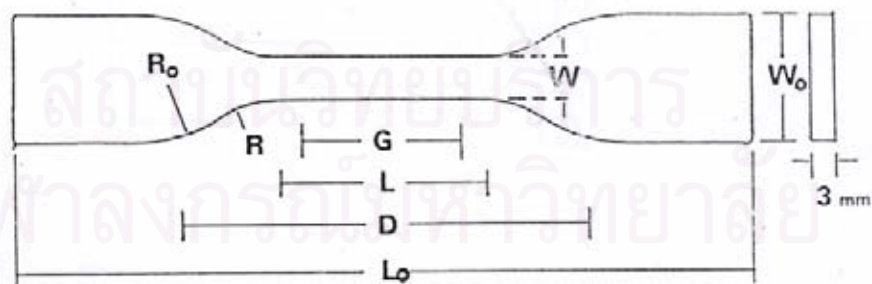

Figure 3.9 A LLOYD Universal testing machine model LR 100K

The tensile testing conditions were as follows:

Temperature:	25°C
Relative humidity:	50%
Load cell	1 kN
Speed of testing:	50 mm/min

The specimens were prepared in a dumbbell shape as shown in Figure 3.8.



W: 6 mm	L: 33 mm	G: 25 mm	R: 14 mm
W ₀ : 19 mm	L ₀ : 115 mm	D: 65 mm	R ₀ : 25 mm

Figure 3.10 Schematic of tensile test specimen (type IV)

3.3.4.2 Flexural Properties

Flexural properties of the composite samples were tested based on ASTM D790-81 using a LLOYD Universal Testing Machine model 500.



Figure 3.11 A LLOYD Universal testing machine model 500

The flexural testing conditions were as follows:

Temperature:	25°C
Relative humidity:	50%
Load cell	2500 kN
Speed of testing:	50 mm/min
Span length:	50 mm

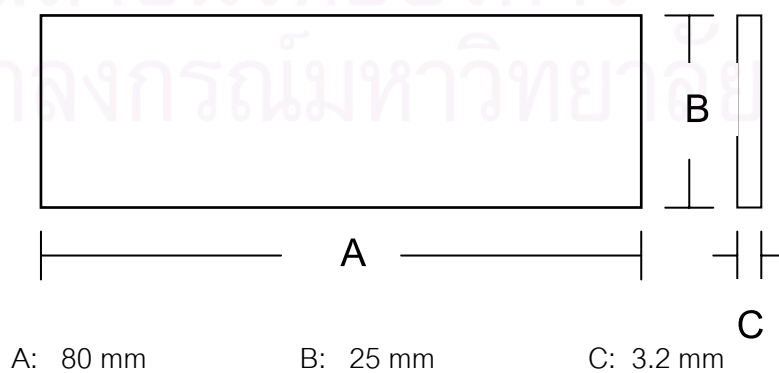

Figure 3.12 Schematic of flexural test specimen

3.3.4.3 Impact Strength

Impact tests of the composites were performed on a Zwick 5102 Pendulum impact tester according to ASTM D256-04 (Izod-type).

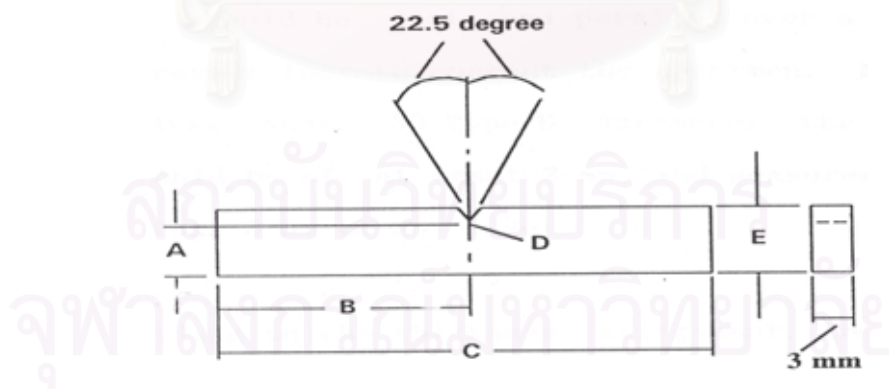

Figure 3.13 A Zwick 5102 Pendulum impact tester (Izod-type)

The machine parameters and testing conditions of the impact test were listed below:

Temperature: 25°C

Relative humidity: 50%



A: 10.16 ± 0.05 mm

B: 32.00 max, 31.50 min

C: 63.50 max, 53.50 min

D: 0.25 ± 0.05 mm

E: 12.70 ± 0.15 mm

Figure 3.14 Schematic of Izod-type test specimen

3.3.5 Morphological Analysis of Polypropylene-Polyester/Cotton Composites

Scanning electron microscope (SEM) at acceleration voltage of 15 kV was used to study the impact fractured surface of the composites in order to understand the failure mechanism of the composites. The fractured surface of the sample was coated with gold before being scanned. The SEM was operated at 15 kV.



Figure 3.15 A Joel JSM-6400 scanning electron microscope

สถาบันวิทยบริการ
จุฬาลงกรณ์มหาวิทยาลัย

CHAPTER IV

RESULTS AND DISCUSSION

4.1 Characteristics of Surface-modified and Unmodified Polypropylene Nonwovens

As previously described in Chapter 3, before compression with polyester/cotton nonwovens, polypropylene nonwovens were surface-modified using a plasma focus devices operated with nitrogen gas at a pressure of 1.5 mbar and different plasma shots. After that, their characteristics were investigated and the results are present as follows.

4.1.1 Morphology

From Figure 4.1, it is clearly seen that after plasma treatment, the surfaces of polypropylene nonwovens become rougher when compared to that of the unmodified one. As the number of plasma shots increases, the degree of roughness and the degradation of fabric surface increase. It can be seen that the surface of polypropylene nonwoven treated with 5 shots shows burning marks.

SEM photograph of unmodified polypropylene nonwoven in Figure 4.2a shows the texture of polypropylene nonwoven. Its texture composes of long polypropylene filaments bound together at a position having square shape. These polypropylene filaments have smooth surface as shown in Figure 4.3a. However, after plasma treatment, some parts of these filaments swelled and/or disoriented as shown in Figures 4.2b-f and Figures 4.3b-f. Furthermore, when polypropylene nonwoven was exposed to 5 shots of plasma, the chain rupture occurred as shown in Figures 4.2f and 4.3f. The swelling, disorientation and chain rupture of polypropylene filaments resulted in the roughness of the fabric surface as previously mentioned.

These results suggest that the number of plasma shots corresponding to the energy exposed to polypropylene nonwovens affects the morphology of the fabric. If it is too high, the degradation of fabric surface occurs.

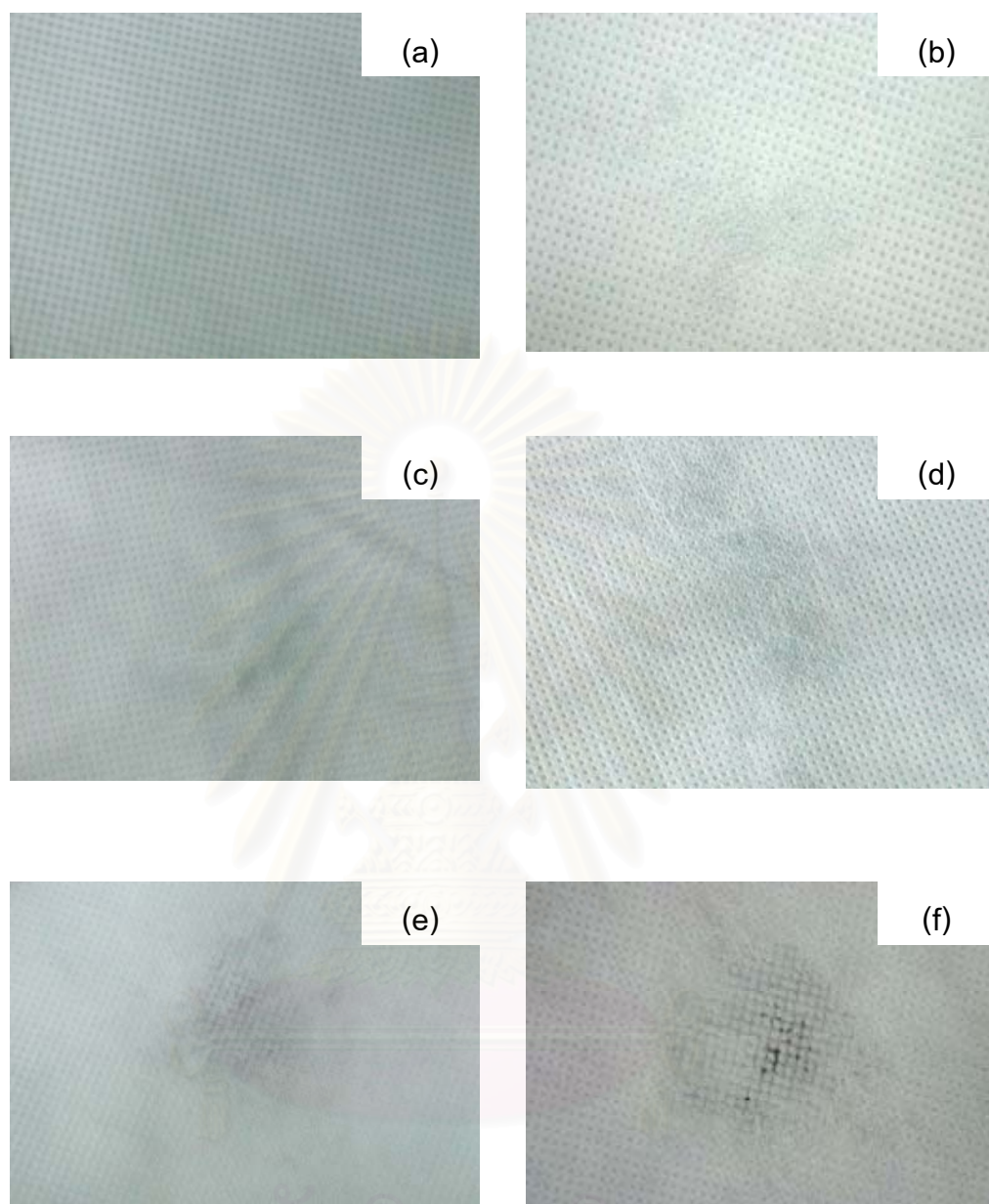

Figure 4.1 Surfaces of unmodified polypropylene nonwoven (a) and modified polypropylene nonwovens using plasma focus at 1 shot (b), 2 shots (c), 3 shots (d), 4 shots (e) and 5 shots (f)

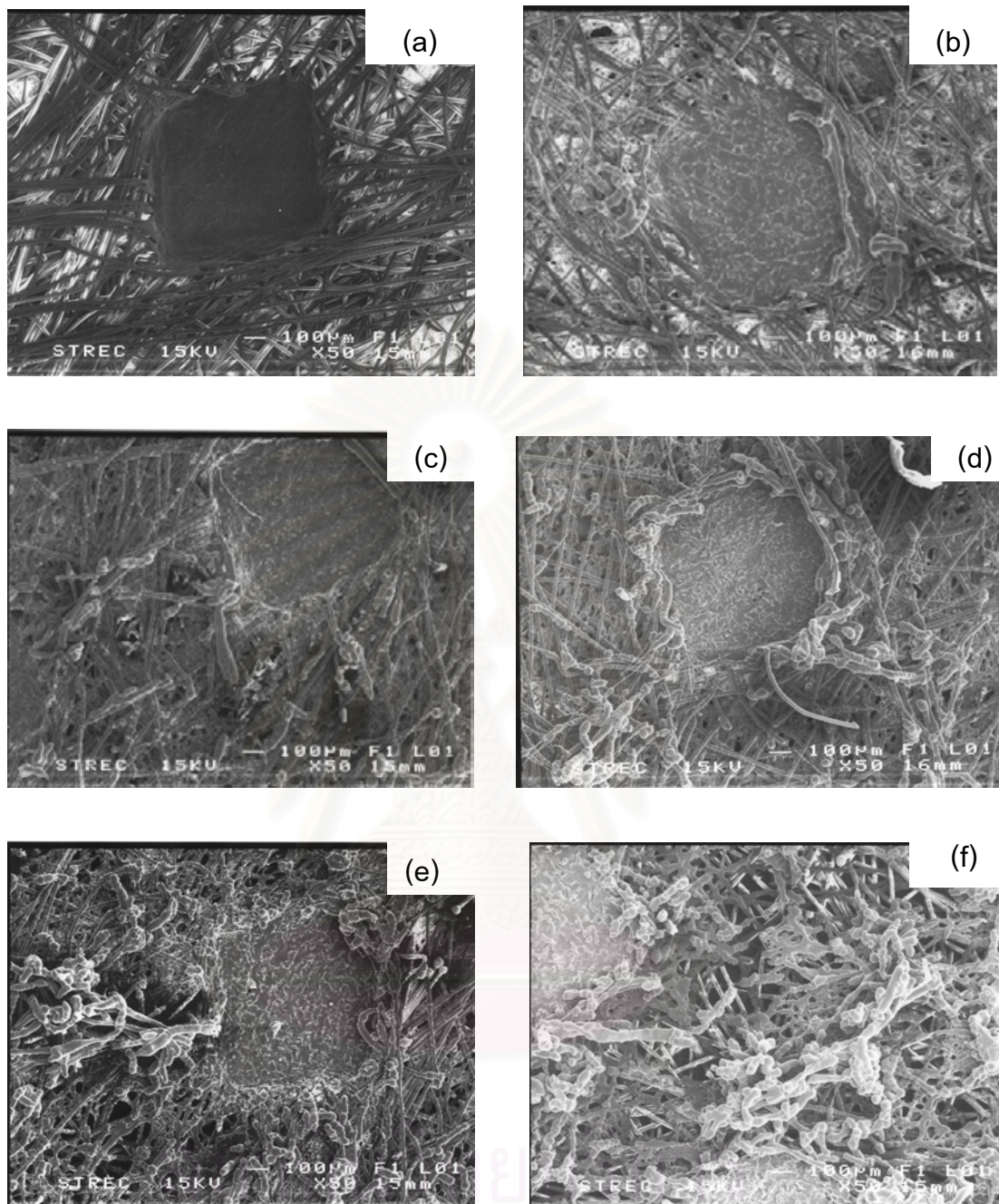

Figure 4.2 SEM photographs at 50X of the surfaces of unmodified polypropylene nonwoven (a) and modified polypropylene nonwovens using plasma focus at 1 shot (b), 2 shots (c), 3 shots (d), 4 shots (e) and 5 shots (f)

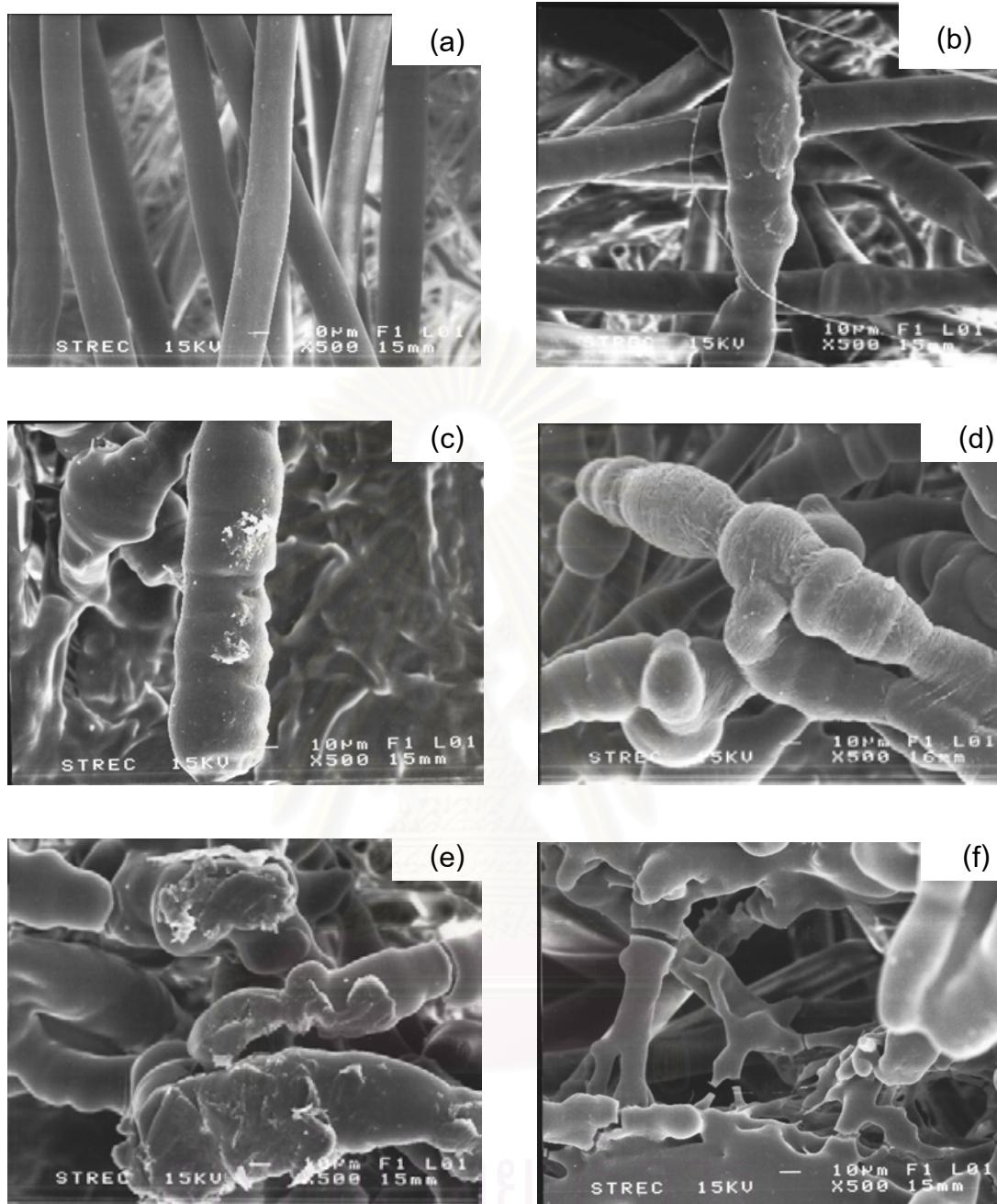

Figure 4.3 SEM photographs at 500X of the surfaces of unmodified polypropylene nonwoven (a) and modified polypropylene nonwovens using plasma focus at 1 shot (b), 2 shots (c), 3 shots (d), 4 shots (e) and 5 shots (f)

4.1.2 Water Contact Angle

Measurement of water contact angle can show hydrophilicity and hydrophobicity of a material. The higher the water contact angle, the more hydrophobicity of a material. This means that water-drops were in round or almost round shape on the surface of a material. On the other hand, lower water contact angle indicates that water-drop is flat on the surface of a material and can easily diffuse through the surface. This material exhibits hydrophilic characteristic.

The water contact angles of unmodified and modified polypropylene nonwovens are shown in Table 4.1

Table 4.1 Water contact angles of unmodified and modified polypropylene nonwovens

Type of Polypropylene Nonwovens	Water Contact Angle (degree)
Unmodified	111.0±1.58
Modified with 1 plasma shot	106.0±1.00
Modified with 2 plasma shots	105.4±1.14
Modified with 3 plasma shots	102.2±1.48
Modified with 4 plasma shots	99.2±1.30
Modified with 5 plasma shots	95.4±2.79

From Table 4.1, it can be seen that unmodified polypropylene nonwoven has higher water contact angle than all modified polypropylene nonwovens. As the number of plasma shots increases, the water contact angles of modified polypropylene nonwovens decrease indicating that the fabric becomes more hydrophilic. This suggests the formation of some polar functional groups on the fabric.

For further characterizations and preparation of the composites, polypropylene nonwovens modified with plasma shots of 1, 3 and 4 shots were used. Polypropylene nonwoven modified with 2 plasma shots was not selected because it exhibited similar water contact angle and morphology as same as that modified with 1 plasma shot; hence, it had similar surface characteristics. Therefore, it is better to use the fabric prepared with lower plasma shot when energy conservation is considered. In the case of polypropylene nonwoven modified with 5 plasma shots, it was not used because it exhibited severe degradation of the surface (burning marks) as shown in Figure 4.1f.

4.1.3 Water Absorption

As shown in Figure 4.4, percentages of water absorption of unmodified and all modified polypropylene sharply increase in the first 4 hours. After that all graphs slightly increase and almost stable from 120-163 hours. Percentages of water absorption of all modified polypropylene nonwovens are higher than that of unmodified fabric and they increase as the number of plasma shots exposed to the fabric increase from 1, 3 and 4, respectively. These results are in conclusive with those of water contact angle measurement. This also suggests the formation of some polar functional groups on the fabric.

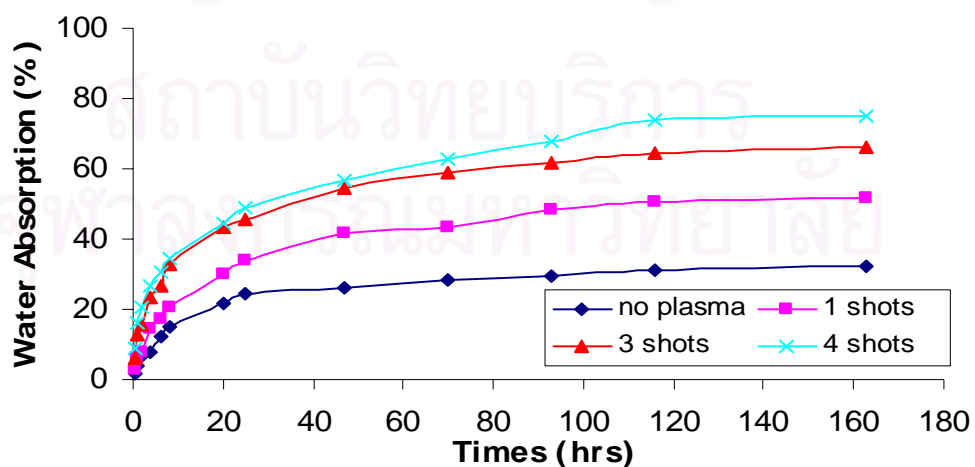
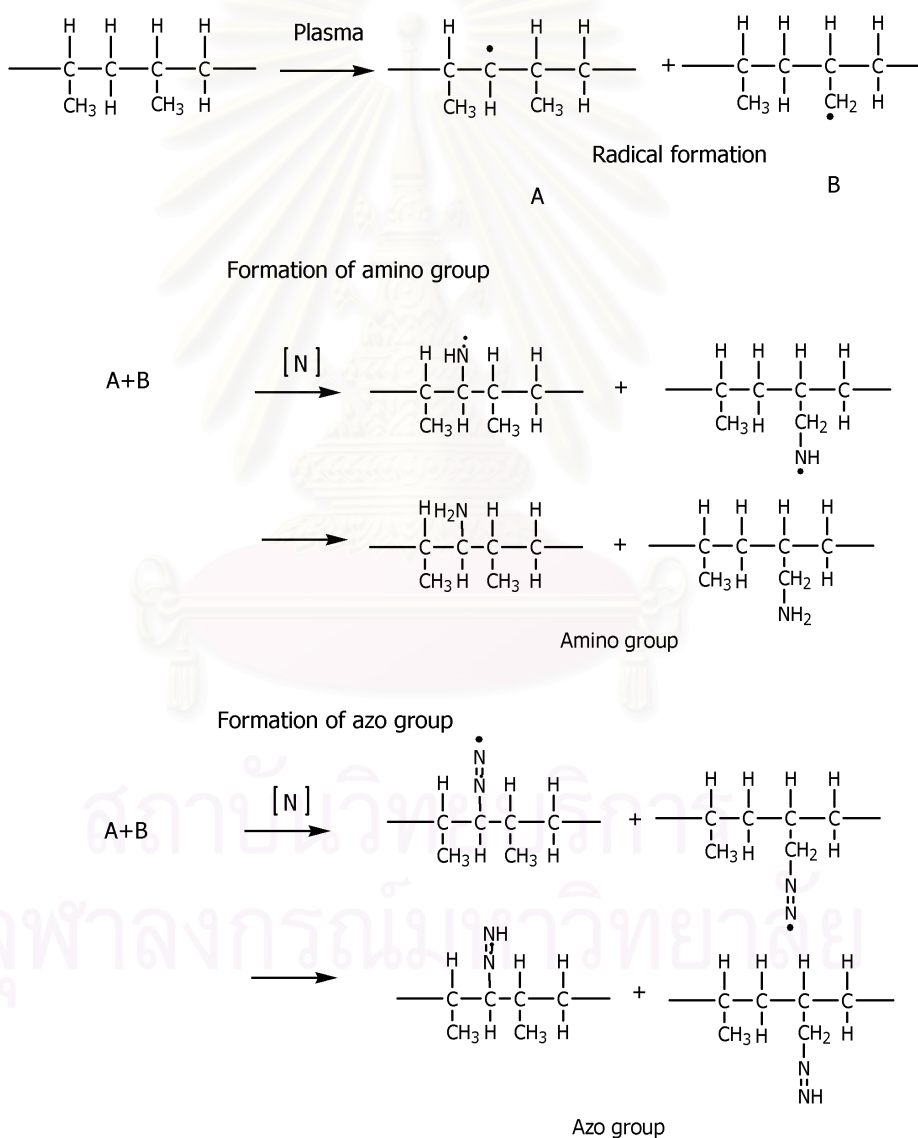

Figure 4.4 Water absorption of unmodified polypropylene nonwoven and modified polypropylene nonwovens using plasma focus at 1, 3 and 4 shots

4.1.4 Chemical Structure

The results obtained from water contact angle measurement and water absorption determination suggest the formation of some hydrophilic functional groups on the surface of PP nonwoven after exposed to nitrogen plasma. It was reported by Inagaki et al [16] that such functional groups can be nitrogen-containing groups. The possible mechanism for the formation of nitrogen-containing groups such as amino (NH_2) and azo ($-\text{N}=\text{N}-\text{H}$) groups can be proposed as follows:



From the proposed mechanism, when compared to FT-IR spectrum of unmodified PP nonwoven as shown in Figure 4.5, a relatively increase in the intensity of the peak corresponding to NH stretchings of NH_2 and $-\text{N}=\text{N}-\text{H}$ groups at wavenumber

of $3400\text{--}3500\text{ cm}^{-1}$ and a relatively decrease in the intensities of the peaks attributed to C-H bendings of CH_2 and CH_3 groups at wavenumbers of 1451 cm^{-1} and 1375 cm^{-1} , respectively are observed in FT-IR spectra of surface-modified PP nonwovens. However, the observation is not clearly seen due to low amount of NH_2 groups was formed. This is in conclusive with slightly change in water contact angle of these surface-modified PP nonwovens.

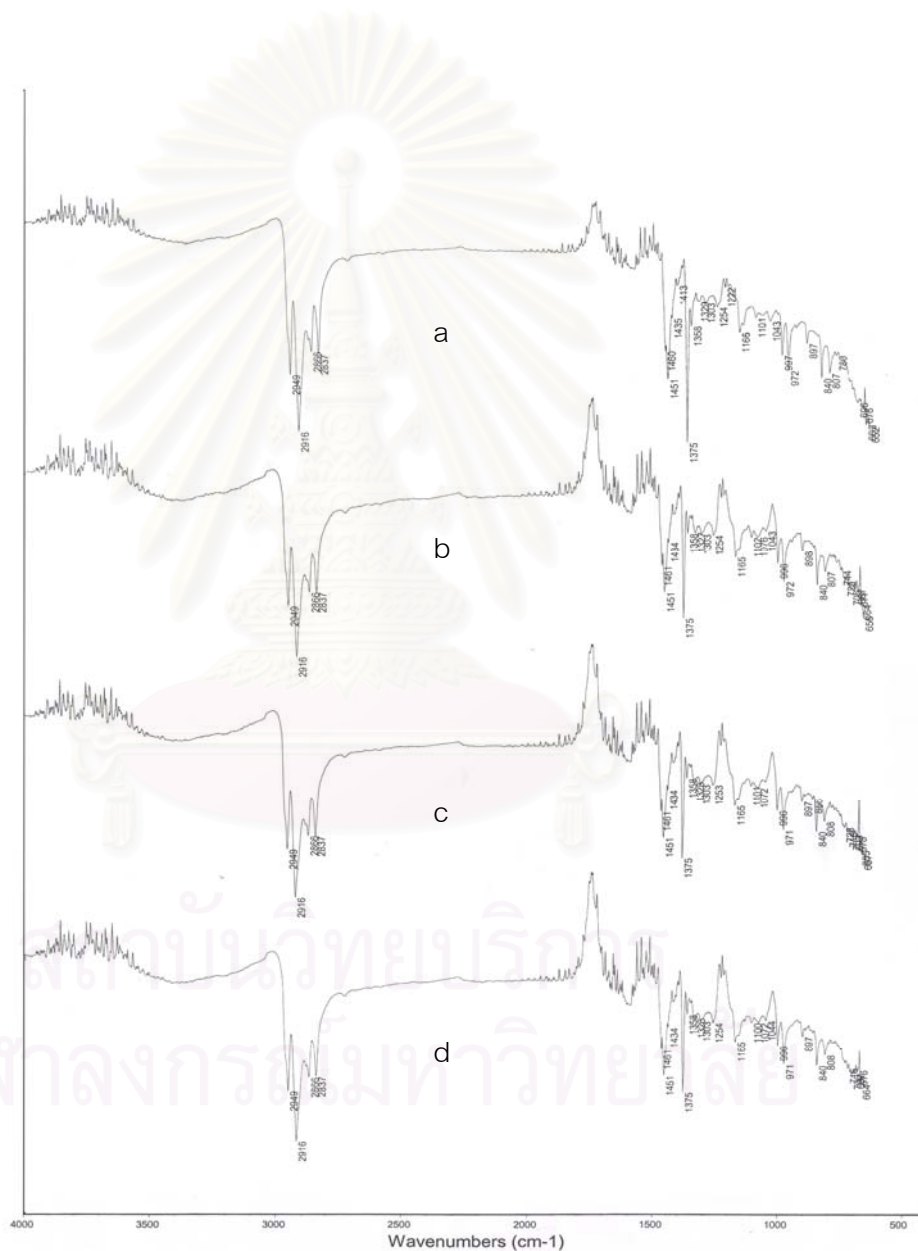

Figure 4.5 ATR/FT-IR spectra of unmodified polypropylene nonwoven (a) and modified polypropylene nonwovens using plasma focus at 1 shot (b), 3 shots (c) and 4 shots (d)

4.2 Mechanical Properties of Polypropylene-Polyester/Cotton Composites

Polypropylene-polyester/cotton (PP-PET/C) composites were prepared by compression molding. Both unmodified and modified PP nonwovens were compressed with PET/C nonwoven at 190°C for 12 minutes using various ratios of PP and PET/C nonwovens. Comparison of the mechanical properties of PP-PET/C composites with those of pure polypropylene is presented in this section. This section will focus on the effects of PET/C nonwoven content and surface modification of PP nonwoven on the tensile, flexural and impact properties of PP-PET/C composites.

4.2.1 Tensile Properties

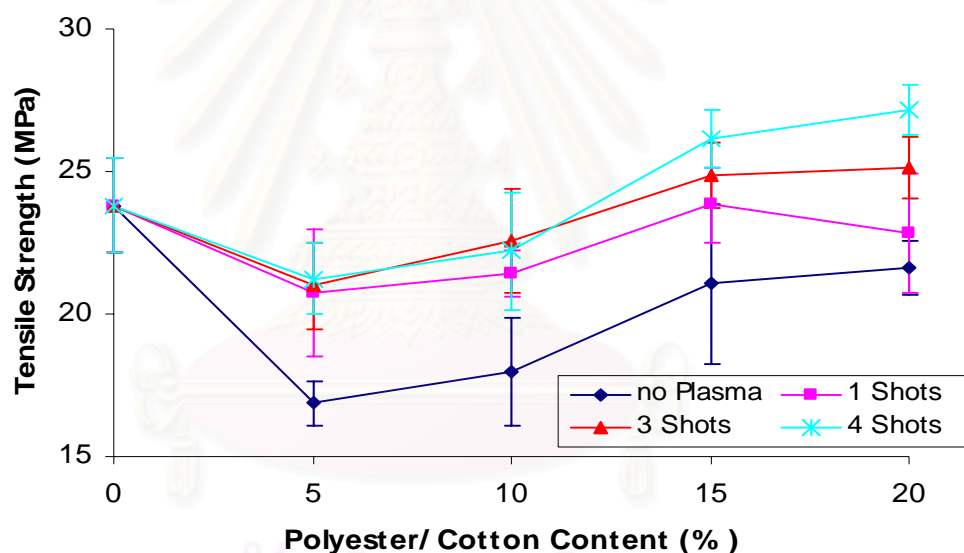

Figure 4.6 Tensile strength of pure polypropylene and polypropylene-polyester/cotton composites

From Figure 4.6, it is clearly seen that surface modification of PP nonwoven significantly affects tensile strength of PP-PET/C composites. This property increases with increasing the number of plasma shots exposed to PP. This may be a result of an increase in surface adhesion between PP and PET/C molecules which caused by a presence of hydrophilic groups and an increase in adhered area on PP surface after plasma exposure as presented in previous sections. At low or no plasma exposure,

there are not enough surface adhesion between PET/C fibers and PP matrix; consequently, tensile strength of PP-PET/C composites prepared at these conditions is lower than that of pure PP.

Figure 4.6 also shows that tensile strength of PP-PET/C composites increases as PET/C content increases. This is because PET/C molecules can interact with stronger bonds such as hydrogen bonds than PP molecules which can only interact by Van der Waals force, therefore, increasing in the amount of PET/C content indicating more stronger bonds are formed in the composites. However, at low PET/C content, PET/C fibers do not act as reinforcing fillers due to low stronger bonds are formed; therefore, PP-PET/C composites prepared at these conditions is lower than that of pure PP.

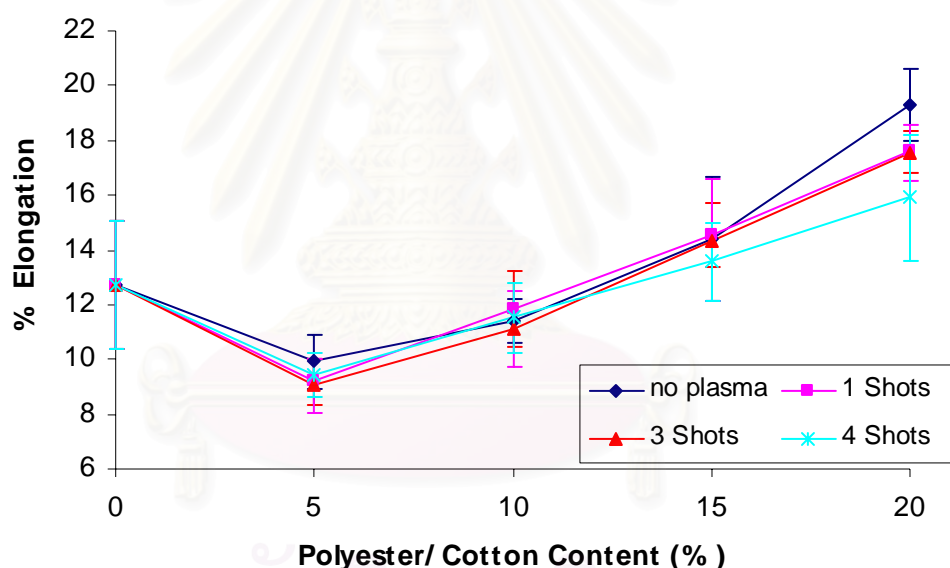

Figure 4.7 % Elongation of pure polypropylene and polypropylene-polyester/cotton composites

Adding PET/C filler to PP matrix disturbs the orientation of PP molecules; hence, less crystalline regions are formed when compared to pure PP. Consequently, %elongation of the composites increases with increasing the amount of PET/C filler as shown in Figure 4.7. The results also suggest that the effect of PET/C content on this property overshadows the effect of surface modification.

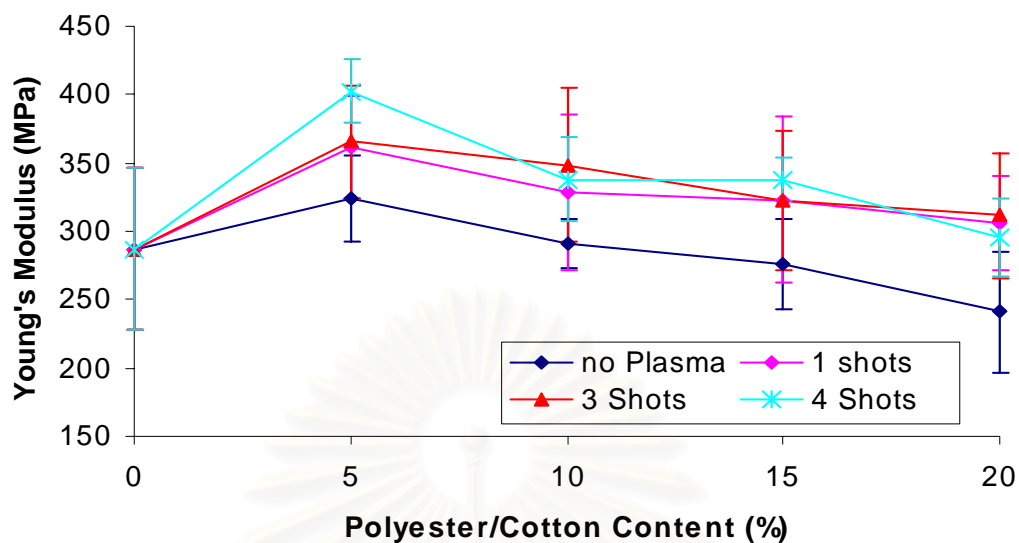

Figure 4.8 Young's modulus of pure polypropylene and polypropylene-polyester/cotton composites

When considering effect of surface modification on Young's modulus, it is clearly seen that an increase in surface adhesion between PET/C filler and PP matrix results in an increase in Young's modulus of the composites. However, due to an increase in %elongation when higher PET/C filler content was used, Young's modulus tends to decrease as the amount of PET/C filler increases as shown in Figure 4.8.

4.2.2 Flexural properties

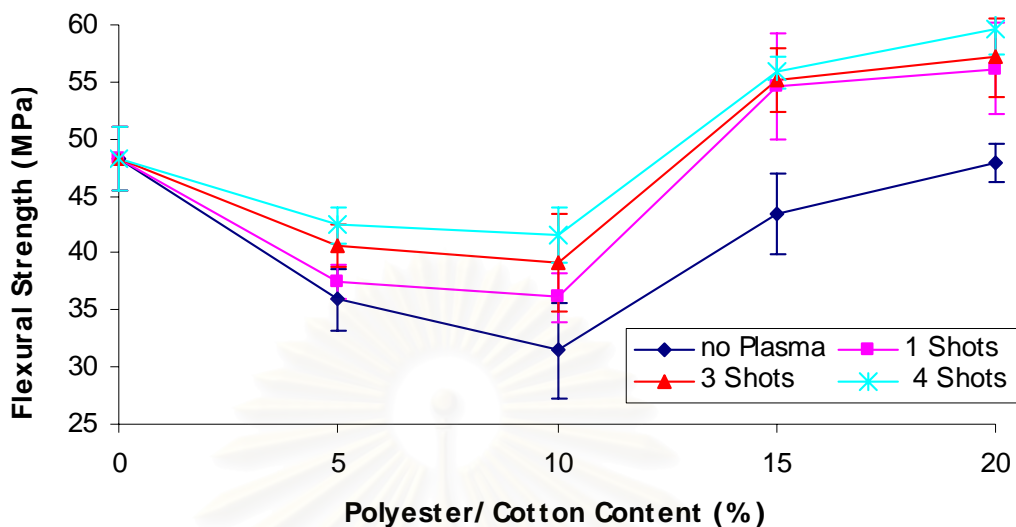

Figure 4.9 Flexural strength of pure polypropylene and polypropylene-polyester/cotton composites

Figure 4.9 shows that the effect of surface modification on flexural strength of PP-PET/C composites is similar to that of tensile strength. Flexural strength also increases with increasing the number of plasma shots exposed to PP. This may be also a result of an increase in surface adhesion between PP and PET/C molecules which caused by a presence of hydrophilic groups and an increase in adhered area on PP surface after plasma exposure. At low or no plasma exposure, there are not enough surface adhesion between PET/C fibers and PP matrix; consequently, flexural strength of PP-PET/C composites prepared at these conditions is lower than that of pure PP.

Figure 4.9 also shows that flexural strength of PP-PET/C composites increases as PET/C content increases. The effect and the causes of this effect are also similar to that of tensile strength.

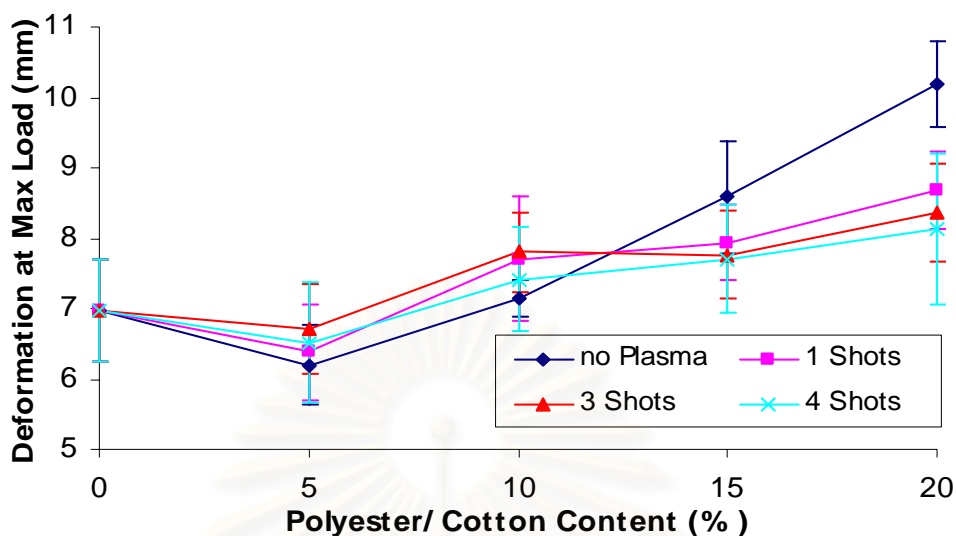

Figure 4.10 Deformation at maximum load of pure polypropylene and polypropylene-polyester/cotton composites

The effect of PET/C filler content on deformation as shown in Figure 4.10 is the same as that of %elongation shown in Figure 4.7. The results also suggest that the effect of PET/C content on this property overshadows the effect of surface modification at low PET/C filler content. However, at high PET/C filler content, deformation of the composites prepared from unmodified PP nonwoven is higher than those of the composites prepared from surface-modified PP nonwovens. In the case of the latter, their deformation decreases with increasing the number of plasma shots. This suggests that as surface adhesion between the two components increases, it is more difficult for polymer molecules to move apart from each other.

จุฬาลงกรณ์มหาวิทยาลัย

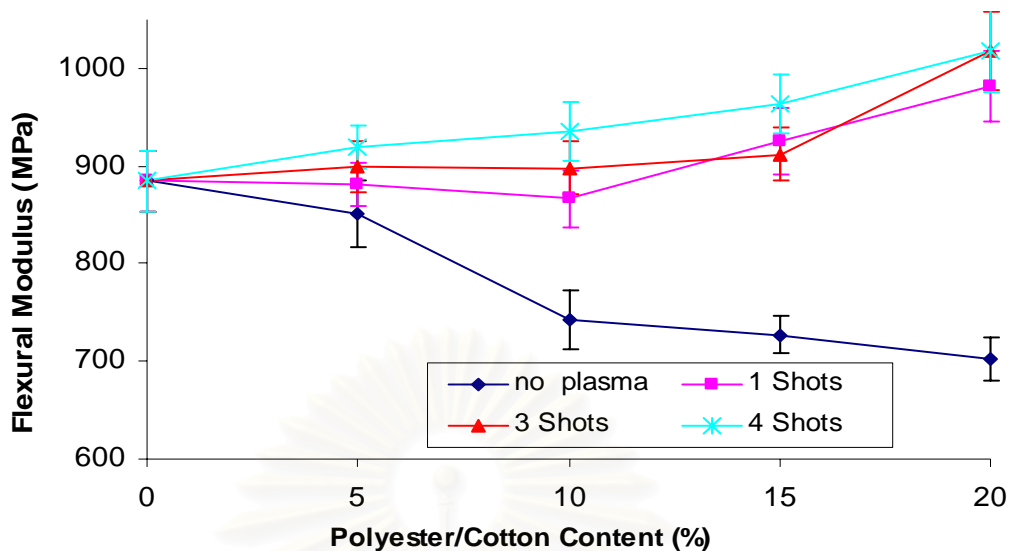

Figure 4.11 Flexural modulus of pure polypropylene and polypropylene-polyester/cotton composites

The effect of surface modification and PET/C filler content on flexural modulus can be divided into two cases. In the case of the composites prepared from unmodified PP nonwoven, it is clearly seen from Figure 4.11 that flexural modulus decreases as PET/C filler content increases. This is because the deformation of the composites is easier to occur when the amount of PET/C filler increases as previously discussed. Therefore, less flexural force is needed to deform the specimens. In the case of the composites prepared from surface-modified PP nonwoven, flexural modulus increases as PET/C filler content and/or the number of plasma shots exposed to the fabric increase. This is because higher surface adhesion is obtained; consequently, stronger force is needed in order to deform the specimens.

4.2.3 Impact Strength

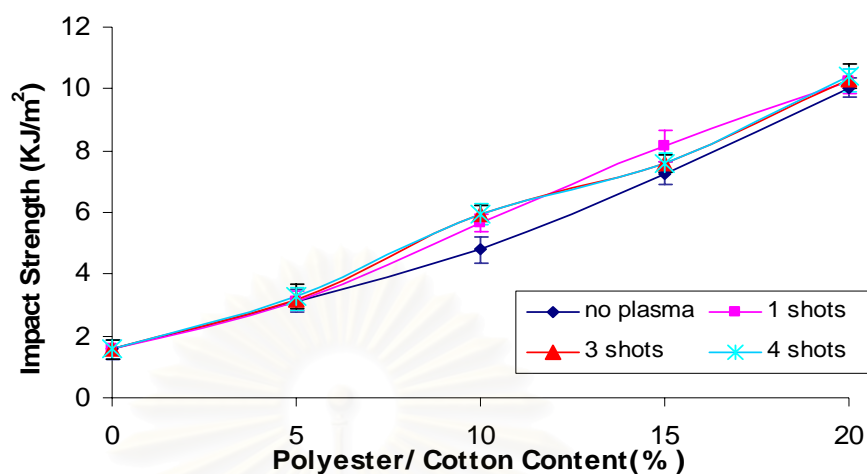

Figure 4.12 Impact strength of pure polypropylene and polypropylene-polyester/cotton composites

It is clearly seen from Figure 4.12 that surface modification does not affect the impact strength of the composites. The impact strength of all composites prepared from both modified and unmodified PP nonwoven is comparable. On the other hand, PET/C filler content exhibits significant effect on this property. Impact strength of the composites increases as PET/C filler content increases. This is due to the fact that PET/C fibers are more flexible than PP matrix; therefore, the energy absorption from impact load is better in the composites having higher PET/C filler content.

4.3 Morphology Studies of Polypropylene-Polyester/Cotton Composites

Figure 4.13 shows fractured surfaces of 20% PET/C-filled composites. Polyester fibers are in circular shape while cotton fibers are in flat rectangular shape. It can be seen from Figure 4.13a that there is no contact between PP matrix and cotton fiber due to their difference in hydrophilic characteristic. While hydrophobic PP has interaction with semi-hydrophobic polyester, it cannot interact with hydrophilic cellulose of cotton fibers. On the other hand, hydrophilic groups occurred on PP surface after plasma exposure increase hydrophilic characteristic of PP; therefore, from Figures 4.13b -4.13d, it is clearly seen the interaction between PP matrix and cotton fibers.

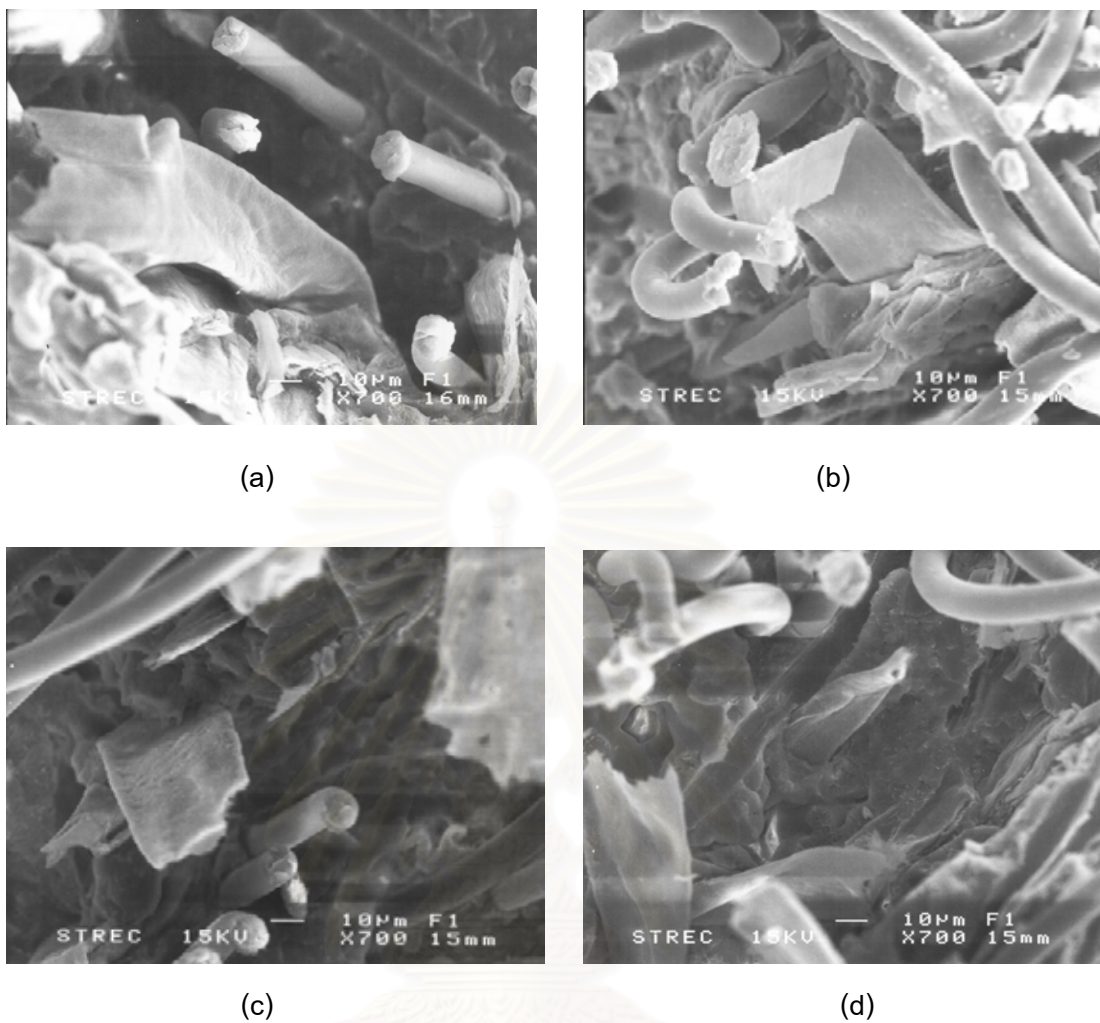

Figure 4.13 SEM micrographs of impact fractured surface of 20% PET/C-filled composites prepared from unmodified PP nonwoven (a) and modified polypropylene nonwovens using plasma focus at 1 shot (b), 3 shots (c) and 4 shots (d)

สถาบันวิทยบริการ
จุฬาลงกรณ์มหาวิทยาลัย

CHAPTER V

CONCLUSIONS AND RECOMMENDATIONS

5.1 Conclusions

Surface modification of polypropylene (PP) nonwoven using plasma generated as discontinuous shots from a plasma focus device to enhance interfacial adhesion between PP matrix and polyester/cotton (PET/C) reinforcing filler of PP-PET/C composites was investigated. From SEM and FT-IR spectroscopic analysis, water contact angle and water absorption measurements, it was found that the roughness and hydrophilic characteristic of PP surface increased as the number of plasma shots was increased from 1, 2, 3, 4 to 5 shots. However, at higher numbers of plasma shots applied, the degradation of PP surface increased. Therefore, PP nonwoven exposed with 5 plasma shots was not used for composite preparation due to the presence of burning marks on its surface.

The mechanical properties of PP-PET/C composites prepared from various amount of unmodified and surface-modified PP nonwovens were tested and the results can be concluded as follows:

1. Tensile properties of PP-PET/C composites prepared from surface-modified PP nonwovens were higher than those of PP-PET/C composites prepared from unmodified PP nonwoven and also higher than those of pure PP at higher degree of modification and higher PET/C filler content. It was also found that increasing number of plasma shots exposed to PP nonwoven and/or PET/C filler content increased the tensile properties of the composites.

2. Flexural properties of PP-PET/C composites prepared from surface-modified PP nonwovens were higher than those of PP-PET/C composites prepared from unmodified PP nonwoven and also higher than those of pure PP at higher degree of modification and higher PET/C filler content. It was also found that increasing number of

plasma shots exposed to PP nonwoven and/or PET/C filler content increased the tensile properties of the composites.

3. Impact strength of PP-PET/C composites was significantly affected the amount of PET/C filler in the composites. It was found that this property increased with increasing PET/C filler content. This effect overshadowed the effect of degree of modification on this property. However, impact strength of all PP-PET/C composites prepared from surface-modified PP nonwovens were higher than those of PP-PET/C composites prepared from unmodified PP nonwoven and pure PP.

The above results indicated that interfacial adhesion between PP matrix and polyester/cotton (PET/C) reinforcing filler of PP-PET/C composites was increased by surface modification of polypropylene (PP) nonwoven using plasma generated as discontinuous shots from a plasma focus device. The results also suggested that the composite prepared from PP nonwoven surface-modified with 4 plasma shots and PET/C nonwoven 20% by weight exhibited the best mechanical properties.

5.2 Recommendations

As the above results indicated that surface modification of polypropylene (PP) nonwoven using a plasma focus device operated with nitrogen can enhance interfacial adhesion between PP matrix and polyester/cotton (PET/C) reinforcing filler of PP-PET/C composites, therefore, further experiments can also be studied by using these results as reference. These experiments can possibly be done by changing the type of the gas from nitrogen to gases such as oxygen and argon or changing charging voltage.

REFERENCES

1. Gibson, R.F. Principles of Composite Material Mechanics. New York : Mc Graw-Hill, 1994.
2. Reinhart, T.J., and Clements, L.L. Engineered Materials Handbook. Ohio : ASM International, 1989.
3. Richardson, T. Composites: A Design Guide. New York : Industrial Press Inc., 1987.
4. Gachter, R., and Muller, H. Plastics Additives Handbook. New York : Houser Publishers, 1987.
5. Rosalind, J. Polypropylene. Modern Plastics Encyclopedia. Mid-October. U.S.A : Mc Graw-Hill, (1989) : 98-101.
6. Odian, G. Principle of Polymerization. 3rd ed. New York : John Wiley & Sons, 1990.
7. Rubin, I.I. Handbook of Plastic Materials and Technology. New York : John Wiley & Sons, 1990.
8. Demianiw, D.G. Olefin Polymer (polypropylene). Encyclopedia of Chemical Technology. 16 (1981) : 454.
9. Colling, D.A and Vasilos, T. Industrial Materials. Vol.2. New Jersey : Prentice-Hall, 1995.
10. Jone, R.F. Guide to Short Fiber Reinforced Plastics. Munich : Hanser Publishers, 1998.
11. Schwartz, M.M. Composite Materials : Properties, Nondestructive Testing and Repair. Vol.1. New Jersey : Prentice Hall PTR, 1997.
12. Albrecht, W., Fuchs, H, and Kitemann, W. Nonwoven Fabrics. WILEY-VCH, 2003.
13. Huttotuwa, G.B., Ismial, H., and Baharin, A. Comparison of the mechanical properties of rice husk powder filled polypropylene composites with talc filled polypropylene composites. Polymer Testing. 21 (2002) : 833-839.
14. Wambua, P., Ivens, J., and Verpoest, I. Natural fibers: can they replace glass in fiber reinforced plastics. Composites Science and Technology 63 (2003) : 1259-1264.

15. Santos, P. and Pezzin, S.H. Mechanical properties of polypropylene reinforced with recycled-pet fibers. Journal of Materials Processing Technology 143-144 (2003): 517-520.
16. Inagaki, N. Hydrophilic Surface (Plasma Treatment and Plasma Polymerization) Surfaces, 3115-3123. : CRC Press, 1996.
17. Karger-Kocsis, J. Polypropylene: Composites. Vol.3. London : Chapman & Hall, 1995.
18. Felix, J.M., and Gatenholm, P. The Nature of Adhesion in Composites of Modified Cellulose Fibers and Polypropylene. Journal of Applied Polymer Science 42 (1991) : 351-362.
19. Bledzki, A.K., Reihmance, S., and Gassen, J. Properties and Modification Methods for Vegetable Fibers. Journal of Applied Polymer Science 59 (1996) : 1329-1336.
20. Wu, J., Yu, D., Chan, C.M. and Kim, J. Effect of Fiber Pretreatment Condition on the Interfacial Strength and Mechanical Properties of wood Fiber/ PP Composites. Journal of Applied Polymer Science 76 (2000) : 1000-1010.
21. Denes, F.S., and Manolache, S. Macromolecular plasma-chemistry: an emerging field of polymer science. Progress in Polymer Science 29 (2004) : 815-885.
22. Strobel, M.. Plasma Surface Modification of Polymer. Utrecht. Netherland : VSP, 1994.
23. Shirasuma T., Aoike T., Akiyama K., Murayama H., Otsuka T. Tazawa D., Horoi K. and Abe Y. Plasma Treatment Apparatus. United States Patent (2004).
24. Dusit Ngamrunroj. Plasma focus modification for material surface treatment. Master's Thesis, Department of Physical Science, Faculty of Science, Chulalongkorn University, 2002.
25. Caiazza, F., Canonico, P., Nigoo, R., and Tagliaferri, V. Electrode Discharge for Plasma Surface Treatment of Polymeric Materials. Journal of Materials Processing Technology 58 (1996) : 96-99.
26. Kan, C.W., Chan, K., Yuen C.W.M., and Miao, M.H. Surface properties of low-temperature plasma treated wool fabrics. Journal of Materials Processing Technology 83 (1998) : 180-184.

27. Carrino, L., Moroni, G., and Polini, W. Cold plasma treatment of polypropylene surface: a study on wettability and adhesion. Journal of Materials Processing Technology 121 (2002) : 373-382.
28. Simor, M., Rahel, J. and Emak, M. Atmospheric-pressure plasma treatment of polyester nonwoven fabrics for electroless plating Surface and Coating Technology 172 (2003) : 1-6.
29. Rahel, J. Simor, M. and Emak, M. Hydrophilization of polypropylene nonwoven fabric using surface barrier discharge. Surface and Coating Technology 172 (2003) : 604-608.
30. Wei, Q.F. Surface characterization of plasma-treated polypropylene fibers. Materials Characterization 52 (2004) : 231-235.
31. Yuan, X., Jayaraman, K., and Bhattacharyya, D. Effects of plasma treatment in enhancing the performance of woodfiber-polypropylene composites. Composites Part A: Applied Science and Manufacturing 35 (2004) : 1263-1374.



APPENDICES

สถาบันวิทยบริการ
จุฬาลงกรณ์มหาวิทยาลัย

Appendix A

Polypropylene Nonwovens

Table A 1 Experimental data of Water contact angles of polypropylene nonwovens

Sample No.	Unmodified PP Nonwoven	Modified of PP nonwoven				
		1 Shots	2 Shots	3 Shots	4 Shots	5 Shots
1	110	107	105	103	98	92
2	111	105	107	102	99	98
3	109	107	104	104	101	98
4	112	103	105	100	100	93
5	113	106	106	102	98	96
Mean	111.0	106.0	105.4	102.2	99.2	95.4
SD.	1.58	1.00	1.14	1.48	1.30	2.79

สถาบันวิทยบริการ
จุฬาลงกรณ์มหาวิทยาลัย

Table A 2 Experimental data of water absorption of polypropylene nonwoven

Sample	% Water Absorption of Polypropylene Nonwoven												
	0.5 hrs	1 hrs	2 hrs	4 hrs	6 hrs	8 hrs	20 hrs	25 hrs	47 hrs	70 hrs	93 hrs	116 hrs	163 hrs
Unmodified Polypropylene	1.5337	3.9877	6.4417	7.9754	11.9631	14.7239	21.4724	24.2331	26.0736	28.5276	29.4478	31.2883	32.2086
Modified Polypropylene at 1 shot	2.6666	6.2222	8.0000	14.2222	17.3333	20.4444	29.7778	33.7778	41.7778	43.5556	48.4444	50.6667	51.5556
Modified Polypropylene at 3 shots	6.2176	12.9533	15.5440	23.3160	26.9430	32.6425	43.5233	45.5958	54.4042	58.8083	61.6580	64.2487	66.3212
Modified Polypropylene at 4 shots	8.7542	16.1616	20.5387	26.9360	30.6397	34.3434	44.4444	49.1582	56.5656	62.9629	67.6767	74.0740	75.0841

Mechanical properties of PP and PP-PET/C Composites.

1. Polypropylene

Table A 3 Experimental data of tensile properties of polypropylene

Sample	Tensile Strength (MPa)	Young's Modulus (MPa)	% Elongation
1	21.87	300.1	10.81
2	25.35	365.17	10.66
3	23.58	311.98	11.80
4	25.6	244.08	15.63
5	22.56	213.15	14.79
Mean	23.79	286.90	12.74
SD.	1.65	59.59	2.32

Table A 4 Experimental data of flexural properties of polypropylene

Sample	Flexural Strength (MPa)	Flexural's Modulus (MPa)	Deformation at Max Load (mm)
1	49.62	908.88	7.324
2	46.61	879.52	5.608
3	48.19	841.77	7.210
4	49.93	921.23	7.172
5	48.56	872.82	7.172
Mean	48.58	884.844	6.9872
SD.	1.32	31.35	0.72

Table A 5 Experimental data of impact strength of the Polypropylene Composites

Sample	Impact Strength (KJ/m ²)
1	1.83
2	1.35
3	1.34
4	1.93
5	1.34
Mean	1.56
SD.	0.29

2. PP-PET/C Composites Prepared from Unmodified PP Nonwovens

Table A 6 Experimental data of tensile properties of PP-PET/C Composites using 5% of PET/C nonwovens

Sample	Tensile Strength (MPa)	Young's Modulus (MPa)	% Elongation
1	17.46	310.23	10.25
2	16.68	378.34	9.15
3	15.67	299.56	11.54
4	17.56	305.79	9.55
5	16.99	324.53	9.15
Mean	16.87	323.69	9.93
SD.	0.76	31.90	1.01

Table A 7 Experimental data of flexural properties of PP-PET/C Composites using 5% of PET/C nonwovens

Sample	Flexural strength (MPa)	Flexural 's Modulus (MPa)	Deformation at Max Load (mm)
1	38.00	809.81	6.22
2	36.80	869.79	5.80
3	32.68	821.97	7.01
4	34.83	859.12	6.26
5	36.72	893.04	5.61
Mean	35.81	850.75	6.20
SD.	2.08	34.37	0.57

Table A 8 Experimental data of impact strength of PP-PET/C Composites using 5% of PET/C nonwovens

Sample	Impact Strength (KJ/m ²)
1	2.81
2	3.29
3	3.42
4	2.64
5	3.47
Mean	3.13
SD.	0.38

Table A 9 Experimental data of tensile properties of PP-PET/C Composites using 10% of PET/C nonwovens

Sample	Tensile Strength (MPa)	Young's Modulus (MPa)	% Elongation
1	18.88	320.49	10.40
2	14.64	294.26	12.44
3	19.45	276.38	11.13
4	18.31	280.62	11.20
5	18.53	284.21	11.93
Mean	17.96	291.19	11.42
SD.	1.91	17.66	0.79

Table A 10 Experimental data of flexural properties of PP-PET/C Composites using 10% of PET/C nonwovens

Sample	Flexural Strength (MPa)	Flexural's Modulus (MPa)	Deformation at Max Load (mm)
1	30.85	744.11	7.10
2	33.57	779.06	6.88
3	29.44	697.07	6.92
4	34.40	737.64	7.42
5	28.49	753.85	7.42
Mean	31.35	742.35	7.15
SD.	2.56	29.81	0.26

Table A 11 Experimental data of impact strength of PP-PET/C Composites using 10% of PET/C nonwovens

Sample	Impact Strength (KJ/m ²)
1	8.24
2	8.08
3	8.70
4	8.11
5	8.51
Mean	8.33
SD.	0.27

Table A 12 Experimental data of tensile properties of PP-PET/C Composites using 15% of PET/C nonwovens

Sample	Tensile Strength (MPa)	Young's Modulus (MPa)	% Elongation
1	16.18	279.67	15.68
2	22.32	259.81	15.74
3	23.07	272.21	16.61
4	21.11	328.61	12.57
5	22.58	240.27	11.47
Mean	21.05	276.11	14.41
SD.	2.82	32.92	2.25

Table A 13 Experimental data of flexural properties of PP-PET/C Composites using 15% of PET/C nonwovens

Sample	Flexural Strength (MPa)	Flexural's Modulus (MPa)	Deformation at Max Load (mm)
1	41.6	717.38	8.78
2	42.95	741.67	9.58
3	44.18	749.47	8.97
4	48.78	702.18	7.48
5	39.38	726.26	8.10
Mean	43.38	727.39	8.58
SD.	3.51	18.90	0.81

Table A 14 Experimental data of impact strength of PP-PET/C Composites using 15% of PET/C nonwovens

Sample	Impact Strength (KJ/m ²)
1	9.86
2	8.94
3	9.84
4	8.30
5	8.33
Mean	9.06
SD.	0.77

Table A 15 Experimental data of tensile properties of PP-PET/C Composites using 20% of PET/C nonwovens

Sample	Tensile Strength (MPa)	Young's Modulus (MPa)	% Elongation
1	22.3	198.37	21.49
2	21.79	244.66	18.13
3	20.96	208.46	19.33
4	22.61	311.61	18.45
5	20.34	256.45	19.05
Mean	21.60	243.91	19.29
SD.	0.94	44.92	1.32

Table A 16 Experimental data of flexural properties of PP-PET/C Composites using 20% of PET/C nonwovens

Sample	Flexural Strength (MPa)	Flexural's Modulus (MPa)	Deformation at Max Load (mm)
1	50.56	726.34	9.39
2	47.28	695.35	10.34
3	47.54	687.89	10.43
4	45.71	724.78	10.98
5	48.28	679.77	9.78
Mean	47.87	702.77	10.18
SD.	1.77	21.56	0.61

Table A 17 Experimental data of impact strength of PP-PET/C Composites using 20% of PET/C nonwovens

Sample	Impact Strength (KJ/m ²)
1	10.40
2	12.94
3	12.45
4	10.23
5	10.16
Mean	11.24
SD.	1.35

3. PP-PET/C Composites Prepared from Surface-modified PP Nonwovens

Using a Plasma Focus at 1 shorts

Table A 18 Experimental data of tensile properties of PP-PET/C Composites using 5% of PET/C nonwovens

Sample	Tensile Strength (MPa)	Young's Modulus (MPa)	% Elongation
1	21.30	358.34	9.53
2	24.34	300.45	10.22
3	19.43	387.56	8.56
4	18.67	393.33	9.45
5	19.98	369.07	8.17
Mean	20.74	361.75	9.19
SD.	2.23	37.03	0.82

Table A 19 Experimental data of flexural properties of PP-PET/C Composites using 5% of PET/C nonwovens

Sample	Flexural Strength (MPa)	Flexural's Modulus (MPa)	Deformation at Max Load (mm)
1	35.09	899.14	6.35
2	38.67	850.92	7.13
3	38.73	867.94	6.79
4	37.76	901.45	5.37
5	37.00	885.83	6.26
Mean	37.45	881.06	6.38
SD.	1.50	21.48	0.67

Table A 20 Experimental data of impact strength of PP-PET/C Composites using 5% of PET/C nonwovens

Sample	Impact Strength (KJ/m ²)
1	2.92
2	3.50
3	2.94
4	3.41
5	2.82
Mean	3.12
SD.	0.31

Table A 21 Experimental data of tensile properties of PP-PET/C Composites using 10% of PET/C nonwovens

Sample	Tensile Strength (MPa)	Young's Modulus (MPa)	% Elongation
1	20.82	313.23	12.22
2	21.81	299.65	13.40
3	21.56	273.55	9.68
4	22.44	330.92	11.56
5	20.47	422.82	12.49
Mean	21.42	328.03	11.87
SD.	0.79	56.98	1.39

Table A 22 Experimental data of flexural properties of PP-PET/C Composites using 10% of PET/C nonwovens

Sample	Flexural Strength (MPa)	Flexural's Modulus (MPa)	Deformation at Max Load (mm)
1	35.49	875.11	8.35
2	33.14	859.79	7.13
3	35.60	819.79	6.79
4	37.85	878.53	7.37
5	38.38	898.34	8.93
Mean	36.09	866.31	7.71
SD.	2.10	29.41	0.89

Table A 23 Experimental data of impact strength of PP-PET/C Composites using 10% of PET/C nonwovens

Sample	Impact Strength (KJ/m ²)
1	6.10
2	5.43
3	5.74
4	5.46
5	5.53
Mean	5.65
SD.	0.28

Table A 24 Experimental data of tensile properties of PP-PET/C Composites using 15% of PET/C nonwovens

Sample	Tensile Strength (MPa)	Young's Modulus (MPa)	% Elongation
1	22.99	300.34	15.75
2	22.33	301.34	12.64
3	25.67	422.99	14.56
4	24.56	267.99	14.78
5	23.67	299.46	14.99
Mean	23.84	323.17	14.54
SD.	1.31	60.12	1.52

Table A 25 Experimental data of flexural properties of PP-PET/C Composites using 15% of PET/C nonwovens

Sample	Flexural Strength (MPa)	Flexural's Modulus (MPa)	Deformation at Max Load (mm)
1	49.56	968.23	8.57
2	54.56	948.59	7.45
3	55.95	883.21	8.47
4	52.56	923.12	7.45
5	59.06	902.34	7.78
Mean	54.34	925.10	7.94
SD.	3.57	34.24	0.54

Table A 26 Experimental data of impact strength of PP-PET/C Composites using 15% of PET/C nonwovens

Sample	Impact Strength (KJ/m ²)
1	8.43
2	8.95
3	7.87
4	7.73
5	7.81
Mean	8.16
SD.	0.52

Table A 27 Experimental data of tensile properties of PP-PET/C Composites using 20% of PET/C nonwovens

Sample	Tensile Strength (MPa)	Young's Modulus (MPa)	% Elongation
1	21.45	289.98	16.43
2	21.32	288.56	18.26
3	21.19	266.46	17.83
4	25.65	350.08	17.25
5	24.56	334.44	18.15
Mean	22.83	305.90	17.58
SD.	2.11	34.91	0.76

Table A 28 Experimental data of flexural properties of PP-PET/C Composites using 20% of PET/C nonwovens

Sample	Flexural Strength (MPa)	Flexural's Modulus (MPa)	Deformation at Max Load (mm)
1	60.46	1008.07	9.33
2	59.09	919.22	8.00
3	54.53	979.82	9.12
4	54.36	997.53	8.57
5	53.98	1002.82	8.34
Mean	56.49	981.49	8.67
SD.	3.05	36.40	0.55

Table A 29 Experimental data of impact strength of PP-PET/C Composites using 20% of PET/C nonwovens

Sample	Impact Strength (KJ/m ²)
1	10.30
2	10.33
3	9.67
4	10.78
5	10.07
Mean	10.23
SD.	0.40

4. PP-PET/C Composites Prepared from Surface-modified PP Nonwovens

Using a Plasma Focus at 3 shorts

Table A 30 Experimental data of tensile properties of PP-PET/C Composites using 5% of PET/C nonwovens

Sample	Tensile Strength (MPa)	Young's Modulus (MPa)	% Elongation
1	23.29	398.71	8.34
2	21.78	386.98	8.80
3	20.17	294.94	7.97
4	19.41	385.44	9.78
5	20.23	360.99	10.35
Mean	20.98	365.41	9.05
SD.	1.55	41.72	1.00

Table A 31 Experimental data of flexural properties of PP-PET/C Composites using 5% of PET/C nonwovens

Sample	Flexural Strength (MPa)	Flexural's Modulus (MPa)	Deformation at Max Load (mm)
1	40.71	913.73	6.35
2	39.64	888.39	5.79
3	38.03	934.23	6.93
4	43.07	893.68	7.13
5	41.67	866.23	7.39
Mean	40.64	899.25	6.72
SD.	1.92	25.85	0.64

Table A 32 Experimental data of impact strength of PP-PET/C Composites using 5% of PET/C nonwovens

Sample	Impact Strength (KJ/m ²)
1	2.66
2	3.10
3	3.43
4	3.62
5	3.11
Mean	3.18
SD.	0.37

Table A 33 Experimental data of tensile properties of PP-PET/C Composites using 10% of PET/C nonwovens

Sample	Tensile Strength (MPa)	Young's Modulus (MPa)	% Elongation
1	23.47	423.09	10.6
2	23.42	298.74	12.58
3	19.41	348.54	9.73
4	22.54	383.39	10.07
5	24.01	289.36	12.57
Mean	22.57	348.62	11.11
SD.	1.84	56.47	1.37

Table A 34 Experimental data of flexural properties of PP-PET/C Composites using 10% of PET/C nonwovens

Sample	Flexural Strength (MPa)	Flexural's Modulus (MPa)	Deformation at Max Load (mm)
1	39.90	930.87	7.66
2	33.25	884.34	6.97
3	44.51	923.45	8.05
4	37.09	876.38	7.87
5	41.23	873.94	8.48
Mean	39.19	897.80	7.80
SD.	4.26	27.21	0.56

Table A 35 Experimental data of impact strength of PP-PET/C Composites using 10% of PET/C nonwovens

Sample	Impact Strength (KJ/m ²)
1	5.68
2	5.63
3	6.40
4	5.73
5	60.2
Mean	5.93
SD.	0.35

Table A 36 Experimental data of tensile properties of PP-PET/C Composites using 15% of PET/C nonwovens

Sample	Tensile Strength (MPa)	Young's Modulus (MPa)	% Elongation
1	25.6	339.97	14.52
2	24.96	358.78	10.46
3	22.98	364.54	15.86
4	24.79	240.67	15.45
5	25.94	306.43	15.45
Mean	24.85	322.08	14.35
SD.	1.15	50.85	2.23

Table A 37 Experimental data of flexural properties of PP-PET/C Composites using 15% of PET/C nonwovens

Sample	Flexural Strength (MPa)	Flexural's Modulus (MPa)	Deformation at Max Load (mm)
1	54.71	932.08	8.00
2	51.61	902.39	8.45
3	53.89	895.38	6.85
4	57.53	947.89	7.45
5	58.5	883.48	8.03
Mean	55.24	912.24	7.76
SD.	2.79	26.80	0.62

Table A 38 Experimental data of impact strength of PP-PET/C Composites using 15% of PET/C nonwovens

Sample	Impact Strength (KJ/m ²)
1	7.18
2	7.44
3	7.62
4	7.61
5	8.05
Mean	7.58
SD.	0.32

Table A 39 Experimental data of tensile properties of PP-PET/C Composites using 20% of PET/C nonwovens

Sample	Tensile Strength (MPa)	Young's Modulus (MPa)	% Elongation
1	25.32	315.37	16.84
2	25.02	329.84	17.80
3	24.57	311.67	19.24
4	26.86	362.99	16.73
5	23.99	238.25	17.05
Mean	25.15	311.62	17.53
SD.	1.08	45.74	1.04

Table A 40 Experimental data of flexural properties of PP-PET/C Composites using 20% of PET/C nonwovens

Sample	Flexural Strength (MPa)	Flexural's Modulus (MPa)	Deformation at Max Load (mm)
1	55.14	1023.94	9.26
2	59.83	998.89	7.92
3	57.62	1085.38	7.48
4	52.43	984.56	8.48
5	60.67	994.92	8.67
Mean	57.13	1017.54	8.36
SD.	3.40	40.59	0.69

Table A 41 Experimental data of impact strength of PP-PET/C Composites using 20% of PET/C nonwovens

Sample	Impact Strength (KJ/m ²)
1	10.70
2	9.80
3	10.04
4	10.60
5	10.25
Mean	10.27
SD.	0.38

5. PP-PET/C Composites Prepared from Surface-modified PP Nonwovens

Using a Plasma Focus at 4 shorts

Table A 42 Experimental data of tensile properties of PP-PET/C Composites using 5% of PET/C nonwovens

Sample	Tensile Strength (MPa)	Young's Modulus (MPa)	% Elongation
1	21.55	436.02	9.89
2	21.89	413.97	10.54
3	20.65	385.23	9.12
4	19.4	377.79	8.45
5	22.67	397.88	9.05
Mean	21.23	402.18	9.41
SD.	1.25	23.38	0.81

Table A 43 Experimental data of flexural properties of PP-PET/C Composites using 5% of PET/C nonwovens

Sample	Flexural Strength (MPa)	Flexural's Modulus (MPa)	Deformation at Max Load (mm)
1	40.66	909.28	7.71
2	41.12	920.26	6.00
3	43.88	913.45	6.59
4	42.34	954.98	6.85
5	44.21	899.32	5.43
Mean	42.44	919.46	6.52
SD.	1.59	21.26	0.86

Table A 44 Experimental data of impact strength of PP-PET/C Composites using 5% of PET/C nonwovens

Sample	Impact Strength (KJ/m ²)
1	2.94
2	3.89
3	3.32
4	3.36
5	2.94
Mean	3.29
SD.	0.39

Table A 45 Experimental data of tensile properties of PP-PET/C Composites using 10% of PET/C nonwovens

Sample	Tensile Strength (MPa)	Young's Modulus (MPa)	% Elongation
1	19.26	289.64	12.52
2	21.39	369.41	10.41
3	24.64	328.35	13.01
4	23.58	343.75	11.56
5	22.12	359.87	10.12
Mean	22.20	338.20	11.52
SD.	2.07	31.34	1.27

Table A 46 Experimental data of flexural properties of PP-PET/C Composites using 10% of PET/C nonwovens

Sample	Flexural Strength (MPa)	Flexural's Modulus (MPa)	Deformation at Max Load (mm)
1	44.07	958.43	6.31
2	38.37	974.75	7.88
3	40.23	901.83	7.82
4	41.47	928.34	7.02
5	43.56	913.48	8.13
Mean	41.54	935.37	7.42
SD.	2.36	30.56	0.75

Table A 47 Experimental data of impact strength of PP-PET/C Composites using 10% of PET/C nonwovens

Sample	Impact Strength (KJ/m ²)
1	5.91
2	6.00
3	5.80
4	5.74
5	6.38
Mean	5.97
SD.	0.25

Table A 48 Experimental data of tensile properties of PP-PET/C Composites using 15% of PET/C nonwovens

Sample	Tensile Strength (MPa)	Young's Modulus (MPa)	% Elongation
1	26.35	349.4	11.34
2	26.74	321.69	13.39
3	25.67	356.46	14.56
4	27.34	321.34	15.01
5	24.67	341.49	13.45
Mean	26.15	338.08	13.57
SD.	1.03	16.02	1.44

Table A 49 Experimental data of flexural properties of PP-PET/C Composites using 15% of PET/C nonwovens

Sample	Flexural Strength (MPa)	Flexural's Modulus (MPa)	Deformation at Max Load (mm)
1	54.72	989.45	8.01
2	57.27	935.45	7.08
3	56.94	943.98	8.72
4	53.98	1004.38	7.98
5	56.38	945.24	6.78
Mean	55.86	963.70	7.71
SD.	1.44	31.00	0.78

Table A 50 Experimental data of impact strength of PP-PET/C Composites using 15% of PET/C nonwovens

Sample	Impact Strength (KJ/m ²)
1	7.17
2	7.71
3	7.39
4	7.85
5	7.69
Mean	7.56
SD.	0.28

Table A 51 Experimental data of tensile properties of PP-PET/C Composites using 20% of PET/C nonwovens

Sample	Tensile Strength (MPa)	Young's Modulus (MPa)	% Elongation
1	28.1	258.15	16.22
2	26.78	274.69	12.31
3	27.45	324.43	15.21
4	27.56	307.59	17.59
5	25.89	313.1	18.54
Mean	27.16	295.59	16.03
SD.	0.85	27.93	2.30

Table A 52 Experimental data of flexural properties of PP-PET/C Composites using 20% of PET/C nonwovens

Sample	Flexural Strength (MPa)	Flexural's Modulus (MPa)	Deformation at Max Load (mm)
1	60.22	1093.34	8.14
2	59.35	983.89	9.56
3	56.36	999.53	7.19
4	59.67	1005.84	8.74
5	62.17	1010.84	7.03
Mean	59.55	1018.69	8.13
SD.	2.09	42.95	1.06

Table A 53 Experimental data of impact strength of PP-PET/C Composites using 20% of PET/C nonwovens

Sample	Impact Strength (KJ/m ²)
1	10.75
2	10.45
3	10.39
4	9.78
5	10.75
Mean	10.43
SD.	0.40



สถาบันวิทยบริการ
จุฬาลงกรณ์มหาวิทยาลัย

Appendix B

ATR/FT-IR Spectrum of Unmodified Polypropylene Nonwoven

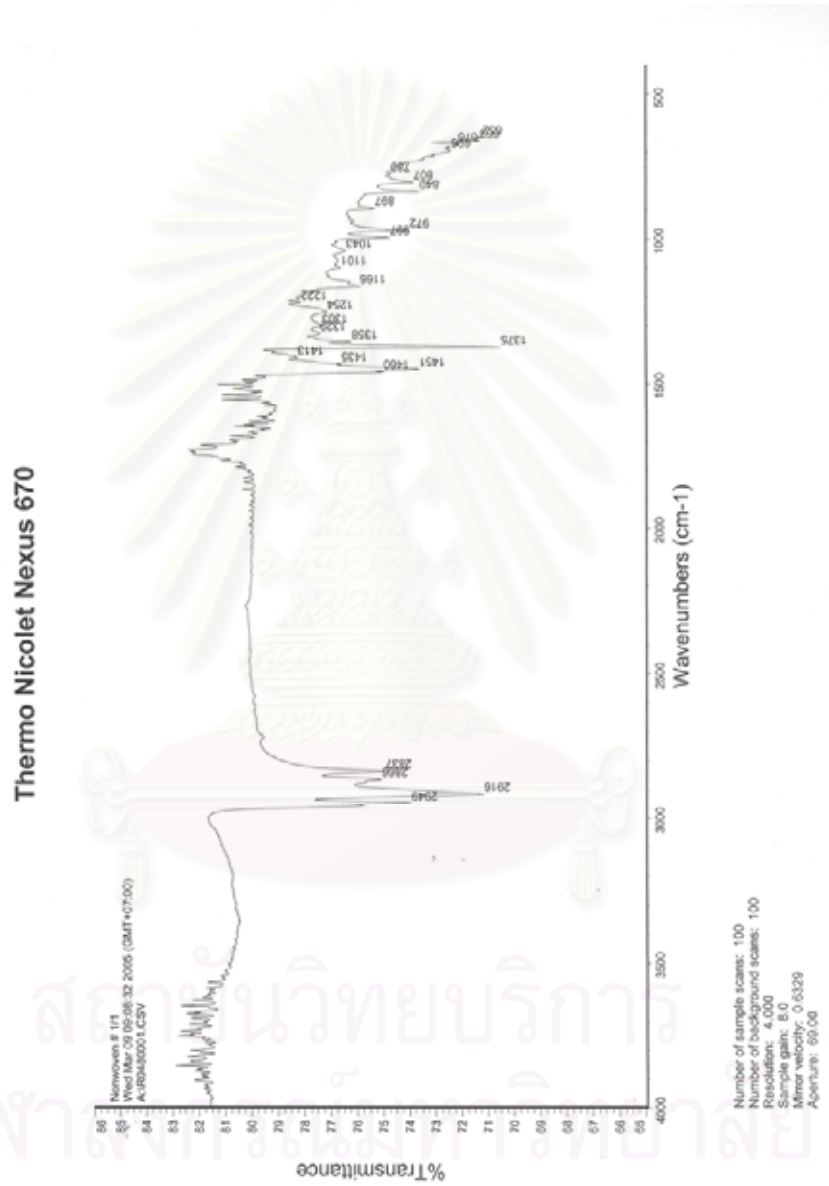

ATR/FT-IR Spectrum of Surface-modified Polypropylene Nonwovens Using Plasma Focus at 1 Shot

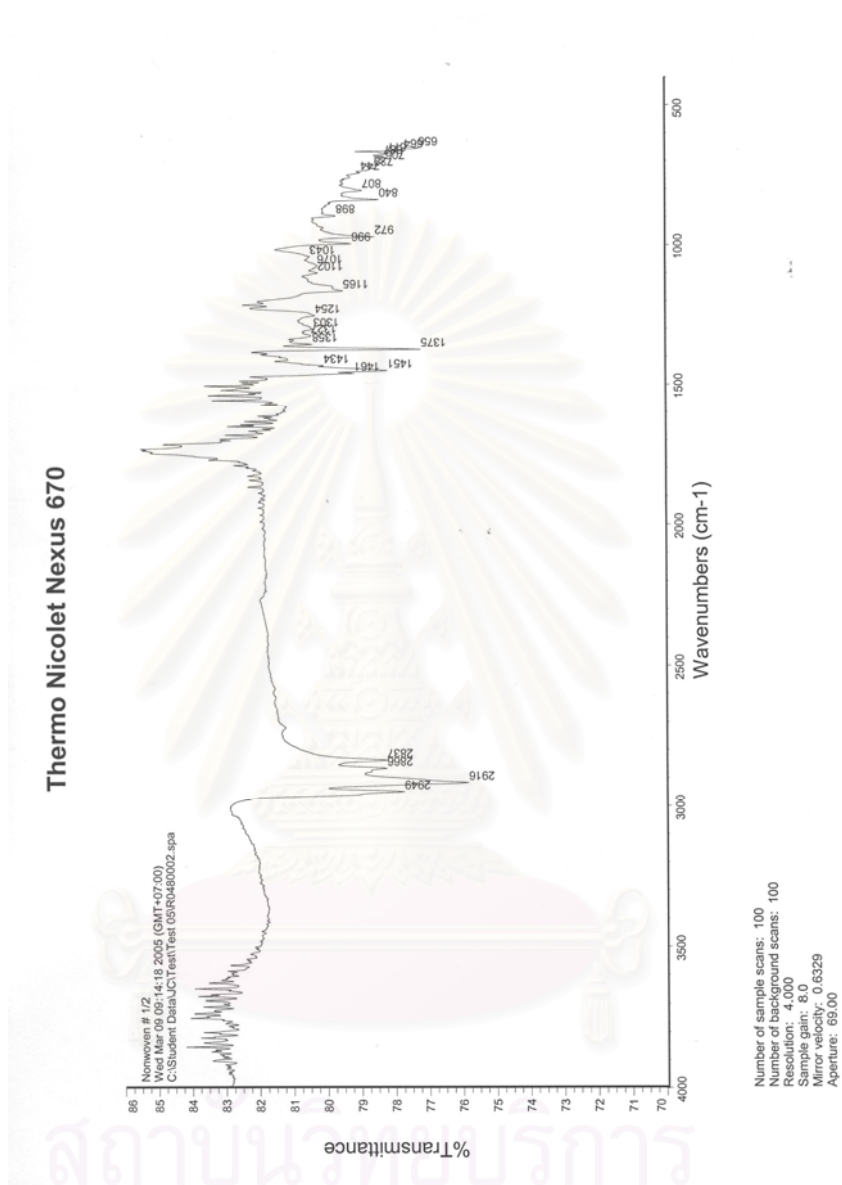

ATR/FT-IR Spectrum of Surface-modified Polypropylene Nonwovens Using Plasma Focus at 3 Shot

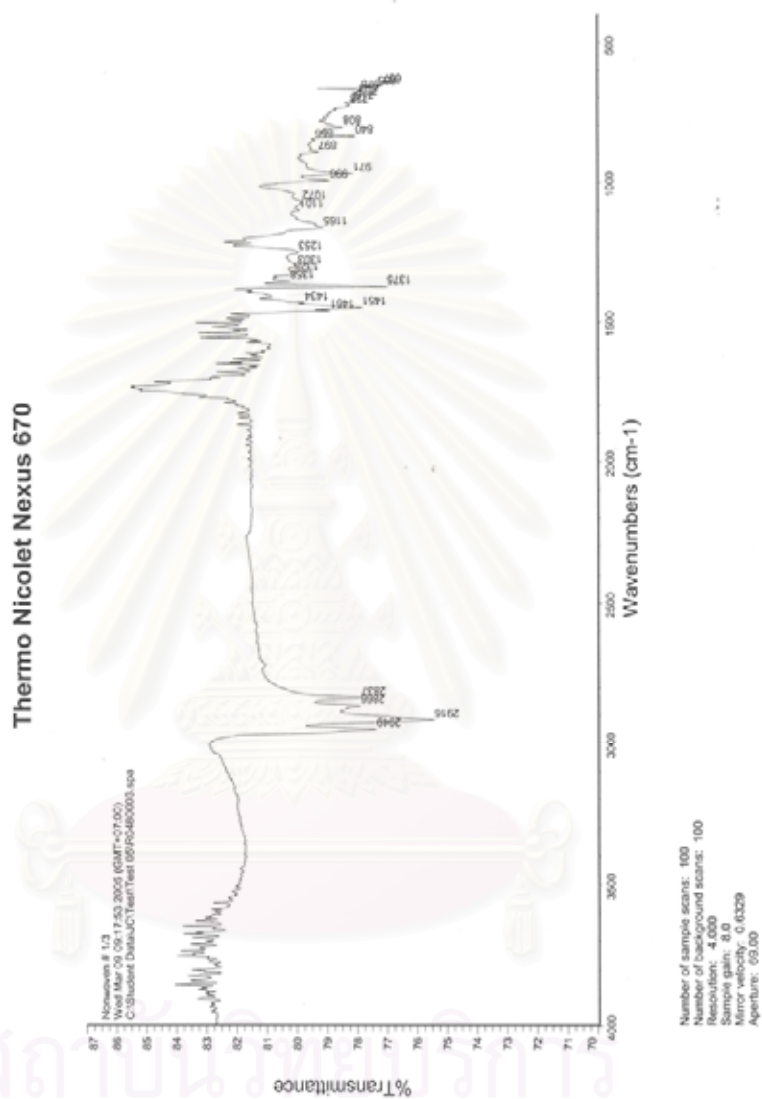

สถาบันวิจัยการ
จุฬาลงกรณ์มหาวิทยาลัย

ATR/FT-IR Spectrum of Surface-modified Polypropylene Nonwovens Using Plasma Focus at 4 Shots

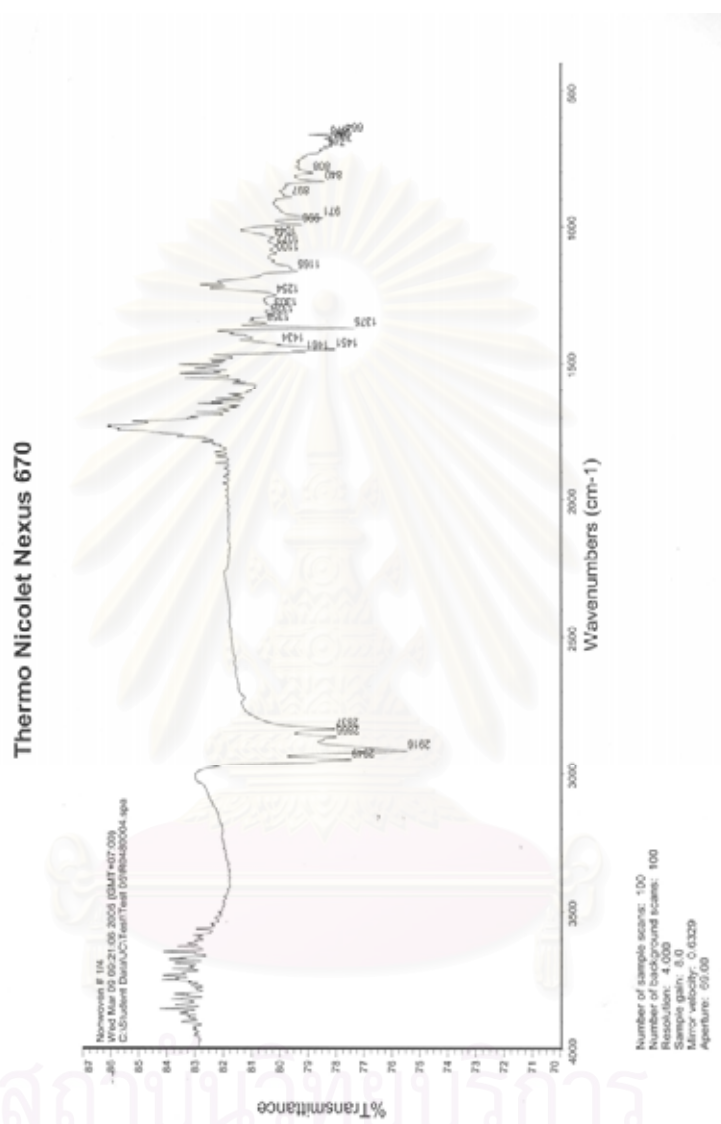

สถาบันวิทยบริการ
จุฬาลงกรณ์มหาวิทยาลัย

BIOGRAPHY

Mr. Jetsadang Srisawat was born in Songkhla, Thailand, on April 10, 1981. He received the Degree of Bachelor of Petrochemical and Polymeric Materials, Faculty of Engineering and Industrial Technology, Silpakorn University in 2003. Then, he continued his post-graduate study in Applied Polymer Science and Textile Technology Major at the Department of Materials Science, Faculty of Science, Chulalongkorn University and ultimately completed the degree of Master of Science in Applied Polymer Science and Textile Technology in May 2005.



สถาบันวิทยบริการ
จุฬาลงกรณ์มหาวิทยาลัย