

Combined Water Dumpflood with Water Injection into Oil Reservoir

Mr. Kimseng Hort



บทคัดย่อและแฟ้มข้อมูลฉบับเต็มของวิทยานิพนธ์ตั้งแต่ปีการศึกษา 2554 ที่ให้บริการในคลังปัญญาจุฬาฯ (CUIR)  
เป็นแฟ้มข้อมูลของนิสิตเจ้าของวิทยานิพนธ์ ที่ส่งผ่านทางบัณฑิตวิทยาลัย

The abstract and full text of theses from the academic year 2011 in Chulalongkorn University Intellectual Repository (CUIR)

are the theses authors has submitted through the University Graduate School.

for the Degree of Master of Engineering Program in Georesources and Petroleum

Engineering

Department of Mining and Petroleum Engineering

Faculty of Engineering

Chulalongkorn University

Academic Year 2016

Copyright of Chulalongkorn University

การแทนที่ร่วมกันด้วยน้ำแบบไหลเทและแบบอัดไปยังแหล่งกักเก็บน้ำมัน



วิทยานิพนธ์นี้เป็นส่วนหนึ่งของการศึกษาตามหลักสูตรปริญญาวิศวกรรมศาสตรมหาบัณฑิต  
สาขาวิชาวิศวกรรมทรัพยากรธรณีและปิโตรเลียม ภาควิชาวิศวกรรมเหมืองแร่และปิโตรเลียม

คณะวิศวกรรมศาสตร์ จุฬาลงกรณ์มหาวิทยาลัย

ปีการศึกษา 2559

ลิขสิทธิ์ของจุฬาลงกรณ์มหาวิทยาลัย

Thesis Title	Combined Water Dumpflood with Water Injection into Oil Reservoir
By	Mr. Kimseng Hort
Field of Study	Georesources and Petroleum Engineering
Thesis Advisor	Assistant Professor Suwat Athichanagorn, Ph.D.

---

Accepted by the Faculty of Engineering, Chulalongkorn University in Partial  
Fulfillment of the Requirements for the Master's Degree

.....Dean of the Faculty of Engineering  
(Associate Professor Supot Teachavorasinskun, D.Eng.)

THESIS COMMITTEE

.....Chairman  
(Assistant Professor Jirawat Chewaroungroj, Ph.D.)

.....Thesis Advisor  
(Assistant Professor Suwat Athichanagorn, Ph.D.)

.....Examiner  
(Falan Srisuriyachai, Ph.D.)

.....External Examiner  
(Ake Rittirong, Ph.D.)

คิมเซ็ง ฮอร์ท : การแทนที่ร่วมกันด้วยน้ำแบบไหลเทและแบบอัดไปยังแหล่งกักเก็บน้ำมัน (Combined Water Dumpflood with Water Injection into Oil Reservoir) อ.ที่  
 ปรึกษาวิทยานิพนธ์หลัก: สุวัฒน์ อธิชนากร, 126 หน้า.

ประโยชน์ที่สำคัญของการอัดน้ำแบบไหลเท คือ ไม่มีต้นทุนสำหรับการฉีดอัดน้ำ อย่างไรก็ตามการอัดน้ำแบบไหลเทจะให้การผลิตน้ำมันที่น้อยกว่าการฉีดอัดน้ำโดยทั่วไป เนื่องจากปริมาณน้ำที่ถ่ายเทจากชั้นน้ำมายังแหล่งกักเก็บน้ำมันอันจำกัด ในทางกลับกันการฉีดอัดน้ำโดยทั่วไปใช้ปริมาณน้ำอันมหาศาลซึ่งส่งผลให้ค่าใช้จ่ายสูงมาก เพราะฉะนั้นเพื่อที่จะก่อให้เกิดประโยชน์สูงสุดจากทั้ง 2 กระบวนการที่กล่าวมาข้างต้น จึงได้ทำการศึกษาระบวนการเพิ่มผลผลิตน้ำมันซึ่งเป็นการผสมระหว่างการอัดน้ำแบบไหลเทและการอัดน้ำโดยทั่วไปในแหล่งกักเก็บน้ำมัน อันประกอบด้วย 3 วิธีการ ได้แก่ 1) เริ่มจากการอัดน้ำแบบไหลเทตามด้วยการฉีดอัดน้ำโดยทั่วไป 2) การอัดน้ำแบบไหลเทพร้อมกับการฉีดอัดน้ำโดยทั่วไป โดยใช้หลุมหลายหลุม 3) การอัดน้ำแบบไหลเทพร้อมกับการฉีดอัดน้ำโดยทั่วไปตามด้วยการสลับหลุมไหลเทเป็นหลุมฉีดอัดน้ำ

แบบจำลองแหล่งกักเก็บซึ่งมีคุณสมบัติเหมือนกับแหล่งน้ำมันในประเทศไทยแหล่งหนึ่งถูกจำลองโดยใช้โปรแกรม ECLIPSE 100 ใน 3 กระบวนการที่แตกต่างกัน คือ การฉีดอัดน้ำโดยทั่วไป การอัดน้ำแบบไหลเท และกระบวนการผสมระหว่างการฉีดอัดน้ำโดยทั่วไปกับการอัดน้ำแบบไหลเท นอกจากนี้ยังได้ทำการศึกษาดัชนีที่เกี่ยวข้อง อันได้แก่ รูปแบบของหลุมผลิต หลุมฉีดอัดน้ำ และหลุมไหลเท (ทั้งในแนวตั้งและแนวนอน) รวมถึงอัตราการผลิต จากการศึกษาพบว่าการแทนที่ร่วมกันด้วยน้ำแบบไหลเทและแบบอัด สามารถให้ผลผลิตน้ำมันใกล้เคียงกับกระบวนการฉีดอัดน้ำโดยทั่วไปเพียงอย่างเดียว แต่ใช้ปริมาณน้ำฉีดอัดน้อยกว่าอย่างเห็นได้ชัด การผสมผสานกันระหว่าง 1 หลุมผลิตแนวตั้งและสองหลุมไหลเท/ฉีดอัด ทำให้ได้ผลผลิตน้ำมันสูงสุดสำหรับ 3 กระบวนการผลิต อัตราการผลิตของเหลวสูงยังให้ประสิทธิภาพการผลิตที่ดีขึ้นเมื่อเทียบกับอัตราการผลิตของเหลวที่ต่ำ

ภาควิชา วิศวกรรมเหมืองแร่และปิโตรเลียม ลายมือชื่อนิสิต .....

สาขาวิชา วิศวกรรมทรัพยากรธรณีและ ลายมือชื่อ อ.ที่ปรึกษาหลัก .....

ปิโตรเลียม

ปีการศึกษา 2559

# # 5871202221 : MAJOR GEORESOURCES AND PETROLEUM ENGINEERING

KEYWORDS: WATER DUMPFLOOD, WATER INJECTION, COMBINED WATER DUMPFLOOD WITH WATER INJECTION

KIMSENG HORT: Combined Water Dumpflood with Water Injection into Oil Reservoir. ADVISOR: ASST. PROF. SUWAT ATHICHANAGORN, Ph.D., 126 pp.

The major advantage of water dumpflood is that there is no cost incurred by water injection. However, water dumpflood generally results in lower oil recovery when compared with conventional waterflooding due to limited amount of water cross-flowing from the aquifer into the reservoir. Conventional waterflooding, on the other hand, requires tremendous amount of water injection from surface that incurs large operating costs. To utilize the benefits of the two methods, the different ways to combine water dumpflood with water injection into oil reservoir were investigated: water dumpflood followed by water injection (schedule 1), simultaneous water dumpflood and injection via different wells (schedule 2), and simultaneous water dumpflood and injection via different wells followed by conversion of dumpflood well to water injection well (schedule 3).

A simple reservoir model having the properties of one of the oil fields in Thailand was constructed using ECLIPSE100 reservoir simulator to simulate three production scenarios: conventional waterflooding, water dumpflood, and combined water dumpflood with water injection. Additional parameters which are types of production, injection, and dumping wells (vertical versus horizontal) and liquid production rate were also investigated. The simulation results clearly illustrate the benefits of combined water dumpflood with injection (schedule 1) that it can achieve similar oil recovery with the conventional waterflooding but requires much smaller amount of injected water. A combination of one vertical producer and two vertical dumping/injection wells yields the highest oil recovery for the three production scenarios. High liquid production rate also provides better production performance compared to low liquid production rate.

Department: Mining and Petroleum      Student's Signature .....

Engineering      Advisor's Signature .....

Field of Study: Georesources and Petroleum  
Engineering

Academic Year: 2016

## ACKNOWLEDGEMENTS

First of all, I would like to express my sincere gratitude to my thesis advisor, Assistant Professor Suwat Athichanagorn, for his precious guidance, strong support, and great encouragement throughout this entire research and study.

I am greatly thankful to all professors in the Department of Mining and Petroleum Engineering, Chulalongkorn University, for their profound knowledge, experience, guidance and full support for my entire study of Master's degree. I am deeply thankful to all committees for their precious time and recommendations on my research.

My sincere thanks to AUN/SEED-Net for providing me the golden opportunity to pursue my Master's degree and financial support that enables me to fully complete my study.

I would like to thank Schlumberger for providing ECLIPSE®100 reservoir simulation software to the Department of Mining and Petroleum Engineering, Chulalongkorn University, that allows me to conduct my research on simulation study successfully.

My special thanks to all faculty members in the Department of Mining and Petroleum Engineering, friends and my classmates who always help and facilitate all the related works.

Last but not least, I would like to convey my profound thanks to my family for great support and encouragement in my study and life.

## CONTENTS

	Page
THAI ABSTRACT .....	iv
ENGLISH ABSTRACT .....	v
ACKNOWLEDGEMENTS .....	vi
CONTENTS .....	vii
List of Tables .....	x
List of Figures.....	xiii
List of Abbreviations .....	xxiv
Nomenclatures.....	xxv
CHAPTER 1 INTRODUCTION.....	1
1.1 Background.....	1
1.2 Objectives .....	2
CHAPTER 2 LITERATURE REVIEW .....	3
2.1 Water dumpflood .....	3
2.2 Water injection.....	4
CHAPTER 3 THEORY AND CONCEPT.....	7
3.1 Dumping rate .....	7
3.2 Injection rate .....	8
3.3 Injectivity index.....	8
3.4 Mobility ratio .....	9
3.5 Overall recovery efficiency .....	10
3.5.1 Displacement efficiency.....	10
3.5.2 Areal sweep efficiency .....	11

	Page
3.5.3 Vertical sweep efficiency .....	11
3.6 Relative permeability .....	11
3.6.1 Corey's correlation.....	12
3.6.2 Stone's model .....	12
3.7 Fracturing pressure .....	14
CHAPTER 4 RESERVOIR SIMULATION MODEL.....	15
4.1 Reservoir model .....	15
4.2 Reservoir properties.....	16
4.2.1 Rock and fluid properties .....	16
4.2.2 Special core analysis (SCAL).....	18
4.3 Well model.....	20
4.4 Production constraint.....	22
4.5 Methodology.....	23
CHAPTER 5 RESULTS AND DISCUSSION.....	29
5.1 Conventional water injection .....	29
5.2 Water dumpflood from 10PV and 50PV aquifer .....	40
5.2.1 Effect of well type for water dumpflood from 10PV aquifer .....	40
5.2.2 Effect of well type for water dumpflood from 50PV aquifer .....	47
5.3 Combined water dumpflood from 10PV aquifer with water injection.....	52
5.3.1 Effect of water dumping and injection schedule for well option 1 ....	53
5.3.2 Effect of water dumping and injection schedule for well option 2....	61
5.3.3 Effect of water dumping and injection schedule for well option 3....	70
5.3.4 Effect of water dumping and injection schedule for well option 4....	77



	Page
5.3.5 Comparison among different well options.....	83
5.4 Combined water dumpflood from 50PV aquifer with water injection.....	84
5.4.1 Effect of water dumping and injection schedule for well option 1....	84
5.4.2 Effect of water dumping and injection schedule for well option 2....	94
5.4.3 Effect of water dumping and injection schedule for well option 3..	101
5.4.4 Effect of water dumping and injection schedule for well option 4..	109
5.4.5 Comparison among different well options.....	117
5.5 Comparison between conventional water injection, water dumpflood, and combined water dumpflood with water injection .....	118
CHAPTER 6 CONCLUSIONS AND RECOMMENDATIONS .....	121
6.1 Conclusions .....	121
6.2 Recommendations.....	123
REFERENCES .....	124
VITA.....	126

## List of Tables

Table 4-1 Physical properties of aquifer and oil reservoir.....	17
Table 4-2 PVT properties of reservoir model .....	17
Table 4-3 Special core analysis.....	18
Table 4-4 Production constraints of production well.....	23
Table 5-1 Results of four well options with maximum liquid production rate of 1000 STB/D in conventional water injection.....	31
Table 5-2 Results of four well options with maximum liquid production rate of 2000 STB/D in conventional water injection.....	37
Table 5-3 Results of four well options with maximum liquid production rate of 1000 STB/D in dumpflood from 10PV aquifer .....	40
Table 5-4 Results of four well options with maximum liquid production rate of 2000 STB/D in dumpflood from 10PV aquifer .....	45
Table 5-5 Results of four well options with maximum liquid production rate of 1000 STB/D in dumpflood from 50PV aquifer .....	48
Table 5-6 Results of four well options with maximum liquid production rate of 2000 STB/D in dumpflood from 50PV aquifer .....	52
Table 5-7 Results of different water dumping and injection schedules for well option 1 in 10PV aquifer size with maximum liquid production rate of 1000 STB/D.....	53
Table 5-8 Results of different water dumping and injection schedules for well option 1 in 10PV aquifer size with maximum liquid production rate of 2000 STB/D.....	60
Table 5-9 Results of different water dumping and injection schedules for well option 2 in 10PV aquifer size with maximum liquid production rate of 1000 STB/D.....	62

Table 5-10 Results of different water dumping and injection schedules for well option 2 in 10PV aquifer size with maximum liquid production rate of 2000 STB/D.....	68
Table 5-11 Results of different water dumping and injection schedules for well option 3 in 10PV aquifer size with maximum liquid production rate of 1000 STB/D.....	70
Table 5-12 Results of different water dumping and injection schedules for well option 3 in 10PV aquifer size with maximum liquid production rate of 2000 STB/D.....	75
Table 5-13 Results of different water dumping and injection schedules for well option 4 in 10PV aquifer size with maximum liquid production rate of 1000 STB/D.....	79
Table 5-14 Results of different water dumping and injection schedules for well option 4 in 10PV aquifer size with maximum liquid production rate of 2000 STB/D.....	81
Table 5-15 Results of different water dumping and injection schedules for well option 1 in 50PV aquifer size with maximum liquid production rate of 1000 STB/D.....	85
Table 5-16 Results of different water dumping and injection schedules for well option 1 in 50PV aquifer size with maximum liquid production rate of 2000 STB/D.....	90
Table 5-17 Results of different water dumping and injection schedules for well option 2 in 50PV aquifer size with maximum liquid production rate of 1000 STB/D.....	95
Table 5-18 Results of different water dumping and injection schedules for well option 2 in 50PV aquifer size with maximum liquid production rate of 2000 STB/D.....	98

Table 5-19 Results of different water dumping and injection schedules for well option 3 in 50PV aquifer size with maximum liquid production rate of 1000 STB/D.....	102
Table 5-20 Results of different water dumping and injection schedules for well option 3 in 50PV aquifer size with maximum liquid production rate of 2000 STB/D.....	106
Table 5-21 Results of different water dumping and injection schedules for well option 4 in 50PV aquifer size with maximum liquid production rate of 1000 STB/D.....	110
Table 5-22 Results of different water dumping and injection schedules for well option 4 in 50PV aquifer size with maximum liquid production rate of 2000 STB/D.....	114
Table 5-23 Comparison results of different approaches of conventional injection, water dumpflood, and combined water dumpflood with water injection .....	120

## List of Figures

Figure 3-1 Water injectivity variations in a radial system [10] .....	9
Figure 4-1 3D view of oil reservoir (bottom) and 10PV aquifer (top) .....	15
Figure 4-2 3D view of oil reservoir (bottom) and 50PV aquifer (top) .....	16
Figure 4-3 Live oil PVT properties of the reservoir .....	18
Figure 4-4 Relative permeability to oil and water as a function of water saturation.....	19
Figure 4-5 Relative permeability to oil and gas as a function of gas saturation.....	19
Figure 4-6 One vertical producer and two vertical injectors (well option 1).....	20
Figure 4-7 One vertical producer and two horizontal injectors (well option 2).....	21
Figure 4-8 One horizontal producer and two vertical injectors (well option 3).....	21
Figure 4-9 One horizontal producer and two horizontal injectors (well option 4)	22
Figure 4-10 Horizontal well trajectory .....	22
Figure 4-11 Flow chart of methodology .....	26
Figure 4-12 Flow chart of simulation cases for conventional water injection .....	27
Figure 4-13 Flow chart of simulation cases for water dumpflood.....	27
Figure 4-14 Flow chart of simulation cases for combined water dumpflood with water injection .....	28
Figure 5-1 Cumulative oil productions of four well options with maximum liquid production rate of 1000 STB/D in conventional water injection .....	30
Figure 5-2 Oil production rates of four well options with maximum liquid production rate of 1000 STB/D in conventional water injection .....	31
Figure 5-3 Reservoir water saturation profiles of well option 1 from top layer (top) and bottom layer (bottom) after 5.5 years of production with maximum liquid production rate of 1000 STB/D in conventional water injection.	32

Figure 5-4 Total water cuts of four well options with maximum liquid production rate of 1000 STB/D in conventional water injection .....	33
Figure 5-5 Reservoir water saturation profiles of well option 2 from top layer (top) and bottom layer (bottom) after 5.8 years of production with maximum liquid production rate of 1000 STB/D in conventional water injection. ....	34
Figure 5-6 Side view cross-sections (z-x plane) of four well options at 6.16 years of production with maximum liquid production rate of 1000 STB/D in conventional water injection .....	35
Figure 5-7 Oil production rates of four well options with maximum liquid production rate of 2000 STB/D in conventional water injection .....	38
Figure 5-8 Total water cuts of four well options with maximum liquid production rate of 2000 STB/D in conventional water injection .....	39
Figure 5-9 Cumulative oil productions of four well options with maximum liquid production rate of 1000 STB/D in water dumpflood from 10PV aquifer .....	41
Figure 5-10 Oil production rates of four well options with maximum liquid production rate of 1000 STB/D in water dumpflood from 10PV aquifer .....	42
Figure 5-11 Oil reservoir pressures of four well options with maximum liquid production rate of 1000 STB/D in water dumpflood from 10PV aquifer .....	42
Figure 5-12 Water cross-flow rates of four well options with maximum liquid production rate of 1000 STB/D in water dumpflood from 10PV aquifer .....	43
Figure 5-13 Total water cuts of four well options with maximum liquid production rate of 1000 STB/D in water dumpflood from 10PV aquifer.....	43

Figure 5-14 Oil production rates of four well options with maximum liquid production rate of 2000 STB/D in water dumpflood from 10PV aquifer ..... 45

Figure 5-15 Reservoir pressures of four well options with maximum liquid production rate of 2000 STB/D in water dumpflood from 10PV aquifer ..... 46

Figure 5-16 Total water cuts of four well options with maximum liquid production rate of 2000 STB/D in water dumpflood from 10PV aquifer..... 47

Figure 5-17 Water cross-flow rates of four well options with maximum liquid production rate of 1000 STB/D in water dumpflood from 50PV aquifer ..... 48

Figure 5-18 Cumulative oil productions of four well options with maximum liquid production rate of 1000 STB/D in water dumpflood from 50PV aquifer ..... 49

Figure 5-19 Oil production rates of four well options with maximum liquid production rate of 1000 STB/D in water dumpflood from 50PV aquifer ..... 49

Figure 5-20 Total water cuts of four well options with maximum liquid production rate of 1000 STB/D in water dumpflood from 50PV aquifer..... 50

Figure 5-21 Cumulative oil productions of schedule 1 of combined method from 10PV aquifer for well option 1 with maximum liquid production rate of 1000 STB/D..... 54

Figure 5-22 Total water productions of schedule 1 of combined method from 10PV aquifer for well option 1 with maximum liquid production rate of 1000 STB/D..... 54

Figure 5-23 Oil production rates of schedule 1 of combined method from 10PV aquifer for well option 1 with maximum liquid production rate of 1000 STB/D..... 55

Figure 5-24 Top view of oil saturation profiles of schedule 1 of combined method from 10PV aquifer for well option 1 with maximum liquid production rate of 1000 STB/D at the end of production .....	56
Figure 5-25 Water injection rates of schedule 1 of combined method from 10PV aquifer for well option 1 with maximum liquid production rate of 1000 STB/D.....	57
Figure 5-26 Total water cuts of schedule 1 of combined method from 10PV aquifer for well option 1 with maximum liquid production rate of 1000 STB/D.....	58
Figure 5-27 Oil production rates of schedules 1, 2 and 3 of combined method from 10PV aquifer for well option 1 with maximum liquid production rate of 1000 STB/D.....	58
Figure 5-28 Reservoir pressures of schedules 1, 2 and 3 of combined method from 10PV aquifer for well option 1 with maximum liquid production rate of 1000 STB/D.....	59
Figure 5-29 Cumulative oil productions and water injections of highest oil recovery cases from maximum liquid production rates of 1000 and 2000 STB/D of combined method from 10PV aquifer for well option 1.....	61
Figure 5-30 Cumulative oil productions of schedule 1 of combined method from 10PV aquifer for well option 2 with maximum liquid production rate of 1000 STB/D.....	63
Figure 5-31 Oil production rates of schedule 1 of combined method from 10PV aquifer for well option 2 with maximum liquid production rate of 1000 STB/D.....	63
Figure 5-32 Total water cuts of schedule 1 of combined method from 10PV aquifer for well option 2 with maximum liquid production rate of 1000 STB/D.....	64



Figure 5-33 Top view of oil saturation profiles of schedule 1 of combined method from 10PV aquifer for well option 1 with maximum liquid production rate of 1000 STB/D at 10 years of production.....	64
Figure 5-34 Total water productions of schedule 1 of combined method from 10PV aquifer for well option 2 with maximum liquid production rate of 1000 STB/D.....	65
Figure 5-35 Water injection rates of schedule 1 of combined method from 10PV aquifer for well option 2 with maximum liquid production rate of 1000 STB/D.....	66
Figure 5-36 Oil production rates of schedules 1, 2 and 3 of combined method from 10PV aquifer for well option 2 with maximum liquid production rate of 1000 STB/D.....	67
Figure 5-37 Oil production rates of schedule 1 of combined method from 10PV aquifer for well option 2 with maximum liquid production rate of 2000 STB/D.....	68
Figure 5-38 Cumulative oil productions and water injections of highest oil recovery cases from maximum liquid production rates of 1000 and 2000 STB/D of combined method from 10PV aquifer for well option 2.....	69
Figure 5-39 Oil production rates of schedule 3 of combined method from 10PV aquifer for well option 3 with maximum liquid production rate of 1000 STB/D.....	71
Figure 5-40 Total water cuts of schedule 3 of combined method from 10PV aquifer for well option 3 with maximum liquid production rate of 1000 STB/D.....	72
Figure 5-41 Top view of oil saturation profile of schedule 3 of combined method from 10PV aquifer for well option 3 with maximum liquid production rate of 1000 STB/D at 5.5 years of production.....	72

Figure 5-42 Cumulative oil productions of schedule 3 of combined method from 10PV aquifer for well option 3 with maximum liquid production rate of 1000 STB/D.....	73
Figure 5-43 Oil production rates of schedules 1, 2 and 3 of combined method from 10PV aquifer for well option 3 with maximum liquid production rate of 1000 STB/D.....	74
Figure 5-44 Total water cuts of schedules 1, 2 and 3 of combined method from 10PV aquifer for well option 3 with maximum liquid production rate of 1000 STB/D.....	74
Figure 5-45 Cumulative oil productions and water injections of highest oil recovery cases from maximum liquid production rates of 1000 and 2000 STB/D of combined method from 10PV aquifer for well option 3.....	76
Figure 5-46 Oil production rates of schedule 1 of combined method from 10PV aquifer for well option 4 with maximum liquid production rate of 1000 STB/D.....	78
Figure 5-47 Cumulative oil productions of schedule 1 of combined method from 10PV aquifer for well option 4 with maximum liquid production rate of 1000 STB/D.....	78
Figure 5-48 Total water cuts of schedule 1 of combined method from 10PV aquifer for well option 4 with maximum liquid production rate of 1000 STB/D.....	80
Figure 5-49 Oil production rates of schedules 1, 2 and 3 of combined method from 10PV aquifer for well option 4 with maximum liquid production rate of 1000 STB/D.....	80
Figure 5-50 Cumulative oil productions and water injections of highest oil recovery cases from maximum liquid production rates of 1000 and	

2000 STB/D of combined method from 10PV aquifer for well option 4.....	82
Figure 5-51 Cumulative oil productions and water injections of four well options of combined method from 10PV aquifer .....	83
Figure 5-52 Oil production rates of schedules 1, 2 and 3 of combined method from 50PV aquifer for well option 1 with maximum liquid production rate of 1000 STB/D.....	85
Figure 5-53 Reservoir pressures of schedules 1, 2 and 3 of combined method from 50PV aquifer for well option 1 with maximum liquid production rate of 1000 STB/D.....	86
Figure 5-54 Water cross-flow rates of schedules 1, 2 and 3 of combined method from 50PV aquifer for well option 1 with maximum liquid production rate of 1000 STB/D.....	86
Figure 5-55 Top view of oil saturation profile of schedule 1 of combined method from 50PV aquifer for well option 1 with maximum liquid production rate of 1000 STB/D at 10 years of production.....	87
Figure 5-56 Total water cuts of schedules 1, 2 and 3 of combined method from 50PV aquifer for well option 1 with maximum liquid production rate of 1000 STB/D.....	88
Figure 5-57 Cumulative oil productions of schedules 1, 2 and 3 of combined method from 50PV aquifer for well option 1 with maximum liquid production rate of 1000 STB/D .....	88
Figure 5-58 Oil production rates of schedules 1 and 2 of combined method from 50PV aquifer for well option 1 with maximum liquid production rate of 2000 STB/D.....	91
Figure 5-59 Reservoir pressures of schedules 1 and 2 of combined method from 50PV aquifer for well option 1 with maximum liquid production rate of 2000 STB/D.....	91

Figure 5-60 Water cross-flow rates of schedules 1 and 2 of combined method from 50PV aquifer for well option 1 with maximum liquid production rate of 2000 STB/D.....	92
Figure 5-61 Total water cuts of schedules 1 and 2 of combined method from 50PV aquifer for well option 1 with maximum liquid production rate of 2000 STB/D.....	92
Figure 5-62 Cumulative oil productions and water injections of highest oil recovery cases from maximum liquid production rates of 1000 and 2000 STB/D of combined method from 50PV aquifer for well option 1.....	93
Figure 5-63 Oil production rates of schedules 1, 2 and 3 of combined method from 50PV aquifer for well option 2 with maximum liquid production rate of 1000 STB/D.....	95
Figure 5-64 Reservoir pressures of schedules 1, 2 and 3 of combined method from 50PV aquifer for well option 2 with maximum liquid production rate of 1000 STB/D.....	96
Figure 5-65 Top view of oil saturation profile of schedule 1 of combined method from 50PV aquifer for well option 2 with maximum liquid production rate of 1000 STB/D at 8 years of production.....	96
Figure 5-66 Total water cuts of schedules 1, 2 and 3 of combined method from 50PV aquifer for well option 2 with maximum liquid production rate of 1000 STB/D.....	97
Figure 5-67 Oil production rates of schedules 1 and 2 of combined method from 50PV aquifer for well option 2 with maximum liquid production rate of 2000 STB/D.....	99
Figure 5-68 Water cross-flow rates of schedules 1 and 2 of combined method from 50PV aquifer for well option 2 with maximum liquid production rate of 2000 STB/D.....	99

Figure 5-69 Total water cuts of schedules 1 and 2 of combined method from 50PV aquifer for well option 2 with maximum liquid production rate of 2000 STB/D.....	100
Figure 5-70 Cumulative oil productions and water injections of highest oil recovery cases from maximum liquid production rates of 1000 and 2000 STB/D of combined method from 50PV aquifer for well option 2.....	101
Figure 5-71 Reservoir pressures of schedules 1 and 2 of combined method from 50PV aquifer for well option 3 with maximum liquid production rate of 1000 STB/D.....	102
Figure 5-72 Water cross-flow rates of schedules 1 and 2 of combined method from 50PV aquifer for well option 3 with maximum liquid production rate of 1000 STB/D.....	103
Figure 5-73 Gas-oil ratio of schedules 1 and 2 of combined method from 50PV aquifer for well option 3 with maximum liquid production rate of 1000 STB/D.....	103
Figure 5-74 Oil production rates of schedules 1 and 2 of combined method from 50PV aquifer for well option 3 with maximum liquid production rate of 1000 STB/D.....	104
Figure 5-75 Total water cuts of schedules 1 and 2 of combined method from 50PV aquifer for well option 3 with maximum liquid production rate of 1000 STB/D.....	104
Figure 5-76 Oil production rates of schedules 1 and 2 of combined method from 50PV aquifer for well option 3 with maximum liquid production rate of 2000 STB/D.....	107
Figure 5-77 Reservoir pressures of schedules 1 and 2 of combined method from 50PV aquifer for well option 3 with maximum liquid production rate of 2000 STB/D.....	107

Figure 5-78 Total water cuts of schedules 1 and 2 of combined method from 50PV aquifer for well option 3 with maximum liquid production rate of 2000 STB/D.....	108
Figure 5-79 Cumulative oil productions and water injections of highest oil recovery cases from maximum liquid production rates of 1000 and 2000 STB/D of combined method from 50PV aquifer for well option 3.....	109
Figure 5-80 Cumulative oil production of schedules 1, 2 and 3 of combined method from 50PV aquifer for well option 4 with maximum liquid production rate of 1000 STB/D .....	111
Figure 5-81 Oil production rates of schedules 1, 2 and 3 of combined method from 50PV aquifer for well option 4 with maximum liquid production rate of 1000 STB/D.....	111
Figure 5-82 Water cross-flow rates of schedules 1, 2 and 3 of combined method from 50PV aquifer for well option 4 with maximum liquid production rate of 1000 STB/D.....	112
Figure 5-83 Total water cuts of schedules 1, 2 and 3 of combined method from 50PV aquifer for well option 4 with maximum liquid production rate of 1000 STB/D.....	112
Figure 5-84 Top view of oil saturation profile of schedule 1 of combined method from 50PV aquifer for well option 1 with maximum liquid production rate of 1000 STB/D at 10 years of production.....	113
Figure 5-85 Oil production rates of schedules 1 and 2 of combined method from 50PV aquifer for well option 4 with maximum liquid production rate of 2000 STB/D.....	114
Figure 5-86 Total water cuts of schedules 1 and 2 of combined method from 50PV aquifer for well option 4 with maximum liquid production rate of 2000 STB/D.....	115

Figure 5-87 Water cross-flow rates of schedules 1 and 2 of combined method from 50PV aquifer for well option 4 with maximum liquid production rate of 2000 STB/D.....	115
Figure 5-88 Cumulative oil productions and water injections of highest oil recovery cases from maximum liquid production rates of 1000 and 2000 STB/D of combined method from 50PV aquifer for well option 4.....	116
Figure 5-89 Cumulative oil productions and water injections of four well options of combined method from 50PV aquifer .....	117
Figure 5-90 Cumulative oil productions and water injections of conventional injection, water dumpflood, and combined water dumpflood with water injection .....	119

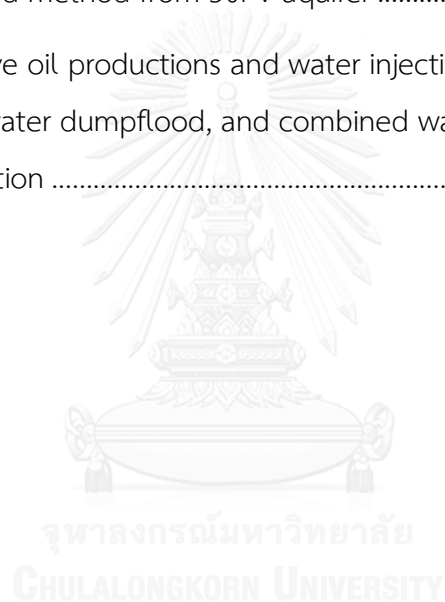

## List of Abbreviations

bbI/STB	Barrel per stock tank barrel
BOPD	Barrel of oil per day
BWPD	Barrel of water per day
BWPD/psi	Barrel of water per day per pound per square inch
GOR	Gas oil ratio
MBOPD	Thousand barrel of oil per day
mD	Millidarcy
MMBO	Million barrel of oil
MMSTB	Million stock tank barrel
OOIP	Oil originally in place
PV	Pore volume
PVT	Pressure-volume-temperature
rb/stb	Reservoir barrel per stock tank barrel
SCAL	Special core analysis
scf/STB	Standard cubic feet per stock tank barrel
STB/D	Stock tank barrel per day
TVD	True vertical depth
WIPM	Water injection for pressure maintenance



## Nomenclatures

$\mu_o$	Oil viscosity, cp
$\mu_w$	Water viscosity, cp
$\sigma_o$	Vertical overburden stress, psig
$B_o$	Oil formation volume factor, bbl/STB
$B_{oi}$	Oil formation volume factor at starting of waterflood, bbl/STB
$B_w$	Water formation volume factor, bbl/STB
$E_A$	Areal sweep efficiency
$E_D$	Displacement efficiency
$E_i$	Vertical sweep efficiency
$E_R$	Overall recovery efficiency
$F_L$	Frictional loss, psi/BWPD
$h$	Reservoir thickness, ft
$I$	Injectivity index, STB/D/psi
$J$	Productivity index, BWPD/psi
$k$	Permeability, mD
$k_{rg}$	Relative permeability to gas
$k_{rg,max}$	Maximum relative permeability to gas
$k_{ro}$	Relative permeability to oil
$k_{ro,max}$	Maximum relative permeability to oil
$k'_{ro}$	Relative permeability to oil at irreducible water saturation
$k_{rw}$	Relative permeability to water
$k_{rw,max}$	Maximum relative permeability to water
$k'_{rw}$	Relative permeability to water at residual oil saturation
$M$	Mobility ratio
$n_g$	Corey's gas exponent
$n_o$	Corey's oil exponent
$n_w$	Corey's water exponent
$p_{eo}$	Boundary pressure in oil zone, psig

$p_{ew}$	Boundary pressure in water zone, psig
$p_f$	Formation pressure, psig
$p_{ff}$	Fracture pressure, psig
$p_{inj}$	Water injection pressure, psig
$p_R$	Average reservoir pressure, psig
$Q$	Injection rate, STB/D
$q_{inj}$	Injection rate, STB/D
$q_w$	Water producing rate, BWPD
$r_e$	Well's drainage radius, ft
$r_w$	Wellbore radius, ft
$s$	Skin factor
$S_g$	Gas saturation
$S_{gr}$	Residual gas saturation
$S_o$	Oil saturation
$S_{oi}$	Initial oil saturation at starting time of waterflood
$S_{or}$	Residual oil saturation
$S_w$	Water saturation
$S_{wr}$	Residual water saturation

# CHAPTER 1

## INTRODUCTION

### 1.1 Background

With continuous oil production from primary recovery, energy of reservoirs that do not have gas cap or aquifer support will decrease sharply to a level making production un-economic. To alleviate this reservoir energy decline in term of pressure support, secondary recovery method by water flooding is implemented in order to maintain well productivities and sustain reservoir pressure. This secondary recovery can be started at any time during the production process.

Dake [1] defined waterflooding as adopting a policy of water injection, with the aim of complete or partial pressure maintenance and accelerated development through the positive displacement of oil towards the producing wells. Waterflooding can be performed via (1) water dumpflood if there is a water aquifer lying above or below the oil reservoir and (2) water injection. Water dumpflood is used in many oil fields since it does not require any surface facilities. The concept of water dumpflood is to allow the water from nearby aquifer to flow naturally to the target oil reservoir in order to maintain the reservoir pressure and prolong the well production life. For water injection, water is injected from surface through injection wells to the target reservoir and push the oil toward production wells. A successful water injection operation can maintain reservoir pressure; therefore, it can both increase oil production and improve the overall recovery.

However, oil fields that have the availability of both surface water and water aquifer can be recovered using both water dumpflood and/or water injection methods. Therefore, performance of combined water dumpflood with water injection needs to be investigated. In this study, reservoir simulation is performed using ECLIPSE100 to simulate three production scenarios: conventional water injection, water dumpflood, and combined water dumpflood with water injection. Type of production, injection, and dumping wells, liquid production rate, and dumping and injection schedule are investigated.

## 1.2 Objectives

1. To find appropriate types of production and injection wells and production rate for conventional water injection and water dumpflood.

2. To find appropriate types of production and injection wells, production rate, and dumping and injection schedule for combined water dumpflood and water injection.

3. To compare the performance of combined water dumpflood with water injection with conventional waterflooding and water dumpflood.



## CHAPTER 2

### LITERATURE REVIEW

#### 2.1 Water dumpflood

Fujita [2] studied pressure-maintenance operation by dumping shallow aquifer water into partially depleted oil reservoir of limestone formation. The study's objective is to maintain oil production by controlling GOR and to improve the ultimate oil recovery after 6 years of production. Water was dumped into reservoir containing light oil (33 °API) underlain by heavy oil mat formation (28 to 9 °API). Before dumping, initial oil production was 30000 BOPD and increased up to 66000 BOPD then decreased to 33000 BOPD after 6 years of production. GOR increased to 1550 scf/STB. Reservoir pressure was depleted to 2650 psig, 1000 psig below the original, leading to closing of five producers. To maximize the oil recovery, reservoir simulation on water dumpflood was conducted. Eight wells were used to dump water with the total rate of 29000 BWPD. The GOR was kept below 1000 scf/STB. As a result, after five years of operation, reservoir pressure was maintained at around 2600 psig, resulting in oil production rate of 40000 to 45000 BOPD giving additional oil recovery of 19.58 MMSTB.

Quttainah and Al-Maraghi [3] conducted full field dumpflood injection project to maintain reservoir pressure and extend production plateau in Umm Gudair reservoir. At an early stage, average oil production was around 3000 BOPD. After 40 years of production, this reservoir is confirmed to have very little natural pressure support, leading to rapid falling of reservoir pressure from 4150 psi to 3000 psi. With this condition and high off-take rate, the production was expected to stay on plateau for only 3 years. To solve this problem, three main options were considered: water injection, infill drilling and combined development options. The authors performed many simulation options and selected the best case which is a combination of 16 dumpflood wells, 38 infill production wells and 6 disposal wells. This scenario provided the oil production plateau length up to 11 years which is the favourable option for the field.

Osharode [4] investigated the application of water dumpflood in a depleted sandstone reservoir for recovering the remaining hydrocarbon in-place in Egbema West. Oil production rate from Egbema West D reservoir dropped from 32 MBOPD to an average of 5 MBOPD within 7 years. The reservoir pressure decreased from 3452 psig to 2650 psig due to insufficient pressure support of the aquifer. In order to increase the production and maintain the reservoir pressure, a pilot water dumpflood was implemented in D reservoir. Aquifer at 4000 ft depth was allowed to flow naturally to the target oil reservoir at 8000 ft depth by pressure and gravity differential. The pilot water dumpflood successfully sustained the reservoir pressure at 2650 psig and provided an increment of 8 psi after 12 years of injection. Cumulative oil production was also increased by 33%.

Anansupak [5] studied viability of water dumpflood in the Pattani basin, Gulf of Thailand, using finite difference numerical simulation. This study investigated on the following scenarios: comparing productions from natural depletion with water dumpflood using edge well injectors and centre well injectors, effects of different aquifer sizes on dumpflooding, impacts of well productivity index and injectivity index, dumpflooding performance for different reservoir depths, performance of underlying and overlying aquifer, effects of oil gravity and starting time for optimal dumpflooding. As a result, the author found that oil production from dumpflooding can be maximized using edge well injectors. The best size of aquifer to reservoir ratio is around 43 RBL/RBL. The reservoir depth between 4000 to 8000 ft TVD used in the study has low impact on oil recovery efficiency. The study also pointed out that overlying aquifer is a better choice compared to underlying aquifer due to its higher cross-flow rate. Light oil gravity of 30 to 40 °API is a favourable condition for this dumpflooding. The oil recovery ranges from 33% to 37% with different starting times of water dumpflood.

## 2.2 Water injection

Mendez et al. [6] demonstrated how the application of Water Injection for Pressure Maintenance (WIPM) has successfully increased the oil production in Boscan heavy oil field (10.5 °API). This field was estimated to have 35 billion barrels of original

oil in place but the cumulative recovery factor at the time of the study was only around 5% OOIP with above 70 years of production. To increase the production, water injection for pressure maintenance was implemented. The authors applied the study of reservoir simulation combined with previous works to determine the optimum recovery. At first, a four-pattern inverted seven-spot pilot was initiated in the centre of the field as a defined WIPM. Three of the four injectors were converted from shut-in disposal wells. Then an Injection Pilot, located east of initial pilot, began using 8 inverted 7-spot patterns. Later on, another pilot called Injection Pilot Expansion was started using a pseudo 1-3-1 inverted 7-spot pattern configuration which was based on numerical simulation studies. The Injection Pilot Expansion is located on the east of the reservoir. As results, WIPM project in Boscan filed has yielded better results of more than 75 million barrels of cumulative oil recovery and another 270 million barrels of oil recovery to the economic limit is expected. Within the East and Expansion project, additional oil recovery is expected to be 62 MMBO by the year 2026 and 189 MMBO to economic limit.

Paige et al. [7] studied the processes that can optimize the performance of injection wells for two oil fields namely: Prudhoe Bay and Forties. Prudhoe reservoir is a sandstone formation at depth of 8800 ft. It contained recoverable reserve around 12 billion barrels. In contrast, the Forties field is a poorly consolidated sandstone formation located at depth of 7,000 ft and its reserve was estimated to be 2.5 billion barrels. The study discussed on many parameters such as waterflood induced fracturing, completion, water injection quality, and injection pressure. The results from this study demonstrated that thermal effects have significant impact on well injectivity. A cold water injection into warm reservoir can reduce the stress of the formation and create the fracture in vertical direction in most reservoirs. Moreover, injection above fracturing pressures can improve the well injectivities and allow the poor water quality to be injected.

Westermarck et al. [8] conducted a project to test parallel horizontal waterflooding aiming to improve oil recovery in shallow low permeability sandstone in north-eastern Oklahoma. The formation is now in the stage of depletion due to solution-gas drive and low initial reservoir pressure. The recovery efficiency was less

than 20% of original oil in place. For secondary recovery method, injection pressure above fracture pressure and small spacing well patterns can increase oil recovery but still not economic because of the presence of natural fractures and number of wells required. Thus, horizontal waterflooding is investigated. The pilot field consisted of one horizontal injector and two parallel horizontal producers straddled the injector. Simulation studies were conducted in the Bartlesville sandstone reservoir that had 85 ft thickness, 15-20% porosity, and permeability of 30-100 mD. From the simulation studies, horizontal injector was located 20 ft above the bottom of the reservoir and the producers were placed 20 ft below the top of the reservoir. The three wells had the horizontal length of 500 ft. As a result, large amount of water can be injected below fracture pressure leading to economic production. The horizontal waterflood with 23 acre spacing generated \$2.9 million cumulative revenue over 6 years of operation, compared to \$1.4 million cumulative revenue over 30 years of operation under a five-spot vertical waterflood.

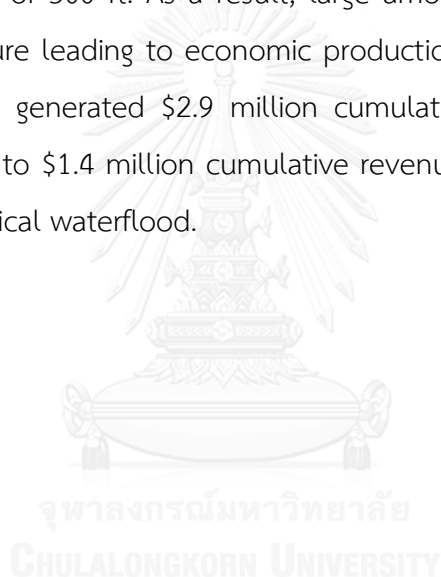



## CHAPTER 3

### THEORY AND CONCEPT

This section describes relevant theory and concepts used in this research which are water dumpflooding, injectivity, mobility ratio, displacement efficiency, volumetric sweep efficiency, relative permeability, and fracture pressure.

#### 3.1 Dumping rate

The concept of water dumpflood is to sustain the target reservoir pressure by naturally flowing water from high pressure potential aquifer into low pressure potential oil zone [9]. This technique is widely used in many oil field projects due to its relatively low operating and capital expenditures. Typically, the source of water can be from an overlying or underlying aquifer. However, the better performance in term of cross-flow is obtained from overlying aquifer compared to underlying aquifer [5].

Davies [9] demonstrated that the rate at which fluid transfers from one zone to another is a constant value if the reservoir static pressures in both zones are maintained. Equation 3.1 represents the rate of transfer which relies on productivity and injectivity of the source and injected zones, frictional loss in casing and reservoirs' static pressure differences.

$$q_w \left[ \frac{1}{I} + \frac{1}{J} + FL \right] = p_{ew} - p_{eo} \quad (3.1)$$

where

$q_w$  = water producing rate, BWPD

$I$  = injectivity index, BWPD / psi

$J$  = productivity index, BWPD / psi

$FL$  = frictional loss, psi / BWPD

$p_{ew}$  = boundary pressure in water zone, psig

$p_{eo}$  = boundary pressure in oil zone, psig

### 3.2 Injection rate

Water injection rate into oil reservoir is one of other factors that contributes to the efficiency of water flooding. However, the injection rate can be influenced by many factors including skin effect near wellbore, rock properties and fluid properties, etc. In oilfield units, the injection rate in radial flow system is commonly calculated as:

$$q_{inj} = \frac{kh}{141.2 \left[ \ln \left( \frac{r_e}{r_w} \right) - \frac{3}{4} + s \right]} (p_{inj} - \bar{p}_R) \frac{k_{rw}}{\mu_w B_w} \quad (3.2)$$

where

$q_{inj}$  = injection rate, STB / D

$k$  = permeability, mD

$h$  = reservoir thickness, ft

$r_e$  = well's drainage radius, ft

$r_w$  = wellbore radius, ft

$p_{inj}$  = water injection pressure, psig

$\bar{p}_R$  = average reservoir pressure, psig

$k_{rw}$  = relative permeability to water

$\mu_w$  = water viscosity, cp

$B_w$  = water formation volume factor, bbl / STB

$s$  = skin factor

### 3.3 Injectivity index

Injectivity index is the ratio of injection rate over the pressure differences between the bottom hole and the reservoir. Determining the injectivity index is the most common way of analysing performance of injection wells. In oilfield units, the injectivity index is commonly calculated as:

$$I = \frac{Q}{p_{inj} - p_R} \quad (3.3)$$

where

$I$  = injectivity index, STB / D / psi

$Q$  = injection rate (as defined in equation 3.2), STB / D

$p_{inj}$  = water injection pressure, psi

$p_R$  = average reservoir pressure, psi

As shown in Figure 3-1 [10], water injectivity index declines at the beginning when water is injected into the reservoir that is depleted by solution-gas drive due to filling up of pore space occupied by free gas. Later on, the injectivity is based on the mobility ratio. The injectivity is constant if the mobility ratio is equal to 1 and increases if mobility ratio is bigger than 1. For favourable condition to displace oil, mobility ratio must be less than 1. In this case, injectivity decreases as cumulated injected water volume increases.

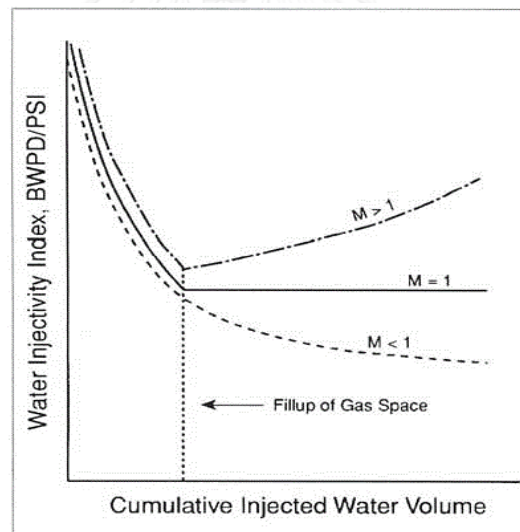

Figure 3-1 Water injectivity variations in a radial system [10]

### 3.4 Mobility ratio

Mobility ratio is defined as the mobility of displacing fluid divided by mobility of displaced fluid. It can be written as Equation 3.4.

$$M = \frac{\left[ \frac{k'_{rw}}{\mu_w} \right]}{\left[ \frac{k'_{ro}}{\mu_o} \right]} \quad (3.4)$$

where

$M$  = mobility ratio

$k'_{rw}$  = relative permeability to water at residual oil saturation

$k'_{ro}$  = relative permeability to oil at irreducible water saturation

$\mu_w$  = water viscosity, cp

$\mu_o$  = oil viscosity, cp

If  $M \leq 1$ , the velocity of displacing fluid is equal to or smaller than that of displaced fluid. It provides a smooth displacement front which is a favourable condition.

If  $M > 1$ , the velocity of displacing fluid is higher than velocity of displaced fluid, leading to a fingering displacement. It is an unfavourable condition.

### 3.5 Overall recovery efficiency

Recovery efficiency is a fraction of recovered oil produced from the beginning of waterflooding. Equation for recovery efficiency can be written as follows:

$$E_R = E_D \times E_A \times E_i \quad (3.5)$$

where

$E_R$  = overall recovery efficiency, fraction

$E_D$  = displacement efficiency, fraction

$E_A$  = areal sweep efficiency, fraction

$E_i$  = vertical sweep efficiency, fraction

#### 3.5.1 Displacement efficiency

Displacement efficiency is the fraction of movable oil that has been removed from the swept zone at any given time. It can be expressed as the difference of oil saturation before water flood and after water flood over oil saturation before water flood.

In term of equation,

$$E_D = 1 - \frac{(s_o / B_o)}{(s_{oi} / B_{oi})} \quad (3.6)$$

where

$S_o$  = average oil saturation in the flood pattern at a particular point

$B_o$  = oil formation volume factor at particular point, bbl / STB

$S_{oi}$  = initial oil saturation at starting of waterflood

$B_{oi}$  = oil formation volume factor at starting of waterflood, bbl / STB

### 3.5.2 Areal sweep efficiency

Areal sweep efficiency is a fraction of the pattern area that is swept by the displacing fluid. It is the area contacted with displacing fluid over total area. This sweep efficiency is affected by four main factors which are

- Flooding pattern type
- Mobility ratio
- Injected volume
- Reservoir heterogeneity

### 3.5.3 Vertical sweep efficiency

Vertical sweep efficiency is the fraction of pattern thickness that is swept by the displacing fluid. It is primarily a function of

- Vertical heterogeneity
- Degree of gravity segregation
- Fluid mobility
- Total injection volume

### 3.6 Relative permeability

Relative permeability is the ratio of effective permeability of a particular fluid at a particular saturation to absolute permeability of that fluid at total saturation. Calculation of relative permeability allows comparison of the different abilities of fluids to flow in the presence of each other since the presence of more than one fluid generally inhibits flow.

### 3.6.1 Corey's correlation

Corey's correlation [11] is a well-known correlation widely used to describe oil, water and gas relative permeability. The correlation is a function of fluid saturation and can be expressed from modified Brooks-Corey function as shown in the following equations:

$$k_{ro} = k_{ro,\max} \left( \frac{s_o - s_{or}}{1 - s_{or} - s_{wc} - s_{gr}} \right)^{n_o} \quad (3.7)$$

$$k_{rw} = k_{rw,\max} \left( \frac{s_w - s_{wc}}{1 - s_{or} - s_{gr} - s_{wc}} \right)^{n_w} \quad (3.8)$$

$$k_{rg} = k_{rg,\max} \left( \frac{s_g - s_{gr}}{1 - s_{or} - s_{gr} - s_{wc}} \right)^{n_g} \quad (3.9)$$

where

$k_{ro}$  = relative permeability to oil

$k_{rw}$  = relative permeability to water

$k_{rg}$  = relative permeability to gas

$k_{ro,\max}$  = maximum relative permeability to oil

$k_{rw,\max}$  = maximum relative permeability to water

$k_{rg,\max}$  = maximum relative permeability to gas

$s_o$  = oil saturation

$s_g$  = gas saturation

$s_w$  = water saturation

$s_{or}$  = residual oil saturation

$s_{gr}$  = residual gas saturation

$s_{wc}$  = connate water saturation

$n_o$  = corey's oil exponent

$n_w$  = corey's water exponent

$n_g$  = corey's gas exponent

### 3.6.2 Stone's model

Stone [12] described a method of using two sets of two-phase data to predict the relative permeability of the intermediate wettability phase in a three-phase system.

After his correlation, he came up with two relevant models namely as: Stone model I and Stone model II.

### Stone model I

This model emphasizes on the prediction of relative permeability in low oil saturation region. Correlations of each phase suggest that relative permeability to wetting phase (water) is a function of water saturation alone and of that to the nonwetting phase (gas) is a function of gas saturation alone. By treating connate water and irreducible residual oil as immobile fluids, the correlation is obtained as:

$$S_o^* = \frac{S_o - S_{or}}{1 - S_{wc} - S_{or}} \quad \text{for } S_o \geq S_{or} \quad (3.10)$$

$$S_w^* = \frac{S_w - S_{wc}}{1 - S_{wc} - S_{or}} \quad \text{for } S_w \geq S_{wc} \quad (3.11)$$

$$S_g^* = \frac{S_g}{1 - S_{wc} - S_{or}} \quad (3.12)$$

Oil relative permeability is related to oil saturation can be defined as:

$$k_{ro} = S_o^* \beta_w \beta_g$$

The two multipliers  $\beta_w$  and  $\beta_g$  are calculated from:

$$\beta_w = \frac{k_{row}}{1 - S_w^*} \quad (3.13)$$

$$\beta_g = \frac{k_{rog}}{1 - S_g^*} \quad (3.14)$$

### Stone model II

Stone model II is a modified version of Stone model I. It is a better predictor than Stone model I in high-oil saturation regions. It is more appropriate for water-wet systems and is not suited for intermediate wetting systems.

$$k_{ro} = (k_{ro})_{s_{wc}} \left[ \left( \frac{k_{row}}{(k_{ro})_{s_{wc}}} + k_{rw} \right) \left( \frac{k_{rog}}{(k_{ro})_{s_{wc}}} + k_{rg} \right) - (k_{rw} + k_{rg}) \right] \quad (3.15)$$

### 3.7 Fracturing pressure

A major saving cost of waterflooding is the reduction of the number of injectors. To achieve this, the injector capacity should be maximized and placed at appropriate location to sweep the oil efficiently. However, higher injection pressure above reservoir breakdown pressure can create vertical fracture to propagate into other reservoir. This fracture propagation causes the loss of injected water. Thus, initial injection pressure should be below formation pressure to avoid fracturing condition.

Fracturing pressure can be calculated using Hubbert and Willis equation [13]:

$$p_{ff} = \frac{\sigma_{ob} + 2p_f}{3} \quad (3.16)$$

where

$p_{ff}$  = fracture pressure, psig

$\sigma_{ob}$  = vertical over burden stress, psig

$p_f$  = formation pressure, psig

Fracturing pressure can also be calculated from correlation obtained from M field in Thailand [14]:

$$\text{Fracturing pressure} = \frac{FRAC.S.G \times TVD}{10.2} \quad (3.17)$$

where

$FRAC.S.G = 1.22 + (TVD \times 1.6 \times 10^{-4})$ , fracturing pressure gradient (bars/meter)

$TVD$  = true vertical depth below rotary table (meter)



## CHAPTER 4

### RESERVOIR SIMULATION MODEL

This section describes the reservoir model created using ECLIPSE100 for numerical simulation to see the performance of water dumpflood, water injection and the combination of water dumpflood with water injection into oil reservoir. Rock properties, fluid properties and special core analysis parameters are presented.

#### 4.1 Reservoir model

The simulation model consists of one underlying oil reservoir and one overlying aquifer isolated by a shale layer of 1800 ft. The model is constructed as a rectangular shape in the Cartesian coordinates and is assumed to be homogeneous. The oil reservoir is constructed with 43×19×20 grid blocks in the x-, y-, and z-direction respectively. Two sizes of aquifer of 10PV and 50PV to oil reservoir are constructed as shown in Figure 4-1 and Figure 4-2, respectively. The 10PV aquifer is constructed with 53×31×20 grid blocks in the x-, y-, and z-direction, respectively while the 50PV aquifer is constructed with 101×81×20 grid blocks in the x-, y-, and z-direction, respectively. Both 10PV and 50PV aquifer have the same thickness of 200 ft while the oil reservoir has thickness of 40 ft.

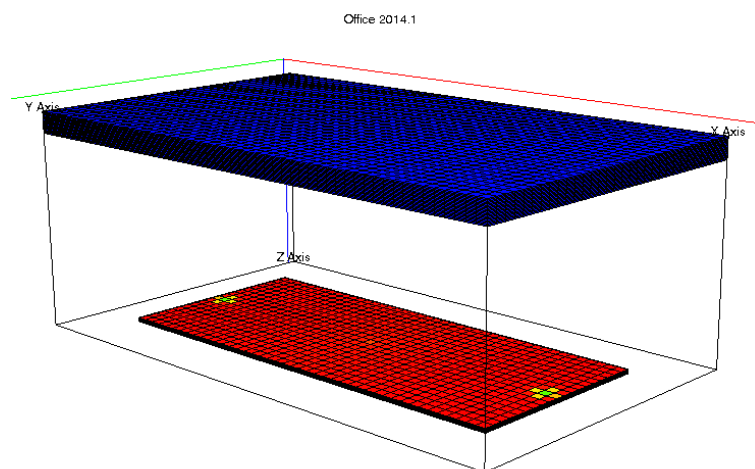

Figure 4-1 3D view of oil reservoir (bottom) and 10PV aquifer (top)

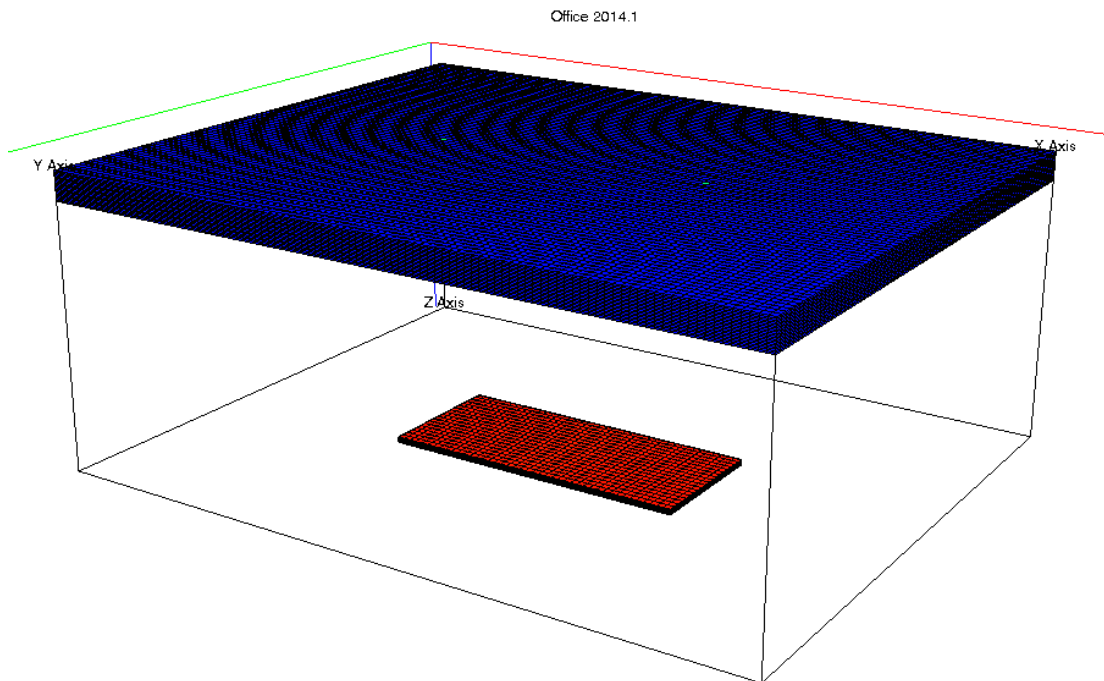

Figure 4-2 3D view of oil reservoir (bottom) and 50PV aquifer (top)

## 4.2 Reservoir properties

### 4.2.1 Rock and fluid properties

Rock and fluid properties used in the simulation were obtained from an oil field in Thailand. Rock properties of both aquifer and oil reservoir are summarized in Table 4-1. Reservoir fluid properties in Table 4-2 include oil and gas gravity, solution gas-oil ratio, bubble point pressure of oil, oil and water formation volume factor at initial condition, and oil and water viscosity at initial condition that generated from correlation in ECLIPSE100. The generated PVT properties such as oil formation volume factor, oil viscosity, and solution gas-oil ratio as function of pressure are plotted in Figure 4-3.

Table 4-1 Physical properties of aquifer and oil reservoir

Parameter	Value		Units
	Oil reservoir	Aquifer	
Grid size	100×100×2	100×100×10	ft.
Top depth	8000	6000	ft.
Thickness	40	200	ft.
Effective porosity	20	20	%
Horizontal permeability	100	100	mD.
Vertical permeability	10	10	mD.
Initial pressure	3440	2580	psia
Temperature	240	200	°F
Dipping angle	0	0	degree
Fracturing pressure	5583	3933	psia

Table 4-2 PVT properties of reservoir model

Parameter	Value	Unit
Oil gravity	25.4	°API
Gas specific gravity	0.8	
Salinity	6000	ppm
Solution gas-oil ratio @ initial condition	200	scf/STB
Bubble-point pressure of oil	1401	psia
Oil formation volume factor @ initial condition	1.162	rb/stb
Oil viscosity @ initial condition	1.541	cp
Water formation volume factor @ initial condition	1.036	rb/stb
Water viscosity @ initial condition	0.241	cp
Water compressibility	4.829E-6	psi <sup>-1</sup>

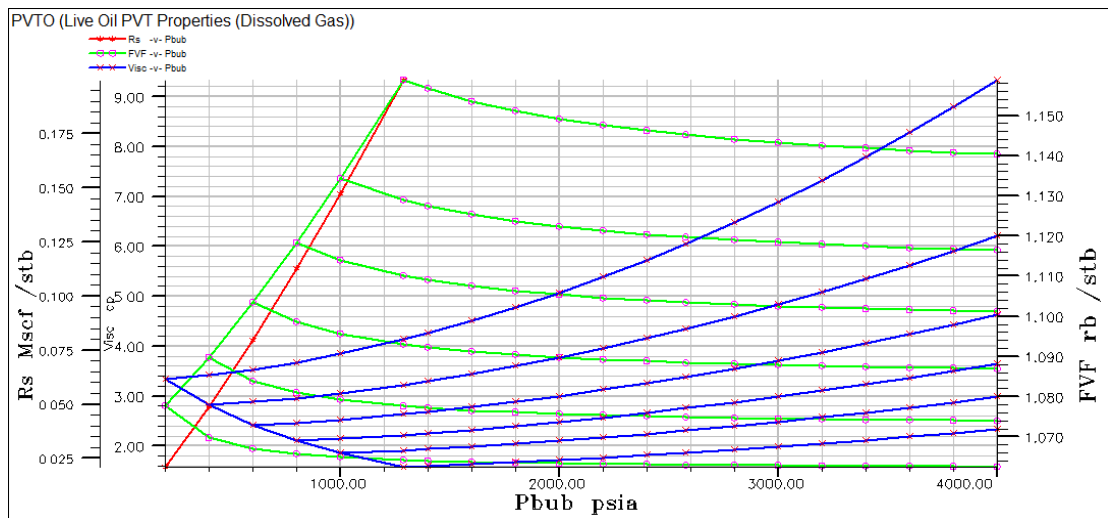

Figure 4-3 Live oil PVT properties of the reservoir

#### 4.2.2 Special core analysis (SCAL)

Relative permeability curves of the reservoir are obtained from Corey's correlation with input parameters shown in Table 4-3. Oil-water and oil-gas relative permeability curves are depicted in Figure 4-4 and Figure 4-5.

Table 4-3 Special core analysis

Parameter	Value
Corey's oil exponent, $n_o$	3
Corey's water exponent, $n_w$	3
Corey's gas exponent, $n_g$	3
Connate water saturation, $S_{wc}$	0.25
Water relative permeability at $S_{orw}$	0.3
Water relative permeability at $S_{w,max}$	1
Residual oil saturation to water, $S_{orw}$	0.3
Residual oil saturation to gas, $S_{org}$	0.3
Oil relative permeability at $S_{wc}$	0.6
Oil relative permeability at $S_{gc}$	0.6
Critical gas saturation, $S_{gcr}$	0.15
Initial gas saturation, $S_{gi}$	0.15
Gas relative permeability at $S_{org}$	0.6
Gas relative permeability at $S_{gmax}$	0.6

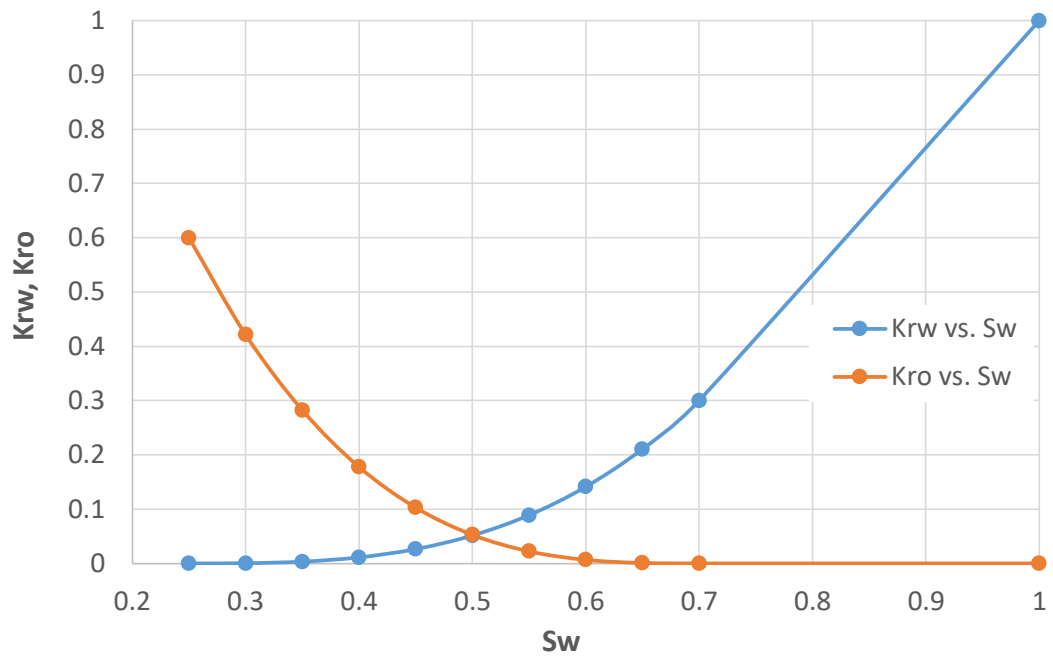

Figure 4-4 Relative permeability to oil and water as a function of water saturation

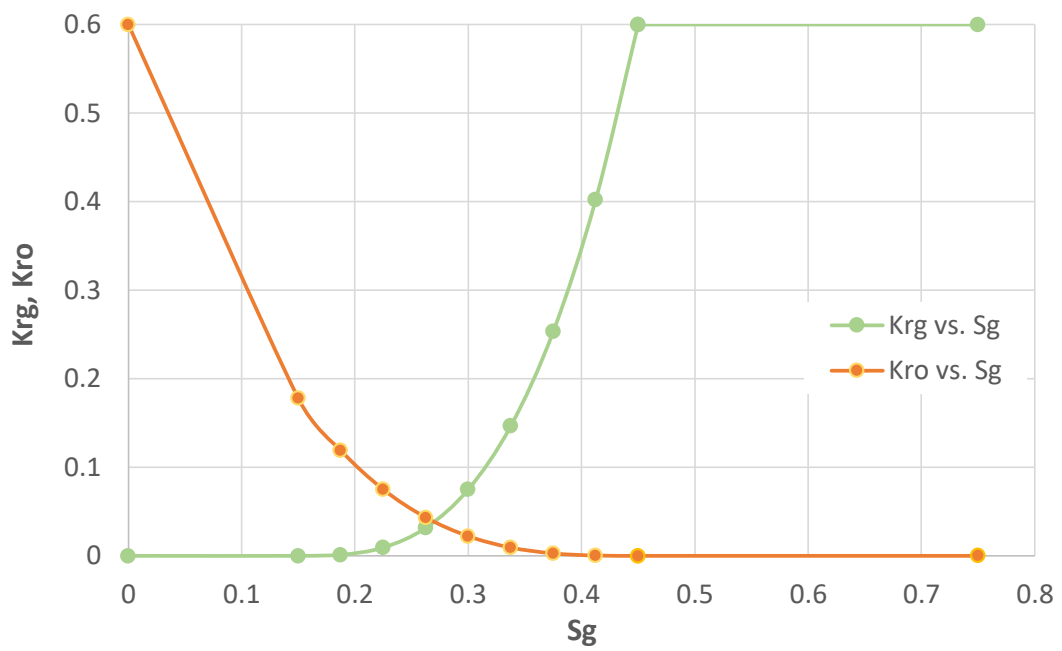

Figure 4-5 Relative permeability to oil and gas as a function of gas saturation

### 4.3 Well model

There are one production well and two dumping/injection wells in the model. The production well is placed in the middle of the reservoir while the dumping/injection wells are placed at the flank of the reservoir. Vertical wells are perforated full to base, and horizontal wells are located at mid depth of the oil reservoir. This geometry is a common direct-line-drive pattern. Four well type combinations as shown in Figures 4-6 to Figure 4-9 and as described below are investigated in this study:

- Well option 1: One vertical producer and two vertical injectors (VV)
- Well option 2: One vertical producer and two horizontal injectors (VH)
- Well option 3: One horizontal producer and two vertical injectors (HV)
- Well option 4: One horizontal producer and two horizontal injectors (HH)

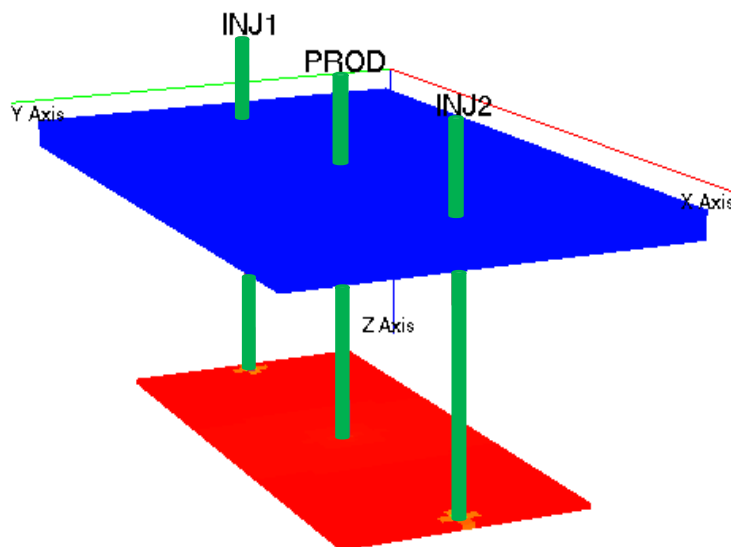

Figure 4-6 One vertical producer and two vertical injectors (well option 1)

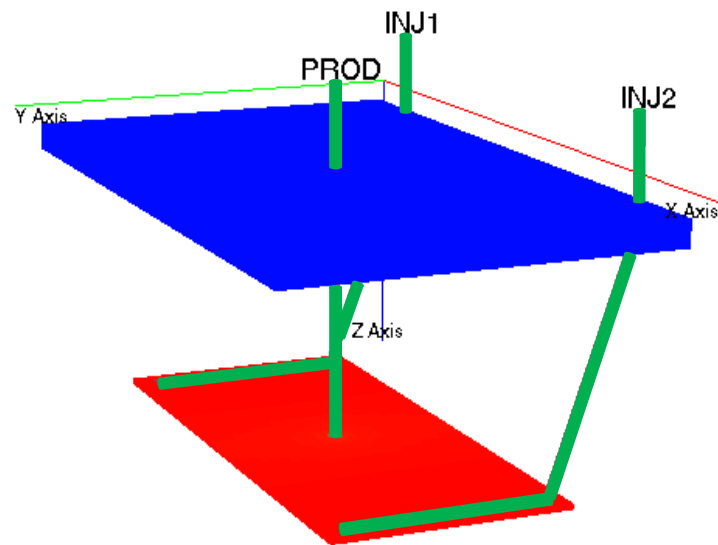

Figure 4-7 One vertical producer and two horizontal injectors (well option 2)

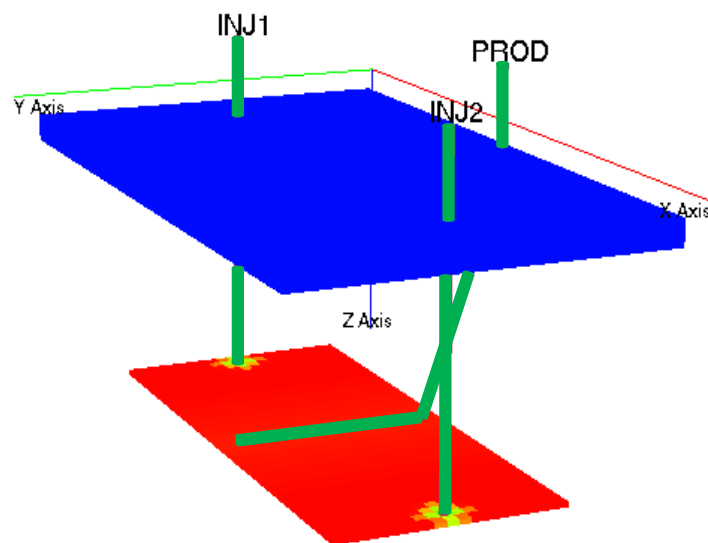

Figure 4-8 One horizontal producer and two vertical injectors (well option 3)

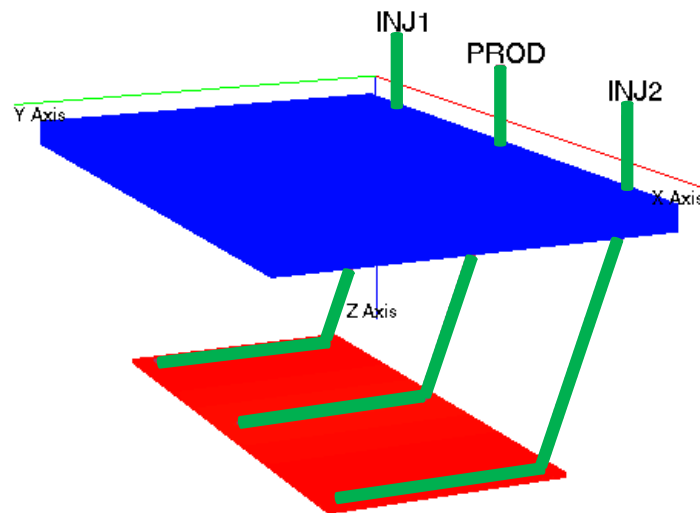

Figure 4-9 One horizontal producer and two horizontal injectors (well option 4)

For horizontal well trajectory, long-radius horizontal well type is selected with build-up rate of  $8^\circ$  per 100 ft and kick-off point starts at depth of 7305 ft. Figure 4-10 illustrates the well trajectory of horizontal wells in this study.

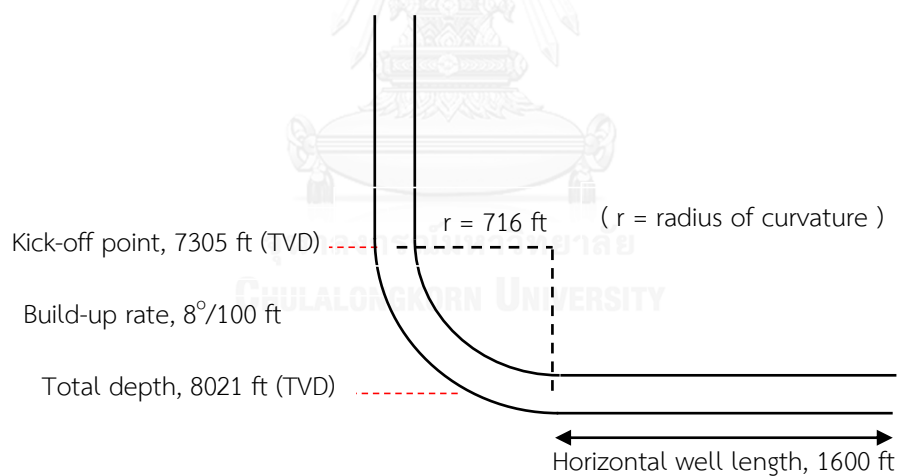

Figure 4-10 Horizontal well trajectory

#### 4.4 Production constraint

Well production constraints are selected as bottom hole pressure of production well, maximum water cut and oil economic limit as summarized in Table 4-4. For injection wells, the maximum bottom hole pressure is set to be 5000 psia which is below the fracturing pressure of 5583 psia.



Table 4-4 Production constraints of production well

Parameter	Value	Unit
Oil economic limit	50	STB/D
Maximum water cut	0.9	
Bottom hole pressure at production well	200	psia
Production time	30	year

#### 4.5 Methodology

This section illustrates the steps to be conducted in this study. The procedures are based on two main parameters: reservoir parameters and operational parameters. Two sizes of aquifer of 10PV and 50PV are selected as the reservoir parameters. Well types, production and injection rate (assuming to be equal), dumping and injection schedules are the operational parameters to be investigated. Each of the step is describes as follows:

1. Constructing rectangular flat oil reservoir at the depth of 8000 ft with dimension of 4300 × 1900 × 40 cu ft.
2. Aquifer sizes of 10PV and 50PV with the same thickness are built above the oil reservoir for dumping water and the top depth is 6000 ft.
3. Designing parameters that would help to maximize the recovery factor as follows:
  - Well types:
    - One vertical producer and two vertical injectors (VV)
    - One vertical producer and two horizontal injectors (VH)
    - One horizontal producer and two vertical injectors (HV)
    - One horizontal producer and two horizontal injectors (HH)
  - Maximum liquid production rate:
    - 1000 STB/D
    - 2000 STB/D

Note that the maximum water injection rate is constrained to the same value as maximum liquid production rate.

➤ Dumping and injection schedule:

- Schedule 1 (Two dumping wells later converted to two injection wells): at the beginning, two wells at the flank of the reservoir are used for dumping water from overlying aquifer into oil reservoir. Then, these dumping wells will be converted to water injection wells when aquifer pressure drops to 300 psi, 1060 psi, and 1820 psi (100%, 66.67%, 33.33% of maximum pressure depletion in aquifer) as three different cases. Note that the maximum pressure depletion in aquifer is the difference between the initial aquifer pressure of 2580 psi and the abandonment aquifer pressure set at 300 psi. The production well at the middle is scheduled to produce since the beginning.
- Schedule 2 (One all-time dumping well and one all-time injection well): one well at the flank of the reservoir is used for dumping water from aquifer while another well at the other flank is used for injecting water from surface. These dumping and injecting wells are used to flood the oil reservoir simultaneously until production constraint is reached. The production well at the middle is scheduled to produce since the beginning.
- Schedule 3 (One dumping well later converted to water injection well and one all-time injection well): one well at the flank of the reservoir is used for dumping water from aquifer while another well at the other flank is used for injecting water from surface. These dumping and injecting wells are used to flood the oil reservoir simultaneously. Later on, the well that is used for dumping water will be converted to water injection well when the aquifer pressure drops to 300 psi, 1060 psi, and

1820 psi (100%, 66.67%, 33.33% of maximum pressure depletion in aquifer) as three different cases. The production well at the middle is scheduled to produce since the beginning.

4. Simulating the cases for conventional water injection using different well types, and production and injection rates as depicted in Figure 4-12.
5. Simulating the cases for water dumpflood using different aquifer sizes, well types, and production and injection rates as depicted in Figure 4-13.
6. Simulating the cases for combined water dumpflood and conventional water injection by combining different aquifer sizes, well types, liquid production rates, and dumping and injection schedules as illustrated in Figure 4-14.
7. Observing and evaluating the performances from each case
8. Summarizing the results and finding the appropriate cases for maximizing production and minimizing injected water.
9. Making conclusions and recommendations.

Figures 4-11 to Figure 4-14 illustrate the summaries of all steps in the simulation study and the combination of each individual parameters.



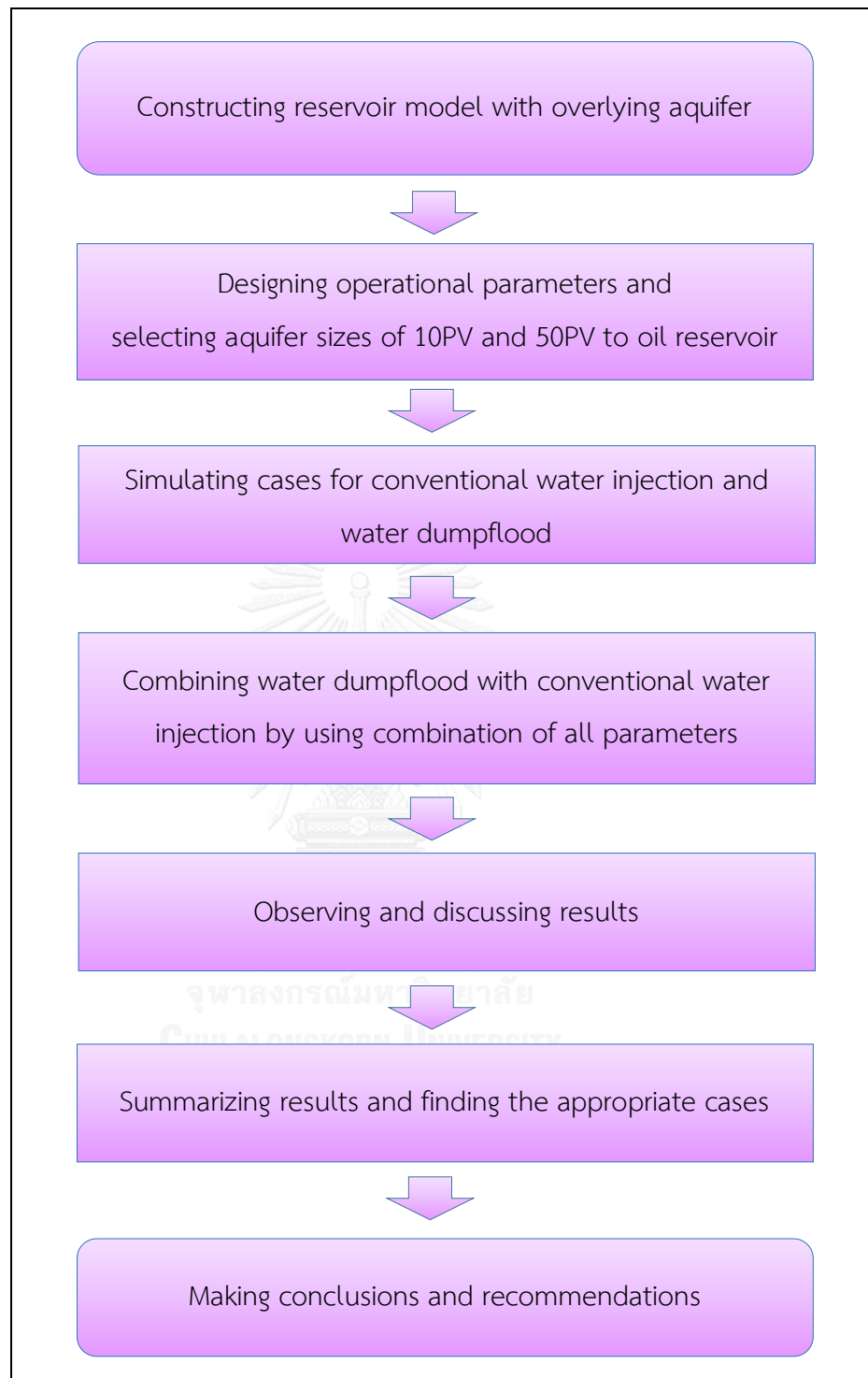

Figure 4-11 Flow chart of methodology

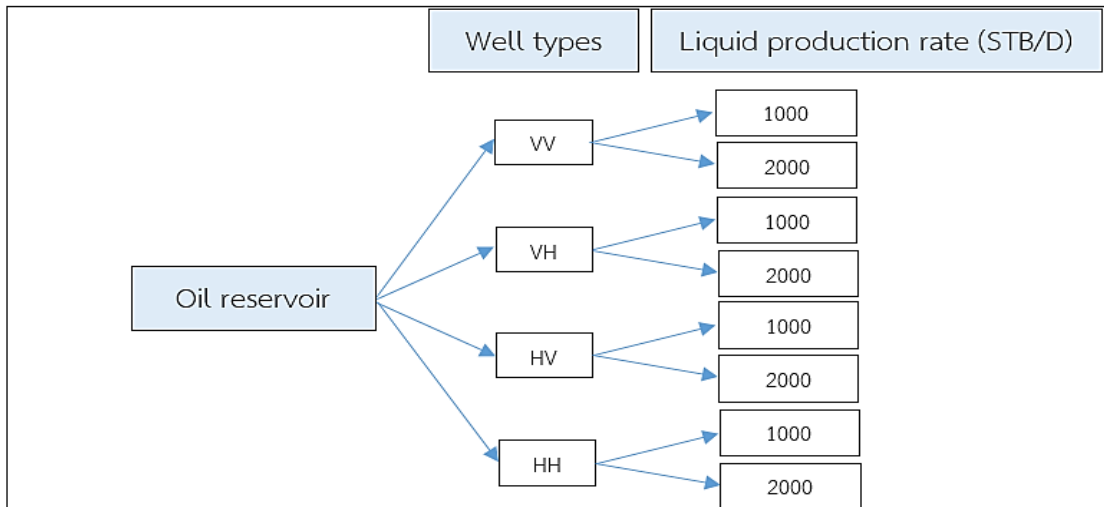

Figure 4-12 Flow chart of simulation cases for conventional water injection

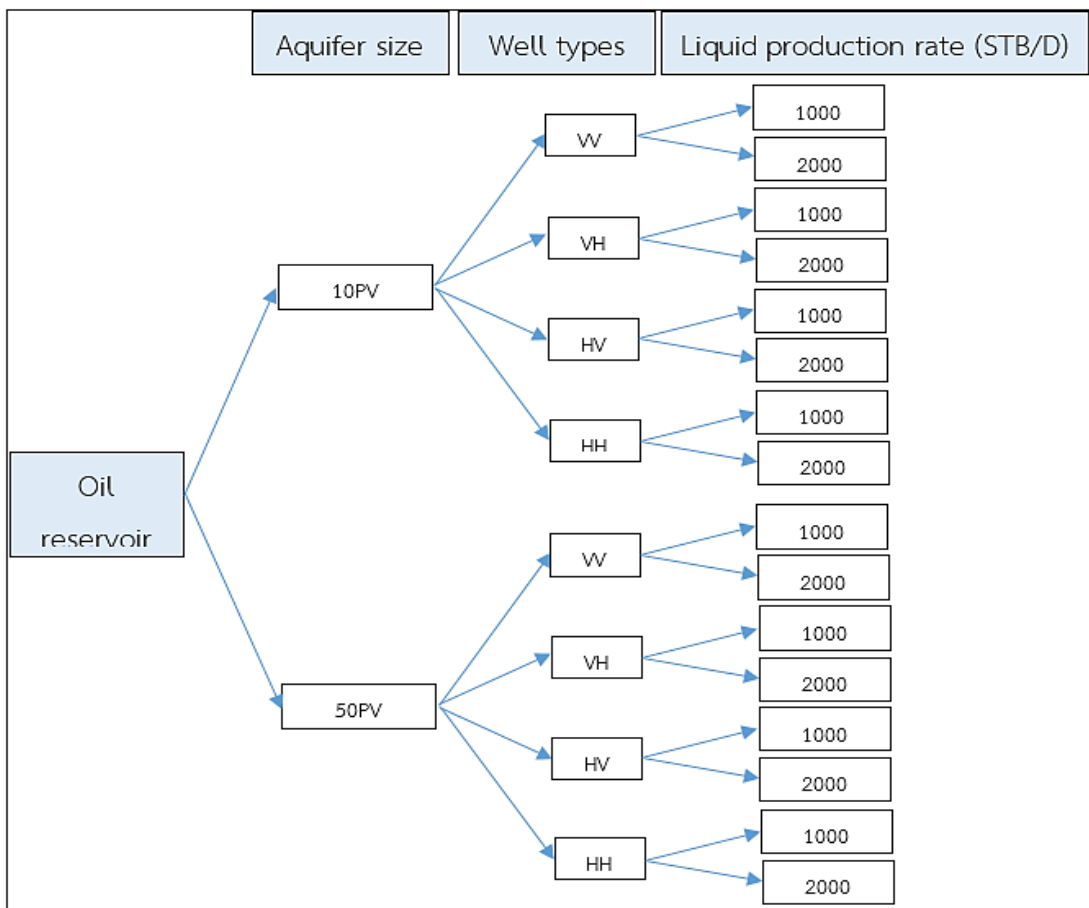

Figure 4-13 Flow chart of simulation cases for water dumpflood

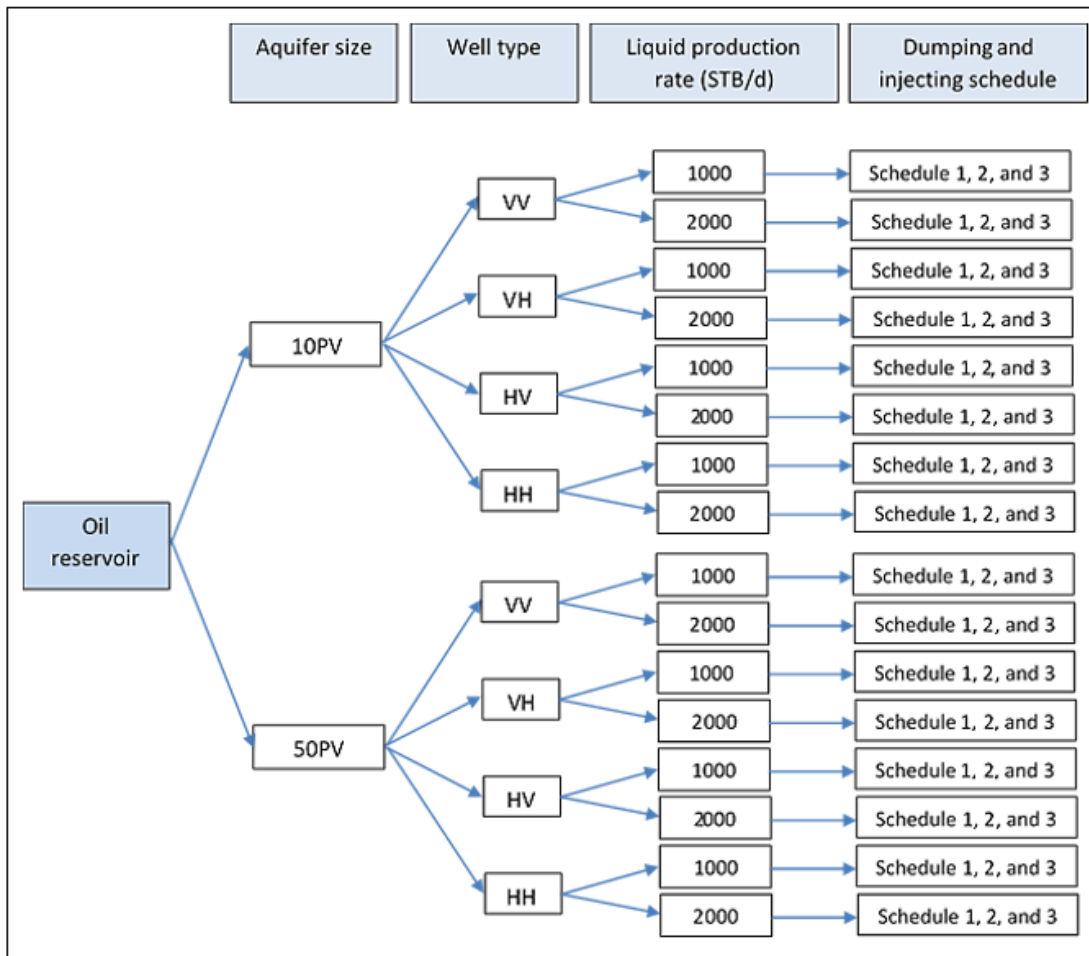

Figure 4-14 Flow chart of simulation cases for combined water dumpflood with water

## CHAPTER 5

### RESULTS AND DISCUSSION

This chapter summarizes the results of all simulation cases from conventional water injection, water dumpflood, and combined water dumpflood with water injection. In conventional water injection, four well options are used in the production strategy with two different flow rates, and results are summarized in term of total oil production, total water production, total water injection, and oil recovery factor. In water dumpflood, the cases were simulated using two separate aquifer sizes (10PV and 50PV) and combining with four different well options and two liquid production rates. The summary results also include the total water dumped from the aquifer.

In the case of combined water dumpflood with water injection, the discussion includes the effect of water dumping and injection schedules integrated with liquid production rates for different well options in both 10PV and 50PV aquifers, comparison among different well options, and comparison among different approaches which are conventional water injection, water dumpflood, and combination technique.

#### 5.1 Conventional water injection

In conventional water injection case, the oil reservoir located at 8000 ft depth was produced with one producer and two injectors using four different well options (option 1, 2, 3, and 4) in order to determine the best well types for producer and injector. Maximum liquid production rates of 1000 and 2000 STB/D were simulated. The total maximum water injection rate from both injectors was constrained to the same value as maximum liquid production rate in each case. The production time was limited to 30 years.

##### *a) Maximum liquid production rate of 1000 STB/D*

Results from simulation illustrate that well option 1 in case of maximum liquid production rate of 1000 STB/D has slightly higher oil recovery factors of 1.27, 2.03, and 2.83 compared to the other three cases. Figure 5-1 depicts the cumulative oil

production and Table 5-1 summarizes the results of four well options with 1000 STB/D maximum liquid production rate. As illustrated in Figure 5-2, oil production rates from the four well options can be achieved for a plateau of 1000 STB/D for a while and start to drop steadily when the water breakthrough occurs. The oil production rate of well option 1 drops faster than that of the other three cases due to early water breakthrough from the rapid movement of the shortest streamline between vertical injectors and vertical producer as shown in Figure 5-3 and Figure 5-4. When this flood front arrives at the producer, the oil production rate drops sharply as oil saturation around the producer decreases dramatically. Then, the other portion of injected water sweeps the oil from the edges of reservoir to the producer, leading to a slower decline of oil production rate. The well finally dies because water cut reaches the maximum value of 90% cut-off. Ultimately, well option 1 provides higher oil rate but total water injection is also higher due to slower decline of oil rate.

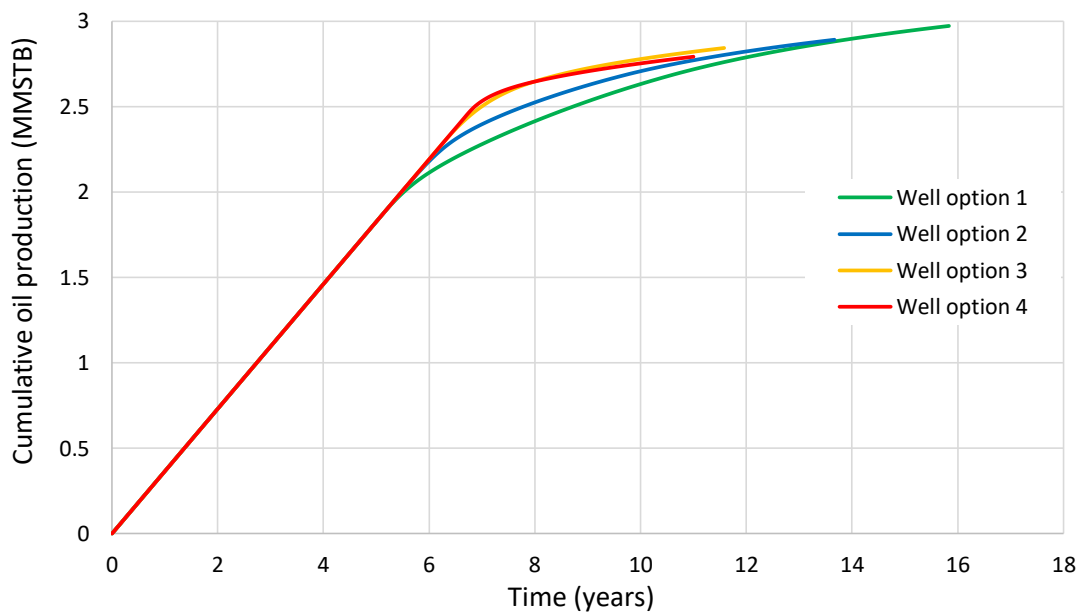

Figure 5-1 Cumulative oil productions of four well options with maximum liquid production rate of 1000 STB/D in conventional water injection



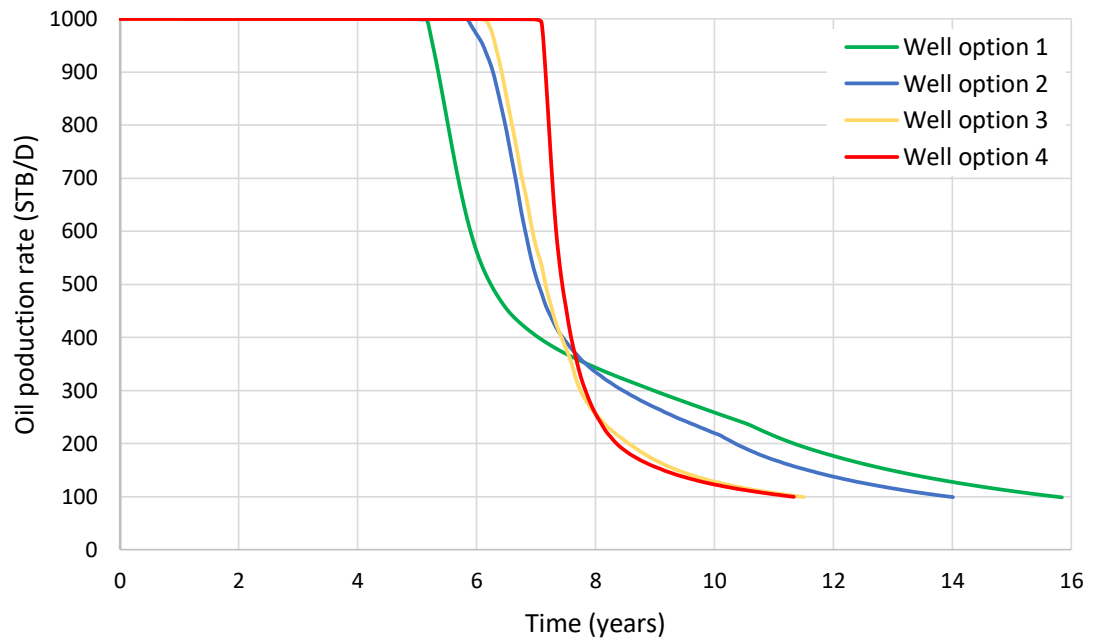

Figure 5-2 Oil production rates of four well options with maximum liquid production rate of 1000 STB/D in conventional water injection

Table 5-1 Results of four well options with maximum liquid production rate of 1000 STB/D in conventional water injection

Well type	Total oil production (MMSTB)	Total water production (MMSTB)	Total water injection (MMSTB)	Oil recovery factor (%)	Production time (years)
Option 1	2.972	2.434	5.783	46.65	15.84
Option 2	2.891	1.812	4.992	45.38	13.68
Option 3	2.843	1.387	4.230	44.62	11.59
Option 4	2.792	1.226	4.018	43.82	11.01

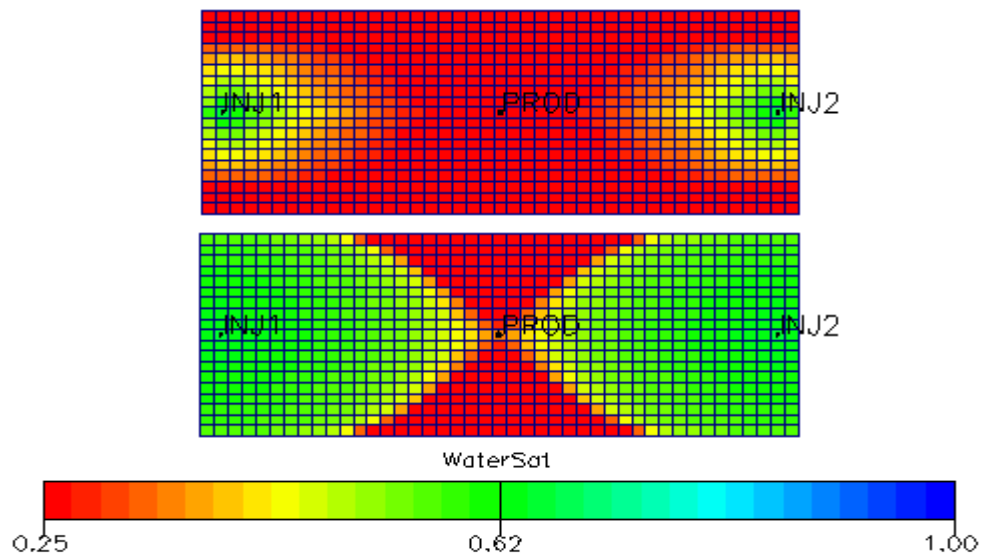

Figure 5-3 Reservoir water saturation profiles of well option 1 from top layer (top) and bottom layer (bottom) after 5.5 years of production with maximum liquid production rate of 1000 STB/D in conventional water injection

Water breakthroughs of well options 2, 3 and 4 happen consecutively after well option 1 as depicted in Figure 5-4. The oil production rate of each case also drops from the plateau rate in the same order as a result of water breakthrough. In the case of well option 2, oil production rate drops sharply at 5.58 years of production for nearly two years and continues to drop more slowly until the end of production. Similar to well option 1, water breakthrough of well option 2 happens primarily from the flood front of the shortest path between horizontal injectors and the vertical producer, resulting in high water production rate and hence less oil production rate. After that, injected water still displaces oil in areas along the edges of the reservoir until the water cut reaches the limit at 90% cut-off. Figure 5-5 demonstrates the flood front of well option 2 when water breakthrough begins.

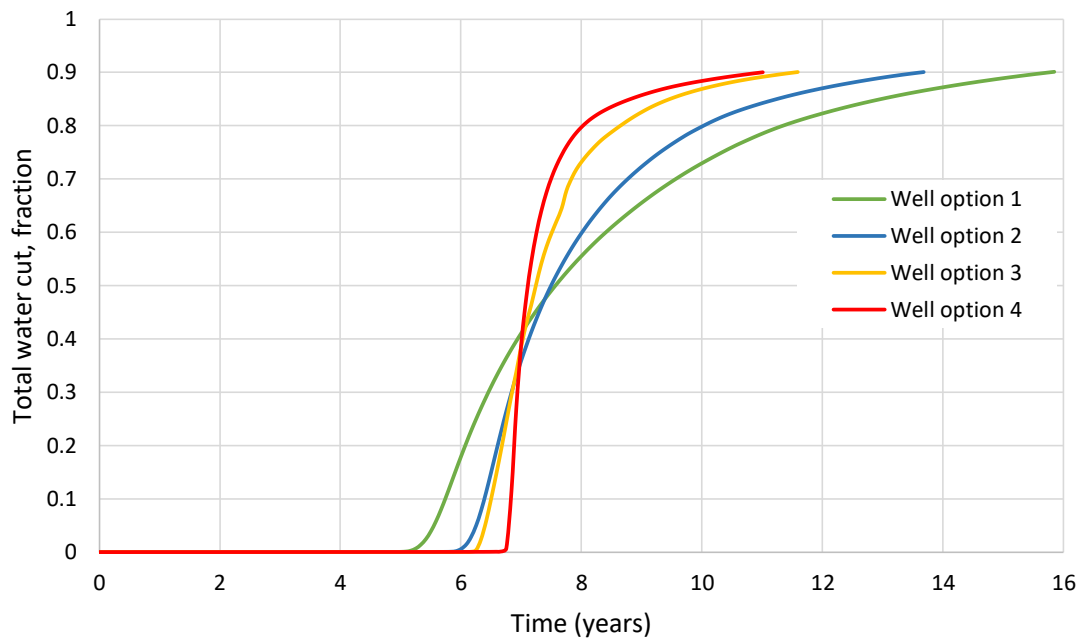

Figure 5-4 Total water cuts of four well options with maximum liquid production rate of 1000 STB/D in conventional water injection

For well options 3 and 4 of which producer is a horizontal well located at mid height of the reservoir, the oil production rate of 1000 STB/D can be produced for longer times because of two reasons. First, horizontal producer has a better productivity. Second, gravity segregation slows down water breakthrough. Due to gravity segregation, injected water tends to move downward, underrunning the oil. As a result, injected water reaches the horizontal producer (well options 3, and 4) at the middle of the reservoir later than vertical producer (well options 1 and 2 with full to base perforation) as shown in Figure 5-6. However, when the water breaks through the producer, the oil production rate falls dramatically because injected water can easily enter the well along the horizontal length. Thus, the production constraint of water cut is reached quickly.

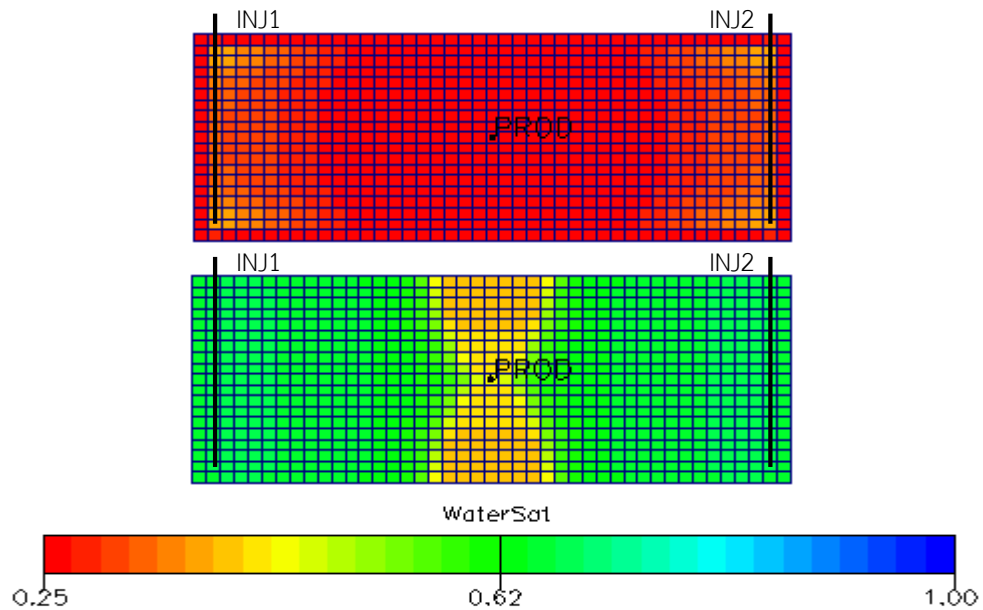

Figure 5-5 Reservoir water saturation profiles of well option 2 from top layer (top) and bottom layer (bottom) after 5.8 years of production with maximum liquid production rate of 1000 STB/D in conventional water injection

As shown in Figure 5-2, oil production rate of well option 4 stays at the plateau rate longer than other cases and drops sharply afterward. Since both the injectors and producer are long horizontal wells, flood front of injected water travels at more or less the same speed across the width of the reservoir (y-axis) but slower compared to other cases. This provides a good areal sweep efficiency. When water breakthrough occurs, injected water enters the producer at the same time along the length of the producer, leading to sharp increase in water cut which eventually reaches the maximum value of 90% in a short period of time after water breakthrough. Thus, the abandonment condition is reached quite early. As a result, oil recovery factor is slightly less than other cases.

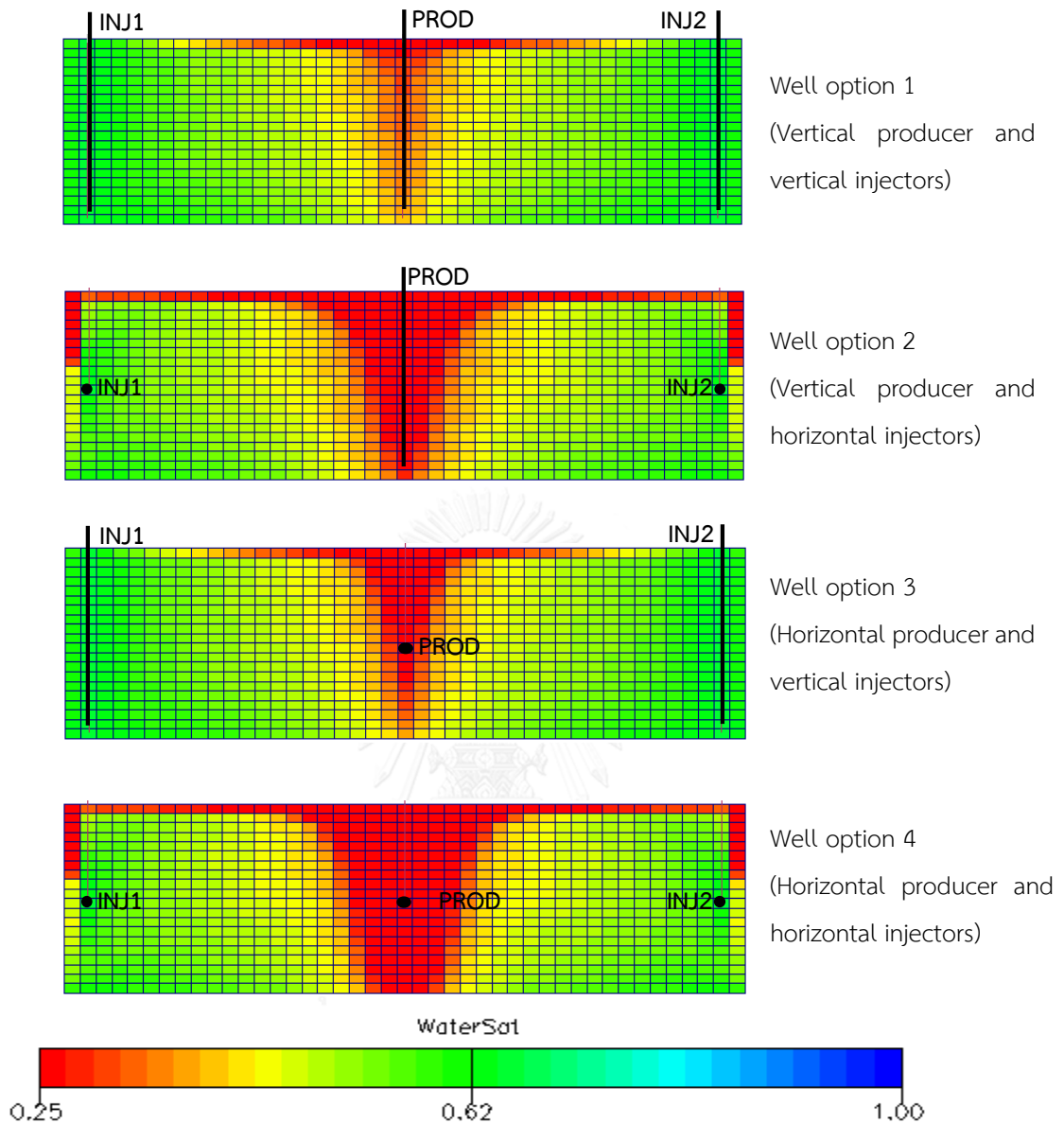

Figure 5-6 Side view cross-sections (z-x plane) of four well options at 6.16 years of production with maximum liquid production rate of 1000 STB/D in conventional water injection

As shown in Table 5-1, well option 1 produces the highest total water production because of the earliest water breakthrough from the rapid movement of the shortest streamline between vertical injectors and vertical producer and the longest production time. For well option 2 of which two injectors are horizontal wells, the injected water travels across the width of the reservoir but slower compared to

vertical injectors with the same vertical producer, and the injected water breaks through the producer from its bottom section. Thus, the total water production is smaller than that of well option 1. Total water production of well option 3 is even smaller compared to options 1 and 2. The reasons are that the injected water from vertical injectors tends to move downward and reaches the horizontal producer located at the mid height of the reservoir at later times and that the production time is shorter. For well option 4 of which both producer and injectors are horizontal wells, the movement of flood front is not only slow but it takes longer time to enter the producer at the mid height of the reservoir, leading to later water breakthrough than other three cases. After the breakthrough, the well can be produced for a short period. As a result, well option 4 has the smallest total water production.

As tabulated in Table 5-1, total water injection of well option 1 is the highest because of the earliest water breakthrough and longest production time. For well option 2, the required water injection is smaller due to the benefit from horizontal injectors that provides better areal sweep efficiency and a bit shorter time for production. Total water injection of well option 3 is even less compared to options 1 and 2 due to the same reasons (later water breakthrough times and shorter production times).

Production time of well option 1 is the longest due to slower increment of water cut since the injected water gradually arrives at the producer. The shortest streamline between vertical producer and vertical injectors arrives first and is followed by other streamlines that travel for longer distances between injectors and the producer. For well option 2, water cut jumps slightly faster because the smoother flood front from horizontal injectors reaches the producer more or less at the same time, leading to shorter production time than well option 1. In case of well options 3 and 4, rapid increases in water cut after breakthrough lead to early abandonment.

*b) Maximum liquid production rate of 2000 STB/D*

Table 5-2 summarizes the results of four well options with 2000 STB/D maximum liquid production rate. Results from simulation illustrate that well options 1 and 2 have approximately the same oil recovery factors (less than 1% difference). As

illustrated in Figure 5-7, oil production rate of well option 1 starts to drop steadily at 0.54 years of production because of high drawdown and low productivity of producer. The rate drops again to another trend due to lower oil saturation around the well bore as a result of water breakthrough from the rapid movement of the shortest streamline between vertical injectors and vertical producer. When the other portion of injected water sweeps the oil from the edges of the reservoir to the producer, the oil rate declines slowly until the end of production. As a result, the highest oil recovery is achieved as shown in Table 5-2. Finally, the well dies because water cut reaches the maximum value of 90% cut-off.

Table 5-2 Results of four well options with maximum liquid production rate of 2000 STB/D in conventional water injection

Well type	Total oil production (MMSTB)	Total water production (MMSTB)	Total water injection (MMSTB)	Oil recovery factor (%)	Production time (years)
Option 1	3.064	2.333	6.269	48.09	8.59
Option 2	3.016	1.818	5.659	47.33	7.75
Option 3	2.715	1.242	3.956	42.61	5.42
Option 4	2.627	1.007	3.654	41.23	5.01

In the case of well option 2, oil production rate drops in the same trend as well option 1 because of high drawdown and low productivity of producer. Later on, the rate drops again to another trend because water breaks through the producer. Water breakthrough of well option 2 happens at later time from the flood front of the shortest path between horizontal injectors and the vertical producer but increases faster than well option 1, resulting in high water production rate and hence slightly less oil production rate. Ultimately, the well dies when the water cut reaches the limit at 90% cut-off.

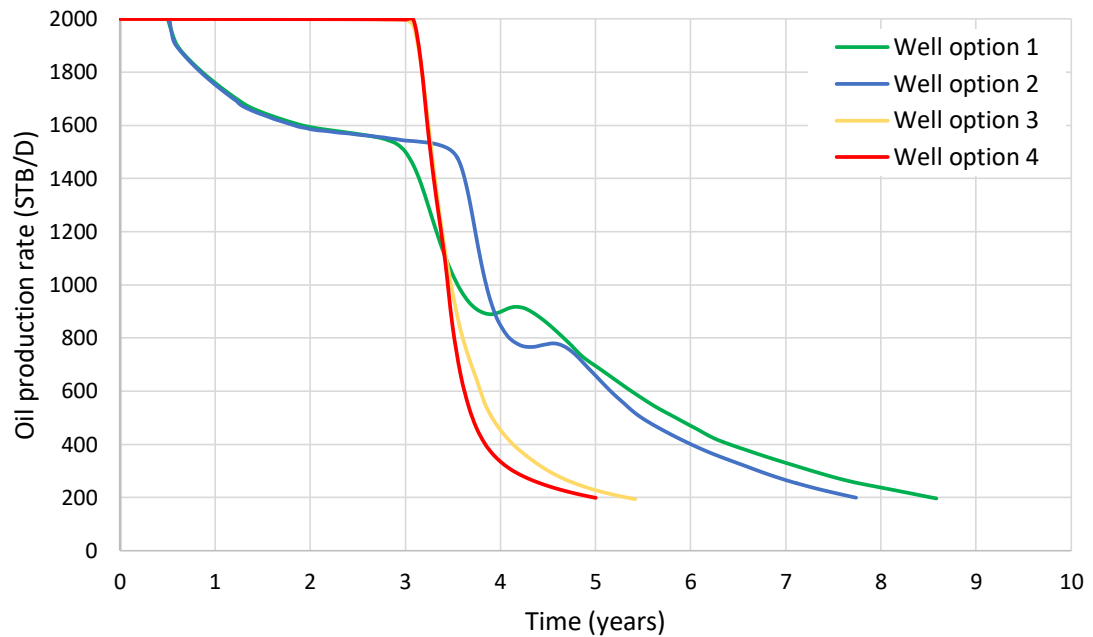

Figure 5-7 Oil production rates of four well options with maximum liquid production rate of 2000 STB/D in conventional water injection

Oil recovery factors of well options 3 and 4 have no significant difference but are moderately lower than that of well options 1 and 2. For well option 3 of which producer is a horizontal well located at mid height of the reservoir, the oil production rate of 2000 STB/D can be produced for longer times (3 years) because of better productivity of producer and gravity segregation that slows down water breakthrough. However, when the water breaks through the producer, the oil production rate falls dramatically because injected water can easily enter the horizontal producer along its length. Thus, the production constraint of water cut is reached very quickly. Thus, oil recovery factor is moderately lower than that of options 1 and 2.

Oil production rate of well option 4 also stays at the plateau rate longer and drops sharply afterward. Since both the injectors and producer are long horizontal wells, flood front of injected water travels at more or less the same speed across the width of the reservoir (y-axis). This provides a good areal sweep efficiency and higher cumulative oil production before water breaks through. When water breakthrough occurs, injected water enters the producer at the same time along the length of the producer, leading to sharp increase in water cut which eventually reaches the



maximum value of 90% in a short period of time. Thus, the abandonment condition is reached quite early. As a result, oil recovery factor is slightly less than that of well option 3 but moderately less than that of options 1 and 2.

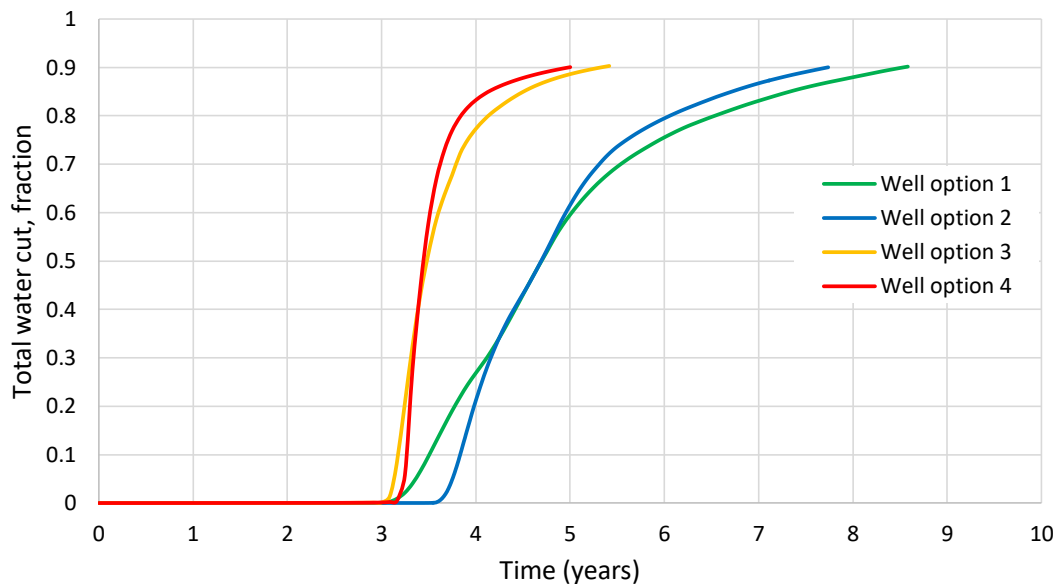

Figure 5-8 Total water cuts of four well options with maximum liquid production rate of 2000 STB/D in conventional water injection

As illustrated in Table 5-2, well option 1 produces the highest total water production because of the earliest water breakthrough and the longest production time while option 4 yields the lowest water production due to latest breakthrough time and shortest production time after breakthrough. This behavior is the same as the one seen in the case of maximum liquid production rate of 1000 STB/D.

In term of total water injection, well option 1 gives the highest value because of the earliest water breakthrough and the longest production time. Well option 4 needs the lowest amount of injected water for opposite reasons.

Production time of well option 1 is the longest due to the slowest increment of water cut even though the breakthrough time is the earliest as shown in Figure 5-8. The production time of well option 4 is the shortest due to opposite reasons. These results are in accordance with the results obtained for the case with maximum liquid production rate of 1000 STB/D.

## 5.2 Water dumpflood from 10PV and 50PV aquifer

### 5.2.1 Effect of well type for water dumpflood from 10PV aquifer

#### a) Maximum liquid production rate of 1000 STB/D

Overlaying aquifer of 10PV size located 1800 ft above the oil reservoir is used as a source of dumping water. All four well options consist of one production well and two dumping wells. Dumping schedules of all cases are commenced at the beginning of production and cease when the aquifer pressure falls below 300 psia (abandonment aquifer pressure). Figure 5-9 illustrates the cumulative oil production and Table 5-3 summarize the results of four well options with the maximum liquid production rate of 1000 STB/D.

Table 5-3 Results of four well options with maximum liquid production rate of 1000 STB/D in dumpflood from 10PV aquifer

Well type	Total oil production (MMSTB)	Total water production (MSTB)	Total water dumped (MMSTB)	Oil recovery factor (%)	Production time (years)
Option 1	1.766	4.716	1.261	27.71	10.25
Option 2	1.841	1.231	1.279	28.89	11.25
Option 3	1.849	5.407	1.259	29.03	10.17
Option 4	1.961	2.483	1.277	30.78	9.42

As illustrated in Figure 5-10, the oil production rate of well options 1 and 2 is 1000 STB/D at the beginning and lasts for only two and a half years due to poor productivity of vertical producer. Then, the oil rate drops steadily to oil production constraint of 50 STB/D as the reservoir pressure is not enough to maintain the flow rate. Water cross-flow from the aquifer in well option 1 with vertical dumping wells is (1.261 MMSTB) a little less compared to that in well option 2 (1.279 MMSTB) with horizontal dumping wells. The oil reservoir pressure of well option 1 also falls slightly below that of well option 2 as shown in Figure 5-11. Total oil production of well option

2 is 0.075 MMSTB over well option 1. In the cases of well options 3 and 4 with horizontal producers, the production well can sustain the oil plateau rate for a longer time due to high productivity of horizontal producer but the rate drops sharply as the reservoir pressure declines faster. From Figure 5-12, water cross-flow rate from the aquifer increases temporarily when the reservoir pressure starts to decline steeply. As a result, the reservoir pressure drops at a slower rate. This temporary increase in water cross-flow rate helps increase the oil production rate back again before declining and reaching the end of production. In summary, maximum liquid production rate of 1000 STB/D in dumpflood from 10PV aquifer has no significant difference in oil recovery (1 to 3%) when operated with different well options.

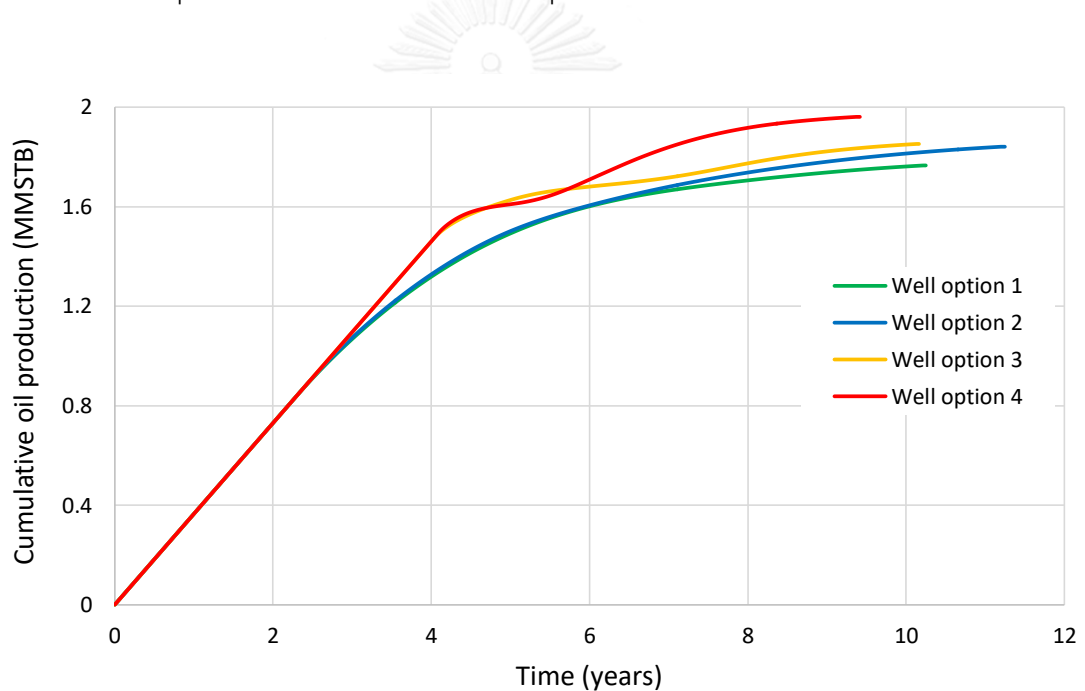

Figure 5-9 Cumulative oil productions of four well options with maximum liquid production rate of 1000 STB/D in water dumpflood from 10PV aquifer

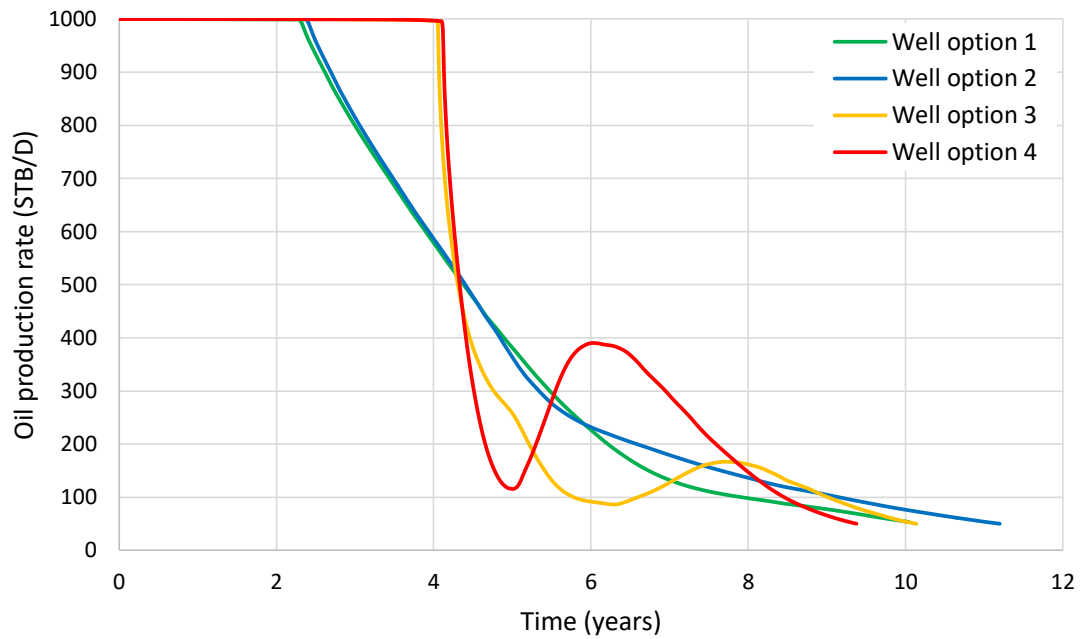

Figure 5-10 Oil production rates of four well options with maximum liquid production rate of 1000 STB/D in water dumpflood from 10PV aquifer

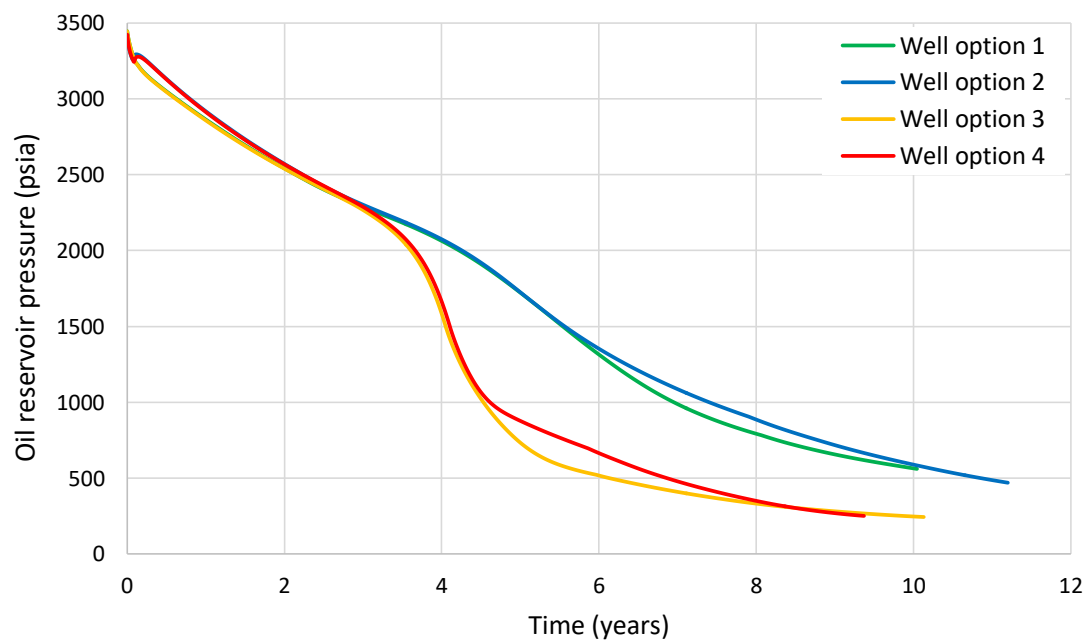

Figure 5-11 Oil reservoir pressures of four well options with maximum liquid production rate of 1000 STB/D in water dumpflood from 10PV aquifer

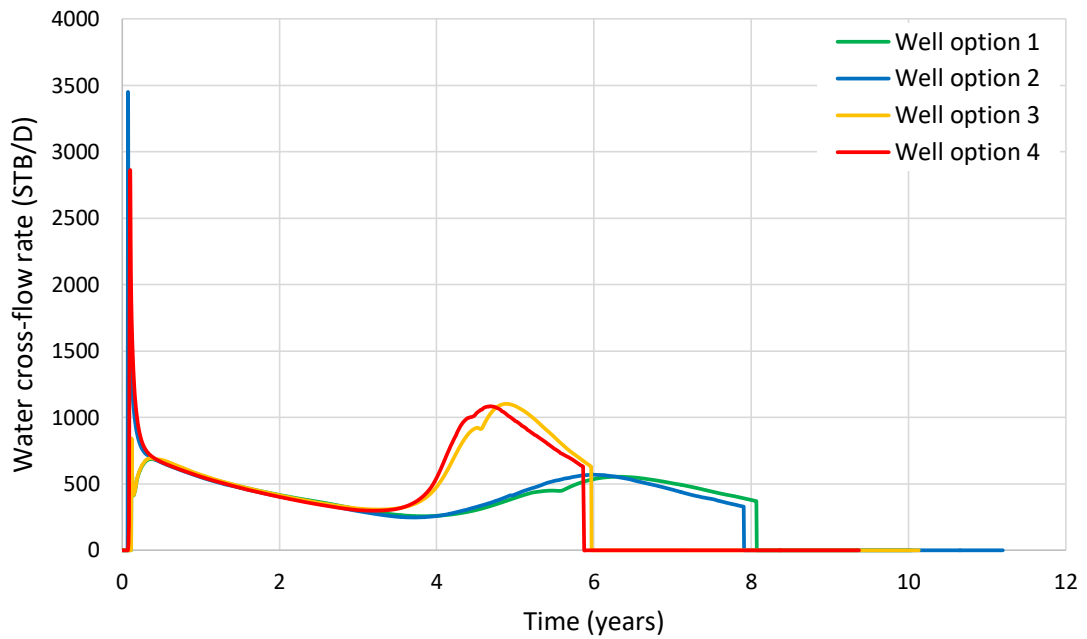

Figure 5-12 Water cross-flow rates of four well options with maximum liquid production rate of 1000 STB/D in water dumpflood from 10PV aquifer

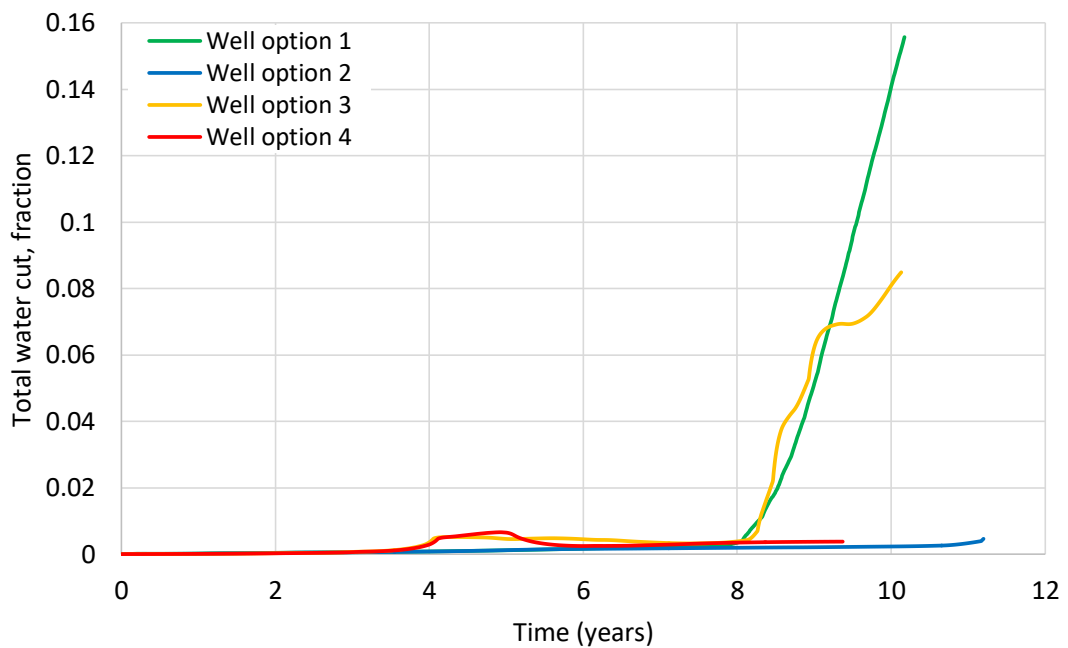

Figure 5-13 Total water cuts of four well options with maximum liquid production rate of 1000 STB/D in water dumpflood from 10PV aquifer

Total water production of four well options are relatively small because the production mainly comes from the reservoir pressure itself and small amount of water cross-flow from the 10PV aquifer. Well options 1 and 3 have slightly higher produced water due to water breakthrough from the vertical dumping wells. As shown in Figure 5-13, water breakthrough of well options 1 and 3 of which dumping wells are vertical wells increases slightly at the end of production from the shortest streamline between producer and dumpers. Total water dumping and production time of the four well options are also approximately the same.

*b) Maximum liquid production rate of 2000 STB/D*

Table 5-3 summarizes the results of four well options with the maximum liquid production rate of 2000 STB/D. As illustrated in Figure 5-14, oil production rates of four well options with 2000 STB/D maximum liquid production rate have similar trend to those of 1000 STB/D with shorter plateau periods. The oil production rate of well options 1 and 2 is 2000 STB/D at the beginning and lasts for only three to four months due to high rate and poor productivity of vertical producer. Then, the oil rate drops steadily to oil production constraint of 50 STB/D as the reservoir pressure is not enough to maintain the flow rate. Water cross-flow from the aquifer in well option 1 with vertical dumping wells is (1.256 MMSTB) a little less than that in well option 2 (1.276 MMSTB) with horizontal dumping wells. The oil reservoir pressure of well option 1 also falls slightly below that of well option 2 as shown in Figure 5-15. Thus, total oil production of well option 2 is slightly higher than well option 1. In the cases of well options 3 and 4 with horizontal producers, the production well can sustain the oil plateau rate for a longer time due to high productivity of horizontal producer but the rate drops sharply as the reservoir pressure declines faster. Water cross-flow rate from the aquifer increases temporarily when the reservoir pressure starts to decline steeply. As a result, the reservoir pressure drops at a slower rate. This temporary increase in water cross-flow rate helps increase the oil production rate back again before declining and reaching the end of production.

Table 5-4 Results of four well options with maximum liquid production rate of 2000 STB/D in dumpflood from 10PV aquifer

Well type	Total oil production (MMSTB)	Total water production (MSTB)	Total water dumped (MMSTB)	Oil recovery factor (%)	Production time (years)
Option 1	1.767	4.258	1.256	27.73	9.67
Option 2	1.841	1.254	1.276	28.89	10.49
Option 3	1.859	6.689	1.256	29.19	8.17
Option 4	1.958	3.099	1.275	30.74	7.50

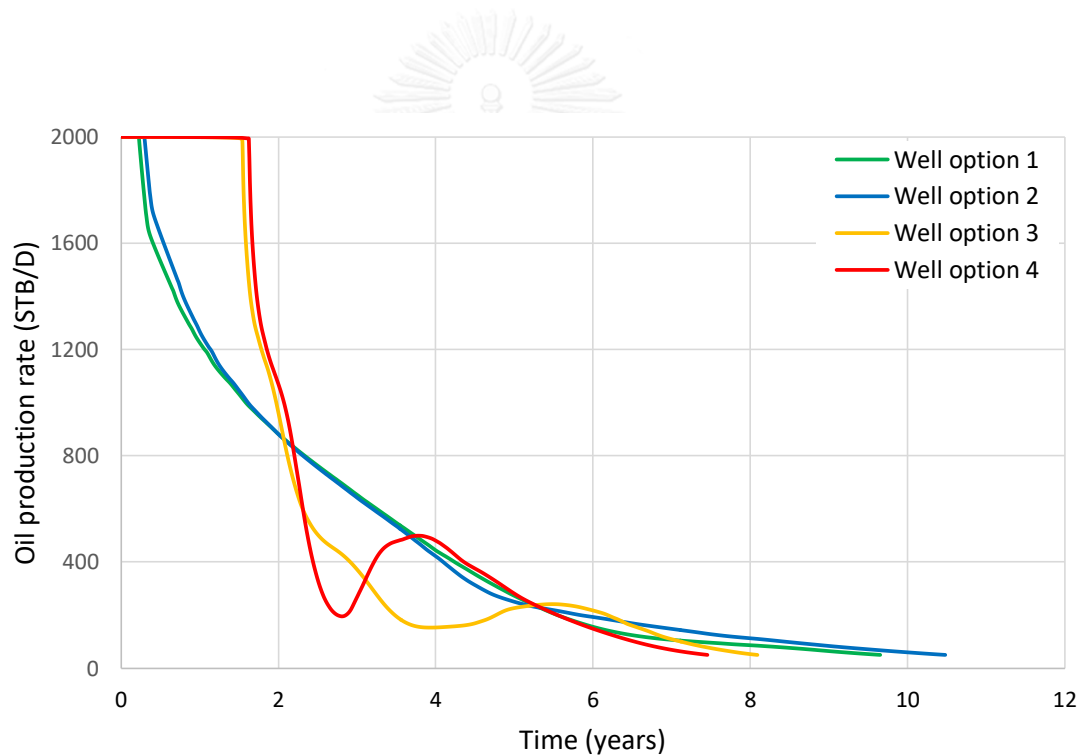

Figure 5-14 Oil production rates of four well options with maximum liquid production rate of 2000 STB/D in water dumpflood from 10PV aquifer

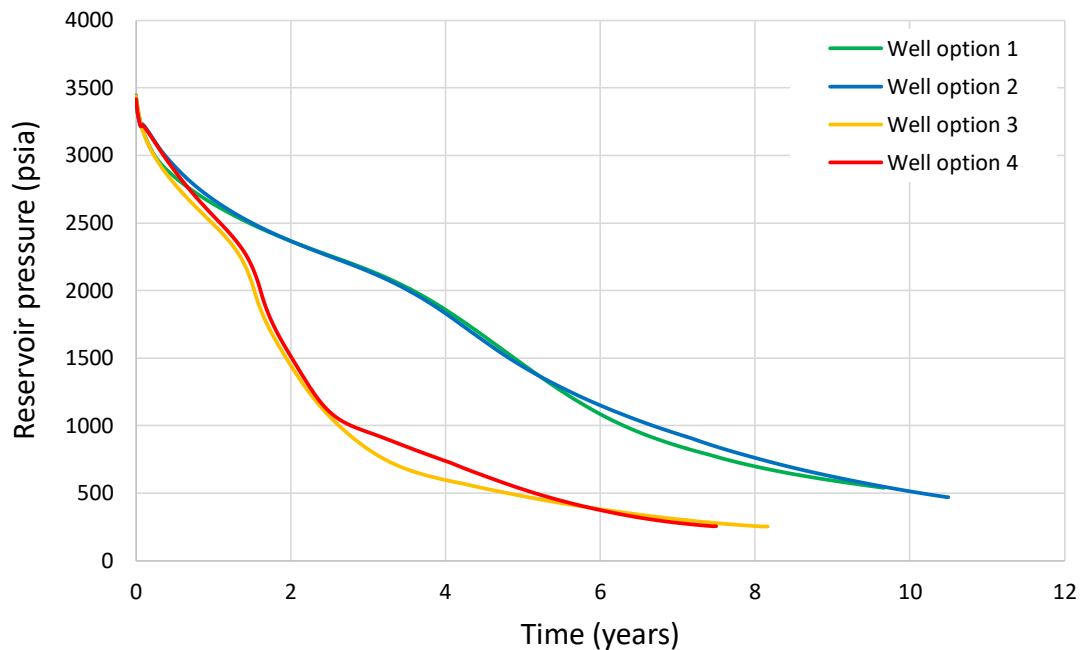

Figure 5-15 Reservoir pressures of four well options with maximum liquid production rate of 2000 STB/D in water dumpflood from 10PV aquifer

From Figure 5-16, well options 1 and 3 of which dumping wells are vertical wells, water cut increases slightly at the end of production from the shortest streamline between producer and dumpers. Thus, the two well options have little more produced water than the other two well options with horizontal dumpers but the difference is insignificant. Total water dumped of four well options are also approximately the same values. The production times of well options 3 and 4 are shorter than those of well options 1 and 2 because of high productivity of horizontal producers from the beginning, leading to early production constraint.

In summary, there is no difference in oil recovery when the liquid production rate is increased from 1000 STB/D to 2000 STB/D. However, total water production and production time slightly differ.



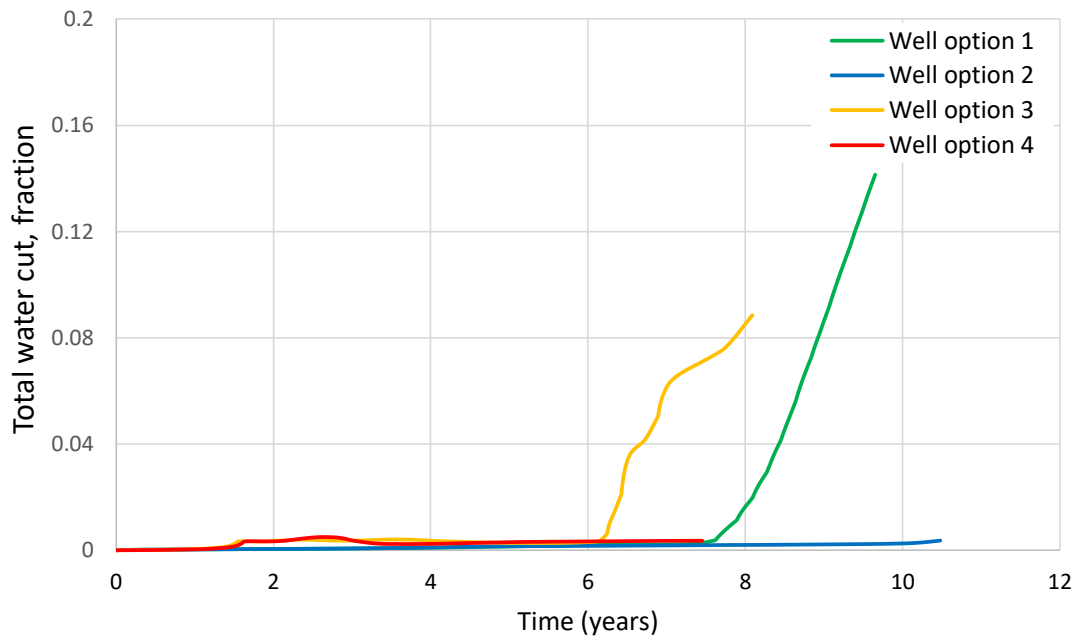

Figure 5-16 Total water cuts of four well options with maximum liquid production rate of 2000 STB/D in water dumpflood from 10PV aquifer

## 5.2.2 Effect of well type for water dumpflood from 50PV aquifer

### a) Maximum liquid production rate of 1000 STB/D

In case of strong aquifer (50PV), oil recovery factors of all well options have better results compared to 10PV aquifer because of high water cross-flow rates from the aquifer as illustrated in Figure 5-17. Starting with maximum liquid production rate of 1000 STB/D, well option 1 provides oil recovery factor of 42.56% while options 2, 3, and 4 yield oil recovery factors of 42.38%, 42.05%, and 41.89%, respectively, as shown in Table 5-5 and Figure 5-18.

As illustrated in Figure 5-19, the oil production rate of four well options is initially 1000 STB/D. When compared among the four options, well option 1 yields the highest oil production, similar to the results in conventional water flooding. Water breakthroughs of well options 2, 3 and 4 occur successively after well option 1 as depicted in Figure 5-20. The oil production rate of each case also falls from the plateau rate in the same order. For well options 1 and 2, the oil rate drops before water breakthrough as a result of poor productivity of vertical producer. The oil rate drops in a certain trend for some period then drops with a sharper trend after water

breakthrough. For well options 3 and 4 in which the producer is horizontal well, oil production can be sustained at the plateau rate until water breakthrough as shown in Figure 5-19. However, when the water breaks through the producer, the oil production rate falls dramatically because of lengthy horizontal producer where injected water can easily enter. Thus, the production constraint of water cut is attained quickly.

Table 5-5 Results of four well options with maximum liquid production rate of 1000 STB/D in dumpflood from 50PV aquifer

Well type	Total oil production (MMSTB)	Total water production (MMSTB)	Total water dumping (MMSTB)	Oil recovery factor (%)	Production time (years)
Option 1	2.712	1.447	3.808	42.56	16.51
Option 2	2.700	1.049	3.489	42.38	13.09
Option 3	2.679	0.913	3.233	42.05	9.84
Option 4	2.669	0.820	3.251	41.89	9.59

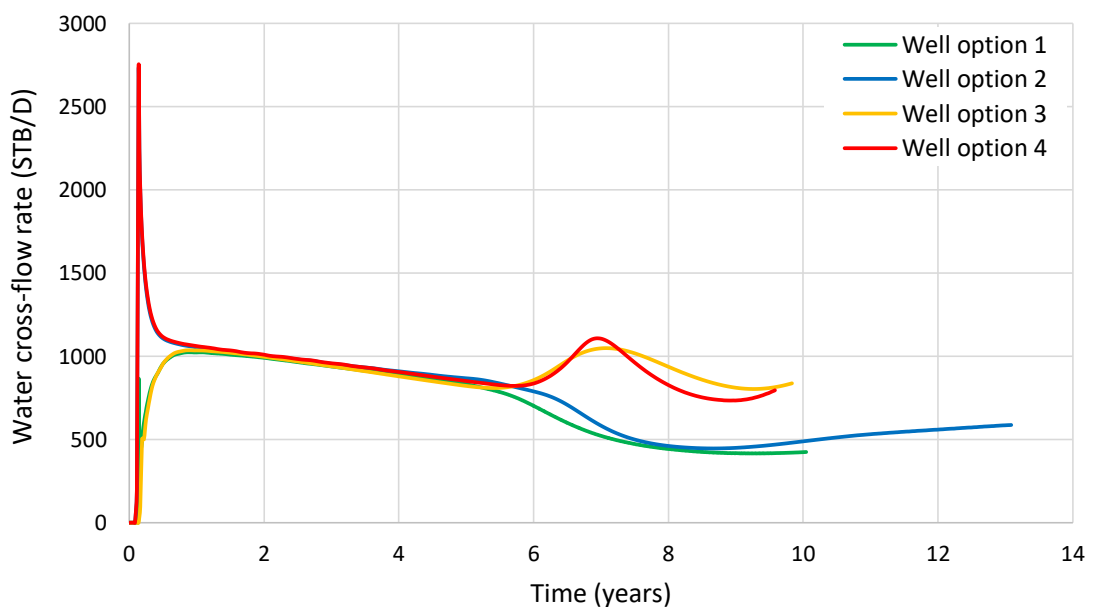

Figure 5-17 Water cross-flow rates of four well options with maximum liquid production rate of 1000 STB/D in water dumpflood from 50PV aquifer

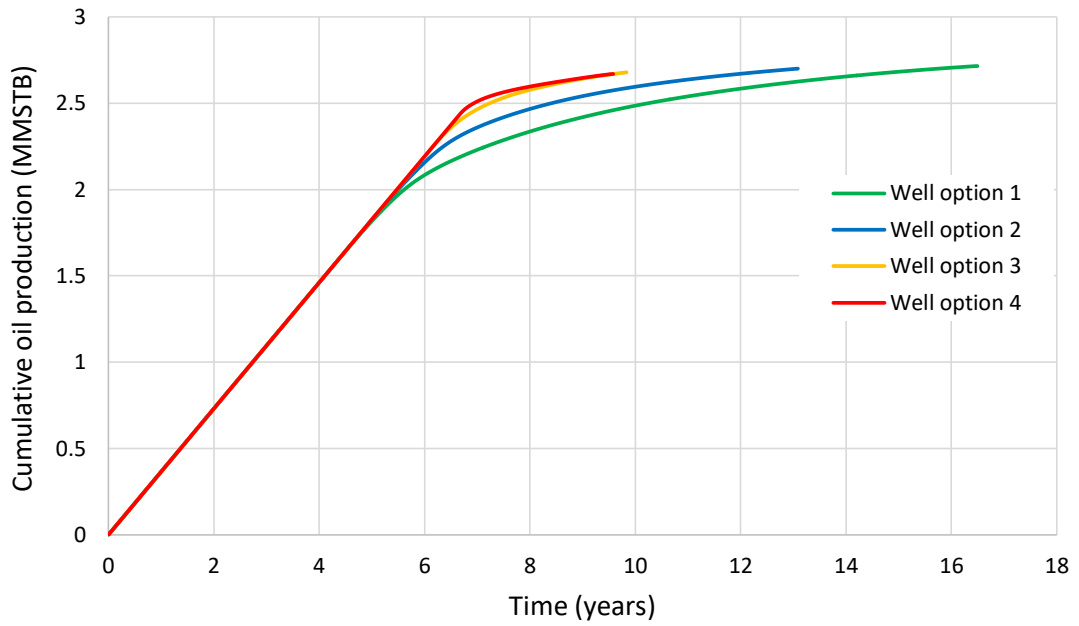

Figure 5-18 Cumulative oil productions of four well options with maximum liquid production rate of 1000 STB/D in water dumpflood from 50PV aquifer

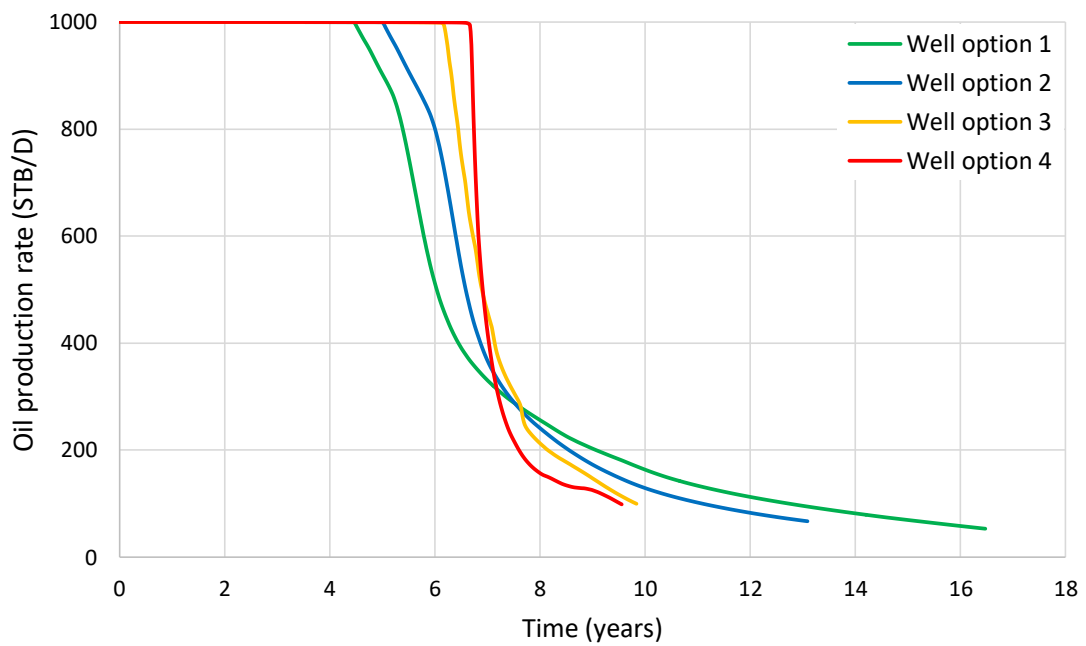

Figure 5-19 Oil production rates of four well options with maximum liquid production rate of 1000 STB/D in water dumpflood from 50PV aquifer

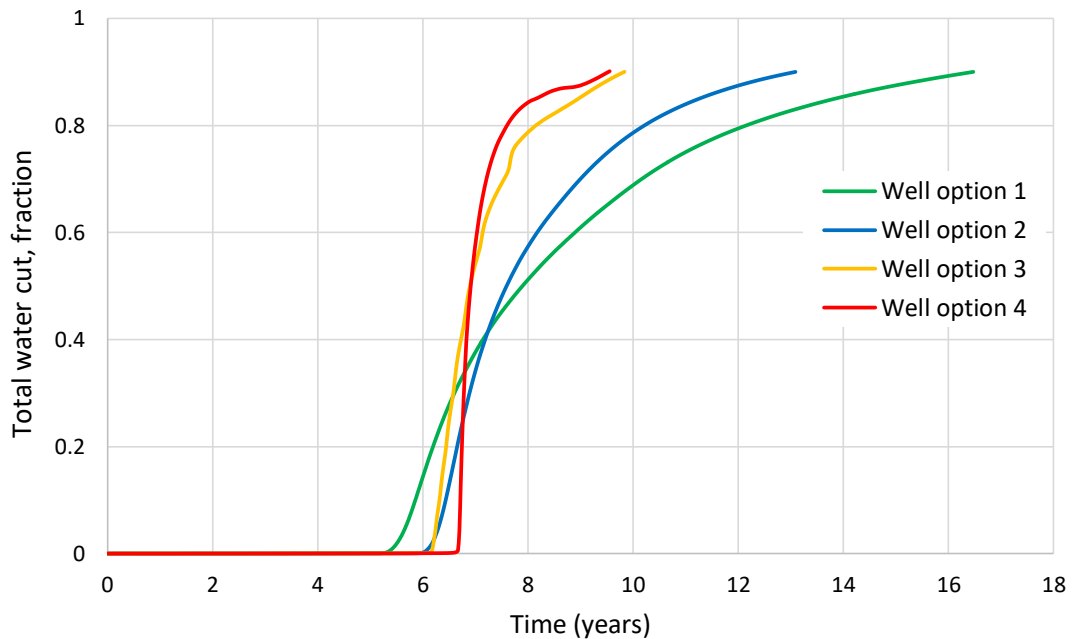

Figure 5-20 Total water cuts of four well options with maximum liquid production rate of 1000 STB/D in water dumpflood from 50PV aquifer

From Table 5-5, well option 1 gives the highest total water production because of early water breakthrough from the rapid movement of the shortest path between vertical dumpers and vertical producer and long production life as water from different streamlines reaches the producer at different times, resulting in gradual increase in water cut. For well option 2 of which two dumpers are horizontal wells, the dumped water moves across the width of the reservoir but slower compared to vertical dumpers with the same vertical producer. When water breaks through, water cut increases faster and reaches maximum value of 90% cut-off faster, leading to shorter production life compared to well option 1. Thus, the total water production is smaller than that of well option 1. Total water production of well option 3 is also less compared to options 1 and 2 due to the fact that the dumped water tends to move downward and reaches the horizontal producer located at the mid height of the reservoir at a later time. As the water breaks through, water cut jumps very sharply. Then, the production stops early. For well option 4 of which both producer and dumpers are horizontal wells, the flood front moves slowly and takes some times to enter the producer at the mid height of the reservoir. When water breaks through the

producer, water cut increases very sharply, leading to earliest abandonment. As a result, well option 4 has the smallest total water production and the shortest oil production life.

Total water dumped of well option 1 is the highest because of earliest water breakthrough and longest well production life as a result of gradual increase in water cut at the producer. For well option 2, the required water dumped is smaller due to the benefit from horizontal dumpers that provides good sweep efficiency and a bit longer time for water to break through. Total water dumped of well option 3 is the smallest because of good productivity of horizontal producer, late time of water breakthrough, and shorter time of production life. Well option 4 gets a little high amount of water dumped compared to well option 3 due to sharp increase of dumping rate at the beginning of production from horizontal dumpers.

*b) Maximum liquid production rate of 2000 STB/D*

When maximum liquid production rate of 2000 STB/D is utilized, simulation results as summarized in Table 5-6 illustrate the same trend with the cases of 1000 STB/D. The total oil productions from well options 1 and 2 for maximum liquid production rates of 1000 and 2000 STB/D are approximately the same (see Table 5-5 for comparison), respectively, which means there is no notable effect of maximum liquid production rate on well options 1 and 2. On the other hand, well options 3 and 4 in the case of 2000 STB/D have slightly less oil recovery factor than those of 1000 STB/D because of early water breakthrough and tremendous water cut.

Water production of well options 1 and 2 have no significant difference when maximum liquid production rate increases from 1000 to 2000 STB/D. Well options 3 and 4 for maximum liquid production rate of 2000 STB/D, on the other hand, have much higher amounts of water production compared to those of 1000 STB/D because water breaks through the producer quite early and water production rate is high.

Both 1000 and 2000 STB/D maximum liquid production rate in well options 1 and 2 have approximately the same amounts of water dumped. Well options 3 and 4 for maximum liquid production rate of 2000 STB/D have much greater amount of dumped water because of better productivity of horizontal producer and high

drawdown, leading to fast decline of reservoir pressure. Thus, water flows in great amounts from aquifer, especially for well option 4 of which dumping wells are horizontal wells.

Table 5-6 Results of four well options with maximum liquid production rate of 2000 STB/D in dumpflood from 50PV aquifer

Well type	Total oil production (MMSTB)	Total water production (MMSTB)	Total water dumped (MMSTB)	Oil recovery factor (%)	Production time (years)
Option 1	2.712	1.401	3.765	42.57	15.34
Option 2	2.688	1.069	3.489	42.19	11.84
Option 3	2.547	1.122	3.315	39.98	6.01
Option 4	2.544	1.325	3.579	39.94	5.67

### 5.3 Combined water dumpflood from 10PV aquifer with water injection

In this section, 10PV aquifer size is used for water dumping combined with water injection. Maximum liquid production rate of production well is set at 1000 and 2000 STB/D. Water dumping and injection schedules are separated into three main schedules as mentioned in Chapter 4. For schedules 1 and 3, converting from dumping well(s) to injection well(s) is based on the abandonment aquifer pressure which is 1820, 1060, and 300 psia as three different cases. For dumping wells, water is allowed to flow freely without controlling the rate. When these wells are converted to injection wells, the total injection rate from both injectors is set equal to maximum liquid production rate. In case of simultaneous one dumping well and one injection well, the water injection rate is set to be equal to 50% of maximum liquid production rate. Total oil production and total water injection are observed and compared between cases to find out the appropriate well combination that can deliver comparable or more oil production and minimize the injection water.

### 5.3.1 Effect of water dumping and injection schedule for well option 1

#### a) Maximum liquid production rate of 1000 STB/D

As summarized in Table 5-7, oil recovery factors of schedules 1 and 3 are higher when dumping well(s) are converted to injection well(s) at high abandonment aquifer pressure of 1820 psia. Note that the aquifer pressure in schedule 3 never reaches 300 psia since the well which is designed as an injector at the beginning slows down the decline in reservoir pressure. In the case of schedule 1 in which two dumping wells are later converted to injectors, total oil production gains from this abandonment aquifer pressure is 0.463 MMSTB, 0.713 MMSTB compared to the ones obtained in 1060, and 300 psia abandonment aquifer pressure, respectively, as shown in Figure 5-21. Moreover, total water production in the case of early water injection (abandonment aquifer pressure of 1820 psia) is smaller than the case with late injection (abandonment aquifer pressure of 1060 psia) as shown in Figure 5-22.

Table 5-7 Results of different water dumping and injection schedules for well option 1 in 10PV aquifer size with maximum liquid production rate of 1000 STB/D

Dumping injection schedule	Abandonment aquifer pressure (psia)	Total oil production (MMSTB)	Total water production (MMSTB)	Total water injection (MMSTB)	Total water dumped (MMSTB)	Recovery factor (%)	Production time (years)
1	1820	2.922	2.367	5.135	0.441	45.86	16.51
	1060	2.459	2.894	5.345	0.852	38.59	20.43
	300	2.209	2.318	4.572	1.261	34.67	20.58
2	-	2.595	1.699	3.105	0.867	40.73	17.01
3	1820	2.953	2.427	5.271	0.433	46.35	16.43
	1060	2.775	3.032	5.152	0.840	43.55	22.26
	300	N/A	N/A	N/A	N/A	N/A	N/A

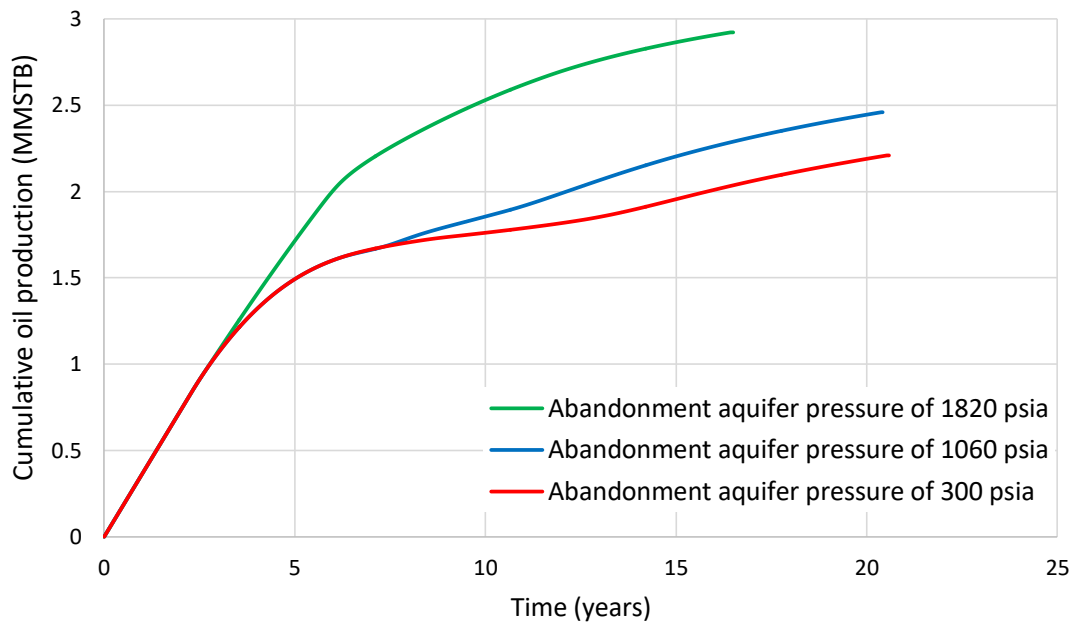

Figure 5-21 Cumulative oil productions of schedule 1 of combined method from 10PV aquifer for well option 1 with maximum liquid production rate of 1000 STB/D

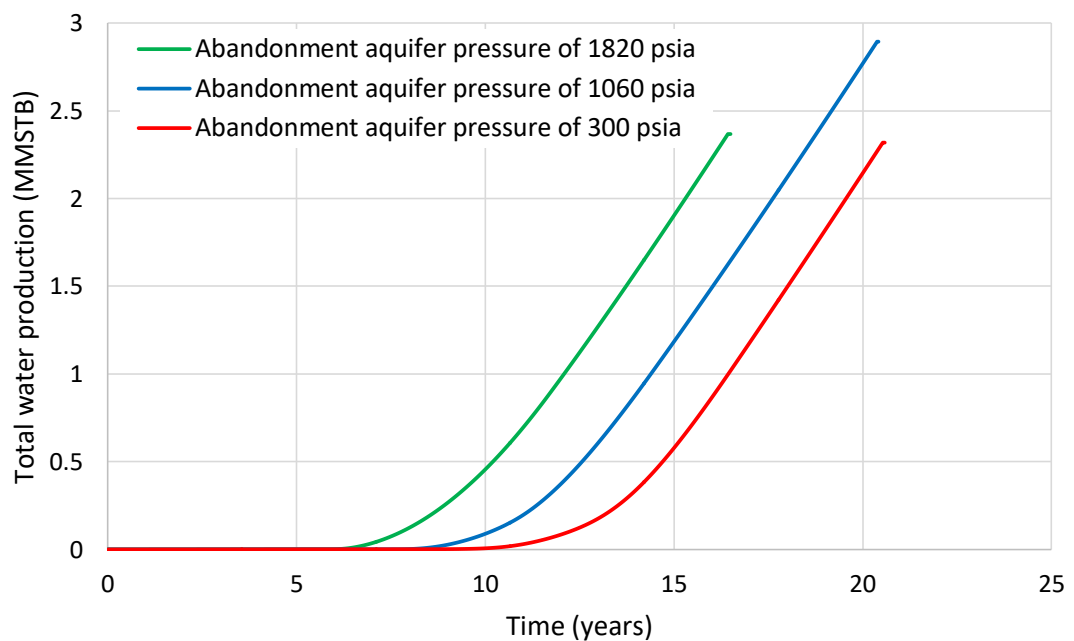

Figure 5-22 Total water productions of schedule 1 of combined method from 10PV aquifer for well option 1 with maximum liquid production rate of 1000 STB/D



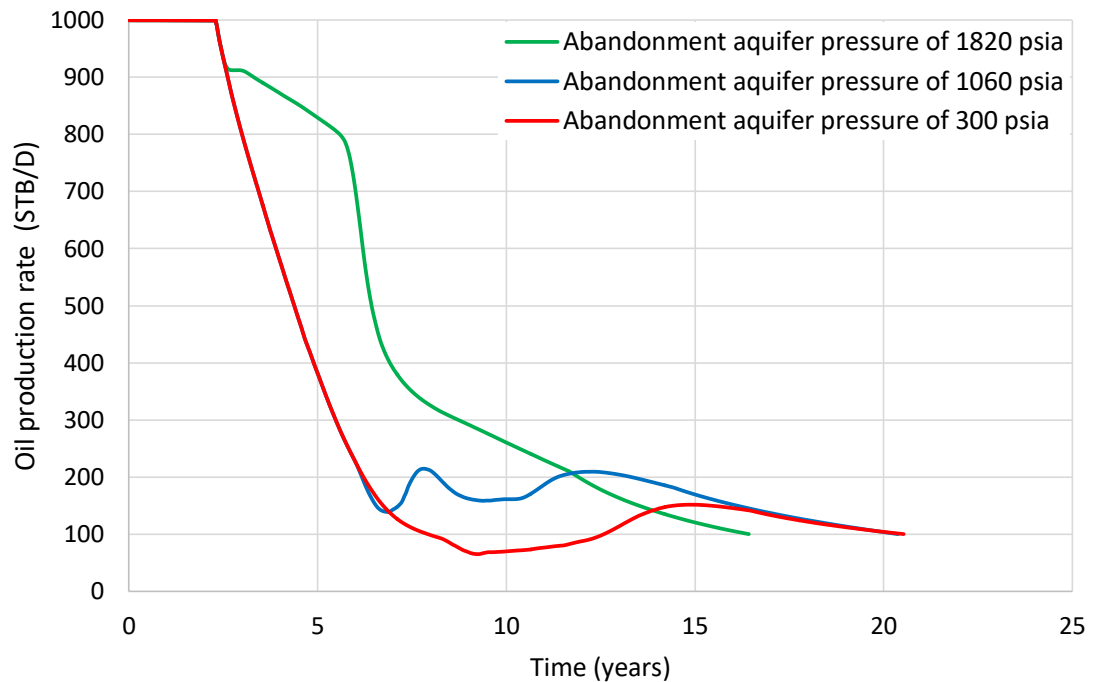

Figure 5-23 Oil production rates of schedule 1 of combined method from 10PV aquifer for well option 1 with maximum liquid production rate of 1000 STB/D

Figure 5-23 shows that oil production rates of three cases in schedule 1 fall after 2.3 years of production and follow the same trend for another 0.3 years. For the case that the dumping wells are converted to injectors at aquifer pressure of 1820 psia (early injection), the oil production rate has a slower decline than the other cases with later water injection because of higher amount of water entering the reservoir, providing better pressure support. Oil production rate in this case (early injection) later falls sharply due to water breakthrough at the end of 5.7 years of production. Then, flood front sweeps oil from the edges of the reservoir into the production well, resulting in a slower decline of oil production rate. From Figure 5-24, oil saturation in the upper part of reservoir in the case of early water injection (1820 psia abandonment aquifer pressure) is lower than that of later water injection (300, and 1060 psia abandonment aquifer pressure). Since the dumped water from 10PV aquifer is not enough to sweep the oil effectively, the case with early water injection results in lower oil saturation at the end. As a result, recovery factors at late water injection are lower. Total water injection for abandonment aquifer pressure of 300 psia in schedule 1 is

relatively low as water injection is started at late time of production as shown in Figure 5-25. However, recovery factor is also much lower than early water injection.

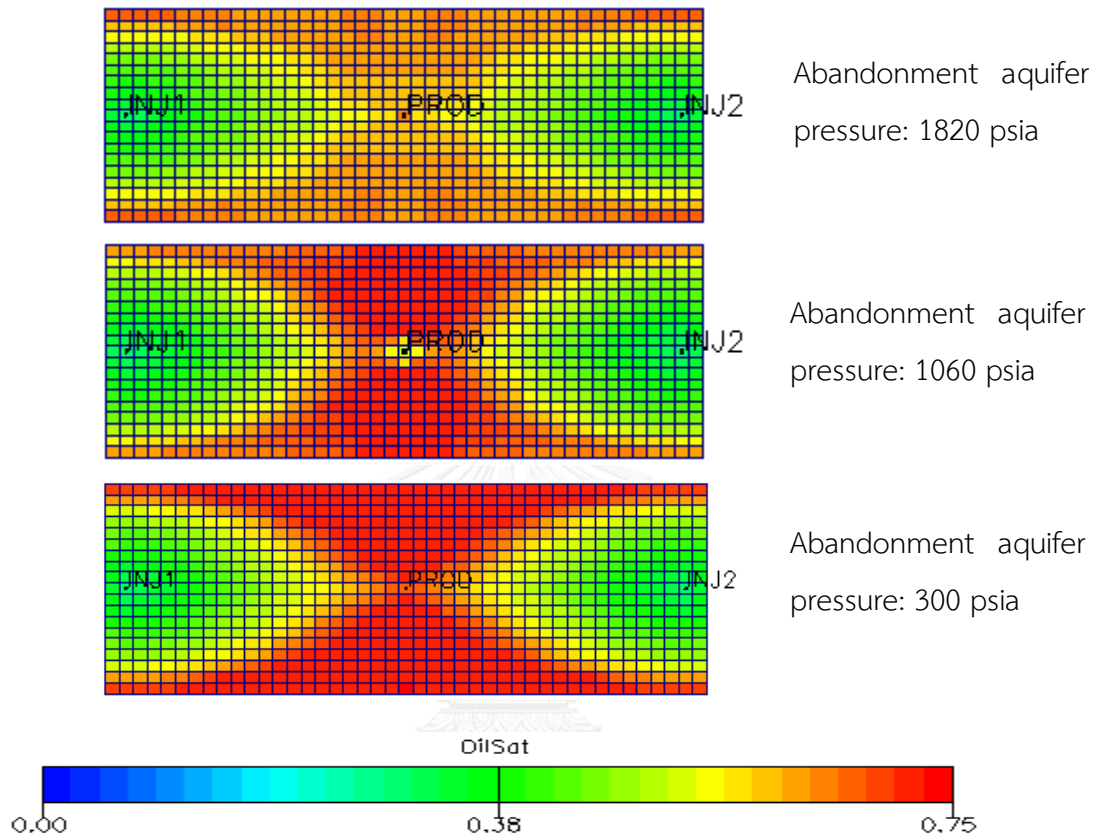

Figure 5-24 Top view of oil saturation profiles of schedule 1 of combined method from 10PV aquifer for well option 1 with maximum liquid production rate of 1000 STB/D at the end of production

Production time for the case that the dumping wells are converted to injectors at early time (1820 psia abandonment aquifer pressure) is shorter than the other cases with later injection because of early water breakthrough from high water injection rate compared to that of dumped water as shown in Figure 5-26. At the lowest abandonment aquifer pressure of 300 psia, water breaks through the producer at the latest time, leading to the longest production life.

When comparing between the three different schedules, total water injection of schedule 2 is much smaller and its oil recovery factor is also 5 to 6% lower

compared to cases with the highest recovery factor from schedules 1 and 3. In Figure 5-27, oil production rate of schedule 2 is 1000 STB/D until 3.6 years of production because of sufficient pressure support contributed from one all-time injection well since the beginning of production as shown in Figure 5-28. This oil rate starts to drop sharply as the reservoir pressure declines and falls to another drift when water breakthrough occurs. Moreover, this oil rate trend is lower than that of other schedules which means that one all-time dumping and injection well from small aquifer size cannot provide sufficient long-term pressure support to the reservoir. One all-time dumping well in this case delivers small amount of water cross flow.

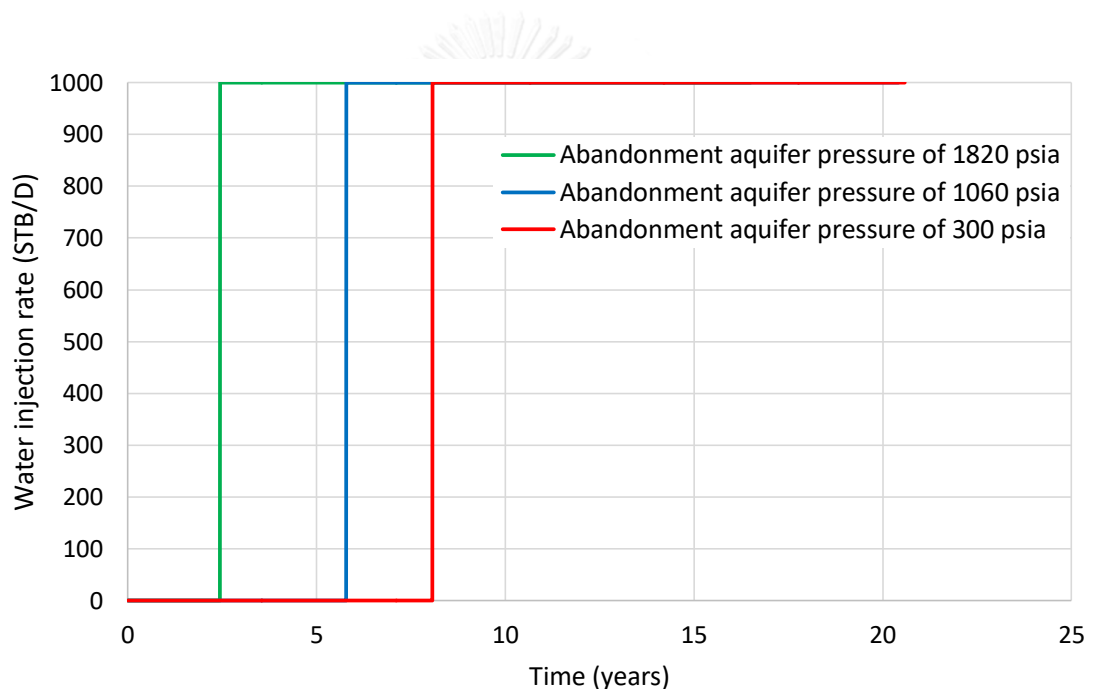

Figure 5-25 Water injection rates of schedule 1 of combined method from 10PV aquifer for well option 1 with maximum liquid production rate of 1000 STB/D

In summary, schedules 1 and 3 with early conversion of dumping well(s) to injector(s) provide very high recovery factors for well option 1. Schedule 1 is recommended if injection cannot be started at the beginning while schedule 3 is appropriate for the case that water can be injected since the beginning.

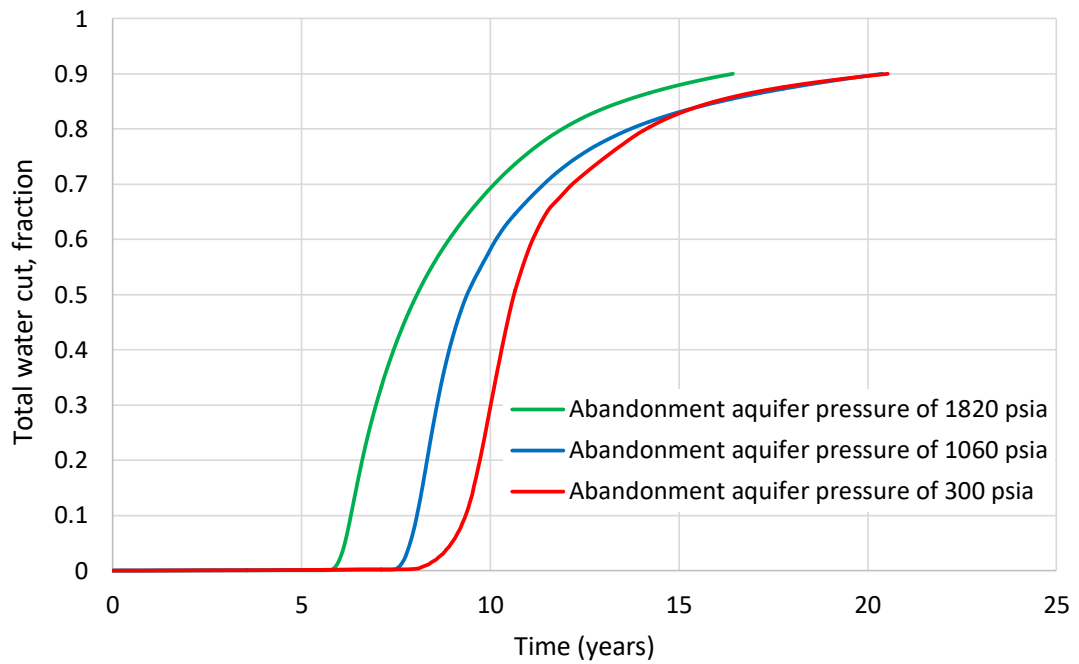

Figure 5-26 Total water cuts of schedule 1 of combined method from 10PV aquifer for well option 1 with maximum liquid production rate of 1000 STB/D

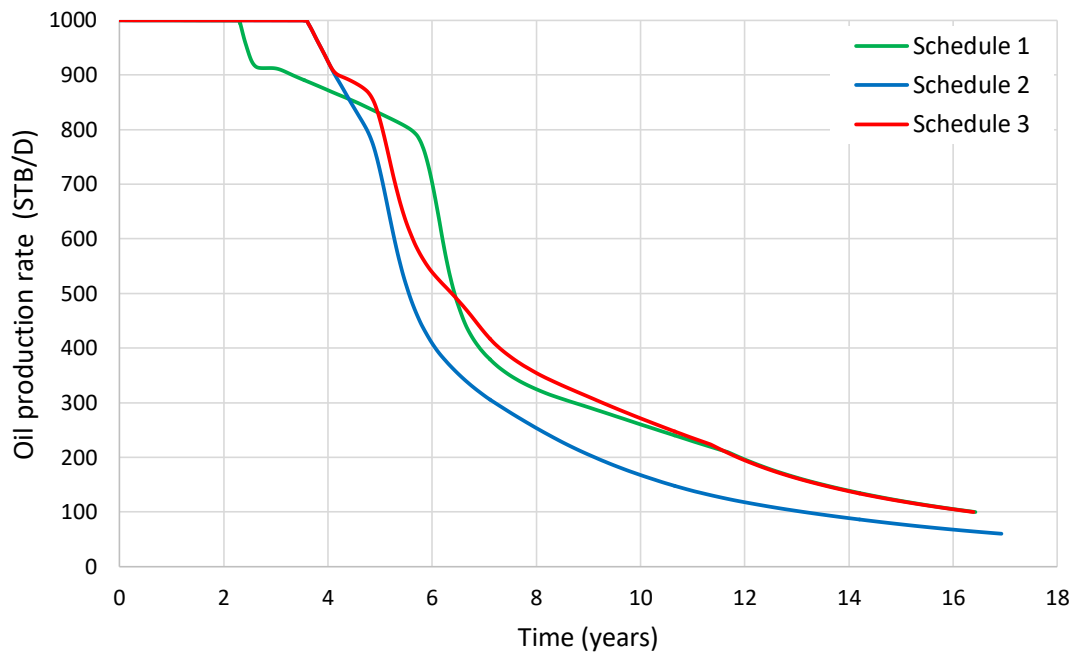

Figure 5-27 Oil production rates of schedules 1, 2 and 3 of combined method from 10PV aquifer for well option 1 with maximum liquid production rate of 1000 STB/D

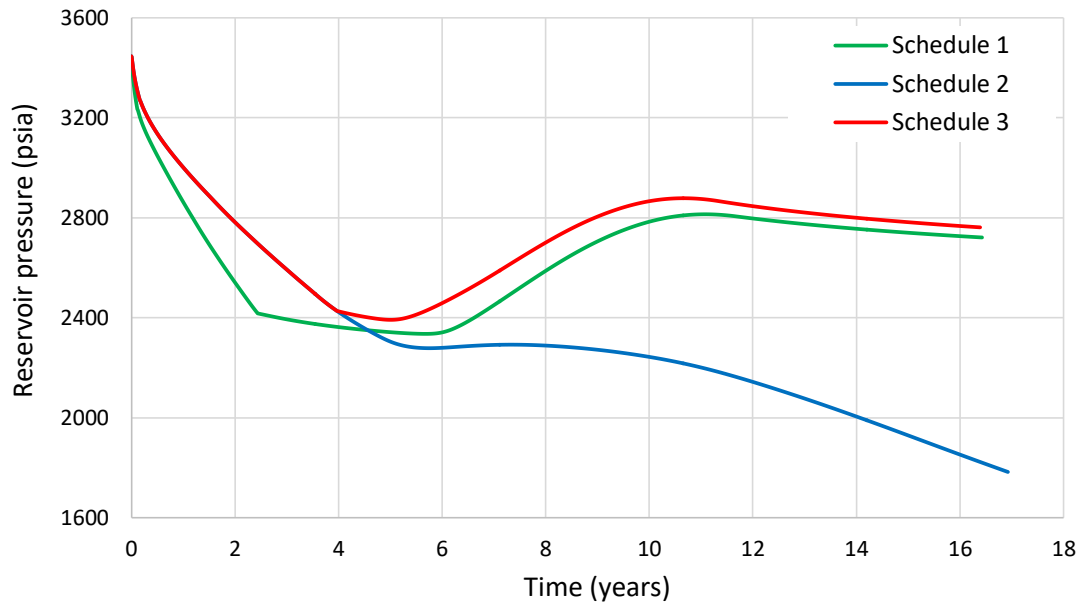

Figure 5-28 Reservoir pressures of schedules 1, 2 and 3 of combined method from 10PV aquifer for well option 1 with maximum liquid production rate of 1000 STB/D

*b) Maximum liquid production rate of 2000 STB/D*

According to Table 5-8, oil recovery factors of schedules 1 (48.47%) and 3 (48.15%) are still the highest for the case of 1820 psia abandonment aquifer pressure (early water injection). The oil recovery factors of schedules 1 and 3 are almost 10% larger than that of schedule 2. Schedule 1 provides slightly higher oil recovery with negligible difference and slightly less amount of water injection than schedule 3. Overall, the trend in the results for maximum liquid production rate of 2000 STB/D is similar to the one for maximum liquid production rate of 1000 STB/D. Either schedules 1 or 3 with early water injection (abandonment aquifer pressure of 1820 psia) can be implemented depending on the availability of the injection facility.

Table 5-8 Results of different water dumping and injection schedules for well option 1 in 10PV aquifer size with maximum liquid production rate of 2000 STB/D

Dumping injection schedule	Abandonment aquifer pressure (psia)	Total oil production (MMSTB)	Total water production (MMSTB)	Total water injection (MMSTB)	Total water dumped (MMSTB)	Recovery factor (%)	Production time (years)
1	1820	3.088	2.224	5.698	0.435	48.47	9.67
	1060	2.495	2.996	5.761	0.845	39.17	13.01
	300	2.083	1.706	4.089	1.256	32.69	13.00
2	-	2.479	2.969	5.083	0.484	38.92	13.92
3	1820	3.067	2.452	5.923	0.428	48.15	9.92
	1060	N/A	N/A	N/A	N/A	N/A	N/A
	300	N/A	N/A	N/A	N/A	N/A	N/A

*c) Comparison between cases with maximum liquid production rate of 1000 and 2000 STB/D*

Figure 5-29 depicts the total oil production and water injection of cases with high oil recovery from maximum liquid production rate of 1000 and 2000 STB/D. For maximum liquid production rate of 1000 STB/D, dumping and injection schedules 1 and 3 provide the highest total oil production of 2.922 and 2.953 MMSTB and require 5.135 and 5.271 MMSTB of total water injection, respectively. In the case of 2000 STB/D, dumping and injection schedules 1 and 3 yield the highest total oil production of 3.088 and 3.067 MMSTB and need 5.698 and 5.923 MMSTB of total water injection, respectively. Both schedules 1 and 3 with maximum liquid production rate of 2000 STB/D give high oil production but require much amounts of water injection compared to the cases with maximum liquid production rate of 1000 STB/D. If there is no major concern with cost of water injection, maximum liquid production rate of 2000 STB/D is recommended.

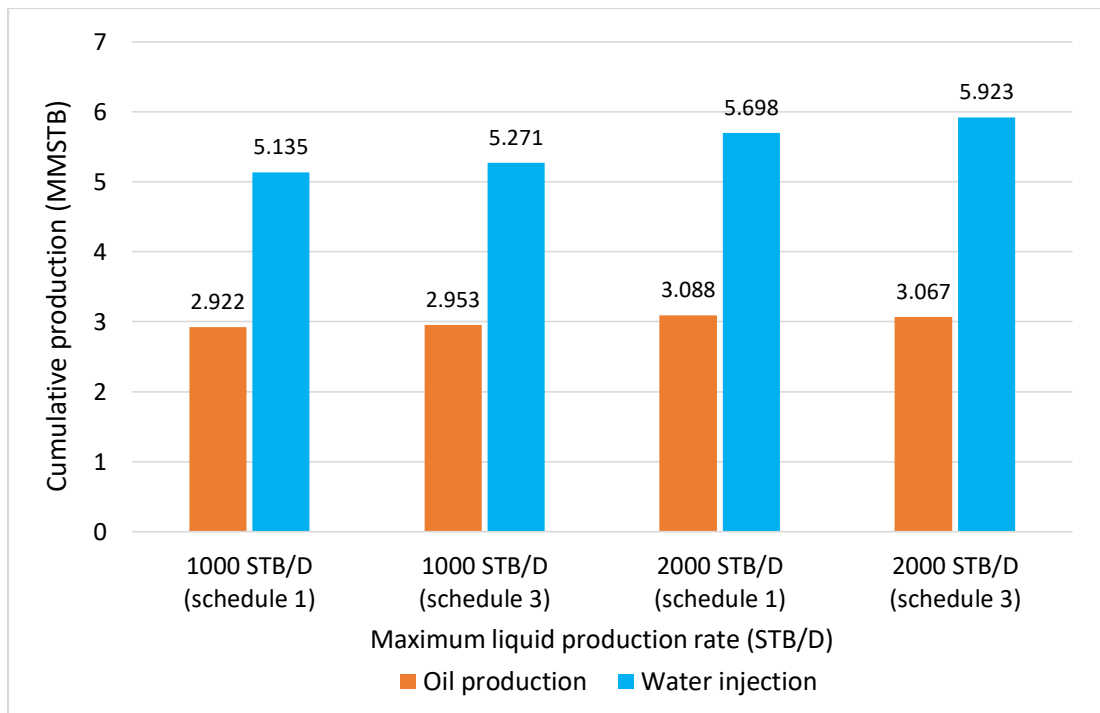

Figure 5-29 Cumulative oil productions and water injections of highest oil recovery cases from maximum liquid production rates of 1000 and 2000 STB/D of combined method from 10PV aquifer for well option 1

### 5.3.2 Effect of water dumping and injection schedule for well option 2

#### a) Maximum liquid production rate of 1000 STB/D

Combination of well option 2 has one vertical production well and two horizontal dumping and/or injection wells. Table 5-9 summarizes the total oil and water production, water injection, water dumped, and recovery factors of three different simulated schedules. Dumping and injection schedules 1 and 3 provide the highest oil recovery factors at high abandonment aquifer pressure of 1820 psia (early injection). The recovery factor decreases as abandonment aquifer pressure is reduced. The lowest abandonment aquifer pressure of 300 psia in schedule 3 is never reached. In the case of schedule 1, starting water injection when the aquifer pressure is 1820 psia yields 0.329 and 0.564 MMSTB higher oil production compared to the ones obtained in 1060 and 300 psia abandonment aquifer pressure, respectively.

Table 5-9 Results of different water dumping and injection schedules for well option 2 in 10PV aquifer size with maximum liquid production rate of 1000 STB/D

Dumping injection schedule	Abandonment aquifer pressure (psia)	Total oil production (MMSTB)	Total water production (MMSTB)	Total water injection (MMSTB)	Total water dumped (MMSTB)	Recovery factor (%)	Production time (years)
1	1820	2.818	1.750	4.334	0.459	44.24	14.09
	1060	2.489	1.992	4.418	0.872	39.06	17.68
	300	2.254	1.475	3.627	1.278	35.38	17.83
2	-	2.641	1.481	2.938	0.884	41.46	16.09
3	1820	2.859	1.796	4.484	0.446	44.87	14.09
	1060	2.769	2.460	4.443	0.855	43.47	19.85
	300	N/A	N/A	N/A	N/A	N/A	N/A

Figure 5-30 and Figure 5-31 illustrates the cumulative oil productions and oil production rates of the three cases in schedule 1, respectively. The oil rate of early water injection case (1820 psia abandonment aquifer pressure) stays at the plateau longer than those of late water injection cases (1060 and 300 psia abandonment aquifer pressure) because dumping wells are converted to injection wells early as aquifer pressure drops to 1820 psia at 2.21 years of production. The oil production rate of the early injection case has slower decline due to higher amount of water injection entering the reservoir at early time, providing better pressure support. Later on, this oil rate drops sharply because of water breakthrough at the end of 6.56 years of production as shown in Figure 5-32. The flood front sweeps oil from the edges into the producer as shown in Figure 5-33, leading to a slower decline of oil production rate until the maximum water cut of 90% is attained. In the case of late water injection (1060 and 300 psia abandonment aquifer pressure), longer time of dumping from small aquifer with long horizontal dumping wells provides poor sweep efficiency due to insufficient amount of water dumped from a small aquifer (10PV). As a result, oil recovery of schedules 1 and 3 at late water injection are lower.



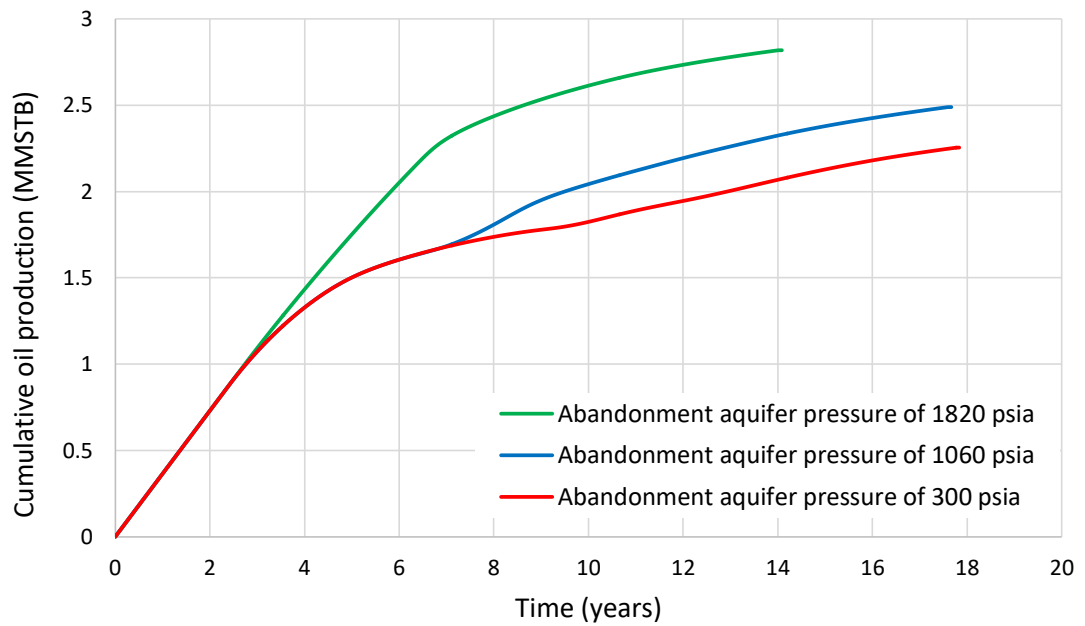

Figure 5-30 Cumulative oil productions of schedule 1 of combined method from 10PV aquifer for well option 2 with maximum liquid production rate of 1000 STB/D

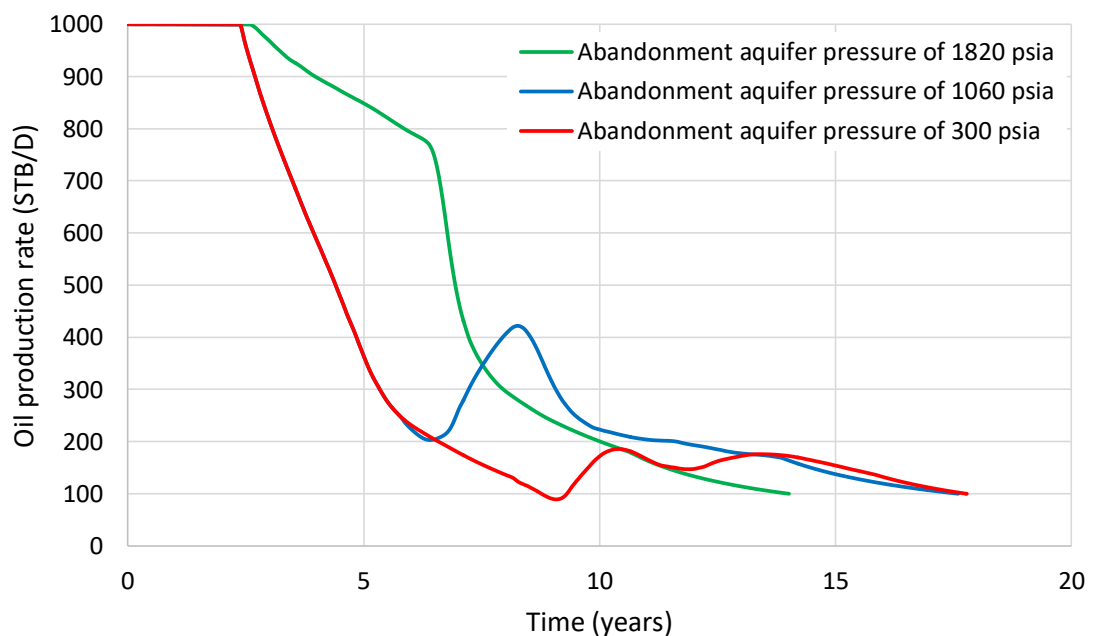

Figure 5-31 Oil production rates of schedule 1 of combined method from 10PV aquifer for well option 2 with maximum liquid production rate of 1000 STB/D

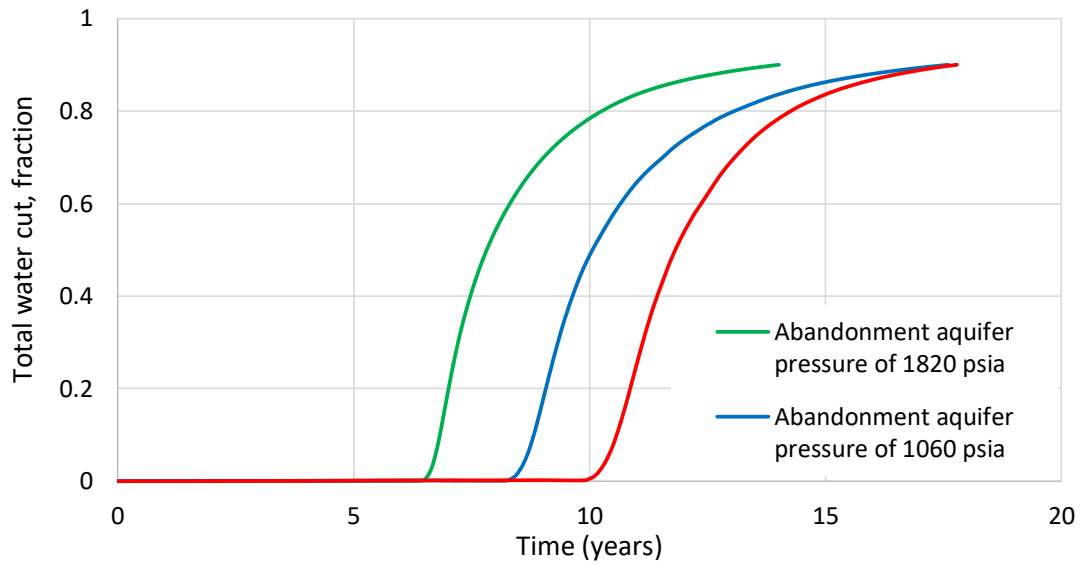

Figure 5-32 Total water cuts of schedule 1 of combined method from 10PV aquifer for well option 2 with maximum liquid production rate of 1000 STB/D

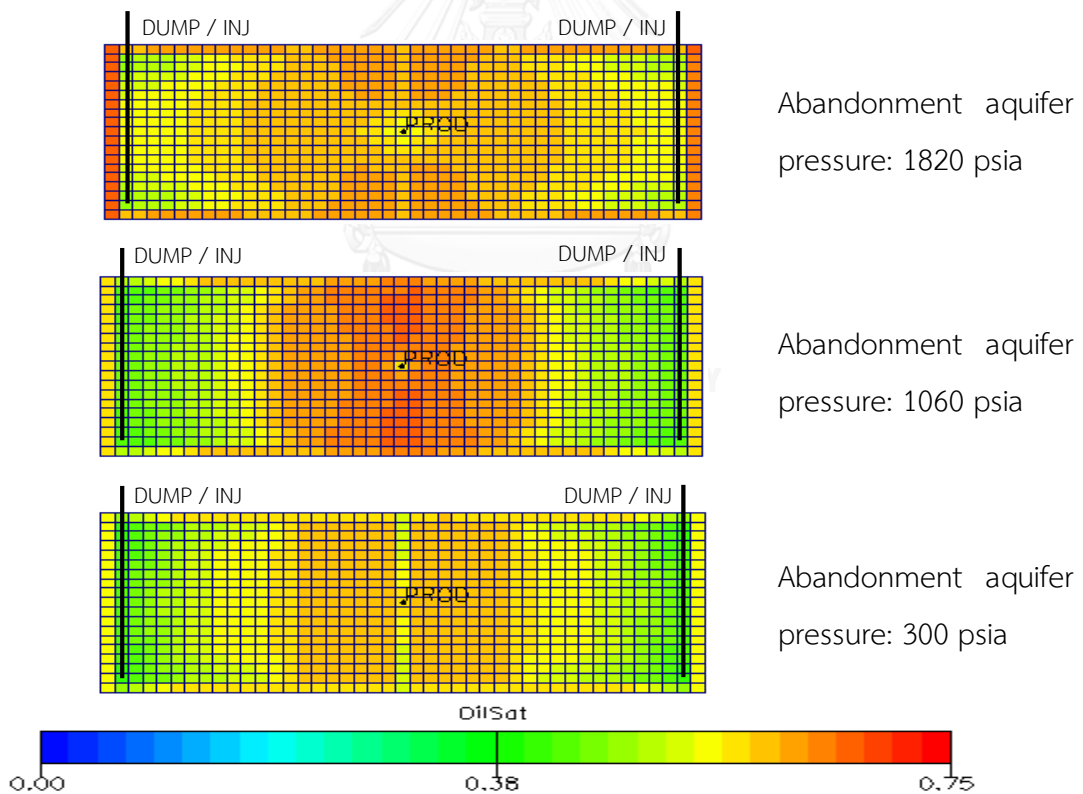

Figure 5-33 Top view of oil saturation profiles of schedule 1 of combined method from 10PV aquifer for well option 1 with maximum liquid production rate of 1000 STB/D at 10 years of production

From Figure 5-34, total water production in the case of early water injection (1820 psia abandonment aquifer pressure) is less than that of the case with late water injection (1060 psia abandonment aquifer pressure) because of short production time that happens as a result of early water breakthrough which eventually reaches the maximum value of 90% cut-off in a short period of time. This reason also results in slightly less of total water injection in the case of early water injection (1820 psia abandonment aquifer pressure) compared to that of late water injection at 1060 psia abandonment aquifer pressure. At abandonment aquifer pressure of 300 psia, total water injection is quite small as water injection is started at late time of production as shown in Figure 5-35.

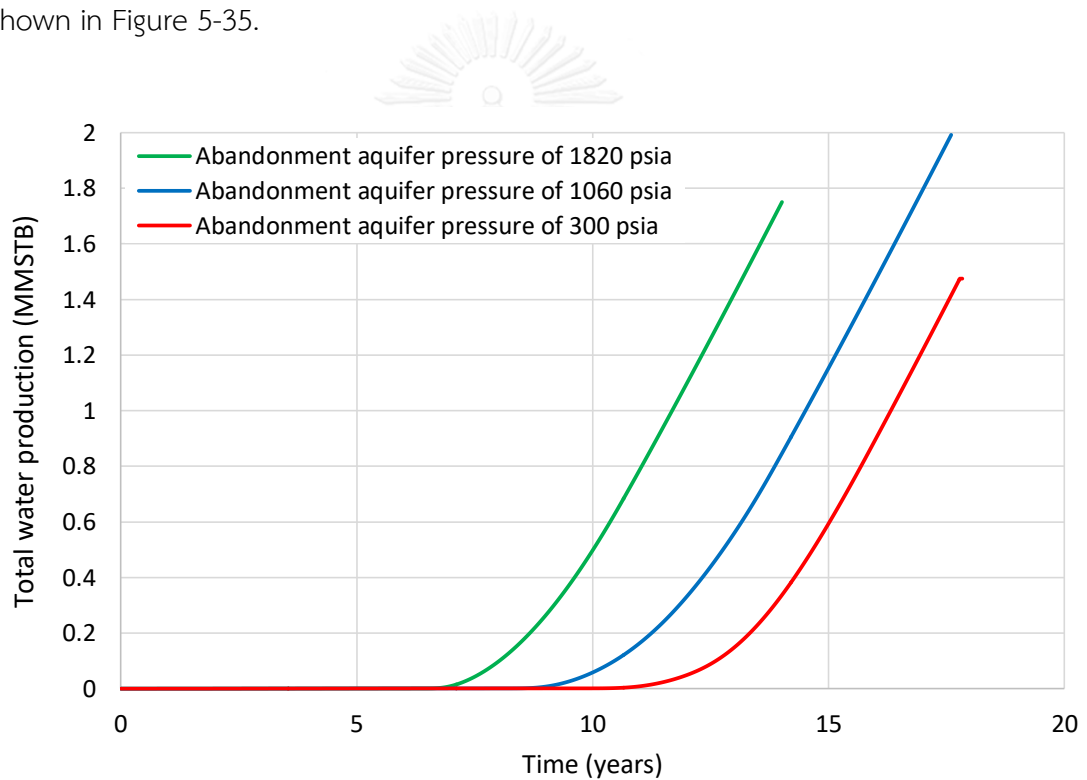

Figure 5-34 Total water productions of schedule 1 of combined method from 10PV aquifer for well option 2 with maximum liquid production rate of 1000 STB/D

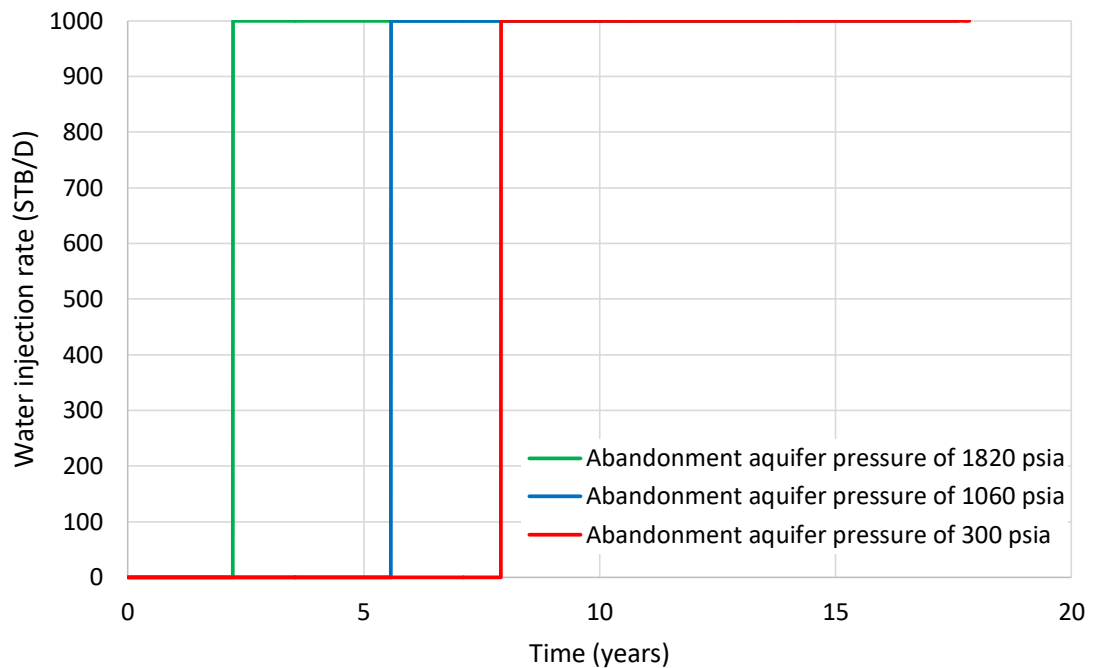

Figure 5-35 Water injection rates of schedule 1 of combined method from 10PV aquifer for well option 2 with maximum liquid production rate of 1000 STB/D

To compare the three different schedules, oil production rates of schedules 1 and 3 at abandonment aquifer pressure of 1820 psia and schedule 2 are plotted in Figure 5-36. For schedule 1, the oil production rate declines early because there is only small pressure support from both dumping wells at the beginning. However, the declining rate is low since dumping wells are converted to injection wells early, resulting in high cumulative oil production. The oil production rate of schedule 3 is also similar to that of schedule 1, except that the plateau is longer due to high pressure support from one all-time injection well from the beginning. In the case of schedule 2, the oil production rate stays at the plateau for the same duration as schedule 3, then drops steeply as the reservoir pressure declines, and drops to another trend when water breaks through the producer. This oil rate remains lower than that of other schedules which means that long-term pressure support from one all-time dumping and injection well is not sufficient for the reservoir.

In summary, schedules 1 and 3 with early abandonment aquifer pressure of 1820 psia are recommended for well option 2 in 10PV aquifer as they yield the highest

oil recovery factors. Schedule 1 should be implemented if injection cannot be started at the beginning while schedule 3 is recommended for the case that injection can be started since the beginning.

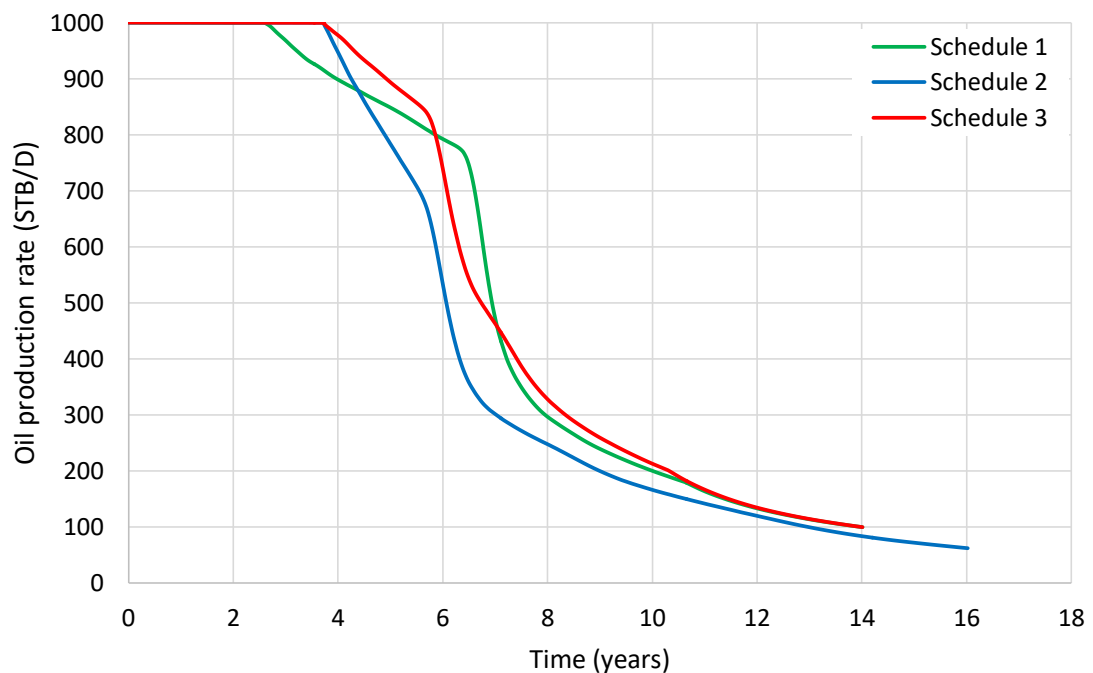

Figure 5-36 Oil production rates of schedules 1, 2 and 3 of combined method from 10PV aquifer for well option 2 with maximum liquid production rate of 1000 STB/D

*b) Maximum liquid production rate of 2000 STB/D*

Using maximum liquid production rate of 2000 STB/D gives schedules 1 and 3 the highest oil recovery factor at abandonment aquifer pressure of 1820 psia (early water injection) as demonstrated in Table 5-10. From Figure 5-37, oil production rates of the three cases of schedule 1 drop very fast from 2000 STB/D in less than four months as a result of high drawdown and small amount of dumped water. For the case of 1820 psia abandonment aquifer pressure of schedule 1, the oil production rate increases back steadily from 1000 STB/D to almost 1500 STB/D for nearly three years when two dumping wells are converted to injection wells. The total of 2000 STB/D of water can be easily injected, resulting in much higher water injection. Overall, the trend in the results for maximum liquid production rate of 2000 STB/D is the same as the

one for maximum liquid production rate of 1000 STB/D. Thus, both schedules 1 and 3 with early water injection (abandonment aquifer pressure of 1820 psia) are recommended depending on the availability of the injection facility.

Table 5-10 Results of different water dumping and injection schedules for well option 2 in 10PV aquifer size with maximum liquid production rate of 2000 STB/D

Dumping injection schedule	Abandonment aquifer pressure (psia)	Total oil production (MMSTB)	Total water production (MMSTB)	Total water injection (MMSTB)	Total water dumped (MMSTB)	Recovery factor (%)	Production time (years)
1	1820	3.029	1.950	5.329	0.455	47.55	8.84
	1060	2.487	2.058	4.688	0.868	39.03	11.25
	300	2.185	1.239	3.646	1.276	34.31	12.16
2	-	2.492	2.594	4.688	0.517	39.11	12.84
3	1820	3.013	1.907	5.317	0.442	47.29	8.76
	1060	N/A	N/A	N/A	N/A	N/A	N/A
	300	N/A	N/A	N/A	N/A	N/A	N/A

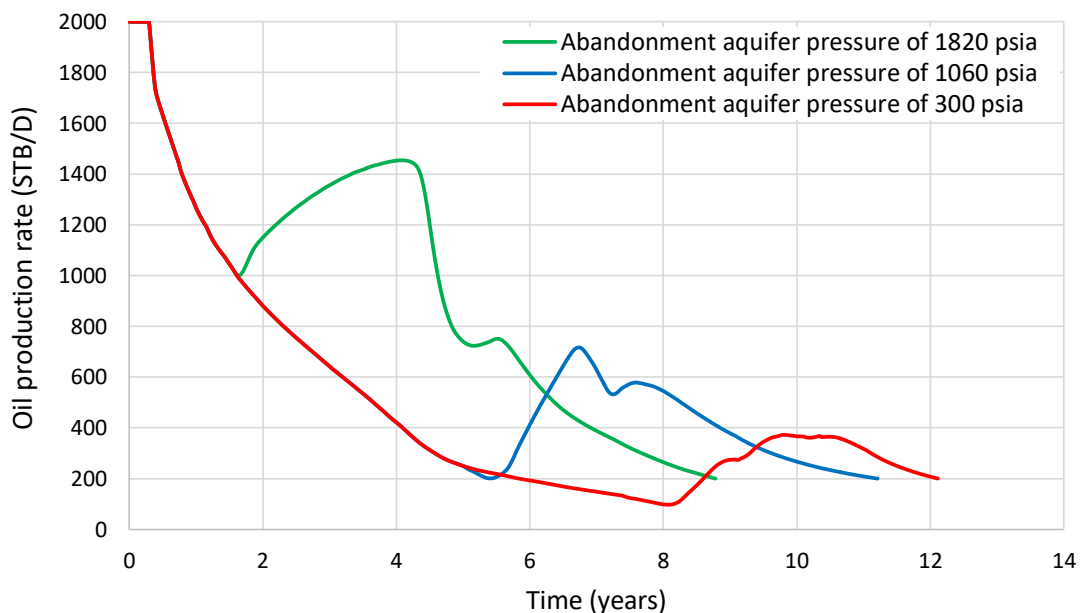

Figure 5-37 Oil production rates of schedule 1 of combined method from 10PV aquifer for well option 2 with maximum liquid production rate of 2000 STB/D

c) Comparison between cases with maximum liquid production rate of 1000 and 2000 STB/D

Figure 5-38 illustrates the total oil production and water injection of cases that have high oil recovery factors from maximum liquid production rate of 1000 and 2000 STB/D. For maximum liquid production rate of 1000 STB/D, dumping and injection schedules 1 and 3 provide total oil production of 2.818 and 2.859 MMSTB, respectively, which are 0.211 and 0.154 MMSTB lower compared to that with maximum liquid production rate of 2000 STB/D. Water injection in the cases of small rate (1000 STB/D) are also much lower than that of the cases with high rate (2000 STB/D). Maximum liquid production rate of 2000 STB/D is recommended over 1000 STB/D in the case that there is no major concern with cost of water injection.

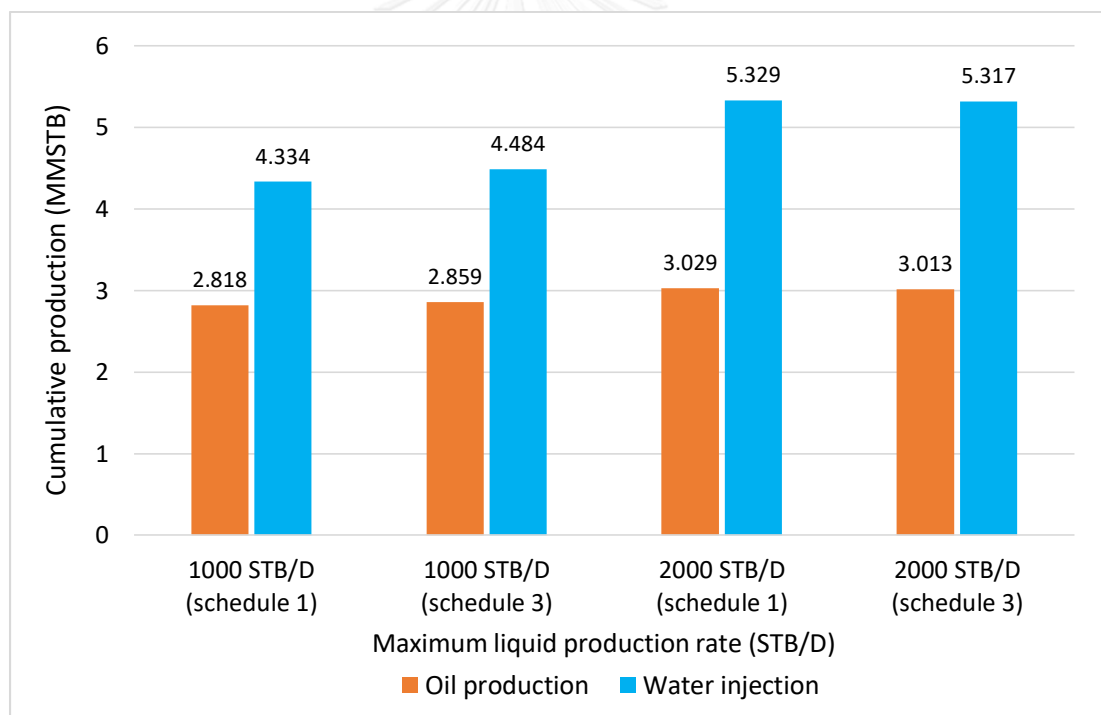

Figure 5-38 Cumulative oil productions and water injections of highest oil recovery cases from maximum liquid production rates of 1000 and 2000 STB/D of combined method from 10PV aquifer for well option 2

### 5.3.3 Effect of water dumping and injection schedule for well option 3

#### a) Maximum liquid production rate of 1000 STB/D

As summarized in Table 5-11, dumping and injection schedule 3 at high abandonment aquifer pressure of 1820 psia (early injection) has the highest oil recovery factor. Schedule 1 with early water injection has no significant difference in oil recovery factor compared to schedule 2. In the case of schedule 3, in which one dumping well is later converted to injector, oil production of 2.689 MMSTB can be obtained when converting dumping well to injection well at early injection. At 1060 and 300 psia abandonment aquifer pressure, oil recovery factors of both cases in schedule 3 are approximately the same but total water injection of the case of 1060 psia abandonment aquifer pressure is 0.487 MMSTB higher than that of the case of 300 psia.

Table 5-11 Results of different water dumping and injection schedules for well option 3 in 10PV aquifer size with maximum liquid production rate of 1000 STB/D

Dumping injection schedule	Abandonment aquifer pressure (psia)	Total oil production (MMSTB)	Total water production (MMSTB)	Total water injection (MMSTB)	Total water dumped (MMSTB)	Recovery factor (%)	Production time (years)
1	1820	2.513	0.642	2.335	0.439	39.44	8.84
	1060	1.693	0.002	0.643	0.852	26.57	6.50
	300	2.141	1.097	2.563	1.259	33.60	13.00
2	-	2.491	0.868	1.912	1.245	39.09	10.48
3	1820	2.689	1.103	3.079	0.432	42.22	10.42
	1060	2.490	0.881	2.475	0.839	39.09	10.42
	300	2.489	0.849	1.988	1.245	39.06	10.42

As shown in Figure 5-39, the oil production rate of schedule 3 with early injection (1820 psia abandonment aquifer pressure) remains at the plateau longer than that of late water injection cases (1060 and 300 psia abandonment aquifer pressure) because one dumping well is converted to injection well from 3.98 years of production. Since dumping well is converted to injection well at early time, pressures from both



injection wells are more or less in equilibrium, resulting in late water breakthrough from one all-time injection well as shown in Figure 5-40. This oil rate then drops due to water breakthrough. At smaller abandonment aquifer pressure (1060 or 300 psia), the oil rate drops early due to water breakthrough from one all-time injection well. In this case, injection pressure is much higher than dumping pressure from small aquifer size, allowing injected water to flow faster to the producer as shown in Figure 5-41. The effect of converted injection well at late time does not provide significant additional pressure support to the reservoir, and sweep efficiency of longer time of vertical dumping well is also poor. Thus, cumulative oil production from early water injection (1820 psia abandonment aquifer pressure) is the highest as illustrated in Figure 5-42.

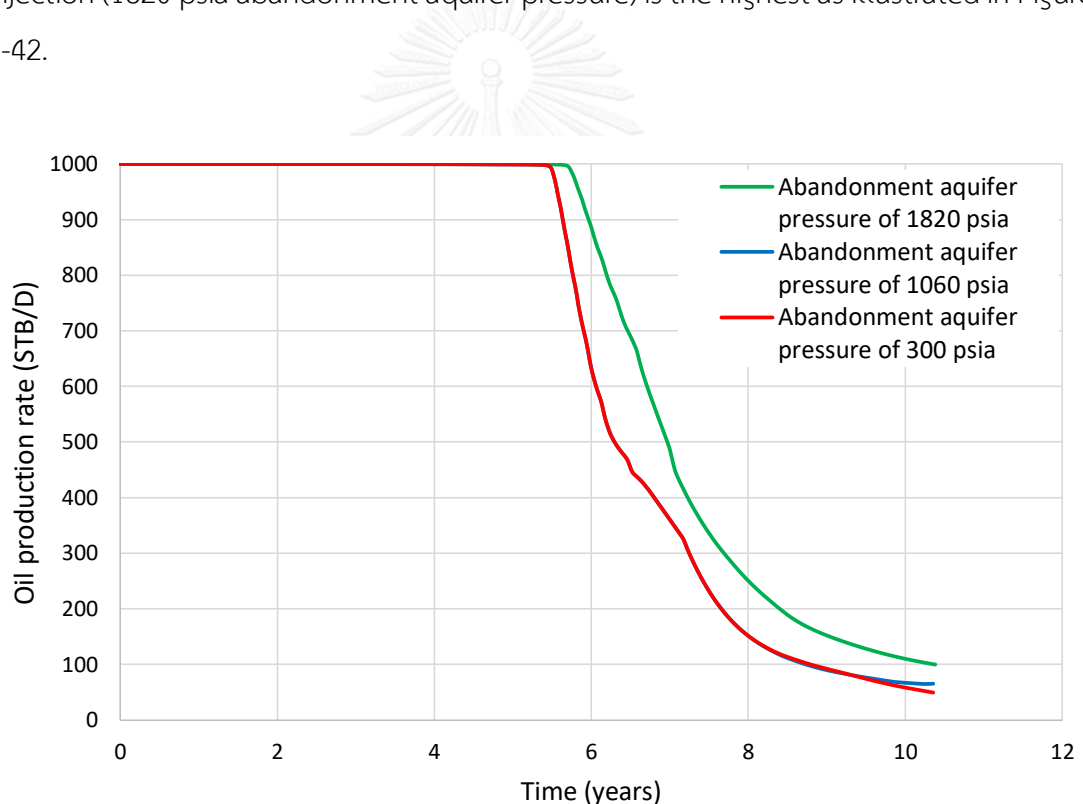

Figure 5-39 Oil production rates of schedule 3 of combined method from 10PV aquifer for well option 3 with maximum liquid production rate of 1000 STB/D

Total water production of the case with early water injection is higher than that with late water injection because water from early converted injector enters the producer in high amount at the late stage of production. Total water injection is much



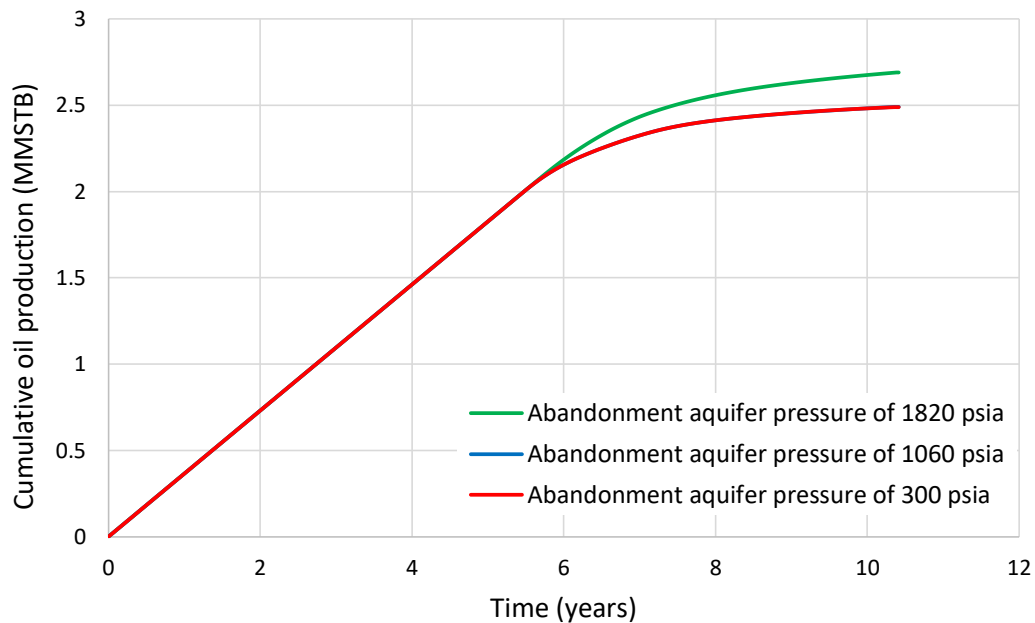

Figure 5-42 Cumulative oil productions of schedule 3 of combined method from 10PV aquifer for well option 3 with maximum liquid production rate of 1000 STB/D

Figure 5-43 illustrates the oil production rates of schedules 1, 2, and 3 with early water injection (1820 psia abandonment aquifer pressure). The oil production rate of schedule 1 stays longer time at the plateau and begins to decline when water breakthrough occurs. The declining rate is high because of much amount of water entering the producer from both injectors, resulting in high water cut as shown in Figure 5-44. In the case of schedule 2, the oil production rate drops early as water breaks through the producer from one all-time injector and its trend is lower than those of other schedules due to insufficient long-term pressure support from one all-time dumping well from small aquifer.

In summary, schedule 3 with early water injection (1820 psia abandonment aquifer pressure) provides the highest oil recover factor for well option 3. With this option, water is required to be injected since the beginning.

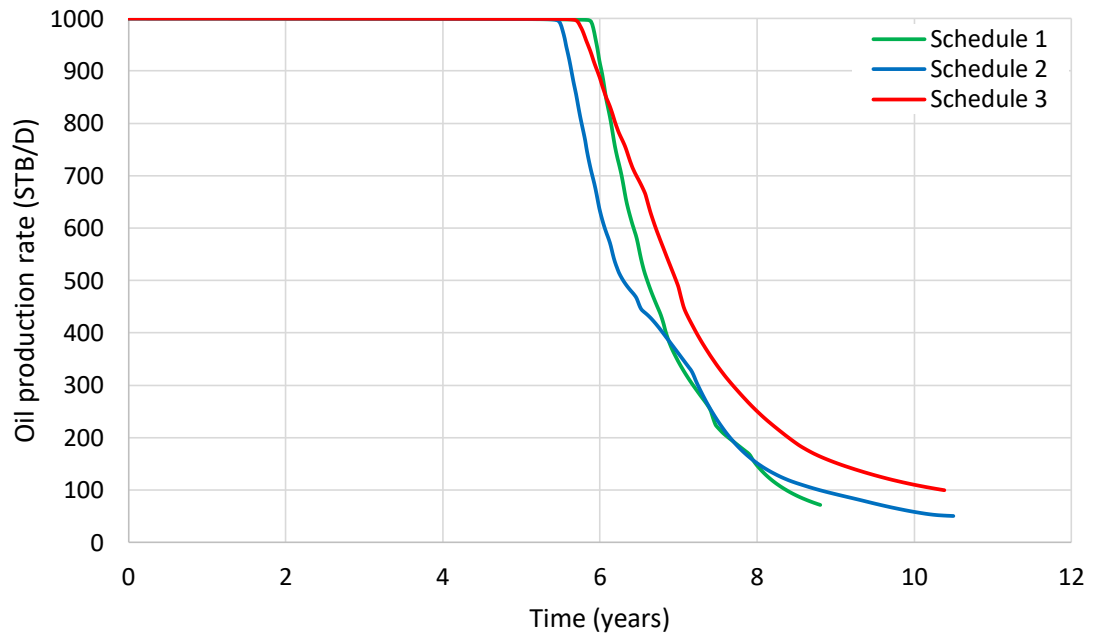

Figure 5-43 Oil production rates of schedules 1, 2 and 3 of combined method from 10PV aquifer for well option 3 with maximum liquid production rate of 1000 STB/D

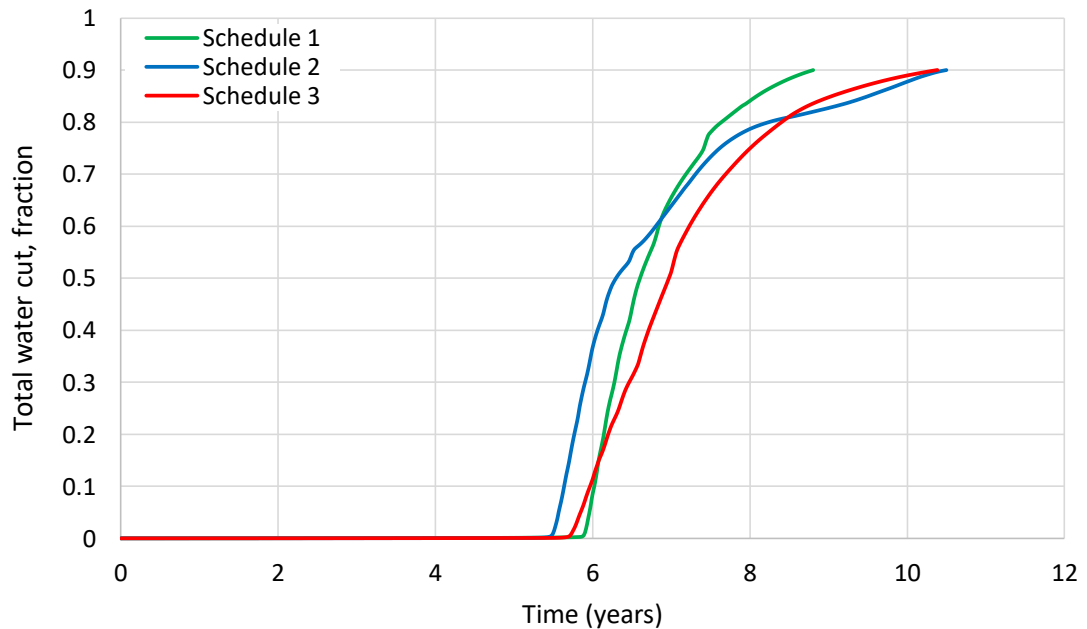

Figure 5-44 Total water cuts of schedules 1, 2 and 3 of combined method from 10PV aquifer for well option 3 with maximum liquid production rate of 1000 STB/D

*b) Maximum liquid production rate of 2000 STB/D*

According to Table 5-12, oil recovery factor of schedule 3 with early water injection (1820 psia abandonment aquifer pressure) is still the highest but 2.08% less than that in the case 1000 STB/D maximum liquid production rate. This small reduction of oil production happens as a result of accelerated depletion of horizontal producer with better productivity, leading to large amount of pressure decline of the reservoir. As a result, injected water from one all-time injection well reaches the producer quite early. Overall, the results for maximum liquid production rate of 2000 STB/D have similar trend to the one for maximum liquid production rate of 1000 STB/D, except that the production time is shorter due to early water breakthrough and high water cut. For maximum liquid production rate of 2000 STB/D, schedules 1 and 3 with early water injection (1820 psia abandonment aquifer pressure) have approximately the same oil recovery factors and production times. Either the schedules 1 or 3 can be implemented, but schedule 3 is recommended if injection can be started at the beginning because it requires less amount of injection water and produces less water production compared to schedule 1.

Table 5-12 Results of different water dumping and injection schedules for well option 3 in 10PV aquifer size with maximum liquid production rate of 2000 STB/D

Dumping injection schedule	Abandonment aquifer pressure (psia)	Total oil production (MMSTB)	Total water production (MMSTB)	Total water injection (MMSTB)	Total water dumped (MMSTB)	Recovery factor (%)	Production time (years)
1	1820	2.512	1.315	3.302	0.432	39.42	6.09
	1060	2.18	1.228	3.141	0.840	33.56	7.17
	300	2.103	1.064	2.961	1.253	33.01	8.33
2	-	2.482	1.293	2.404	1.110	38.95	6.58
3	1820	2.523	1.225	3.217	0.425	40.14	6.00
	1060	2.527	1.536	3.218	0.832	39.66	6.67
	300	N/A	N/A	N/A	N/A	N/A	N/A

c) Comparison between cases with maximum liquid production rate of 1000 and 2000 STB/D

Comparison of total oil production and water injection of the cases with high oil recovery factors for maximum liquid production rate of 1000 and 2000 STB/D are plotted in Figure 5-45. For maximum liquid production rate of 1000 STB/D, dumping and injection schedules 1 and 3 give 2.513 and 2.698 MMSTB of oil production, respectively, and these values are 0.001 and 0.175 higher compared to those for maximum liquid production rate of 2000 STB/D. Moreover, water injection in the cases of small rate (1000 STB/D) are also relatively low compared to those for the high rate (2000 STB/D). Thus, well option 3 in this case should be implemented with either schedules 1 or 3 with maximum liquid production rate of 1000 STB/D.

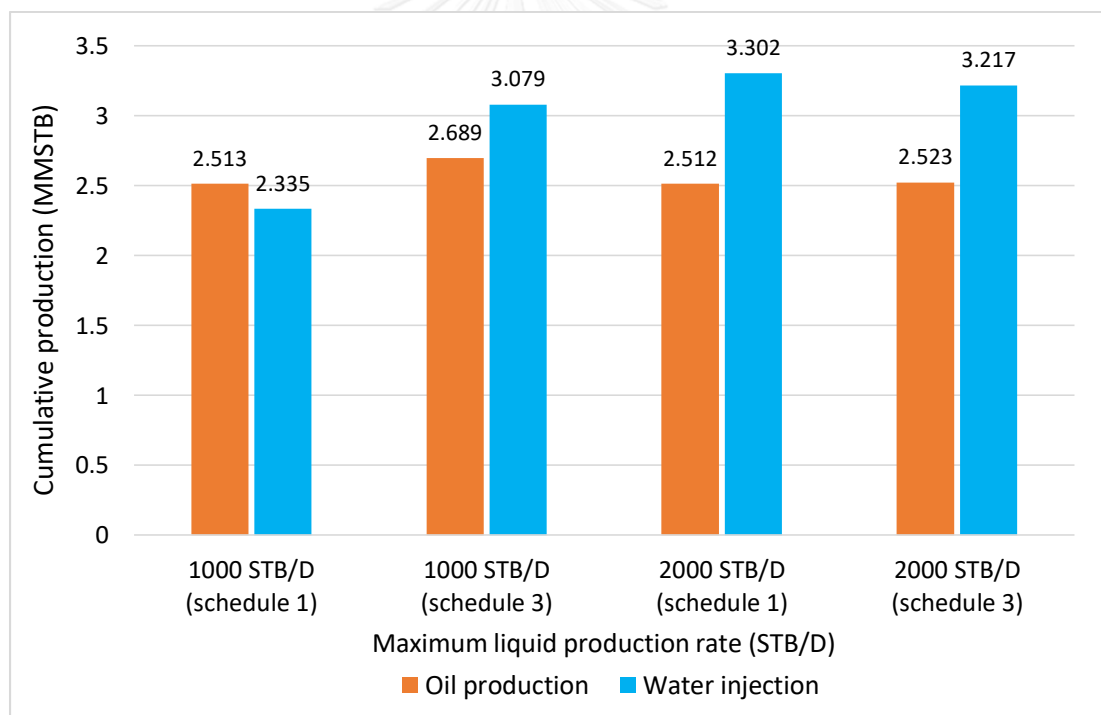

Figure 5-45 Cumulative oil productions and water injections of highest oil recovery cases from maximum liquid production rates of 1000 and 2000 STB/D of combined method from 10PV aquifer for well option 3

### 5.3.4 Effect of water dumping and injection schedule for well option 4

#### *a) Maximum liquid production rate of 1000 STB/D*

Combination of well option 4 has one horizontal production well and two horizontal dumping and/or injection wells. As summarized in Table 5-13, oil recovery factors of schedules 1 and 3 with early injection (1820 psia abandonment aquifer pressure) are the highest compared to late water injection cases (1060 and 300 psia abandonment aquifer pressure). Note that the aquifer pressure in schedule 3 never reaches 300 psia since the reservoir pressure declines slowly as a result of one all-time injector. From Figure 5-46, the oil production rate of schedule 1 at early injection stays at the plateau for 6.32 years of production because of better productivity of the producer and early conversion of dumping wells to injection wells that helps maintain the reservoir pressure and sweeps the oil efficiently. Then, the oil rate declines sharply as a tremendous amount of injected water from horizontal injectors enters the horizontal producer at the same time along the horizontal length of the well, leading to sharp increase in water cut which eventually reaches the maximum water cut of 90% in a short period of time. In the cases of late injection, the oil rates drop since 4.11 years of production due to insufficient pressure support from the two dumping wells. As a result, cumulative oil productions of schedules 1 and 3 at late injection are smaller as depicted in Figure 5-47.

Water production in the case of early injection (1820 psia abandonment aquifer pressure) is lower than the case with late injection (1060 psia abandonment aquifer pressure) due to early water breakthrough and sharp increase in water cut as shown in Figure 5-48, leading to short production time. Moreover, early water injection cases also require larger amounts of injected water.

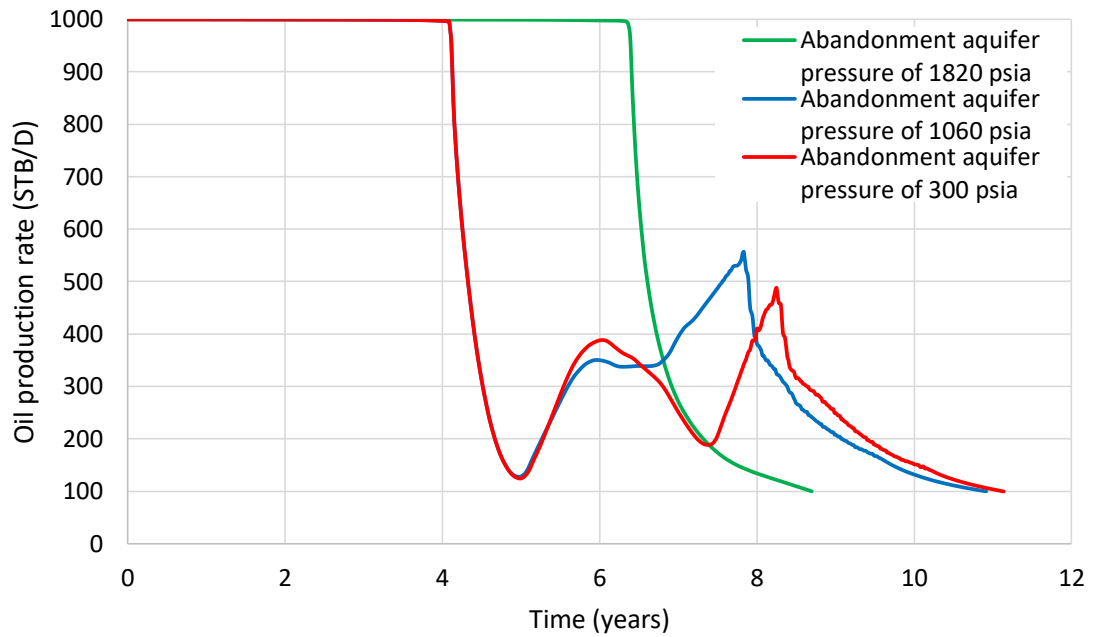

Figure 5-46 Oil production rates of schedule 1 of combined method from 10PV aquifer for well option 4 with maximum liquid production rate of 1000 STB/D

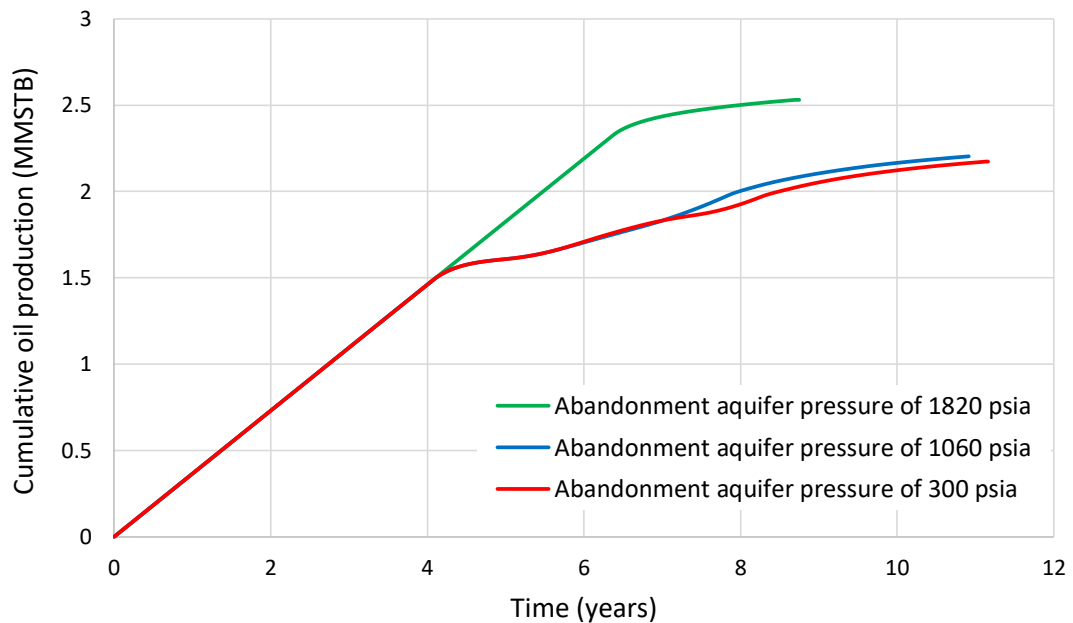

Figure 5-47 Cumulative oil productions of schedule 1 of combined method from 10PV aquifer for well option 4 with maximum liquid production rate of 1000 STB/D



Table 5-13 Results of different water dumping and injection schedules for well option 4 in 10PV aquifer size with maximum liquid production rate of 1000 STB/D

Dumping injection schedule	Abandonment aquifer pressure (psia)	Total oil production (MMSTB)	Total water production (MMSTB)	Total water injection (MMSTB)	Total water dumped (MMSTB)	Recovery factor (%)	Production time (years)
1	1820	2.531	0.645	2.386	0.457	39.73	8.76
	1060	2.204	0.753	2.303	0.878	34.59	10.92
	300	2.174	0.680	1.926	1.281	34.12	11.16
2	-	2.494	0.765	1.689	1.223	39.16	9.25
3	1820	2.664	0.958	2.963	0.445	41.81	9.92
	1060	2.493	0.759	2.094	0.852	39.13	9.17
	300	N/A	N/A	N/A	N/A	N/A	N/A

The effect of three different schedules with maximum liquid production rate of 1000 STB/D for well option 4 are plotted in term of oil production rate in Figure 5-49. The oil production rates of schedules 1 and 3 stay at the plateau longer time than that of schedule 2 because of early conversion of dumping well(s) to injection well(s). The rates then drop dramatically when water breakthrough occurs, resulting in much higher amount of injected water in schedule 3, in which injection begins since the beginning and slightly less for schedule 1. In the case of schedule 2, the oil rate drops early due to partial pressure support from one all-time injector but later on, the declining rate is slow as a result of dumped water that sweeps the oil to the producer at late time. Thus, oil recovery of schedule 2 is slightly less compared to those of other two schedules but its injected water is much lower than other cases.

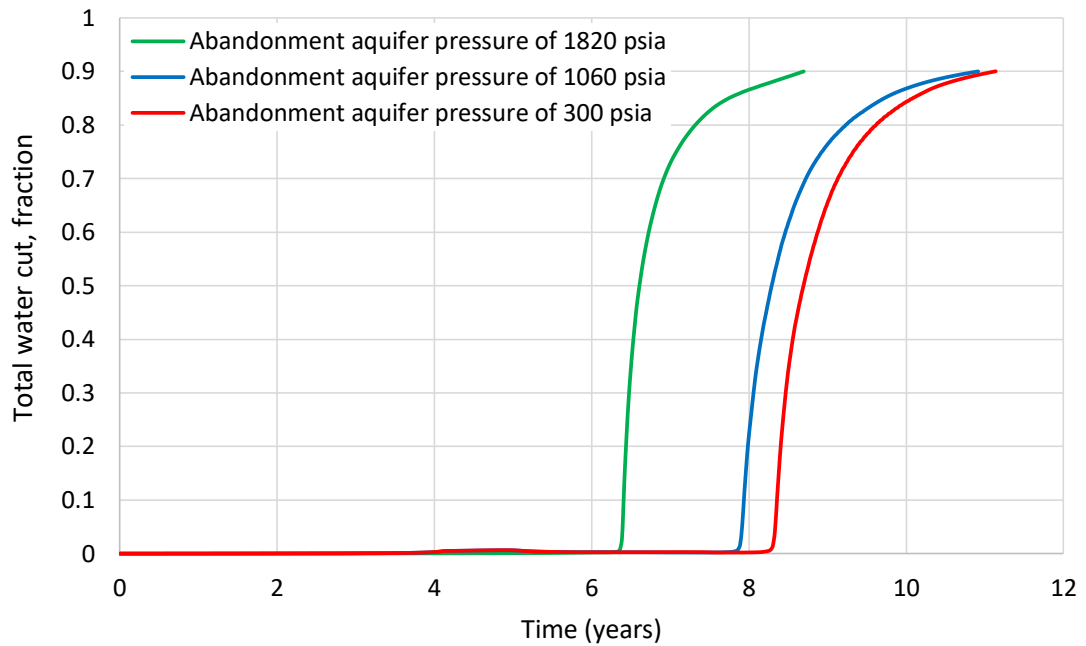

Figure 5-48 Total water cuts of schedule 1 of combined method from 10PV aquifer for well option 4 with maximum liquid production rate of 1000 STB/D

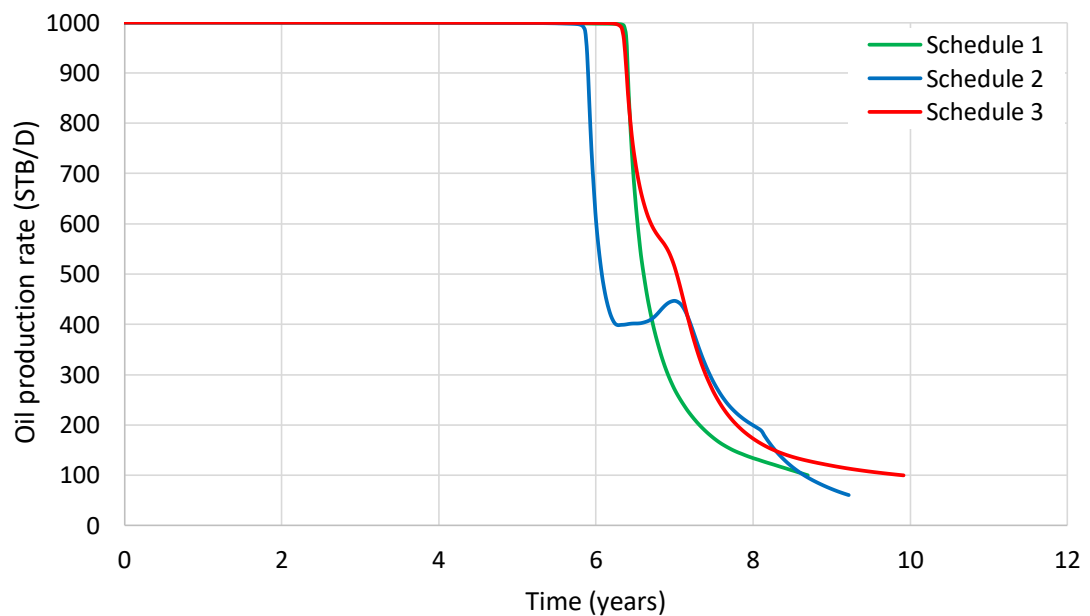

Figure 5-49 Oil production rates of schedules 1, 2 and 3 of combined method from 10PV aquifer for well option 4 with maximum liquid production rate of 1000 STB/D

*b) Maximum liquid production rate of 2000 STB/D*

As summarized in Table 5-14, recovery factors of schedule 1 with early injection (1820 psia abandonment aquifer pressure), schedule 2, and both cases with abandonment aquifer pressures of 1820 and 1060 psia of schedule 3 are approximately the same. Schedules 1 and 3 with early injection require tremendous amount of water injection compared to schedule 2 because dumping wells are converted to injection wells quite early as a result of accelerated depletion and better productivity of the producer, leading to sharp decline of reservoir pressure. Water production of schedules 1 and 3 is slightly less than schedule 2 because of late water breakthrough and short production time that results from high water cut of both injectors. In conclusion, schedules 2 and 3 with early water injection (1820 psia abandonment aquifer pressure) are recommended for well option 4 with maximum liquid production rate of 2000 STB/D.

Table 5-14 Results of different water dumping and injection schedules for well option 4 in 10PV aquifer size with maximum liquid production rate of 2000 STB/D

Dumping injection schedule	Abandonment aquifer pressure (psia)	Total oil production (MMSTB)	Total water production (MMSTB)	Total water injection (MMSTB)	Total water dumped (MMSTB)	Recovery factor (%)	Production time (years)
1	1820	2.439	1.102	3.063	0.455	38.29	5.50
	1060	2.178	1.065	2.749	0.864	34.18	6.42
	300	2.122	0.642	2.289	1.279	33.30	7.25
2	-	2.468	1.167	2.223	1.160	38.74	6.09
3	1820	2.495	0.995	2.999	0.440	39.16	5.16
	1060	2.469	1.165	2.707	0.847	38.77	5.75
	300	N/A	N/A	N/A	N/A	N/A	N/A

*c) Comparison between cases with maximum liquid production rate of 1000 and 2000 STB/D*

Total oil productions and water injections of the cases with high oil recovery factors for maximum liquid production rate of 1000 and 2000 STB/D are shown in Figure 5-50. For maximum liquid production rate of 1000 STB/D, dumping and injection schedules 1 and 3 give 2.531 and 2.664 MMSTB of oil production, respectively, which are higher compared to those for maximum liquid production rate of 2000 STB/D. Schedule 3 of maximum liquid production rate 1000 STB/D provides the highest oil production while its water injection is slightly less than that with maximum liquid production rate of 2000 STB/D. Thus, this schedule is recommended.

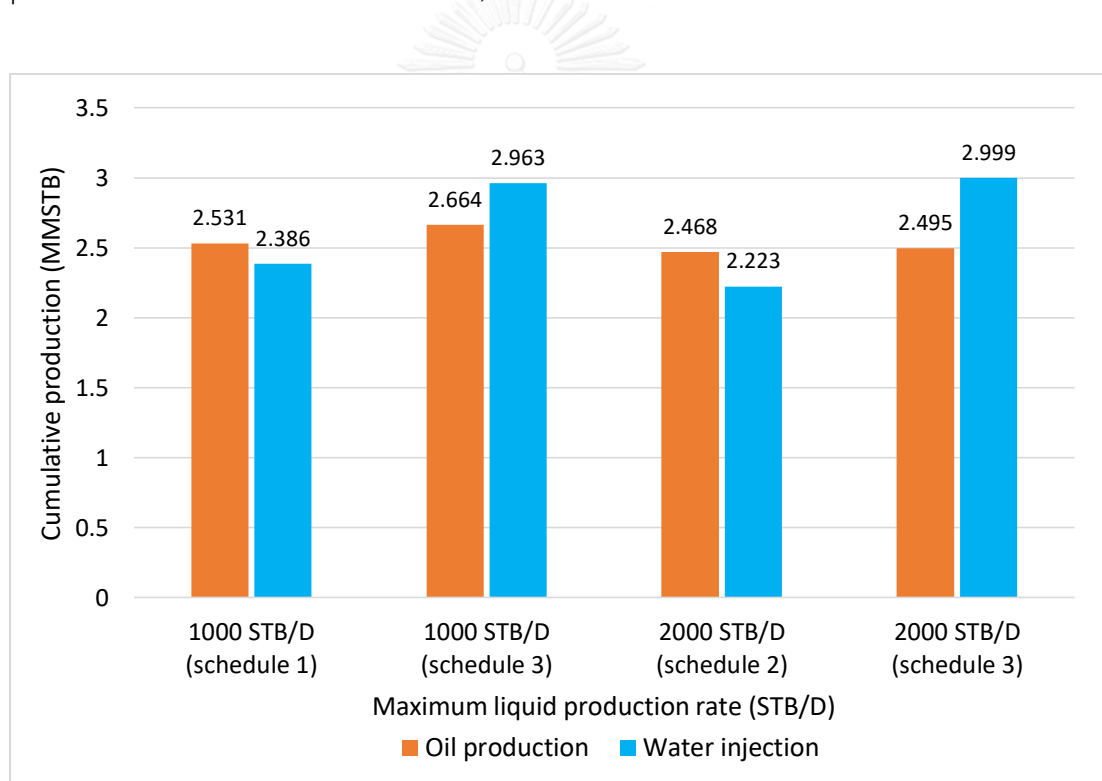

Figure 5-50 Cumulative oil productions and water injections of highest oil recovery cases from maximum liquid production rates of 1000 and 2000 STB/D of combined method from 10PV aquifer for well option 4

### 5.3.5 Comparison among different well options

In the combined water dumpflood from 10PV aquifer with water injection, well option 1 gives the highest oil production of 3.088 MMSTB when maximum liquid production rate of 2000 STB/D is implemented with schedule 1, in which two dumping wells are later converted to two injection wells at early injection (1820 psia abandonment aquifer pressure). As illustrated in Figure 5-51, this well option requires tremendous amount of water injection of 5.698 MMSTB. In the case of well option 2, the oil production can be maximized when maximum liquid production rate of 2000 STB/D is used with schedule 1. This combination provides 3.029 MMSTB of oil and 5.329 MMSTB of water injection which are 0.059 and 0.369 MMSTB of oil and water, respectively, lower than that of well option 1. Well options 3 and 4 yield approximately the same oil production and the highest recoveries are obtained when maximum liquid production rate of 1000 STB/D is used with schedule 3. However, these oil productions are relatively low compared to well options 1 and 2, but the amounts of water injection are much smaller. If cost of water injection is not a major concern, well option 1 with maximum liquid production rate of 2000 STB/D and well schedule 1 is recommended.

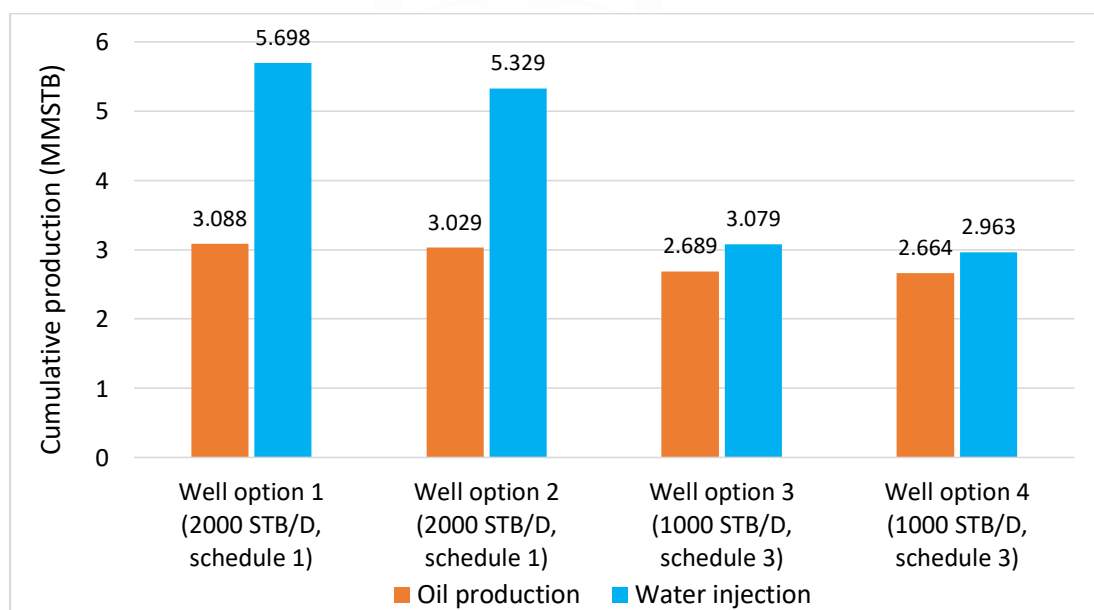

Figure 5-51 Cumulative oil productions and water injections of four well options of combined method from 10PV aquifer

## 5.4 Combined water dumpflood from 50PV aquifer with water injection

In this section, 50PV aquifer size is used for water dumping combined with water injection. Maximum liquid production rate of 1000 and 2000 STB/D is implemented. Dumping and injection schedules are separated into three main schedules as mentioned in Chapter 4. For schedules 1 and 3, converting from dumping well(s) to injection well(s) is based on the abandonment aquifer pressure which is 1820, 1060, and 300 psia as three different cases. For dumping wells, water is allowed to flow freely without controlling the rate. When these wells are converted to injection wells, the total injection rate from both injectors is set equal to maximum liquid production rate. In case of simultaneous one dumping well and one injection well, the water injection rate is set to be equal to 50% of maximum liquid production rate. Total oil production and total water injection are observed and compared between cases to find out the appropriate well combination that can deliver comparable or more oil production and minimize the injection water.

### 5.4.1 Effect of water dumping and injection schedule for well option 1

#### *a) Maximum liquid production rate of 1000 STB/D*

As summarized in Table 5-15, aquifer pressures in schedules 1 and 3 never reach 1060 and 300 psia abandonment aquifer pressure since the aquifer size is relatively big, leading to small pressure decline during the production. With 1820 psia abandonment aquifer pressure (early injection), schedules 1 and 3 have approximately the same oil recovery as schedule 2. As illustrated in Figure 5-52, the oil production rate of schedule 1 drops 0.75 years earlier than those of schedules 2 and 3 due to the fact that its reservoir pressure declines faster compared to the other schedules at early time as shown in Figure 5-53. Figure 5-54 clearly illustrates that total water cross-flow rate of schedule 1 from both dumping wells is mostly smaller than 1000 STB/D. For schedules 2 and 3, the total water cross-flow rate from one dumping well is mostly higher than 500 STB/D at early production time. Thus, the total amount of water dumping rate from dumping well and injection rate from injector is mostly higher than 1000 STB/D. This results in slower reservoir pressure decline of schedules 2 and 3

compared to that of schedule 1. When aquifer pressure reaches 1820 psia, both dumping wells of schedule 1 are converted to injectors, leading to increase in reservoir pressure. Then, flood front sweeps oil from the edges of reservoir into the producer as shown in Figure 5-55, resulting in a lower decline of oil rate and longer production time.

Table 5-15 Results of different water dumping and injection schedules for well option 1 in 50PV aquifer size with maximum liquid production rate of 1000 STB/D

Dumping injection schedule	Abandonment aquifer pressure (psia)	Total oil production (MMSTB)	Total water production (MMSTB)	Total water injection (MMSTB)	Total water dumped (MMSTB)	Recovery factor (%)	Production time (years)
1	1820	2.934	2.399	3.541	2.105	46.06	16.43
	1060	N/A	N/A	N/A	N/A	N/A	N/A
	300	N/A	N/A	N/A	N/A	N/A	N/A
2	-	2.898	2.125	2.829	2.240	45.49	15.51
3	1820	2.915	2.259	3.191	2.096	45.76	15.92
	1060	N/A	N/A	N/A	N/A	N/A	N/A
	300	N/A	N/A	N/A	N/A	N/A	N/A

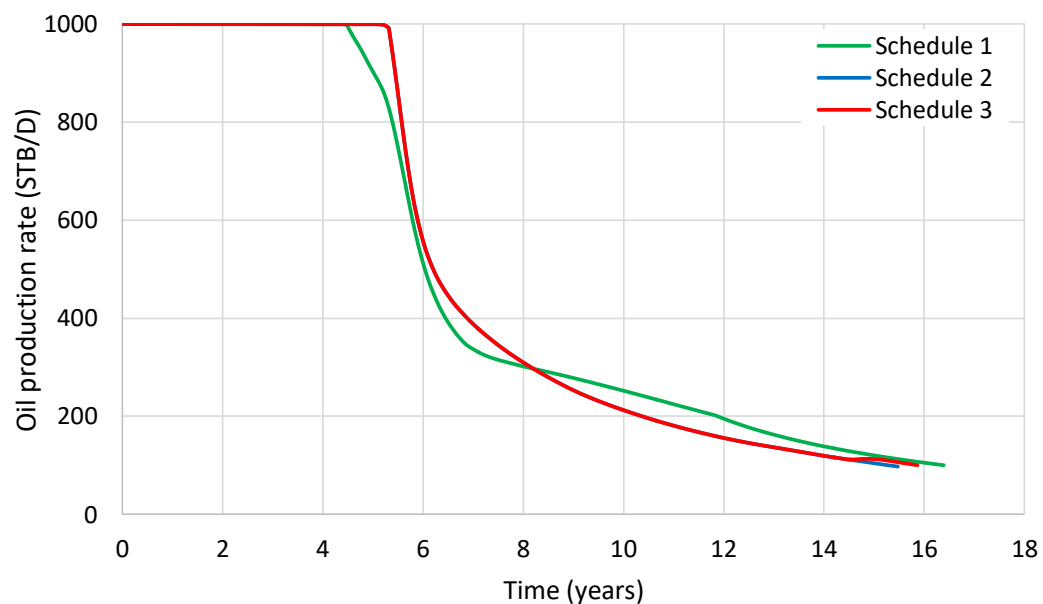

Figure 5-52 Oil production rates of schedules 1, 2 and 3 of combined method from 50PV aquifer for well option 1 with maximum liquid production rate of 1000 STB/D

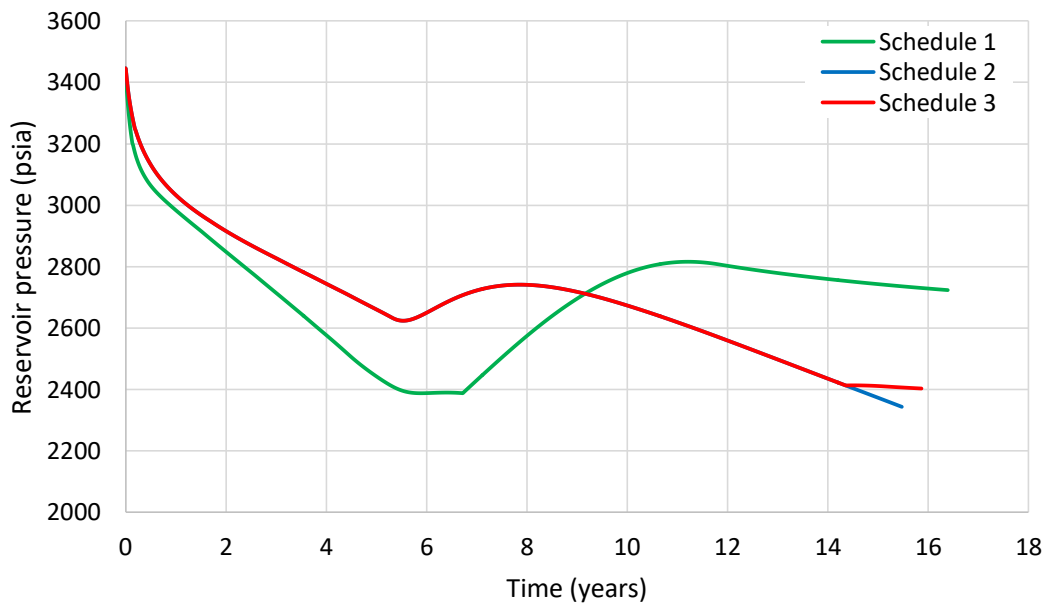

Figure 5-53 Reservoir pressures of schedules 1, 2 and 3 of combined method from 50PV aquifer for well option 1 with maximum liquid production rate of 1000 STB/D

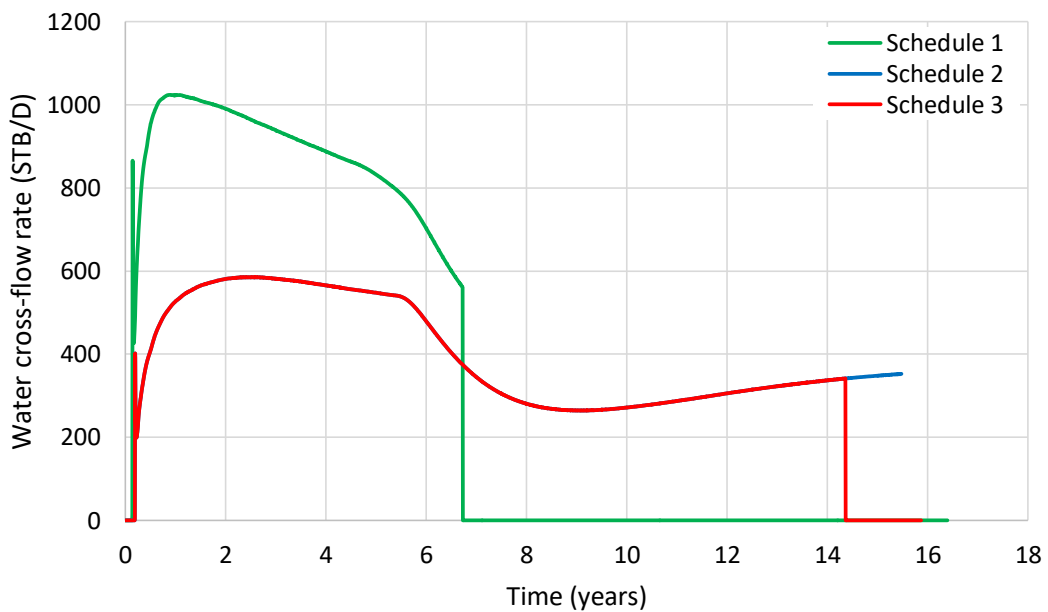

Figure 5-54 Water cross-flow rates of schedules 1, 2 and 3 of combined method from 50PV aquifer for well option 1 with maximum liquid production rate of 1000 STB/D



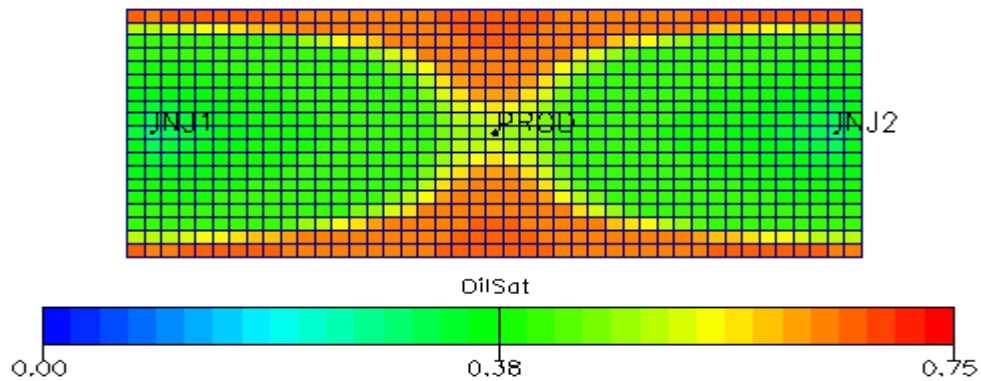

Figure 5-55 Top view of oil saturation profile of schedule 1 of combined method from 50PV aquifer for well option 1 with maximum liquid production rate of 1000 STB/D at 10 years of production

Oil production rates of schedules 2 and 3 begin to drop sharply at 5.22 years of production due to water breakthrough and then drop gradually when the reservoir pressure slightly builds up. The two schedules have the same trend and only show slight difference at late time of production. This indicates that one dumping well from the beginning of schedules 2 and 3 give a slower decline of aquifer pressure, resulting in long production time in order to reach abandonment aquifer pressure of 1820 psia. The three schedules have similar breakthrough times as shown in Figure 5-56. When the aquifer pressure reaches 1820 psia, water cut of the producer in schedule 3 increases to almost 90% cut-off value, leading to a small additional oil recovery from the converted injection well as illustrated in Figure 5-57.

Water production rate of schedule 1 increases at a slower pace than those of schedules 2 and 3 at early times after breakthrough because of better sweep efficiency from simultaneous water injection of both injectors and later on, increases with a higher pace as flood front from the edges of the reservoir enters the producer. As a result, schedule 1 has slightly higher water production. Moreover, schedule 1 requires large amount of injected water because of early conversion of both dumping wells to injection wells compared to schedule 3.

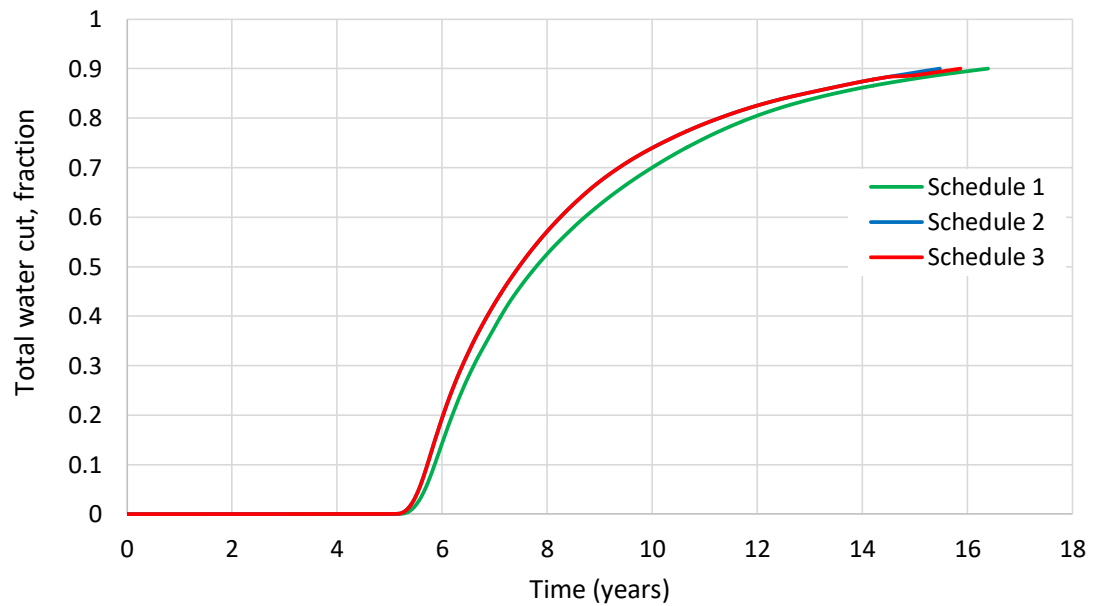

Figure 5-56 Total water cuts of schedules 1, 2 and 3 of combined method from 50PV aquifer for well option 1 with maximum liquid production rate of 1000 STB/D

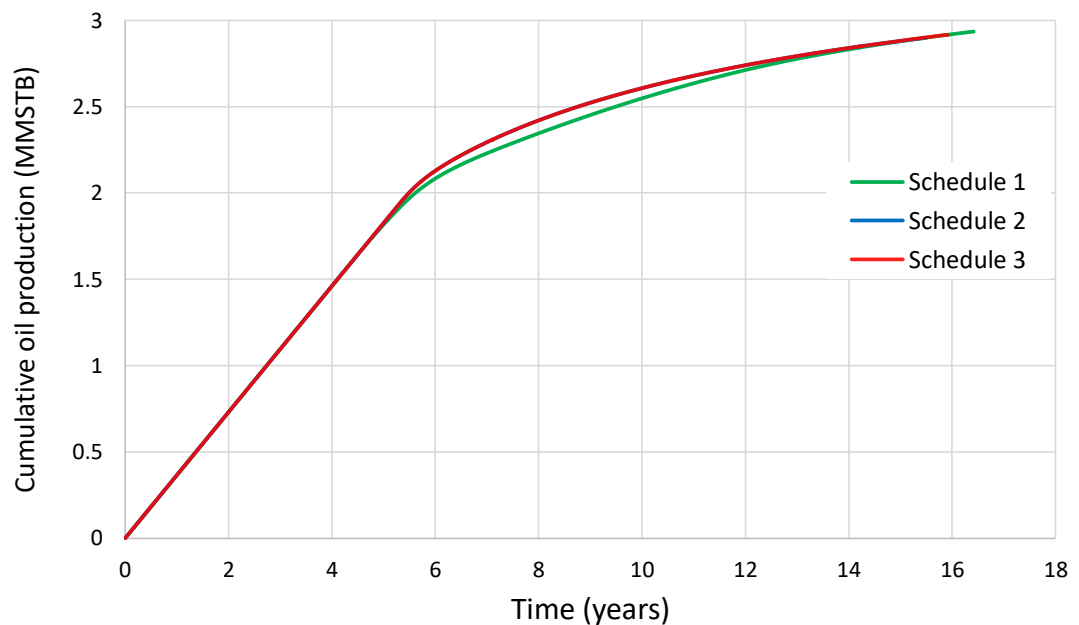

Figure 5-57 Cumulative oil productions of schedules 1, 2 and 3 of combined method from 50PV aquifer for well option 1 with maximum liquid production rate of 1000 STB/D

*b) Maximum liquid production rate of 2000 STB/D*

According to Table 5-16, schedule 1 with late water injection (1060 and 300 psia abandonment aquifer pressure) cannot be implemented because aquifer pressure never reaches these abandonment pressures. In the case of schedule 3 with one all-time injector and one dumping well later converted to injector, the aquifer pressure cannot attain any of the three abandonment pressures (1820, 1060, and 300 psia) because of the effect of large aquifer size and high injection rate of the one all-time injector that slows down the decline in reservoir pressure.

As shown in Figure 5-58, the oil production rate of schedule 1 can be produced at 2000 STB/D for only 0.22 years from the beginning and then drops sharply as a result of low productivity of vertical producer. This high drawdown at the beginning leads to rapid decline of reservoir pressure as shown in Figure 5-59 and as a result, tremendous amount of water crosses flow to the reservoir as shown in Figure 5-60. Then, the reservoir pressure declines slowly, and the oil production rate drops at slower trend. Late on, this oil rate experiences another rapid decline due to water breakthrough. When the injection begins, the oil rate increases due to increase in reservoir pressure and finally decrease due to low oil saturation around the producer. In the case of schedule 3, oil production rate of 2000 STB/D can be obtained a little longer compared to schedule 1 because of the effect of one all-time injector. This oil rate then drops sharply due to poor productivity of the producer. Water breakthrough in this case happens at 3.2 years of production, resulting in another steep decline. The oil rate trend is lower than that of schedule 1 because one all-time dumping well provides much less amount of water cross-flow.

Table 5-16 Results of different water dumping and injection schedules for well option 1 in 50PV aquifer size with maximum liquid production rate of 2000 STB/D

Dumping injection schedule	Abandonment aquifer pressure (psia)	Total oil production (MMSTB)	Total water production (MMSTB)	Total water injection (MMSTB)	Total water dumped (MMSTB)	Recovery factor (%)	Production time (years)
1	1820	3.069	2.371	4.129	2.093	48.19	11.51
	1060	N/A	N/A	N/A	N/A	N/A	N/A
	300	N/A	N/A	N/A	N/A	N/A	N/A
2	-	2.888	3.099	4.931	1.472	45.33	13.51
3	1820	N/A	N/A	N/A	N/A	N/A	N/A
	1060	N/A	N/A	N/A	N/A	N/A	N/A
	300	N/A	N/A	N/A	N/A	N/A	N/A

Water production and water injection in the case of schedule 1 are much lower compared to those of schedule 2 due to simultaneous conversion of both dumping wells to injectors that provides equivalent pressure support from both injectors. As a result, flood front can sweep the oil more efficiently and water breakthrough in this case occurs at late time as shown in Figure 5-61. Sharp increase of water cut from simultaneous injection also results in short production time. In schedule 2, one all-time injection well with maximum injection rate of 1000 STB/D (50% of maximum liquid production rate) causes quite early water breakthrough, leading to tremendous amounts of produced water and injected water.

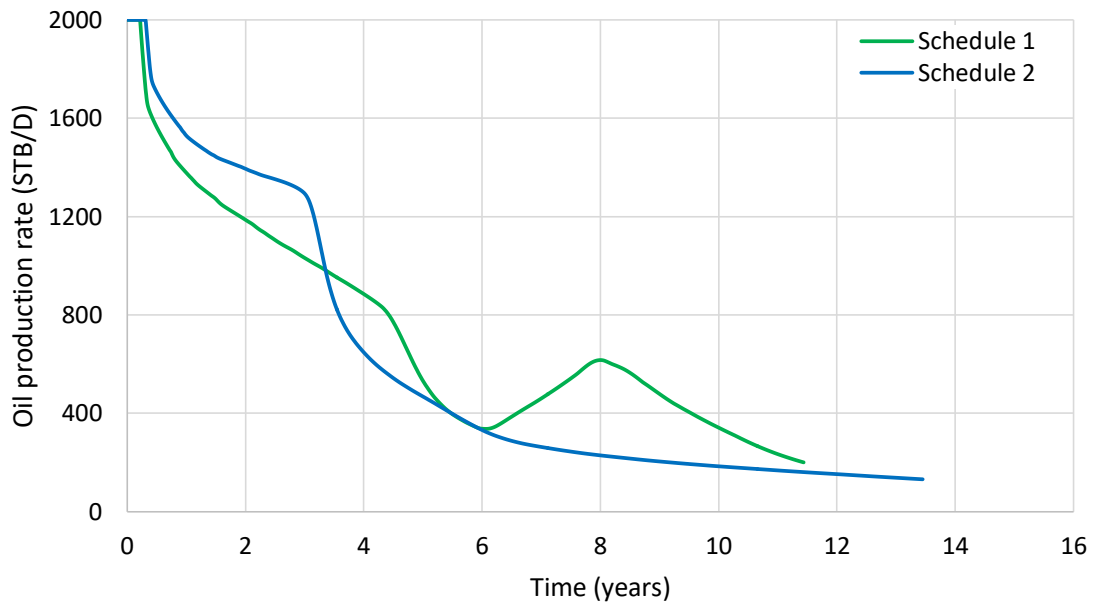

Figure 5-58 Oil production rates of schedules 1 and 2 of combined method from 50PV aquifer for well option 1 with maximum liquid production rate of 2000 STB/D

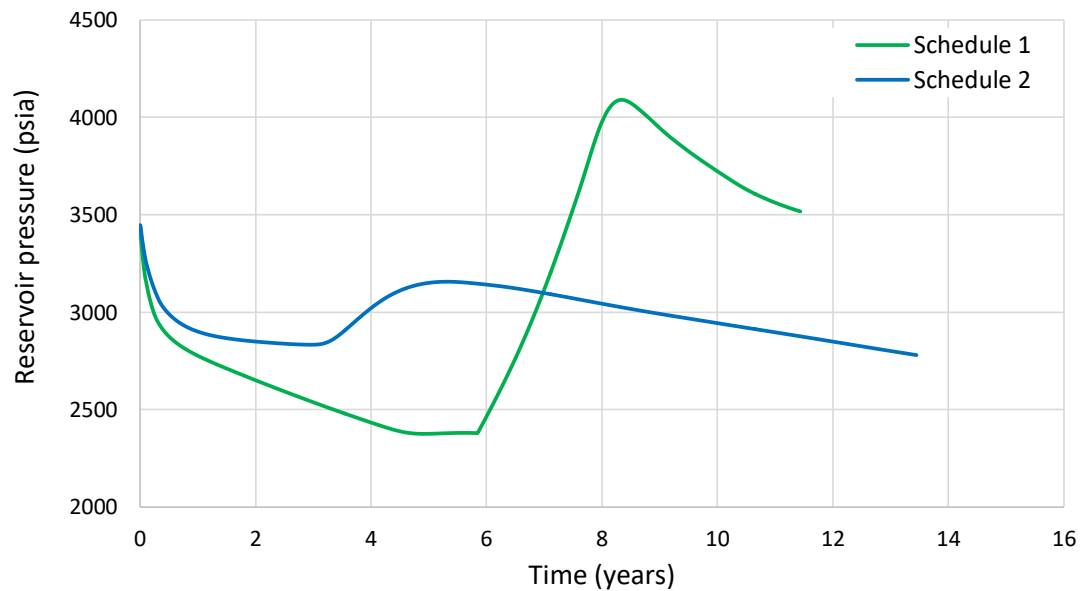

Figure 5-59 Reservoir pressures of schedules 1 and 2 of combined method from 50PV aquifer for well option 1 with maximum liquid production rate of 2000 STB/D

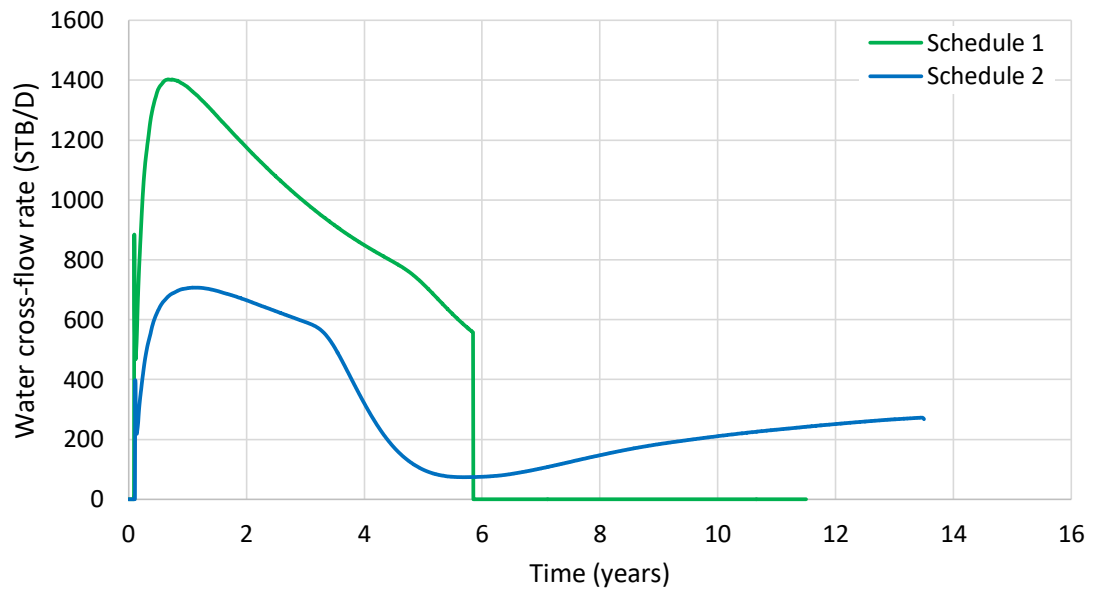

Figure 5-60 Water cross-flow rates of schedules 1 and 2 of combined method from 50PV aquifer for well option 1 with maximum liquid production rate of 2000 STB/D

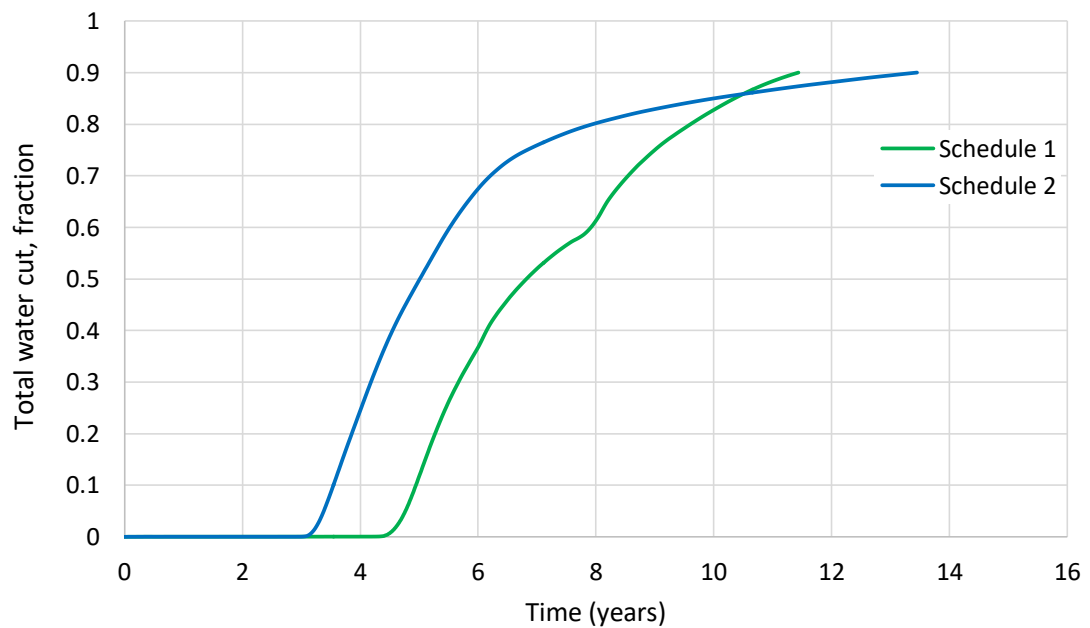

Figure 5-61 Total water cuts of schedules 1 and 2 of combined method from 50PV aquifer for well option 1 with maximum liquid production rate of 2000 STB/D

c) Comparison between cases with maximum liquid production rate of 1000 and 2000 STB/D

Figure 5-62 illustrates the total oil productions and water injections of cases with high oil recovery from maximum liquid production rate of 1000 and 2000 STB/D. With maximum liquid production rate of 1000 STB/D, either schedules 1 or 2 can be implemented since the oil productions are not significantly different but water injection of schedule 1 is relatively higher than that of schedule 2. Schedule 3 with one dumping well later converted to injector and one all-time injector should not be used because the dumping well can only be converted to injector at very late time of production which does not provide significant oil recovery. In the case of 2000 STB/D maximum liquid production rate, schedule 1 is the best option because oil production is higher and water injection is much lower compared to schedule 2. This schedule provides the highest oil recovery factor for well option 1. If cost of water injection is not a major concern, well option 1 with maximum liquid production rate of 2000 STB/D and well schedule 1 is recommended.

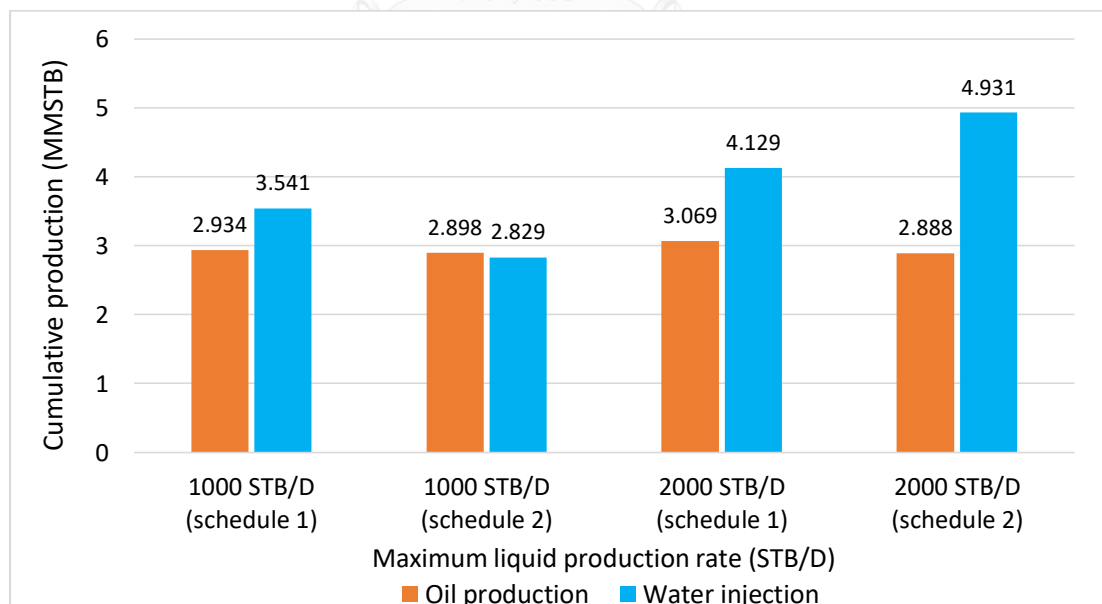

Figure 5-62 Cumulative oil productions and water injections of highest oil recovery cases from maximum liquid production rates of 1000 and 2000 STB/D of combined method from 50PV aquifer for well option 1

#### 5.4.2 Effect of water dumping and injection schedule for well option 2

##### *a) Maximum liquid production rate of 1000 STB/D*

Similar to well option 1, schedules 1 and 3 are not applicable with low abandonment aquifer pressures (1060 and 300 psia) due to small aquifer pressure decline during the production. As summarized in Table 5-17, oil recovery factors of the three schedules are approximately the same with less than 1% difference. In Figure 5-63, the oil production rate of schedule 1 drops earlier than other cases because of rapid decline of reservoir pressure as a result of using two dumping wells from the beginning as depicted in Figure 5-64. This rate drops again due to water breakthrough but the declining rate is not that high because of the conversion of the two dumping wells. Later on, this declining rate is even slower since oil from the edges of the reservoir is swept into the producer as shown in Figure 5-65, resulting in longer production time compared to other two schedules.

Oil production rates of schedules 2 and 3 stay at the plateau longer than schedule 1 because of high pressure support from one all-time injector since the beginning. These rates then drop dramatically when water breakthrough occurs as shown in Figure 5-66. Finally, the flood front sweeps the oil into the producer, resulting in slower decline of oil rates. Note that conversion of dumping well to injector of schedule 3 begins at very late time because aquifer pressure declines slowly. This converted injector does not provide significant oil recovery since the water cut almost reaches 90% cut-off at the time of conversion.

Both horizontal dumping wells of schedule 1 allow aquifer pressure to reach 1820 psia abandonment pressure early. As a result, the two dumping wells are converted to injectors, and duration of water injection of 1000 STB/D is quite long, leading to high water injection and water production than other schedules.



Table 5-17 Results of different water dumping and injection schedules for well option 2 in 50PV aquifer size with maximum liquid production rate of 1000 STB/D

Dumping injection schedule	Abandonment aquifer pressure (psia)	Total oil production (MMSTB)	Total water production (MMSTB)	Total water injection (MMSTB)	Total water dumped (MMSTB)	Recovery factor (%)	Production time (years)
1	1820	2.841	1.719	2.700	2.154	44.59	13.59
	1060	N/A	N/A	N/A	N/A	N/A	N/A
	300	N/A	N/A	N/A	N/A	N/A	N/A
2	-	2.831	1.507	2.328	2.150	44.44	12.76
3	1820	2.846	1.597	2.516	2.067	44.68	13.01
	1060	N/A	N/A	N/A	N/A	N/A	N/A
	300	N/A	N/A	N/A	N/A	N/A	N/A

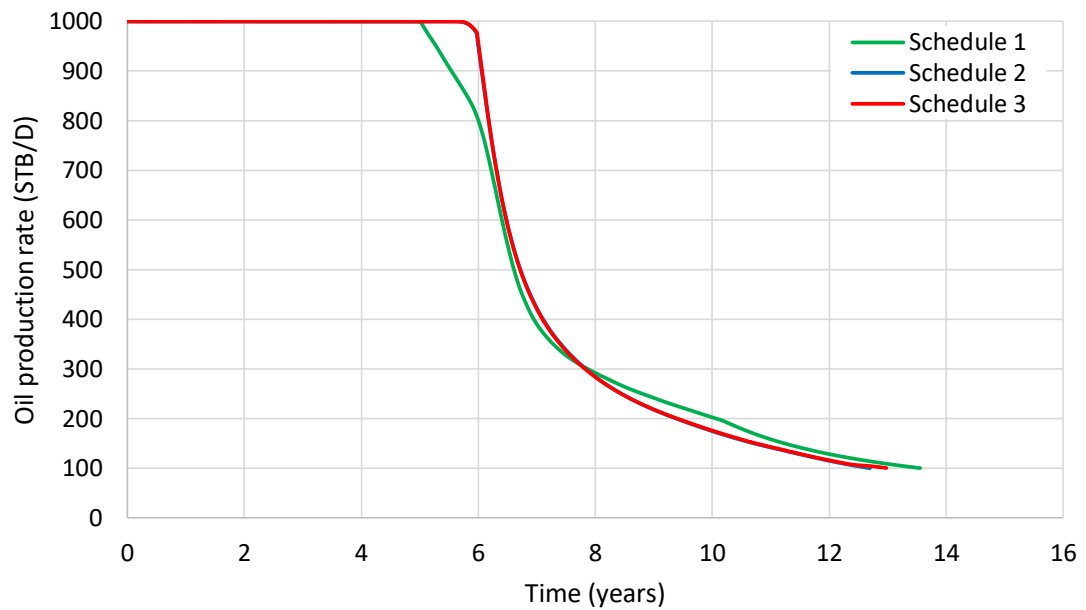

Figure 5-63 Oil production rates of schedules 1, 2 and 3 of combined method from 50PV aquifer for well option 2 with maximum liquid production rate of 1000 STB/D

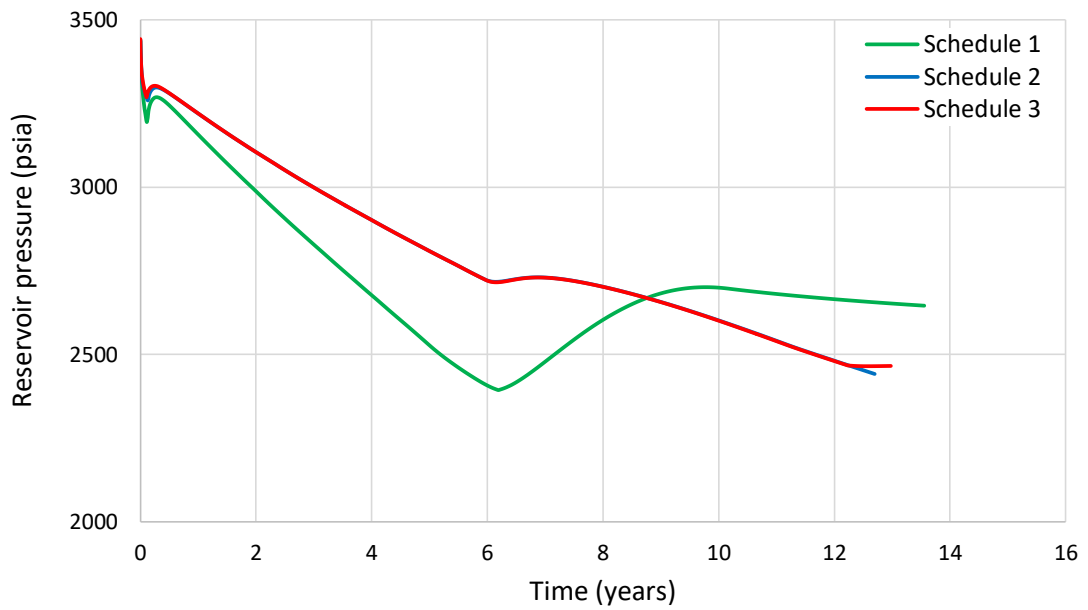

Figure 5-64 Reservoir pressures of schedules 1, 2 and 3 of combined method from 50PV aquifer for well option 2 with maximum liquid production rate of 1000 STB/D

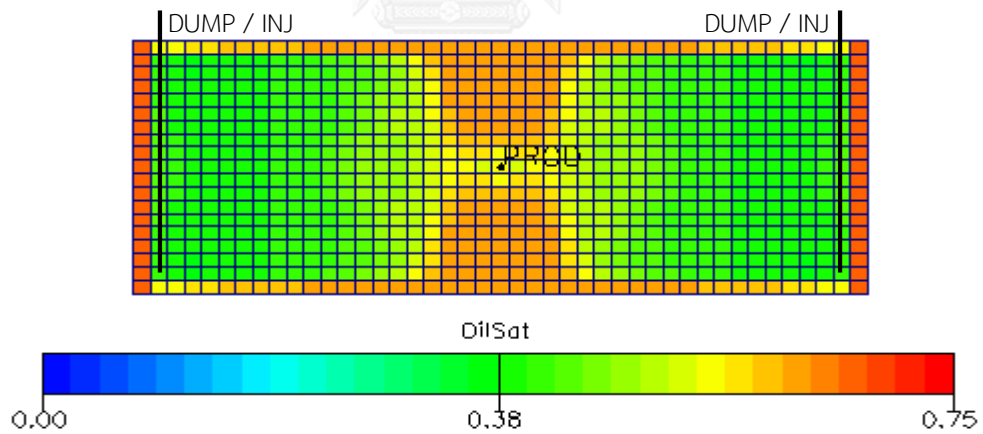

Figure 5-65 Top view of oil saturation profile of schedule 1 of combined method from 50PV aquifer for well option 2 with maximum liquid production rate of 1000 STB/D at 8 years of production

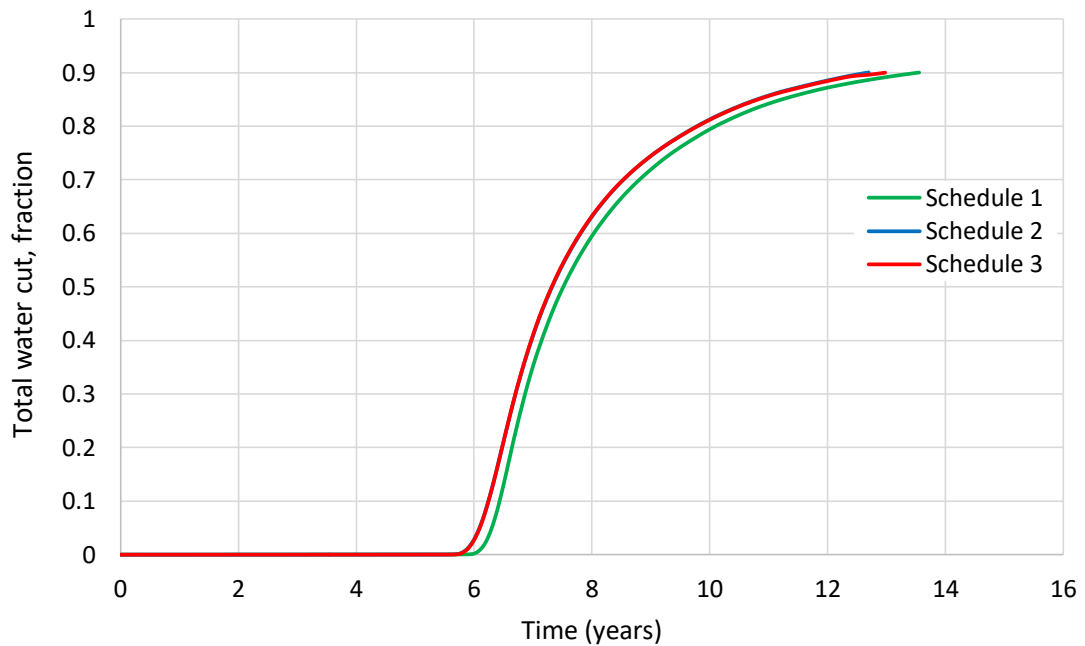

Figure 5-66 Total water cuts of schedules 1, 2 and 3 of combined method from 50PV aquifer for well option 2 with maximum liquid production rate of 1000 STB/D

*b) Maximum liquid production rate of 2000 STB/D*

Table 5-18 illustrates that the cases of schedule 1 with late water injection (1060 and 300 psia abandonment aquifer pressure) and schedule 3 with any of the three abandonment aquifer pressures are not applicable because aquifer pressure never reaches the limit values. Schedule 1 at early injection provides higher oil recovery factor of 2% compared to the case with schedule 2. As shown in Figure 5-67, oil production rates of both schedules drop quite early due to low productivity of the vertical producer. In the case of schedule 1, water crosses flow from aquifer into the reservoir in high amount at the beginning due to sharp decrease of reservoir pressure and long horizontal dumping wells as shown in Figure 5-68. This tremendous amount of dumped water slows down the decline of reservoir pressure, resulting in slower decrease of oil production rate. Then, water breakthrough occurs, and the oil production rate drops again until water injection begins. The oil production rate of schedule 2 stays higher than that of schedule 1 since the beginning because of high injection rate from one all-time injector. Later on, this oil rate falls sharply due to early

water breakthrough from one all-time injector. The rate keeps falling below the trend of schedule 1 as a result of less water dumped from one all-time dumping well.

Table 5-18 Results of different water dumping and injection schedules for well option 2 in 50PV aquifer size with maximum liquid production rate of 2000 STB/D

Dumping injection schedule	Abandonment aquifer pressure (psia)	Total oil production (MMSTB)	Total water production (MMSTB)	Total water injection (MMSTB)	Total water dumped (MMSTB)	Recovery factor (%)	Production time (years)
1	1820	2.975	1.975	3.565	2.143	46.71	9.76
	1060	N/A	N/A	N/A	N/A	N/A	N/A
	300	N/A	N/A	N/A	N/A	N/A	N/A
2	-	2.848	2.089	3.865	1.533	44.71	10.59
3	1820	N/A	N/A	N/A	N/A	N/A	N/A
	1060	N/A	N/A	N/A	N/A	N/A	N/A
	300	N/A	N/A	N/A	N/A	N/A	N/A

Schedule 1 produces less water and requires much lower water injection than those of schedule 2 as a fact that simultaneous conversion of dumping wells to injectors provides better flood front, leading to better sweep efficiency and late water breakthrough as shown in Figure 5-69. However, production time of schedule 1 is short because of sharp increase of water cut from simultaneous injection. In the case of schedule 2 with one all-time injector, injected water arrives the producer quite early, resulting in high amounts of water injection and water production.

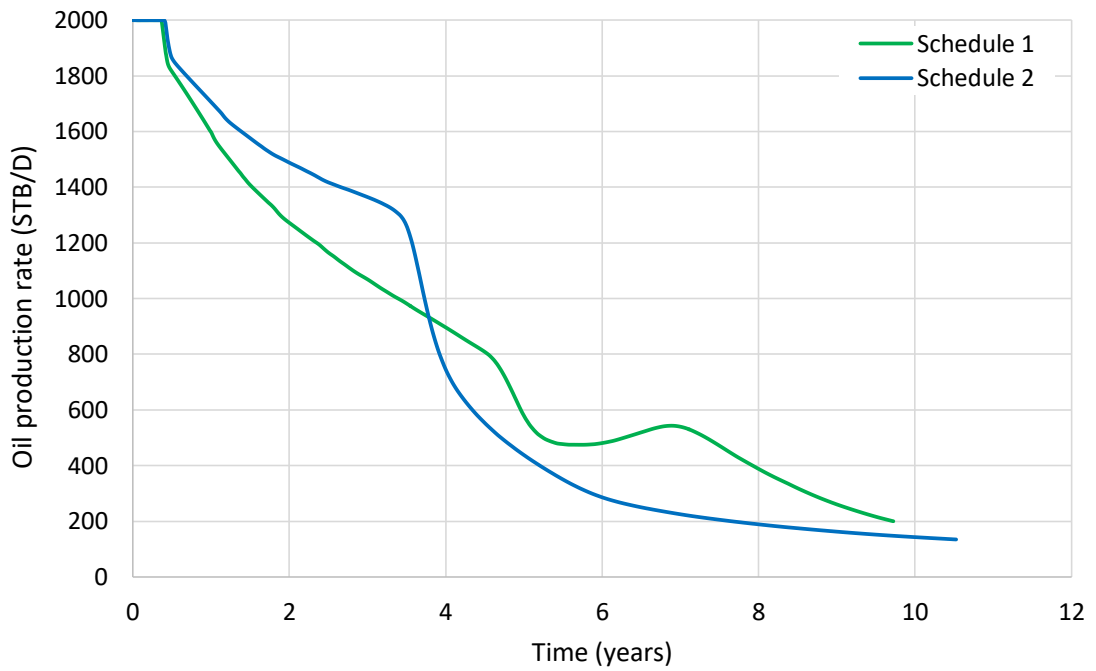

Figure 5-67 Oil production rates of schedules 1 and 2 of combined method from 50PV aquifer for well option 2 with maximum liquid production rate of 2000 STB/D

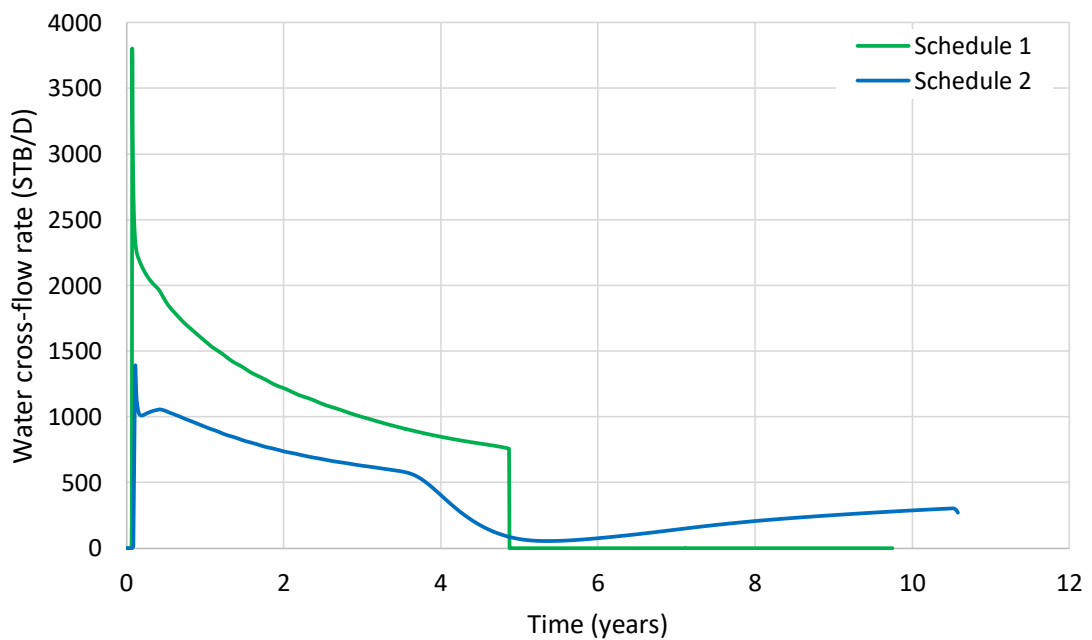

Figure 5-68 Water cross-flow rates of schedules 1 and 2 of combined method from 50PV aquifer for well option 2 with maximum liquid production rate of 2000 STB/D

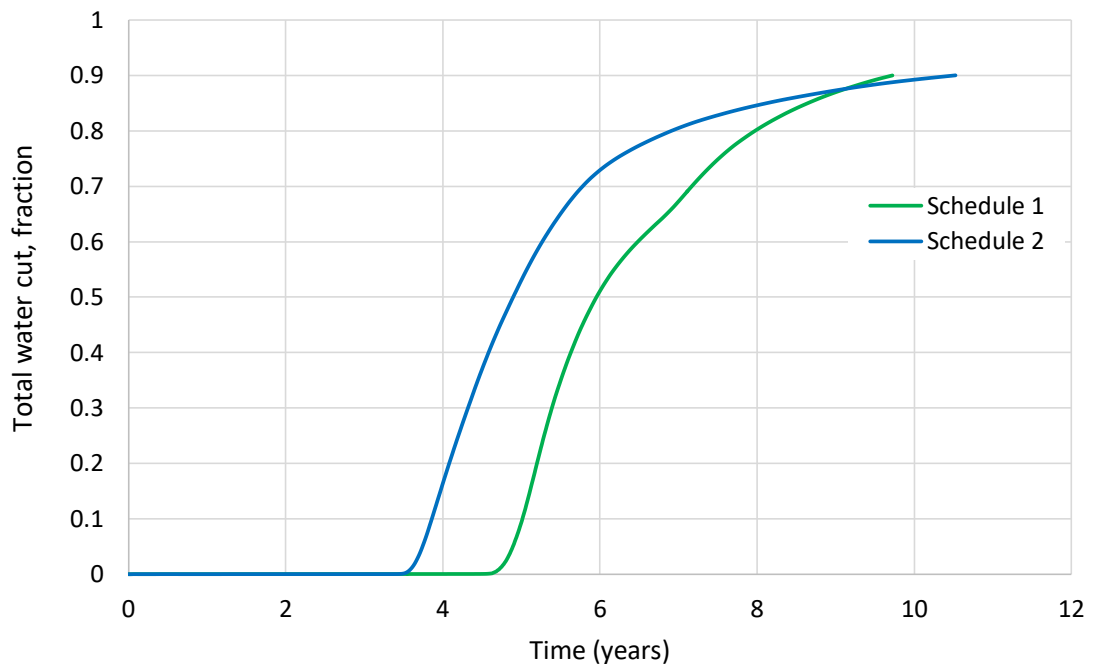

Figure 5-69 Total water cuts of schedules 1 and 2 of combined method from 50PV aquifer for well option 2 with maximum liquid production rate of 2000 STB/D

*c) Comparison between cases with maximum liquid production rate of 1000 and 2000 STB/D*

In the cases of maximum liquid production rate of 1000 STB/D, either schedule 1 or 2 can be used depending on the availability of injection facility but the oil recovery is slightly less compared to the cases with 2000 STB/D maximum liquid production rate. Schedule 3 with one dumping well later converted to injector and one all-time injector is not recommended since the dumping well can only be converted to injector at very late time of production which does not provide any significant oil recovery. With maximum liquid production rate of 2000 STB/D, schedule 1 at early injection is the best option compared to schedule 2 because it provides high oil recovery and even less amounts of water production and injection as shown in Figure 5-70. This schedule 1 also yields the highest oil recovery and short production time compared to the cases with small production rate (1000 STB/D). Thus, it is recommended for well option 2.

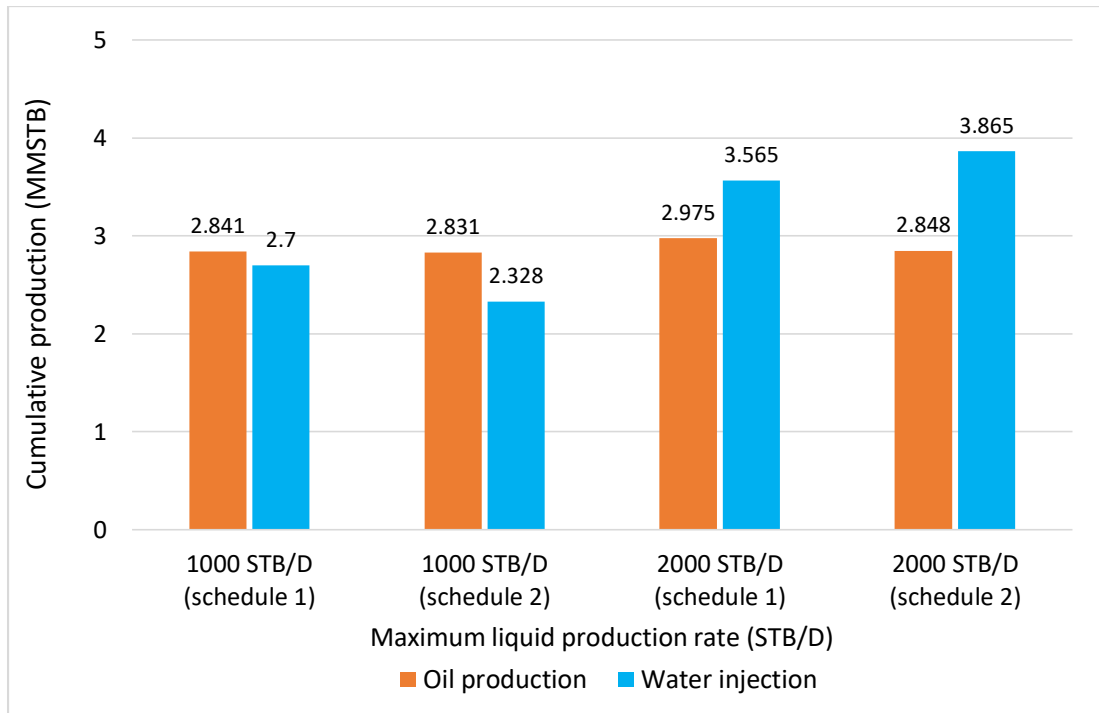

Figure 5-70 Cumulative oil productions and water injections of highest oil recovery cases from maximum liquid production rates of 1000 and 2000 STB/D of combined method from 50PV aquifer for well option 2

### 5.4.3 Effect of water dumping and injection schedule for well option 3

#### a) Maximum liquid production rate of 1000 STB/D

As summarized in Table 5-19, schedule 1 with late injection (1060 and 300 psia abandonment aquifer pressure) and schedule 3 are not applicable because of large aquifer size that can deliver water to the reservoir without having much aquifer pressure decline. From Figure 5-71 and Figure 5-72, reservoir pressure of schedule 1 drops below that of schedule 2 since the beginning because the total water cross flow rate from the aquifer of both dumping wells is relatively less than that of the schedule 2 with one all-time dumping and injection well. Then, this reservoir pressure drops to another trend due to sharp decline of bottom hole pressure of producer, resulting in high gas-oil ratio as shown in Figure 5-73. Finally, the injection begins at 6.47 years of production, leading to slower decline of the reservoir pressure. On the other hand, one all-time injector of schedule 2 that injects 500 STB/D of water constantly can

deliver more pressure support, resulting in slowly decline of the reservoir pressure until the production ends. As a result, the oil production rate of schedule 1 is below the trend of schedule 2 as shown in Figure 5-74.

Table 5-19 Results of different water dumping and injection schedules for well option 3 in 50PV aquifer size with maximum liquid production rate of 1000 STB/D

Dumping injection schedule	Abandonment aquifer pressure (psia)	Total oil production (MMSTB)	Total water production (MMSTB)	Total water injection (MMSTB)	Total water dumped (MMSTB)	Recovery factor (%)	Production time (years)
1	1820	2.704	1.119	1.481	2.097	42.45	10.51
	1060	N/A	N/A	N/A	N/A	N/A	N/A
	300	N/A	N/A	N/A	N/A	N/A	N/A
2	-	2.829	1.199	2.025	2.035	44.41	11.09
3	1820	N/A	N/A	N/A	N/A	N/A	N/A
	1060	N/A	N/A	N/A	N/A	N/A	N/A
	300	N/A	N/A	N/A	N/A	N/A	N/A

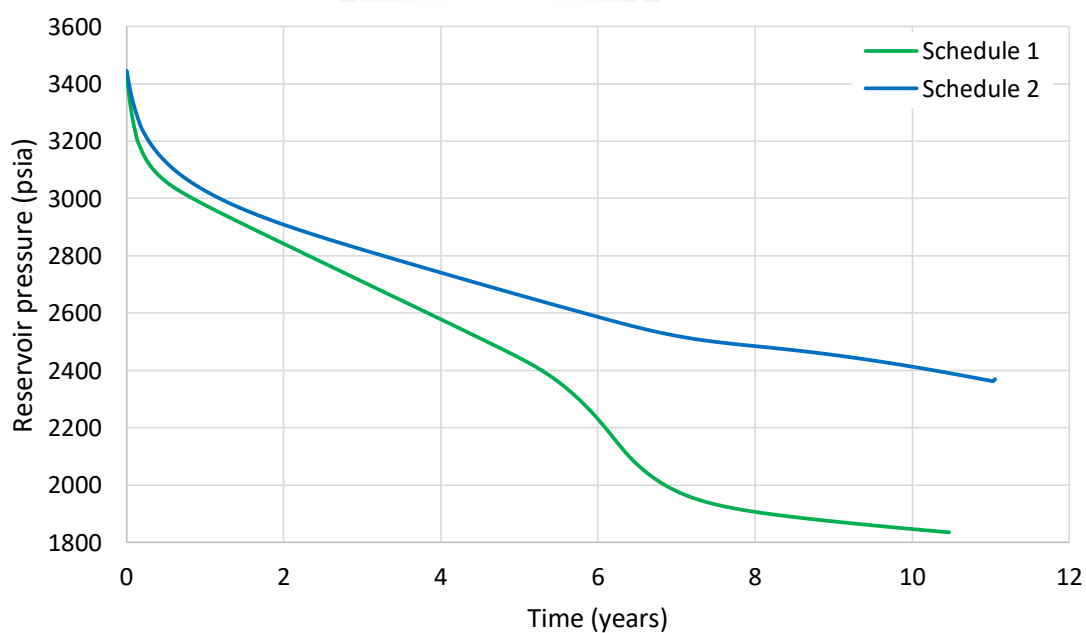

Figure 5-71 Reservoir pressures of schedules 1 and 2 of combined method from 50PV aquifer for well option 3 with maximum liquid production rate of 1000 STB/D



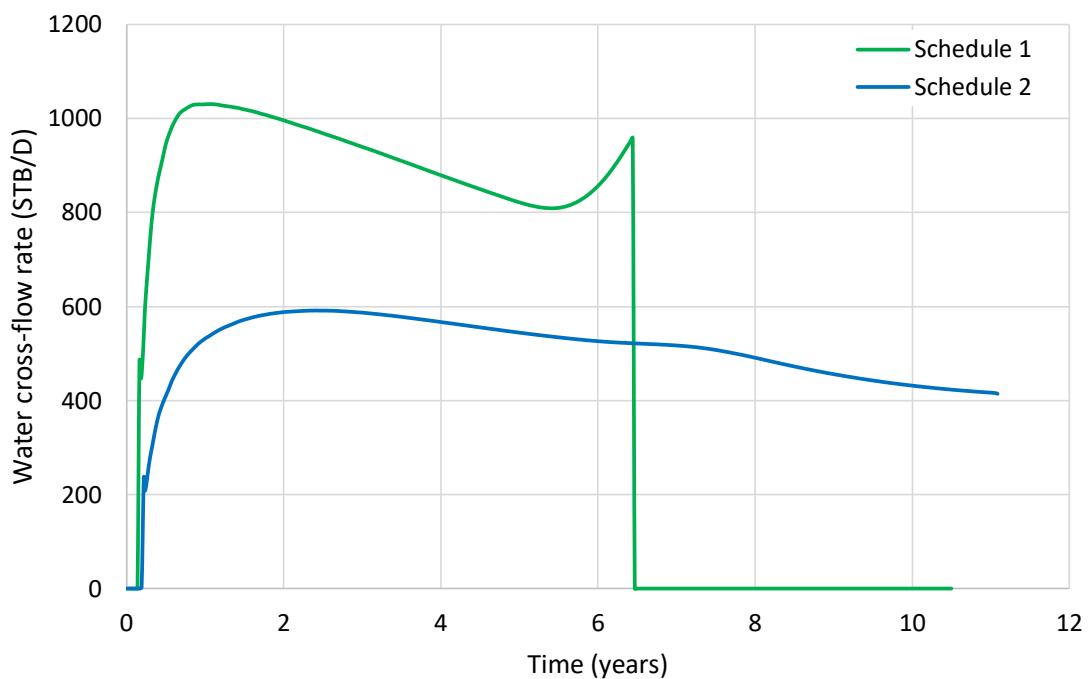

Figure 5-72 Water cross-flow rates of schedules 1 and 2 of combined method from 50PV aquifer for well option 3 with maximum liquid production rate of 1000 STB/D

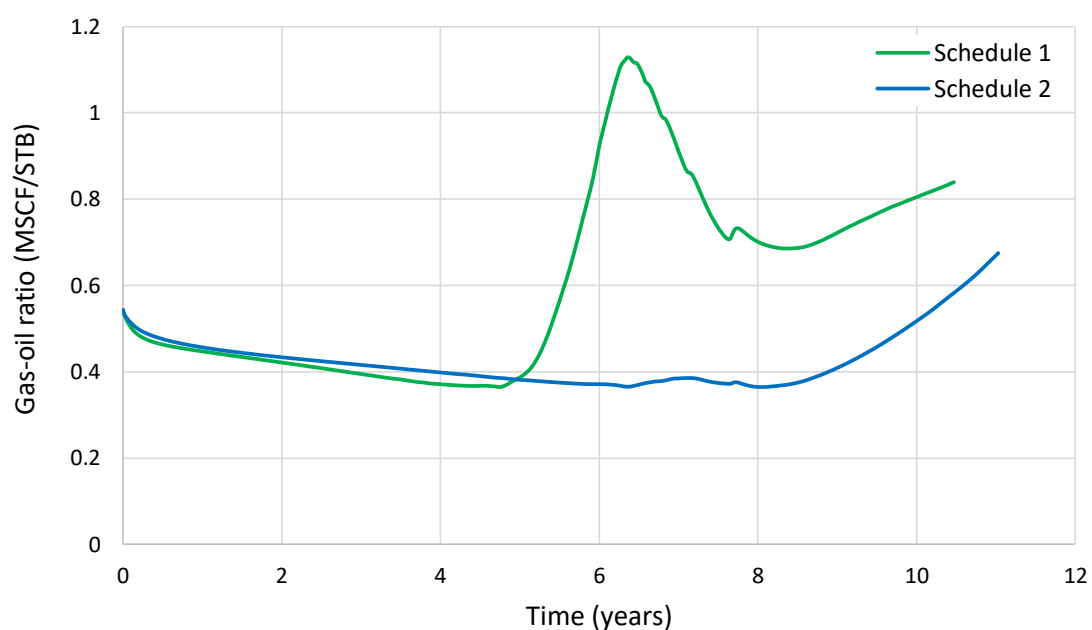

Figure 5-73 Gas-oil ratio of schedules 1 and 2 of combined method from 50PV aquifer for well option 3 with maximum liquid production rate of 1000 STB/D

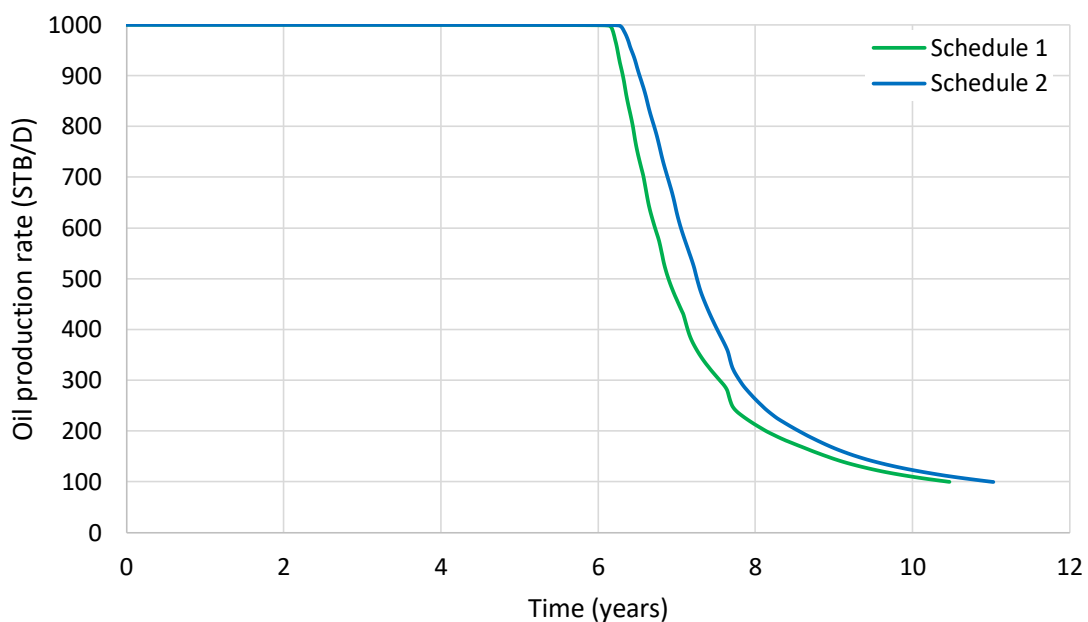

Figure 5-74 Oil production rates of schedules 1 and 2 of combined method from 50PV aquifer for well option 3 with maximum liquid production rate of 1000 STB/D

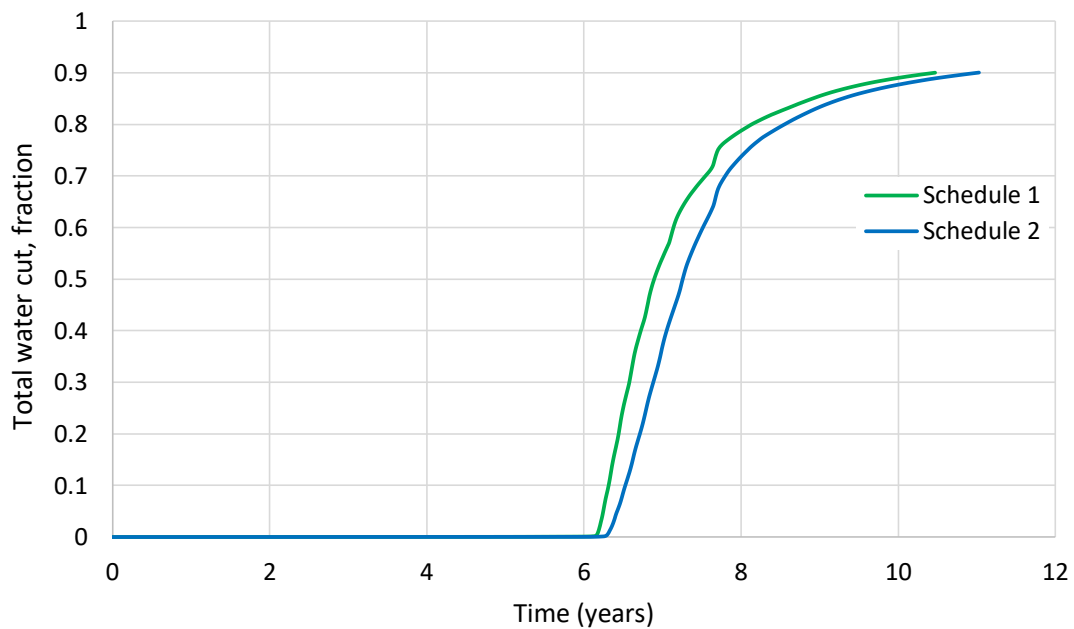

Figure 5-75 Total water cuts of schedules 1 and 2 of combined method from 50PV aquifer for well option 3 with maximum liquid production rate of 1000 STB/D

Water injection of schedule 1 is much lower than that of schedule 2 because the injection begins at late time as a result of low pressure decline of aquifer. Water breakthrough of schedule 1, as shown in Figure 5-75, occurs early and increases faster, leading to 90% maximum water cut at early time compared to schedule 2. As a result, schedule 1 produces slightly less amount of water. Note that water breakthrough in schedule 2 happens later than schedule 1 because its one all-time dumping well can also deliver water cross flow rate of 500 STB/D or more at early time of production.

*b) Maximum liquid production rate of 2000 STB/D*

In the case of maximum liquid production rate of 2000 STB/D for well option 3, only schedule 1 with early injection (1820 psia abandonment aquifer pressure) and schedule 2 are applicable. Table 5-20 shows that oil recovery factor of schedule 2 is 41.02% and is slightly higher than that of schedule 1 of 39.89%. Figure 5-76 clearly illustrates that the oil production rate of schedule 1 with maximum liquid production rate of 2000 STB/D falls sharply and early than that of schedule 2. The reason is that accelerated production from horizontal producer results in sharp decline of reservoir pressure since the beginning and gradually decreases to another steeper trend when the reservoir pressure is no longer sufficient to support that high liquid rate as shown in Figure 5-77. The oil rate of schedule 1 then increases a little bit as a result of increasing of water cross-flow and continues to drop steadily when water breakthrough occurs. The conversion of both dumping wells to injectors at 3.69 years of production has insignificant effect to the oil production rate.

In the case of schedule 2, the oil production rate can stay at the plateau for 2.75 years of production due to high water injection rate from one all-time injector, leading to slower reservoir pressure decline. This oil rate then falls sharply because of insufficient long-term pressure support and drops to another trend due to water breakthrough at 2.86 years of production.

Table 5-20 Results of different water dumping and injection schedules for well option 3 in 50PV aquifer size with maximum liquid production rate of 2000 STB/D

Dumping injection schedule	Abandonment aquifer pressure (psia)	Total oil production (MMSTB)	Total water production (MMSTB)	Total water injection (MMSTB)	Total water dumped (MMSTB)	Recovery factor (%)	Production time (years)
1	1820	2.542	1.169	1.462	2.081	39.89	5.67
	1060	N/A	N/A	N/A	N/A	N/A	N/A
	300	N/A	N/A	N/A	N/A	N/A	N/A
2	-	2.614	1.156	1.947	1.747	41.02	5.33
3	1820	N/A	N/A	N/A	N/A	N/A	N/A
	1060	N/A	N/A	N/A	N/A	N/A	N/A
	300	N/A	N/A	N/A	N/A	N/A	N/A

In well option 3, in which dumping or injection well(s) are vertical wells, water cross-flow from the aquifer into the reservoir is not that high compared to horizontal dumping or injection well(s). As a result, aquifer pressure drop is slower and takes time to attain the abandonment aquifer pressure. Schedule 1 in this case requires relatively less water injection compared to schedule 2 because of late conversion of both dumping wells to injectors. However, water production of schedule 1 is slightly higher than that of schedule 2. In opposite to the case with maximum liquid production rate of 1000 STB/D, water breaks through the producer quite early in the case of schedule 2, as shown in Figure 5-78, because one all-time dumping well provides lower water dumping rate than 1000 STB/D which results in rapid moment of injection water from one all-time injector.

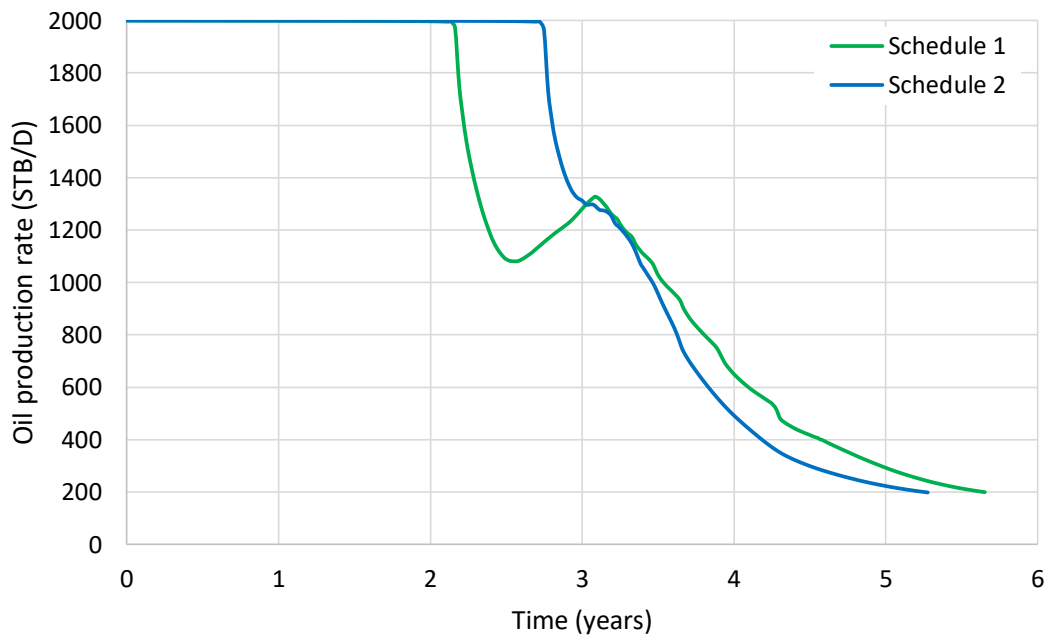

Figure 5-76 Oil production rates of schedules 1 and 2 of combined method from 50PV aquifer for well option 3 with maximum liquid production rate of 2000 STB/D

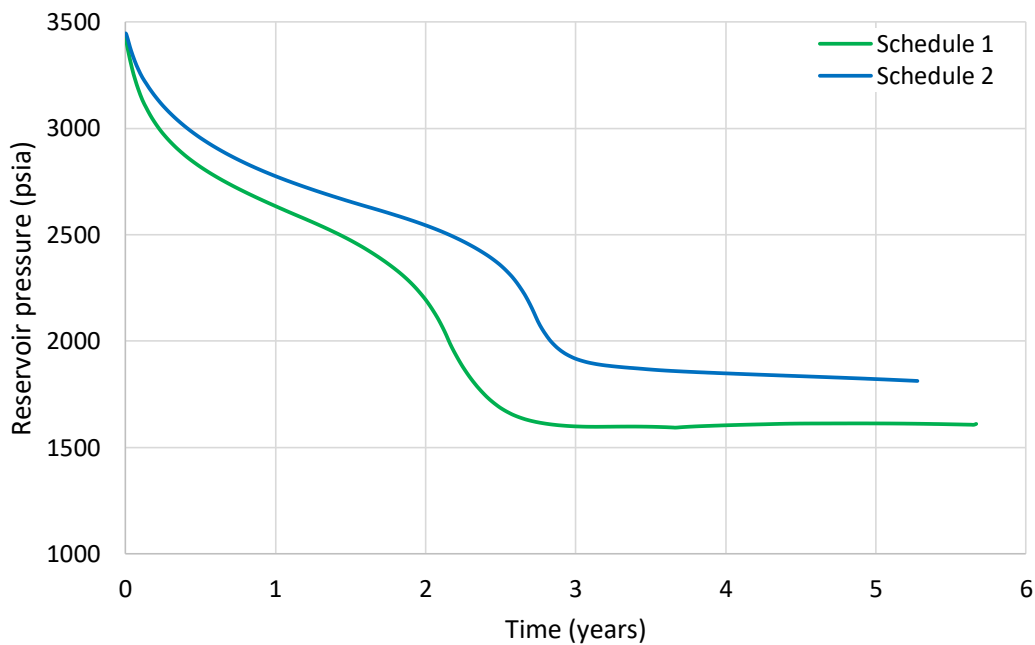

Figure 5-77 Reservoir pressures of schedules 1 and 2 of combined method from 50PV aquifer for well option 3 with maximum liquid production rate of 2000 STB/D

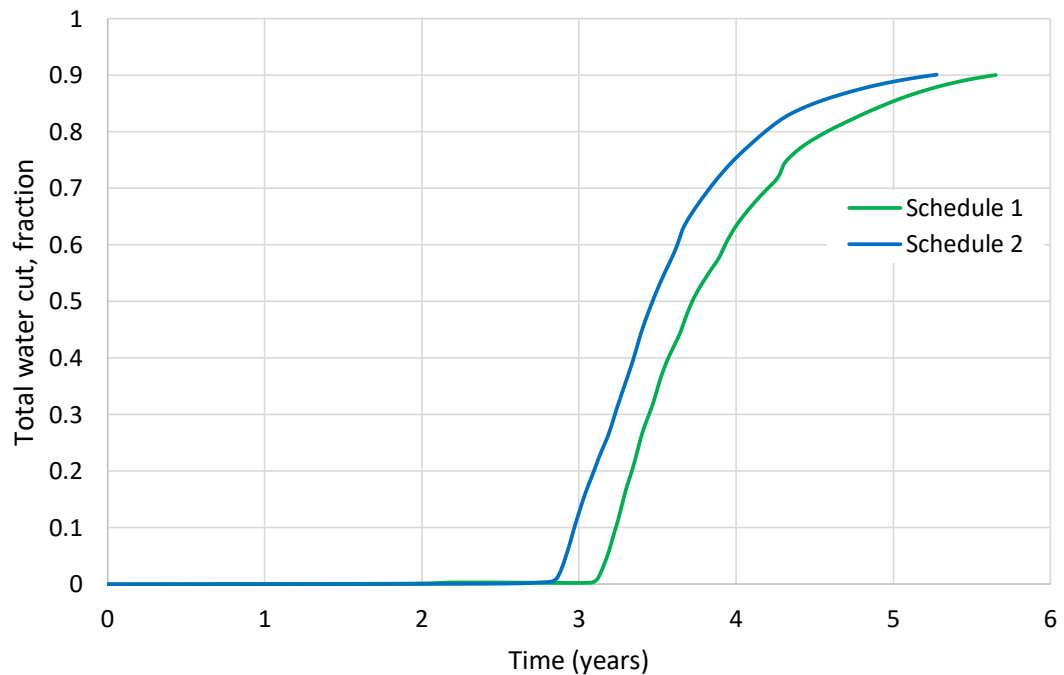

Figure 5-78 Total water cuts of schedules 1 and 2 of combined method from 50PV aquifer for well option 3 with maximum liquid production rate of 2000 STB/D

*c) Comparison between cases with maximum liquid production rate of 1000 and 2000 STB/D*

As depicted in Figure 5-79, either schedules 1 or 2 of well option 3 with maximum liquid production rate of 1000 STB/D provides the highest oil recovery factor and slightly higher amount of injected water compared to those with maximum liquid production rate of 2000 STB/D. If the injection facility is ready since the beginning of production, schedule 2 of 1000 STB/D maximum liquid production rate is recommended because it yields better oil recovery.

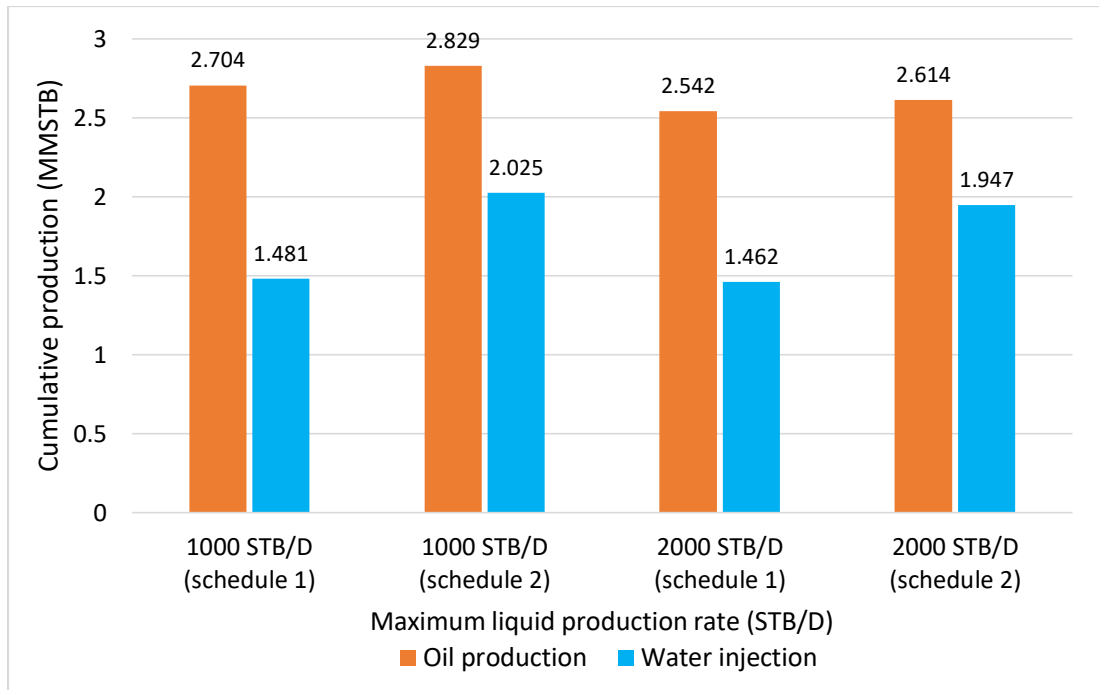

Figure 5-79 Cumulative oil productions and water injections of highest oil recovery cases from maximum liquid production rates of 1000 and 2000 STB/D of combined method from 50PV aquifer for well option 3

#### 5.4.4 Effect of water dumping and injection schedule for well option 4

##### a) Maximum liquid production rate of 1000 STB/D

As summarized in Table 5-21 and illustrated in Figure 5-80, oil recovery factors of schedules 2 and 3 are approximately the same and higher when dumping well is converted to injector at early abandonment aquifer pressure of 1820 psia. Note that aquifer pressure in schedules 1 and 3 never reach 1060 and 300 psia since the aquifer is large and the well which is designed as one all-time injector (schedule 3) slows down the decline in reservoir pressure. For well option 4 in which both producer and injection/dumping well(s) are horizontal wells, the oil production rates of the three schedules are at the plateau for long period of time as shown in Figure 5-81. After that, the oil production rates drop sharply as a result of water breakthrough. In the case of schedule 1, water cross-flow rate from both dumping wells is generally around 1000 STB/D while the rate of schedules 2 and 3 from one dumping well alone is around 600 STB/D as depicted in Figure 5-82. As a result, dumped water from one dumping well

breaks through the producer early in the case of schedules 2 and 3 as illustrated in Figure 5-83 and Figure 5-84. Water breakthrough of schedule 1 happens right after the injection begins, leading to a very sharply decrease of oil production rate. In schedules 2 and 3, total water dumping with injection rate is higher than 1000 STB/D. Thus, the reservoir pressure drop is slower, and more oil can be produced for slightly longer production time.

Table 5-21 Results of different water dumping and injection schedules for well option 4 in 50PV aquifer size with maximum liquid production rate of 1000 STB/D

Dumping injection schedule	Abandonment aquifer pressure (psia)	Total oil production (MMSTB)	Total water production (MMSTB)	Total water injection (MMSTB)	Total water dumped (MMSTB)	Recovery factor (%)	Production time (years)
1	1820	2.702	1.070	1.530	2.147	42.42	10.34
	1060	N/A	N/A	N/A	N/A	N/A	N/A
	300	N/A	N/A	N/A	N/A	N/A	N/A
2	-	2.806	1.171	1.993	2.156	44.04	10.92
3	1820	2.805	1.162	2.019	2.135	44.03	10.92
	1060	N/A	N/A	N/A	N/A	N/A	N/A
	300	N/A	N/A	N/A	N/A	N/A	N/A

Water injection and water production in the case of schedule 1 are much lower than other two schedules because the injection begins at late time. Schedules 2 and 3 have exactly the same trend and only small difference is observed at the end of production. In summary, schedule 2 yields the highest oil recovery, and schedule 3 is not recommended because the conversion of dumping well to injector is quite late.



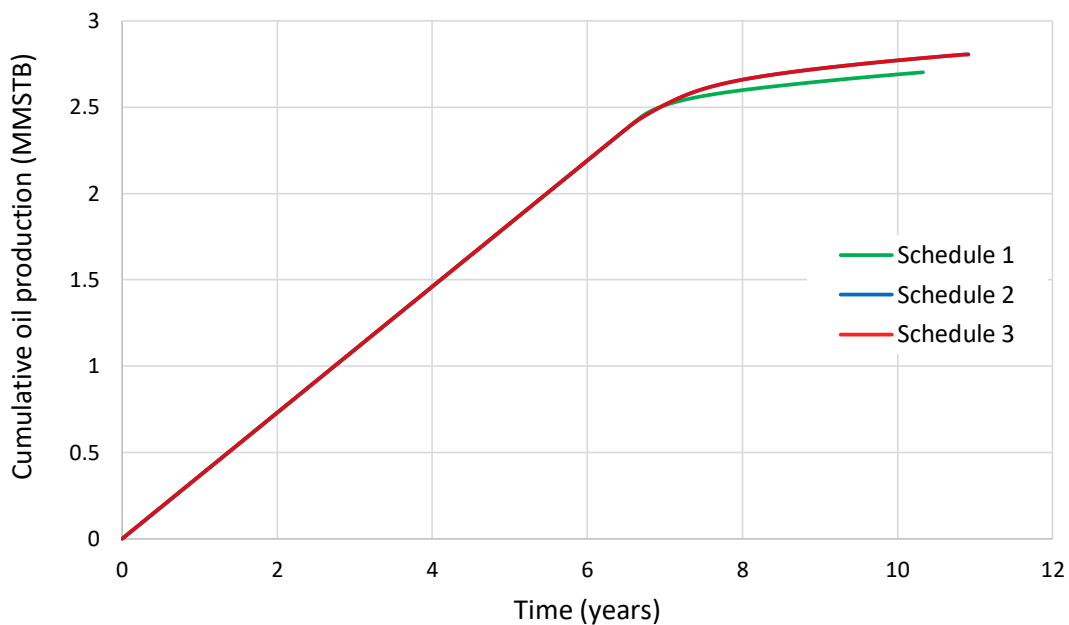

Figure 5-80 Cumulative oil production of schedules 1, 2 and 3 of combined method from 50PV aquifer for well option 4 with maximum liquid production rate of 1000 STB/D

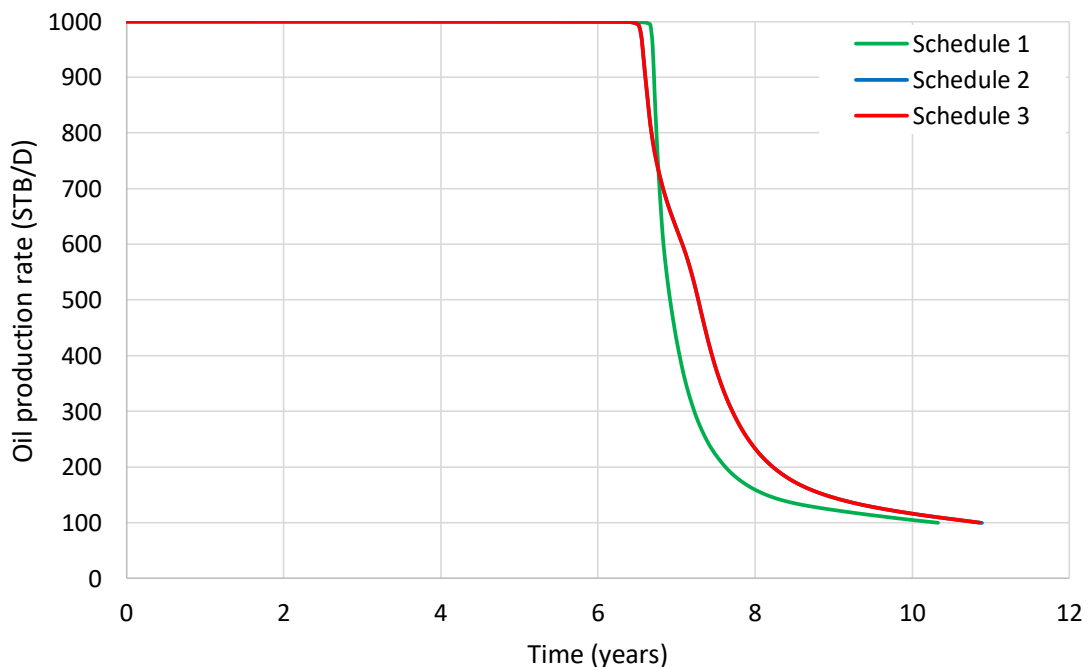

Figure 5-81 Oil production rates of schedules 1, 2 and 3 of combined method from 50PV aquifer for well option 4 with maximum liquid production rate of 1000 STB/D

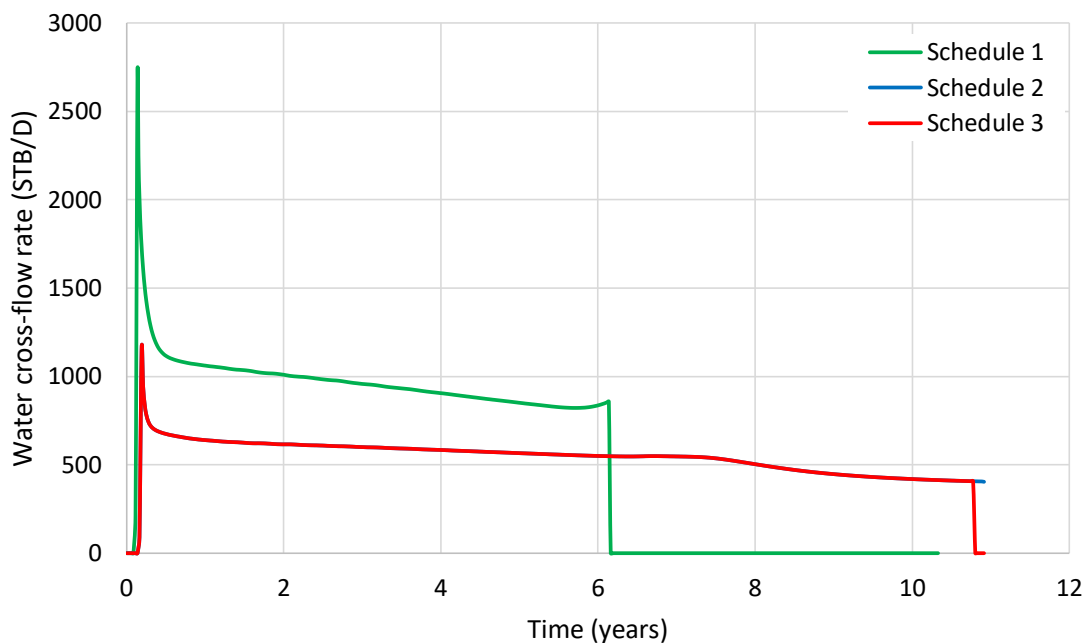

Figure 5-82 Water cross-flow rates of schedules 1, 2 and 3 of combined method from 50PV aquifer for well option 4 with maximum liquid production rate of 1000 STB/D

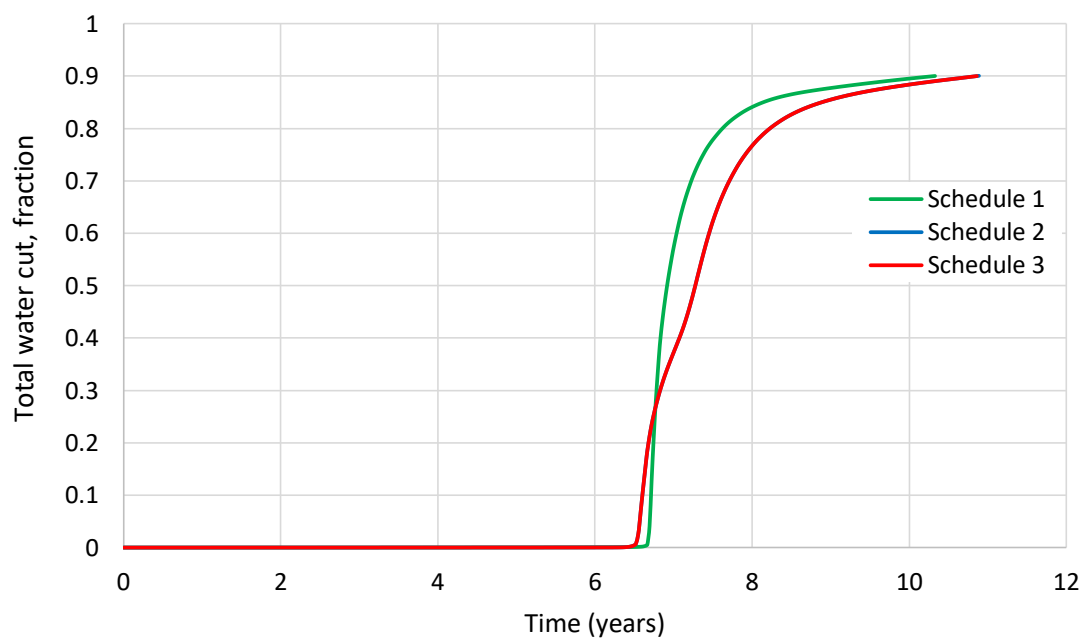

Figure 5-83 Total water cuts of schedules 1, 2 and 3 of combined method from 50PV aquifer for well option 4 with maximum liquid production rate of 1000 STB/D

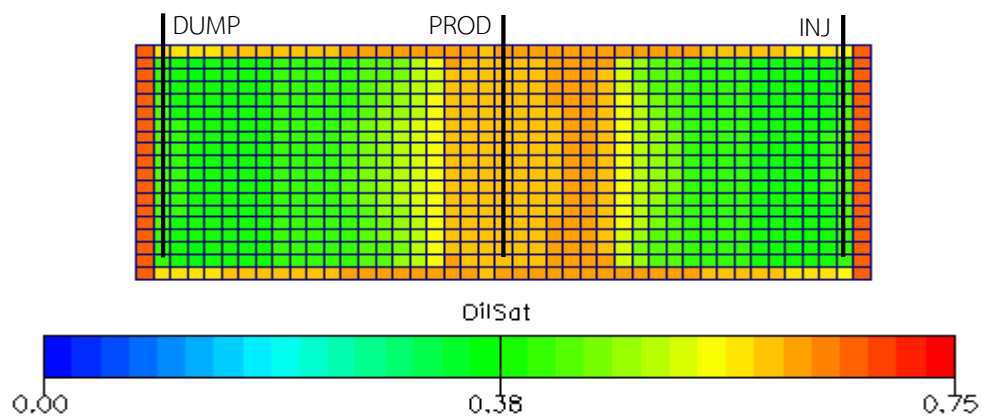

Figure 5-84 Top view of oil saturation profile of schedule 1 of combined method from 50PV aquifer for well option 1 with maximum liquid production rate of 1000 STB/D at 10 years of production

*b) Maximum liquid production rate of 2000 STB/D*

As summarized in Table 5-22, there are only two cases that are applicable which are schedule 1 with early injection (1820 psia abandonment aquifer pressure) and schedule 2. Oil recovery factor of schedule 2 with high liquid production rate is still the highest compared to schedule 1. As depicted in Figure 5-85, the oil production rate of schedule 1 drops dramatically at early time as a result of accelerated production from horizontal producer that leads to rapid reservoir pressure decline. Then, the oil rate starts to increase sharply for a period of time due to high water cross-flow during the rapid reservoir pressure decline and the conversion of dumping wells to injectors. Later on, the rate drops again due to water breakthrough as shown in Figure 5-86.

For schedule 2 in which one all-time dumping and injection wells are used, the oil production rate remains at the plateau for longer time compared to schedule 1 due to high water injection rate since the beginning. This results in smaller reservoir pressure decline. The rate then increases for a short time and falls again as water breakthrough occurs. Finally, this rate falls sharply because of higher water production that mainly comes from the one all-time dumping well that deliver water more than 1000 STB/D as shown in Figure 5-87.

Table 5-22 Results of different water dumping and injection schedules for well option 4 in 50PV aquifer size with maximum liquid production rate of 2000 STB/D

Dumping injection schedule	Abandonment aquifer pressure (psia)	Total oil production (MMSTB)	Total water production (MMSTB)	Total water injection (MMSTB)	Total water dumped (MMSTB)	Recovery factor (%)	Production time (years)
1	1820	2.482	0.978	1.324	2.134	38.96	5.09
	1060	N/A	N/A	N/A	N/A	N/A	N/A
	300	N/A	N/A	N/A	N/A	N/A	N/A
2	-	2.567	0.791	1.705	1.812	40.29	4.67
3	1820	N/A	N/A	N/A	N/A	N/A	N/A
	1060	N/A	N/A	N/A	N/A	N/A	N/A
	300	N/A	N/A	N/A	N/A	N/A	N/A

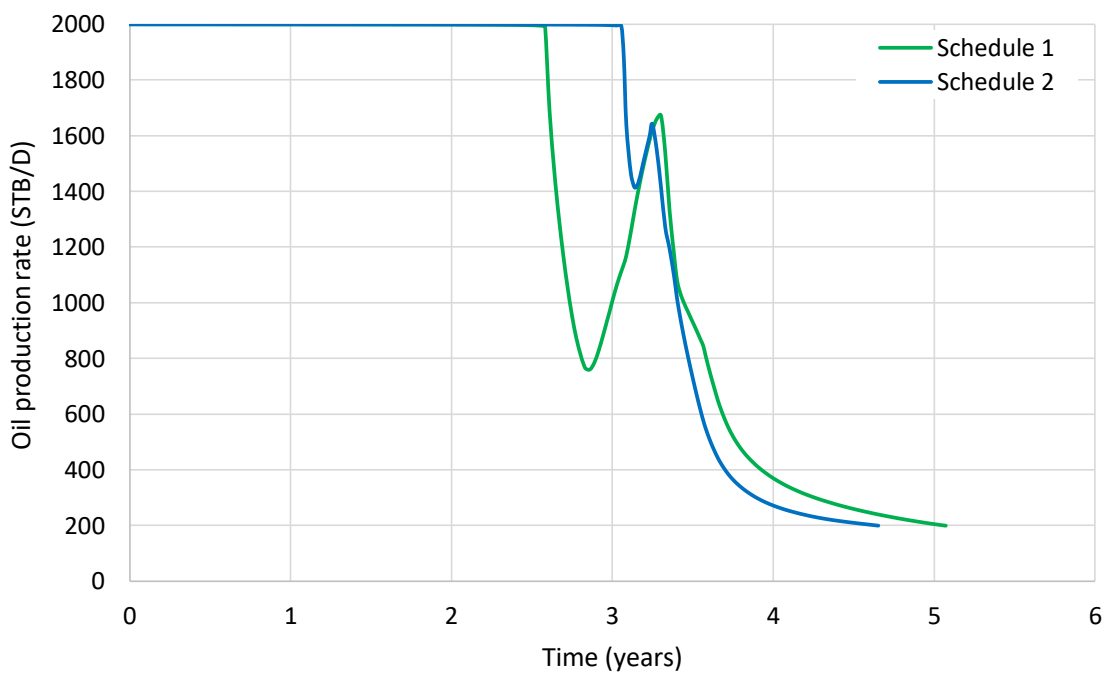

Figure 5-85 Oil production rates of schedules 1 and 2 of combined method from 50PV aquifer for well option 4 with maximum liquid production rate of 2000 STB/D

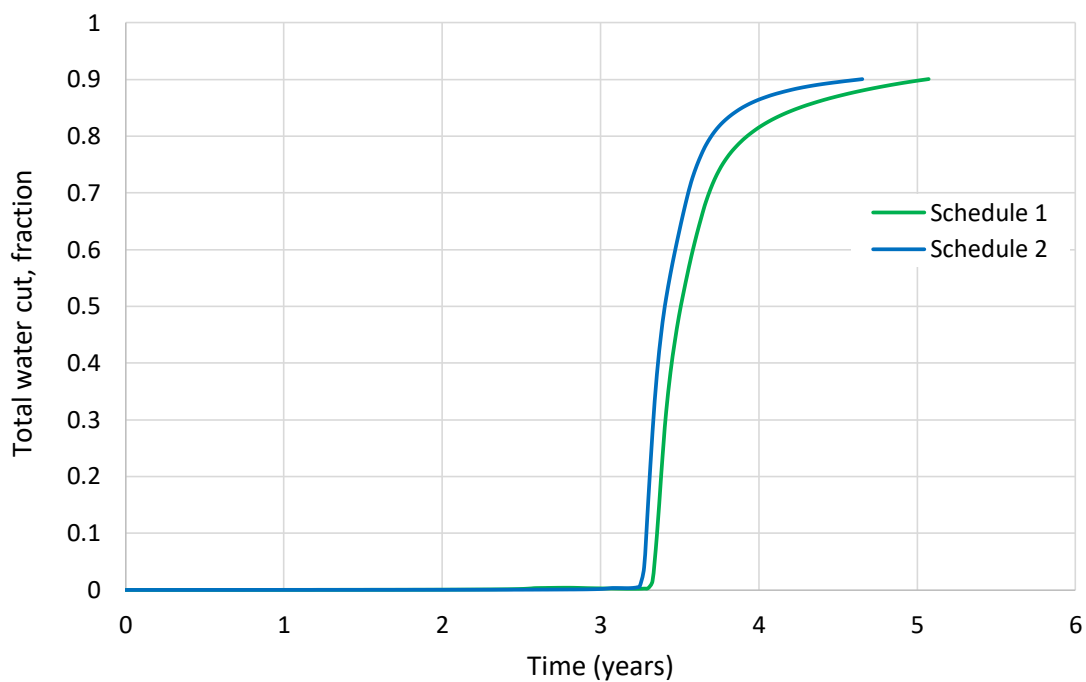

Figure 5-86 Total water cuts of schedules 1 and 2 of combined method from 50PV aquifer for well option 4 with maximum liquid production rate of 2000 STB/D

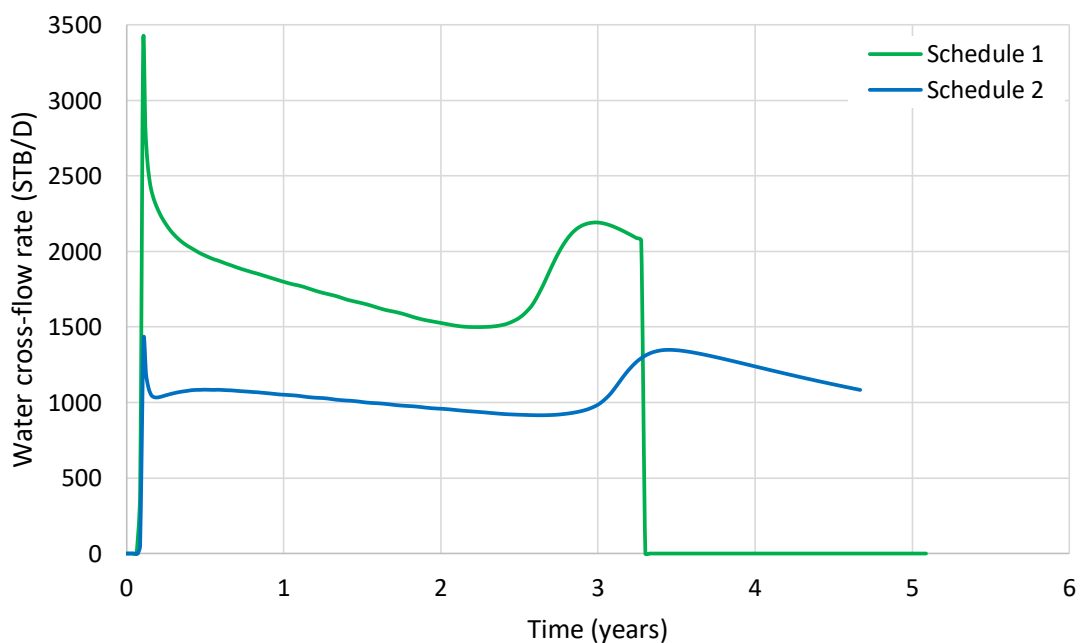

Figure 5-87 Water cross-flow rates of schedules 1 and 2 of combined method from 50PV aquifer for well option 4 with maximum liquid production rate of 2000 STB/D

Schedule 1 provides slightly less oil recovery factor but also requires much lower water injection compared to schedule 2 due to the fact that the conversion of both dumping wells to injectors is started at late time of production. However, water production of schedule 1 is slightly higher since the production time is longer than that of schedule 2.

*c) Comparison between cases with maximum liquid production rate of 1000 and 2000 STB/D*

As illustrated in Figure 5-88, both schedules 1 and 2 with maximum liquid production rate of 1000 STB/D yield higher oil recovery factors and require more water injection than those of 2000 STB/D maximum liquid production rate. In term of oil production, either schedule 1 or 2 with maximum liquid production rate of 1000 STB/D can be implemented but schedule 2 is recommended if injection can begin since the beginning of production. However, the cases with maximum liquid production rate of 2000 STB/D require less production time.

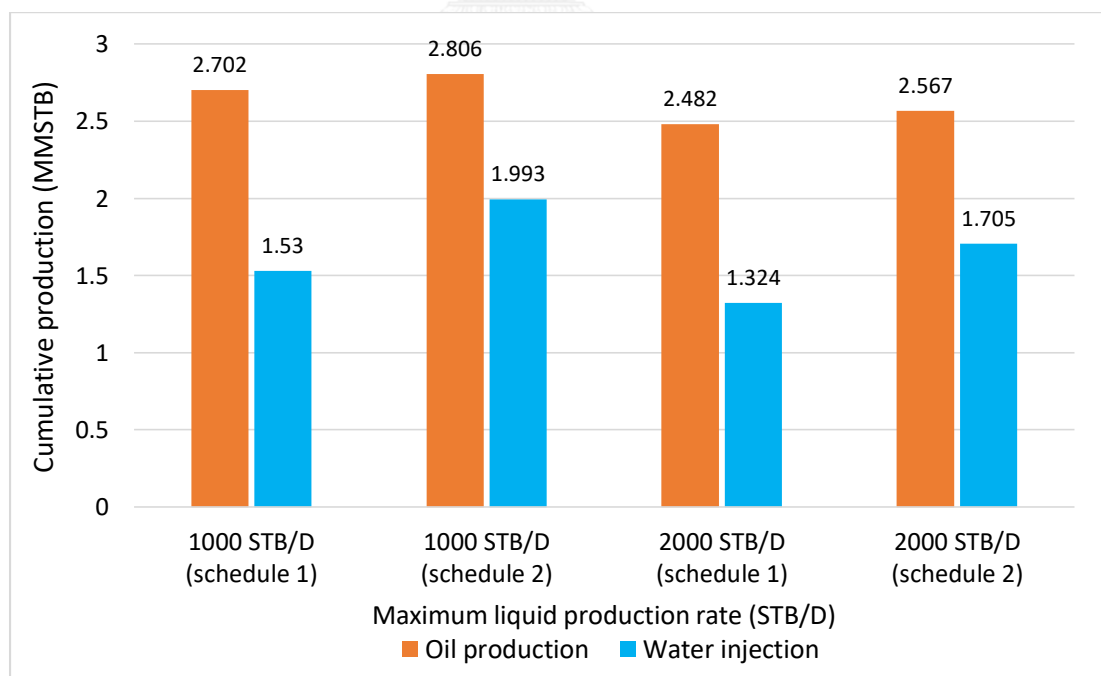

Figure 5-88 Cumulative oil productions and water injections of highest oil recovery cases from maximum liquid production rates of 1000 and 2000 STB/D of combined method from 50PV aquifer for well option 4

#### 5.4.5 Comparison among different well options

The comparison among well options 1, 2, 3 and 4 in term of oil production and water injection are summarized in Figure 5-89. Well option 1 provides the highest oil production of 3.069 MMSTB and requires the highest water injection of 4.129 MMSTB when maximum liquid production rate of 2000 STB/D with schedule 1 is used. In the case of well option 2 where maximum liquid production rate of 2000 STB/D with schedule 1 is implemented, the oil production is 2.975 MMSTB and water injection is 3.565 MMSTB which are 0.094 and 0.564 MMSTB of oil and water lower than those of schedule 1, respectively. Well options 3 and 4 have approximately the same oil production and water injection. These oil productions are relatively less compared to well options 1 and 2 but the amounts of water injection are also much lower.

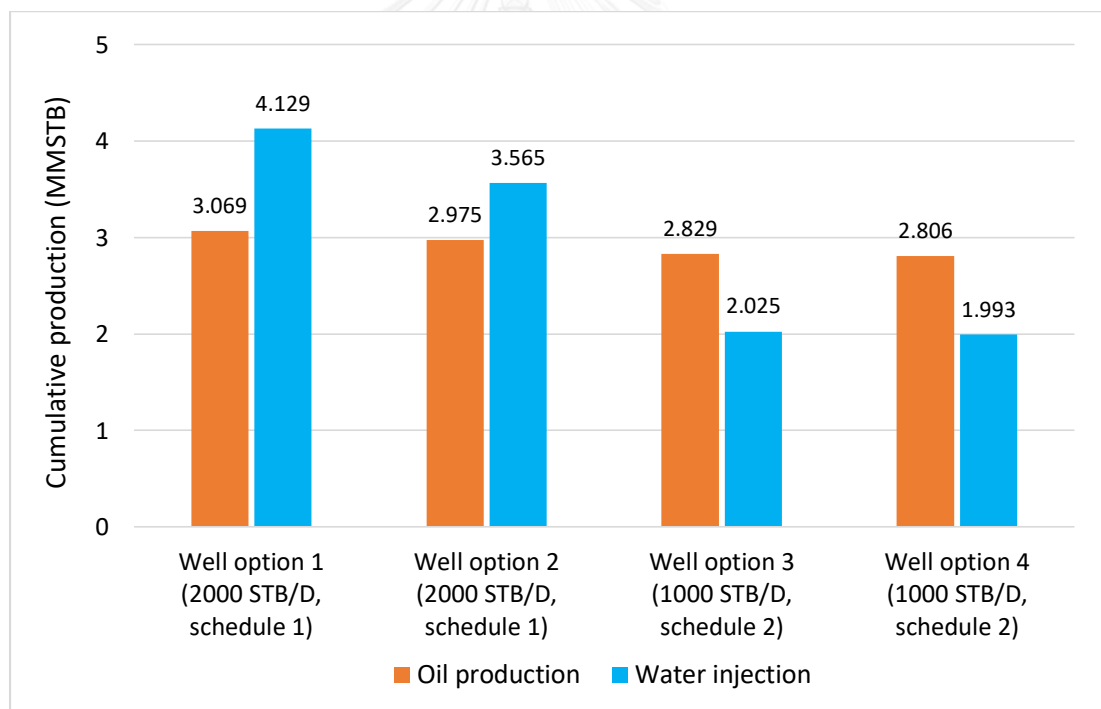

Figure 5-89 Cumulative oil productions and water injections of four well options of combined method from 50PV aquifer

### 5.5 Comparison between conventional water injection, water dumpflood, and combined water dumpflood with water injection

The simulation results of conventional water injection as discussed in section 5.1 show that well option 1 with maximum liquid production rate of 2000 STB/D yields the highest oil production of 3.064 MMSTB with total water injection of 6.269 MMSTB. For water dumpflood from 10PV aquifer, well option 3 with maximum liquid production rate of 2000 STB/D provides total oil production of 1.859 MMSTB which is higher than that of well options 1 and 2 of 0.092 and 0.018 MMSTB, respectively. But, it is lower than that of well option 4 of 0.099 MMSTB. However, this well option 3 is the good choice because it has only one horizontal well compared to well option 4 in which all three wells are horizontal. In the case of water dumpflood from 50PV aquifer, well option 1 with maximum liquid production rate of 2000 STB/D is recommended as it yields higher oil production and less water production compared to those of 1000 STB/D maximum liquid production rate.

The comparison between different approaches is summarized in Figure 5-90 and Table 5-23. For combined water dumpflood from 10PV aquifer with water injection, well option 1 with maximum liquid production rate of 2000 STB/D and well schedule 1 gives the highest oil recovery factor compared to the best case of water dumpflood technique from 10PV aquifer. However, this combined method also produces large amount of water and tremendous amount of water injection of 5.698 MMSTB is required. When the combined method from 10PV aquifer is compared with conventional water injection, well option 1 in the combined method is even slightly better because it yields slightly higher oil recovery than that of conventional water injection. Moreover, water production is also lower in the case of combined method and amount of water injection can be reduced as much as 5.698 MMSTB in comparison to 6.269 MMSTB for conventional water injection.

Combined water dumpflood from 50PV aquifer with water injection also provides significant benefit compared to water dumpflood from 50PV aquifer and conventional water injection technique. As illustrated in Table 5-23, water dumpflood from 50PV aquifer gives the highest oil recovery of 42.57% and 1.401 MMSTB of



produced water. On the other hand, well option 1 with maximum liquid production rate of 2000 STB/D and well schedule 1 of combined method from 50PV aquifer provides the highest oil recovery of 48.19%. It is clearly seen that combined method generates more oil recovery but the amounts of water production and injection are also larger than that of water dumpflood. With the best case of conventional water injection, the well option 1 of combined method from 50PV aquifer provides very slightly higher oil recovery and water production compared to that of conventional water injection. The benefit is that the water injection of combined method is only 4.129 MMSTB which is much lower in comparison to 6.269 MMSTB of convention water injection.

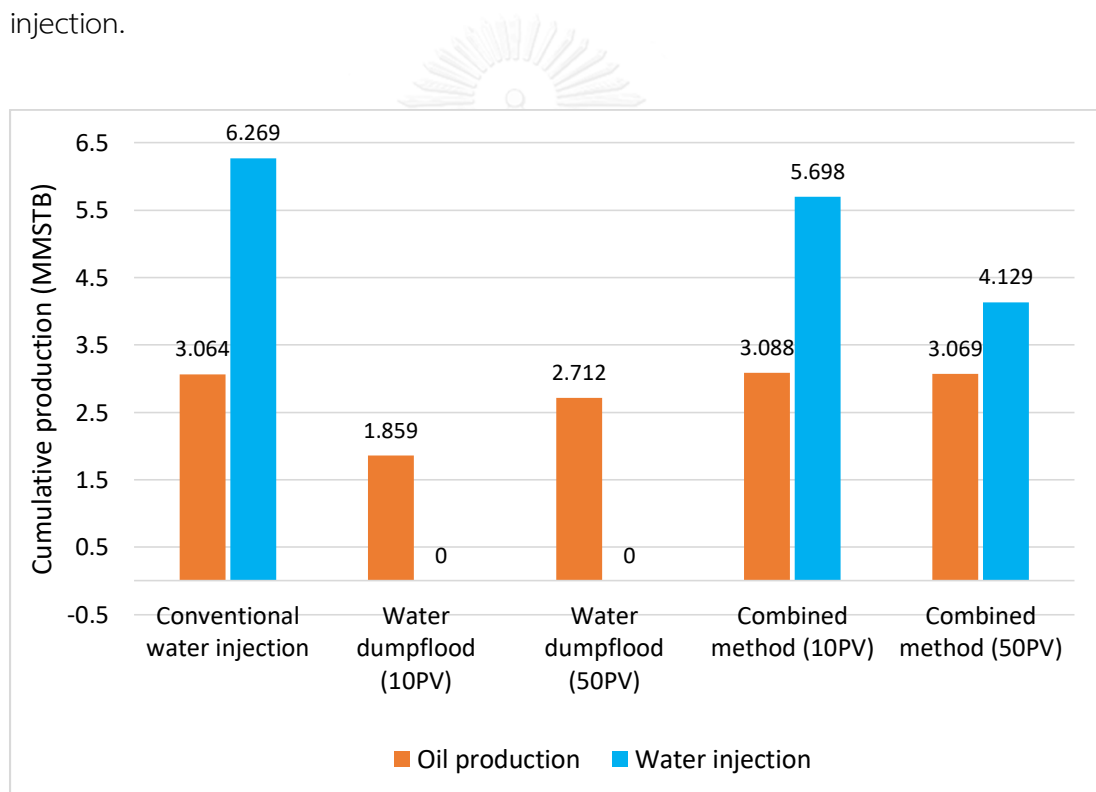

Figure 5-90 Cumulative oil productions and water injections of conventional injection, water dumpflood, and combined water dumpflood with water injection

Table 5-23 Comparison results of different approaches of conventional injection, water dumpflood, and combined water dumpflood with water injection

Production strategy	Well option	Schedule, liquid rate (STB/D)	Total oil production (MMSTB)	Total water production (MMSTB)	Total water injection (MMSTB)	Total water dumped (MMSTB)	Recovery factor (%)	Production time (years)
Conventional injection	1	2000	3.064	2.333	6.269	-	48.09	8.59
10PV Water dumpflood	3	2000	1.859	0.006	-	1.256	29.19	8.17
50PV Water dumpflood	1	2000	2.712	1.401	-	3.765	42.57	15.34
Combined method (10PV)	1	Schedule1, 2000	3.088	2.224	5.698	0.435	48.47	9.67
Combined method (50PV)	1	Schedule1, 2000	3.069	2.371	4.129	2.093	48.19	11.51

\*Note the abandonment aquifer pressure is 1820 psia.

## CHAPTER 6

### CONCLUSIONS AND RECOMMENDATIONS

This chapter presents the summaries of the simulation study including the effect of maximum liquid production rate and well option on conventional water injection and water dumpflood, and the effect of water dumping and injection schedule for each well option in the combined water dumpflood from 10PV and 50PV aquifer with water injection.

#### 6.1 Conclusions

From results and discussions in Chapter 5, the conclusions can be drawn and summarized as follows:

- 1) For conventional water injection, a combination of one vertical producer and two vertical injectors yields the highest oil recovery factor of 46.65% and 48.09% in cases with low and high liquid production rates of 1000 and 2000 STB/D, respectively. The reason is that vertical injectors gradually sweep the oil from the edges of the reservoir into the vertical producer, resulting in a gradual increase in water cut at the producer and leading to slower decline of oil production rate until the water cut reaches 90% cut-off. When maximum liquid production rate is increased to high rate of 2000 STB/D, more oil recovery is obtained as a result of better sweep efficiency that overcomes the gravity segregation between injected water and the reservoir oil.
- 2) For water dumpflood from 10PV aquifer, a combination of one horizontal producer and two vertical dumping wells with high liquid production rate of 2000 STB/D is recommended as it provides higher oil recovery (29.19% recovery factor) compared to the other two combinations with vertical producers. This well has oil recovery factor of 1.55% lower than that of well option 4 (30.74%) which is combination of one horizontal producer and two horizontal dumping wells but it requires only one horizontal producer in comparison to 3 horizontal wells in well option 4. High liquid production rate of 2000 STB/D with recovery factor of 29.19% is a good choice as it

- yields approximately the same oil recovery with short production time than that of low liquid production rate of 1000 STB/D which yields 29.03% recovery factor. In summary, oil production of water dumpflood from 10PV aquifer mainly depends on the better productivity of horizontal producer and high liquid rate.
- 3) For water dumpflood from 50PV aquifer, a combination of one vertical producer and two vertical dumping wells (42.57%) with high liquid production rate of 2000 STB/D is a good option because high liquid drawdown results in high water cross-flow from the big aquifer and small increment of water cut, resulting in more oil production.
  - 4) In the case of combined water dumpflood from small aquifer (10PV), a combination of one vertical producer and two vertical dumping/injection wells with high liquid production rate of 2000 STB/D and schedule 1 which is to set two wells to be dumping wells and later convert them to injection wells provides the highest oil recovery (48.47%) because of early water injection from both dumping wells and good sweep efficiency from high injection rate. This recovery is 19.28% and 0.38% higher than those of dumpflood from 10PV aquifer and conventional water injection, respectively. Total water injection can be reduced as much as 0.571 MMSTB compared to conventional injection.
  - 5) In the case of combined water dumpflood from large aquifer (50PV), a combination of one vertical producer and two vertical dumping/injection wells with high liquid production rate of 2000 STB/D and schedule 1 which is to set two wells to be dumping wells and later convert them to injection wells also provides the highest oil recovery which is similar to combined method from 10PV aquifer. It yields 5.62% and 0.1% of oil recovery factors higher than those of dumpflood from 50PV aquifer and conventional water injection, respectively. In term of water injection, a combination of one vertical producer and two vertical dumping/injection wells in this combined method from 50PV aquifer requires much less amount of injected water of 4.129 MMSTB in comparison to 6.269 MMSTB of conventional water injection.
  - 6) In both aquifer sizes in this study, dumping and injection with schedule 1 and schedule 3 (one dumping well later converted to injection well and one all-time

injection well) give high oil recovery when the conversion of dumping well(s) to injection well(s) begins at early abandonment aquifer pressure (1820 psia).

## 6.2 Recommendations

Since the study focuses on the homogeneous reservoir model and simple geometry, complexity of reservoir geometry and reservoir heterogeneity are recommended for further investigation. The results from this study might be different when the new geometry and heterogeneity are included and the conclusion maybe different.



## REFERENCES

- [1] L. P. Dake, *The Practice of Reservoir Engineering (Revised Edition)* vol. 36: Elsevier, 2001.
- [2] K. Fujita, "Pressure Maintenance by Formation Water Dumping for the Ratawi Limestone Oil Reservoir, Offshore Khafji," *Journal of Petroleum Technology*, vol. 34, pp. 738-754, 1982.
- [3] R. B. Quttainah and E. Al-Maraghi, "Umm Gudair Production Plateau Extension. The Applicability of Fullfield Dumpflood Injection to Maintain Reservoir Pressure and Extend Production Plateau," in *SPE International Improved Oil Recovery Conference in Asia Pacific*, 2005.
- [4] C. O. Osharode, G. Erivona, M. Nnadi, and K. Folorunso, "Application of Natural Water Dumpflood in a Depleted Reservoir for Oil and Gas Recovery-Egbema West Example," in *Nigeria Annual International Conference and Exhibition*, 2010.
- [5] A. Anansupak, "Viability of the Water Dump Floods Technique in Got," Thesis, Chulalongkorn University, 2011.
- [6] A. J. Mendez, B. Chacin, S. Balram, and B. Smith, "Successful Application of Water Injection to Increase Oil Recovery in Boscán Field," in *SPE Latin America and Caribbean Petroleum Engineering Conference*, 2014.
- [7] R. Paige, L. Murray, J. Martins, and S. Marsh, "Optimising Water Injection Performance," in *Middle East Oil Show*, 1995.
- [8] R. Westermarck, D. Dauben, S. Robinowitz, and H. Weyland, "Enhanced Oil Recovery with Horizontal Waterflooding, Osage County, Oklahoma," in *SPE/DOE Symposium on Improved Oil Recovery*, 2004.
- [9] C. Davies, "The Theory and Practice of Monitoring and Controlling Dumpfloods," in *SPE European Spring Meeting*, 1972.
- [10] A. Satter, G. M. Iqbal, and J. L. Buchwalter, *Practical Enhanced Reservoir Engineering: Assisted with Simulation Software*: Pennwell Books, 2008.
- [11] A. T. Corey, "The Interrelation between Gas and Oil Relative Permeabilities," *Producers monthly*, vol. 19, pp. 38-41, 1954.

- [12] H. Stone, "Probability Model for Estimating Three-Phase Relative Permeability," *Journal of Petroleum Technology*, vol. 22, pp. 214-218, 1970.
- [13] A. T. Bourgoyne, K. K. Millheim, M. E. Chenevert, and F. S. Young, "Applied Drilling Engineering," 1986.
- [14] M. Rangponsumrit, "Well and Reservoir Management for Mercury Contaminated Waste Disposal," 2004.



## VITA

Mr. Kimseng Hort was born in Takeo, Cambodia in 1991. The author obtained the B.Eng. degree in Geo-resources and Geotechnical Engineering from Institute of Technology of Cambodia, Phnom Penh, Cambodia in 2015. He pursued his study at the Department of Mining and Petroleum Engineering, Chulalongkorn University, in 2015 as a full time Master's degree student in the field of petroleum engineering.

