



REFERENCES

- Ahluwalia, V.K. and Seshadri, T.R. Special chemical components of commercial woods and related materials. VI. *Tectona grandis*. J. Sci. Ind. Res. (india) 16B (1957) :323 (Through C.A. 52 : 2182 i).
- Akihisa, T., Thakur, S., Rosenstein, U. and Matsumoto, T. Sterols of cucurbitaceae : The configuration at C-24 of alkyl Δ^5 , Δ^7 - and Δ^8 -sterols. Lipids 21 (1986) : 39 - 47.
- Baba, Xiao, Taniguchi, Ohishi and Kozawa. Isocoumarins from *Coriandrum sativum*. Phytochemistry 30 (1991) : 4143 - 4146.
- Bell, E.A. and Charlwood, B.V. Secondary Plant Products, Vol. VIII. New York : Springer - Verlag Berlin Heidelberg, 1980..
- Burnett, A.R. and Thomson, R.H. Chemotaxonomic investigation in Asphodeleae and Aloineae (Liliaceae). Phytochemistry 3 (1964) : 383-390.
- Burnett, A.R. and Thomson, R.H. Naturally occurring quinones. Part X. The quininioid constituents of *Tabebuia avellanedae* (Bignoniaceae). J. Chem. Soc. (C) (1967) : 2100-2104.
- Cooke, R.G. and Johnson, B.L. Colouring matters of australian plants XI. Quinones from *Ventilago viminalis*. Aust. J. Chem. 16 (1963): 695-702.
- Cumming, A.M. and Thomson, R.H. Anthraquinones in *Maesopsis eminii*. Phytochemistry 9 (1970) :2399 - 2400.
- Devon, T.K., Scott, A.I. Handbook of Naturally Occuring Compound. vol.II. New York and London :Academie Press, 1972.

- Elderfield, R.C. ed. Heterocyclic Compounds. Vol.II. New York : John Wiley & Sons, Inc., 1951.
- Fournier, G., Ludwig, Bercht, C.A., Paris, R.R. and Paris, M.R.
3 - Methoxychrysazin, a new anthraquinone from *Xyris semifuscata*. Phytochemistry 14 (1975) : 2099.
- Gibbs, R.D. Chemotaxonomy of Flowering Plants. Vol.III. Montreal and London : McGill - Queen's University Press, 1974.
- Gilman, H. et al. Organic Chemistry. Vol.II 2 nd ed. New York : John Wiley & sons, Inc., 1957.
- Goodwin, T.W. and Mercer, E.I. Introduction to Plant Biochemistry. 2nd ed. London : Pergamon Press, 1983.
- Grove and Frederick, New metabolic products of *Aspergillus flavus*, asperentin, its methyl ether, and 5Δ -hydroxyasperentin. J.Chem. Soc. Perkin Trans.1 19 (1972) : 2400-6.
- Hallock, F., Clardy, Kenfield, S. and Strobel. De-O-Methyldiaporthin, a phytotoxin from *Drechslera Siccans*. Phytochemistry 27 (1998) : 3123 - 3125.
- Hansen B. Flora of Thailand, Vol.5 part 1. pp.130-138, Bangkok, 1987.
_____, Notes on Asian species of *Xyris*, Bot. Tidsskr. 74 (1979): 21-25
- Heftmann, E. and Mosettig, E. Biochemistry of Steroids, New York : Reinhold Publishing Corporation. 1960.
- Herbert, R.B. The Biosynthesis of Secondary Metabolites, Chapman and Hall, 1981.
- Holker, J.S.E., Simpson, T.J. Studies on fungal metabolites. Part 2. Carbon-13 NMR biosynthetic studies on pentaketide metabolites of *Aspergillus melleus*. J.C.S.Perkin Trans. 1 (1981) : 1397-1400.

- Ikan R., Natural Products, London : Academic Press, 1969.
- Kirtikar, K.R. and Basu, B.D. Indian Medicinal Plants, Vol.IV. 2nd ed. Delhi :Prabasi Press, 1975.
- Knapp, J.E., Farnsworth, M.R., Theiner, M. and Schiff, P.L.Jr. Anthraquinones and other constituents of *Fabiana imbricata*. Phytochemistry 11 (1972) : 3091 - 3092.
- Kral, R. and Wanderley. Ten Novelties in *Xyris* (Xyridaceae) from the Planalto of Brazil. Ann, Missouri Bot. Gard, 75 (1988):352-372.
- Kral, R. A treatment of american Xyridaceae exclusive of *Xyris*. Ann. Missouri Bot.Gard. 79 (1992) : 819-885.
- Lawrence, H.M. Taxonomy of Vascular Plants. 3 rd ed. pp. 403-404, New York : the Macmillian company, 1985.
- Le Blance, G.D., Babineau, L.M. 2, 5-Dimethoxybenzoquinone, 3,4-dimethyl-8- hydroxy-isocoumarin, and eburicoic acid isolated from *Lenzites thermophila*. Can. J.Microbiol. 18 (1972):161-3.
- Lee, H.H. Colouring matters from *Prismatomeris malayana*, Phytochemistry 8 (1969) : 501-503.
- Leistner, E. Mode of incorporation of precursors into alizarin (1,2-dihydroxy- 9,10 anthraquinone). Phytochemistry 12 (1973) : 337-345.
- Miller, L.P. Phytochemistry. Vol.II. New York : Van Nostrand Reinhold company, 1973.
- Mir, I., Ahmad, S. and Hamid, A. Chemical investigation on *Lenzites trabea*. Pak.J.Sci.Inf.Res, 14 (1971) : 479-80.
- Moore, Jack H., Davis, Norman D. and Diemer, Urban L. Mellein and 4-hydroxy-mellein production by *Aspergillus ochraceus*. Appl.Microbiol. 23 (1972) : 1067-72.

- Mori, H., Sugie, S., Niwa, K., Takahashi, M. and Kawai, K. Induction of intestinal tumors on rat by chrysazin. Br. J. Cancer, 52 (1985) : 781-783.
- Murray, R.D. H., Mendez, J. and Brown, S.A. The Natural Coumarins, Occurrence, Chemistry and Biochemistry. A Wiley-Interscience Publication, 1982.
- Nakanishi, Goto, Ito, Natori and Nozoe, Natural Products Chemistry. Vol. I London : Academic Press, 1974.
- Narasimhan, N.S., Bhide, B.H. Synthetic applications of lithiation reactions V. Tetrahedron 27 (1971) : 24.
- Nijsiri Ruangrunsi and Payom Tantivatana. Anthraquinones from *Xyris indica* Linn. Chula, Res, J. 7 (1980) : 144-147.
- Robinson, T. The Organic Constituents of Higher Plants 2nd ed. pp. 106-112, Mineapolis : Burgess publishing company, 1967.
- Scott, Peter M., Van Walbeek and Wilhelmina, Cladosporin, a new antifungal metabolite from *Cladosporium cladosporioides*. J. Antibiot. 24 (1971) : 747-755.
- Shoppee, C.W., Cook, J. and Stacey, M. Chemistry of the Steroids, London : Butterworths, 1957.
- Sim, S.K. Medicinal Plant Glycosides. University of Toronto Press, 1968.
- Speranza, G., Manitto, P., Cassara, P. and Monti, D. Feralolide, a dihydroisocoumarin from cape aloe. Phytochemistry 33 (1993) : 175-178.
- Sun and Toia, F. Biosynthetic studies on ant metabolites of mellein and 2, 4-dihydroxyacetophenone from [1,2 - ¹³C₂] acetate, J. of Nat. Prot. 56 (1993) : 953-956.

- Swain, T. ed. Chemical Plant Taxonomy. London and New York : Academic Press, 1963.
- Sztaricskai, F., Dinya, Z., Batta, Gy., Szallas, Szentirmai A. and Fodor A. Anthraquinones produced by enterobacters and nematodes. Models in Chemistry 129 (1992) : 697-707.
- Takido, M. Studies on the constituents of the seeds of *Cassia obtusifolia* Linn. I. The Structure of obtusifolin. Chem, Pharm. Bull. 6(1958): 397.
- Thomson, R.H., Cook, J.W. and Stacey, M. ed. Naturally Occurring Quinones, London : Butter Worths Scientific Publications, 1957.
- Thomson, R.H., ed. The Chemistry of Natural Products. 2 nd ed. London: Chapman and Hall, 1993.
- _____, The Chemistry of Natural Products. Scotland : Thomson Litho Ltd., 1985.
- _____, Naturally Occurring Quinones. 2 nd ed. London and New York: Academic Press, 1971.
- Trease, G.E. and Evans, W.C. Pharmacognosy, 12 th ed. London : Bailliere Tindall, 1983.
- Umezawa, Iinuma, Ito, Matsuzaki, Takeuchi and Tanabe. Dopamine β -hydroxylase inhibitor produced by *Gloeophyllum striatum* and its identity with oosponol. J. Antibiot. 25 (1972):239-42.
- Van Rheed van Oudtshoorn, M.C.B. Preliminary chemotaxonomical observations on *Aloe* Juices and on *Bulbine* species. Planta. Med. 11 (1963) : 332-337.
- Weete, J.D. Review Article. Sterol of the fungi : Distribution and biosynthesis. Phytochemistry 12 (1973) :1843-1864.

- Wijnsma, R., Verpoorte, R., Mulder-Krieger, Th. and Baerheim Svendsen, A.
Anthraquinone in callus cultures of *Cinchona ledgeriana*.
Phytochemistry 23 (1984) : 2307-2311.
- Wright, J.L.C *et. al.* Identification of C-24 alkyl epimer of marine
sterols by ^{13}C NMR spectroscopy. Can, J. Chem. 56 (1978):1898-1903.
- Yoshikawa *et. al.*, Thumberginols C, D, and E, New antiallergic and
antimicrobial dihydroisocoumarins, and thunberginol G 3'-O-
glucoside and (-)-hydrangenol 4'-O-glucoside, new dihydroisocoumarin
glycosides, from Hydrangeae Dulcis Folium. Chem, Pharm, Bull.
40 (2) 1992 : 3352-3354.
- Yoshikawa, Uchida, Chatani, Murakami and Yamahara. Thunberginols A, B,
and F. New antiallergic and antimicrobial principles from
Hydrangeae Dulcis Folium. Chem, Pharm, Bull. 40 (11) 1992:
3121-3123.



APPENDIX

a) Silica gel G/petroleum ether : ethyl acetate (8:1)

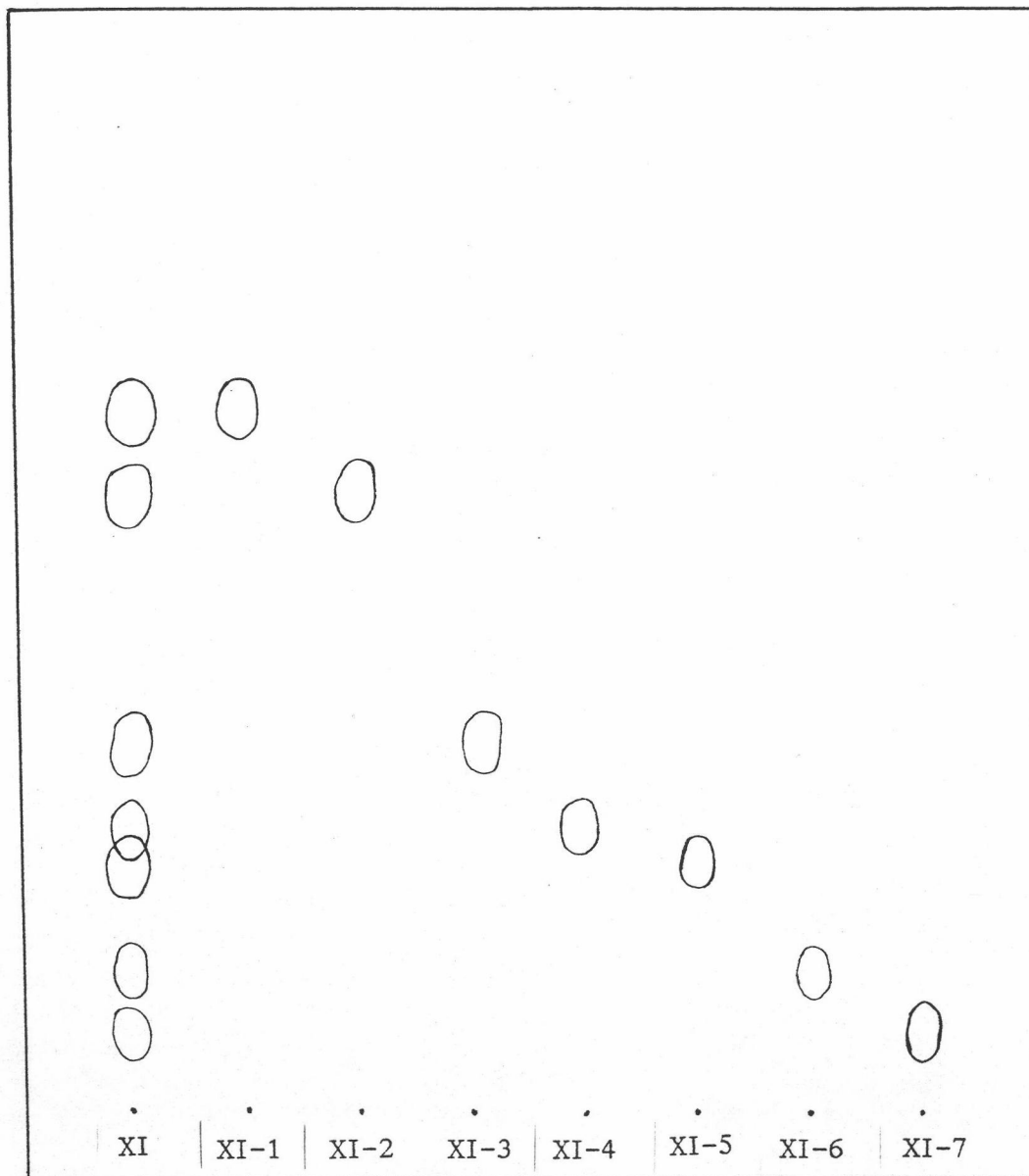

Figure 11

Thin layer chromatograms of isolated compounds from *Xyris indica* Linn.

b) Silica gel G/n-hexane : ethyl acetate (99:1)

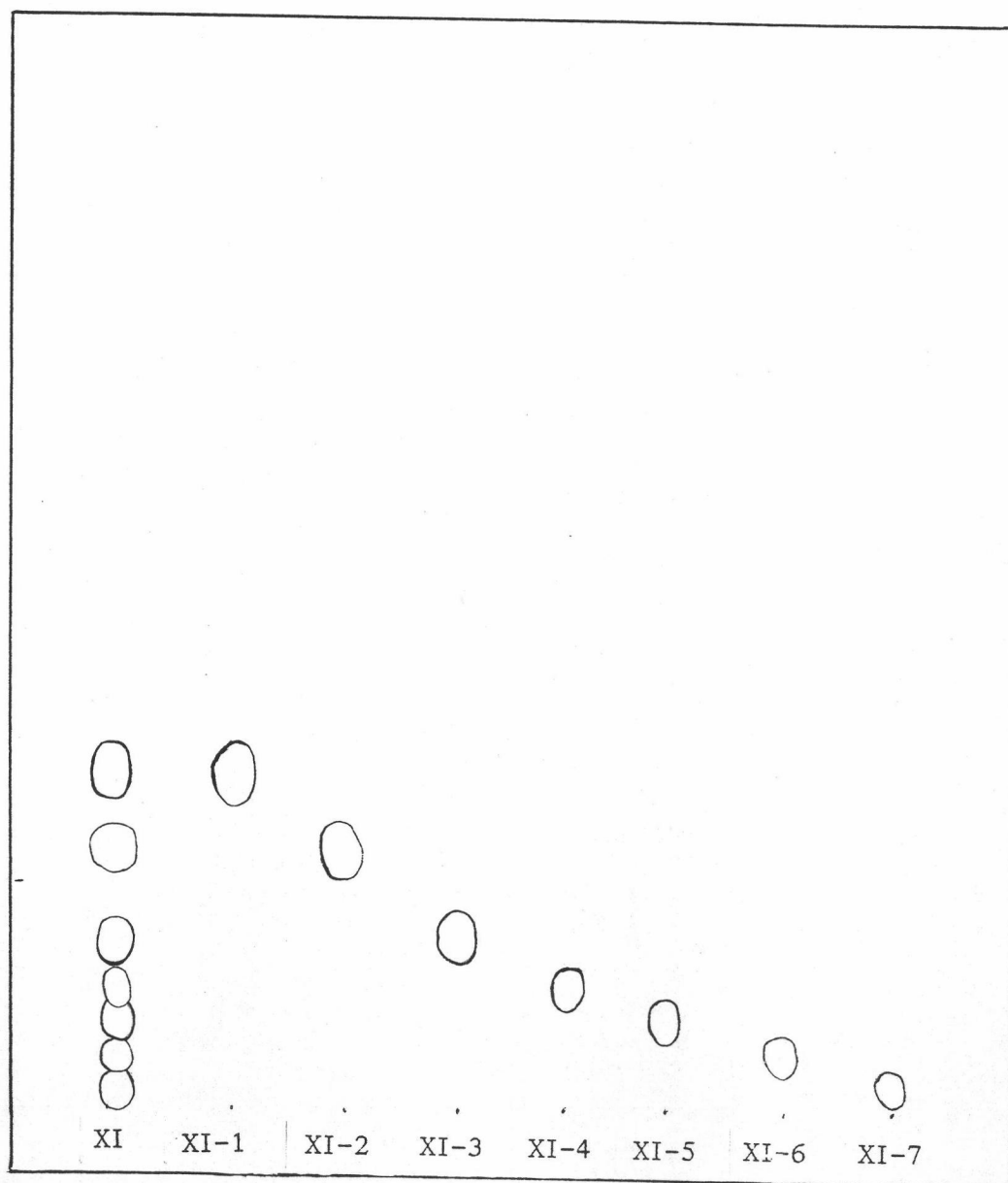

Figure 12

Thin layer chromatograms of isolated compounds from *Xyris indica* Linn.

c) Silica gel G/chloroform

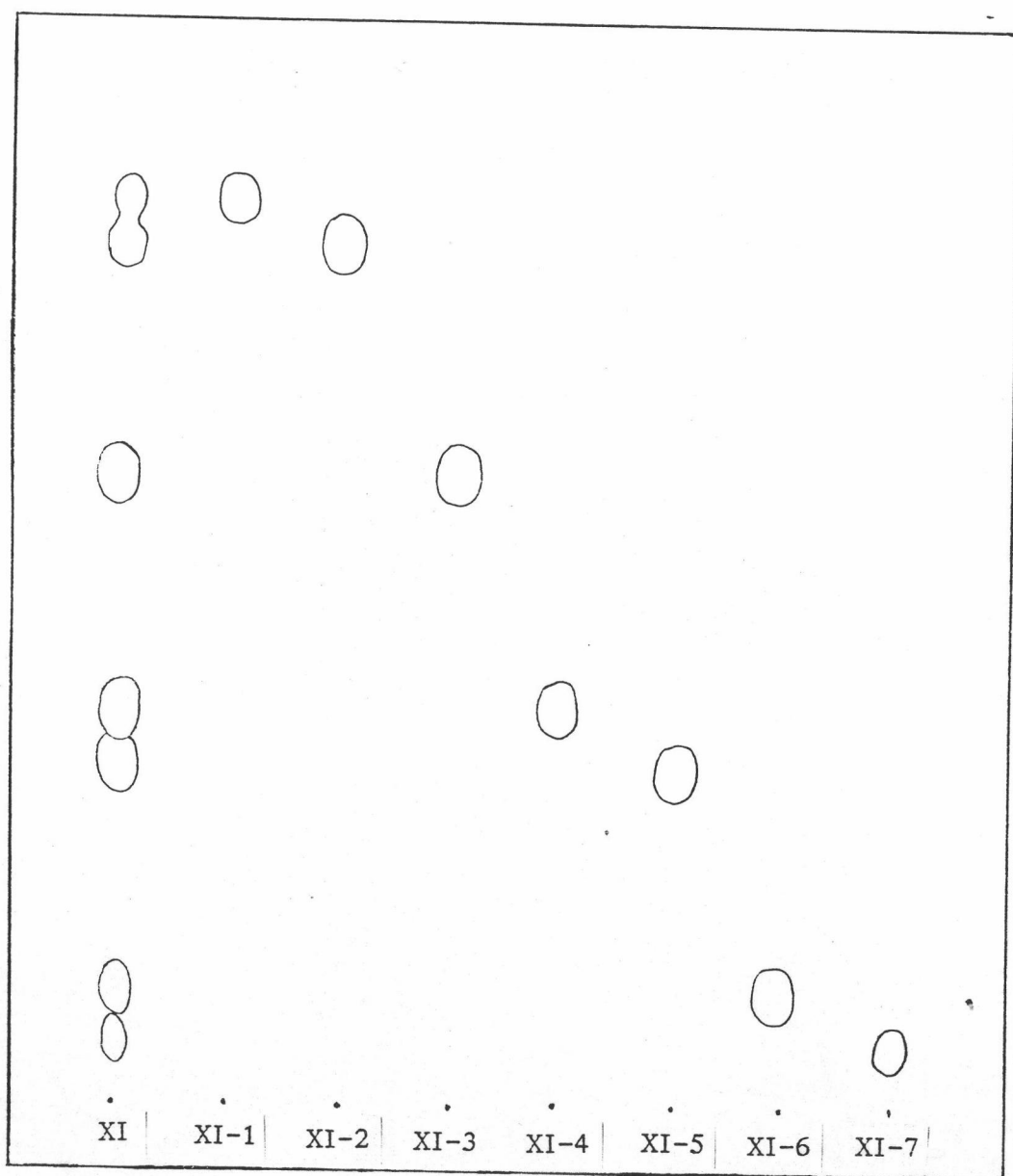

Figure 13

Thin layer chromatograms of isolated compounds from *Xyris indica* Linn.

d) Silica gel G/petroleum ether : ethyl acetate (5:1)

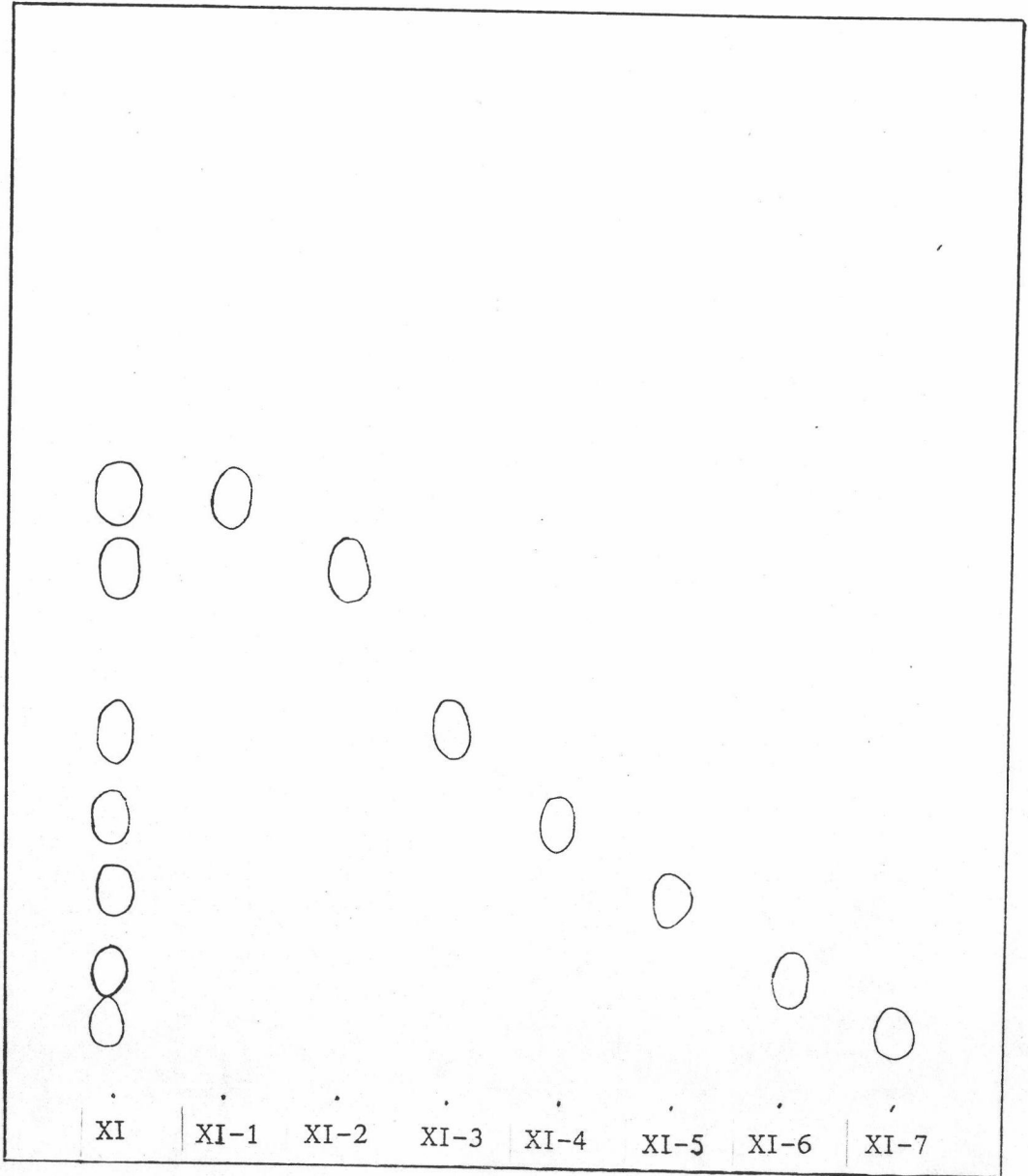

Figure 14

Thin layer chromatograms of isolated compounds from *Xyris indica* Linn.

e) Silica gel G/benzene : ethyl acetate (15:1)

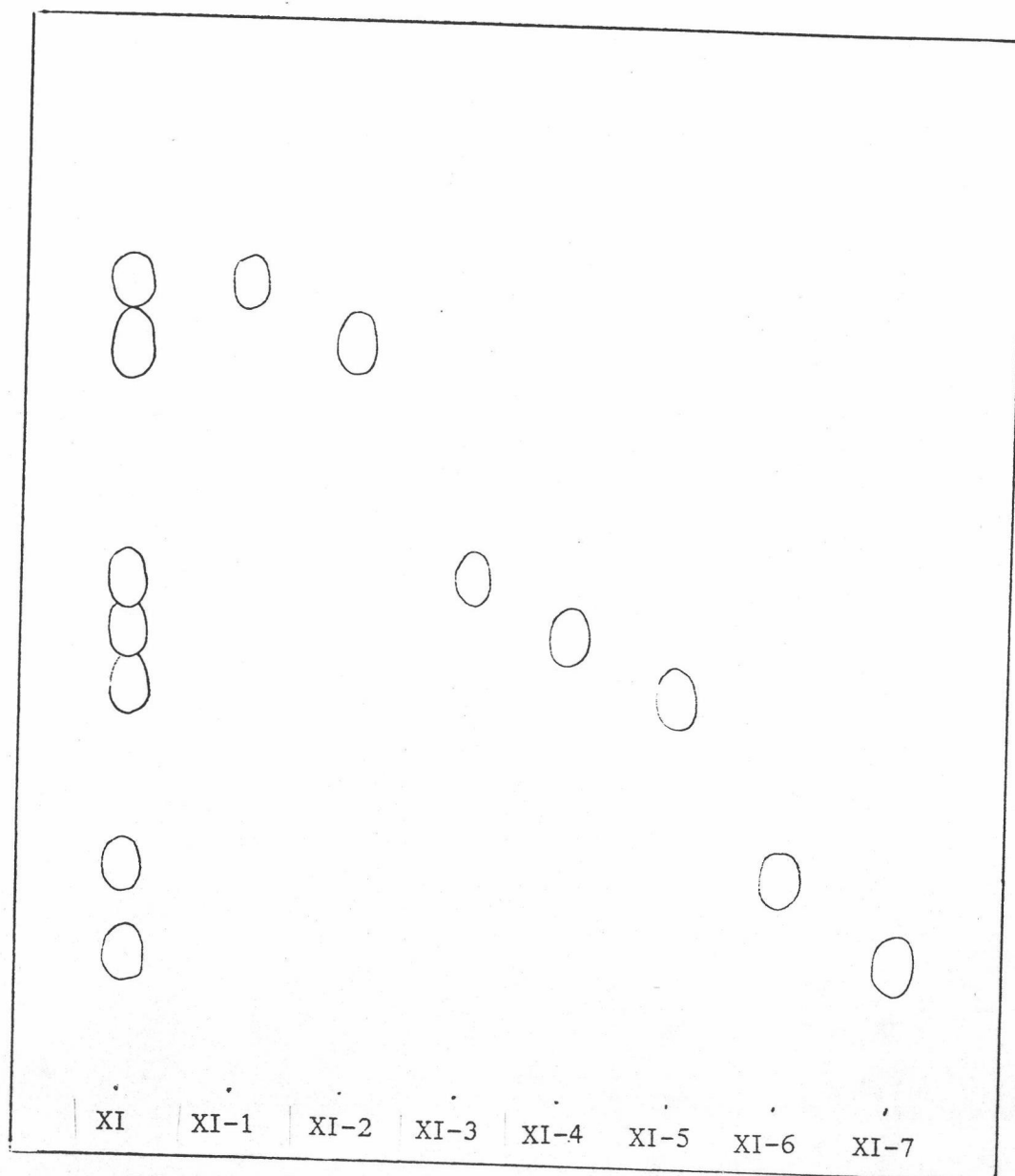

Figure 15

Thin layer chromatograms of isolated compounds from *Xyris indica* Linn.

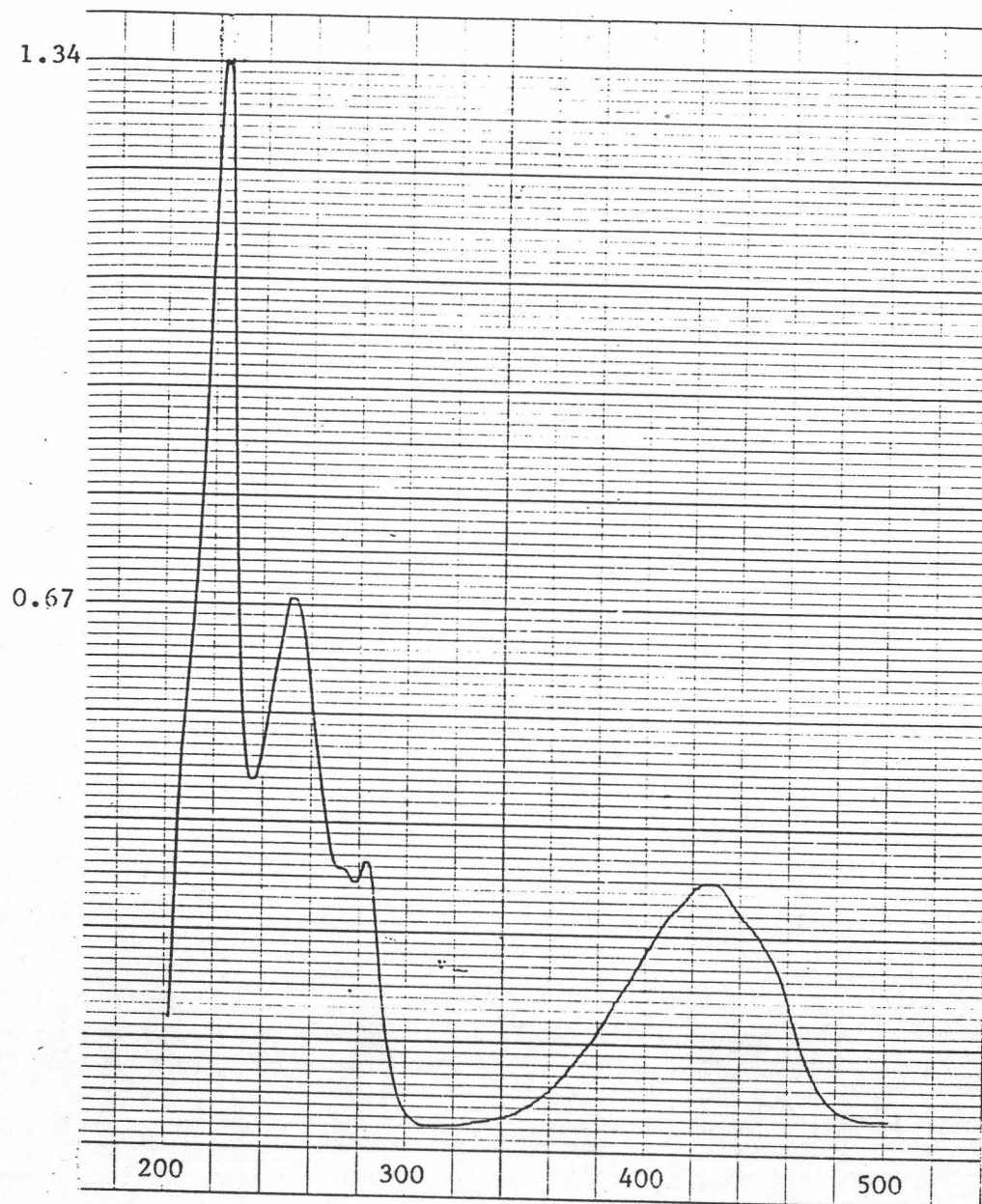
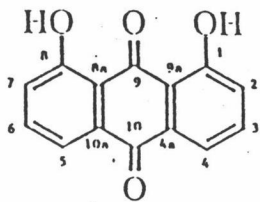

Figure 16 Ultraviolet absorption spectrum of XI-1

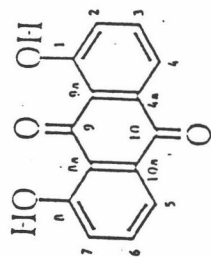
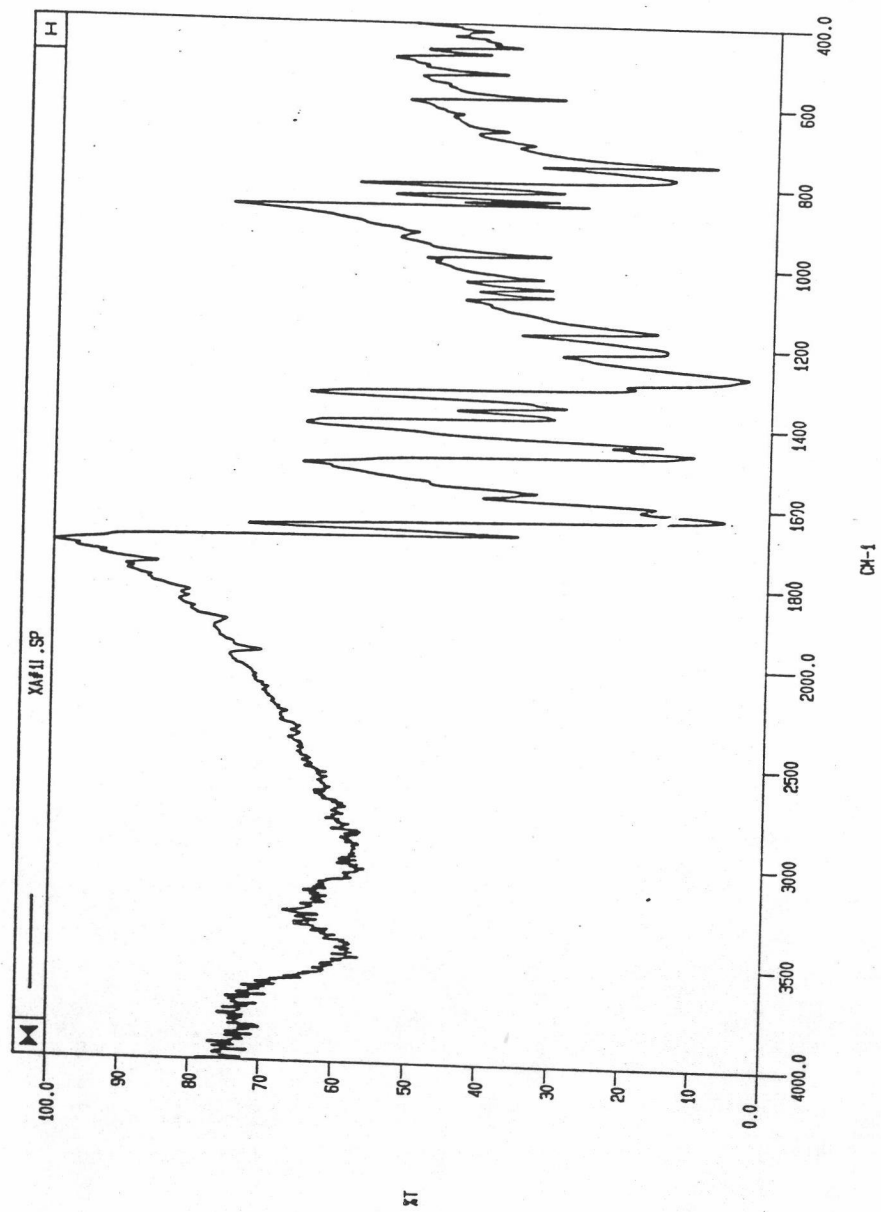
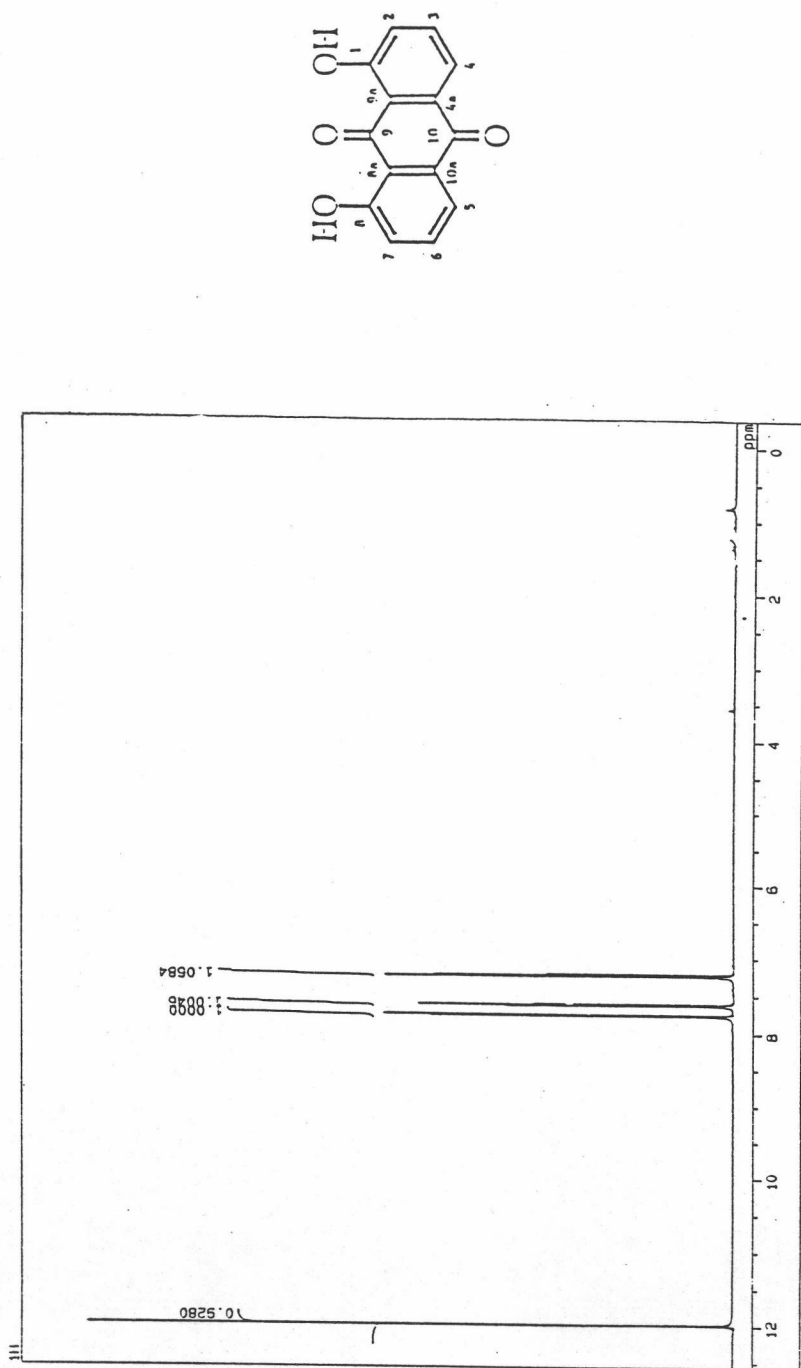
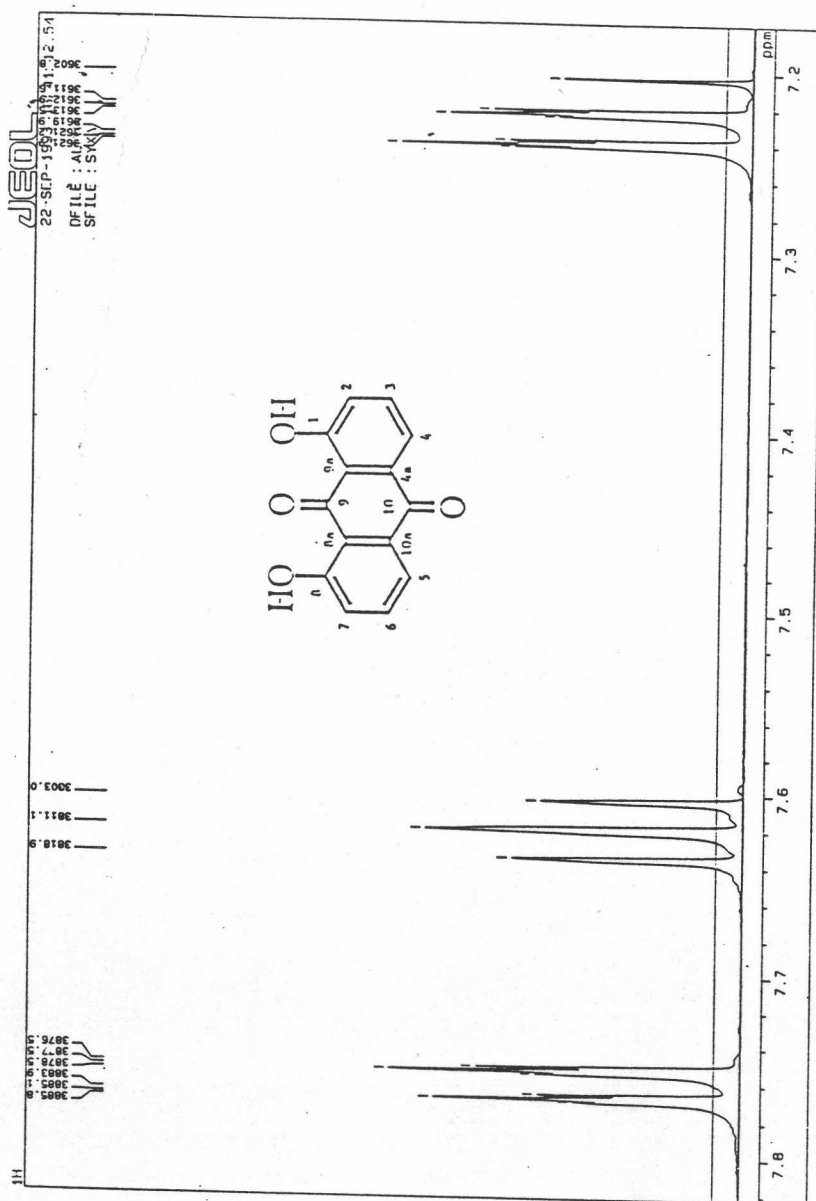
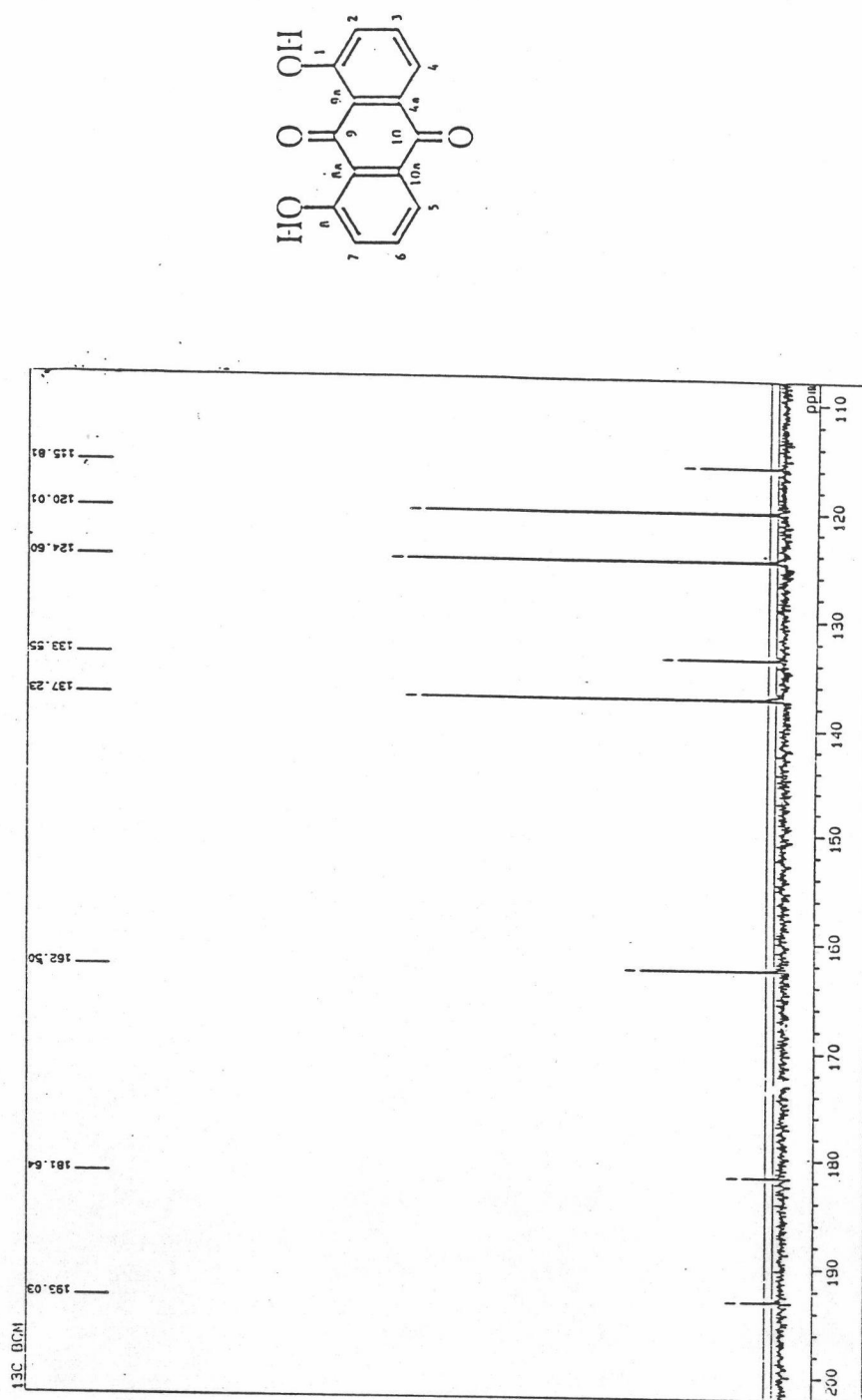

Figure 17 Infrared absorption spectrum of XI-1

Figure 18 $^1\text{H-NMR}$ spectrum of XI-1

Figure 19 Expansion of $^1\text{H-NMR}$ spectrum of XI-1

Figure 20 ^{13}C -NMR spectrum of XI-1

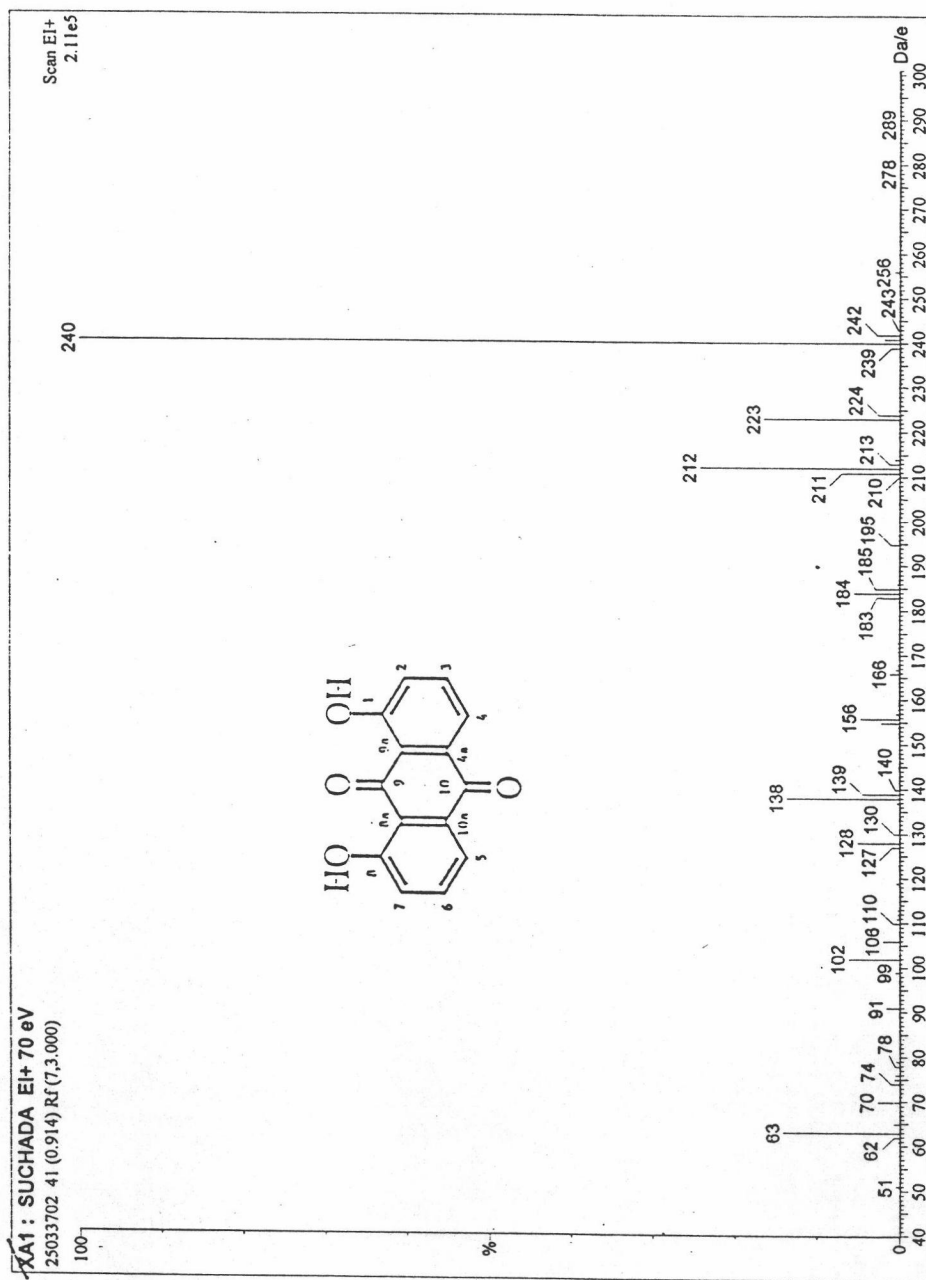

Figure 21 EI mass spectrum of XI-1

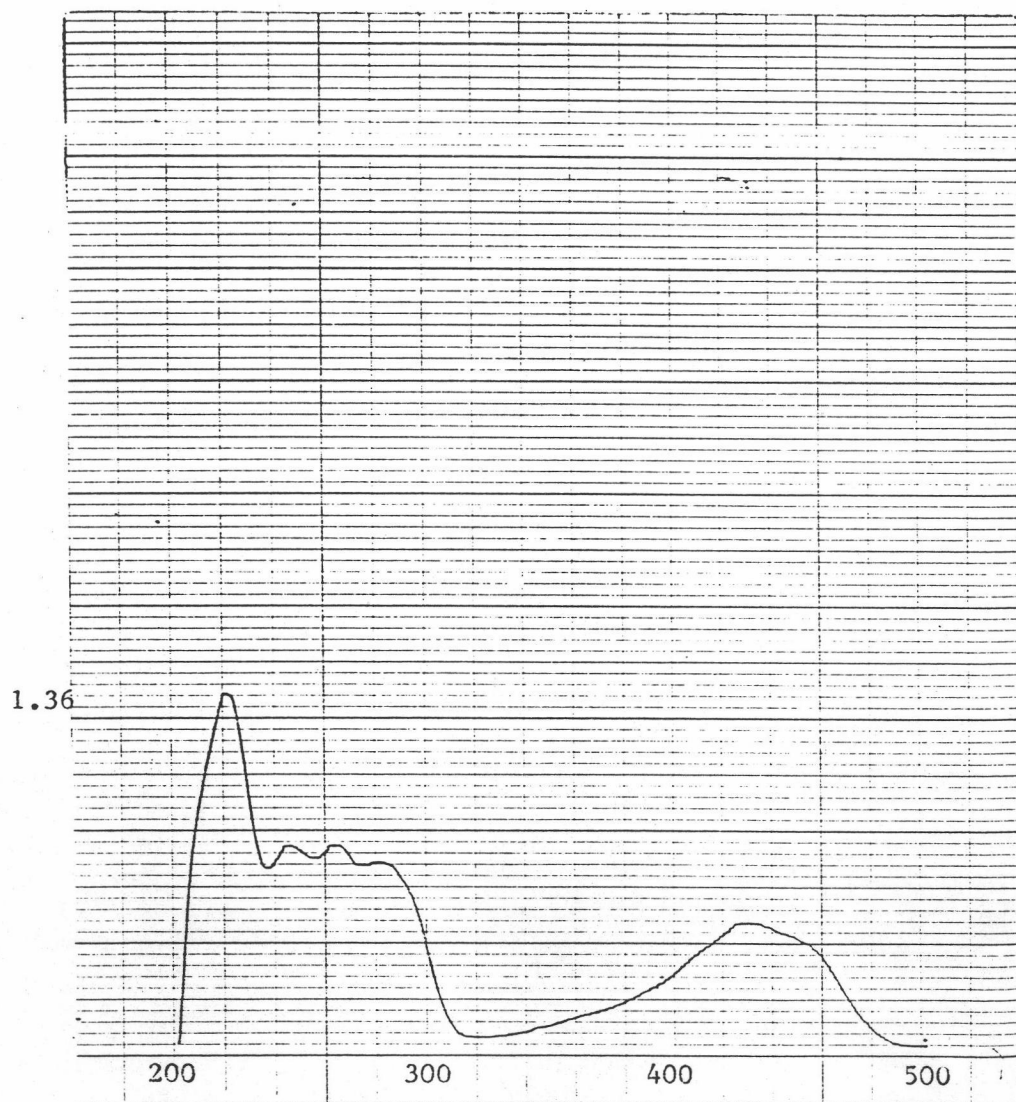
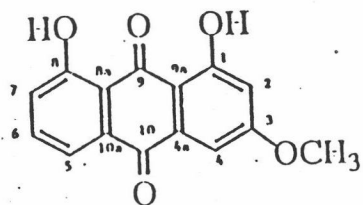

Figure 22 Ultraviolet absorption spectrum of XI-2

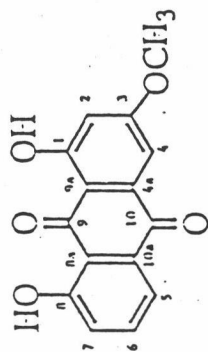
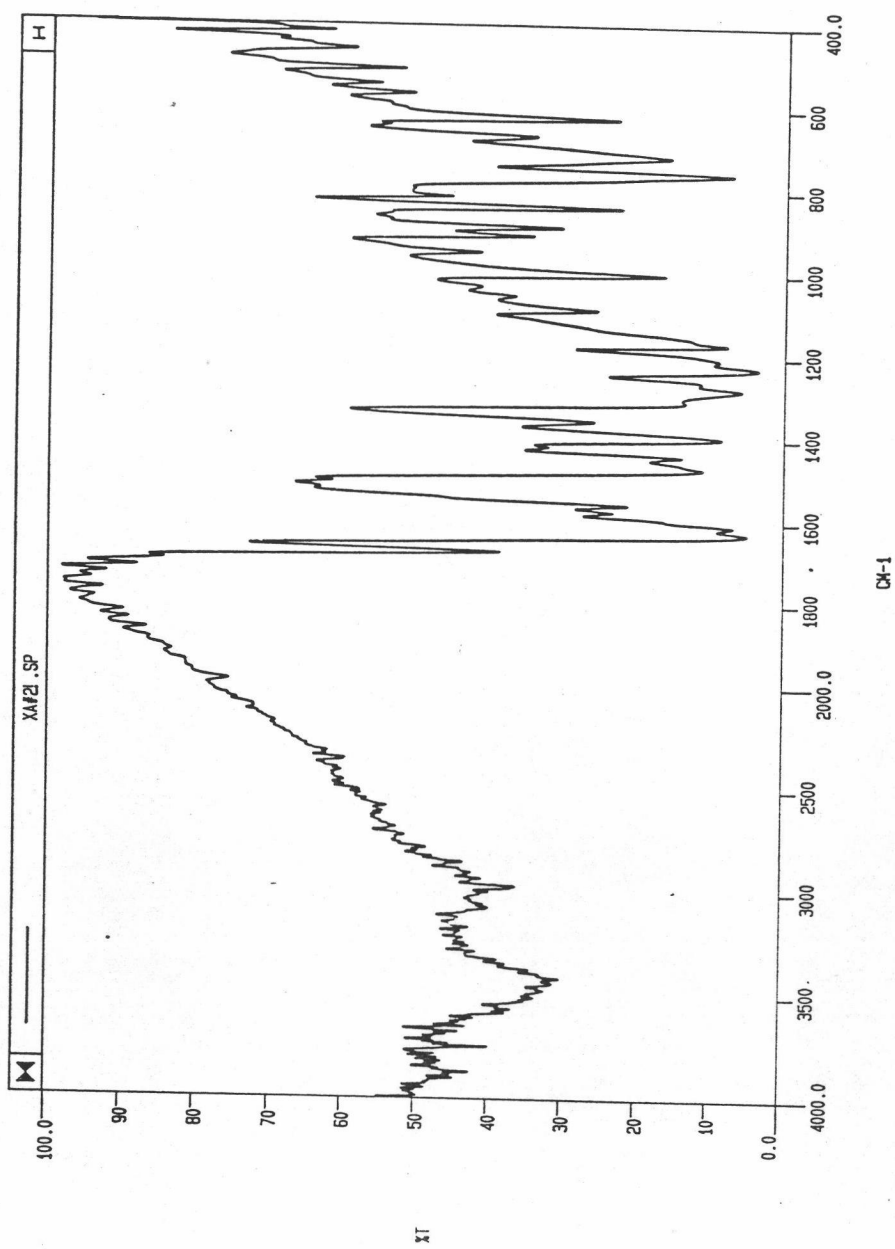
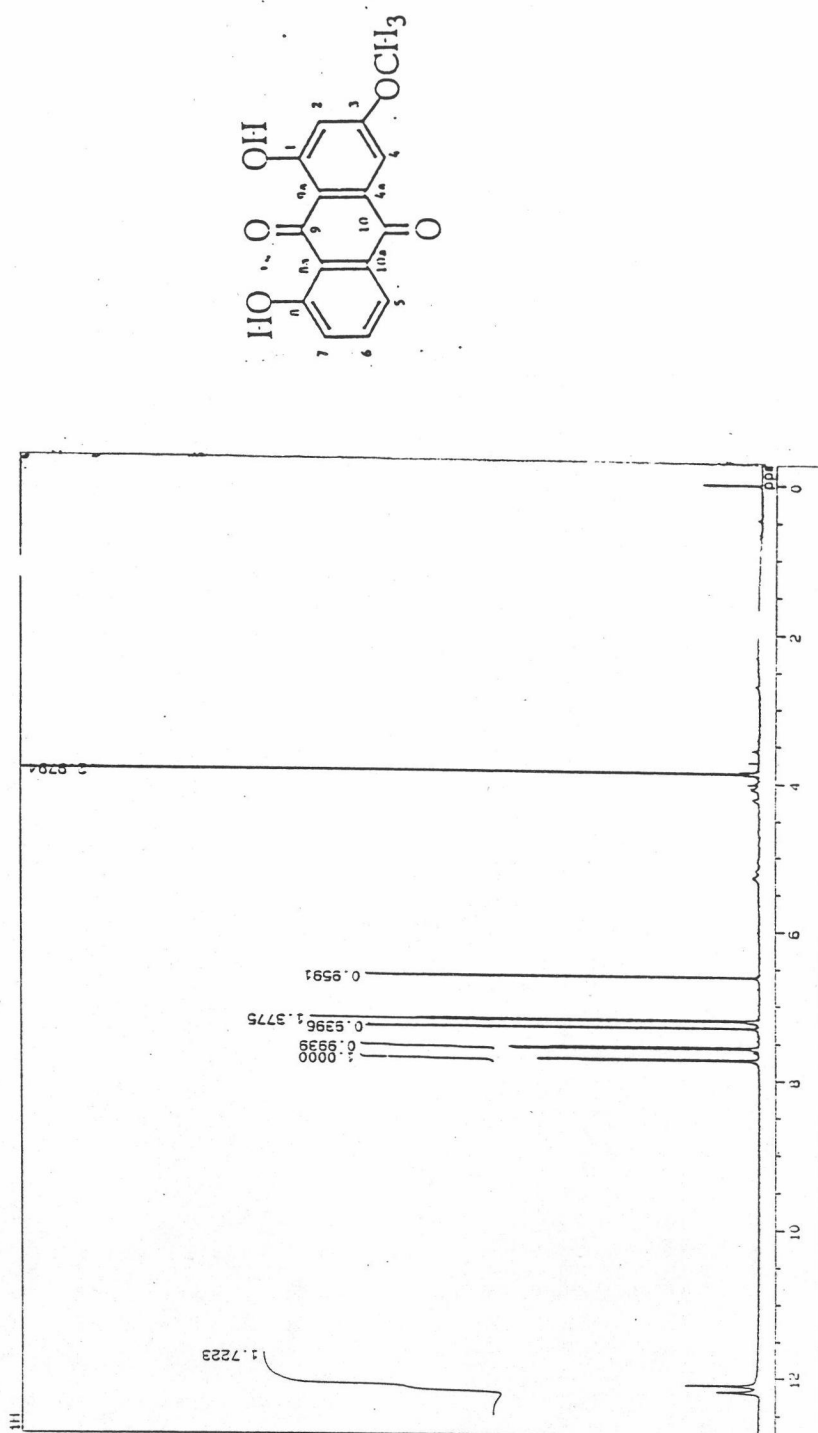
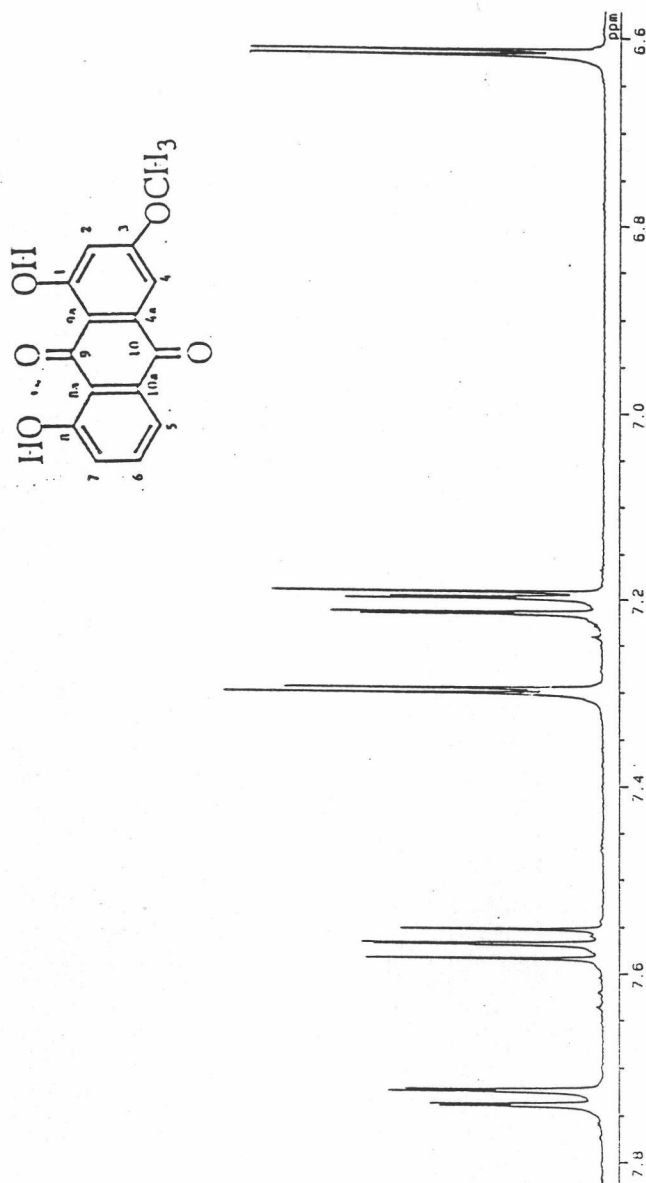

Figure 23 Infrared absorption spectrum of XI-2

Figure 24 $^1\text{H-NMR}$ spectrum of XI-2

Figure 25 Expansion of $^1\text{H-NMR}$ spectrum of XI-2

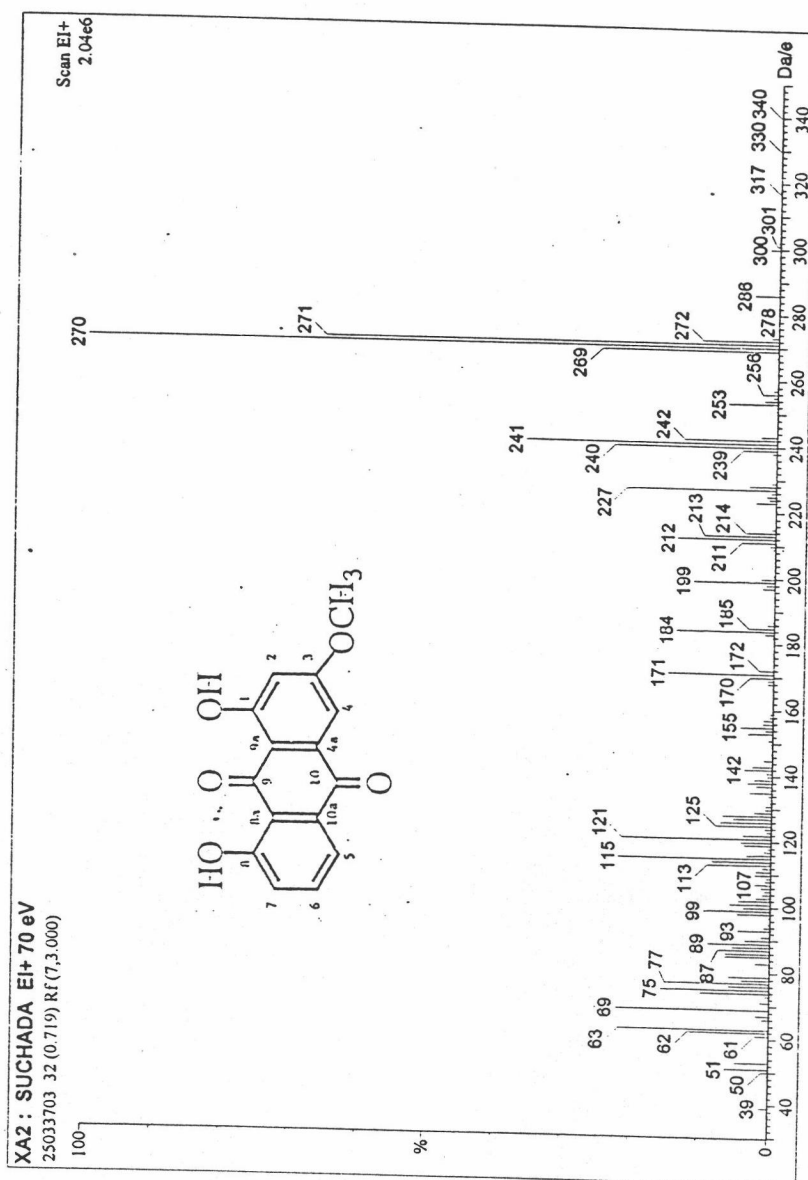

Figure 26 EI mass spectrum of XI-2

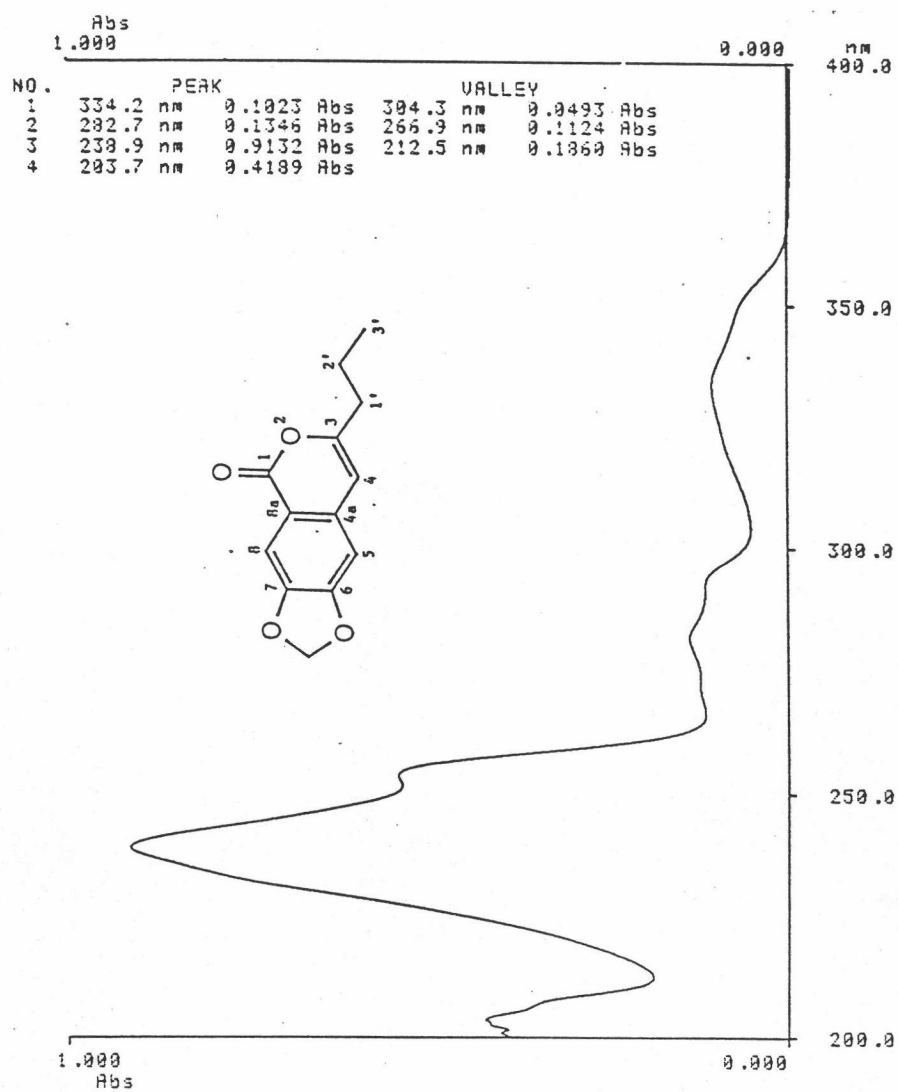

Figure 27 Ultraviolet absorption spectrum of XI-3

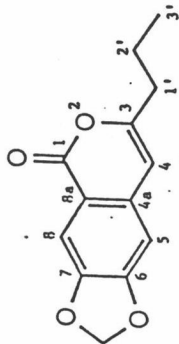
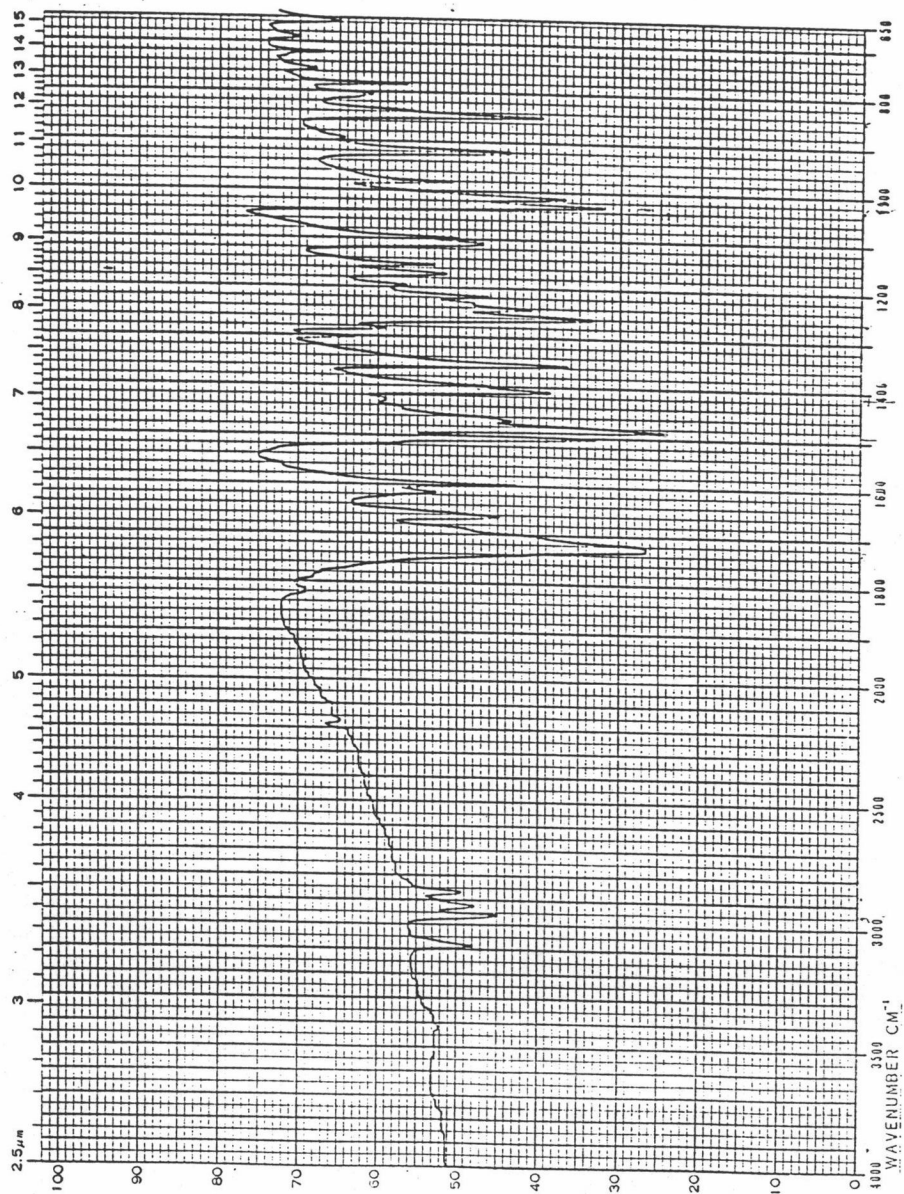
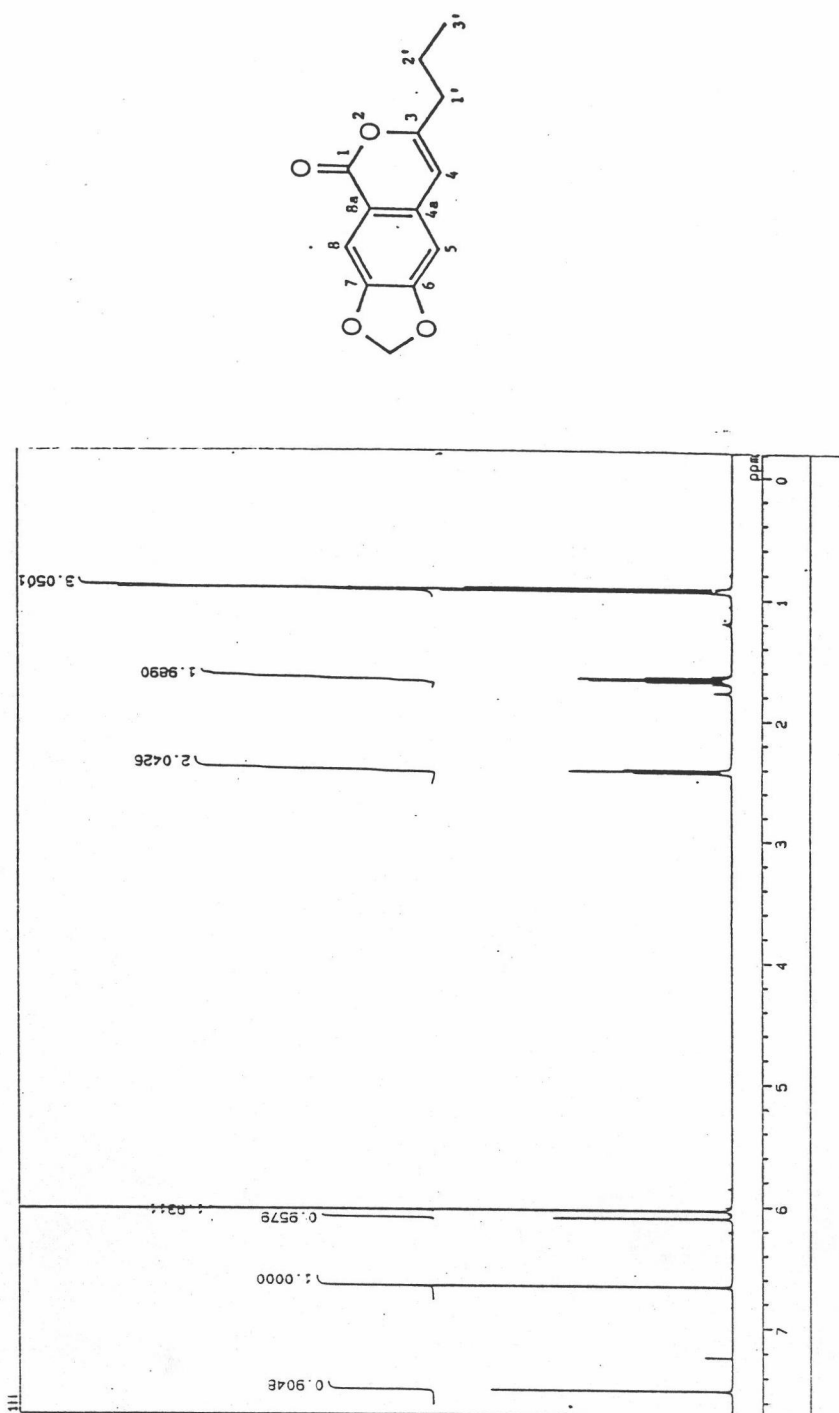
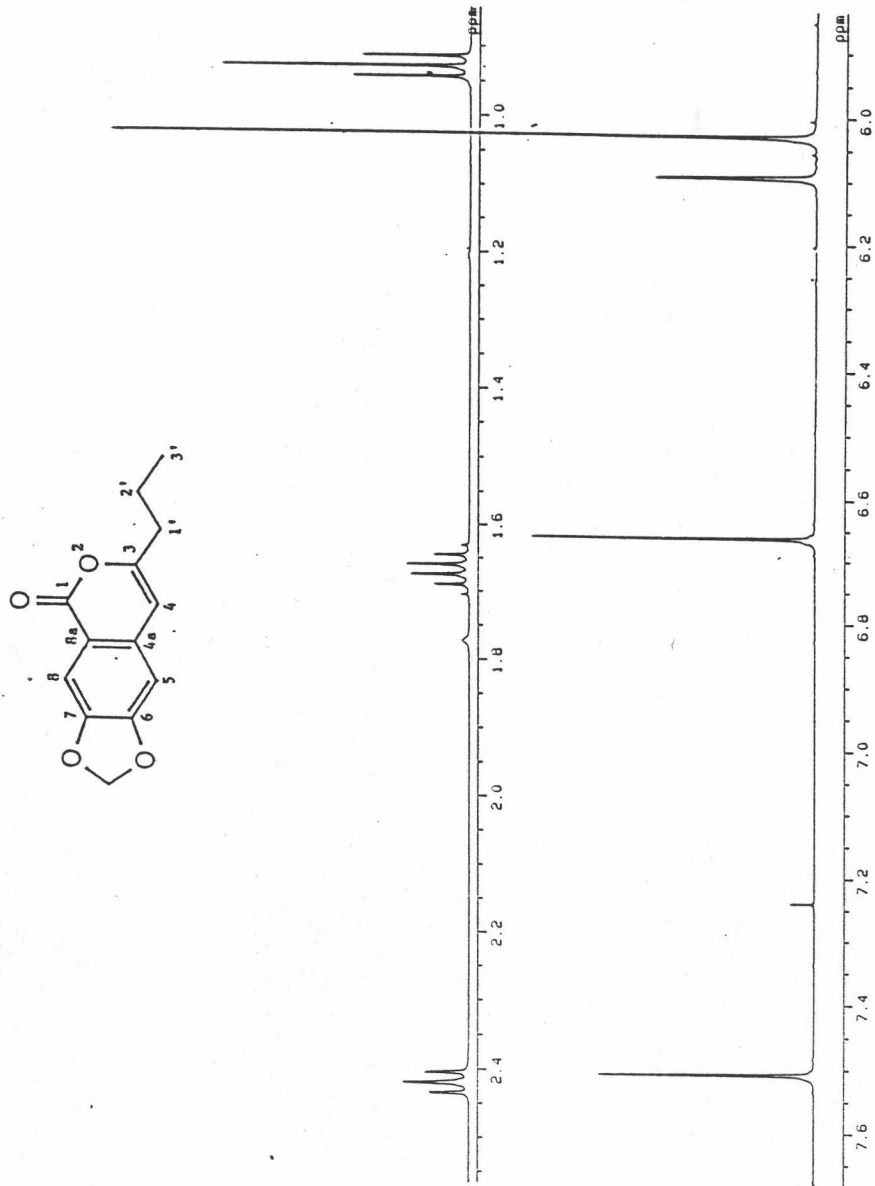

Figure 28 Infrared absorption spectrum of XI-3

Figure 29 $^1\text{H-NMR}$ spectrum of XI-3

Figure 30 Expansion of $^1\text{H-NMR}$ spectrum of XI-3

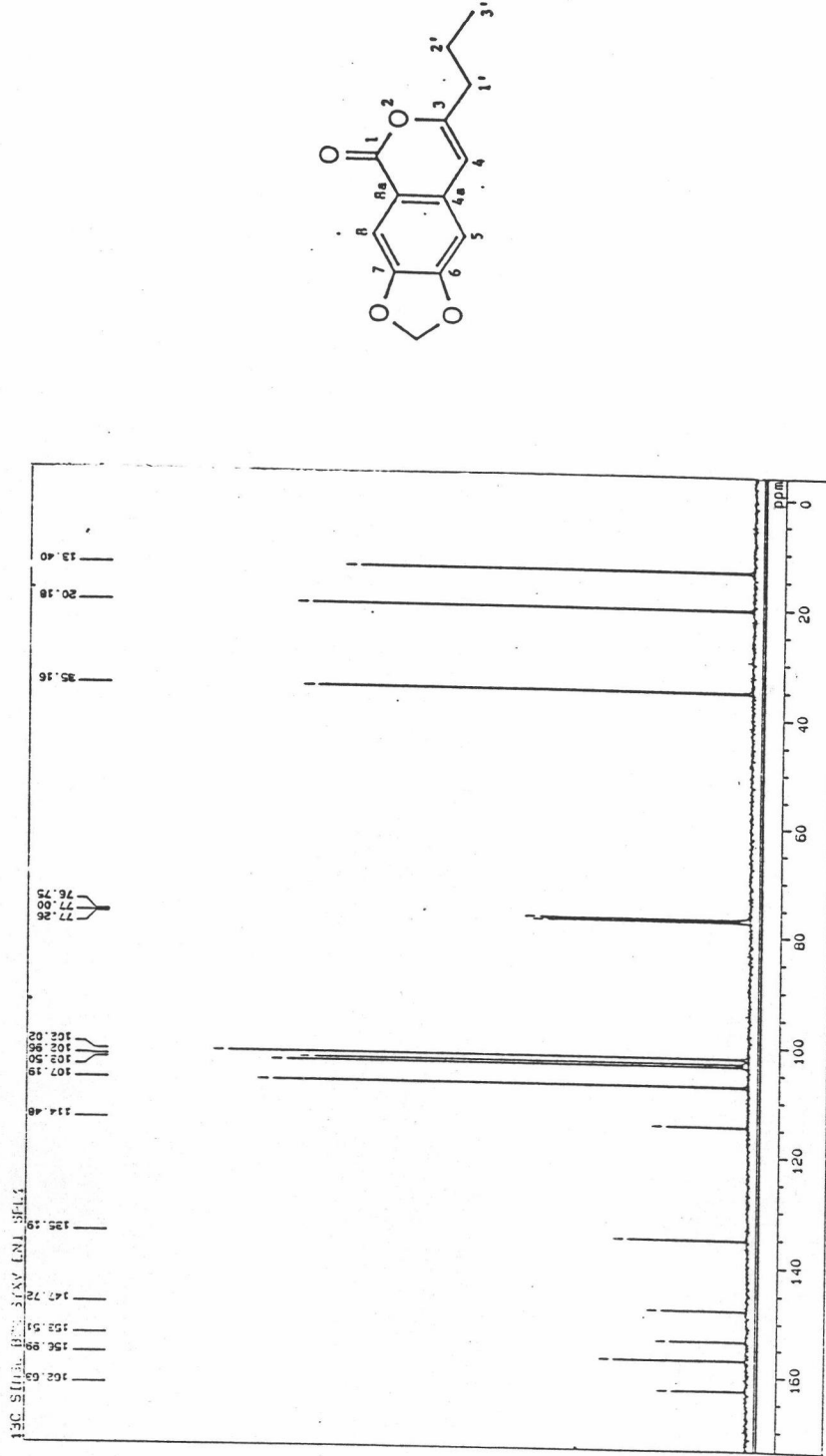
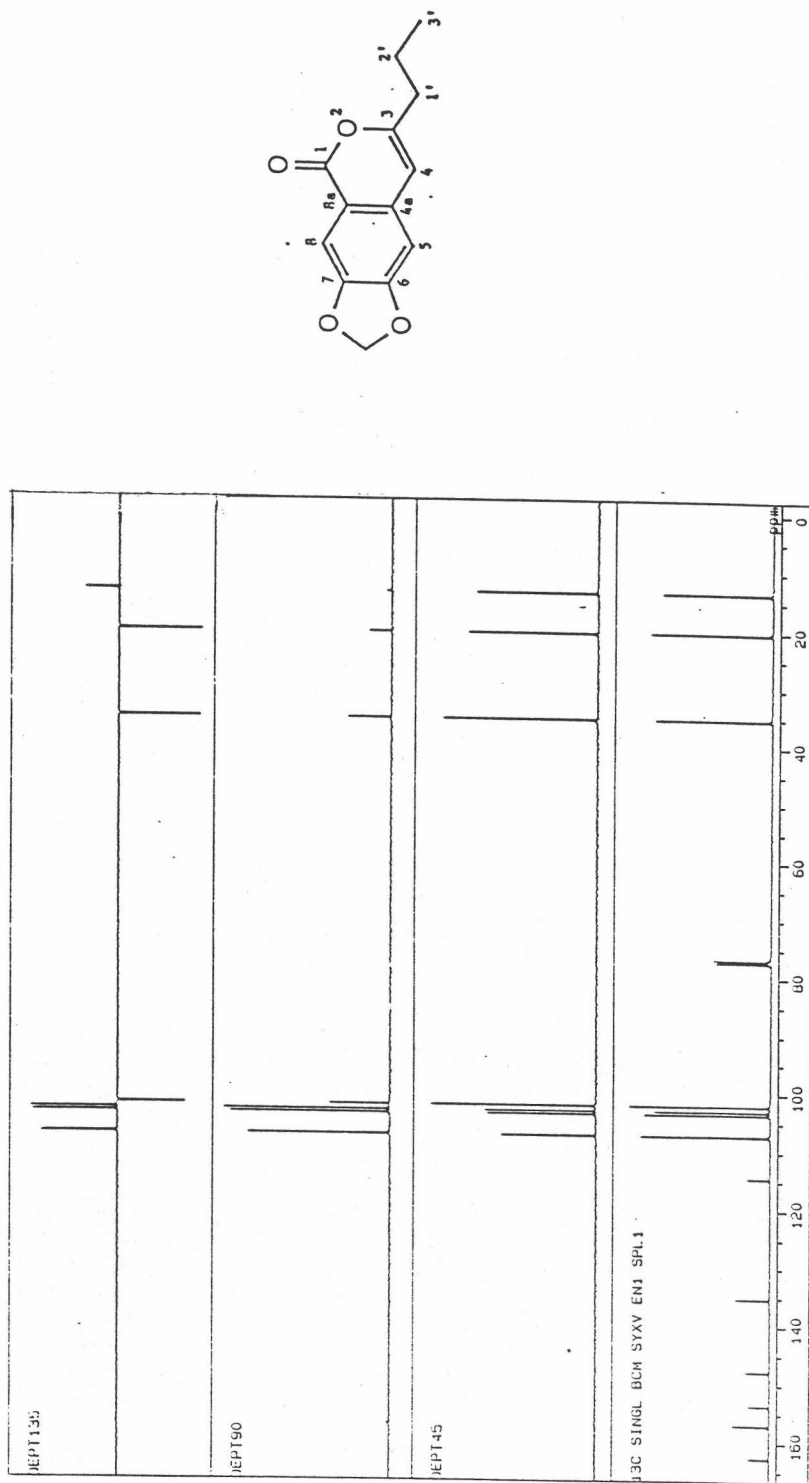
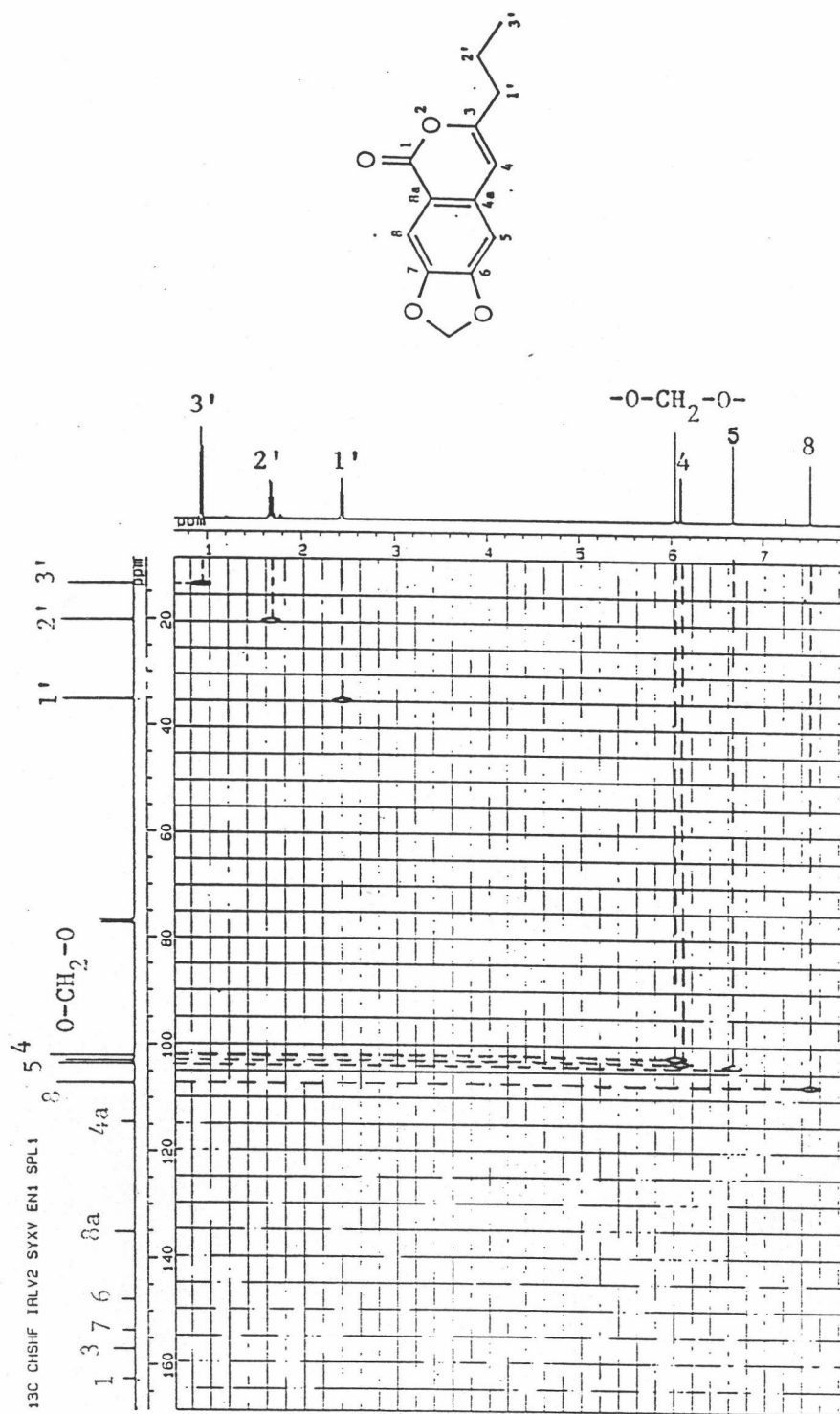

Figure 31 ¹³C-NMR spectrum of XI-3

Figure 32 ^{13}C -NMR spectrum of XI-3 (DEPT)

Figure 33 ^{13}C - ^1H COSY spectrum of XI-3

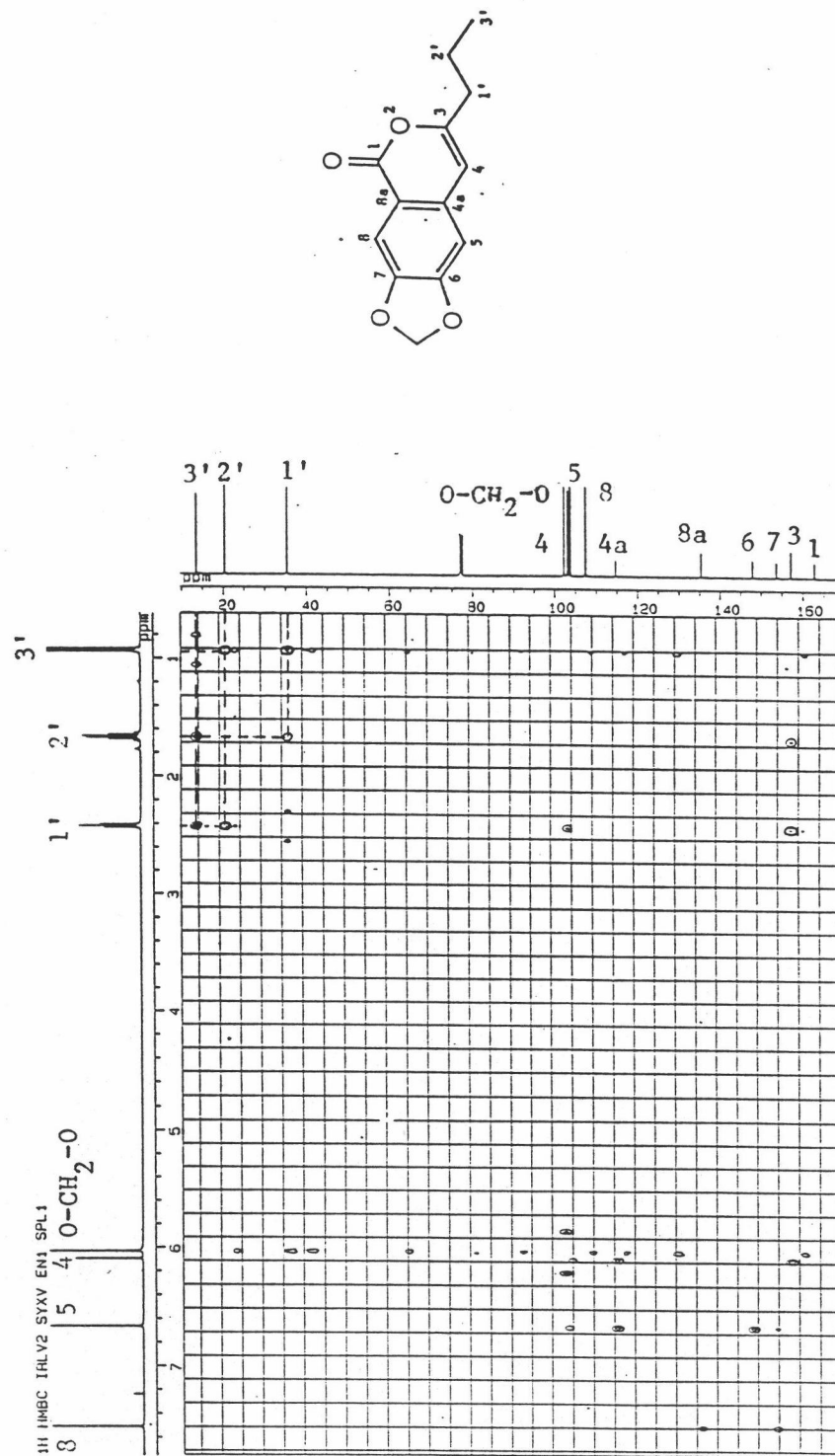

Figure 34 HMBP spectrum of XI-3

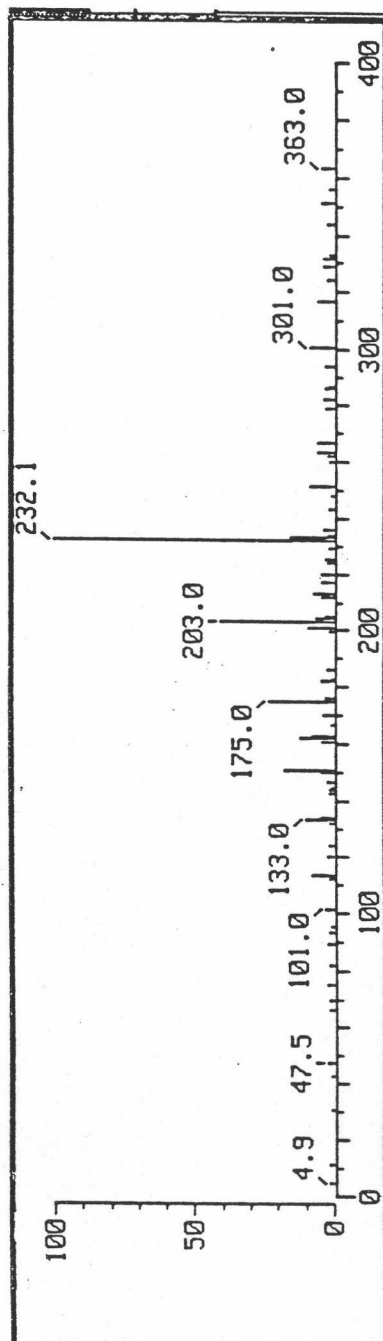
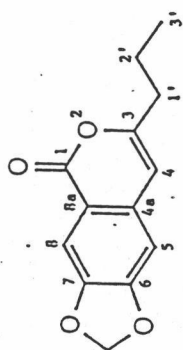

Figure 36 HREIMS spectrum of XI-3

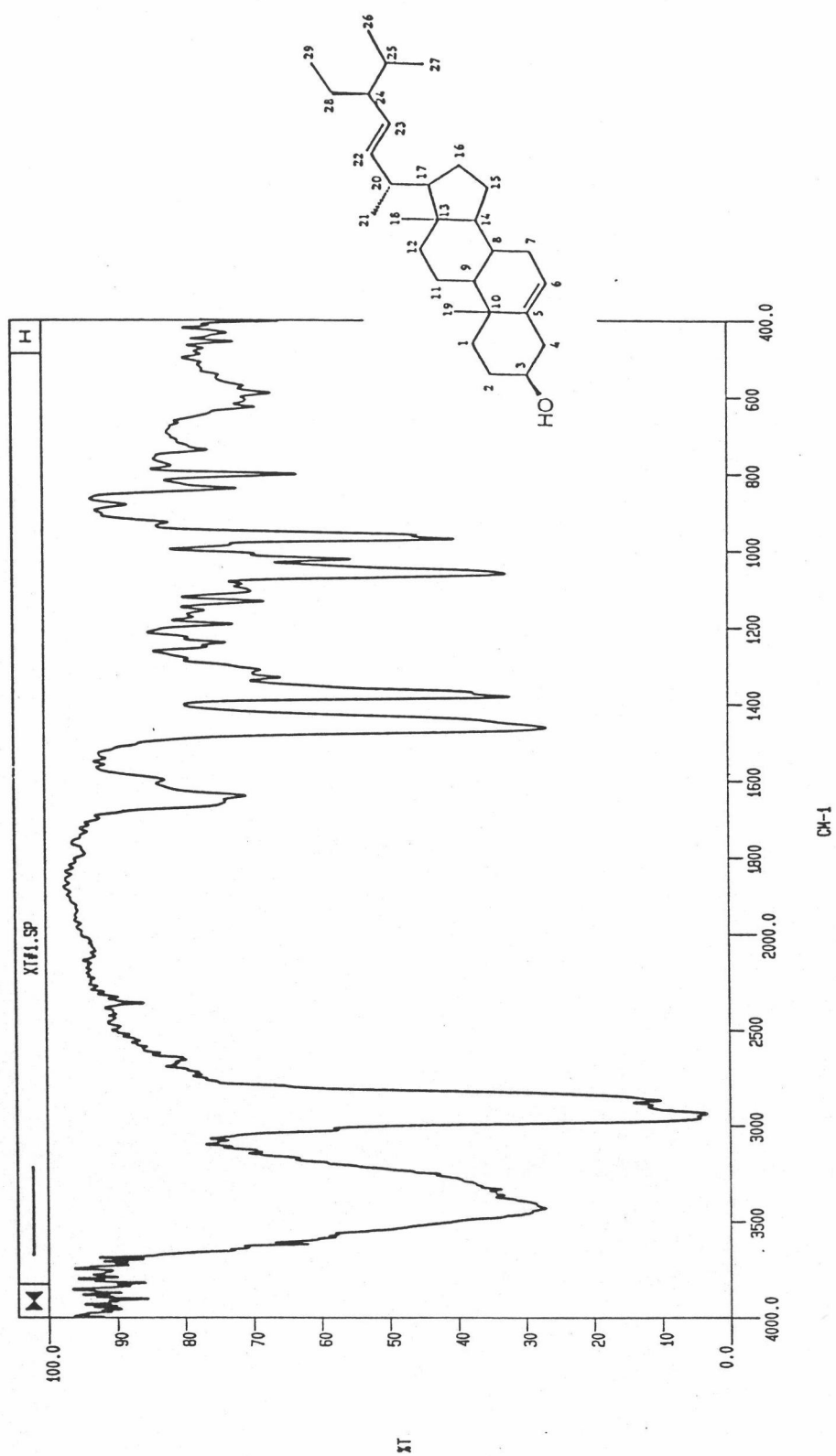
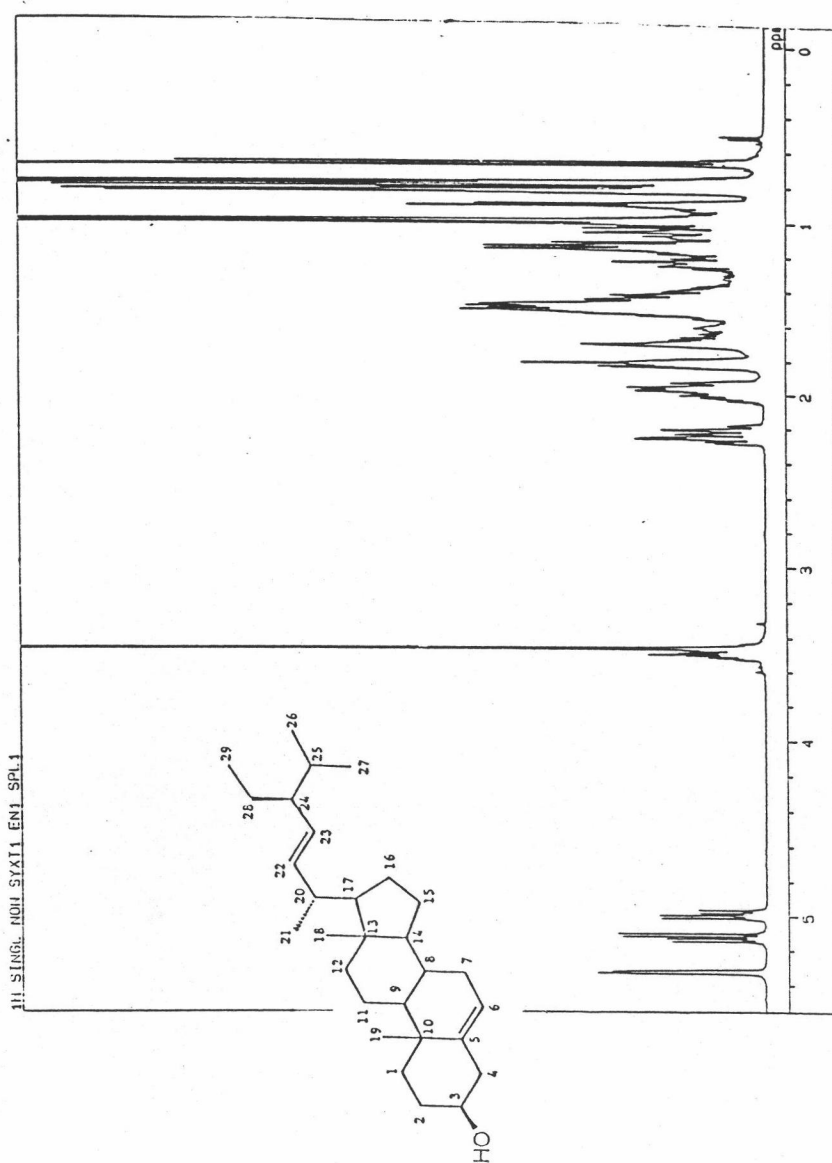
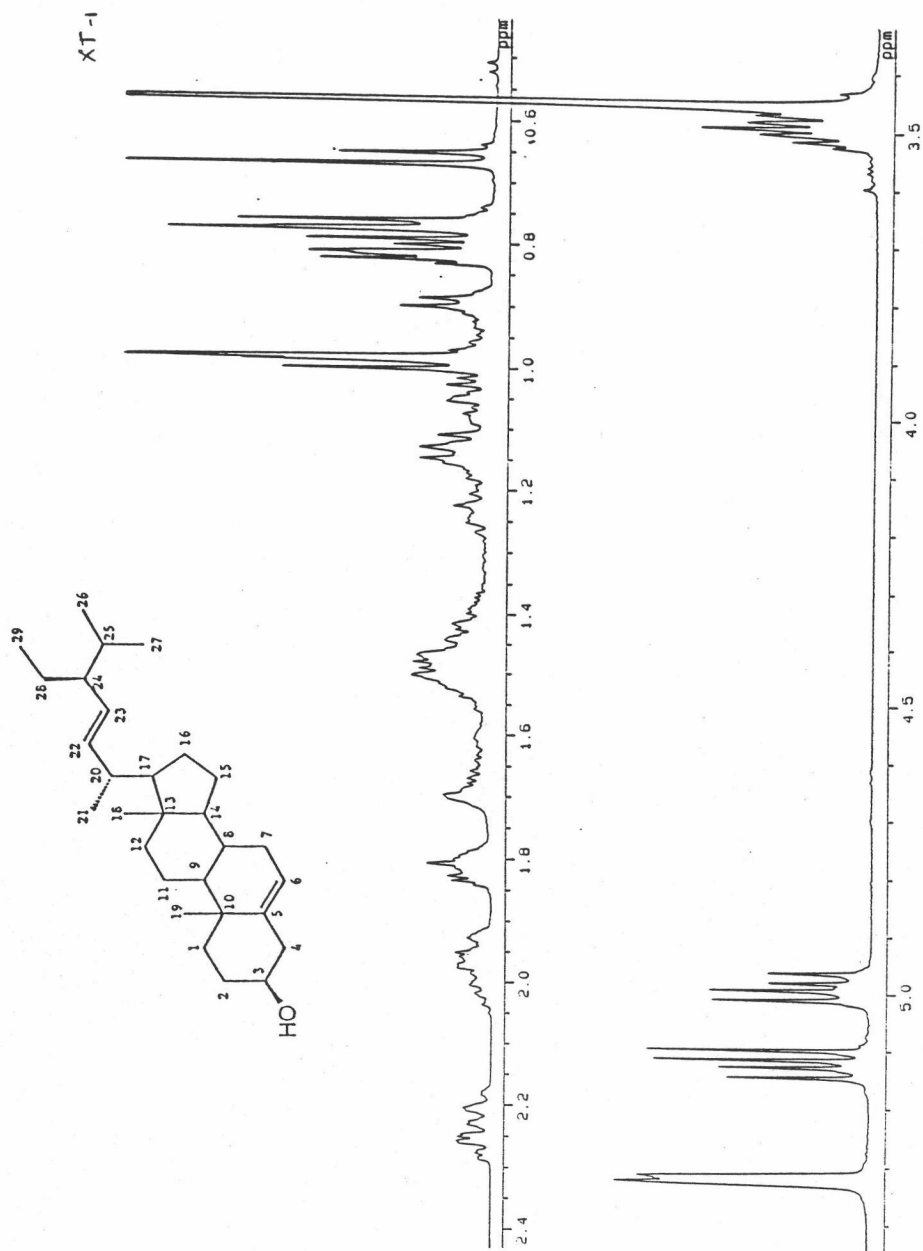

Figure 37 Infrared absorption spectrum of XI-4

Figure 38 ¹H-NMR spectrum of XI-4

Figure 39 Expansion of $^1\text{H-NMR}$ spectrum of XI-4

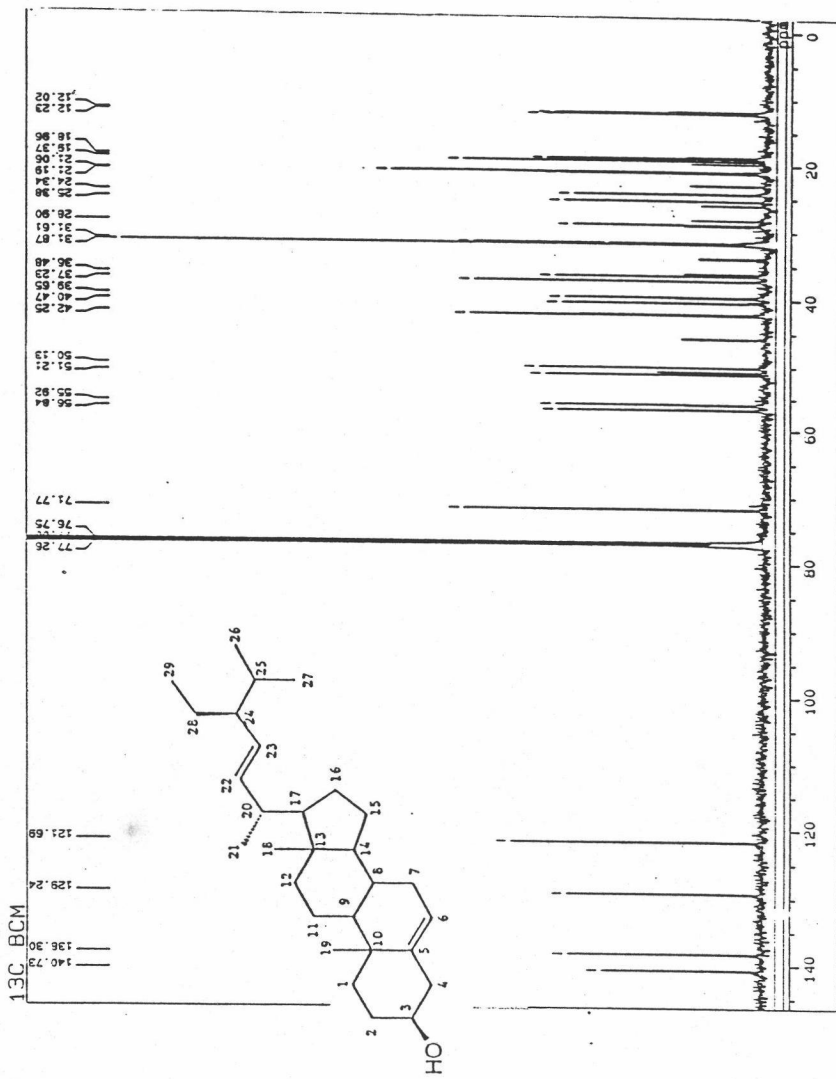
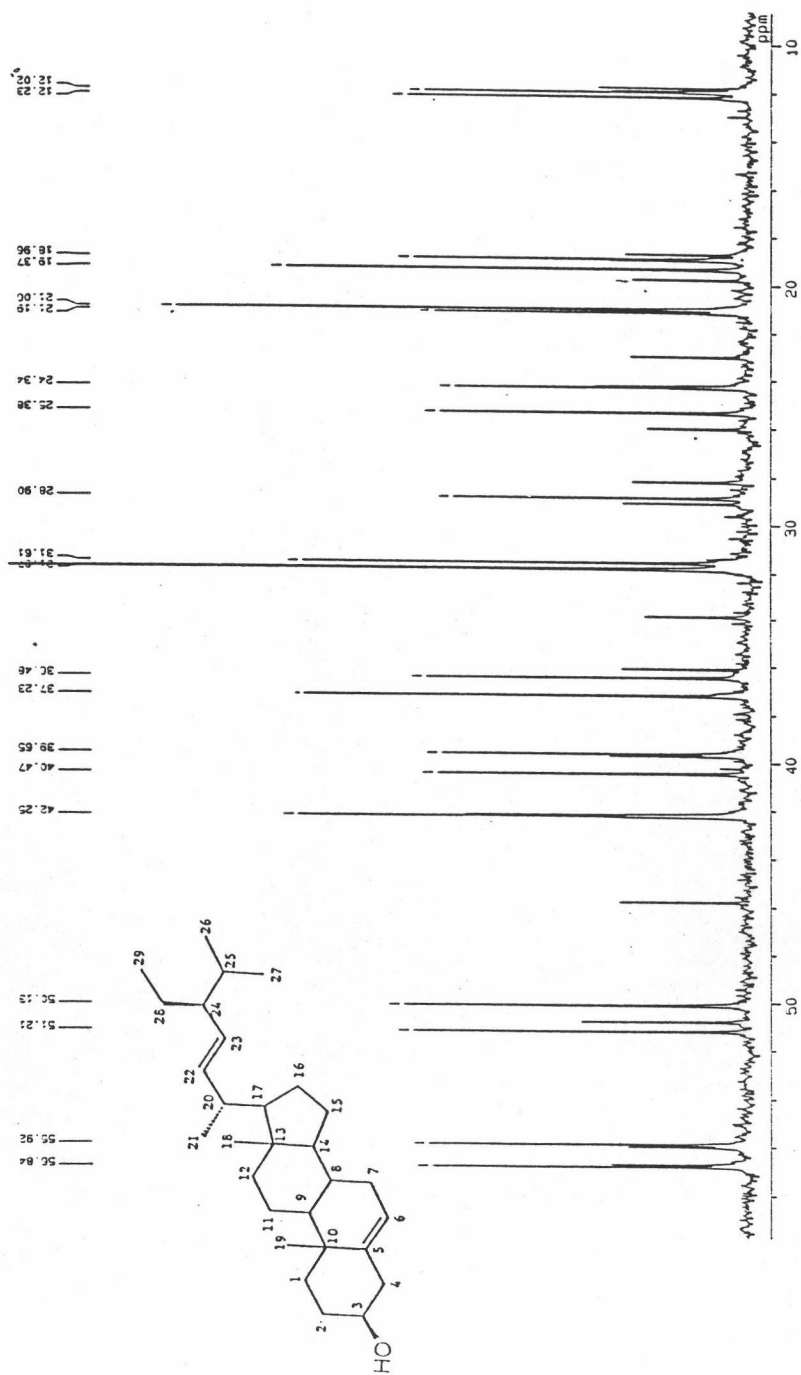

Figure 40 ¹³C-NMR spectrum of XI-4

Figure 41 Expansion of ^{13}C -NMR spectrum of XI-4

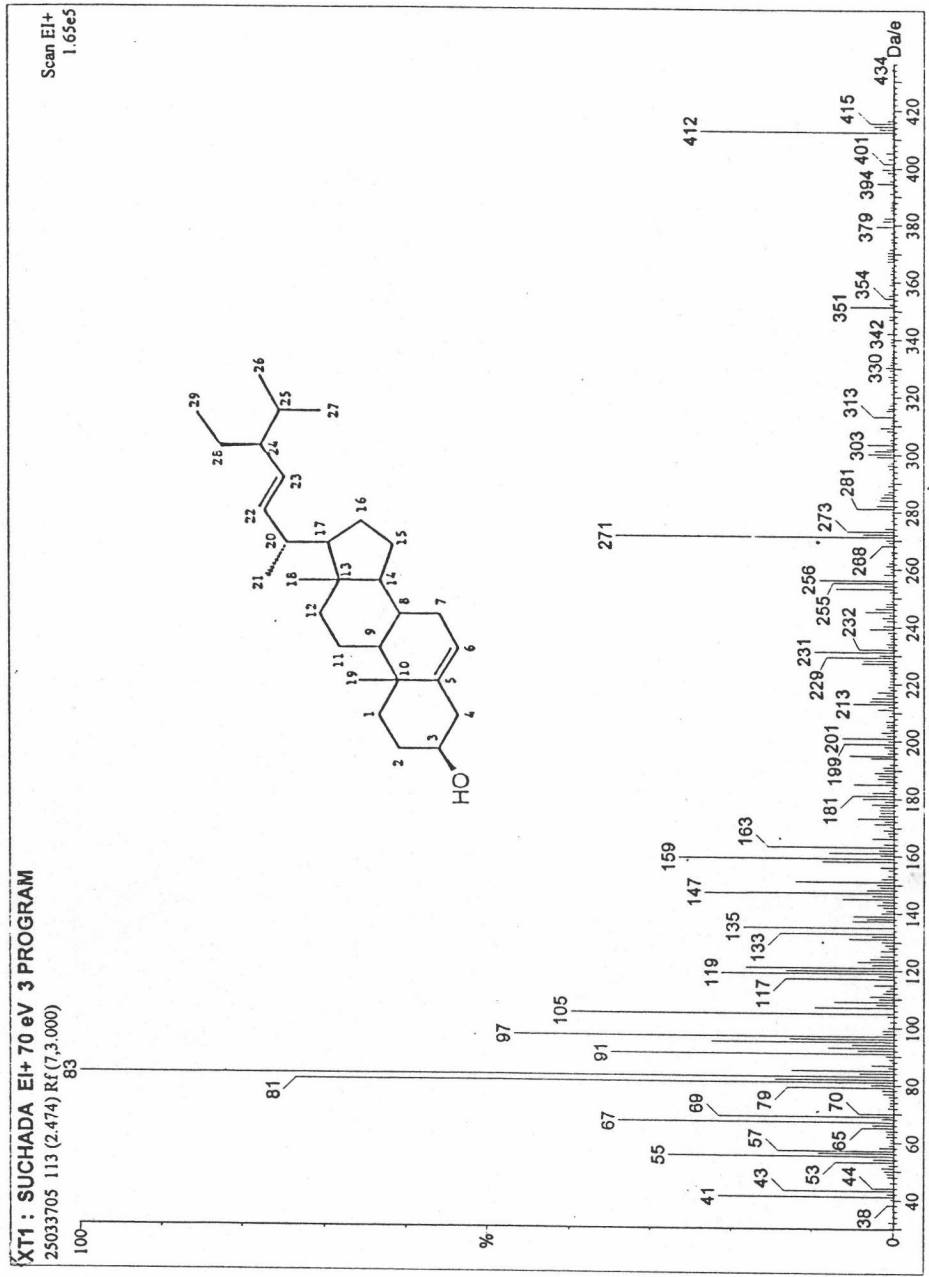

Figure 42 EI mass spectrum of XI-4

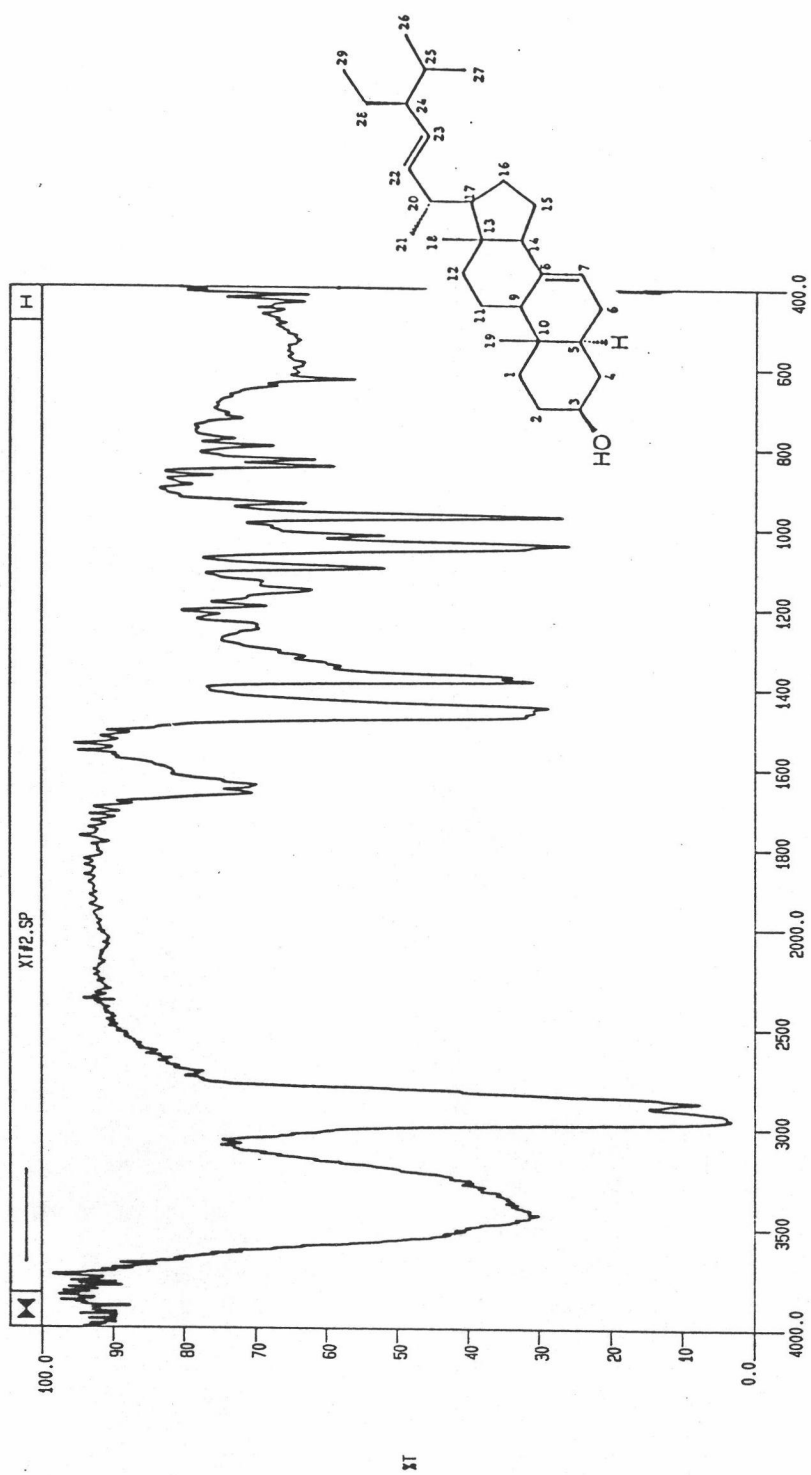
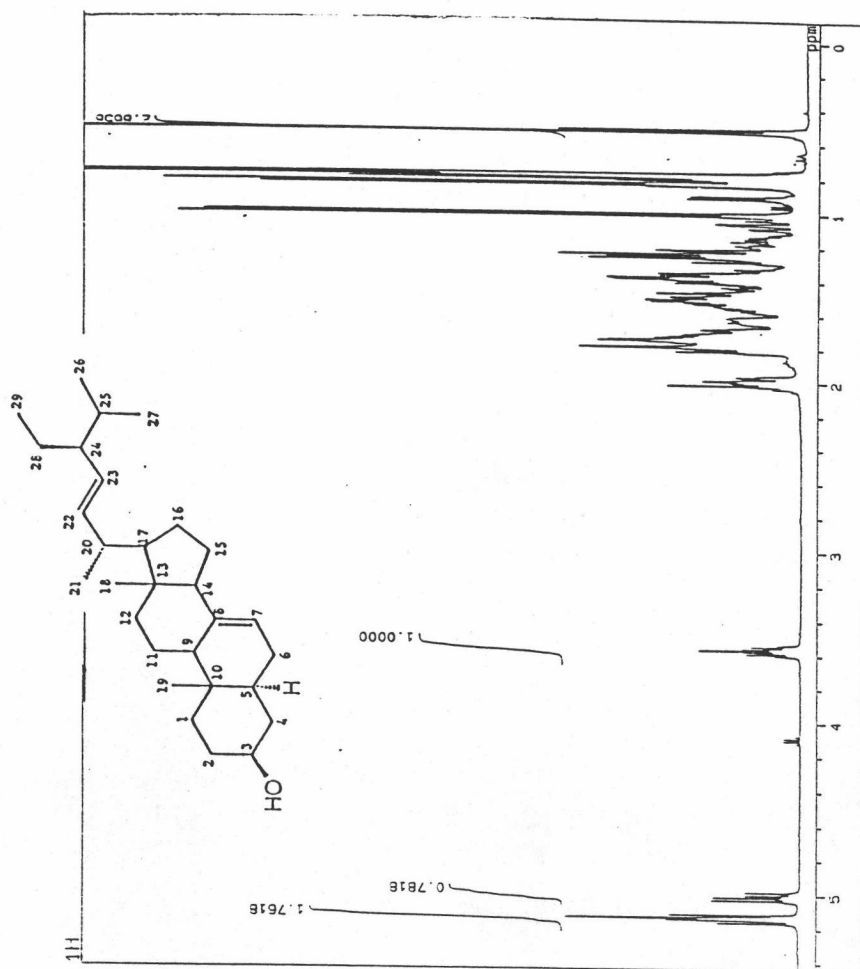
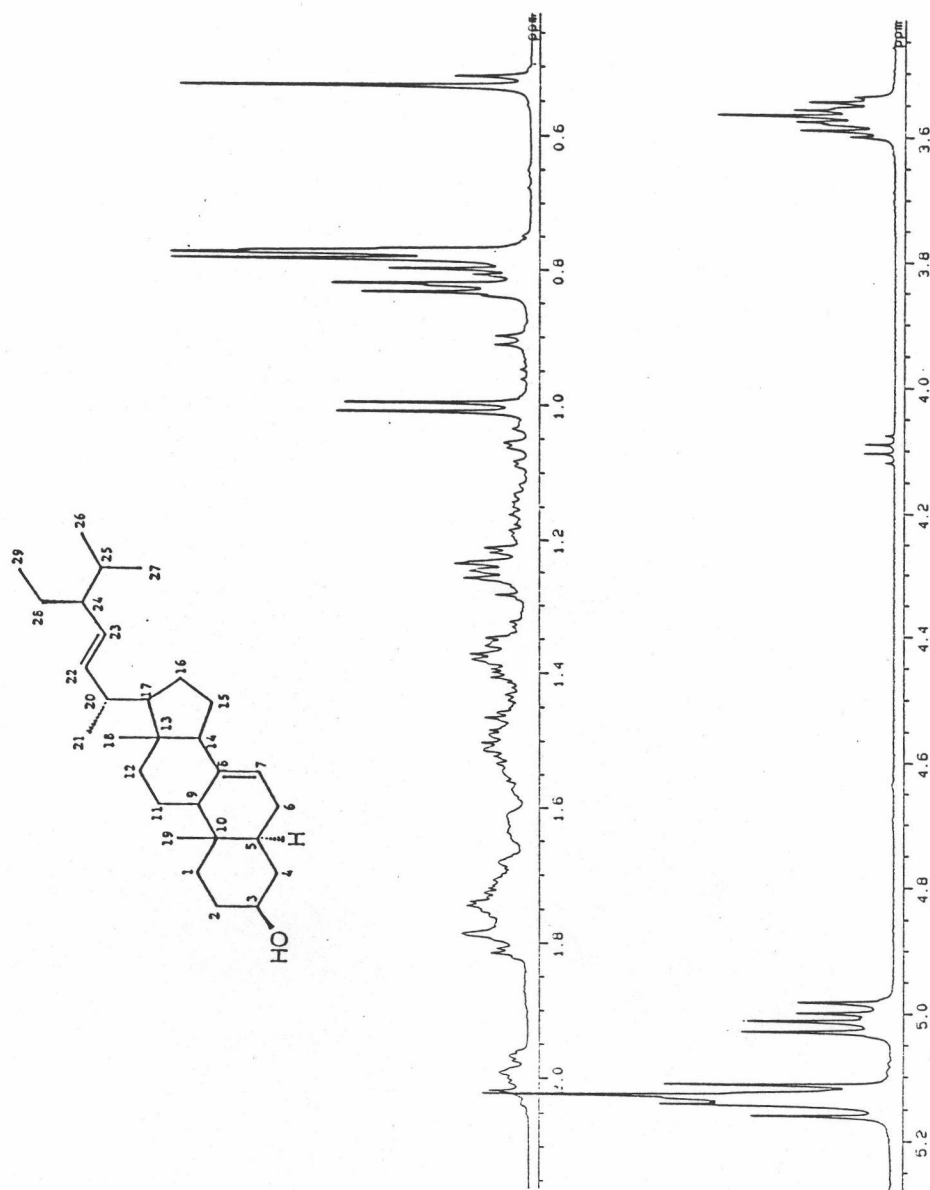
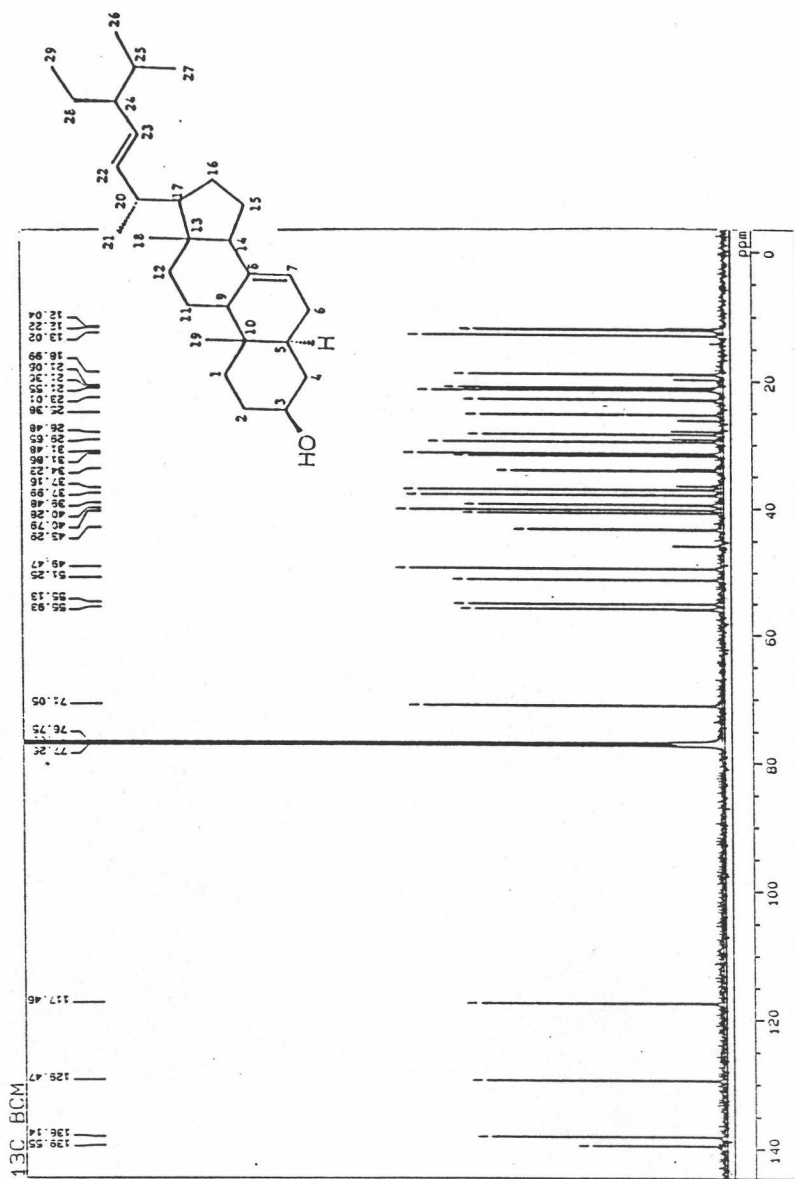

Figure 43 Infrared absorption spectrum of XI-5

Figure 44 $^1\text{H-NMR}$ spectrum of XI-5

Figure 45 Expansion of ¹H-NMR spectrum of XI-5

Figure 46 ^{13}C -NMR spectrum of XI-5

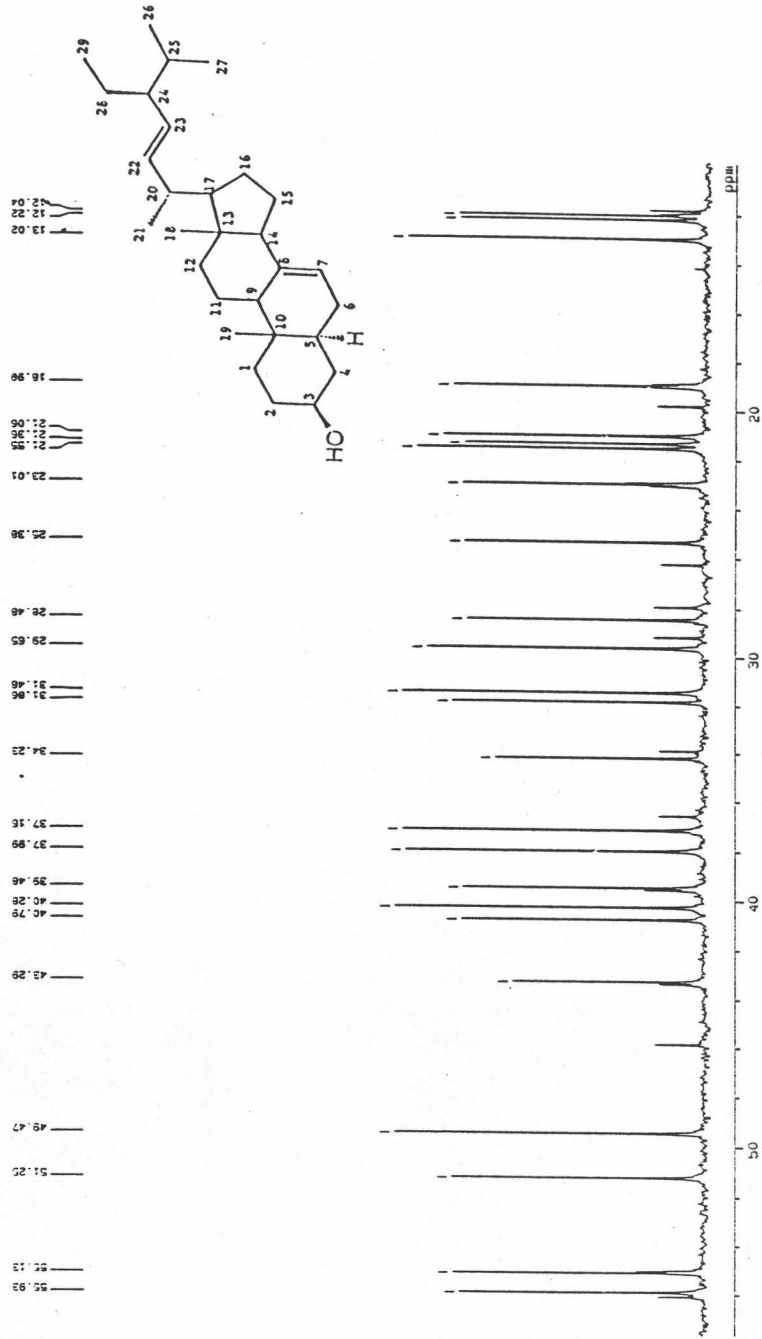

Figure 47 Expansion of ¹³C-NMR spectrum of XI-5

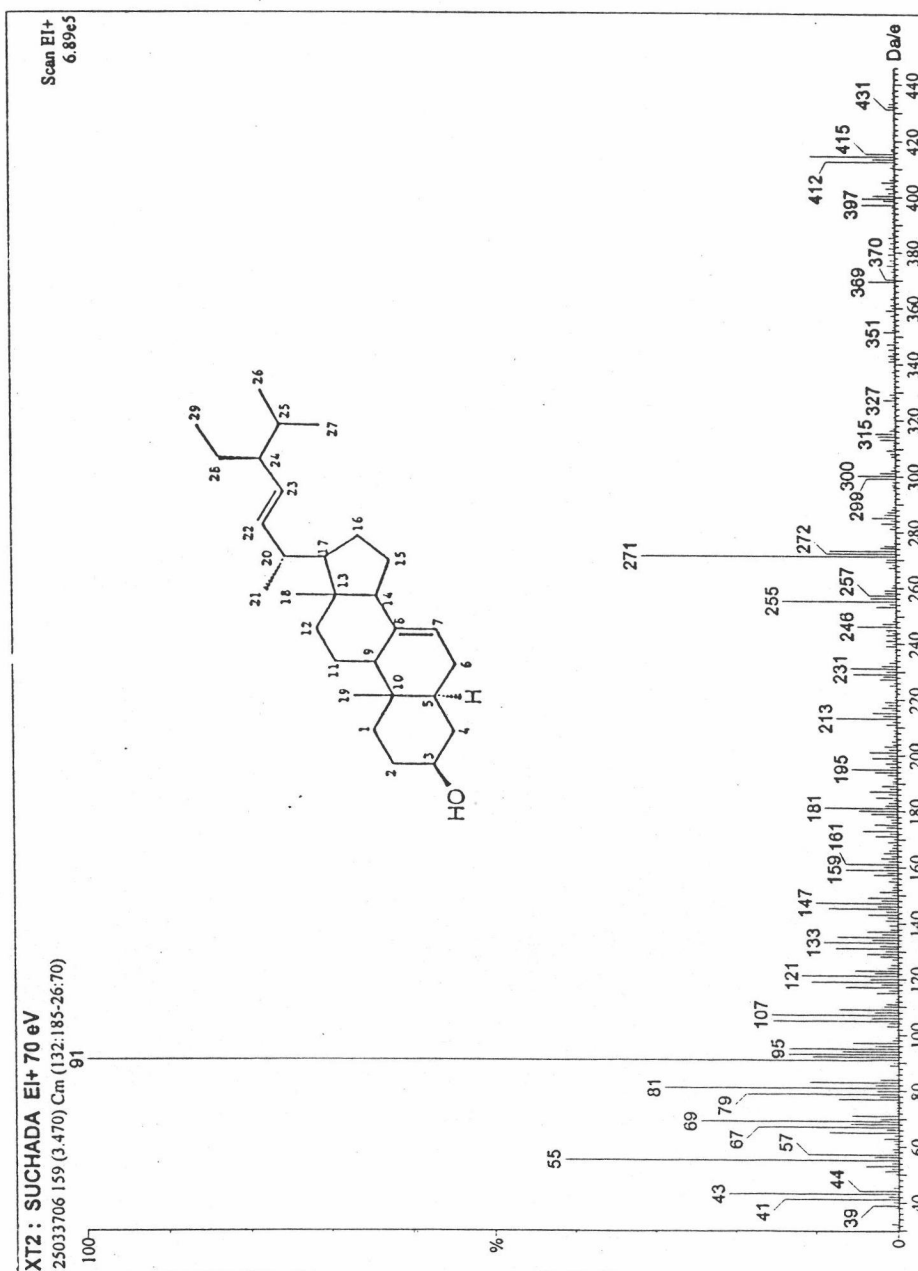

Figure 48 EI mass spectrum of XI-5

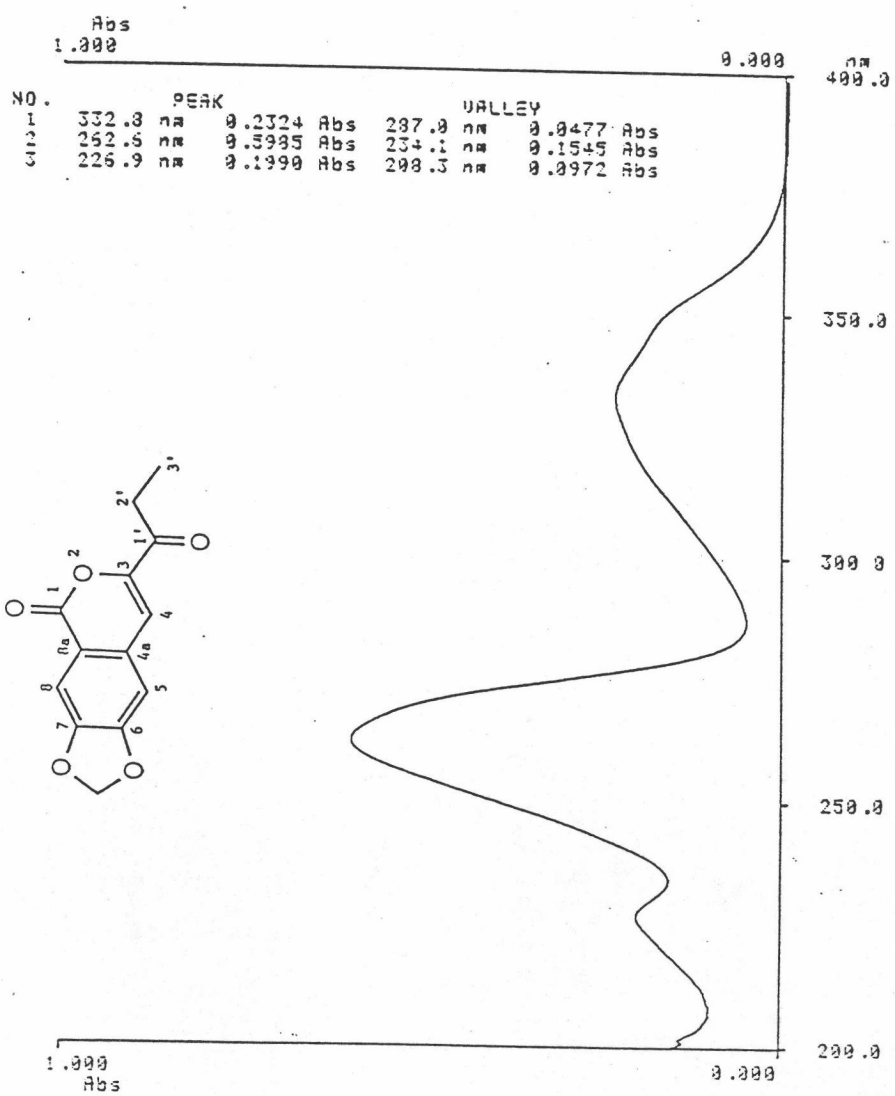

Figure 49 Ultraviolet absorption spectrum of XI-6

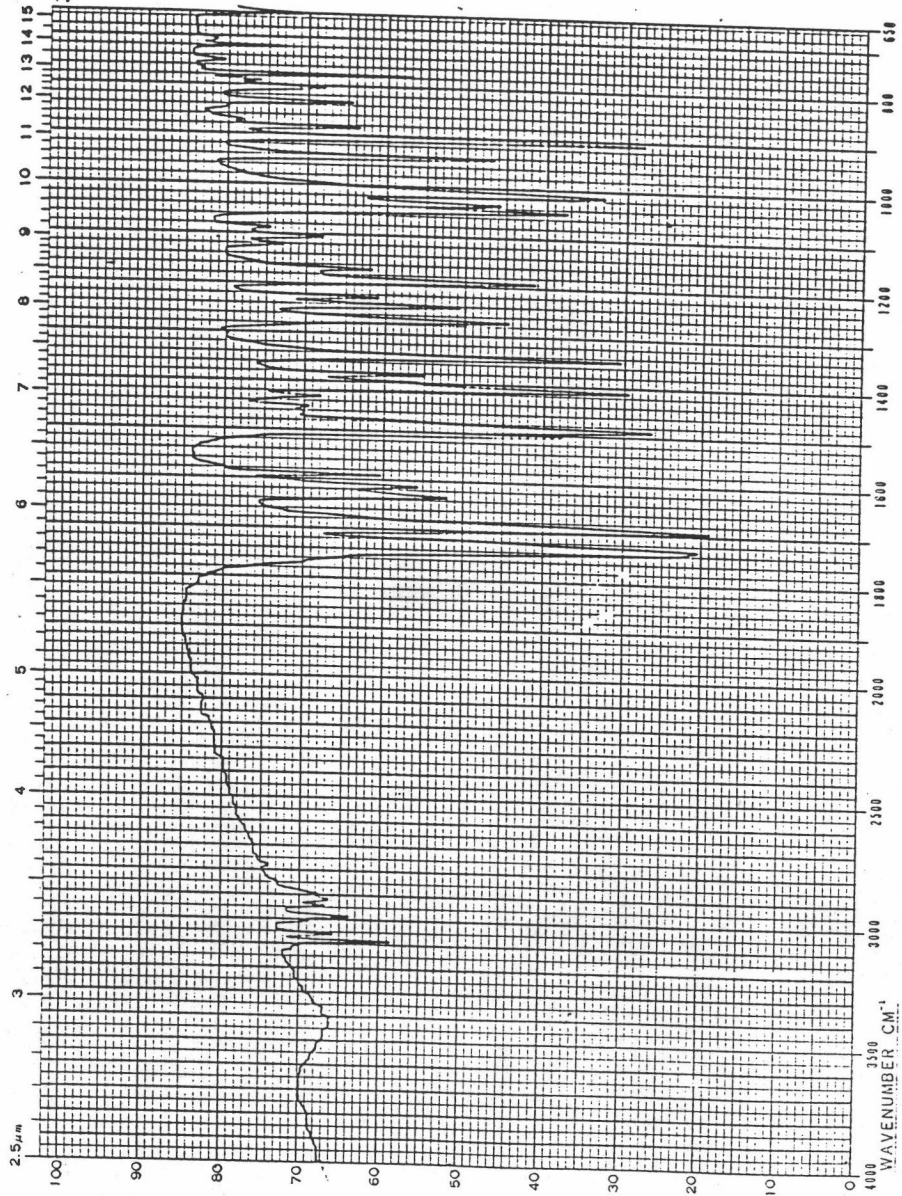
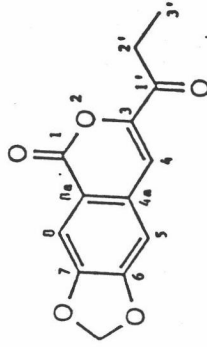
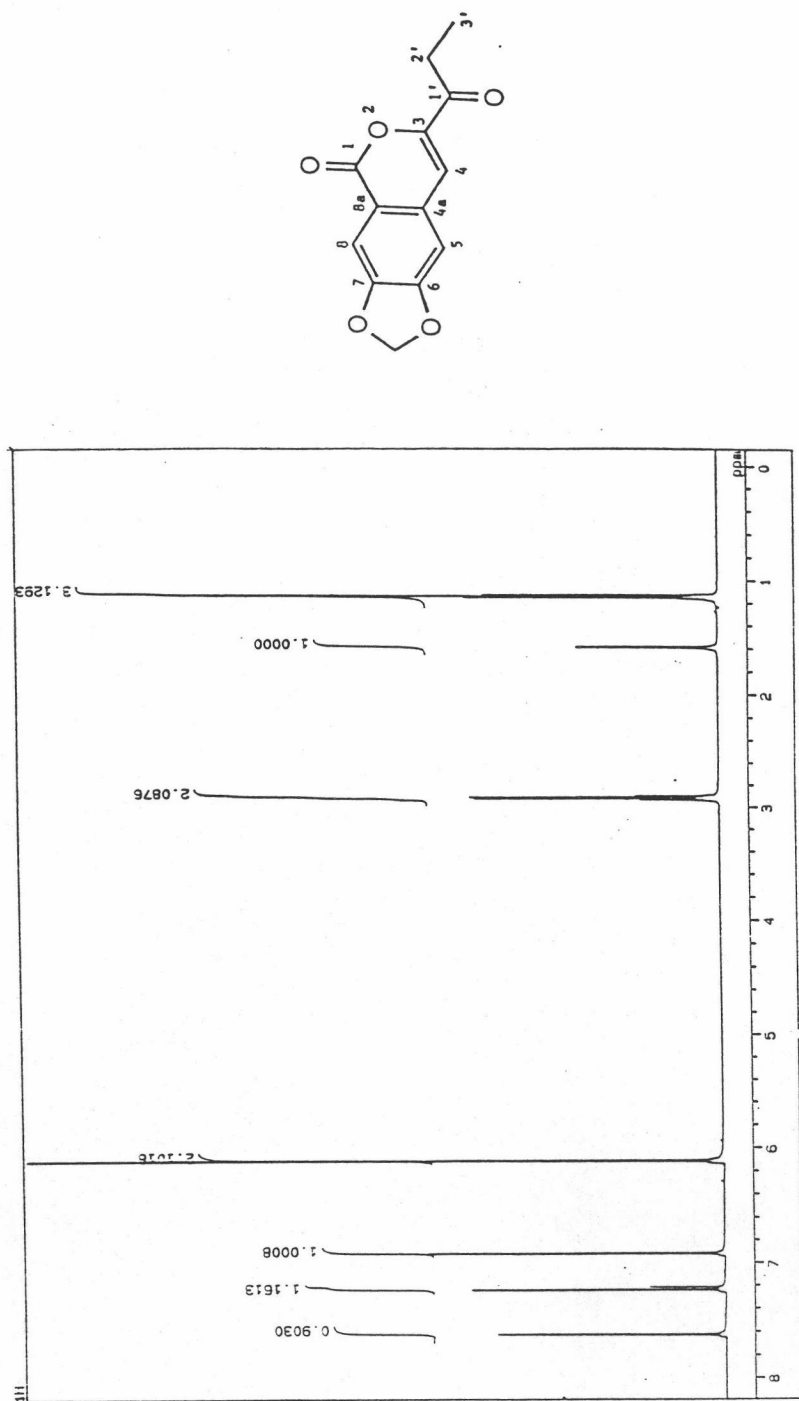
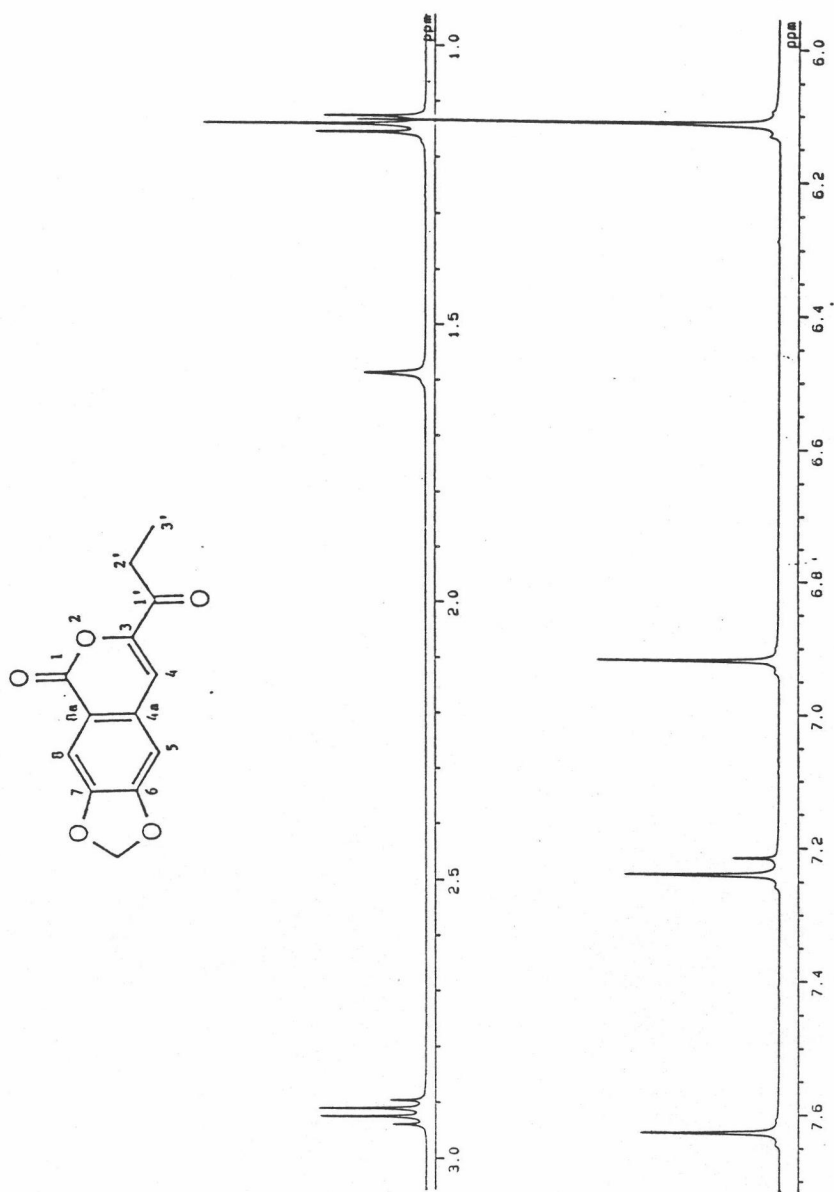
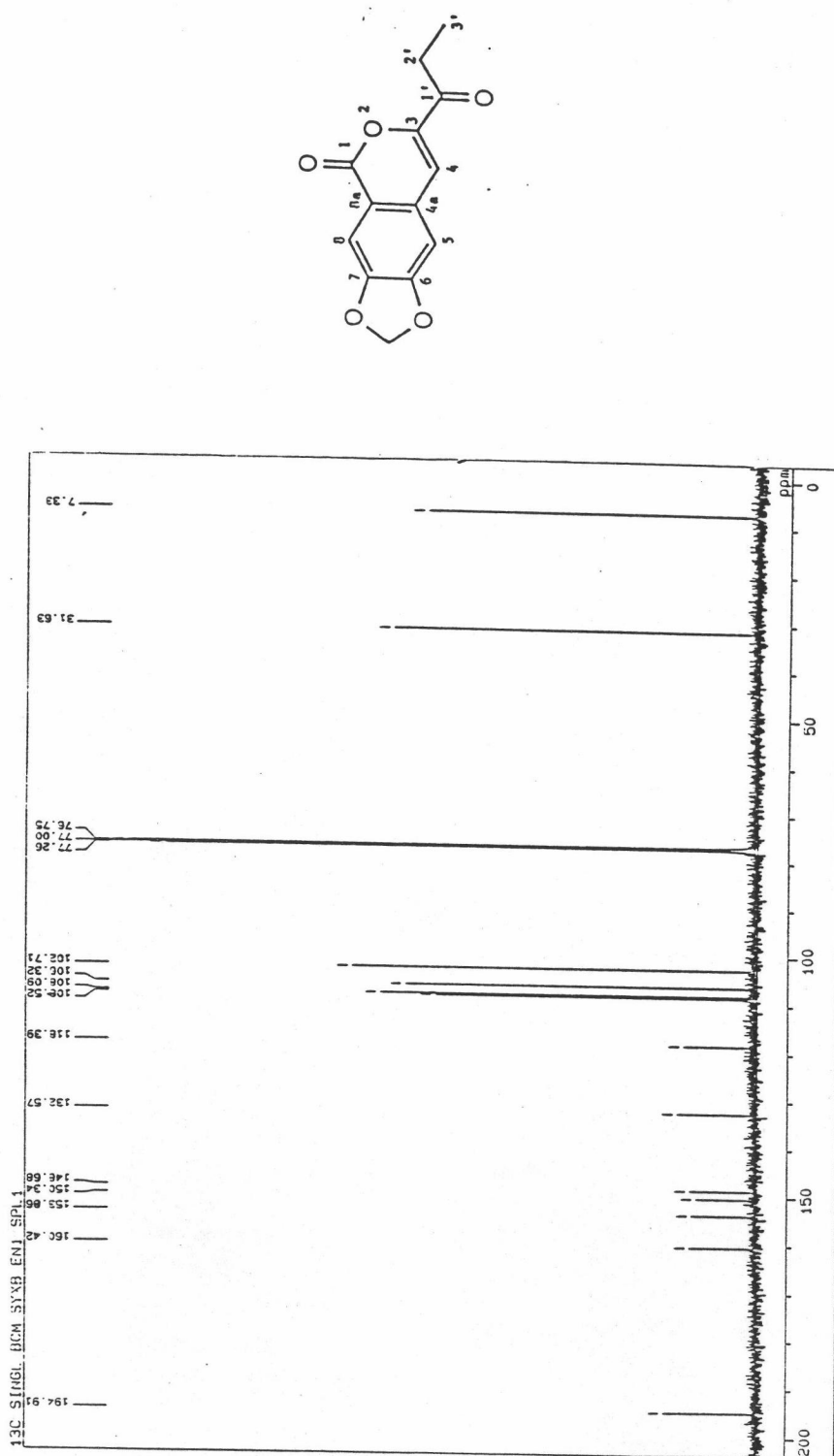
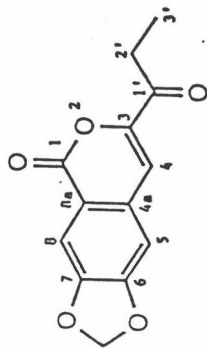
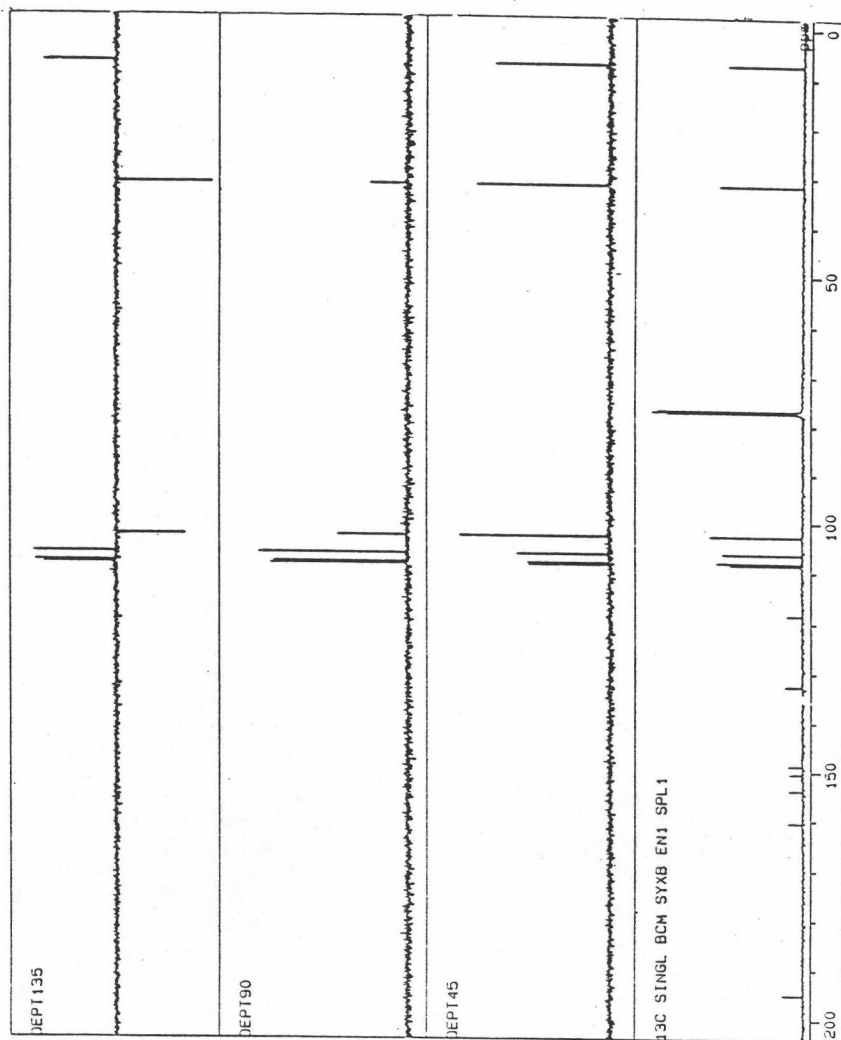

Figure 50 Infrared absorption spectrum of XI-6

Figure 51 ¹H-NMR spectrum of XI-6

Figure 52 Expansion of ¹H-NMR spectrum of XI-6

Figure 53 ^{13}C -NMR spectrum of XI-6

Figure 54 ¹³C-NMR spectrum of XI-6 (DEPT)

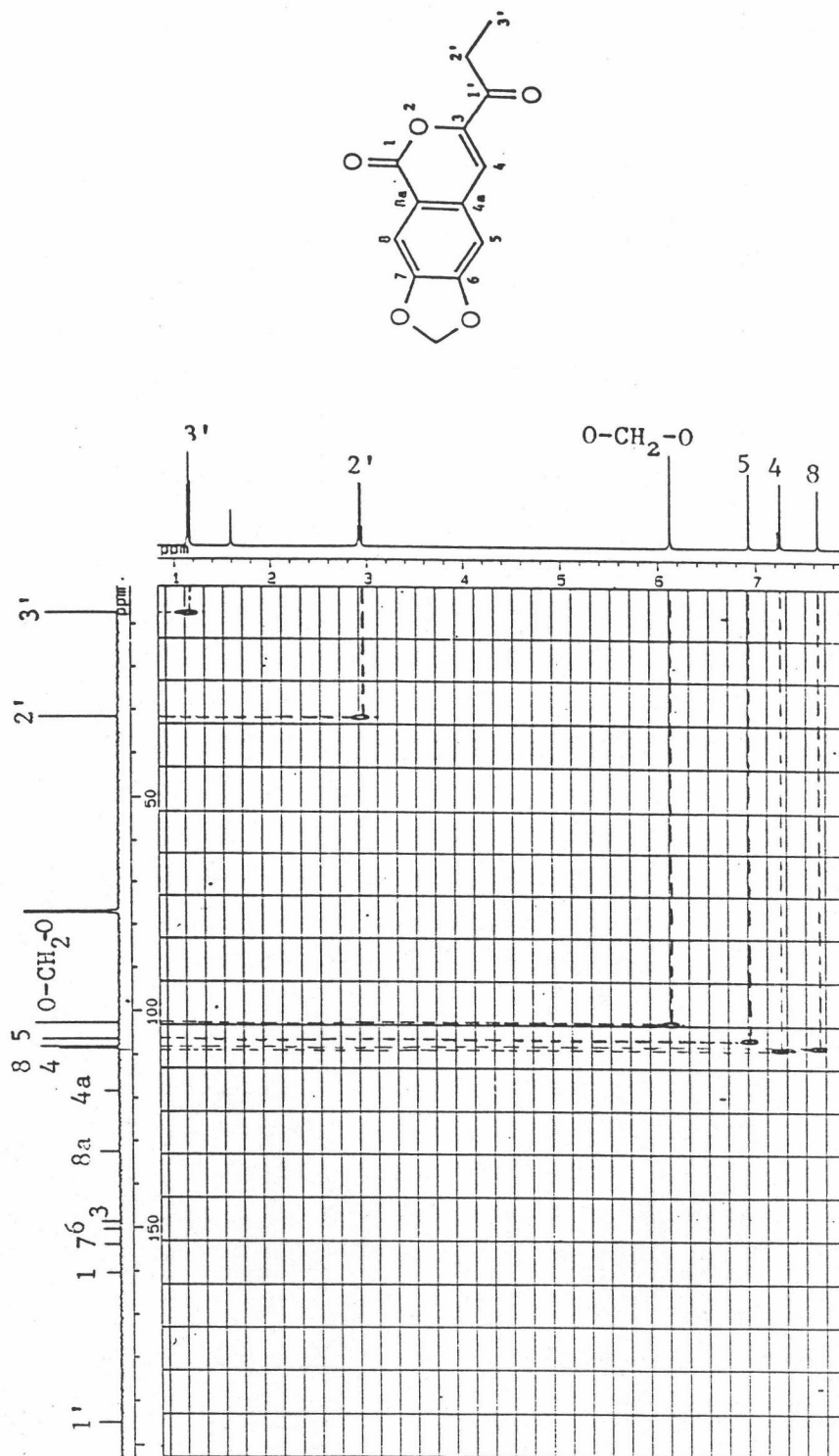
Figure 55 ^{13}C - ^1H COSY spectrum of XI-6

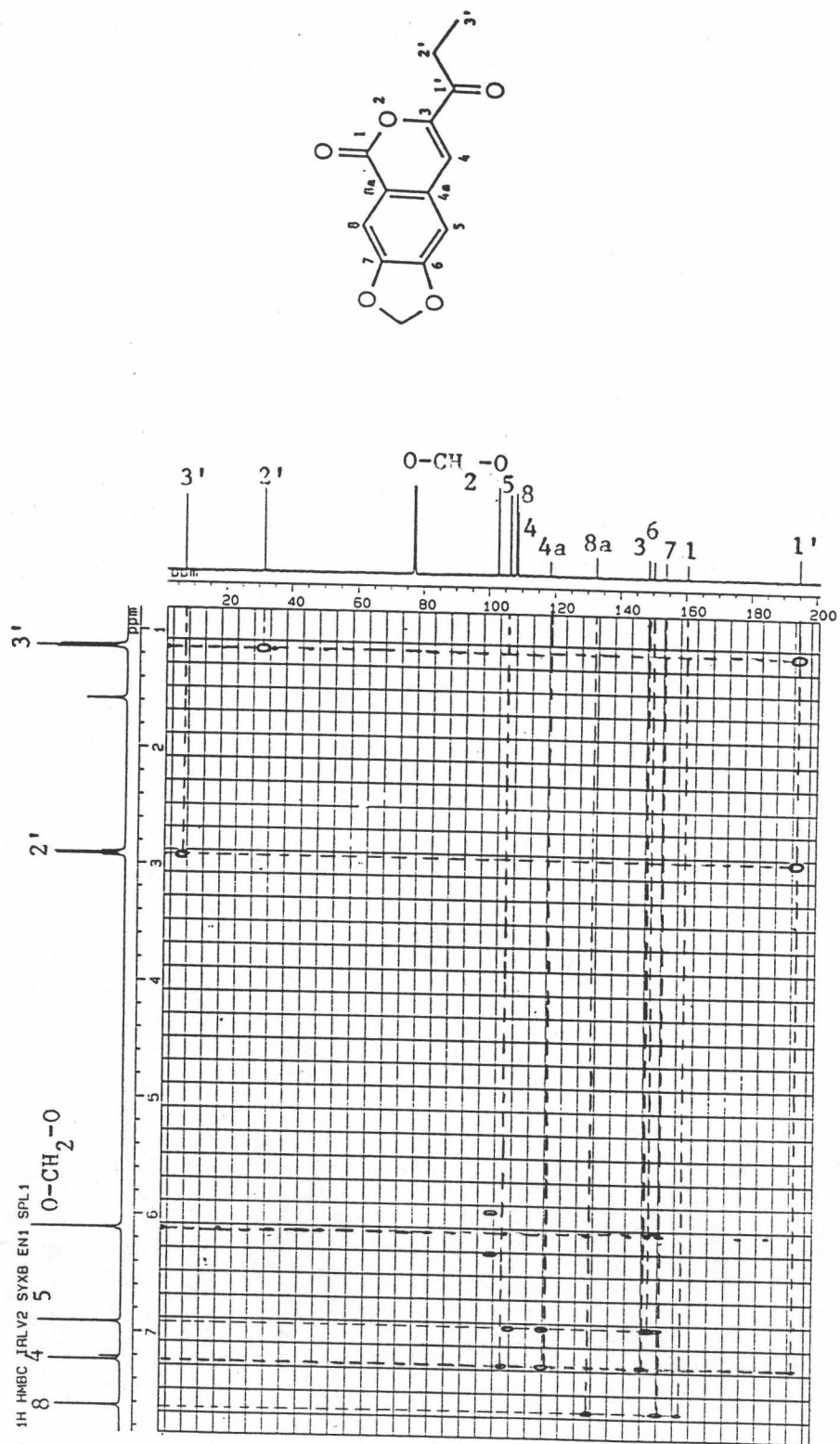

Figure 56 HMBC spectrum of XI-6

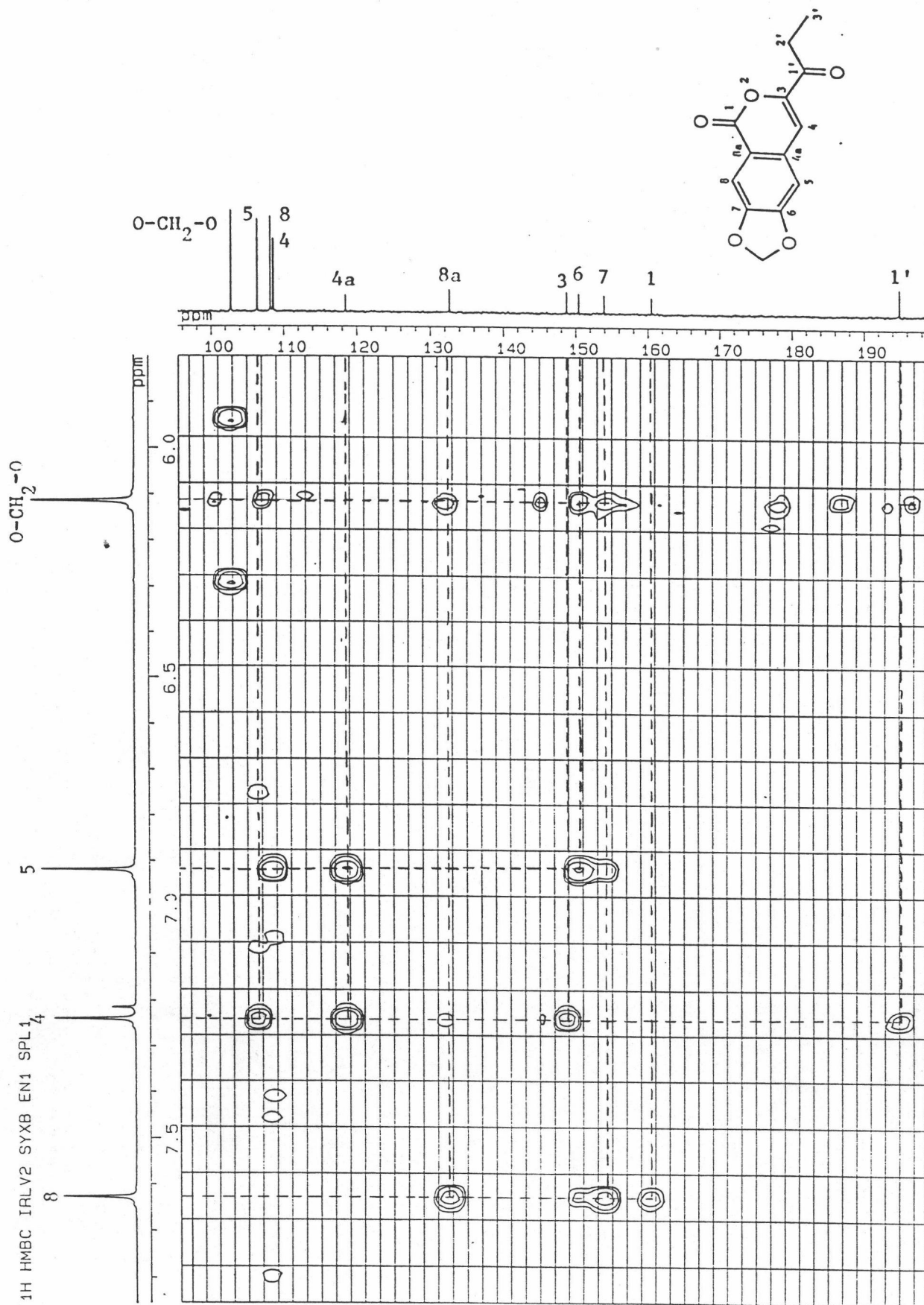

Figure 57 Expansion of HMBC spectrum of XI-6

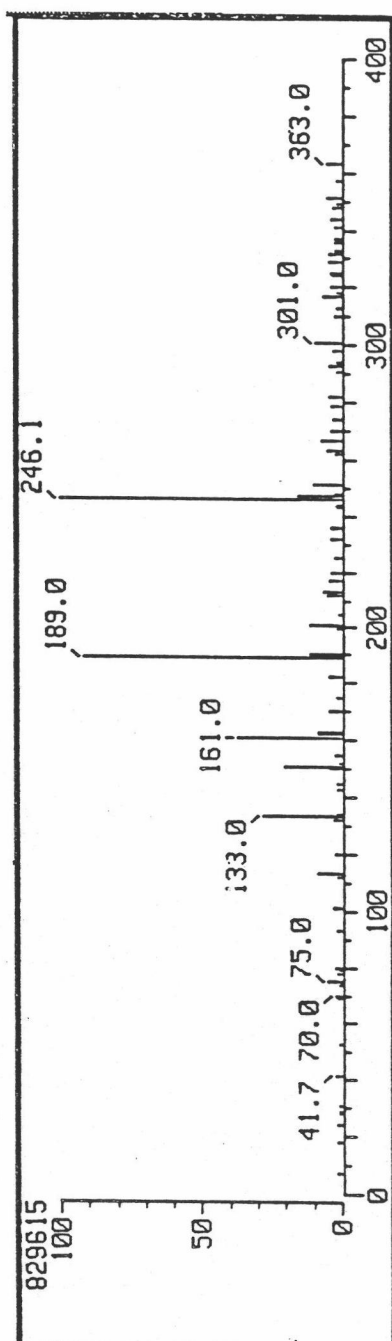
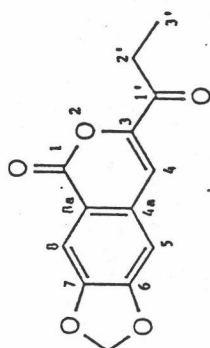

Figure 58 HREIMS spectrum of XI-6

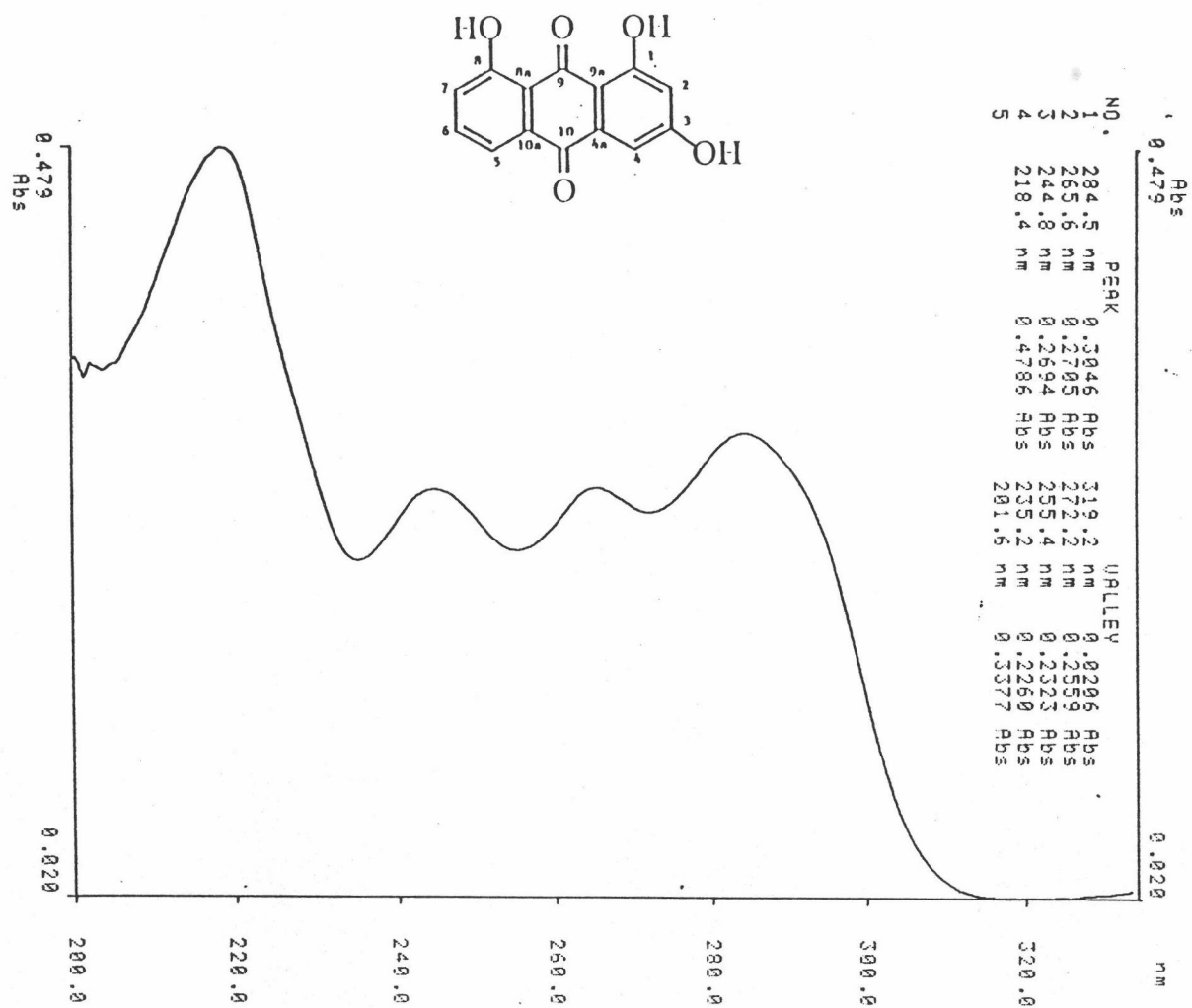

Figure 59 Ultraviolet absorption spectrum of XI-7

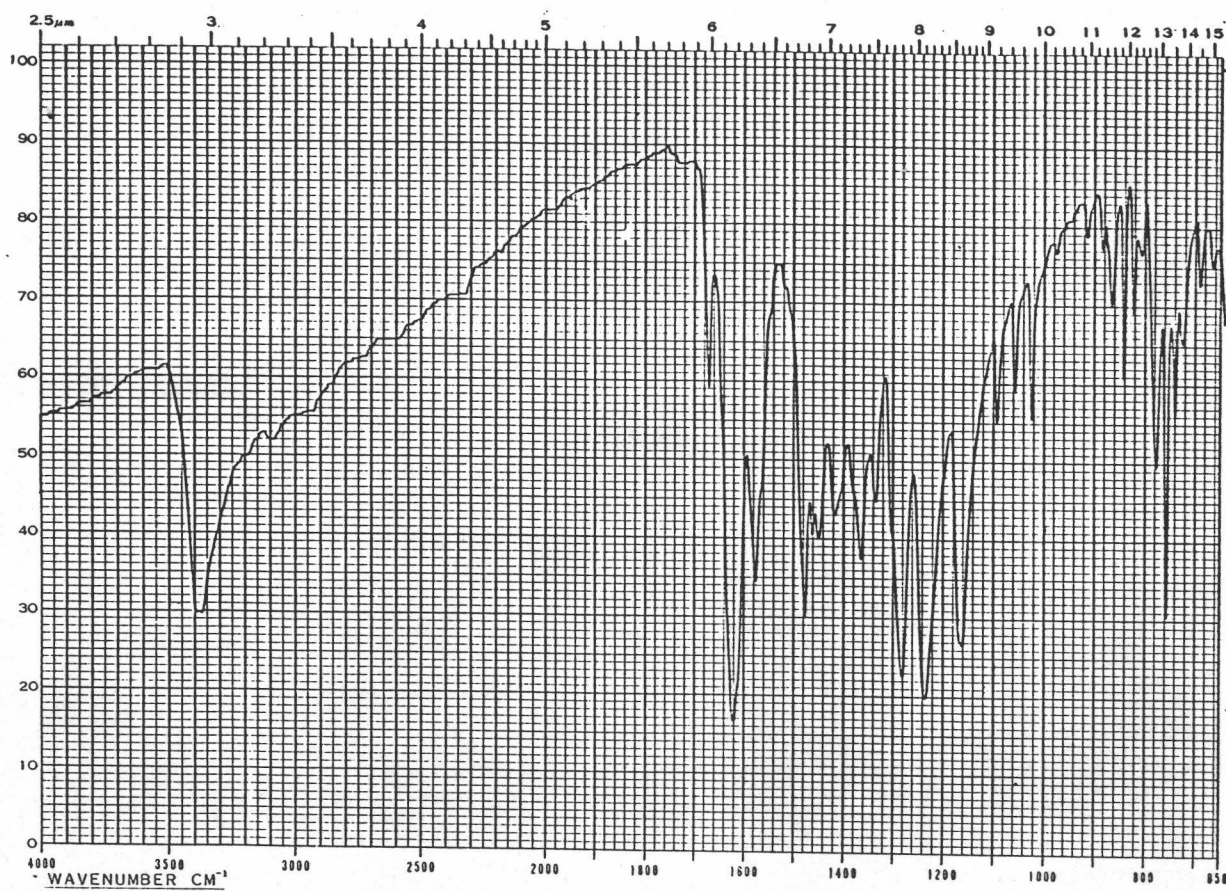
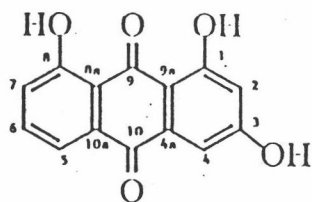
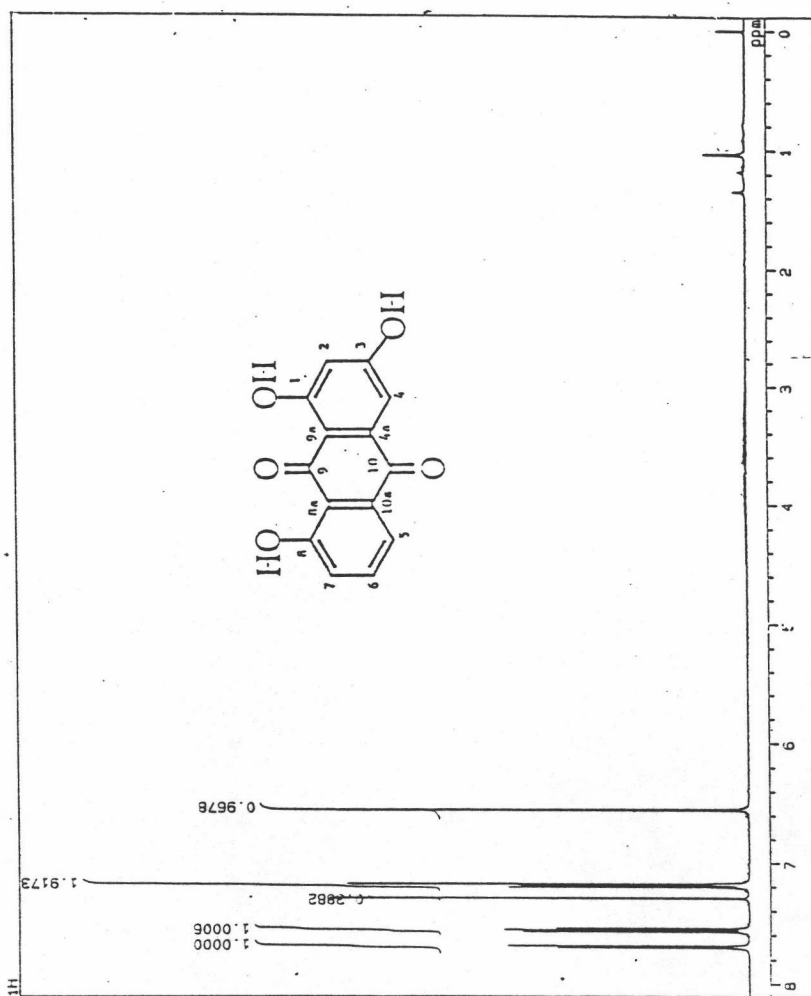
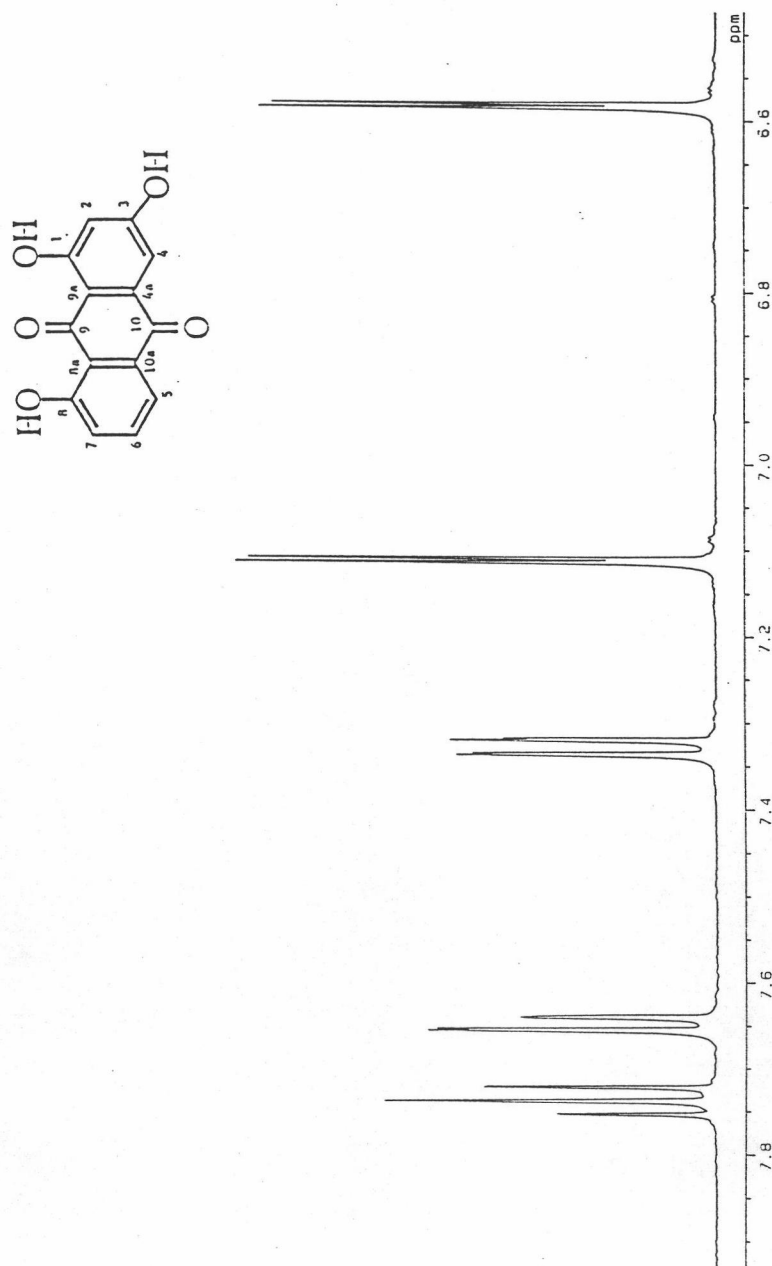

Figure 60 Infrared absorption spectrum of XI-7

Figure 61 $^1\text{H-NMR}$ spectrum of XI-7

Figure 62 Expansion of $^1\text{H-NMR}$ spectrum of XI-7

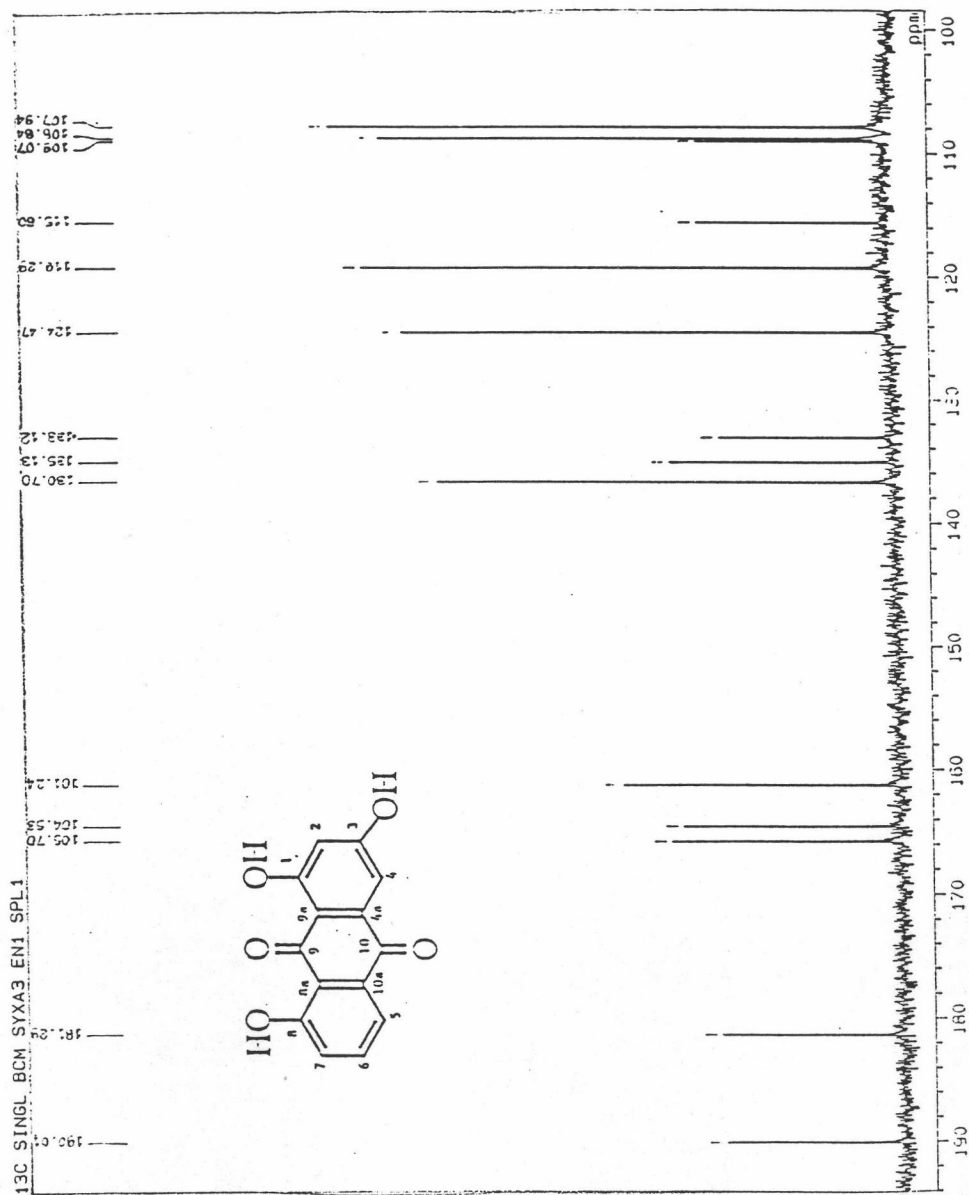
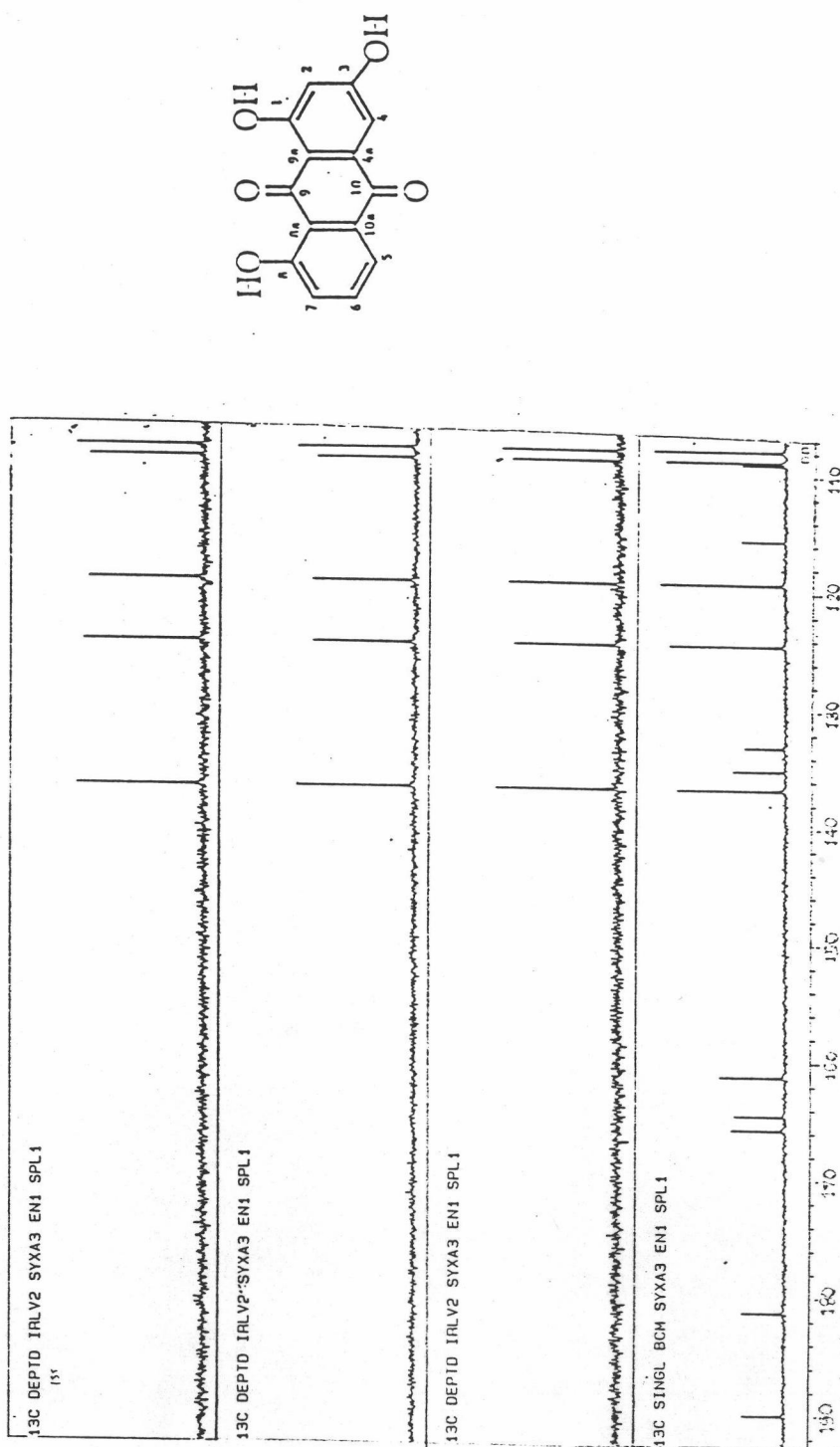

Figure 63 ¹³C-NMR spectrum of XI-7

Figure 64 ^{13}C -NMR spectrum of XI-7 (DEPT)

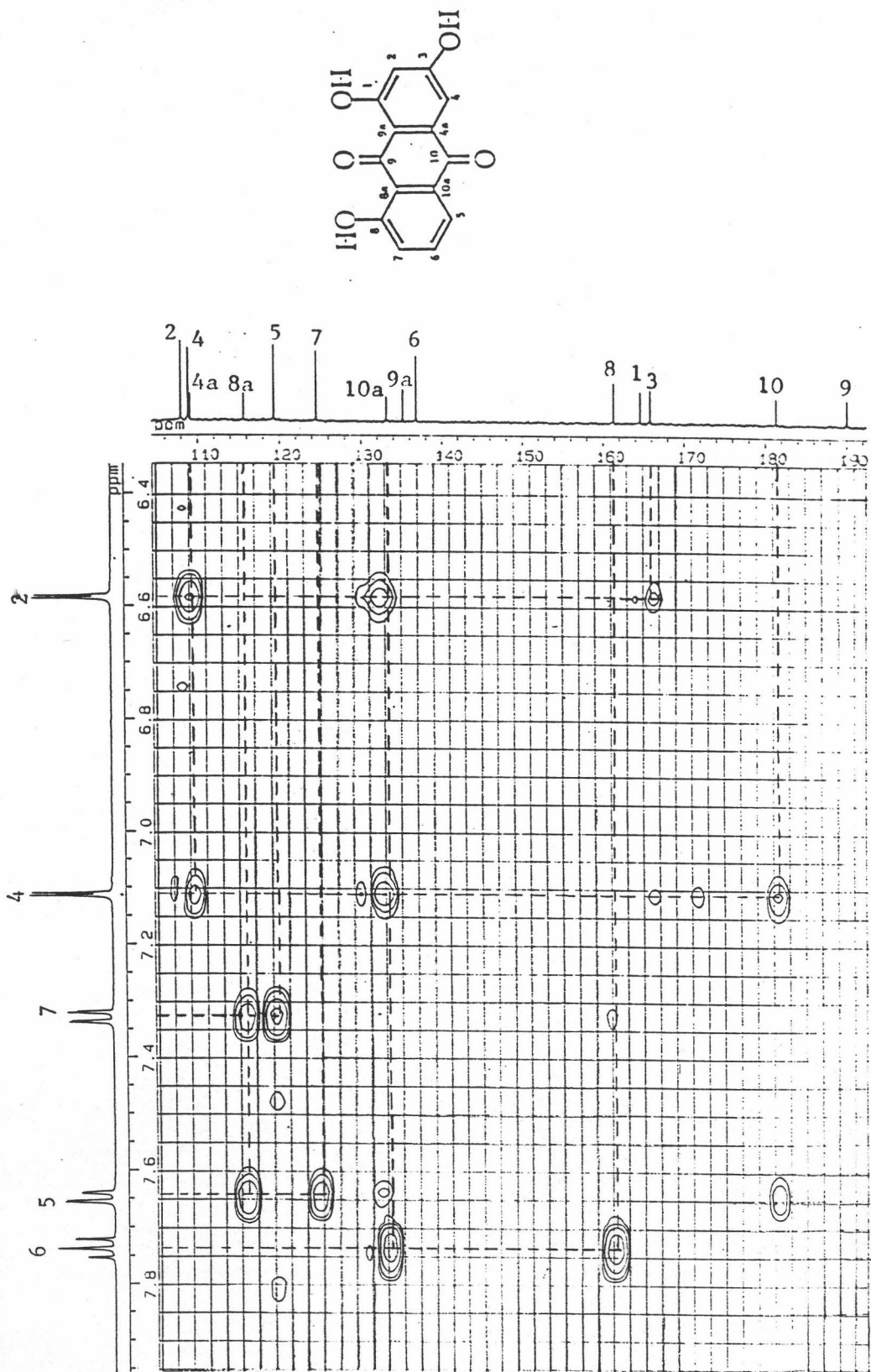

Figure 65 HMBC spectrum of XI-7

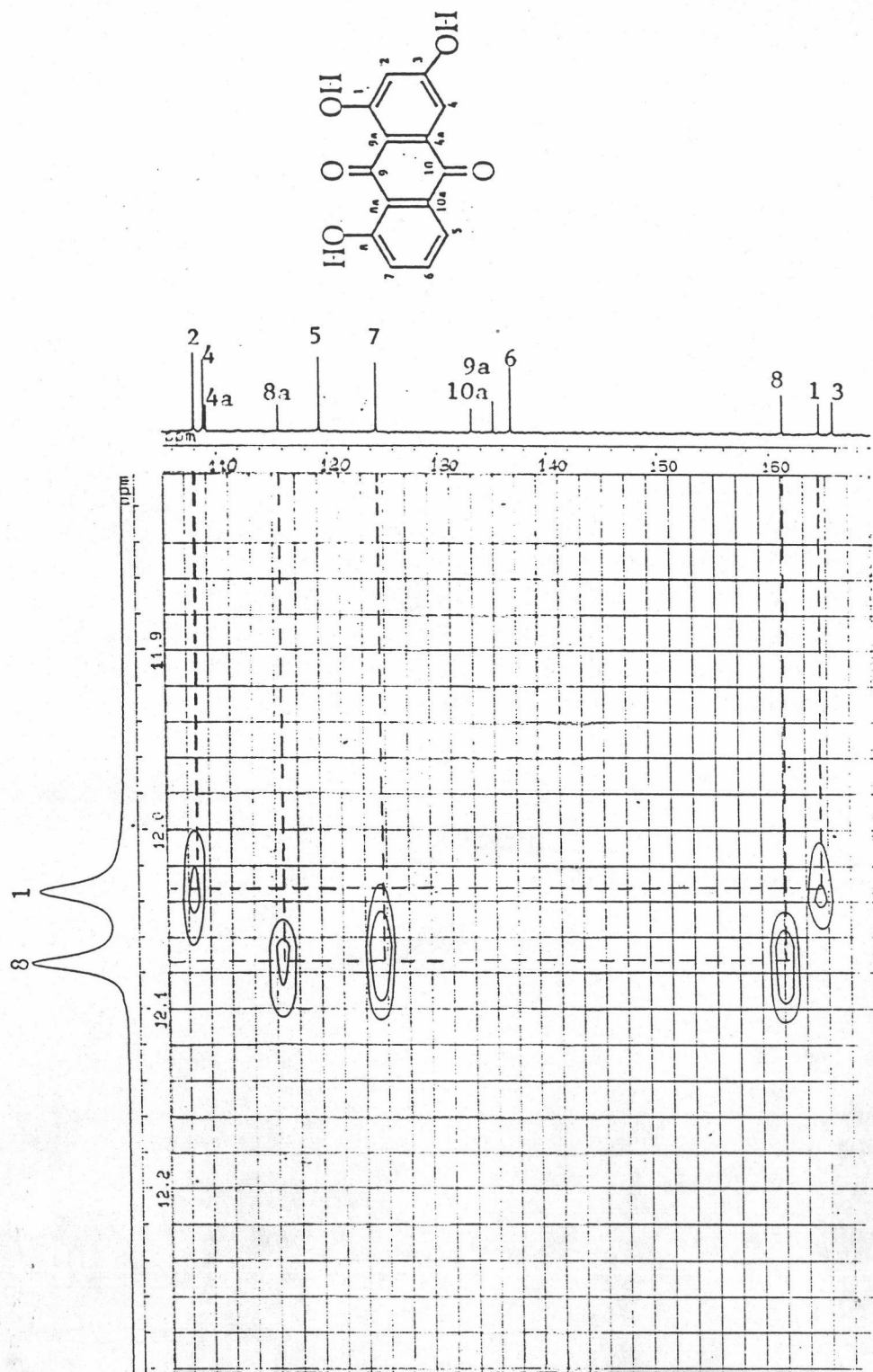

Figure 66 Expansion of HMB spectrum of XI-7

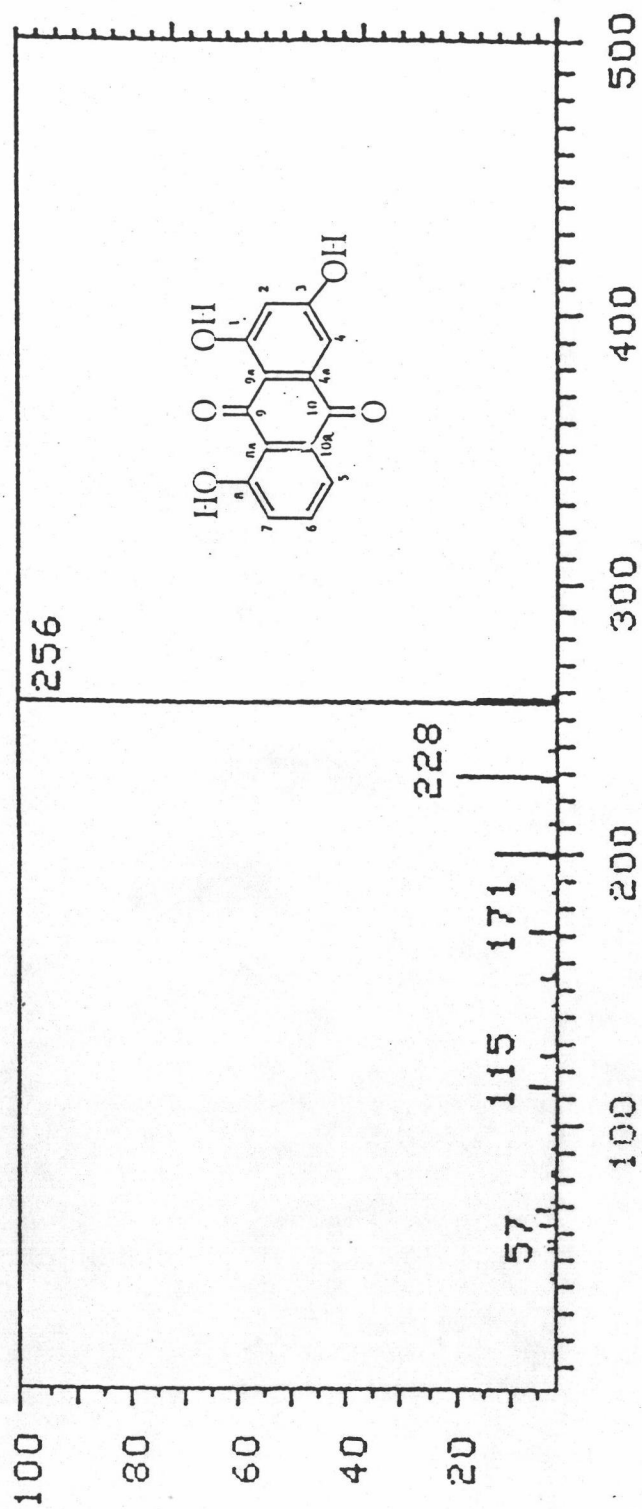

Figure 67 HREIMS spectrum of XI-7



VITA

Police Lieutenant Suchada Sukrong was born on October 19, 1967. in Nonthaburi, Thailand. She received her bachelor of Science in pharmacy in 1990 from the Faculty of pharmaceutical Science, Chulalongkorn University, Bangkok, Thailand. At present, she is a pharmacist at Police General Hospital, Bangkok, Thailand.