



CHAPTER II

THEORETICAL BACKGROUND AND LITERATURE REVIEW

2.1 The Atmospheric Distillation Unit

The most common separation process in refinery is atmospheric distillation which utilizes the difference in boiling point. The objective is to separate the mixture into several fractions. Figure 2.1 shows a typical process flow scheme of an atmospheric distillation unit. Crude distillation unit consists of a desalter, an atmospheric tower, three side strippers and a debutanizer/splitter. Crude oil is preheated by exchanging heat with pump-around reflux streams and then sent to a desalter to remove salts, solids and water. The desalted crude oil is further preheated by exchanging heat with products and pump-around reflux stream.

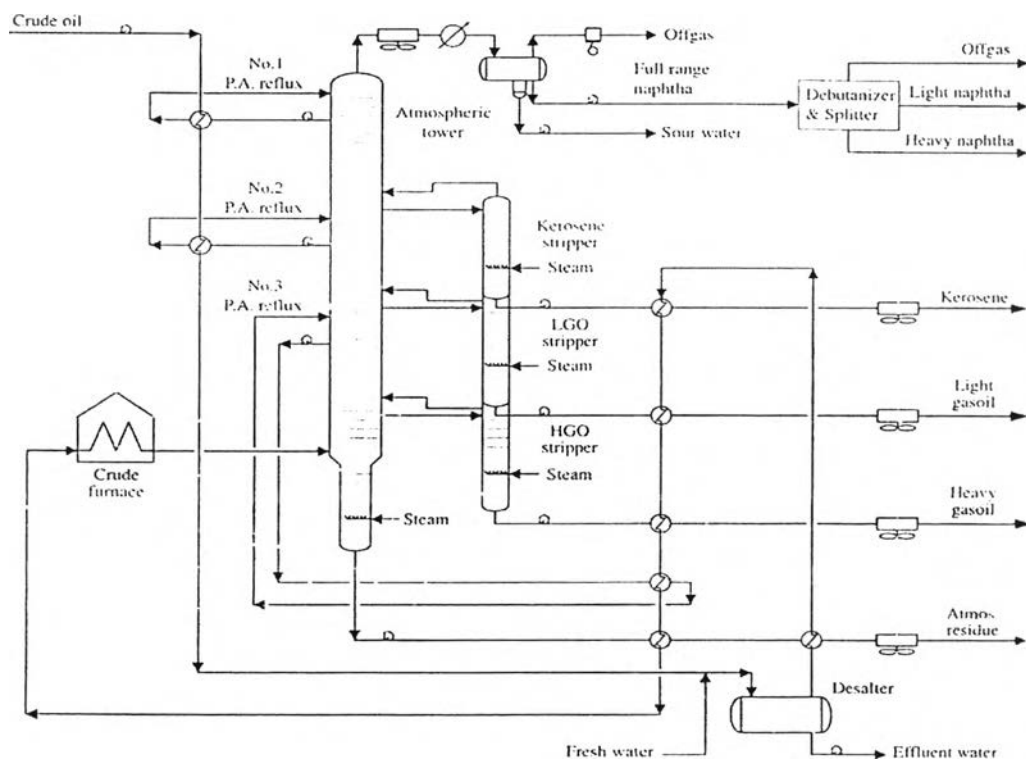

Figure 2.1 Process Flow Scheme of an atmospheric distillation unit.

(Lorenz *et al.*, 1997).

Before reaching the tower, desalted oil heated by a crude furnace to a temperature which provides the required degree of vaporization. The hot crude oil enter to the flash zone of the atmospheric tower, most of it vaporizes. The liquid portion of the flashed crude that is the residue with small amount of components in the range of gas oil flows down to a bottom stripping section of the atmospheric tower, where distillate fractions dissolved in the liquid are vaporized with steam stripping. While the vapor includes all the components that comprise the products rise through the distillation trays.

The mixed vapor stream rises up the column through the trays and counter-current to the internal reflux liquid flowing down the column that condensation and fractionation of distillate products take place on the trays. The internal reflux liquid is created by condensation of the ascending oil vapor that has contacted cooled pump-around liquid. Pump-around circuit steams prepares reflux streams of different temperature levels, and enables effective utilization of the reflux heat load for heating the crude oil feed. The condensed liquid is withdrawn from the side of column as side-stream products such as kerosene, light gas oil and heavy gas oil. These streams are sent to side strippers, where the lighter gas and oil fractions are removed by steam stripping for adjustment of the flash point. The bottoms of the side strippers are withdrawn as distillate products such as kerosene, light gas oil and heavy gas oil. The topped vapor of the atmospheric tower is condensed at the top condenser. The condensed liquid, called full boiling range naphtha, is sent to a debutanizer to remove the butane and lighter gases. The debutanizer offgas and gases not condensed in condenser(s) of the atmospheric tower are sent to a gas concentration unit to recover propane and butane (LPG). The debutanizer full range naphtha is separated into light and heavy naphtha by a splitter.

2.2 Heat Exchanger Network Synthesis

Heat exchanger network (HEN) synthesis is one of the most extensively studied problems in industrial process synthesis. In all chemical industries, the energy consumption for the processes represents an important part of the operating costs, which makes the efficient use of the energy an important issue. Because of the

need for heat recovery, almost every chemical industry is nowadays heat integrated by one or more networks of heat exchangers. This is attributed to the importance of determining the energy costs for a process and improving the energy recovery in industrial sites. The first HEN-related paper by Ten Broeck (1994) and thermodynamic was the first systematic method, using the concept of pinch introduced during the 1970s to maximize energy recovery and complete methodology has been developed by Linnhoff and Tjoe (1985-1986), Linnhoff (1993). HEN synthesis techniques have evolved extremely by Grossmann and Kravanja (1995).

The process Integration is the heat recovery pinch, discovered independently by Hohmann (1971), Umeda et al. (1978-1979) and Linnhoff et al. (1978-1979). It was Linnhoff's group at UMIST in Manchester, however, that developed this concept into an industrial technology in the 80's. The first approaches treated the HEN synthesis problem without applying decomposition into sub-tasks. The limitations of optimization techniques were the bottleneck of the mathematical approaches at that time. As a result of the pinch concept, the single task approaches were shifted to procedures introducing techniques for decomposing the problem into three sub-tasks; minimum utility cost, minimum number of units and minimum investment cost network configurations. The main advantage of decomposing the HEN synthesis problem is that sub-problems can be treated in a much easier fashion than the original single-task problem. The sub-problems are the following

2.2.1 Minimum Utility Cost Target

Utility costs are usually the most significant variable operating cost. Utility operating costs include fuel, electricity, steam, cooling water, refrigeration, compressed air and inert gas. Energy management is an important element of controlling utility cost. A principle objective in the synthesis of HEN is the efficient utilization of energy. Thus, it desirable to compute the maximum energy recovery (MER) before synthesizing the HEN; that is to determine the minimum hot and cold utilities in the network, given the heating and cooling requirements for the most thermodynamically efficient network. Linnhoff and Turner (1981) provide the example to introduce this target step.

To determine the minimum utilities for heating and cooling, it is common to design two networks of heat exchangers, one on the hot side and one on the cold side of pinch. Two methods are presented for this purpose. The first, introduced by Linnhoff and Hindmarsh (1983), places emphasis on positioning the heat exchangers by working out from pinch. An extension of the utility targeting procedure in the pinch method for heat exchanger network synthesis is presented by Marcelo Castier (2007) for targeting the minimum utility. The HENs involving a retrofit is presented by Linnhoff and Vredeveld (1984) and developed in 1986. Pinch analysis retrofits a heat exchanger network for an industrial ethylbenzene plant integration which presented by Sung-Geun Yoon and co-workers (2007). The second is an algorithmic strategy that utilizes the mathematical modeling, which was introduced in Mixed Integer Linear Programming (MILP) for simultaneous structure and parameter optimization. This model is used for designing utility system (Papoulias and Grossmann, 1983). An Linear Programming (LP) transshipment model for minimum utilities problems and MILP transshipment model for the minimum number of units with possible stream splitting and mixing are developed.

2.2.2 Minimum Number of Units Target

The match combination can be determined with the minimum number of units and their load distribution for a fixed utility cost. The MILP transportation model of Cerda and Westerberg (1983) consider directly all the feasible links for heat exchange between each pair of hot and cold stream over their corresponding temperature intervals. At the same time, the MILP transshipment model of Papoulias and Grossmann (1983) are developed for minimum the number of units with possible stream splitting and mixing. Gundersen and Grossmann (1990) proposed a vertical transshipment model that will tend to favor the selection of matches that exhibit vertical heat transfer. A.R.Ciric and C.A.Floudas (1989) presented a the optimal redesign problem of existing heat exchanger networks by MILP in the first stage and Non-linear Programming (NLP) in the second stage to minimize the cost of purchasing new heat exchanger, the cost of addition area and the piping cost.

2.2.3 Minimum Investment Cost Network Configurations

It is based on the heat load and match information of previous targets. Using the superstructure-based formulation, developed by Floudas et al. (1986), the NLP problem is formulated and optimized for the minimum total cost of the network. The objective function in this model is the investment cost of the heat exchangers that are postulated in a superstructure.

However, limitation of decomposition-based methods is that costs due to energy, units and area cannot be optimized simultaneously, and as a result the trade-offs are not taken into account appropriately. Thus, simultaneous heat exchanger network synthesis methods are taken place. The simultaneous approaches purpose to find the optimal network with or without some decomposed problem. The simultaneous optimization generally results in MINLP formulations, which assumptions exist to simplify these complex models.

In 1986, Floudas and Grossmann introduced a multiperiod MILP model for the minimum utilities cost and minimum number of match of target problems, based on Papoulias and Grossmann's (1983) transshipment model. In this model the changes in the pinch point and utility required at each time period are taken into account. Extensions were presented first by Floudas and Grossmann (1987), and NLP formulation based on a superstructure presentation of possible network topologies to derive automatically network configurations that feature minimum investment cost, minimum number of units, and minimum utility cost for each time period.

Floudas and Ciric (1989) proposed a match-network hyperstructure model to simultaneously optimize all of the capital costs related to the heat exchanger network. This MINLP formulation is based on the combination of the transshipment model of Papoulias and Grossmann (1983) for match selection, and the minimum investment cost network configuration model of Floudas and Grossmann (1986) for determining the heat exchanger areas, temperatures and the flow rate in the network. The proposed simultaneous synthesis may still lead to suboptimal networks, since the value for HRAT must be specified before the design stage.

In 1990, Yee and Grossmann formulated another simultaneous synthesis where within each stage exchanges of heat can occur between each hot and

cold stream. This model can simultaneously target for area and energy cost while properly accounting for the differences in heat transfer coefficients between the streams. The match-network hyperstructure model was then further modified by Ciric and Floudas (1991) to treat HRAT as an explicit optimization variable. This MINLP formulation included any decomposition into design targets and simultaneously optimizes trade-offs between energy, units and area. Ciric and Floudas (1991) also demonstrated the benefit of a simultaneous approach versus sequential methods.

Ji and Bagajewicz (2001) performed the rigorous procedure for the design of conventional atmospheric crude fractionation units. Part I aims to find the best scheme of a multipurpose crude distillation unit which can process the various crude. Heat demand-supply diagrams are used as a guide for optimal scheme instead of grand composite curves. Thus, the total energy consumption from stream, heater and cooler is clearly shown and this leads the process to be easily optimal. In part II, 2001, Soto and Bagajewicz attempted to design a multipurpose heat exchanger network that can handle in variety of crude. In order to overcome the smaller gap between hot and cold composite curves, models that fixed the heat recovery by using the minimum heat recovery approximation temperature (HRAT) and the exchanger minimum approach temperature (EMAT) was performed. In 2003, Part III, Soto and Bagajewicz established a model to determine a heat exchanger network with only two branches above and below desalter. The total annualized costs, operating cost and depreciation of capital, of solution limited to one or two branches are compared with the results of four branches. In this part, the present model is based on a transshipment model and the vertical heat exchange constraints combined with HRAT/EMAT. In addition, investment cost is not directly controlled by this model, but further indirectly controlled by limiting of the minimum unit numbers. The smaller number of units leads to minimal capital cost and energy consumption simultaneously.

In 2001, Grossmann presents review of nonlinear mixed-integer and disjunctive programming techniques. To present a unified overview and derivation of mixed integer nonlinear programming (MILP) techniques as applied to nonlinear discrete optimization problems that are expressed in algebraic form. The solution of MINLP problems with convex functions is presented first, followed by brief discus-

sion on extensions for the no convex case. The solution of logic based representations, known as generalized disjunctive program, is also described, Theoretical properties are presented and numerical comparisons on a small process network problem.

In 2003, Balasubramanian and Grossmann introduce approximation to multistage stochastic optimization in multi period batch plant scheduling they consider the problem of scheduling under demand uncertainty multi product batch plant represented through the state task network. They present a multistage stochastic mixed integer linear programming (MILP) model and some decisions are take upon realization of the uncertainty. Computational results indicate that the proposed approximation strategy provides an expected profit within a few percent of the multistage stochastic MILP in a fraction of the computation time, and provides significant improvement in the expected profit over similar deterministic approaches.

In 2005, Grossmann and his teams present an algorithmic framework for convex mixed integer nonlinear programs. This paper is motivated by fact that mixed integer nonlinear programming is an important and difficult area for which there is a need for developing new methods and software for solving large-scale problems. This work represents the first step in an ongoing and ambitious project with in an open-source environment. Coin-Or is our chosen environment for the development of the optimization software. A class of hybrid algorithms, of which branch and bound and polyhedral outer approximation are the two extreme cases, this framework is reported, and a library of mixed integer nonlinear problems that exhibit convex continuous relaxations is made publicly available.

New rigorous one-step MILP formulation for heat exchanger network synthesis was developed by Barbaro and Bagajewicz (2005). This methodology does neither rely on traditional super targeting network design by the pinch technology, nor is a nonlinear model, but further use only one-step to optimize the solution. Cost-optimal networks, cost-effective solutions, can be obtained at once by using this model.

In 2006, Caballero and Grossmann introduce structural considerations and modeling in the synthesis of heat integrated-thermally coupled distillation sequences. Deals with the design of mixed thermally coupled-heat integrated distillation sequences, the approach considers from conventional columns to fully thermally

coupled systems. A discussion about superstructure generation and the convenience of using a representation based on separation tasks instead of equipment id presented as well as a set of logical rules in terms of Boolean variables which allow to systematically generating all the feasible structures. The model is base on the Fenske, Underwood Gilliland equations.

Thokozani Majozi and Anand Moodley (2007) purpose debottleneck the overall cooling water supply for the cooling water network. The presented a technique for contemporary targeting and design in cooling water systems. This technique is based on a superstructure from which a mathematical formulation is derived using system specific variables and parameters. The structural considerations of corresponding mathematical formulations consider in four operational cases. The first case is in a linear programming (LP) formulation, the second case yields a mixed integer linear programming (MILP) formulation whilst the other two cases yield mixed integer nonlinear programming (MINLP) formulations which cannot be exactly linearized.

2.3 Mathematical Programming Models

Mathematical programming is class of methods for solving constrained optimization problems. Both continuous and discrete (or binary) variables can be used in the corresponding mathematical programming models.

Generally, a mathematical programming model consists of an objective function and a set of equality constraints as well as inequality constraints. The problem can be expressed in a general form as

$$\begin{aligned} & \text{Min } f(x,y) \\ & \text{Subject to} \\ & \quad g(x,y) \leq 0 \\ & \quad h(x,y) = 0 \\ & \text{where} \\ & \quad x \in \mathbb{R}^n \\ & \quad y \in [0,1]^m \end{aligned}$$

It should be noticed that the variables x and y in general are vectors of variables, and that the constraints g and h similarly are vectors of functions. The objective function (f) is assumed to be a scalar.

Mathematical programming model consists of an objective function and a set of equality constraints as well as inequality constraints.

Classes of Mathematical Programming Models

The mathematical modeling of the systems leads to different types of formulations.

1. Linear Programming (LP)
2. Non-Linear Programming (NLP)
3. Mixed Integer Linear Programming(MILP)
4. Mixed Integer Non-Linear Programming(MINLP)

2.4 Model for Grassroots synthesis

A rigorous MILP formulation for grass-root design of heat exchanger networks is developed. The methodology does not rely on traditional super targeting followed by network design steps typical of the pinch design method, nor is a non-linear model based on superstructures. It considers splitting, non-isothermal mixing and it counts shells/unites. The model relies on transportation/transshipment concepts. The model has the following features:

- counts heat exchangers units and shells
- Approximates the area required for each exchanger unit or shell
- Controls the total number of units
- Implicitly determines flow rates in splits
- Handles non-isothermal mixing
- Identifies bypasses in split situations when convenient
- Controls the temperature approximation(HRAT/EMAT of ΔT min)when desired
- Can address block-design through the use of zones
- Allows multiple matches between two streams

2.5 Mathematical Model

2.5.1 Set Definitions

A set of several heat transfer zones is defined, namely $Z = \{z \mid z \text{ is a heat transfer zone}\}$

Use of zones can be used to separate the design in different sub-networks that are not interrelated, simplifying the network and the problem complexity. Next, the following sets are used to identify hot streams, cold streams, hot utilities and cold utilities.

$$H^z = \{i \mid i \text{ is a hot stream present in zone } z\}$$

$$C^z = \{j \mid j \text{ is a cold stream present in zone } z\}$$

$$HU^z = \{i \mid i \text{ is a heating utility present in zone } z\} \quad (HU^z \subset H^z)$$

$$CU^z = \{j \mid j \text{ is a heating utility present in zone } z\} \quad (CU^z \subset C^z)$$

Moreover, several temperature intervals are considered in each zone, in order to perform the heat balances and the area calculations. The different sets related to the temperature intervals are defined as

$$M^z = \{m \mid m \text{ is a temperature interval in zone } z\}$$

$$M_i^z = \{m \mid m \text{ is a temperature interval belonging to zone } z, \text{ in which hot stream } i \text{ is presented}\}$$

$$N_j^z = \{n \mid n \text{ is a temperature interval belonging to zone } z, \text{ in which cold stream } j \text{ is presented}\}$$

$$H_m^z = \{i \mid i \text{ is a hot stream present in temperature interval } m \text{ in zone } z\}$$

$$C_n^z = \{j \mid j \text{ is a cold stream present in temperature interval } n \text{ in zone } z\}$$

$$m_i^0 = \{m \mid m \text{ is the starting temperature interval for hot stream } i\}$$

$$n_j^0 = \{n \mid n \text{ is the starting temperature interval for cold stream } j\}$$

$$m_i^f = \{m \mid m \text{ is the final temperature interval for hot stream } i\}$$

$$n_i^f = \{n \mid n \text{ is the final temperature interval for cold stream } j\}$$

The MILP model uses the temperature intervals to perform energy balances and mass flow balances. Figure 2.2 depicts one hot and one cold stream spanning some temperature intervals and exchanging heat. At each temperature interval, the variables $\hat{q}_{ijm}^{z,H}$ account for the overall heat exchanged in interval m of hot stream i and all the intervals of cold stream j , in zone z . Familiar with $\hat{q}_{ijm}^{z,H}$, the variables $\hat{q}_{ijn}^{z,C}$ are used to compute the overall heat received by cold stream j at interval n from all intervals of hot stream i . The variables $q_{im,jn}^z$ are used to formulate the heat transportation from interval to interval between both streams.

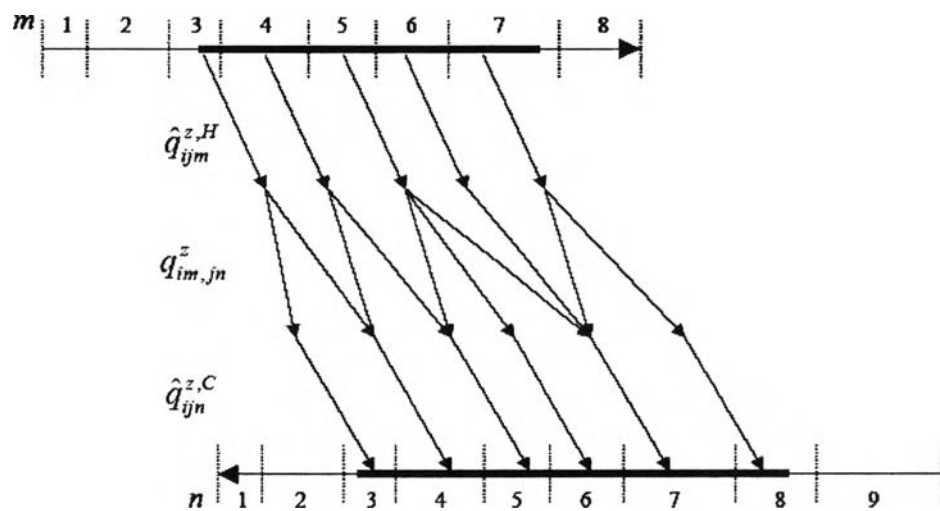

Figure 2.2 Basic scheme of the transportation/transshipment model. (Barbaro and Bagajewicz, 2005)

A number of sets are introduced to define all possible sources and destinations for heat transfer in this transportation scheme.

$$P = \{(i,j) \mid \text{heat exchange match between hot stream } i \text{ and cold stream } j \text{ is permitted}\}$$

$P_{im}^H = \{j \mid \text{heat transfer from hot stream } i \text{ at interval } m \text{ to cold stream } j \text{ is permitted}\}$

$P_{jm}^C = \{i \mid \text{heat transfer from hot stream } i \text{ to cold stream } j \text{ at interval } m \text{ is permitted}\}$

Set P defines as allowed matching between hot and cold streams. In order not to against the thermodynamically possible, permitted and forbidden heat exchange matches can be set up by the designer. Sets P_{im}^H and P_{jm}^C define as feasible heat transfer flows at each temperature interval.

Finally, the following sets allow the designer to manage additional features of the formulation.

$NI^H = \{i \mid \text{non-isothermal mixing is permitted for hot stream } i \}$

$NI^C = \{j \mid \text{non-isothermal mixing is permitted for cold stream } j \}$

$S^H = \{i \mid \text{splits are allowed for hot stream } i \}$

$S^C = \{j \mid \text{splits are allowed for cold stream } j \}$

$B = \{(i,j) \mid \text{more than one heat exchanger unit is permitted between hot stream } i \text{ and cold stream } j \}$

The sets NI^H and NI^C are used to specify whether non-isothermal mixing of stream splits is permitted, while sets S^H and S^C establish the possibility of stream splits. Finally, set B is used to allow more than one heat exchanger match between two streams, as shown in Figure 2.3 for match (i_l, j_l) . Thus, this model is able to distinguish situations where more than one heat exchanger unit is required to perform a heat exchange match.

Next, the different equations of the model for grass-root design of heat exchanger networks are introduced.

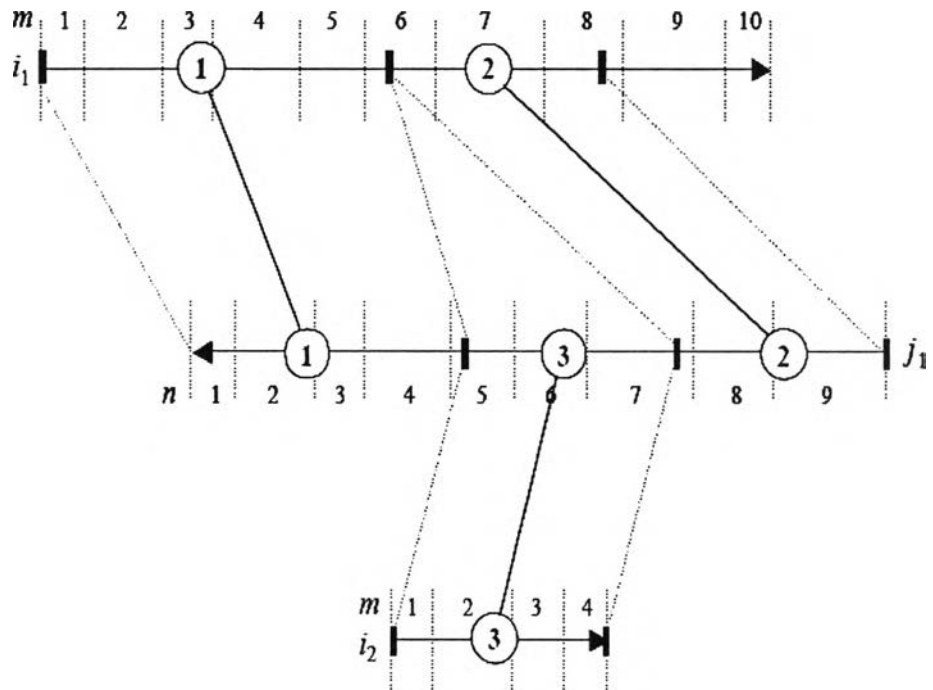

Figure 2.3 A case where more than one heat exchanger unit is required for a match (i,j) . (Barbaro and Bagajewicz, 2005)

2.5.2 Heat Balance Equations

The total heat available on each hot streams or the total heat demand of cold streams is equal to the heat transferred to the specific intervals. For heating and cooling utilities, these balances are described by the following equations.

Heat balance for heating utilities

$$F_i^H (T_m^u - T_m^L) = \sum_{\substack{n \in M^z \\ T_n^L < T_m^u}} \sum_{\substack{j \in C_n^z \\ j \in P_{jn}^H \\ i \in P_{jn}^C}} q_{im,jn}^z \quad z \in Z; m \in M^z; i \in H_m^z; i \in HU^z \quad (2.1)$$

Heat balance for cooling utilities

$$F_i^C (T_n^u - T_n^L) = \sum_{\substack{m \in M^z \\ T_n^L < T_m^u}} \sum_{\substack{i \in H_m^z \\ i \in P_{jn}^C \\ j \in P_{im}^H}} q_{im,jn}^z \quad z \in Z; n \in M^z; j \in C_n^z; j \in CU^z \quad (2.2)$$

The heat balances for process streams where only isothermal mixing of splits is considered are stated below.

Heat balance for hot process streams – $i \notin NI^H$

$$\Delta H_{im}^{z,H} = \sum_{\substack{n \in M^z \\ T_n^L < T_m^U}} \sum_{\substack{j \in C_n^z \\ j \in P_{jm}^H \\ i \in P_{jn}^H}} q_{im,jn}^z \quad z \in Z; m \in M^z; i \in H_m^z; i \notin HU^z; i \notin NI^H \quad (2.3)$$

Heat balance for cold process streams – $j \notin NI^C$

$$\Delta H_{jn}^{z,C} = \sum_{\substack{m \in M^z \\ T_n^L < T_m^U}} \sum_{\substack{i \in H_m^z \\ i \in P_{jn}^C \\ j \in P_{im}^H}} q_{im,jn}^z \quad z \in Z; n \in M^z; j \in C_n^z; j \notin CU^z; i \notin NI^C \quad (2.4)$$

The hot and cold cumulative heat transfer is defined in the next sets of equations. This cumulative transfer is introduced for presentation convenience because it is related to the equations that define the existence of heat exchangers in the different temperature intervals.

Cumulative heat transfer from hot stream i at interval m to cold stream j

$$\hat{q}_{ijm}^{z,H} = \sum_{\substack{n \in M^z; T_n^L < T_m^U \\ j \in C_n^z; i \in P_{jn}^C}} q_{im,jn}^z \quad z \in Z; m \in M^z; i \in H_m^z; j \in C^z; j \in P_{im}^H \quad (2.5)$$

Cumulative heat transfer to cold stream j at interval n from hot stream i

$$\hat{q}_{ijn}^{z,C} = \sum_{\substack{m \in M^z; T_n^L < T_m^U \\ i \in H_m^z; j \in P_{im}^H}} q_{im,jn}^z \quad z \in Z; n \in M^z; i \in H^z; j \in C_n^z; i \in P_{jn}^C \quad (2.6)$$

2.5.2.1 Heat Balance Equations for Streams Allowed to Have Non-Isothermal Split Mixing

A new variable (\bar{q}) is introduced to account for heat flows between intervals of the same stream that correspond to such mixing. Heat is artificially transferred from one interval to another within the same stream to account for non-isothermal mixing conditions. Figure 2.4 illustrates how this non-isothermal mixing of stream splits is taken into account.

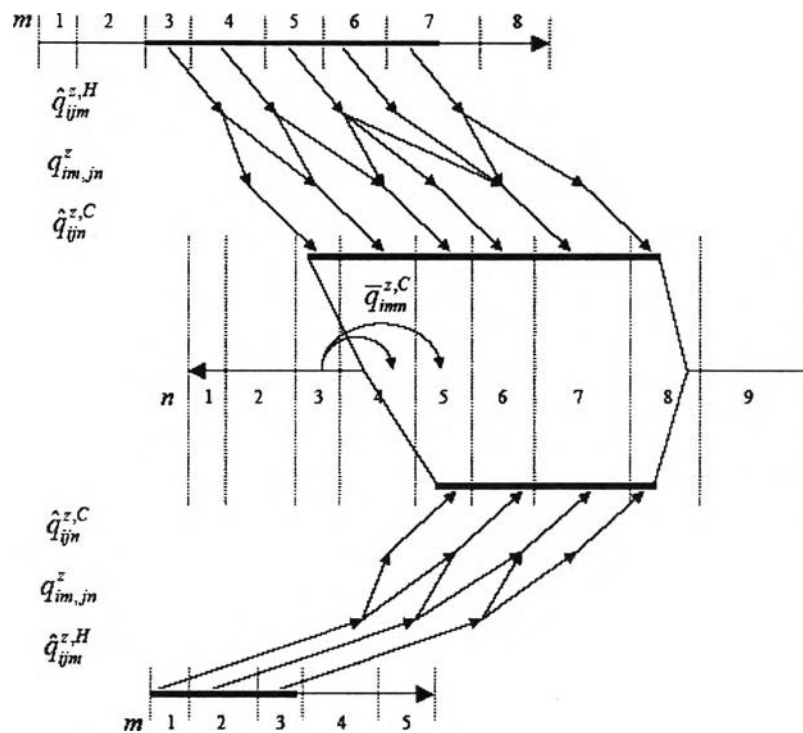

Figure 2.4 Non-isothermal split mixing. (Barbaro and Bagajewicz, 2005)

Following the Figure 2.4, cold stream j has been split to exchange heat between stream i_1 and i_2 and non-isothermal mixing between these splits is allowed. This figure shows the upper portion, the split in the cold stream spans temperature intervals 3 and 8, while the lower portion spans from interval 5 to interval 8. However, the whole stream spans from interval 4 to interval 8 after mixing and the non-split part spans the rest of the intervals. In order to complete the non-

isothermal mixing which allow one branch to reach a larger temperature as shown in the Figure 4, interval 3 get more heat than its demand ($\Delta H_{j3}^{z,C}$) and transfer this surplus heat to interval 4 and 5. Interval 4 and 5 receive less heat than their demand from the hot streams, with the difference being transferred from interval 3 by the heat \bar{q} . The heat balance equations for non-isothermal mixing of split are shown as

Heat balance for hot streams (non-isothermal mixing allowed)

$$\Delta H_{im}^{z,H} = \sum_{\substack{n \in M^z \\ T_n^L < T_m^U}} \sum_{\substack{j \in C_n^z \\ j \in P_{im}^H \\ i \in P_{jn}^C}} q_{im,jn}^z + \sum_{\substack{n \in M^z \\ n > m}} \sum_{i \in H_n^z} \bar{q}_{imn}^{z,H} - \sum_{\substack{n \in M^z \\ n < m}} \sum_{i \in H_n^z} \bar{q}_{imn}^{z,H} \quad z \in Z; m \in M^z; i \in H_m^z; i \notin HU^z; i \in NI^H \quad (2.7)$$

Heat balance for cold streams (non-isothermal mixing allowed)

$$\Delta H_{jn}^{z,C} = \sum_{\substack{m \in M^z \\ T_n^L < T_m^U}} \sum_{\substack{i \in H_m^z \\ i \in P_{jn}^C \\ j \in P_m^H}} q_{im,jn}^z + \sum_{\substack{m \in M^z \\ m < n}} \sum_{j \in C_m^z} \bar{q}_{jmn}^{z,C} - \sum_{\substack{m \in M^z \\ m > n}} \sum_{j \in C_m^z} \bar{q}_{jmn}^{z,C} \quad z \in Z; n \in M^z; j \in C_n^z; j \notin CU^z; j \in NI^C \quad (2.8)$$

In addition, the condition that heat cannot be transferred within a stream if there is no heat transfer with other stream need to be established in the model. Consequently, these equations force \bar{q} to be zero whenever there is no heat transferred with other streams.

Heat balance for hot streams – $i \in NI^H$

$$\sum_{\substack{n \in M^z \\ n < m}} \sum_{i \in H_n^z} \bar{q}_{imn}^{z,H} \leq \sum_{\substack{n \in M^z \\ T_n^L < T_m^U}} \sum_{\substack{j \in C_n^z; j \in P_{im}^H \\ i \in P_{jn}^C}} q_{im,jn}^z \quad z \in Z; m \in M^z; i \in H_m^z; i \notin HU^z; i \in NI^H \quad (2.9)$$

Heat balance for cold streams – $i \in NI^C$

$$\sum_{\substack{m \in M^z \\ m > n}} \sum_{j \in C_m^z} \bar{q}_{jmn}^{z,C} \leq \sum_{\substack{m \in M^z \\ T_n^L < T_m^U}} \sum_{\substack{i \in H_m^z; i \in P_{jn}^C \\ j \in P_m^H}} q_{im,jn}^z \quad z \in Z; n \in M^z; j \in C_n^z; j \notin CU^z; j \in NI^C \quad (2.10)$$

2.5.3 Heat Exchanger Definition and Count

The model is defined as a consecutive series of heat exchange shells between a hot and a cold stream. For each temperature interval, heat transfer is accounted using the cumulative heat (\hat{q}), while the existence of a heat exchanger for a given interval is defined by a new variable (Y), which determines whether heat exchange takes place or not at that interval. In addition, two new variables (K and \hat{K}), which are closely related to the Y variables, are introduced in order to indicate whether a heat exchanger begins or ends at a specific interval. The use of these new variables to count units has been previously proposed by Bagajewicz and Rodera (1998) and later used by Bagajewicz and Soto (2001, 2003) and Ji and Bagajewicz (2002).

Even placing the multiple shells, this seems to be as a single heat exchanger. Nevertheless, there are cases where non-consecutive series of shells could be allowed. For those cases, different heat exchangers have to be defined for each series. In order to consider the possibility of multiple heat exchangers between the same pair of streams, the additional equations are required.

For the case where only one exchanger is allowed per match between streams i and j , $(i,j) \notin B$, then binary variable $Y_{ijm}^{z,H}$, and two continuous variables $K_{ijm}^{z,H}$, $\hat{K}_{ijm}^{z,H}$ are used. The binary variable $Y_{ijm}^{z,H}$, indicates that there is a match between stream i at interval m receiving heat from some intervals of stream j . In turn, $K_{ijm}^{z,H}$ and $\hat{K}_{ijm}^{z,H}$ indicate the beginning and end of a string of intervals for which the binary variable is active. Conversely, when $(i,j) \in B$, $Y_{ijm}^{z,H}$ is declared as continuous and $K_{ijm}^{z,H}$, $\hat{K}_{ijm}^{z,H}$ are set up as binary. The Y variables are probably greater or equal than one if a heat exchanger exists for the correspondent streams and interval. However, all variables $Y_{ijm}^{z,H}$, $K_{ijm}^{z,H}$ and $\hat{K}_{ijm}^{z,H}$ are getting to be zero when no heat exchanger exists matching streams i and j .

The following group of constraints is used to determine the existence of a heat exchanger for a given pair of streams and temperature intervals. When only one heat exchanger is allowed per match, constraint (2.15)–(2.19) and (2.20)–(2.24)

are valid. The equation (2.25) applies further in cases where more than one exchanger is permitted. However, equations (2.15) and (2.20) only apply to the first and last interval of a hot stream, respectively, while the sets of equations (2.16)–(2.19) and (2.21)–(2.24) are used for all intervals.

Bounds on cumulative heat transfer for hot process streams

$$q_{ijm}^L Y_{ijm}^{z,H} \leq \hat{q}_{ijm}^{z,H} \leq \Delta H_{im}^{z,H} Y_{ijm}^{z,H} \quad z \in Z; m \in M^z; i \in H_m^z; i \notin HU^z; j \in C^z; j \in P_{im}^H \quad (2.11)$$

Bounds on cumulative heat transfer for cold process streams

$$q_{ijn}^L Y_{ijn}^{z,C} \leq \hat{q}_{ijn}^{z,C} \leq \Delta H_{jn}^{z,C} Y_{ijn}^{z,C} \quad z \in Z; n \in M^z; i \in H^z; j \in C_n^z; j \notin CU^z; i \in P_{jn}^C \quad (2.12)$$

Bounds on cumulative heat transfer for heating utilities

$$q_{ijm}^L Y_{ijm}^{z,H} \leq \hat{q}_{ijm}^{z,H} \leq F_i^U (T_m^U - T_m^L) \quad z \in Z; m \in M^z; i \in H_m^z; i \in HU^z; j \in C^z; j \in P_{im}^H \quad (2.13)$$

Bounds on cumulative heat transfer for cooling utilities

$$q_{ijn}^L Y_{ijn}^{z,C} \leq \hat{q}_{ijn}^{z,C} \leq F_j^U (T_n^U - T_n^L) \quad z \in Z; n \in M^z; i \in H^z; j \in C_n^z; j \in CU^z; i \in P_{jn}^C \quad (2.14)$$

Heat exchanger beginning for hot streams – $(i,j) \notin B$

$$K_{ijm}^{z,H} \geq Y_{ijm}^{z,H} \quad z \in Z; m \in M^z; m = m_i^0; i \in H^z; j \in C^z; j \in P_{im}^H; (i,j) \notin B \quad (2.15)$$

$$K_{ijm}^{z,H} \leq 2 - Y_{ijm}^{z,H} - Y_{ijm-1}^{z,H} \quad (2.16)$$

$$K_{ijm}^{z,H} \leq Y_{ijm}^{z,H} \quad z \in Z; m \in M^z; i \in H_m^z \cap H_{m-1}^z; j \in C^z; j \in P_{im}^H \cap P_{im-1}^H; (i,j) \notin B \quad (2.17)$$

$$K_{ijm}^{z,H} \geq Y_{ijm}^{z,H} - Y_{ijm-1}^{z,H} \quad (2.18)$$

$$K_{ijm}^{z,H} \geq 0 \quad (2.19)$$

Heat exchanger ending for hot streams – $(i,j) \notin B$

$$\hat{K}_{ijm}^{z,H} \geq Y_{ijm}^{z,H} \quad z \in Z; m \in M^z; m = m^j; i \in H^z; j \in C^z; j \in P_{im}^H; (i,j) \notin B \quad (2.20)$$

$$\hat{K}_{ijm}^{z,H} \leq 2 - Y_{ijm}^{z,H} - Y_{ijm+1}^{z,H} \quad (2.21)$$

$$\hat{K}_{ijm}^{z,H} \leq Y_{ijm}^{z,H} \quad \left. \begin{array}{l} (2.21) \\ (2.22) \\ (2.23) \\ (2.24) \end{array} \right\} z \in Z; m \in M^z; i \in H_m^z \cap H_{m+1}^z; j \in C^z; j \in P_{im}^H \cap P_{im+1}^H; (i,j) \notin B \quad (2.22)$$

$$\hat{K}_{ijm}^{z,H} \geq Y_{ijm}^{z,H} - Y_{ijm+1}^{z,H} \quad (2.23)$$

$$\hat{K}_{ijm}^{z,H} \geq 0 \quad (2.24)$$

Heat exchanger existence on hot streams - $(i,j) \in B$

$$Y_{ijm}^{z,H} = \sum_{\substack{l \in M_l^z \\ l \leq m \\ j \in P_{il}^H}} K_{ijl}^{z,H} - \sum_{\substack{l \in M_l^z \\ l \leq m-1 \\ j \in P_{il}^H}} \hat{K}_{ijl}^{z,H} \quad z \in Z; m \in M^z; i \in H_m^z; j \in C^z; j \in P_{im}^H; (i,j) \in B \quad (2.25)$$

The example shown in Figure 2.5 for a match $(i,j) \notin B$, only one heat exchanger is allowed, will explain how the previous sets of constraints work. The hot side of heat exchanger spans from interval 3 to 8 of stream i , heat transferred to cold stream j is not shown. Since, only one heat exchanger is permitted for this match, variables $Y_{ijm}^{z,H}$ are defined as binary while $K_{ijm}^{z,H}$ and $\hat{K}_{ijm}^{z,H}$ are continuous. The values for all variables are given in Table 2.1. These numbers correspond to the set of constraints in (2.15)-(2.19) and (2.20)-(2.24).

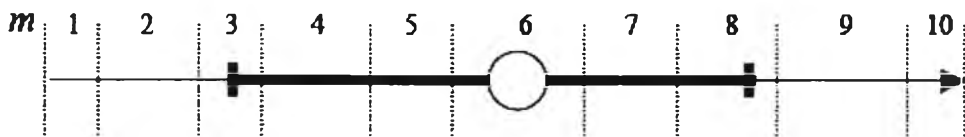

Figure 2.5 Heat exchanger definition when $(i,j) \notin B$. (Barbaro and Bagajewicz, 2005)

Table 2.1 Values of $Y_{ijm}^{z,H}$, $K_{ijm}^{z,H}$ and $\hat{K}_{ijm}^{z,H}$ variables when $(i,j) \notin B$. (Barbaro and Bagajewicz, 2005)

m	$Y_{ijm}^{z,H}$	$K_{ijm}^{z,H}$	$\hat{K}_{ijm}^{z,H}$
1	0	0	0
2	0	0	0
3	1	1	0
4	1	0	0
5	1	0	0
6	1	0	0
7	1	0	0
8	1	0	1
9	0	0	0
10	0	0	0

Following Figure 2.5, whenever $Y_{ijm}^{z,H} = 0$ then it follows that $K_{ijm}^{z,H} = 0$ and $\hat{K}_{ijm}^{z,H} = 0$, explain in constraint (2.17) and (2.22). At any interval where $Y_{ijm-1}^{z,H} = 1$, constraint (2.18) becomes trivial and thus $K_{ijm}^{z,H}$ is getting to be zero because when $Y_{ijm}^{z,H} = 1$, constraint (2.16) gives $K_{ijm}^{z,H}$ to zero.

The possibility of allowing two heat exchangers between the same pair of streams is considered. In Figure 2.6, there are two heat exchangers between the shown hot stream and a certain cold stream, $(i,j) \in B$. Both exchangers are placed in series for the hot stream without any other unit in between. Then, the constraint (2.25) is used for defining heat exchangers existence. Additionally, variables $K_{ijm}^{z,H}$ and $\hat{K}_{ijm}^{z,H}$ are declared as binary while $Y_{ijm}^{z,H}$ are stated as continuous which the values of these variables are shown in Table 2.2.

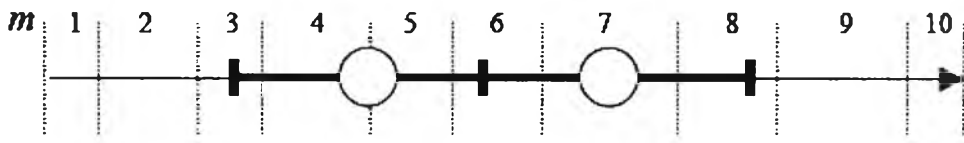

Figure 2.6 Heat exchanger definition when $(i,j) \in B$. (Barbaro and Bagajewicz, 2005)

Table 2.2 Values of $Y_{ijm}^{z,H}$, $K_{ijm}^{z,H}$ and $\hat{K}_{ijm}^{z,H}$ variables when $(i,j) \in B$. (Barbaro and Bagajewicz, 2005)

m	$Y_{ijm}^{z,H}$	$K_{ijm}^{z,H}$	$\hat{K}_{ijm}^{z,H}$
1	0	0	0
2	0	0	0
3	1	1	0
4	1	0	0
5	1	0	0
6	2	1	1
7	1	0	0
8	1	0	1
9	0	0	0
10	0	0	0

Whenever a heat exchanger begins or ends, the binary variables $K_{ijm}^{z,H}$ and $\hat{K}_{ijm}^{z,H}$ are set to one. Then constraint (2.25) leads the values of $Y_{ijm}^{z,H}$ equal to one for all intervals m between the beginning and end of a heat exchanger. Note that, when a heat exchanger between the same pair of stream ends and another one begins in the same interval (interval 6 for this example) then $Y_{ijm}^{z,H}$ is equal to two. Since $Y_{ijm}^{z,H} = 2$ is not feasible if the Y are declared as binary variables and constraints (2.15) and (2.16) are used, this is why a different set of equations and variable declarations is required when $(i,j) \in B$, at a cost of increasing the number of binary variables.

A similar set of equations is used to define the location of a heat exchanger for cold streams. These expressions are presented next without further explanation.

Heat exchanger beginning for cold streams - $(i,j) \notin B$

$$K_{ijn}^{z,C} \geq Y_{ijn}^{z,C} \quad z \in Z; n \in M^z; n = n_j^0; i \in H^z; j \in C_n^z; i \in P_{jn}^C; (i,j) \notin B \quad (2.26)$$

$$K_{ijn}^{z,C} \leq 2 - Y_{ijn}^{z,C} - Y_{ijn-1}^{z,C} \quad (2.27)$$

$$K_{ijn}^{z,C} \leq Y_{ijn}^{z,C} \quad z \in Z; n \in M^z; i \in H^z; j \in C_n^z \cap C_{n-1}^z; i \in P_{jn}^C \cap P_{jn-1}^C; (i,j) \notin B \quad (2.28)$$

$$K_{ijn}^{z,C} \geq Y_{ijn}^{z,C} - Y_{ijn-1}^{z,C} \quad (2.29)$$

$$K_{ijn}^{z,C} \geq 0 \quad (2.30)$$

Heat exchanger ending for cold streams - $(i,j) \notin B$

$$\hat{K}_{ijn}^{z,C} \geq Y_{ijn}^{z,C} \quad z \in Z; n \in M^z; n = n_j^0; i \in H^z; j \in C_n^z; i \in P_{jn}^C; (i,j) \notin B \quad (2.31)$$

$$\hat{K}_{ijn}^{z,C} \leq 2 - Y_{ijn}^{z,C} - Y_{ijn-1}^{z,C} \quad (2.32)$$

$$\hat{K}_{ijn}^{z,C} \leq Y_{ijn}^{z,C} \quad z \in Z; n \in M^z; i \in H^z; j \in C_n^z \cap C_{n-1}^z; i \in P_{jn}^C \cap P_{jn-1}^C; (i,j) \notin B \quad (2.33)$$

$$\hat{K}_{ijn}^{z,C} \geq Y_{ijn}^{z,C} - Y_{ijn-1}^{z,C} \quad (2.34)$$

$$\hat{K}_{ijn}^{z,C} \geq 0 \quad (2.35)$$

Heat exchanger existence on cold streams - $(i,j) \in B$

$$Y_{ijn}^{z,C} = \sum_{\substack{l \in N_j^z \\ l \leq n \\ i \in P_{jl}^C}} K_{ijl}^{z,C} - \sum_{\substack{l \in N_j^z \\ l \leq n-1 \\ i \in P_{jl}^C}} \hat{K}_{ijl}^{z,C} \quad z \in Z; n \in M^z; i \in H^z; j \in C_n^z; i \in P_{jn}^C; (i,j) \in B \quad (2.36)$$

Lastly, by counting the number of beginnings or endings of heat exchanger, the number of heat exchanger units between a given pair of streams, E_{ij}^z , can be figured out. The beginnings number is calculated by equation (2.37) to (2.38) and equation (2.39) to (2.40) is used to generate the endings number.

Number of heat exchangers between hot stream i and cold stream $j - (i,j) \notin B$

$$E_{ij}^z = \sum_{m \in M_i^z; j \in P_m^H} K_{ijm}^{z,H} \quad (2.37)$$

$$E_{ij}^z = \sum_{n \in N_j^z; i \in P_n^C} K_{ijn}^{z,C} \quad z \in Z; i \in H^z; j \in C^z; (i,j) \in P \quad (2.38)$$

$$E_{ij}^z = \sum_{m \in M_i^z; j \in P_m^H} \hat{K}_{ijm}^{z,H} \quad (2.39)$$

$$E_{ij}^z = \sum_{n \in N_j^z; i \in P_n^C} \hat{K}_{ijn}^{z,C} \quad (2.40)$$

$$E_{ij}^z \leq 1 \quad z \in Z; i \in H^z; j \in C^z; (i,j) \in P; (i,j) \notin B \quad (2.41)$$

$$E_{ij}^z \leq E_{ij}^{z,\max} \quad z \in Z; i \in H^z; j \in C^z; (i,j) \in P; (i,j) \in B \quad (2.42)$$

For the last equation, (2.42), the number of shell, U_{ij}^z , need to be greater or equal to the number of heat exchanger units, E_{ij}^z . Because a single heat exchanger does not mean only one shell, the shell number should be needed to satisfy the required area for each match.

However, each shell number will be counted as a separate heat exchanger whenever the condition of more than one exchanger is presented. The constraints for this situation are shown below.

Number of heat exchangers between hot stream i and cold stream $j - (i,j) \in B$

$$U_{ij}^z = \sum_{m \in M_i^z; j \in P_m^H} K_{ijm}^{z,H} \quad (2.43)$$

$$U_{ij}^z = \sum_{m \in M_i^z; j \in P_m^H} \hat{K}_{ijm}^{z,H} \quad (2.44)$$

$$U_{ij}^z = \sum_{n \in N_j^z; i \in P_n^C} K_{ijn}^{z,C} \quad (2.45)$$

$$U_{ij}^z = \sum_{n \in N_j^z; i \in P_n^C} \hat{K}_{ijn}^{z,C} \quad (2.46)$$

2.5.4 Heat Transfer Consistency

To explain the heat load of each exchanger unit for multiple heat exchange, heat transfer consistency constraints are necessary to be addressed. When heat exchanges from hot stream to cold stream with two exchangers exist in series, for example in Figure 2.7, the cumulative heat of hot stream in interval 6, $\hat{q}_{ij6}^{z,H}$ is transfer to the cold stream in interval 5 and the heat left of hot stream, $\tilde{q}_{ij6}^{z,H}$, is sent into interval 8 of cold stream. The amount of heat that is transferred to the next heat exchanger in series, $\tilde{q}_{ijm}^{z,H}$, is used to calculate the heat load and area calculations in each heat exchanger. Table 2.3 expressed the values of the variables involved in heat load calculation which are the heat exchanger existence, beginning and ending of each heat exchanger unit and the value of \tilde{q} . Another variable need to initiate is called $X_{im,jn}^z$ which used to find out the ending interval for each heat exchanger connected in sequence for match (i,j) . So, the value of $X_{im,jn}^z$ will be zero whenever m and n are cold-end intervals and be higher than zero in all other situations.

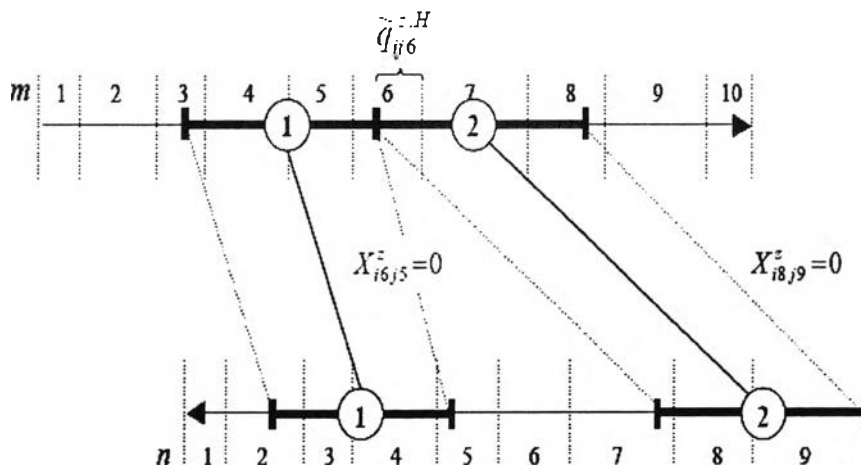

Figure 2.7 Heat transfer consistency example when $(i,j) \in B$. (Barbaro and Bagajewicz, 2005)

Table 2.3 Values of variables $K_{ijm}^{z,H}$, $\hat{K}_{ijm}^{z,H}$, $Y_{ijm}^{z,H}$ and $\tilde{q}_{ijm}^{z,H}$ when $(i,j) \in B$. (Barbaro and Bagajewicz, 2005)

$$\begin{aligned} \text{Load} &= \hat{q}_{ij3}^{z,H} + \hat{q}_{ij4}^{z,H} + \hat{q}_{ij5}^{z,H} + \hat{q}_{ij6}^{z,H} - \tilde{q}_{ij6}^{z,H} \\ \text{Unit 1} &= \hat{q}_{ij2}^{z,C} + \hat{q}_{ij3}^{z,C} + \hat{q}_{ij4}^{z,C} + \hat{q}_{ij5}^{z,C} \end{aligned}$$

$$\begin{aligned} \text{Load} &= \hat{q}_{ij3}^{z,H} + \hat{q}_{ij4}^{z,H} + \hat{q}_{ij5}^{z,H} + \hat{q}_{ij6}^{z,H} + \hat{q}_{ij7}^{z,H} + \hat{q}_{ij8}^{z,H} \\ \text{Units 1+2} &= \hat{q}_{ij2}^{z,C} + \hat{q}_{ij3}^{z,C} + \hat{q}_{ij4}^{z,C} + \hat{q}_{ij5}^{z,C} + \hat{q}_{ij7}^{z,C} + \hat{q}_{ij8}^{z,C} + \hat{q}_{ij9}^{z,C} \end{aligned}$$

M	Y_m	K_m	\hat{K}_m	\tilde{q}_m
1	0	0	0	0
2	0	0	0	0
3	1	1	0	0
4	1	0	0	0
5	1	0	0	0
6	2	1	1	≥ 0
7	1	0	0	0
8	1	0	1	0
9	0	0	0	0
10	0	0	0	0

n	Y_n	K_n	\hat{K}_n	\tilde{q}_n
1	0	0	0	0
2	1	1	0	0
3	1	0	0	0
4	1	0	0	0
5	1	0	1	0
6	0	0	0	0
7	1	1	0	0
8	1	0	0	0
9	1	0	1	0

The heat transfer consistency constraints for multiple heat exchangers are expressed here. Heat transfer consistency for multiple heat exchangers between the same pair of streams.

$$\sum_{\substack{l \in M_i^z \\ l \leq m}} \hat{q}_{ijl}^{z,H} - \tilde{q}_{ijm}^{z,H} \leq \sum_{\substack{l \in N_j^z \\ l \leq n}} \hat{q}_{ijl}^{z,C} - \tilde{q}_{ijm}^{z,C} + 4X_{im,jn}^z \text{Max} \left\{ \sum_{\substack{l \in M_i^z \\ l \leq m \\ j \in P_{il}^H}} \Delta H_{il}^{z,H}; \sum_{\substack{l \in M_j^z \\ l \leq n \\ i \in P_{jl}^C}} \Delta H_{jl}^{z,C} \right\} \quad (2.47)$$

$$\sum_{\substack{l \in M_i^z \\ l \leq m}} \hat{q}_{ijl}^{z,H} - \tilde{q}_{ijm}^{z,H} \geq \sum_{\substack{l \in N_j^z \\ l \leq n}} \hat{q}_{ijl}^{z,C} - \tilde{q}_{ijm}^{z,C} - 4X_{im,jn}^z \text{Max} \left\{ \sum_{\substack{l \in M_i^z \\ l \leq m \\ j \in P_{il}^H}} \Delta H_{il}^{z,H}; \sum_{\substack{l \in M_j^z \\ l \leq n \\ i \in P_{jl}^C}} \Delta H_{jl}^{z,C} \right\} \quad (2.48)$$

$$X_{im,jn}^z = 2 - \hat{K}_{ijm}^{z,H} - \hat{K}_{ijn}^{z,C} + \frac{1}{4} \sum_{\substack{l \in N_j^z \\ l \leq n}} \hat{K}_{ijl}^{z,C} - \frac{1}{4} \sum_{\substack{l \in M_i^z \\ l \leq m}} \hat{K}_{ijl}^{z,H} \quad (2.49)$$

$$\sum_{\substack{l \in M_i^z \\ l \leq m \\ j \in P_{il}^H}} \hat{K}_{ijl}^{z,H} - \sum_{\substack{l \in N_j^z \\ l \leq n \\ i \in P_{jl}^C}} \hat{K}_{ijl}^{z,C} \geq 0 \quad (2.50)$$

$z \in Z; m, n \in M^z; T_n^L < T_m^U; T_n^L \geq T_m^L$
 $(i,j) \in B; i \in H_m^z; j \in C_n^z; i \in P_{jn}^C; j \in P_{im}^H$

$$\left. \begin{array}{l} \sum_{\substack{l \in M_i^z \\ l \leq m \\ j \in P_{ij}^H}} (K_{ijl}^{z,H} - \hat{K}_{ijl}^{z,H}) \leq 1 \end{array} \right\} \quad z \in Z; m \in M^z; (ij) \in B; i \in H_m^z; j \in P_{im}^H \quad (2.51)$$

$$\left. \begin{array}{l} \sum_{\substack{l \in N_j^z \\ l \leq n \\ i \in P_{jl}^C}} (K_{ijl}^{z,C} - \hat{K}_{ijl}^{z,C}) \leq 1 \end{array} \right\} \quad (2.52)$$

$$\left. \begin{array}{l} \tilde{q}_{ijm}^{z,H} \leq \hat{q}_{ijm}^{z,H} \end{array} \right\} \quad z \in Z; m \in M^z; (ij) \in B; i \in H_m^z; j \in P_{im}^H \quad (2.53)$$

$$\left. \begin{array}{l} \tilde{q}_{ijm}^{z,H} \leq K_{ijm}^{z,H} \Delta H_{im}^{z,H} \end{array} \right\} \quad z \in Z; m \in M^z; (ij) \in B; i \in H_m^z; j \in P_{im}^H \quad (2.54)$$

$$\left. \begin{array}{l} \tilde{q}_{ijm}^{z,H} \leq \hat{K}_{ijm}^{z,H} \Delta H_{im}^{z,H} \end{array} \right\} \quad (2.55)$$

$$\left. \begin{array}{l} \tilde{q}_{ijm}^{z,H} \geq 0 \end{array} \right\} \quad (2.56)$$

$$\left. \begin{array}{l} \tilde{q}_{ijn}^{z,C} \leq \hat{q}_{ijn}^{z,C} \end{array} \right\} \quad z \in Z; n \in M^z; (ij) \in B; j \in C_n^z; i \in P_{jn}^C \quad (2.57)$$

$$\left. \begin{array}{l} \tilde{q}_{ijn}^{z,C} \leq K_{ijn}^{z,C} \Delta H_{in}^{z,C} \end{array} \right\} \quad z \in Z; n \in M^z; (ij) \in B; j \in C_n^z; i \in P_{jn}^C \quad (2.58)$$

$$\left. \begin{array}{l} \tilde{q}_{ijn}^{z,C} \leq \hat{K}_{ijn}^{z,C} \Delta H_{in}^{z,C} \end{array} \right\} \quad (2.59)$$

$$\left. \begin{array}{l} \tilde{q}_{ijn}^{z,C} \geq 0 \end{array} \right\} \quad (2.60)$$

Main constraints for the heat transfer consistency are the equation (2.47) to (2.49). All these constraints show that whatever calculated from hot or cold stream, the heat load of heat exchanger also be the same. In addition, in case where there is the cold-end interval, $X_{im,jn}^z = 0$, the equation (2.47) and (2.48) become an equality as

$$\sum_{\substack{l \in M_i^z \\ l \leq m}} \hat{q}_{ijl}^{z,H} - \tilde{q}_{ijn}^{z,H} = \sum_{\substack{l \in N_j^z \\ l \leq n}} \hat{q}_{ijl}^{z,C} - \tilde{q}_{ijm}^{z,C}$$

For example in Figure 2.7, at interval 6 of hot stream and interval 5 for cold stream, the constraint (2.47) and (2.48) will be summary to

$$\hat{q}_{ij3}^{z,H} + \hat{q}_{ij4}^{z,H} + \hat{q}_{ij5}^{z,H} + \hat{q}_{ij6}^{z,H} - \tilde{q}_{ij6}^{z,H} = \hat{q}_{ij2}^{z,C} + \hat{q}_{ij3}^{z,C} + \hat{q}_{ij4}^{z,C} + \hat{q}_{ij5}^{z,C} - \tilde{q}_{ij5}^{z,C}$$

And the heat exchanger does not start at interval 5 of cold stream, so the value of $\tilde{q}_{ij5}^{z,C}$ is zero. This lead the equation become

$$\hat{q}_{ij3}^{z,H} + \hat{q}_{ij4}^{z,H} + \hat{q}_{ij5}^{z,H} + \hat{q}_{ij6}^{z,H} - \tilde{q}_{ij6}^{z,H} = \hat{q}_{ij2}^{z,C} + \hat{q}_{ij3}^{z,C} + \hat{q}_{ij4}^{z,C} + \hat{q}_{ij5}^{z,C}$$

The next constraint, (2.50), is produced to make sure that there is feasible temperature difference between hot and cold stream at the cold-end that is the hot stream temperature is forced to be higher than the cold stream temperature at the cold-end of the heat exchanger. Figure 2.7 will show clearer in description. Following constraints, (2.51) and (2.52), are used to describe that a new exchanger can only start, in the same interval with the first one sequentially, when the previous exchanger has ended. Last sets of constraint, (2.53) to (2.60), are used to specify the value of variable \tilde{q} . This variable is created to be zero for all intervals except the connection interval between two exchangers which continuous constructed in series, first heat exchanger ends and the second exchanger starts in the same interval.

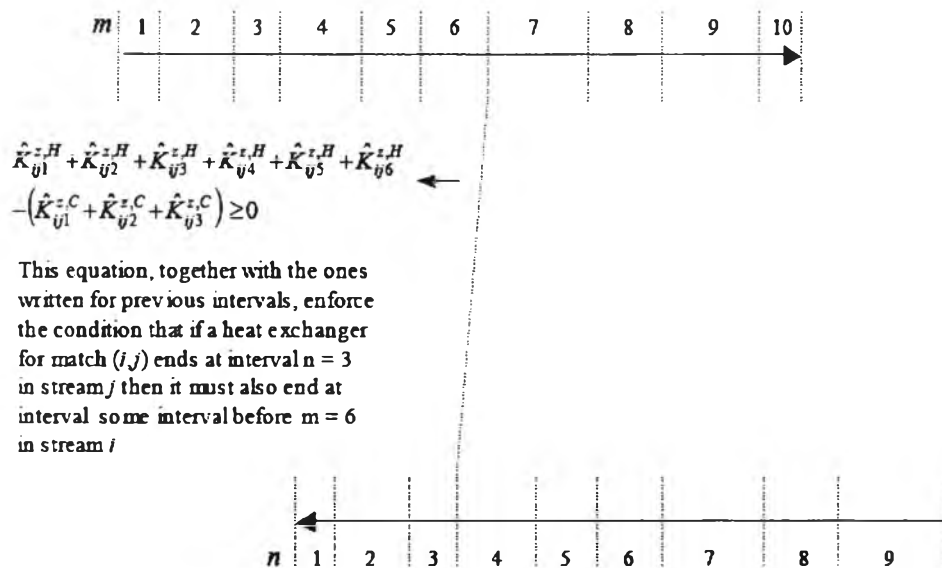

Figure 2.8 Integer cut for heat exchanger end when $(i,j) \in B$. (Barbaro and Bagajewicz, 2005)

2.5.5 Flow Rate Consistency within Heat Exchangers

The assumption that constant flow rate passed through heat exchanger is applied to the MILP model. The next equation group expresses the consistency of flow rate within a heat exchanger. In Figure 2.8 depicts an example of heat exchanger which exchange heat during the interval 3 to interval 8 of hot stream i with the cold stream j . Next, new word need to be introduced, they are called “extreme intervals” which are the intervals 3 and 8 for this example while “exchanger-internal intervals” are referred to the retired intervals which are the interval 4 to 7.

Let explain more details for this example where allow only one exchanger for match, $(i,j) \in B$. For the exchanger-internal intervals, interval 4 to 7, the flow rate can be consistently established as the ratio of the cumulative heat transfer, the heat capacity and the interval temperature difference. In contrast, this equation can not be used for the extreme intervals because the real temperature difference between upper and lower bound of interval are not the same as normal range, it is smaller. Consequently, flow rate for the interval 3 and 8 can be solved by the inequality constraints as mention in Figure 2.9.

$$\frac{\hat{q}_{ijm}^{z,H}}{Cp_{im}(T_m^U - T_m^L)} \geq \frac{\hat{q}_{ijm-1}^{z,H}}{Cp_{im-1}(T_{m-1}^U - T_{m-1}^L)} \quad \frac{\hat{q}_{ijm}^{z,H}}{Cp_{im}(T_m^U - T_m^L)} \leq \frac{\hat{q}_{ijm-1}^{z,H}}{Cp_{im-1}(T_{m-1}^U - T_{m-1}^L)}$$

Heat exchanger spanning

$$\frac{\hat{q}_{ijm}^{z,H}}{Cp_{im}(T_m^U - T_m^L)} = \frac{\hat{q}_{ijm-1}^{z,H}}{Cp_{im-1}(T_{m-1}^U - T_{m-1}^L)}$$

Figure 2.9 Flow rate consistency equations. (Barbaro and Bagajewicz, 2005)

The equations used for classify which interval is exchanger-internals or extreme intervals are introduced couple with the variable α . Actually, it is defined as continuous but the following constraints enforce it to be one when the interval is exchanger-internal and zero for all others.

Definition of exchanger-internal intervals for hot streams

$$\alpha_{ijm}^{z,H} \leq 1 - K_{ijm}^{z,H} - K_{ijm-1}^{z,H} \quad (2.61)$$

$$\alpha_{ijm}^{z,H} \leq 1 - \hat{K}_{ijm}^{z,H} - \hat{K}_{ijm-1}^{z,H} \quad (2.62)$$

$$\alpha_{ijm}^{z,H} \geq Y_{ijm}^{z,H} - K_{ijm}^{z,H} - K_{ijm-1}^{z,H} - \hat{K}_{ijm}^{z,H} - \hat{K}_{ijm-1}^{z,H} \quad (2.63)$$

$$\alpha_{ijm}^{z,H} \geq 0 \quad (2.64)$$

At exchanger-internal interval, there is no exchanger begins or ends, so $K_{ijm}^{z,H}$, $K_{ijm-1}^{z,H}$, $\hat{K}_{ijm}^{z,H}$, $\hat{K}_{ijm-1}^{z,H}$ are all zero and $Y_{ijm}^{z,H} = 1$. The constraint (2.63) gives the value of $\alpha_{ijm}^{z,H}$ to be one. On the other hand, for the extreme intervals, at least one of $K_{ijm}^{z,H}$, $K_{ijm-1}^{z,H}$, $\hat{K}_{ijm}^{z,H}$, $\hat{K}_{ijm-1}^{z,H}$ will be equal to one or $Y_{ijm}^{z,H} = 0$. So, $\alpha_{ijm}^{z,H}$ will become to zero.

However, there is another condition, which effect to these constraint equations. When splitting stream flow rate is allowed, the flow rate consistency equation will be

Flow rate consistency for hot streams in exchanger-internal intervals - $i \in S^H$, $(i,j) \notin B$

$$\frac{\hat{q}_{ijm}^{z,H}}{Cp_{im}(T_m^U - T_m^L)} \leq \frac{\hat{q}_{ijm-1}^{z,H}}{Cp_{im-1}(T_{m-1}^U - T_{m-1}^L)} + (1 - \alpha_{ijm}^{z,H}) \cdot F_i \quad (2.65)$$

$$\frac{\hat{q}_{ijm}^{z,H}}{Cp_{im}(T_m^U - T_m^L)} \geq \frac{\hat{q}_{ijm-1}^{z,H}}{Cp_{im-1}(T_{m-1}^U - T_{m-1}^L)} - (1 - \alpha_{ijm}^{z,H}) \cdot F_i \quad (2.66)$$

Flow rate consistency for hot streams in extreme intervals - $i \in S^H$, $(i,j) \notin B$

$$\frac{\hat{q}_{ijm}^{z,H}}{Cp_{im}(T_m^U - T_m^L)} \geq \frac{\hat{q}_{ijm-1}^{z,H}}{Cp_{im-1}(T_{m-1}^U - T_{m-1}^L)} - (1 + \hat{K}_{ijm-1}^{z,H} + \hat{K}_{ijm}^{z,H} - K_{ijm-1}^{z,H}) \cdot F_i \quad (2.67)$$

$$\frac{\hat{q}_{ijm}^{z,H}}{Cp_{im}(T_m^U - T_m^L)} \leq \frac{\hat{q}_{ijm-1}^{z,H}}{Cp_{im-1}(T_{m-1}^U - T_{m-1}^L)} + (1 + K_{ijm-1}^{z,H} + K_{ijm}^{z,H} - \hat{K}_{ijm}^{z,H}) \cdot F_i \quad (2.68)$$

For the exchanger-internal interval, $\alpha=1$, that is the last term in the right hand side of both constraints, (2.65) and (2.66), are canceled out and the constraints perform as equality. In contrast, constraint (2.67) and (2.68) are defined for the extreme intervals. Constraint (2.67) is referred to the beginning of heat exchanger and the end of exchanger is expressed in constraint (2.68). Consider (2.67), at the end of exchanger, the last term in the right hand side is deleted. The last term in (2.68) can also be erased whenever there is a starting of exchanger.

However, the effect of stream splitting also needs to be concerned. The possibility of appearing two different heat exchangers in the same interval is used to construct the constraints for stream splitting.

Flow rate consistency for hot streams in extreme intervals - $i \in S^H$, $(i,j) \in B$

$$\frac{\hat{q}_{ijm}^{z,H}}{Cp_{im}(T_m^U - T_m^L)} \geq \frac{\hat{q}_{ijm-1}^{z,H}}{Cp_{im-1}(T_{m-1}^U - T_{m-1}^L)} - (1 + \hat{K}_{ijm-1}^{z,H} + \hat{K}_{ijm}^{z,H} - K_{ijm-1}^{z,H}) \cdot F_i \quad (2.69)$$

$$\frac{\hat{q}_{ijm}^{z,H}}{Cp_{im}(T_m^U - T_m^L)} \geq \frac{\tilde{q}_{ijm-1}^{z,H}}{Cp_{im-1}(T_{m-1}^U - T_{m-1}^L)} - (2 + \hat{K}_{ijm}^{z,H} - K_{ijm-1}^{z,H} - Y_{ijm-1}^{z,H}) \cdot F_i \quad (2.70)$$

$$\frac{\hat{q}_{ijm}^{z,H} - \tilde{q}_{ijm}^{z,H}}{Cp_{im}(T_m^U - T_m^L)} \leq \frac{\hat{q}_{ijm-1}^{z,H}}{Cp_{im-1}(T_{m-1}^U - T_{m-1}^L)} + (2 + K_{ijm-1}^{z,H} - \hat{K}_{ijm}^{z,H} - Y_{ijm}^{z,H}) \cdot F_i \quad (2.71)$$

When a heat exchanger starts at interval $m-1$, the constraint (2.69) is applied while the constraint (2.70) is used to identify when another heat exchanger between the same pair of hot and cold stream that ends at the interval $m-1$. Constraint (2.71) expresses at the end of a heat exchanger which the possibility of having two heat exchangers that start at the same interval is concerned. All constraints, (2.67) to (2.71), can be simplified for the case that stream split is not allowed because the flow rate for exchanger-internal intervals is equal to the actual flow rate.

Flow rate consistency for hot streams - $i \notin S^H$

$$\hat{q}_{ijm}^{z,H} \geq (Y_{ijm-1}^{z,H} + Y_{ijm}^{z,H} - Y_{ijm+1}^{z,H} - 2) \cdot \Delta H_{im}^{z,H} \quad z \in Z; m \in M^z; i \in H_{m-1}^z \cap H_m^z \cap H_{m+1}^z; i \notin S^H \quad (2.72)$$

$(i,j) \notin B; j \in C^z; j \in P_{im-1}^H \cap P_{im}^H \cap P_{im+1}^H$

$$\left. \begin{aligned} \hat{q}_{ijm}^{z,H} &\geq (Y_{ijm}^{z,H} - K_{ijm}^{z,H} - \hat{K}_{ijm}^{z,H}) \cdot \Delta H_{im}^{z,H} \\ \hat{q}_{ijm}^{z,H} &\geq (Y_{ijm}^{z,H} + K_{ijm}^{z,H} + \hat{K}_{ijm}^{z,H} - 2) \cdot \Delta H_{im}^{z,H} \end{aligned} \right\} \begin{aligned} z \in Z; m \in M^z; i \in H_{m-1}^z \cap H_m^z \cap H_{m+1}^z; i \notin S^H \\ j \in C^z; j \in P_{im-1}^H \cap P_{im}^H \cap P_{im+1}^H \end{aligned} \quad (2.73)$$

$$\left. \begin{aligned} \hat{q}_{ijm}^{z,H} &\geq (Y_{ijm}^{z,H} - K_{ijm}^{z,H} - \hat{K}_{ijm}^{z,H}) \cdot \Delta H_{im}^{z,H} \\ \hat{q}_{ijm}^{z,H} &\geq (Y_{ijm}^{z,H} + K_{ijm}^{z,H} + \hat{K}_{ijm}^{z,H} - 2) \cdot \Delta H_{im}^{z,H} \end{aligned} \right\} \quad (2.74)$$

In case that only one exchanger is permitted, expressed in constraint (2.72), the heat flow is equivalent to the amount of enthalpy change for any internal interval. However, for the multiple exchangers, the variables Y are probably higher than one. Therefore, two following constraint, (2.73) and (2.74), are set to satisfy the concept of equivalent between heat flow and enthalpy change.

Consequently, flow rate consistency constraints for cold streams are shown below.

Definition of exchanger-internal intervals for cold streams $j \in S^C$

$$\alpha_{ijn}^{z,C} \leq 1 - K_{ijn}^{z,C} - K_{ijn-1}^{z,C} \quad (2.75)$$

$$\alpha_{ijn}^{z,C} \leq 1 - \hat{K}_{ijn}^{z,C} - \hat{K}_{ijn-1}^{z,C} \quad (2.76)$$

$$\alpha_{ijn}^{z,C} \geq Y_{ijn}^{z,C} - K_{ijn}^{z,C} - K_{ijn-1}^{z,C} - \hat{K}_{ijn}^{z,C} - \hat{K}_{ijn-1}^{z,C} \quad (2.77)$$

$$\alpha_{ijn}^{z,C} \geq 0 \quad (2.78)$$

Flow rate consistency for cold streams in exchanger-internal intervals- $j \in S^C, (i,j) \notin B$

$$\left. \frac{\hat{q}_{ijn}^{z,C}}{Cp_{jn}(T_n^U - T_n^L)} \leq \frac{\hat{q}_{ijn-1}^{z,C}}{Cp_{jn-1}(T_{n-1}^U - T_{n-1}^L)} + (1 - \alpha_{ijn}^{z,C}) \cdot F_j \right\} \begin{aligned} z \in Z; n \in M^z; j \in S^C \\ j \in C_n^z \cap C_{n-1}^z; i \in H^z; i \in P_{jn}^C \cap P_{jn-1}^C \end{aligned} \quad (2.79)$$

$$\left. \frac{\hat{q}_{ijn}^{z,C}}{Cp_{jn}(T_n^U - T_n^L)} \geq \frac{\hat{q}_{ijn-1}^{z,C}}{Cp_{jn-1}(T_{n-1}^U - T_{n-1}^L)} - (1 - \alpha_{ijn}^{z,C}) \cdot F_j \right\} \quad (2.80)$$

Flow rate consistency for cold streams in extreme intervals- $j \in S^C, (i,j) \notin B$

$$\left. \frac{\hat{q}_{ijn}^{z,C}}{Cp_{jn}(T_n^U - T_n^L)} \geq \frac{\hat{q}_{ijn-1}^{z,C}}{Cp_{jn}(T_n^U - T_n^L)} - (1 + \hat{K}_{ijn-1}^{z,C} + \hat{K}_{ijn}^{z,C} - K_{ijn-1}^{z,C}) \cdot F_i \right\} \quad (2.81)$$

$$\left. \frac{\hat{q}_{ijn}^{z,C}}{Cp_{jn}(T_n^U - T_n^L)} \leq \frac{\hat{q}_{ijn-1}^{z,C}}{Cp_{in-1}(T_{n-1}^U - T_{n-1}^L)} + (1 + K_{ijn-1}^{z,C} + K_{ijn}^{z,C} - \hat{K}_{ijn}^{z,C}) \cdot F_i \right\} \begin{aligned} z \in Z; n \in M^z; (i,j) \notin B \\ j \in S^C; j \in C_n^z \cap C_{n-1}^z \\ i \in H^z; i \in P_{jn}^C \cap P_{jn-1}^C \end{aligned} \quad (2.82)$$

Flow rate consistency for cold streams in extreme intervals - $j \in S^C, (i, j) \in B$

$$\frac{\hat{q}_{ijn}^{z,C}}{Cp_{jn}(T_n^U - T_n^L)} \geq \frac{\hat{q}_{ijn-1}^{z,C}}{Cp_{j,n-1}(T_{n-1}^U - T_{n-1}^L)} - \left(1 + \hat{K}_{ijn-1}^{z,C} + \hat{K}_{ijn}^{z,C} - K_{ijn-1}^{z,C}\right) \cdot F_j \quad (2.83)$$

$$\frac{\hat{q}_{ijn}^{z,C}}{Cp_{jn}(T_n^U - T_n^L)} \geq \frac{\tilde{q}_{ijn-1}^{z,C}}{Cp_{j,n-1}(T_{n-1}^U - T_{n-1}^L)} - \left(2 + \hat{K}_{ijn-1}^{z,C} - K_{ijn-1}^{z,C} - Y_{ijn-1}^{z,C}\right) \cdot F_j \quad (2.84)$$

$$\frac{\hat{q}_{ijn}^{z,C} - \tilde{q}_{ijn}^{z,C}}{Cp_{jn}(T_n^U - T_n^L)} \leq \frac{\hat{q}_{ijn-1}^{z,C}}{Cp_{j,n-1}(T_{n-1}^U - T_{n-1}^L)} + \left(2 + K_{ijn-1}^{z,C} - \hat{K}_{ijn}^{z,C} - Y_{ijn}^{z,C}\right) \cdot F_j \quad (2.85)$$

Flow rate consistency for cold streams - $j \notin S^C$

$$\hat{q}_{ijn}^{z,C} \geq \left(Y_{ijn-1}^{z,C} - Y_{ijn}^{z,C} - Y_{ijn+1}^{z,C} - 2\right) \cdot \Delta H_{jn}^{z,C} \quad \left. \begin{array}{l} z \in Z; n \in M^z; j \in C_{n-1}^z \cap C_n^z \cap C_{n+1}^z; i \notin S^C \\ (i, j) \notin B; i \in H^z; i \in P_{j,n-1}^C \cap P_{jn}^C \cap P_{j,n+1}^C \end{array} \right\} \quad (2.86)$$

$$\hat{q}_{ijn}^{z,C} \geq \left(Y_{ijn}^{z,C} - K_{ijn}^{z,C} - \hat{K}_{ijn}^{z,C}\right) \cdot \Delta H_{jn}^{z,C} \quad \left. \begin{array}{l} z \in Z; n \in M^z; j \in C_{n-1}^z \cap C_n^z \cap C_{n+1}^z; i \notin S^C \\ (i, j) \in B; i \in H^z; i \in P_{j,n-1}^C \cap P_{jn}^C \cap P_{j,n+1}^C \end{array} \right\} \quad (2.87)$$

$$\hat{q}_{ijn}^{z,C} \geq \left(Y_{ijn-1}^{z,C} + K_{ijn}^{z,C} + \hat{K}_{ijn+1}^{z,C} - 2\right) \cdot \Delta H_{jn}^{z,C} \quad (2.88)$$

2.5.6 Temperature Difference Enforcing

This part is necessary to generate in order to assure the heat transfer feasible. Firstly, Figure 2.10, constraint (2.89) and (2.90) introduce the temperature difference of extreme interval for the condition that there are no splits allowed. Additionally, constraint (2.91) to (2.96) further explain in case where stream splits are allowed.

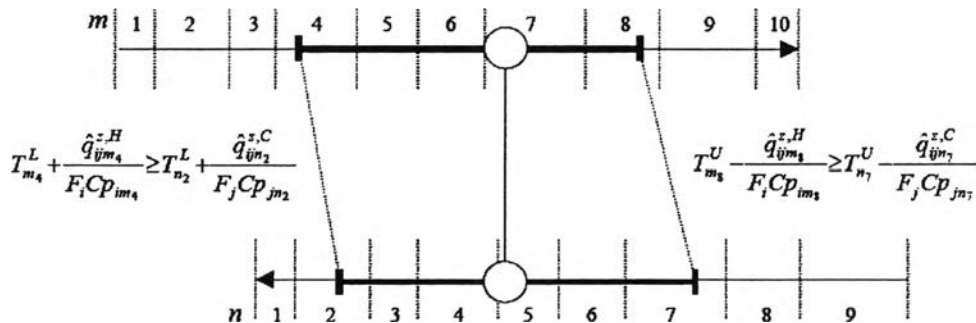

Figure 2.10 Temperature difference assurances when splits are not allowed. (Barbaro and Bagajewicz, 2005)

Temperature feasibility constraints - $i \notin S^H, j \in S^C$

$$T_m^L + \frac{\hat{q}_{ijm}^{z,H}}{F_i C p_{im}} \geq T_n^L + \frac{\hat{q}_{ijn}^{z,C}}{F_j C p_{jn}} - (2 - K_{ijm}^{z,H} - K_{ijn}^{z,C}) \cdot T_n^U \quad \left. \begin{array}{l} z \in Z; m, n \in M^z; T_n^L \leq T_m^U; T_n^U \geq T_m^L \\ i \in H_m^z; j \in C_n^z; i \notin S^H; j \in S^C; i \in P_{jn}^C; j \in P_{im}^H \end{array} \right\} \quad (2.89)$$

$$T_m^U - \frac{\hat{q}_{ijm}^{z,H}}{F_i C p_{im}} \geq T_n^U - \frac{\hat{q}_{ijn}^{z,C}}{F_j C p_{jn}} - (2 - \hat{K}_{ijm}^{z,H} - \hat{K}_{ijn}^{z,C}) \cdot T_n^U \quad (2.90)$$

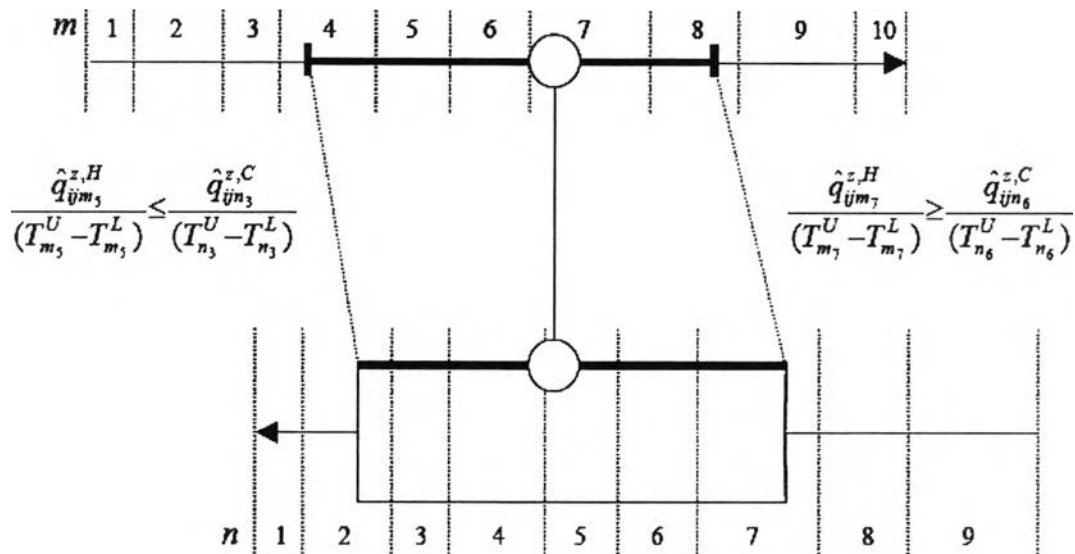

Figure 2.11 Temperature difference assurance when splits are allowed. (Barbaro and Bagajewicz, 2005)

Temperature feasibility constraints - $i \in S^H, j \in S^C, (i, j) \notin B$

$$\hat{K}_{ijn}^{z,C} \leq 2 - K_{ijm}^{z,H} - K_{ijn}^{z,C} \quad (2.91)$$

$$\frac{\hat{q}_{ijn}^{z,C}}{T_m^U - T_n^L} \leq \frac{\hat{q}_{ijm+1}^{z,C}}{T_{n+1}^U - T_{n+1}^L} \frac{C p_{jn}}{C p_{jn+1}} + (2 - K_{ijm}^{z,H} - K_{ijn}^{z,C}) \cdot \frac{\Delta H_{jn}^{z,C}}{T_m^U - T_n^L} \quad \left. \begin{array}{l} z \in Z; m, n \in M^z; i \in S^H \\ j \in S^C; T_n^L < T_m^U; T_n^U > T_m^L \end{array} \right\} \quad (2.92)$$

$$\frac{\hat{q}_{ijm}^{z,H}}{\text{Min}\{T_m^U, T_n^L\} - T_m^L} \geq \frac{\hat{q}_{ijm+1}^{z,H}}{T_{m+1}^U - T_{m+1}^L} \frac{C p_{im}}{C p_{im+1}} - (2 - K_{ijm}^{z,H} - K_{ijn}^{z,C}) \frac{\Delta H_{im+1}^{z,H}}{T_{m+1}^U - T_{m+1}^L} \quad \left. \begin{array}{l} i \in H_m^z \cap H_{m+1}^z; j \in C_n^z \cap C_{n+1}^z; \\ i \in P_{jn}^C \cap P_{jn+1}^C; j \in P_{im}^H \cap P_{im+1}^H \end{array} \right\} \quad (2.93)$$

$$K_{ijm}^{z,H} \leq 2 - \hat{K}_{ijm}^{z,H} - \hat{K}_{ijn}^{z,C} \quad (2.94)$$

$$\frac{\hat{q}_{ijm}^{z,H}}{T_m^U - T_n^L} \leq \frac{\hat{q}_{ijm-1}^{z,H}}{T_{m-1}^U - T_{m-1}^L} \frac{Cp_{im}}{Cp_{im-1}} + \left(2 - \hat{K}_{ijm}^{z,H} - \hat{K}_{ijn}^{z,C}\right) \frac{\Delta H_{im}^{z,H}}{T_m^U - T_n^L} \quad (2.95)$$

$$\frac{\hat{q}_{ijn}^{z,C}}{T_n^U - \text{Max}\{T_m^L, T_n^L\}} \geq \frac{\hat{q}_{ijn-1}^{z,C}}{T_{n-1}^U - T_{n-1}^L} \frac{Cp_{jn}}{Cp_{jn-1}} + \left(2 - \hat{K}_{ijm}^{z,H} - \hat{K}_{ijn}^{z,C}\right) \frac{\Delta H_{jn-1}^{z,C}}{T_{n-1}^U - T_{n-1}^L} \quad (2.96)$$

$$\left. \begin{array}{l} z \in Z; m, n \in M^z; i \in S^H \\ j \in S^C; T_n^L < T_m^U; T_n^U > T_m^L \\ i \in H_m^z \cap H_{m+1}^z; j \in C_n^z \cap C_{n+1}^z; \\ i \in P_{jn}^C \cap P_{jn+1}^C; j \in P_{im}^H \cap P_{im+1}^H \end{array} \right\}$$

All these next constraints are performed only for overlapping pairs of intervals where $T_n^L < T_m^U$ and $T_n^U > T_m^L$ which m and n are the overlapping intervals of hot and cold stream at the hot end of heat exchanger. Constraint (2.91) is generated to guarantee that the cold end of the cold stream of heat exchanger will not be located at the same interval with the hot end. Feasible heat transfer forces the constraint (2.92) in valid. That is the hot end temperature for the cold stream is less than the hot stream. Moreover, constraint (2.93) stated that the hot end temperature of the hot stream equal to $\text{Min}\{T_m^U; T_n^U\}$ as illustrated in Figure 2.11. Finally, the constraints for the case of multiple heat exchangers are presented next.

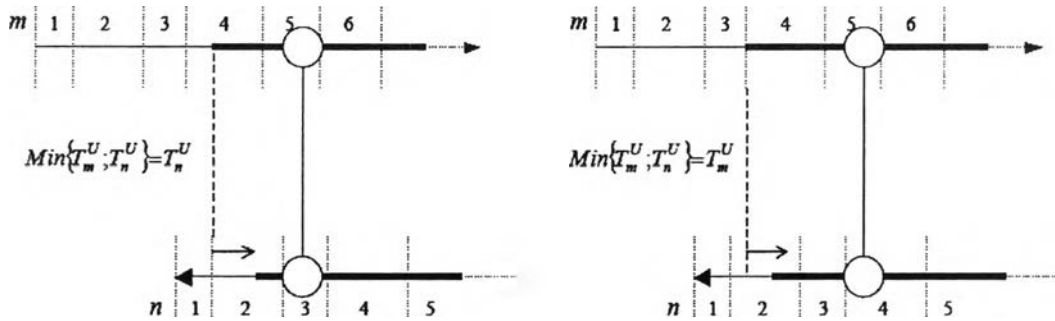

Figure 2.12 Temperature difference assurance at the hot end of an exchanger -

$i \in S^H, j \in S^C, (i, j) \notin B$. (Barbaro and Bagajewicz, 2005)

Temperature feasibility constraints $i \in S^H, j \in S^C, (i, j) \in B$

$$\left. \begin{aligned} \hat{K}_{ijn}^{z,C} &\leq 1 + Y_{ijn}^{z,C} - K_{ijm}^{z,H} - K_{ijn}^{z,C} \\ \frac{\hat{q}_{ijn}^{z,C}}{T_m^U - T_n^L} &\leq \frac{\hat{q}_{ijm+1}^{z,C}}{T_{n+1}^U - T_{n+1}^L} \frac{Cp_{jn}}{Cp_{jn+1}} + (1 + Y_{ijn}^{z,C} - K_{ijm}^{z,H} - K_{ijn}^{z,C}) \cdot \frac{\Delta H_{jn}^{z,C}}{T_m^U - T_n^L} \\ \frac{\hat{q}_{ijn}^{z,C}}{T_m^U - T_n^L} &\leq \frac{\hat{q}_{ijm+1}^{z,C}}{T_{n+1}^U - T_{n+1}^L} \frac{Cp_{jn}}{Cp_{jn+1}} + (2 - K_{ijm}^{z,H} - K_{ijn}^{z,C}) \cdot \frac{\Delta H_{jn}^{z,C}}{T_m^U - T_n^L} \end{aligned} \right\} \begin{array}{l} z \in Z; m, n \in M^I; i \in S^H; \\ j \in S^C; T_n^L < T_m^U; T_n^U > T_m^L \\ i \in H_m^I \cap H_{m+1}^I; j \in C_n^I \cap C_{n+1}^I \\ i \in P_m^C \cap P_{m+1}^C; j \in P_m^H \cap P_{m+1}^H \end{array} \quad (2.97)$$

$$\left. \begin{aligned} \frac{\hat{q}_{ijn}^{z,C}}{T_m^U - T_n^L} &\leq \frac{\hat{q}_{ijm+1}^{z,C}}{T_{n+1}^U - T_{n+1}^L} \frac{Cp_{jn}}{Cp_{jn+1}} + (1 + Y_{ijn}^{z,C} - K_{ijm}^{z,H} - K_{ijn}^{z,C}) \cdot \frac{\Delta H_{jn}^{z,C}}{T_m^U - T_n^L} \end{aligned} \right\} \begin{array}{l} z \in Z; m, n \in M^I; i \in S^H; \\ j \in S^C; T_n^L < T_m^U; T_n^U > T_m^L \\ i \in H_m^I \cap H_{m+1}^I; j \in C_n^I \cap C_{n+1}^I \\ i \in P_m^C \cap P_{m+1}^C; j \in P_m^H \cap P_{m+1}^H \end{array} \quad (2.98)$$

$$\left. \begin{aligned} \frac{\hat{q}_{ijn}^{z,C}}{T_m^U - T_n^L} &\leq \frac{\hat{q}_{ijm+1}^{z,C}}{T_{n+1}^U - T_{n+1}^L} \frac{Cp_{jn}}{Cp_{jn+1}} + (2 - K_{ijm}^{z,H} - K_{ijn}^{z,C}) \cdot \frac{\Delta H_{jn}^{z,C}}{T_m^U - T_n^L} \end{aligned} \right\} \begin{array}{l} z \in Z; m, n \in M^I; i \in S^H; \\ j \in S^C; T_n^L < T_m^U; T_n^U > T_m^L \\ i \in H_m^I \cap H_{m+1}^I; j \in C_n^I \cap C_{n+1}^I \\ i \in P_m^C \cap P_{m+1}^C; j \in P_m^H \cap P_{m+1}^H \end{array} \quad (2.99)$$

$$\frac{\hat{q}_{ijm}^{z,H}}{\text{Min}\{T_m^U; T_n^U\} - T_m^L} \geq \frac{\hat{q}_{ijm+1}^{z,H}}{T_{m+1}^U - T_{m+1}^L} \frac{Cp_{im}}{Cp_{im+1}} - (2 - K_{ijm}^{z,H} - K_{ijn}^{z,C}) \cdot \frac{\Delta H_{im+1}^{z,H}}{T_{m+1}^U - T_{m+1}^L} \quad (2.100)$$

$$\left. \begin{aligned} K_{ijm}^{z,H} &\leq 1 + Y_{ijm}^{z,H} - \hat{K}_{ijm}^{z,H} - \hat{K}_{ijn}^{z,C} \end{aligned} \right\} \quad (2.101)$$

$$\left. \begin{aligned} \frac{\hat{q}_{ijm}^{z,H} - \tilde{q}_{ijm}^{z,H}}{T_m^U - T_n^L} &\leq \frac{\hat{q}_{ijm-1}^{z,H}}{T_{m-1}^U - T_{m-1}^L} \frac{Cp_{im}}{Cp_{im-1}} + (2 - \hat{K}_{ijm}^{z,H} - \hat{K}_{ijn}^{z,C}) \cdot \frac{\Delta H_{im}^{z,H}}{T_m^U - T_n^L} \end{aligned} \right\} \begin{array}{l} z \in Z; m, n \in M^I; i \in S^H; \\ j \in S^C; T_n^L < T_m^U; T_n^U > T_m^L \\ i \in H_m^I \cap H_{m-1}^I; j \in C_n^I \cap C_{n-1}^I \\ i \in P_m^C \cap P_{m-1}^C; j \in P_m^H \cap P_{m-1}^H \end{array} \quad (2.102)$$

$$\left. \begin{aligned} \frac{\hat{q}_{ijm}^{z,H} - \tilde{q}_{ijm}^{z,H}}{T_n^U - \text{Max}\{T_m^L; T_n^L\}} &\leq \frac{\hat{q}_{ijm-1}^{z,H}}{T_{n-1}^U - T_{n-1}^L} \frac{Cp_{jn}}{Cp_{jn-1}} - (2 - \hat{K}_{ijm}^{z,H} - \hat{K}_{ijn}^{z,C}) \cdot \frac{\Delta H_{jn-1}^{z,H}}{T_{n-1}^U - T_{n-1}^L} \end{aligned} \right\} \begin{array}{l} z \in Z; m, n \in M^I; i \in S^H; \\ j \in S^C; T_n^L < T_m^U; T_n^U > T_m^L \\ i \in H_m^I \cap H_{m-1}^I; j \in C_n^I \cap C_{n-1}^I \\ i \in P_m^C \cap P_{m-1}^C; j \in P_m^H \cap P_{m-1}^H \end{array} \quad (2.103)$$

2.5.7 Heat Exchanger Area Calculation

The area of heat exchanger can be determined by considering the heat transfer of any stream match.

Heat transfer area for one heat exchanger is permitted

$$A_{ij}^z = \sum_{m \in M_i^I} \sum_{\substack{n \in N_j^I: T_n^L < T_m^U \\ j \in P_m^H; i \in P_m^C}} \left[\frac{q_{im,jn}^z (h_{im} + h_{jn})}{\Delta T_{mn}^{ML} h_{im} h_{jn}} \right] \quad z \in Z; i \in H^I; j \in C^I; (i, j) \in P \quad (2.104)$$

For multiple heat exchangers between streams i and j are allowed, each exchanger area can be formulated by this following constraints.

Heat transfer area for multiple heat exchangers

$$\hat{A}_{ij}^{z,k} \leq \sum_{\substack{l \in M_i^z; n \in N_j^z \\ l < m; T_i^L < T_m^U \\ j \in P_{im}^H \\ i \in P_{jn}^C}} \left[\frac{(q_{il,jn}^z - \tilde{q}_{il,jn}^z) \cdot (h_{il} + h_{jn})}{\Delta T_{ln}^{ML} \cdot h_{il} \cdot h_{jn}} \right] - \sum_{h=1}^{k-1} A_{ij}^{z,h} + A_{ij,max}^z (2 - \hat{K}_{ijm}^{z,H} - G_{ijm}^{z,k}) \quad (2.105)$$

$$\hat{A}_{ij}^{z,k} \geq \sum_{\substack{l \in M_i^z; n \in N_j^z \\ l < m; T_i^L < T_m^U \\ j \in P_{im}^H \\ i \in P_{jn}^C}} \left[\frac{(q_{il,jn}^z - \tilde{q}_{il,jn}^z) \cdot (h_{il} + h_{jn})}{\Delta T_{ln}^{ML} \cdot h_{il} \cdot h_{jn}} \right] - \sum_{h=1}^{k-1} A_{ij}^{z,h} - A_{ij,max}^z (2 - \hat{K}_{ijm}^{z,H} - G_{ijm}^{z,k}) \quad (2.106)$$

$$\hat{A}_{ij}^{z,k} \geq A_{ij}^z - \sum_{h=1}^{k-1} \hat{A}_{ij}^{z,h} \quad \left. \begin{array}{l} z \in Z; m \in M^z \\ i \in H_m^z; j \in C^z \\ j \in P_{im}^H; (i,j) \in B \\ k = 1, \dots, k_{max} - 1 \end{array} \right\} \quad (2.107)$$

$$\sum_{h=1}^{k_{max}} h \cdot G_{ijm}^{z,h} = \sum_{\substack{l \in M_i^z; l \leq m \\ j \in P_{im}^H}} K_{ijl}^{z,H} + 1 - Y_{ijm}^{z,H} \quad (2.108)$$

$$\sum_{\substack{n \in N_j^z; T_n^L < T_m^U \\ j \in P_{im}^H; i \in P_{jn}^C}} \tilde{q}_{im,jn}^z = \tilde{q}_{ijm}^{z,H} \quad (2.109)$$

$$\tilde{q}_{im,jn}^z \leq q_{im,jn}^z \quad (2.110)$$

The maximum number of heat exchangers allowed per match, k_{max} , is required for area calculation. The heat exchanger area of the k -th heat exchanger is calculated by subtracting the area of the former exchangers, $k-1$, from the total accumulated area until the end of the k -th exchanger. The binary variables $\hat{X}_{ijm}^{z,h}$ are used to specify which exchanger is present at a certain temperature interval. Obviously, all constraints (2.105) to (2.110) are constructed for hot stream intervals only because hot and cold stream intervals can generate the same heat exchanger area.

2.5.8 Number of Shells

The variable U_{ij}^z is used to define as the number of shells.

Maximum Shell Area

$$A_{ij}^z \leq A_{ij,max}^z U_{ij}^z \quad z \in Z; i \in H^z; j \in C^z; (i,j) \in P; (i,j) \notin B \quad (2.111)$$

$$\hat{A}_{ij}^{z,k} \leq A_{ij,max}^z \hat{U}_{ij}^{z,k} \quad z \in Z; i \in H^z; j \in C^z; (i,j) \in P; (i,j) \in B \quad (2.112)$$

2.5.9 Objective Function

The objective function of the MILP model is to minimize the annualized total cost, this is composed of the operating and capital cost. The simply assumption of linear relation is used to approximate the total cost. The equation applied to calculate the objective value is indicated below. The first term represents the cost of hot utility, the second referred to cooling utility cost, followed by the fixed cost for heat exchanger and end up with the area cost.

$$\begin{aligned}
 \text{Min Cost} = & \sum_z \sum_{i \in \text{HU}^z} \sum_{\substack{j \in \text{C}^z \\ (i,j) \in \text{P}}} c_i^H F_i^H \Delta T_i + \sum_z \sum_{\substack{j \in \text{CU}^z \\ (i,j) \in \text{P}}} \sum_{i \in \text{H}^z} c_j^C F_j^C \Delta T_j + \left[\sum_z \sum_{i \in \text{H}^z} \sum_{\substack{j \in \text{C}^z \\ (i,j) \in \text{P}}} (c_{ij}^F U_{ij}^z + c_{ij}^A A_{ij}^z) \right]_{(i,j) \in \text{B}} \\
 & + \left[\sum_k \left[\sum_z \sum_{i \in \text{H}^z} \sum_{\substack{j \in \text{C}^z \\ (i,j) \in \text{P}}} (c_{ij}^F \hat{U}_{ij}^{z,k} + c_{ij}^A \hat{A}_{ij}^{z,k}) \right] \right]_{(i,j) \in \text{B}}
 \end{aligned} \quad (2.113)$$