



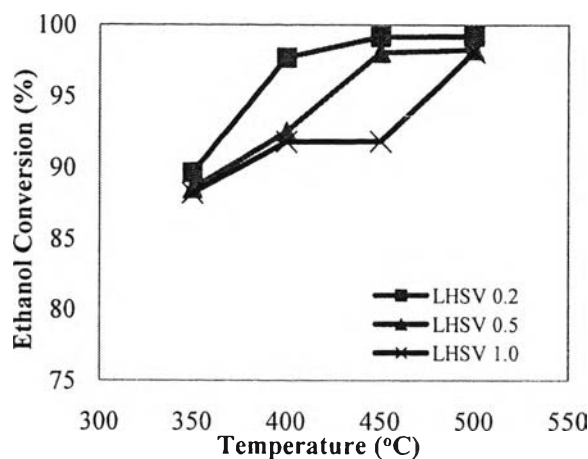
## CHAPTER IV

### RESULTS AND DISCUSSION

In this chapter, the catalytic activity testing results, including the effects of reaction temperature, liquid hourly space velocity, and time on stream, using SAPO-34 catalyst in catalytic dehydration reaction are analyzed and discussed in Parts 4.1, 4.2, and 4.3, respectively. In addition, the plant design for economic evaluation and the economic evaluation results are discussed in Parts 4.4 and 4.5, respectively, in this chapter as well.

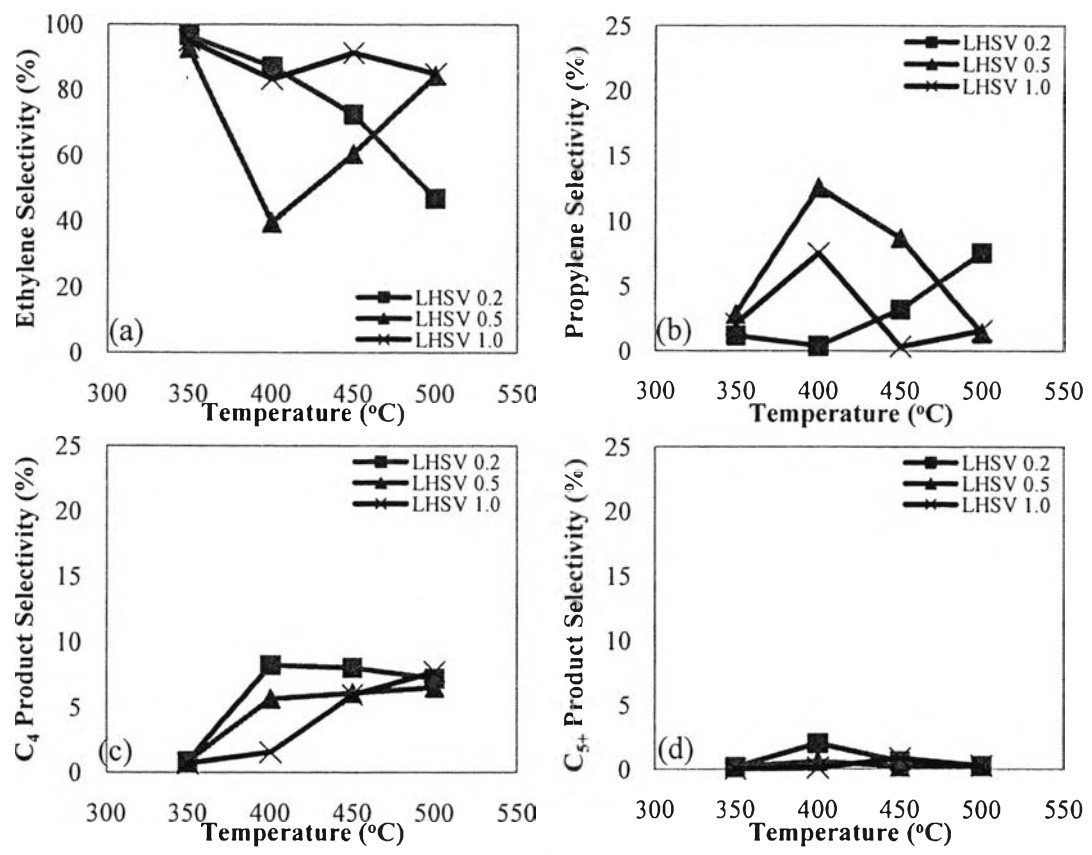
#### 4.1 Effect of Reaction Temperature

The conversion of bio-ethanol was carried out over the silicoaluminophosphate zeolite (SAPO-34) in the isothermal fixed bed reactor. The reaction temperature were varied in the range of 350 °C to 500 °C with a 50 °C increment at various liquid hourly space velocities (LHSV). The effect of reaction temperatures on the ethanol conversion results are shown in Figure 4.1. As can be seen in this figure, at each LHSV (0.2 h<sup>-1</sup>, 0.5 h<sup>-1</sup> and 1.0 h<sup>-1</sup>), the ethanol conversion tends to increase with the increasing reaction temperature. In this range of temperatures, the ethanol conversion varies from 89.6% to 99.2% at 0.2 h<sup>-1</sup> LHSV, from 88.5% to 98.3% at 0.5 h<sup>-1</sup>, and from 88.2% to 98.1% at 1.0 h<sup>-1</sup>. According to the results, the conversion of ethanol is not only controlled by the type of catalyst but also the reaction temperature. Since ethanol dehydration is an endothermic reaction, the reaction is favored at a high reaction temperature. With the increase in reaction temperature, ethanol as the reactant can be easily converted to form products and the reaction can easily shift to the product side, leading to a higher ethanol conversion at a higher reaction temperature.



**Figure 4.1** Effect of reaction temperature on ethanol conversion over SAPO-34 catalyst at various LHSVs (at 45 minutes time on stream).

Apart from the ethanol conversion, reaction temperature also affects the selectivity of the products. The selectivities of ethylene, propylene, C<sub>4</sub> product, and C<sub>5+</sub> product are shown in Figure 4.2 whereas the selectivities of ethane, propane, methane, and carbon dioxide are shown in Figure 4.3. As can be seen in Figure 4.2, the selectivity of ethylene is the highest among that of the other products at all temperatures whereas the selectivity of C<sub>5+</sub> products is a trace amount due to the moderate acid strength of the SAPO-34 catalyst. The product distribution of the conversion of ethanol strongly depends on the reaction temperature. At a high liquid hourly space velocity (1.0 h<sup>-1</sup> LHSV), temperature does not much significantly affect to the selectivity of ethylene. The ethylene selectivity varies from 83.3% to 95.1% in this range of temperature. The temperature of 350 °C is found to give the highest selectivity to ethylene whereas the selectivities to other products are very low. The dehydration of ethanol to form ethylene can easily occur at this temperature. With the increase of temperature to 400 °C, some of ethylene molecules can be further converted to form propylene, leading to the decrease of selectivity to ethylene and the increase of selectivity to propylene (7.54%). With an increase in the temperature higher than 400 °C, the selectivity to propylene decreases, but the selectivity to C<sub>4</sub> products increases because a high temperature can increase the ethylene cracking ability of an acid catalyst to form heavier products.

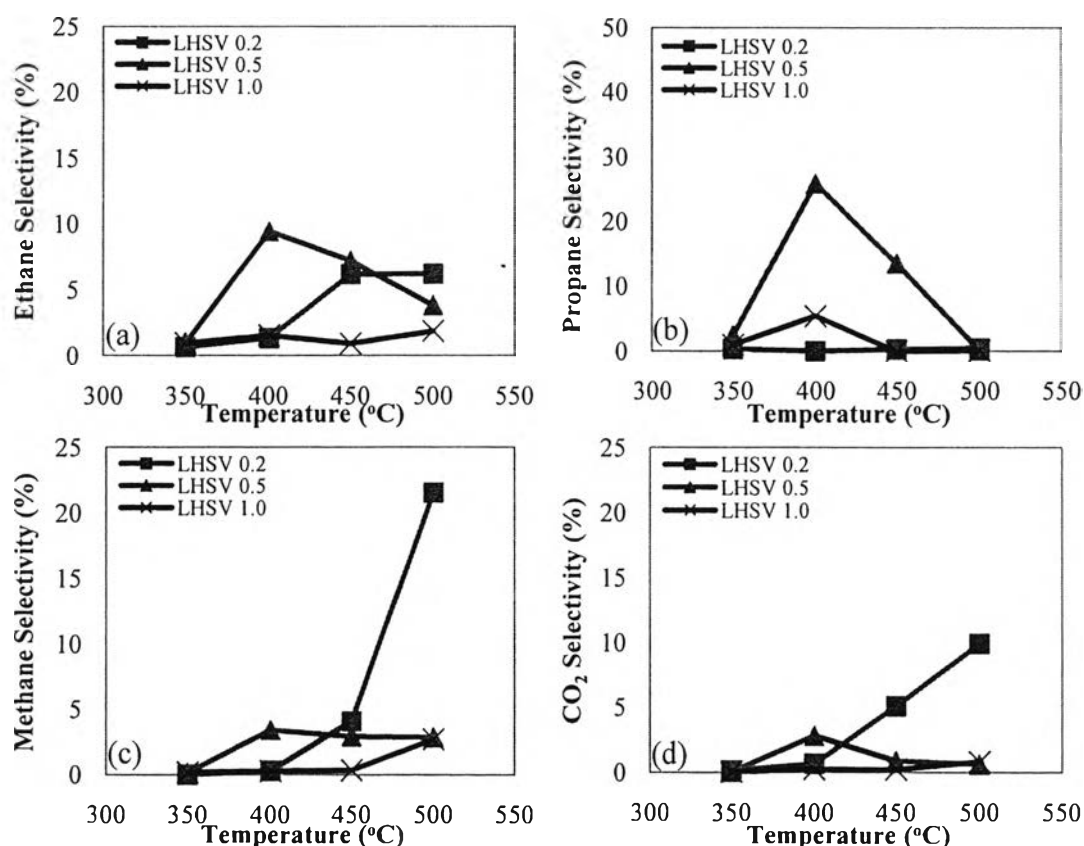


**Figure 4.2** Effect of reaction temperature on selectivity of the products over SAPO-34 catalyst at various LHSVs (at 45 minutes time on stream); (a) ethylene selectivity, (b) propylene selectivity, (c) C<sub>4</sub> product selectivity, and (d) C<sub>5+</sub> product selectivity.

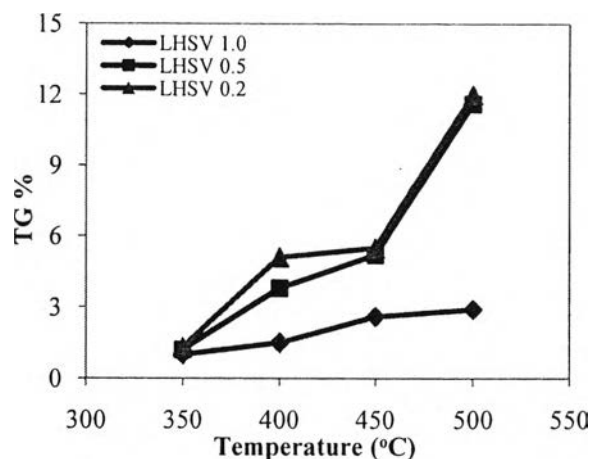
Furthermore, the influence of reaction temperature at a moderate liquid hourly space velocity (0.5 h<sup>-1</sup> LHSV) is found not much different from that of 1.0 h<sup>-1</sup> LHSV. As can be seen in Figure 4.2, the selectivity of ethylene at this LHSV is still the highest among that of the other products in this range of temperature. As mentioned above that the product distribution of ethanol dehydration is strongly controlled by reaction temperature. At a reaction temperature of 350 °C, the amount of ethylene is the highest (92.6% selectivity) when compared at the other temperatures since a low temperature around 350 °C is a suitable condition for the production of ethylene. By losing a water molecule, the ethanol can be converted to ethylene through the dehydration reaction. Some propylene molecules can also be formed at a low temperature as well but with a little amount (2.85%). When the

temperature is increased to 400 °C, some ethylene molecules can also be further converted to propylene, leading to the higher selectivity to propylene and the lower selectivity to ethylene at this temperature than those of 350 °C. Moreover, an increase in the temperature higher than 400 °C, the selectivity to propylene decreases because it can be continuously converted to heavier molecules, especially C<sub>4</sub> product, leading to the increase of selectivity to C<sub>4</sub> product at a high temperature.

Moreover, at a low liquid hourly space velocity (0.2 h<sup>-1</sup> LHSV), the effect of reaction temperature is found different. When the reaction temperature increases to 500 °C, the ethylene selectivity decreases to 46.9% in accordance with high formation of methane and carbondioxide (21.5% and 9.91%, respectively) at this temperature as shown in Figure 4.3.



**Figure 4.3** Effect of reaction temperature on selectivity of the products over SAPO-34 catalyst at various LHSVs (at 45 minutes time on stream); (a) ethane selectivity, (b) propane selectivity, (c) methane selectivity, and (d) carbondioxide selectivity.



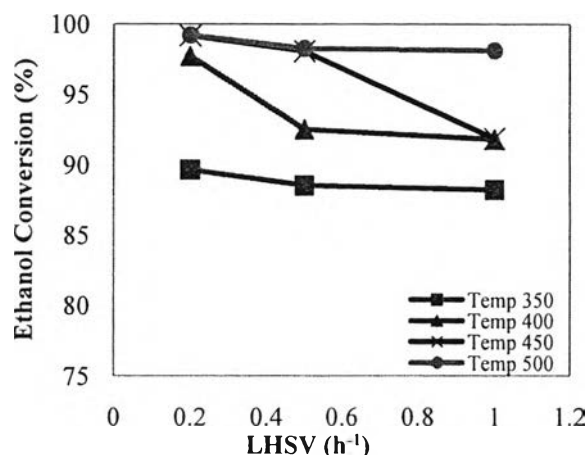
**Figure 4.4** Coke formation on spent catalysts as a function of reaction temperature.

Apart from conversion and selectivity, the temperature also affects to the coke formation on the catalysts (as shown in Figure 4.4). At all LHSVs, with the increasing temperature, heavier molecules can easily be formed, which later behave as intermediates for coke formation. Thus, a high reaction temperature causes a high amount of coke on the catalyst.

#### 4.2 Effect of Liquid Hourly Space Velocity (LHSV)

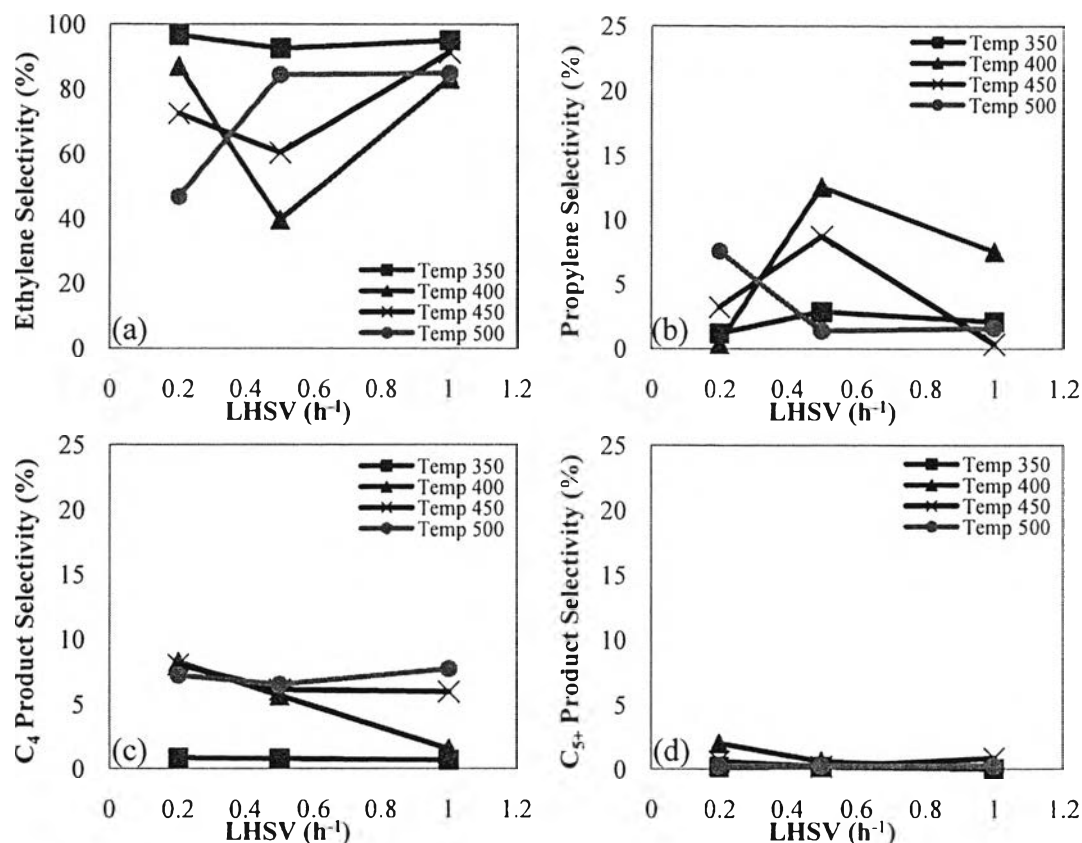
Apart from reaction temperature, liquid hourly space velocity (LHSV) also affects to the ethanol conversion and the product selectivity. The LHSVs were varied at the values of  $0.2 \text{ h}^{-1}$ ,  $0.5 \text{ h}^{-1}$ , and  $1.0 \text{ h}^{-1}$ , at various temperatures. The effect of LHSV on the ethanol conversion results are shown in Figure 4.5. As can be seen, the ethanol conversion tends to increase with the decrease in LHSV. The ethanol conversion varies from 88.2% to 89.6% at 350 °C, from 91.8% to 97.7% at 400 °C, from 91.8% to 99.2% at 450 °C, and from 98.1% to 99.2% at 500 °C in this range of LHSV. According to the results, the ethanol conversion is also controlled by the LHSV. At a high liquid hourly space velocity ( $1.0 \text{ h}^{-1}$  LHSV) that means a low contact time of ethanol in the catalyst bed, the ethanol reactant cannot be completely converted to form the products, leading to a low ethanol conversion. With the decrease in LHSV, the ethanol has more time to spend in the catalyst bed; thus, a

high amount of ethanol can be converted to form the products, leading to a higher ethanol conversion at a lower liquid hourly space velocity.



**Figure 4.5** Effect of LHSV on ethanol conversion over SAPO-34 catalyst at various temperatures (at 45 minutes time on stream).

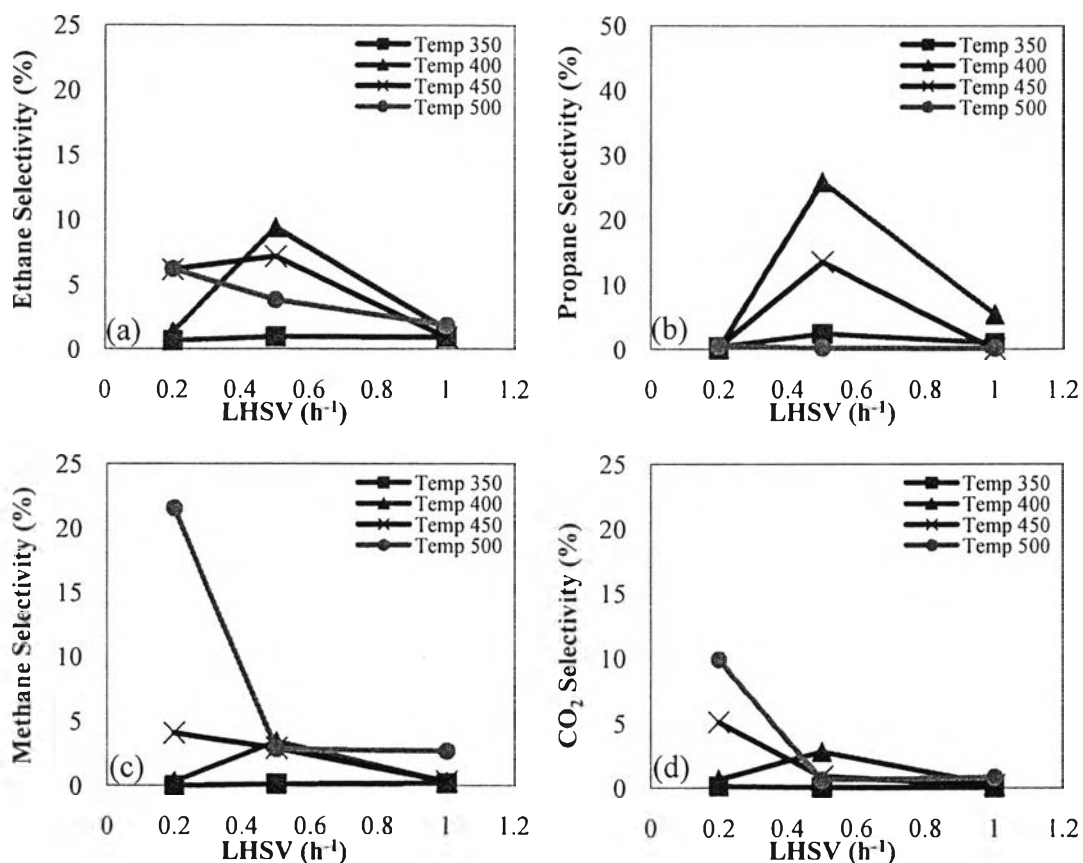
Apart from the ethanol conversion, liquid hourly space velocity also affects the selectivity of the products. The selectivities of ethylene, propylene, C<sub>4</sub> product, and C<sub>5</sub>+ product are shown in Figure 4.6 whereas the selectivities of ethane, propane, methane, and carbondioxide are shown in Figure 4.7. As can be seen at low temperature (350 °C), the liquid hourly space velocity does not much significantly affect to the selectivity of the products. The ethylene selectivity is still the highest, varying from 92.6% to 96.7% in this range of LHSVs. The propylene and other product selectivities also do not significantly change in this range of LHSVs. As mentioned above, since a low temperature is a suitable condition for the high production of ethylene; other hydrocarbons are hard to be formed at a low temperature, so the selectivities of other products, except ethylene, were still low, and do not vary with the LHSVs.



**Figure 4.6** Effect of LHSVs on selectivity of the products over SAPO-34 catalyst at various reaction temperatures (at 45 minutes time on stream); (a) ethylene selectivity, (b) propylene selectivity, (c) C<sub>4</sub> product selectivity, and (d) C<sub>5+</sub> product selectivity.

In addition, the effect of liquid hourly space velocity at a moderate temperature (400 °C – 450 °C) is somewhat different from that at a low temperature. As can be seen in Figure 4.6, at a high space velocity (LHSV 1.0 h<sup>-1</sup>), the ethylene selectivity is very high. The contact time of ethanol in the catalyst bed is pretty low, and no sufficient time is allowed for the cracking of ethylene molecules to heavier molecules, leading to the highest ethylene selectivity and low propylene and C<sub>4+</sub> products selectivities at this space velocity. When the LHSV is decreased to 0.5 h<sup>-1</sup>, there is more contact time of the ethanol feed and the ethylene product to live in the catalyst bed. Ethylene can be continuously converted to propylene and C<sub>4</sub> products, leading to the increase of selectivity to propylene at this LHSV. However, a decrease in the LHSV to 0.2 h<sup>-1</sup>, the selectivity to propylene then decreases. Since too low

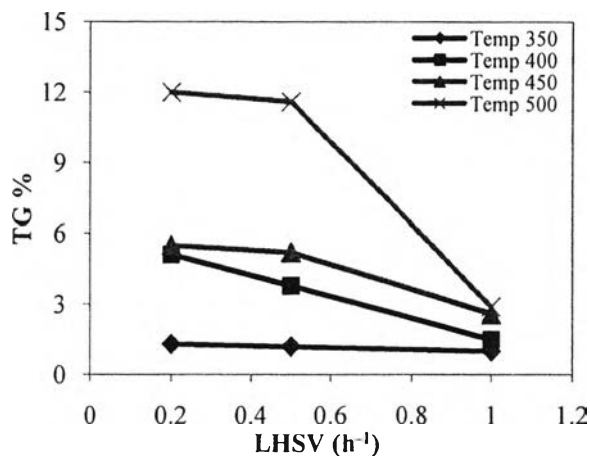
LHSV means too long contact time; when the propylene intermediates stay longer in the catalyst bed, they can be further converted to heavier products, especially  $C_4$  and  $C_6$  products, leading to the decrease of propylene selectivity and the increase of  $C_{4+}$  products selectivity.



**Figure 4.7** Effect of LHSVs on selectivity of the products over SAPO-34 catalyst at various reaction temperatures (at 45 minutes time on stream); (a) ethane selectivity, (b) propane selectivity, (c) methane selectivity, and (d) carbondioxide selectivity.

Furthermore, the LHSV also effects to the coke formation on the spent catalysts (as shown in Figure 4.8). At all reaction temperatures, when the LHSV decreases, the products have more time to spend in the catalyst bed, leading to a high production of heavier molecules, that are intermediates for coke formation. Thus, a low liquid hourly space velocity causes a high amount of coke on the catalyst.

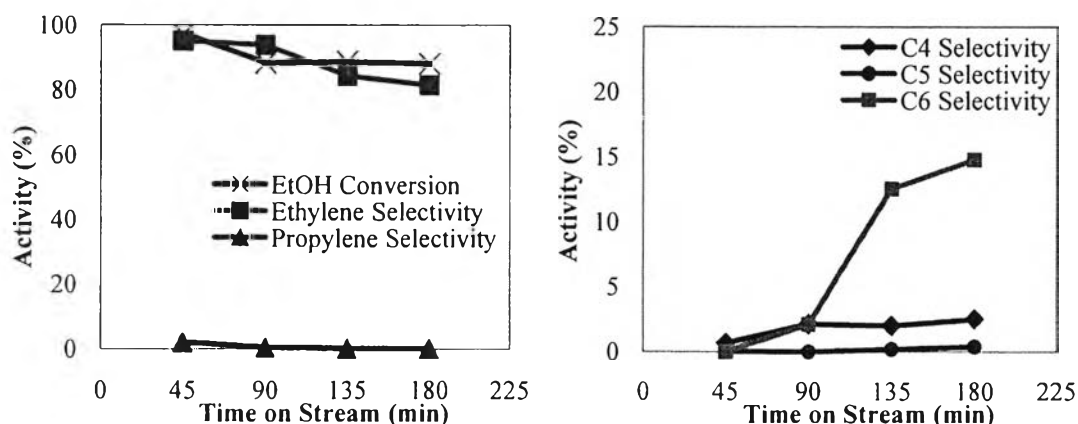




**Figure 4.8** Coke formation on spent catalysts as a function of LHSV.

### 4.3 Effect of Time on Stream

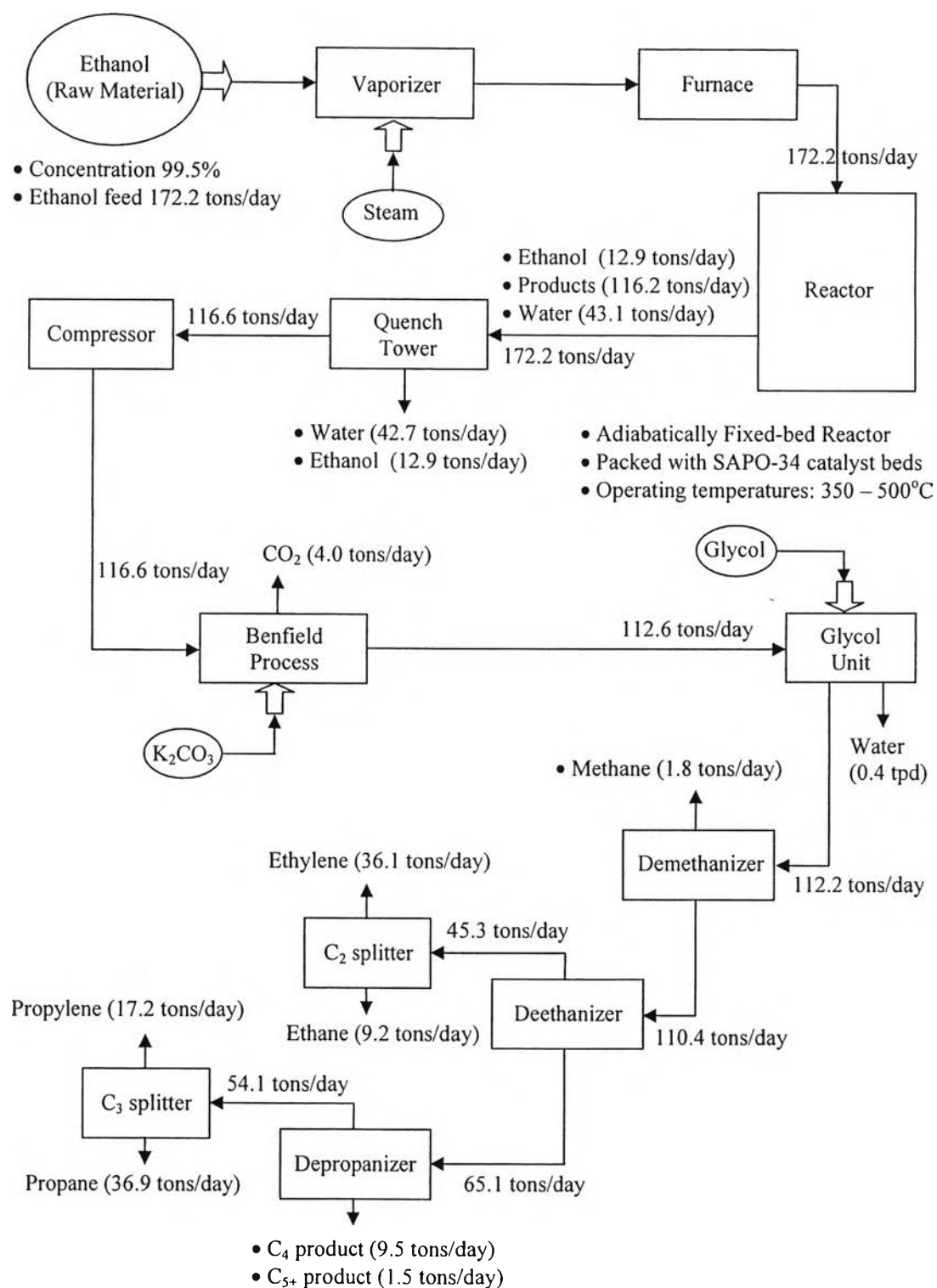
For the effect of time on stream, the gaseous product obtained at a fixed temperature of 400°C was analyzed every 45 minutes. The results are plotted against the time on stream as shown in Figure 4.9. As can be seen, the conversion of ethanol, and the selectivity of ethylene and propylene decrease with the time on stream whereas that of the C<sub>4</sub> – C<sub>6</sub> products increases. The catalytic activity decreases with the reaction time due to coke formation on the catalyst. At 400 °C, the amount of coke after 180 minutes of time on stream is 1.5% (as shown in Figure 4.8). The coke formation can deactivate and block the channel of the catalyst, so it is hard to convert ethanol, leading to the reduction in ethanol conversion. Moreover, ethylene and propylene formed over the catalyst bed can continuously be converted to heavier molecules; thus, the amount of C<sub>4</sub> – C<sub>6</sub> products increases with time on stream. Therefore, the ethylene and propylene selectivities decrease with time on stream as well.



**Figure 4.9** Catalytic activity of SAPO-34 as a function of time on stream (at  $1.0 \text{ h}^{-1}$  LHSV and  $400^\circ\text{C}$ ).

#### 4.4 Plant Design for Light Olefins Production

A light olefins production plant was further developed from the existing ethylene production plant previously developed by Chematur International AB. Chematur technology is a technology to manufacture ethylene from ethanol via catalytic dehydration process using SynDol catalyst. This plant can manufacture 30,000 metric tons of ethylene per year using 33,000 metric tons of commercial grade ethanol as the basic raw material. The conversion of ethanol and the selectivity to ethylene can reach up to 99 and 97%, respectively. Since it has only ethylene as a product with some trace of liquid products, Chematur technology has only ethylene purification. However, with using SAPO-34 as the catalyst, a significant amount of propylene is co-produced with ethylene. The modification of a process for propylene separation and purification is also needed in this work.



**Figure 4.10** Block diagram of the modified process for light olefins production.

#### 4.4.1 Process Description

Background and details of technologies are based on the existing plant. The process for the production of light olefins (both ethylene and propylene) from ethanol using SAPO-34 catalyst was further developed from Chematur International AB technology, Karlskoga, Sweden. The objective of this study was to modify and design of the ethanol dehydration process, aiming to produce high purity propylene and ethylene. The simplified block diagram of the modified process is shown in Figure 4.10. The pre-feasibility study of this light olefins manufacturing plant was also performed.

##### *4.4.1.1 General Plant Description*

According to the block diagram in Figure 4.10, 172 tons per day of 99.5% ethanol is delivered to a vaporizer in order to vaporize ethanol from a liquid phase to a vapor phase. The vaporized ethanol is then fed to the furnace to enable desired operating temperature, and passed through the four catalyst beds in an adiabatically operated reactor. The operating temperatures range of 350 -500°C. Ethanol is converted to ethylene, propylene, and other by-products as it passes over the SAPO-34 catalyst beds with 22.6 and 10.8% yield ethylene and propylene, respectively. Next, the gas stream is sent to a quench tower in order to remove water, acidic impurities, and unconverted ethanol, which later leaves at the bottom of the tower. The gas stream leaving the top of the tower is compressed and passed through a plant of Benfield process in order to remove carbon dioxide and acid gases. Then, the gas stream is dried in a drying system to remove water and carbon dioxide. After drying process, the dried gas is sent to a demethanizer where the methane gas is separated at the top of the column. The bottom stream of the demethanizer column consisting of ethylene, ethane, propylene, propane and other heavier components is sent to a deethanizer. The overhead stream from the deethanizer tower consisting of ethylene and ethane is then sent to a C<sub>2</sub> splitter in order to separate 36.1 tpd ethylene from ethane. The bottom stream from the deethanizer tower consists of propylene, propane, and other heavy molecules. The bottom stream from the deethanizer tower consisting of propylene, propane, and other heavy molecules is next passed to a depropanizer tower. The overhead stream from the depropanizer tower consisting of propylene and propane is then sent to a C<sub>3</sub> splitter in order to separate 17.2 tpd

propylene from propane. The summary of process description can be listed in Table 4.1 based on the block diagram in Figure 4.10.

**Table 4.1** Summary of plant description

Description	Value
Plant capacity	172.2 tons per day of ethanol used 36.1 tons per day of ethylene produced 17.2 tons per day of propylene produced
Ethanol feed concentration	99.5%
Ethanol conversion	92.5%
Yield of ethylene	22.6 %
Yield of propylene	10.8 %
Spec. of ethylene product	Polymer grade
Spec. of propylene product	Polymer grade
Mode of operation	Continuous (Dehydration)

#### 4.4.1.2 Description of Each Unit

The process flow sheets shown in Figures 4.11 – 4.12 portray schematically the process modified from the design proposed by Chematur International AB. The plant can be designed in three major units: (1) Reaction, (2) Product purification, and (3) Product separation. The process can be described as follows.

##### (a) Vaporizer

In this process, the ethanol used as a raw material is supplied from an offsite storage tank. The ethanol is delivered to the kettle-type ethanol vaporizer, V-110, in the liquid phase. In this unit the medium pressure steam is used to vaporize the feed ethanol from a liquid phase to a gas phase.

##### (b) Adiabatic Reactor System

Before entering the reactor, the temperature of the vaporized ethanol is increased to 400°C in the preheat section of the furnace, Q-110,

where the sufficient heat is provided to the reactor to enable desired operating temperature. The superheated ethanol then flows to the four bed adiabatic reactor, R-110. Ethanol is converted to ethylene, propylene and other by-products with 22.6% yield ethylene and 10.8% yield propylene as it passes over the catalyst beds. Ethylene and propylene formation is predominant in temperature regions of 350°C – 500°C. Since the ethanol dehydration reaction is endothermic, the effluent gas gradually cools down, leading to a progressive decrease in the reaction rate. After leaving each bed in the reactor, the effluent gas needs to be reheated in the furnace where the temperature of the effluent gas increases to the desired temperature, before being sent to the next bed of the reactor in order to increase ethanol conversion. In the last bed, the ethanol conversion is increased ultimately to 92.5%. The products consist of 36.1 tpd of ethylene, 17.2 tpd of propylene, and other by-products.

*(c) Quench Tower System*

The effluent stream leaving the last bed of the reactor is next passed to a waste heat boiler, E-110. In this unit, some of the heat is recovered for further utilization as medium pressure steam. Next, the partially cooled gas is sent to a quench tower, D-110. Using a cooler, E-120, equipped with the quench tower can help improve the removal of efficiency heat. In this system, the gas is cooled and the water in the effluent gas is condensed. The liquid in the bottom of the tower consisting of condensed water, acidic impurities, and unconverted ethanol can be removed. Some of the cool bottom fraction is sent back to the top of the tower to be used as spray-water, while the remainder is sent to wastewater treatment. Nevertheless, some oxygenate components especially acetaldehyde and diethyl ether are not condensed in the quench tower so these components need to be sent into the purification section together with light olefins and other light by products.

*(d) Compressor*

The gas stream leaving the quench tower mainly consists of ethylene (36.1 tpd) and propylene (17.2 tpd). It is next sent to a compressor, G-110, in order to enable sufficient pressure through downstream units. The outlet pressure from the compressor unit is set to a desirable operating pressure in the downstream units as well. Then, it passes through an intercooler and a knockout drum, F-110, where some of the remaining water is removed. In this stage, the

condensable component is separated from the gas, and sent back to the quench tower, D-110.

*(e) Benfield Process*

After leaving the knockout drum, the effluent gas is sent to a Benfield process, D-120, where the acid gas purification is taken place. The gas to be treated is fed to the bottom of the absorber, and flows to the top of the tower whereas the absorbing liquid (dipotassium carbonate) supplied at the top of the absorber flows in the opposite way to the bottom of the tower. The acid gas, mostly composed of  $\text{CO}_2$ , is absorbed by the absorbing liquid. After absorbing the acid gas, the liquid is preheated, and then sent to a regenerator. The acid gas is stripped by steam, and then the regenerated liquid is recirculated to the absorber.

*(f) Drying System*

The upper gas from the Benfield process is cooled then the condensable component occurred by this cooling is separated in a feed dryer knockout drum, F-210, and sent back to the quench tower whereas the cooled gas is sent to a glycol unit, P-210, where the removal of water from the effluent gas occurs. The gas stream enters the bottom of the absorption column, and contacts with the water-free glycol (lean glycol) supplied at the top of the column. The water is removed from the gas stream by physical absorption, and leaves with glycol stream at the bottom of the column; then, the glycol is thermally regenerated to remove the water and recirculated to the absorber. The dry gas leaving the top of the column is supposed to contain nearly zero moles of water, and then sent to separation units.

*(g) Demethanizer*

After drying process, the dried gas is sent to a demethanizer, A-210, in order to separate methane gas from other gases. In this unit, the gas mixture is compressed to 62 bars, cooled, and then allowed to run through a turboexpander. The turboexpander allows the gas to expand in an adiabatic expansion, and the temperature is down to  $-91^\circ\text{C}$  where the pressure in the demethanizer is maintained at 21 bars. By keeping the column at this pressure, the methane liquefies at  $-91^\circ\text{C}$ , instead of  $-161.6^\circ\text{C}$ . The liquid mixture then falls down through the demethanizer distillation column. After that, when the heat is added to the demethanizer, the methane bubbles out of the top of the column as a gas. The

bottom stream of the demethanizer column consists of ethylene (36.1 tpd), ethane (9.2 tpd), propylene (17.2 tpd), propane (36.9 tpd) and other heavier components (11.0 tpd).

*(h) Deethanizer and C<sub>2</sub> Splitter*

After passing the demethanizer, the bottom stream, mainly C<sub>2+</sub> is fed to a deethanizer tower, A-220. The deethanizer tower follows the same design and operational principles as any other distillation column, but this is the typical recovery under the cryogenic temperatures. The overhead stream from the deethanizer tower mainly consists of ethylene (36.1 tpd) and ethane (9.2 tpd) whereas the bottom stream from the deethanizer tower consists of propylene (17.2 tpd), propane (36.9 tpd) and other heavy molecules (11.0 tpd). The overhead stream from this deethanizer, containing ethane and ethylene, is then sent to a C<sub>2</sub> splitter, A-230, where the separation of ethylene and ethane is conducted. This column requires refrigeration, and the distillation zone is at a temperature being conducive to hydrate formation. The light component leaving the top of the column is ethylene, and the heavy component leaving at the bottom of the column is ethane.

*(i) Depropanizer and C<sub>3</sub> Splitter*

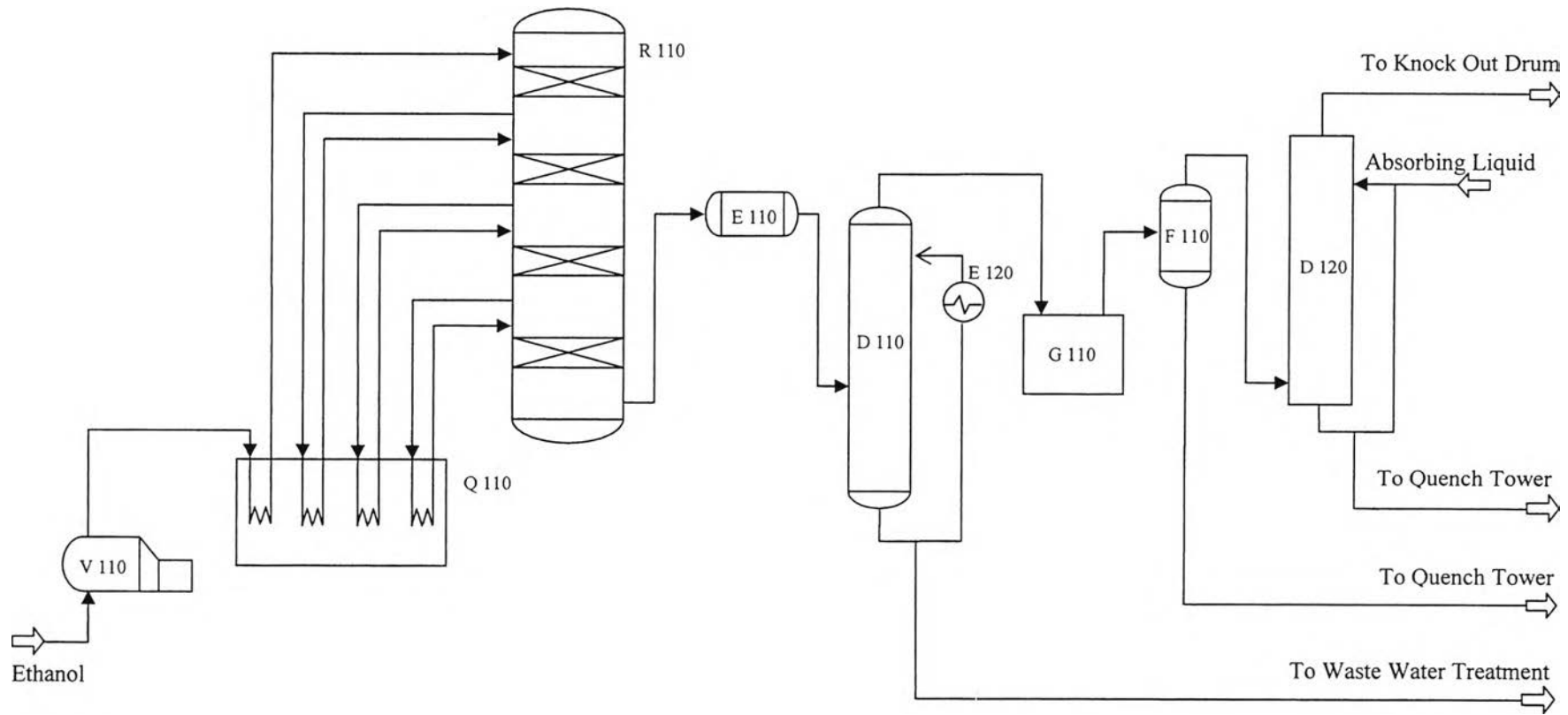
The bottom stream from the deethanizer tower consisting of propylene, propane and other heavy molecules is next fed to a depropanizer tower, A-240. The principle of operation of depropanizer is similar to those of deethanizer, but there are some differences that are temperature and pressure. In this unit the C<sub>3</sub>'s are separated from heavier components. The overhead stream from the depropanizer tower consists of propylene (17.2 tpd) and propane (36.9 tpd) whereas the bottom stream from the deethanizer tower consists of C<sub>4</sub>'s and other heavy molecules (11.0 tpd). The overhead stream from the depropanizer tower is then sent to a C<sub>3</sub> splitter, A-250, where the separation of propylene from propane takes place. The overhead stream from the C<sub>3</sub> splitter is propylene product, and the bottom stream is propane.

#### 4.4.2 Utility Requirement

In this process, the utilities needed consist of: (1) cooling water, (2) steam for the evaporator and the separating units, (3) electricity for all electrical and electronic equipments, and (4) process water for cleaning equipments.

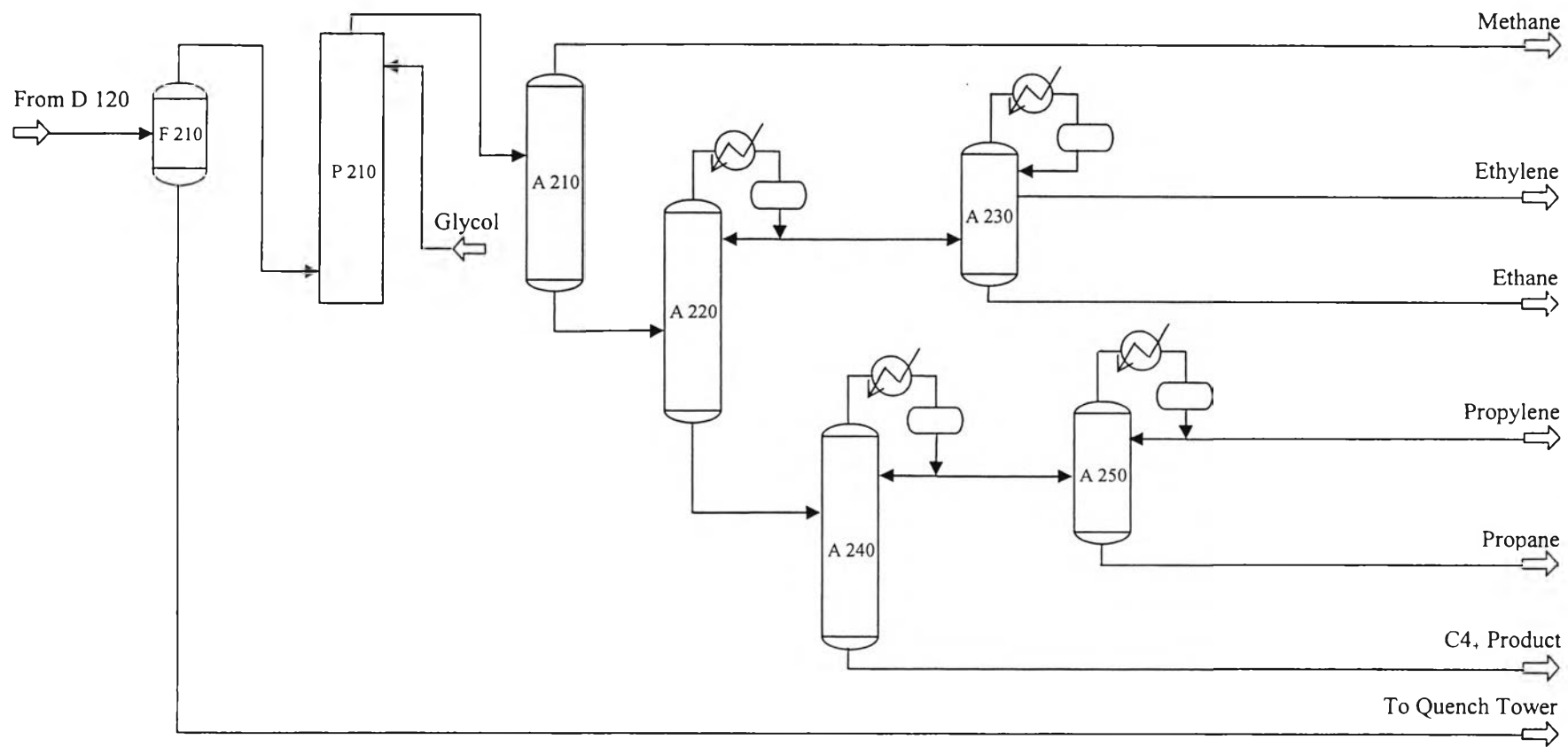


4 97195004



<b>V 110</b> Vaporizer	<b>Q 110</b> Furnace	<b>R 110</b> Reactor System	<b>E 110</b> Waste Heat Boiler	<b>D 110</b> Quench Tower	<b>E 120</b> Quench Cooler	<b>G 110</b> Compressor	<b>F 110</b> Knock Out Drum	<b>D 120</b> Benfield Process
---------------------------	-------------------------	--------------------------------	-----------------------------------	------------------------------	-------------------------------	----------------------------	--------------------------------	----------------------------------

Figure 4.11 Process flow diagram.



<b>F 210</b>	<b>P 210</b>	<b>A 210</b>	<b>A 220</b>	<b>A 240</b>	<b>A 230</b>	<b>A 250</b>
Feed Knock Out Drum	Glycol Unit	Demethanizer	Deethanizer	Depropanizer	C2 Splitter	C3 Splitter

**Figure 4.12** Process flow diagram (Cont.).

## 4.5 Economic Evaluation

According to the laboratory results (see Sections 4.1 and 4.2), the reaction temperature of 400 °C and the LHSV of 0.5 h<sup>-1</sup> were found to be the suitable set of conditions for a significantly high production of propylene. At this condition, the conversion of ethanol is 92.5%, the selectivity to ethylene is 39.7%, and the selectivity to propylene is 12.6%). Thus, the product yields from this condition was used for the economic evaluation (as shown in Table F1). The results are discussed below.

### 4.5.1 Basis Assumptions, Scope, and Limitations of the Economic Evaluation

The pre-feasibility study is subjected to the following scope and limitations.

- The feed used in this process is ethanol (99.5% concentration) supplied by a bioethanol production company transported by truck.
- The ethylene and propylene are stored as a refrigerated liquid and transported by refrigerated vessels.
- Electricity is purchased from Provincial Electricity Authority
- Waste water is sent to waste water treatment unit affecting to the total capital cost.
- The steam is bought; therefore, no steam generator is included in the design.

The total capital investment cost estimation is subjected to the following scope and limitations.

- The plant estimated cost is broken-down as follows: (1) overall Chematur plant, (2) deduction cost of drying and purification system of Chematur plant, and (3) additional estimated cost of scale-down from gas separation plant (Appendix G).

- Each broken-down item of costs is estimated in this study using the following indexing relationship.

$$Cost \propto Size^{0.6}$$

- Plant cost estimation is in the accuracy of  $\pm 50\%$ .
- Some of ISBL and OSBL are included in the cost estimation.
- Instrumentation and electrical equipments are included in the cost estimation.
- In scaled-down estimation cost, 5% inflation rate per year is taken into account as a compound basis used in the following equation.

$$Cost(Present) = Cost(1 + Inflation\ rate)^{year}$$

For economic evaluation, basis assumptions are listed as follows.

- All Capex is paid at zero after 20 years.
- All of capital costs were evaluated in  $\pm 50\%$  accuracy by Thairoil Company Limited.
- Gaseous products are sold as fuels according to their heating values.
- Labor and maintenance costs are 3.1% of investment cost, each.
- Utility costs of light olefins plant are 20% added on top of that of Chematur plant.
- Operating time is 8,000 hours per year (333 days per year)
- Economic life is 20 years, corporate tax is 30%, and depreciation is 20 years.

#### 4.5.2 Economic Evaluation and Feasibility

The economic feasibility information for the production of light olefins from bio-ethanol plant is discussed in this section. The economic evaluation is based on the plant capacity of 172.2 tonnes ethanol per day (see Section 4.4.1). The cost estimation is subjected to the scope and limitations described in Section

4.5.1. With the following evaluation, the information on the ethanol to light olefin plant is presented in Table 4.2.

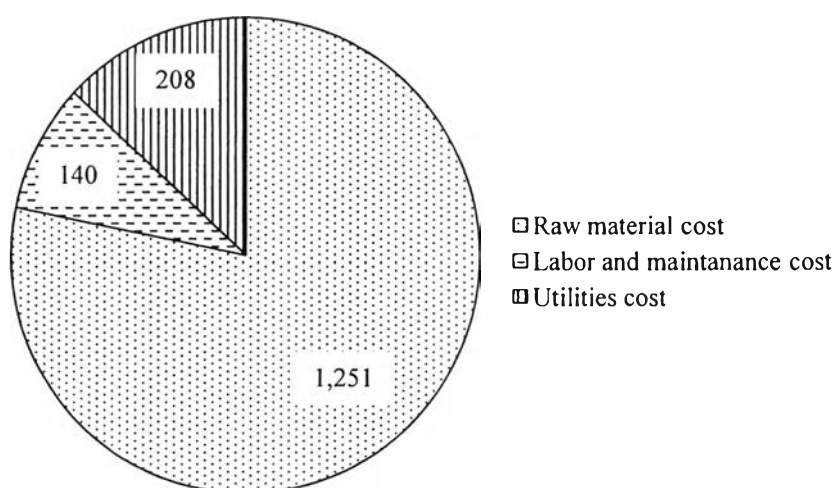
**Table 4.2** Ethanol to light olefins plant information

<b>Total Capital Cost</b>	
Total investment cost (Mil.Baht)	4,515
<b>Operating Cost</b>	
Raw material cost (Mil.Baht/year)	1,251
Labor cost and maintenance cost (Mil.Baht/year)	140
Utilities cost (Mil.Baht/year)	208
Total operating cost (Mil.Baht/year)	1,599
<b>Revenue</b>	
Ethylene sale (Mil.Baht/year)	562
Propylene sale (Mil.Baht/year)	288
Natural gas sale (Mil.Baht/year)	434
Gross sale (Mil.Baht/year)	1,284

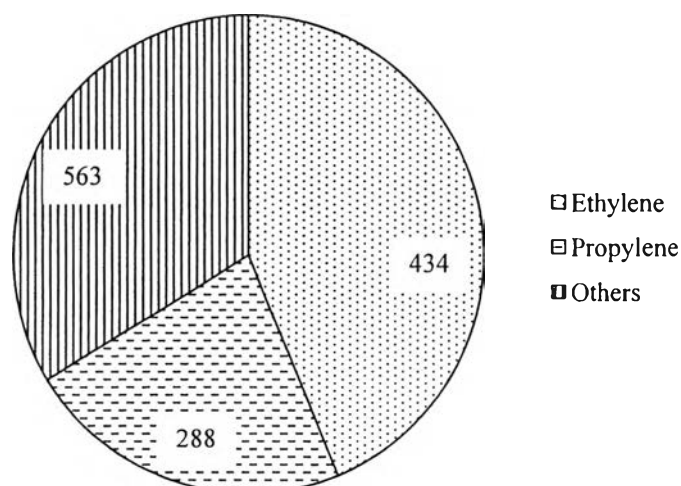
The total capital investment cost of light olefins production plant was roughly estimated as follows: (1) First, the overall cost of Chematur plant was deducted by the cost of its drying and purification system, and (2) then added with the estimated cost of gas separation plant scaled down from the one operated at PTT Public Company Limited (as shown in Appendix G). As can be seen in Table 4.2 and Appendix F, the total investment cost of this plant is 4,145 millions baht.

Apart from the total capital investment cost, another important parameter for economic evaluation is operating cost. The operating costs are divided into two groups: one is fixed operating costs and another is variable operating costs. Fixed operating costs are almost constant in every years, and do not significantly change when the production rate is changed. The fixed operating costs include, for examples, labor cost and maintenance cost. Variable operating costs are the costs associated with the production that change when the production rate is changed. The

variable costs include, for examples, raw material cost and utility costs. In this case, the operating cost breakdown is shown in Figure 4.13. As can be seen from Table 4.2 and Figure 4.13, the total operating cost is about 1,599 millions baht per year. The raw material cost is 1,251 millions baht per year or about 78.2% of the total capital cost. Since the raw material cost is the highest among the other operating costs, it is the most important factor affecting the total capital cost.



**Figure 4.13** Operating cost breakdown (millions baht per year).



**Figure 4.14** Product revenue distribution (millions baht per year).

The revenues of bio-ethanol to light olefins plant come from the selling of the product. Ethylene and propylene are sold in a specification of polymer grade olefins with the price of 46,800 and 50,400 baht per ton, respectively. Other products including methane, ethane, propane, C<sub>4+</sub> product and carbondioxide are sold as fuels whose price is calculated from the heating values. The product revenues distribution is shown in Figure 4.14. As can be seen from Table 4.2 and Figure 4.14, the revenues of ethylene, propylene, and natural gas are 434, 288, and 563 millions baht per year, respectively.

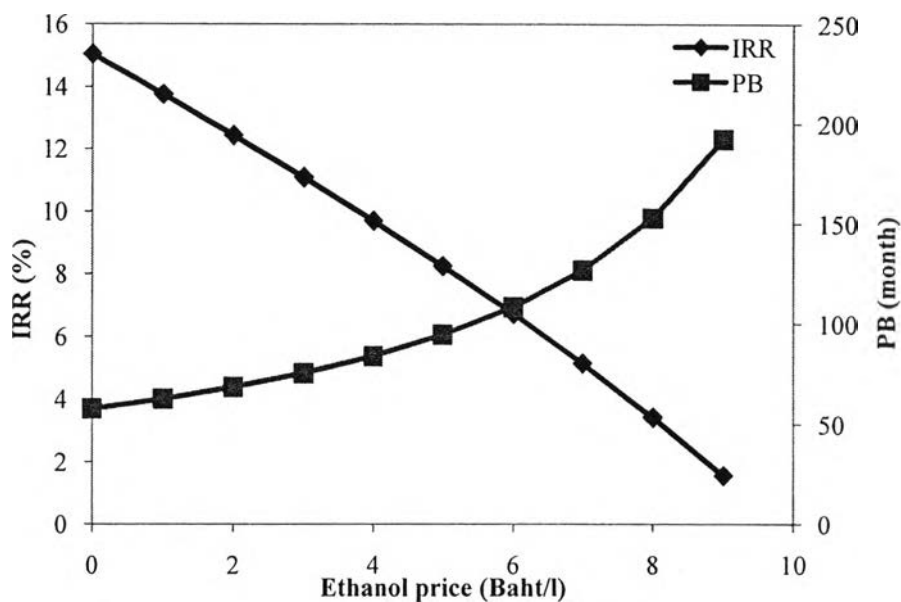
According to the total capital cost, operating cost, and revenues in Table 4.2, the operating costs (1.599 millions baht per year) are higher than revenues (1,284 million baht per year). The margin of the evaluation have a negative sign (-315 millions baht per year) that means the revenues are less than the expenses. Moreover, the net cash flow after tax consequently has a minus sign, leading to no value of internal rate of return (IRR can not be calculated); thus the bio-ethanol to light olefins plant is not feasible in this case.

#### 4.5.3 Sensitivity Analysis

Two parameters, including the ethanol price and the product prices, are studied in the sensitivity analysis of the bio-ethanol to light olefins plant.

##### *4.5.3.1 Ethanol Price Factor*

As mentioned above, this plant is not commercially feasible at the input values of ethanol price and products price. The ethanol price is varied in this section in order to find the optimum price that gives 15% internal rate of return. The product prices including ethylene, propylene, and natural gas were fixed at 46,800 baht per ton, 50,400 baht per ton, and 442.3 baht per million BTU, respectively (Appendix F). The sensitivity of IRR toward ethanol price is shown in Figure 4.15. As can be seen, with the decrease in ethanol price, the internal rate of return increases whereas payback period (PB) decreases. The ethanol price that makes this plant commercially feasible with 15.0% IRR and 58 month PB is 0.03 baht per liter, which is not possible.

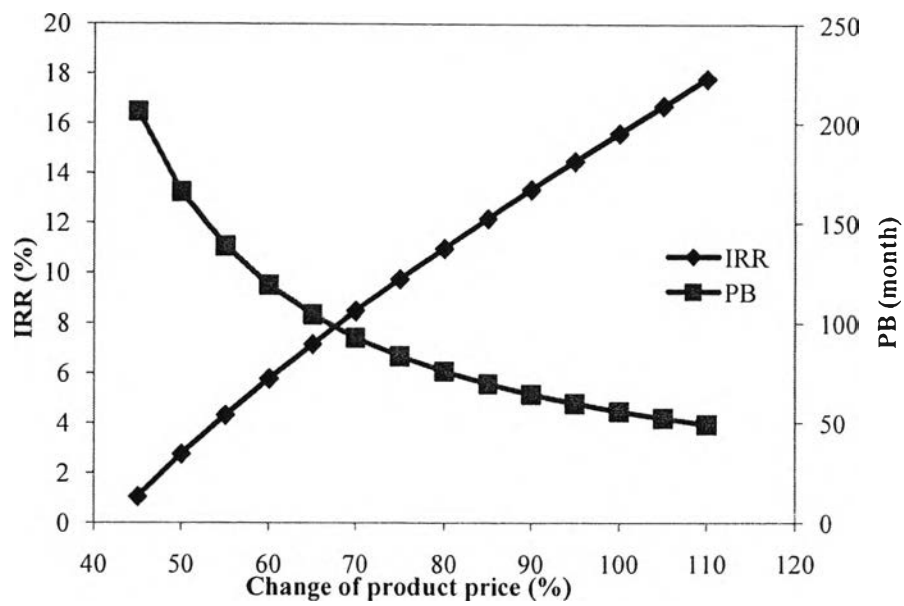


**Figure 4.15** Sensitivity of IRR toward ethanol price (at fixed product prices).

#### 4.5.3.2 Product Price Factor

Apart from the ethanol price, the product prices are one of the factors determining the feasibility of the bio-ethanol to light olefins plant. The product prices (ethylene, propylene, and natural gas) are varied in order to find the optimum price that gives 15% internal rate of return (Appendix F). The sensitivity of IRR toward product prices is shown in Figure 4.16. From this figure, with the increase in the product prices, the internal rate of return increases whereas the payback period decreases. The product prices that make this project commercially feasible with 15.2% IRR and 57 month PB are 98% higher than the original prices (92,664 baht per ton ethylene, 99,792 baht per ton propylene, and 876 baht per million BTU natural gas).





**Figure 4.16** Sensitivity of IRR toward the change of product (at fixed ethanol price of 17.2 baht per kg).