

CHARTER IV

RESULTS AND DISCUSSION

4.1 Improved Systematic Methodology of Selection and Design of the Best IL-Based Separation Process for Generic Systems

An attempt to create the effective methodology of selecting ILs has not been successful over a last decade although a number of researches on ILs have been published; however, a majority of research was based on experimental liquid-liquid extraction and many of them were based on their in-house programs such as COSMOtherm software. A comparison for the selection in terms of simulation process design and economic evaluation has not much been found. Beyond the part of IL selection, this work also aims to design the systematic methodology covering both the process design and economic evaluation by demonstrating on our available programs including ICAS, ProPred, PROII and ECON software.

In order to get the best IL-based separation process, three main stages, namely the selection, verification, and comparison are illustrated in Figure 3.1 and Table 4.1. A summary of this systematic methodology is described in the following subsections.

Table 4.1 List of all steps and constraints of each stage in the improved systematic methodology of selection and design of the best IL-based separation process for generic systems

	Step	Constraint	Tool
Stage 1: Selection			
Mixture selection	1) Collect the problem mixture	Homogeneous binary mixture	Literature database
	2) Select the problem mixture	Industrial needs	
Separation process selection	1) Collect the technology of separation process	Suitable separation process for ILs	Literature database
	2) Select the suitable technology for ILs		
IL pre-selection	1) Collect the necessary IL data	Property parameters	Screening graphs
	2) Construct the screening graph	- Hildebrand solubility parameter	
	3) Select the feasible IL candidates	- Capacity and selectivity	

Table 4.1 List of all steps and constraints of each stage in the improved systematic methodology of selection and design of the best IL-based separation process (continued).

	Step	Constraint	Tool
Stage 2: Verification			
Verification of mixture	1) Verify the mixture behavior and target solute from VLE graph	Mixture behavior	ICAS
	2) Verify the target solute from vapor pressure and heat of vaporization graphs	Target solute	ProPred
Verification of IL	1) Collect NRTL binary parameters of ILs	NRTL binary parameters	Literature database
	2) Calculate the critical properties of ILs	Separation capability	ICAS
	3) Generate VLE graph of ILs		

Table 4.1 List of all steps and constraints of each stage in the improved systematic methodology of selection and design of the best IL-based separation process (continued).

	Step	Constraint	Tool
Stage 3: Comparison			
VLE comparison	1) Evaluate the separation capability of both ILs	Separation capability	ICAS
Simulation comparison	1) Simulate the separation process of conventional organic solvents (base case)	Energy requirement	PROII
	2) Simulate the separation process of ILs	Solvent rate	
	3) Evaluate the best IL-based separation process		
Economic comparison	1) Calculate sizing equipment	CAPEX, OPEX and economic cost ratio of IL by CS $(X_{IL}/X_{CS})_{econ}$	Econsoftware
	2) Calculate capital cost (CAPEX) and operating cost (OPEX)		
	3) Calculate the economic cost ratio of IL by CS $(X_{IL}/X_{CS})_{econ}$		

4.1.1 Stage 1: Selection

This step involves with defining a problem mixture, selection of a separation process and the IL entrainers. Both azeotropic mixture (azeotrope) and close-boiling mixtures are defined as the problem mixtures in this study. The problem mixtures are then classified by the number of components, phase (homogeneous or heterogeneous system) and type of solution (aqueous or non-aqueous system). The selection of the problem mixtures is mainly based on their widely used in several industries. After that, they become the case studies for performing in the extractive distillation (ED) process. The outstanding technique of ED is an addition of a third component presented by ILs as entrainer. Since ILs have the separation capability to effectively break azeotrope or increase the relative volatility of mixtures. In-depth details are described below.

4.1.1.1 *Mixture Selection*

- Step 1: Collect problem mixtures from literature database

Problem mixtures (e.g. azeotropic mixture and close-boiling mixture) are collected from literature database and then classified by the number of components, phase and type of solution. In addition, the data of azeotropic point should be included (if any).

- Number of components
 - Binary (2 compounds)
 - Ternary (3 compounds)
 - Quaternary (4 compounds)
- Phase
 - Homogeneous form (single phase)
 - Heterogeneous form (mixed phase)
- Type of solution
 - Aqueous systems (with water) e.g. Water + Alcohol
 - Non-aqueous systems (without water) e.g. Alcohol + Aliphatic Hydrocarbons

- Step 2: Select the problem mixtures

The selection of problem mixtures for case studies is based on the real application in industries. Since ILs are new type of compounds and new ILs have been continuously reported, the number of available literature database of the interest IL and its interaction with the problem mixture is one of the additional consideration for the selection.

4.1.1.2 Separation Process Selection

Since most of ILs have a high boiling temperature and be able to extract a target solute in the problem mixtures, the technique of ED process is suitable and matching on the capability of ILs. Only the ED process is selected for this methodology.

4.1.1.3 IL Pre-Selection

Coming to the last step of selection as the heart of this methodology, the effective tool in this part is the screening graphs made from both experimental and predicted property parameters of ILs in order to pre-selecting the feasible IL candidates. The comprehension of all procedures should be done before performing.

- Step 1: Collect the necessary IL data

With regard to the feasible ILs, chemical data and activity coefficients at infinite dilution at 298 K are proposed to collect for the calculation of the Hildebrand solubility parameter, capacity and selectivity of ILs. The following data have been collected.

- Chemical Data
 - Name(e.g.1-hexyl-3-methylimidazolium tetracyanoborate)
 - Abbreviation (e.g. HMIM-TCB)
 - Structure

The Extended Group Contribution (GC) of Hildebrand solubility parameter model for ILs from Kulajanpeng *et al.* (2014) as shown in Table

2.7 is successfully calculated the Hildebrand solubility parameter of ILs by using the linear model in Equation 2.5 (see the derivation of model in appendix C).

▪ **Activity coefficients at infinite dilution at 298 K**

The average experimental activity coefficients at infinite dilution for each solute in IL are the key property parameters to calculate the capacity and selectivity of ILs in Equations 2.13 and 2.14, respectively.

• Step 2: Construct the screening graph

To construct the screening graphs, three graphs are plotted;

▪ 1st plot: the Hildebrand solubility parameters of ILs in the *x-axis* vs the capacity (C_2^∞) of ILs in *y-axis*

▪ 2nd plot: the Hildebrand solubility parameters of ILs in the *x-axis* vs the selectivity (S_{12}^∞) of ILs in *y-axis*

▪ 3rd plot: the Hildebrand solubility parameters of ILs in the *x-axis* vs the capacity (C_2^∞) of ILs in the primary *y-axis* and selectivity (S_{12}^∞) of ILs in the secondary *y-axis*

Two vertical lines depicted in Figure 4.1 represent the Hildebrand solubility parameters of the each solute in the mixtures (e.g. $\delta_{solute1}$ and $\delta_{solute2}$). All three aforementioned graphs were plotted for both solutes to observe the trend of capacity (see Figure 4.1) and selectivity (see Figure 4.2) against Hildebrand solubility parameter. Then, both capacity and selectivity were plotted against Hildebrand solubility parameter as depicted in Figure 4.3. Three similar graphs were constructed for solute 2 as shown in Figures 4.4 to 4.6. It is noted that the effective screening graphs provide a number of feasible ILs with the feasible target solute.

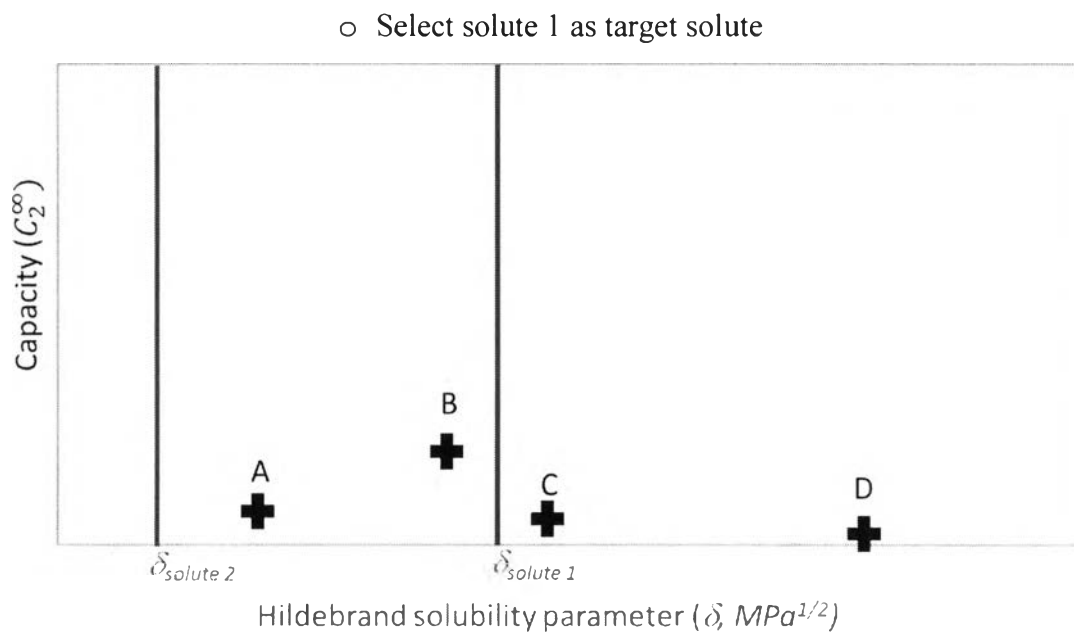

Figure 4.1 Hildebrand solubility parameters of ILs in *x-axis* vs Capacity (C_2^∞) of ILs in *y-axis* (solute 1 as target solute), where A, B, C and D stand for ILs.

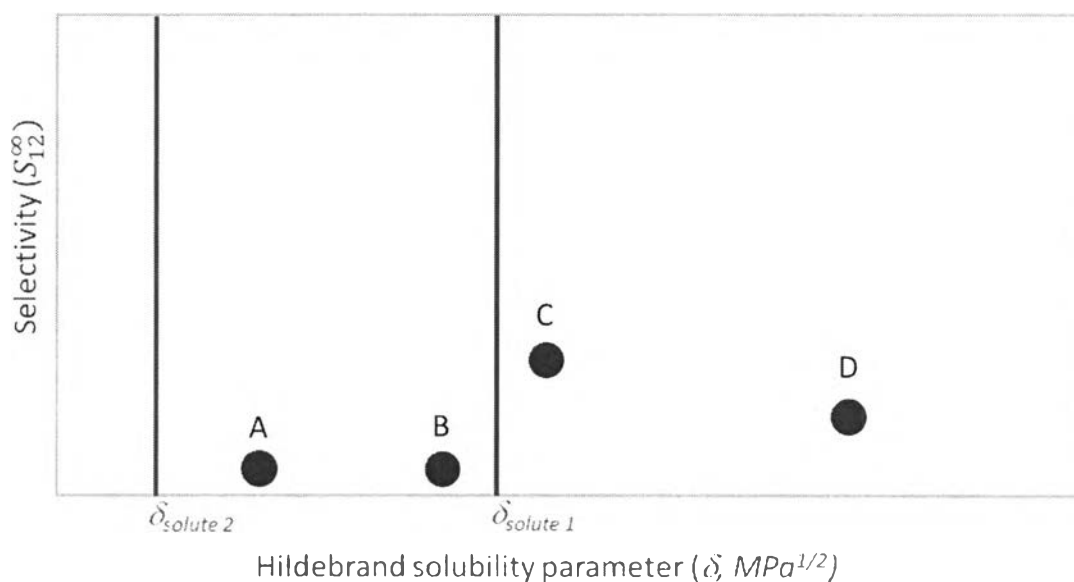

Figure 4.2 Hildebrand solubility parameters of ILs in *x-axis* vs Selectivity (S_{12}^∞) of ILs in *y-axis* (solute 1 as target solute), where A, B, C and D stand for ILs.

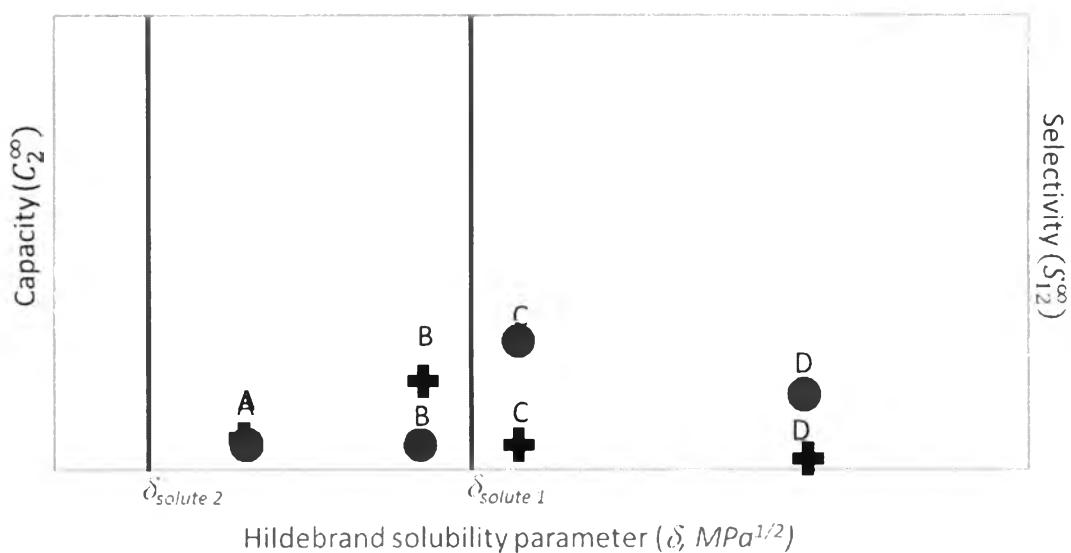

Figure 4.3 Hildebrand solubility parameters of ILs in x -axis vs Capacity (C_2^∞) of ILs in primary y -axis and Selectivity (S_{12}^∞) of ILs in secondary y -axis (solute 1 as target solute), where A, B, C and D stand for ILs.

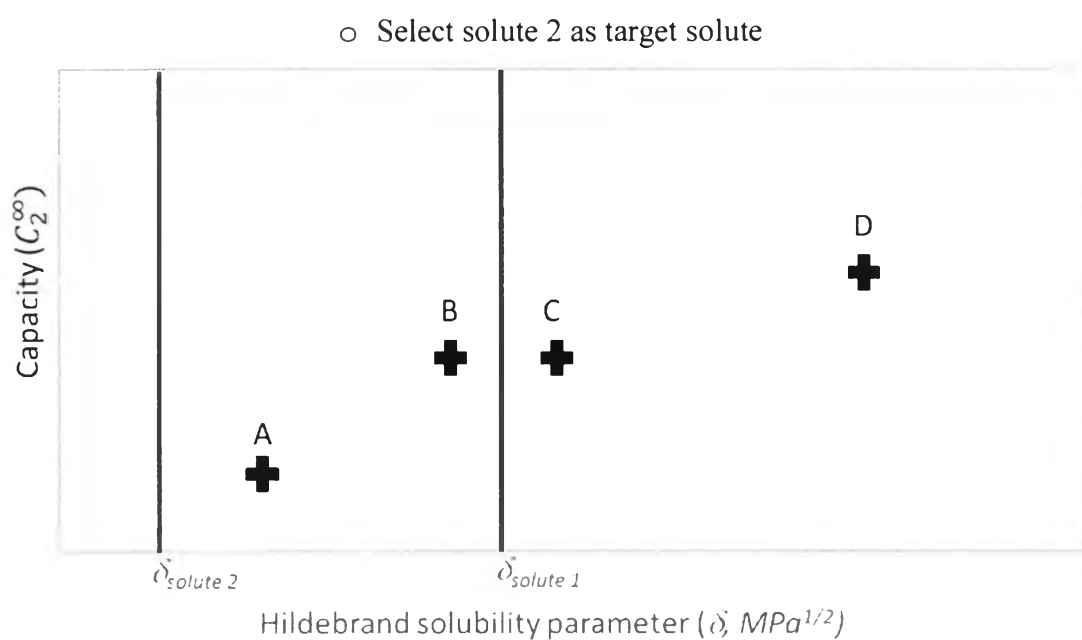

Figure 4.4 Hildebrand solubility parameters of ILs in x -axis vs Capacity (C_2^∞) of ILs in y -axis (solute 2 as target solute), where A, B, C and D stand for ILs.

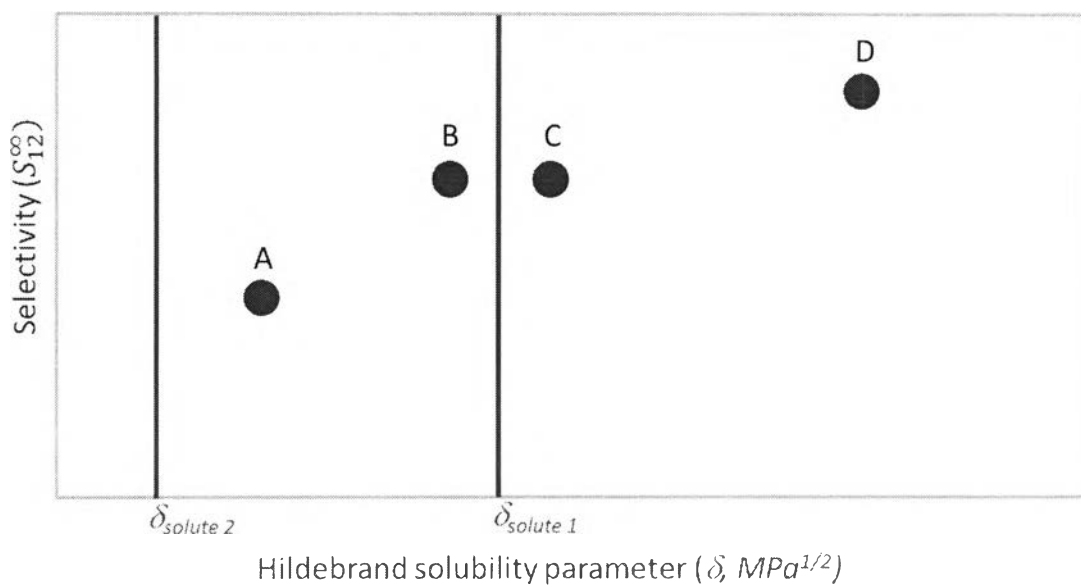

Figure 4.5 Hildebrand solubility parameters of ILs in x -axis vs Selectivity (S_{12}^{∞}) of ILs in y -axis (solute 2 as target solute), where A, B, C and D stand for ILs.

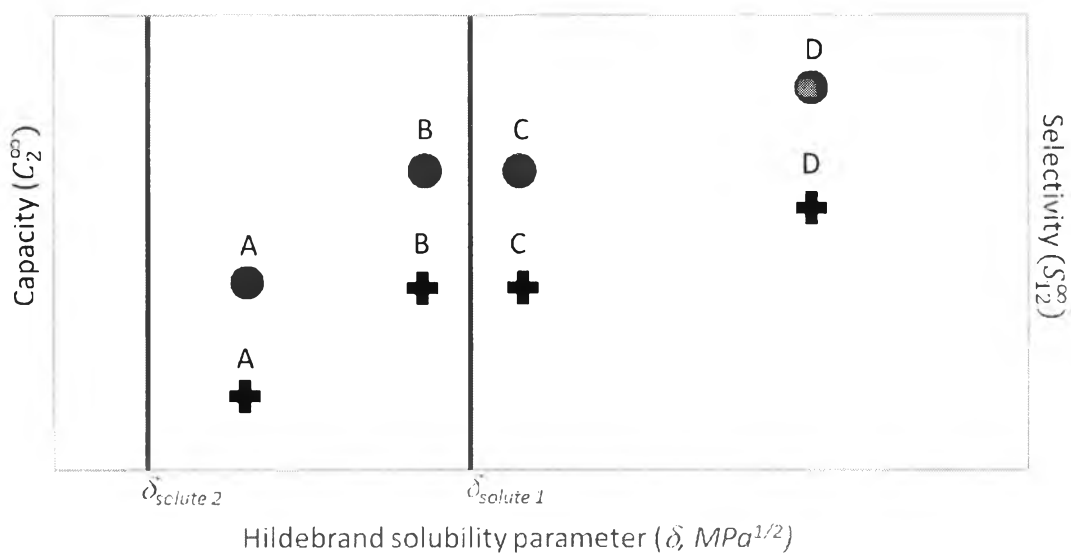

Figure 4.6 Hildebrand solubility parameters of ILs in x -axis vs Capacity (C_2^{∞}) of ILs in primary y -axis and Selectivity (S_{12}^{∞}) of ILs in secondary y -axis (solute 2 as target solute), where A, B, C and D stand for ILs.

- Step 3: Select the feasible IL candidates
 - Select the minimum and maximum capacity (C_2^∞) of ILs in the first plot of screening graph between the Hildebrand solubility parameter of ILs vs capacity (C_2^∞) of ILs as shown in Figure 4.7.

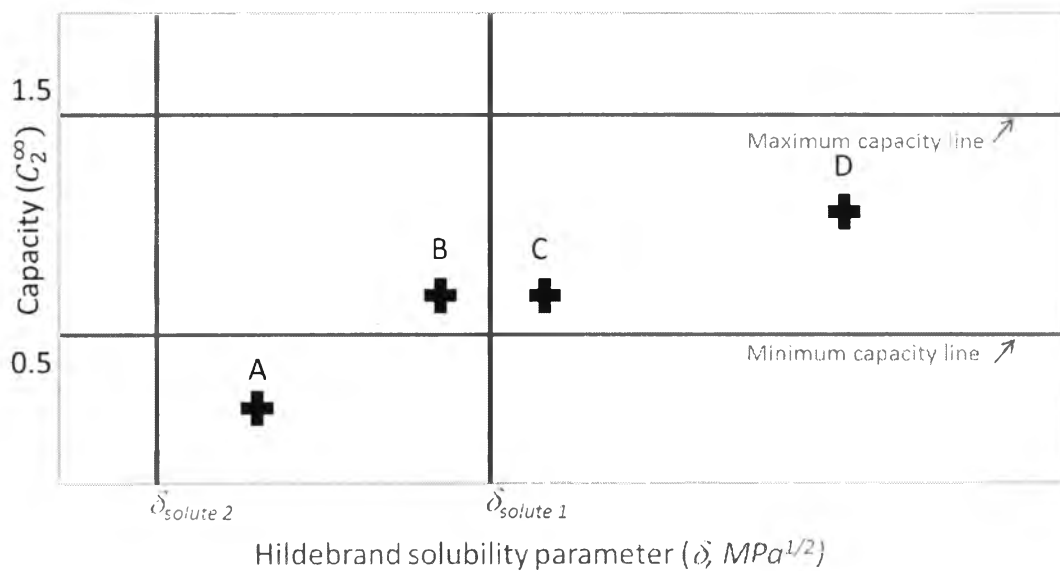

Figure 4.7 Hildebrand solubility parameter of ILs in *x-axis* vs Capacity (C_2^∞) of ILs in *y-axis* (solute 1 as target solute), where A, B, C and D stand for ILs.

- Select the minimum and maximum selectivity (S_{12}^∞) of ILs in the second plot of screening graph between the Hildebrand solubility parameter of ILs vs selectivity (S_{12}^∞) of ILs.

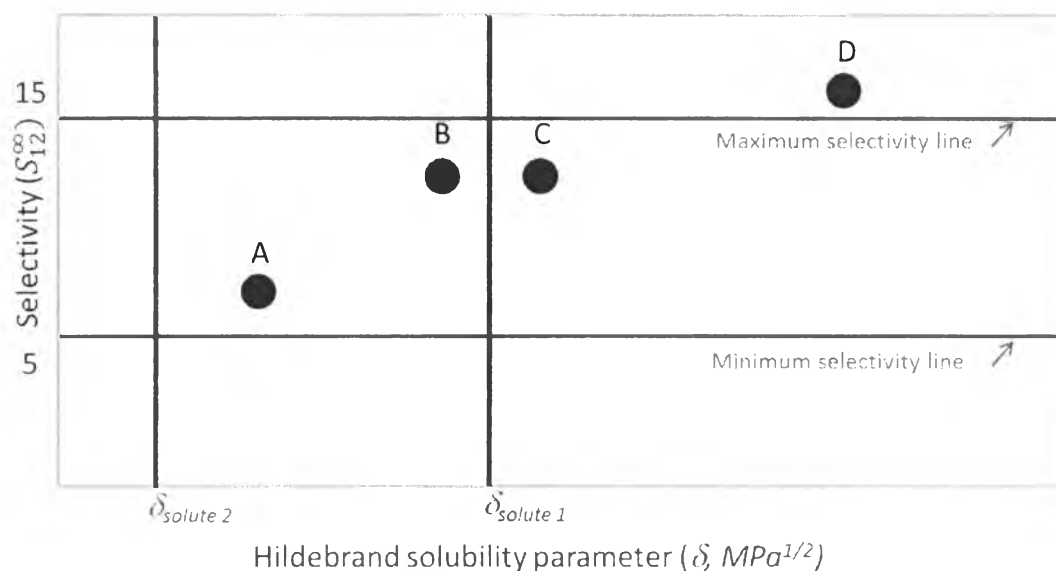

Figure 4.8 Hildebrand solubility parameters of ILs in x -axis vs Selectivity (S_{12}^{∞}) of ILs in y -axis (solute 1 as target solute), where A, B, C and D stand for ILs.

- Combine the minimum and maximum of both capacity (C_2^{∞}) and selectivity (S_{12}^{∞}) of ILs into the third plot of screening graph between the Hildebrand solubility parameter vs capacity (C_2^{∞}) and selectivity (S_{12}^{∞}) of ILs to establish the boundary of the Hildebrand solubility parameter as the target window. The feasible IL candidates were selected based on the closest to the Hildebrand solubility parameter (δ) of the target solute (i.e. shaded area in the target window of $\delta_{solute 1}$ shown in Figure 4.9). Beyond that, these feasible IL candidates should have both high capacity and high selectivity. It is noted that the minimum and maximum ranges of the capacity and selectivity can be adjusted depending on a specific azeotropic mixture.

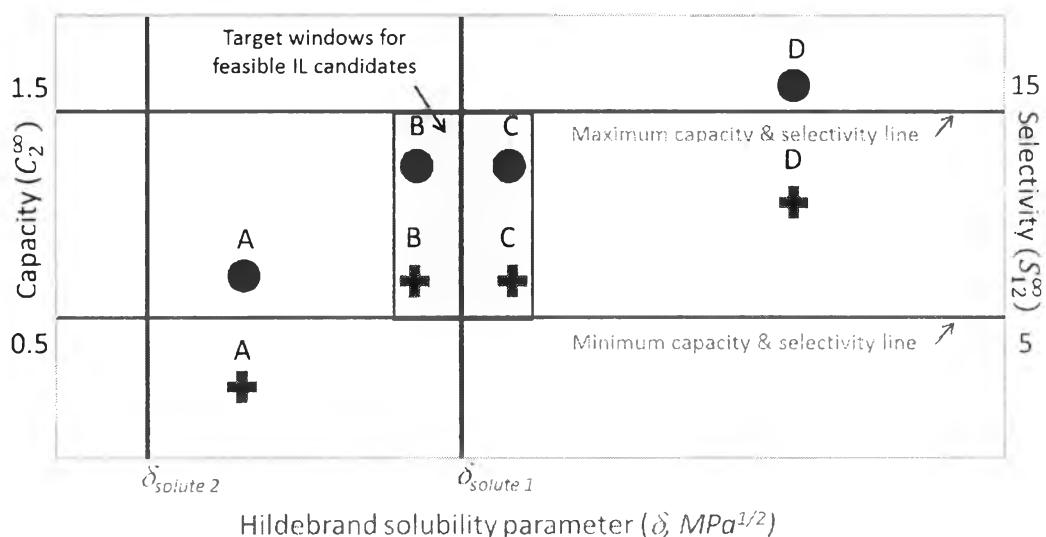

Figure 4.9 Hildebrand solubility parameters of ILs in x -axis vs Capacity (C_2^∞) of ILs in primary y -axis and Selectivity (S_{12}^∞) of ILs in secondary y -axis (solute 1 as target solute), where A, B, C and D stand for ILs.

4.1.2 Stage 2: Verification

The main purpose of the verification emphasizes on the investigation of mixture behavior (e.g. the comparison between vapor pressure and heat of vaporization of each pure component, types of mixture and an azeotropic point (if any) from the selected mixtures. In addition, the selected target solute in each mixture from screening graphs must be investigated to confirm the suitability. Finally, the separation capability of feasible IL candidates was also observed.

4.1.2.1 Verification of Mixture

The analytical graphs of mixture, for instance, vapor pressure and heat of vaporization graphs from ProPred program (or available literature database) and a vapor-liquid equilibrium (VLE) graph using ICAS program, were plotted to investigate the mixture behavior from vapor pressure and heat of vaporization of each pure component, classify the types of mixtures as azeotropic or close-boiling mixture, and observe (if any) the azeotropic point. Furthermore, these plots help to ensure the target solute of each mixture whether it is easier to extract along with ILs than another one.

- Step 1: Verify the mixture behavior and target solute from vapor pressure and heat of vaporization graphs

The plots of vapor pressure and heat of vaporization are shown in Figures 4.10 and 4.11, respectively. These plots present the pure component behavior of each solute. These two plots help identify the overhead and bottom product of the mixture of solute 1 and solute 2. As an entrainer, the target solute is extracted by IL and come out as a bottom product in the extractive distillation column. For instance, Figures 4.10 and 4.11 indicate that solute 1 is that target solute since the vapour pressure of solute 1 is lower while the heat of vaporization is higher than solute 2.

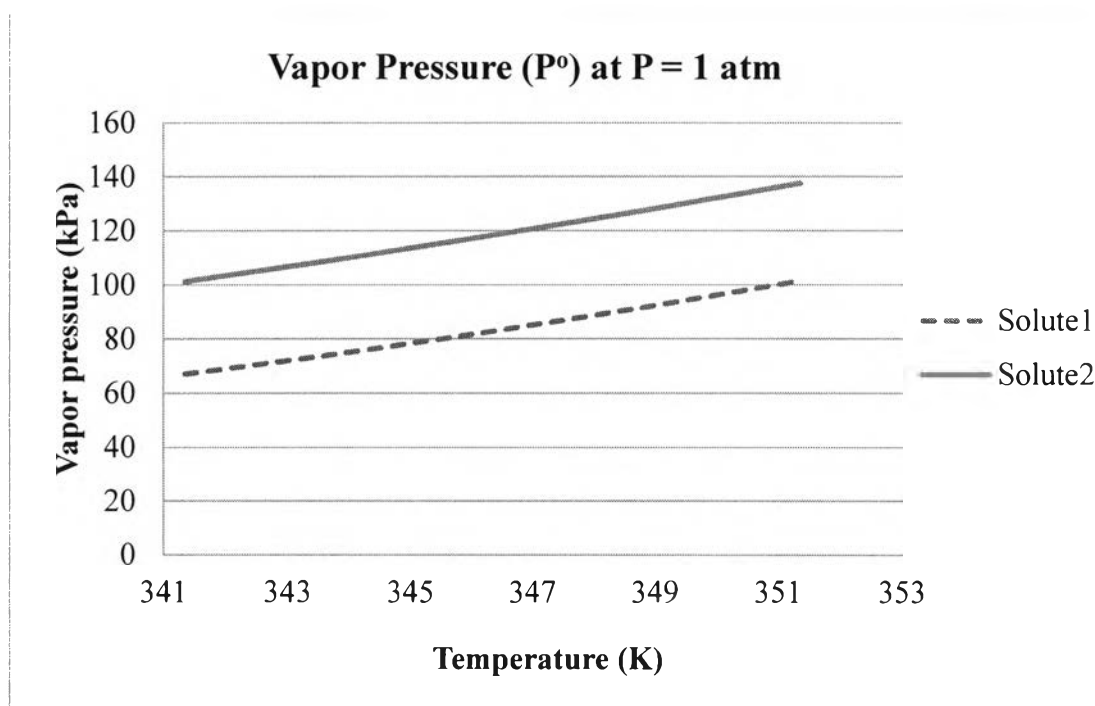

Figure 4.10 Vapor pressure at 1 atm vs Temperature of each solute.

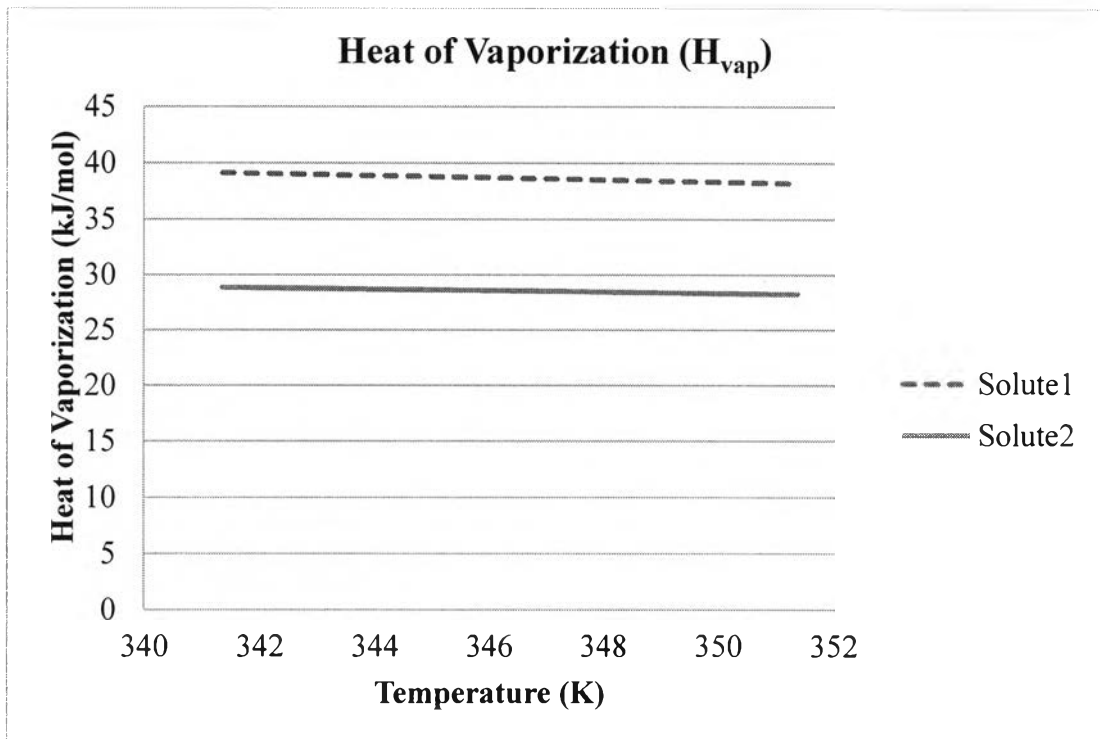

Figure 4.11 Heat of vaporization vs Temperature of each solute.

- Step 2: Verify the mixture behavior and the target solute from vapor-liquid equilibrium (VLE) graph

First of all, NRTL binary parameters of each mixture are collected from literature database (see more the calculation of original NRTL binary parameters in Appendix-E) and then input to ICAS program. From the plot, the types of each mixture from VLE graphs can be classified as azeotropic mixture in Figure 4.12 or close-boiling mixture in Figure 4.13.

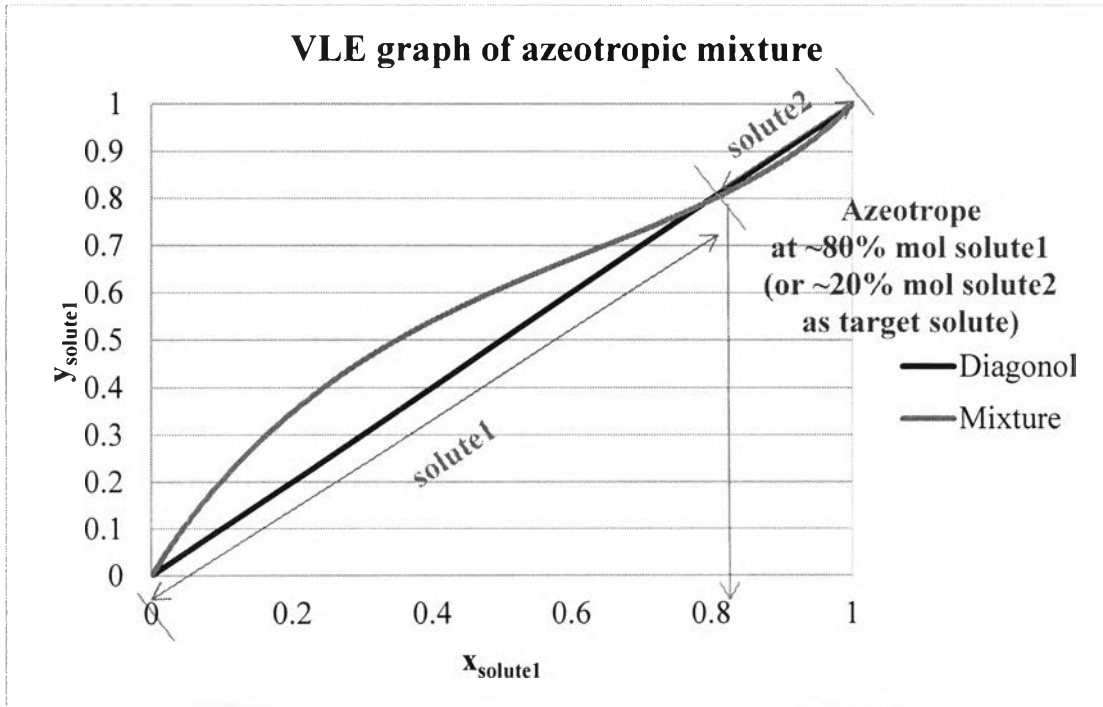

Figure 4.12 VLE graph of azeotropic mixture.

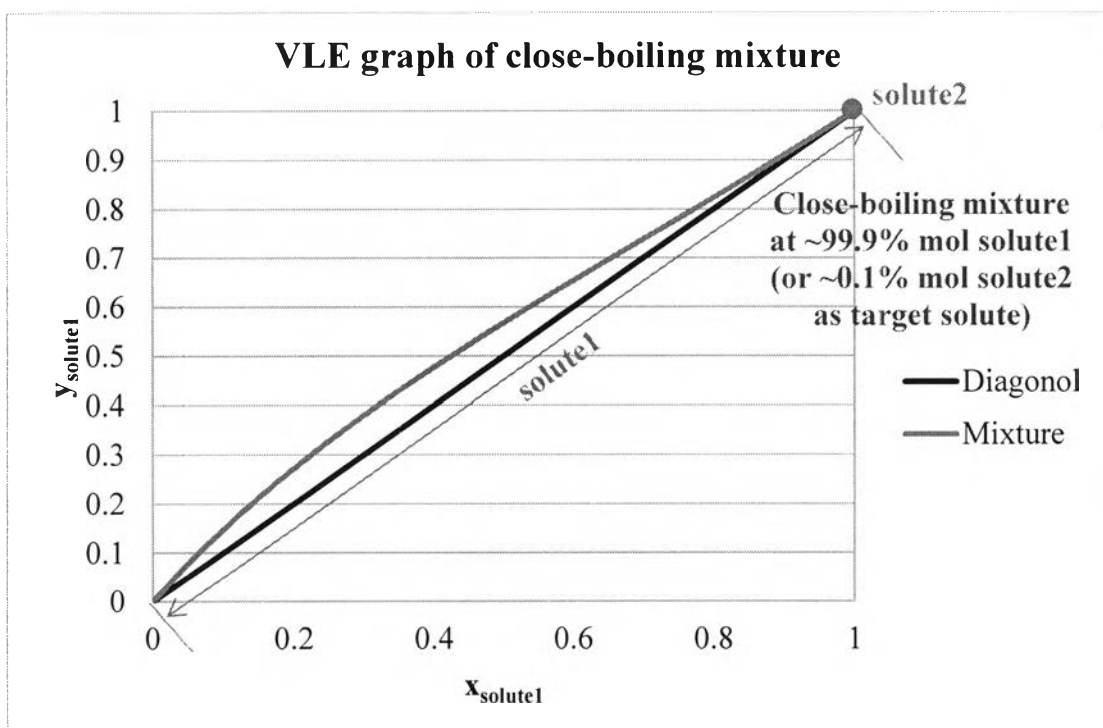

Figure 4.13 VLE graph of close-boiling mixture.

4.1.2.2 Verification of IL

To ensure the efficiency of each feasible IL candidates, the separation capability for breaking azeotrope or increasing the relative volatility is investigated through VLE graphs using ICAS program. Since both NRTL binary parameters and critical properties of ILs are not available in the program so that the experimental data from literatures and the predictive critical properties of ILs proposed by Valderrama (2009) were employed. The detail procedures and necessary equations are given below.

- Step 1: Collect NRTL binary parameters of ILs

Owing to a difference of the collected NRTL binary parameters of experimental data from several literatures, the calculation of original NRTL binary parameters (A_{ij}) are proposed for inputting into ICAS program (see more in appendix B).

- Step 2: Calculate the critical properties of ILs

Not only the critical properties of ILs (e.g. critical pressure (P_C), critical temperature (T_C), critical volume (V_C), normal boiling temperature (T_b), and acentric factor (ω)) are not available in program but also not found in any commercial chemical database or literatures. The critical properties of ILs were calculated by using both the extended GC of the critical property model for ILs in Table 2.8 and the critical property model for ILs proposed by Valderrama (2009) as shown in equations 2.6 to 2.12 in Table 2.9. The precision of model can be expressed as the absolute average deviation (%AAD) and root mean square deviation (RMSD) from the comparison between the calculated liquid densities (ρ_L) of ILs and the experimental data.

- Step 3: Generate VLE graph of ILs

The calculated original NRTL binary parameters and critical properties of each feasible IL candidates were used to plot the VLE graph using ICAS program to ensure the separation capability for breaking the azeotrope or increasing the relative volatility in each mixture. It is noted that if there is no any verified ILs for comparison at this step, user has to go back to stage 1 again to select new feasible IL candidates.

4.1.3 Stage 3: Comparison

In order to obtain the best IL-based separation process, all verified IL candidates from the previous stage must pass through all three comparison steps, namely VLE, simulation, and economic comparison. VLE graphs of all IL candidates were plotted on the same graph to compare the separation capability at the same concentration of ILs. ProII software used to simulate the separation process and calculate the minimum energy requirement and solvent usage to compare between the IL process and the conventional organic solvent process. At the last step, Econsoftware is the proposed tool to calculate a capital cost (CAPEX) and an operating cost (OPEX) of each process for economic comparison. However, the final evaluation will be cautioned to select the new feasible IL candidates in stage 1 over whether any verified ILs could not perform.

4.1.3.1 VLE Comparison

The VLE graphs from verification of IL step will be regenerated to compare against each other at the same concentration of ILs as shown in Figure 4.14. It is anticipated that the IL that gives that highest shift in the VLE plot should perform the best as entrainer. However, the final evaluation of the best IL is considered along with simulation results and economic evaluation.

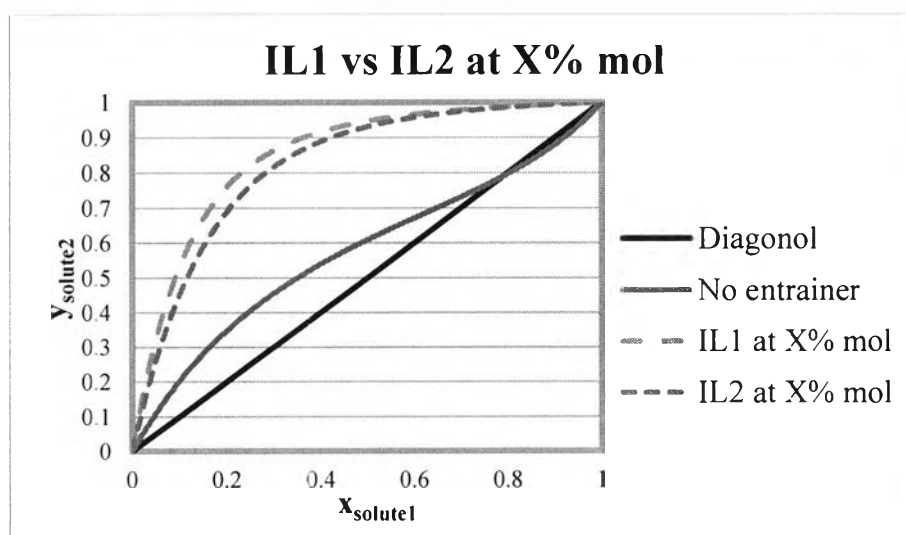

Figure 4.14 Example VLE comparison graph for separation capability of ILs in each mixture.

4.1.3.2 Simulation Comparison

Although, ILs is gradually considered as the new generation compounds as potential entrainers instead of conventional solvents; however, the conventional solvents are still the common entrainers in the extractive distillation nowadays. Hence, the extractive distillation using conventional solvent is simulated as a base case to compare with the conceptual design of IL process in terms of overall energy requirement and solvent usage at the same as target purity (≥ 99.5) of every product. In general, two fractional distillation columns are composed of the extractive distillation column (EDC) and solvent recovery column (SRC). Conversely in IL recovery technology, the simple flash evaporation is employed instead of the fractional distillation column. As a professional program for petroleum and petrochemical fields, PROII is nominated to run the simulation process for this work.

- Step 1: Simulate the separation process of conventional organic solvents (base case)

To start with azeotropic mixture and conventional solvents (CS) from atmospheric condition (1atm, 25°C), their conditions should be adjusted by heat exchanger before performing in EDC. Solute1 presents as the light key product at the top of EDC and solute 2 as the heavy key product is extracted along with CS together at the bottom of EDC. The operating condition in SRC is adjusted to obtain the target purity of solute 2 as by-product and CS for recovering back to EDC again. Throughout, CS make-up at atmospheric condition is fed to calibrate the CS recycle line. The operation of target purity (≥ 99.5) and appropriate condition for sales (1 atm, 30°C) are controlled by pumps and heat exchangers.

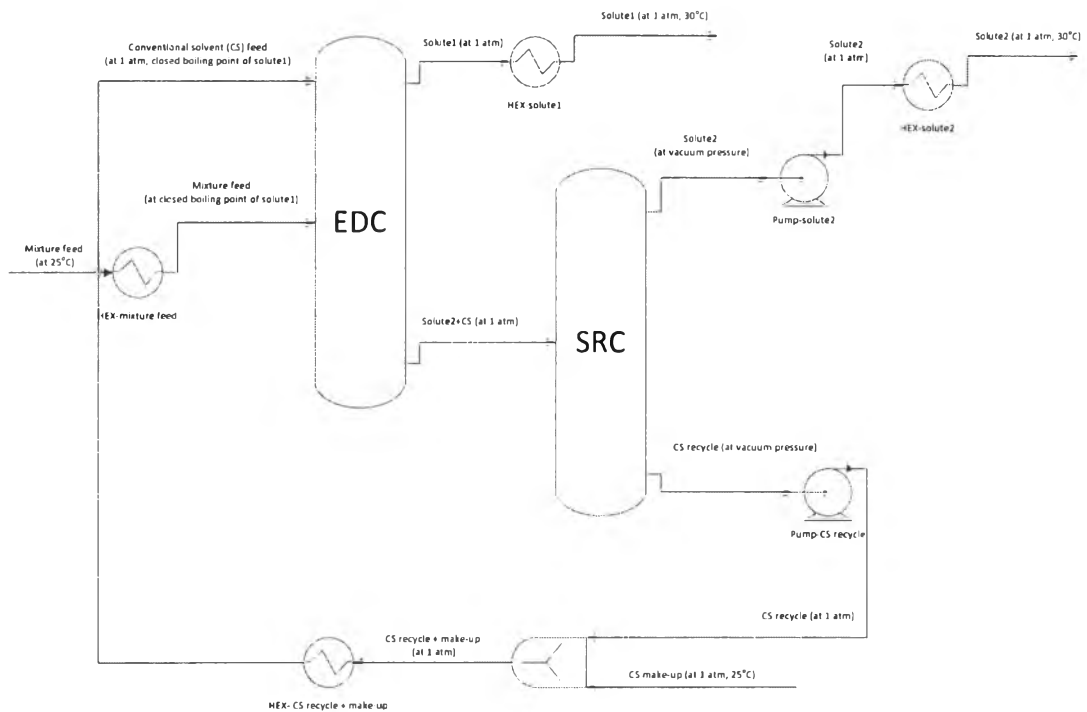

Figure 4.15 Separation process flowsheet of CS process (Base case).

Table 4.2 Fixed parameter and process variable for CS process (Base case)

Fixed parameter		Process variable
Extractive distillation column (EDC)		
EDC operating pressure	Atmospheric pressure (1 atm)	Theoretical stages
		reflux ratio
		Condenser duty
		Reboiler Duty
Mixture feed		Mixture feed
Mixture feed flowrate		Feed location
Mixture feed condition	1 atm, 25°C	

Table 4.2 Fixed parameter and process variable for CS process (Base case)
(Continued)

Fixed parameter		Process variable
Mixture feed		Mixture feed
X_{solute1}		
X_{solute2} (as target solute)		
Target purity of Solute1	≥ 99.5	
Solvent recovery column (SRC)		
SRC operating column	Vacuum pressure	
Target purity of solute 2	≥ 99.5	
Target purity of CS recycle	≥ 99.5	
CS make-up temperature	25°C	CS make-up Flowrate
Outlet temperature of heat exchanger		
HEX-mixture feed	Closed boiling temperature of solute 1	duty
HEX-solute1	30°C	duty
HEX-solute2	30°C	duty
HEX-CS recycle + make-up	temperature as same mixture feed	
Outlet pressure of pump		
Pump-solute2	1 atm	duty
Pump-CS recycle	1 atm	duty

The optimization of the CS process shown in Figure 4.15 of a conventional solvent using fixed parameters in Table 4.2.

- Extractive Distillation Column (EDC)
 - Create the mixture feed;
 - Set composition of feed
 - Set temperature of feed which exists as a liquid phase

- Create the CS feed;
 - Use the CS feed as same as the mixture feed (or 1:1) as first guess
- Find out the number of theoretical stages
 - Set target purity of solute1 product (≥ 99.5) in specification column
 - Use short-cut distillation column for calculating the number of theoretical stages as first guess
- Find out the actual stage
 - Set target purity of solute1 product (≥ 99.5) in column specification
 - Use the calculated theoretical stages from short-cut distillation column as first guess
 - Optimize the number of stages of fractional distillation column which the column exists work
- Find out the actual mixture feed location and solvent feed location
 - Optimize the actual mixture feed and solvent feed location which exist the target purity of solute1 product (≥ 99.5)
 - Consider on the minimum reboiler duty and solvent feed rate
- Adjust the solute 1 product condition for sale
 - Use HEX-solute1 to adjust the outlet temperature at 30°C
- Solvent Recovery column (SRC)
 - Find out the number of theoretical stages
 - Set first guess vacuum pressure
 - Set target purity of solute 2 product (≥ 99.5)
 - Use short-cut distillation column for calculating the number of theoretical stages as first guess

- Find out the actual stage and operating pressure
 - Set target purity of solute2 product (≥ 99.5) and CS recycle (≥ 99.5) in column specification
 - Use the calculated theoretical stages from short-cut distillation column as first guess
 - Optimize the number of stages and the operating pressure of fractional distillation column which the column exists work
- Find out the actual solute2 + CS feed location
 - Optimize the actual solute2 + CS feed location which exist the target purity of solute2 product (≥ 99.5) and CS recycle (≥ 99.5)
 - Consider on the minimum reboiler duty
- Adjust the solute 2 product condition for sale
 - Use pump-solute 2 to adjust the outlet pressure at 1 atm
 - Use HEX-solute 2 to adjust the outlet temperature at 30°C
- Do the close-loop and optimize the overall process again
 - Merge CS recycle with CS make-up for maintaining the feed rate.
 - Connect CS recycle + make-up line to EDC
 - Optimize again based on minimum energy requirement and solvent usage
- Step 2: Simulate the separation process of ILs

IL-based separation process is quite similar to the conventional solvent process but different in the IL recovery technology. Instead of a fractional distillation column in the CS process, the IL process used a simple flash evaporation. Because of high boiling temperature, IL is easy to separate out from solute 2 in a flash evaporator. However, the flash evaporator temperature is limited

not exceed the degradation temperature of IL. All the time, IL is recovering back to EDC by the calibration of IL make-up. The target purity (≥ 99.5) and appropriate condition for sale of every compound are fixed for comparing with the CS process.

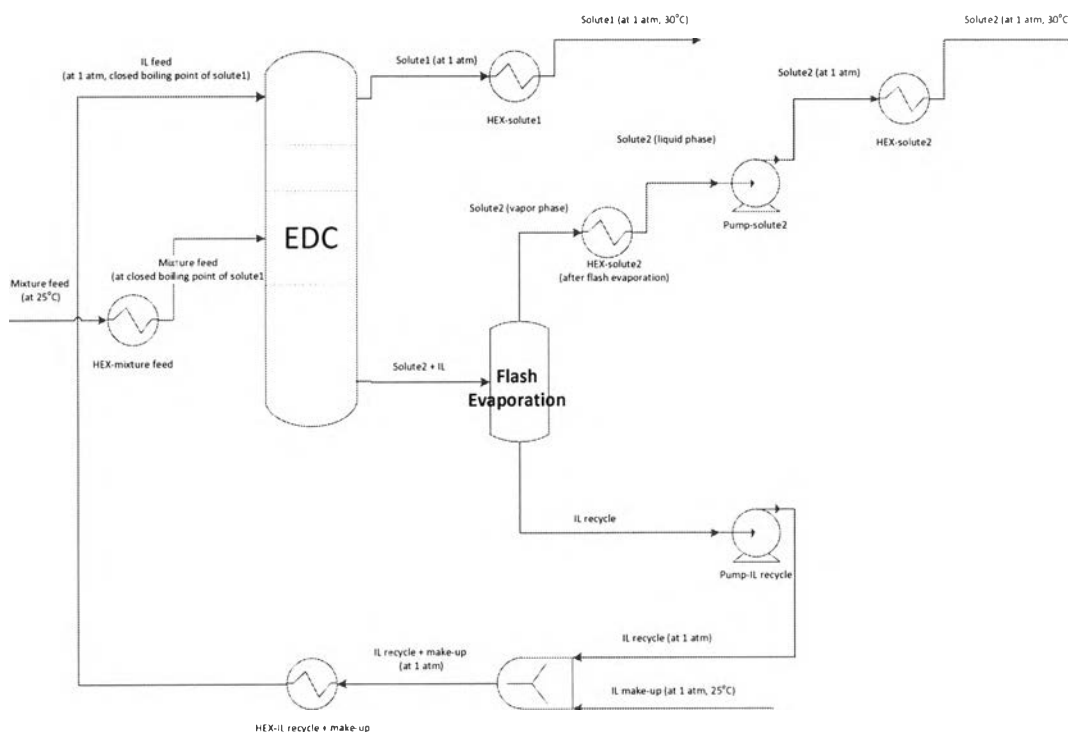

Figure 4.16 Separation process flowsheet of IL process.

Table 4.3 Fixed parameter and process variable for IL process

Fixed parameter		Process variable
Extractive distillation column (EDC)		
Operating pressure	Atmospheric pressure	Reflux ratio
Theoretical stages	Fixed as same as basecase	Condenser duty
		Reboiler duty
Mixture feed		Mixture feed
Mixture feed location	Fixed as same as basecase	

Table 4.3 Fixed parameter and process variable for IL process (Continued)

Fixed parameter		Process variable
Mixture feed		Mixture feed
Mixture feed flowrate		
X_{solute1}		
X_{solute2} (as target solute)		
Mixture feed temperature	1 atm, 25°C	
Target purity of solute 1	≥ 99.5	
Flash evaporation		
Flash operating pressure	Vacuum pressure	
Target purity of solute 2	≥ 99.5	
Target purity of IL recycle	≥ 99.5	
Limited IL temperature	\leq Degradation temperature	
IL make-up temperature	25°C	IL make-up flowrate
Outlet temperature of heat exchanger		
HEX-mixture feed	Closed boiling temperature of solute1	duty
HEX-solute1	30°C	duty
HEX-solute2 (after flash evaporation)	Saturated liquid	duty
HEX-solute2	30°C	duty
HEX- IL recycle + make-up	Temperature as same as mixture feed	
Outlet pressure of pump		
Pump-solute2	1 atm	duty
Pump-IL recycle	1 atm	duty

The optimization of the IL process shown in Figure 4.16 of IL using fixed parameters in Table 4.3.

- Extractive Distillation Column (EDC)
 - Create new components (ILs) and input the thermodynamic parameter
 - Add the additional critical properties and NRTL binary parameters of ILs in the library database
 - Create the mixture feed;
 - Set composition of feed
 - Set temperature of feed which exists as a liquid phase
 - Create the IL feed;
 - Use the IL feed as same as the mixture feed (or 1:1) as first guess
 - Find out the number of theoretical stages
 - Set target purity of solute1 product (≥ 99.5) in column specification
 - Use short-cut distillation column for calculating the number of theoretical stages as first guess
 - Find out the actual stage
 - Set target purity of solute1 product (≥ 99.5) in specification column
 - Use the calculated number of theoretical stages from short-cut distillation column as first guess
 - Optimize the number of stages of fractional distillation column which the column exists work
 - Find out the actual mixture feed location and solvent feed location
 - Optimize the actual mixture feed and solvent feed location which exist the target purity of solute1 product (≥ 99.5)

- Consider on the minimum reboiler duty and solvent feed rate
- Adjust the solute 1 product condition for sale
 - Use HEX-solute1 to adjust the outlet temperature at 30°C
- Flash evaporation
 - Set flash evaporation specification
 - Set the composition recovery or target purity of solute 2 product and IL recycle (≥ 99.5)
 - Optimize flash evaporation condition which has a minimum duty and not over degradation temperature of IL
 - Adjust the solute2 product condition for sale
 - Use HEX-solute2 (after flash evaporation) to adjust phase as saturated liquid.
 - Use Pump-solute2 to adjust the outlet pressure at 1 atm
 - Use HEX-solute2 to adjust the outlet temperature at 30°C
 - Do the close-loop and optimize the overall process again
 - Merge CS recycle with CS make-up for maintaining the feed rate.
 - Connect CS recycle + make-up line to EDC
 - Optimize again based on minimum energy requirement and solvent usage.
- Step 3: Evaluate the best IL-based separation process

In order to get the best IL-based separation process for economic evaluation, among feasible IL candidate processes are compared each other in terms of the energy requirement and solvent usage. Furthermore, the best IL process should be better than the conventional organic solvent process.

4.1.3.2 Economic Comparison

No matter how perfectly of ILs to break azeotrope from the VLE comparison and to decrease energy requirement and solvent usage as compared to the CS process, economic comparison is always an important tool for industry to make a decision whether to invest a project, especially a new and challenging technology. To perform an economic comparison, the fundamental data from simulation were brought to calculate the equipment sizing, utility usage and other related information and then input them into the ECON software to calculate the CAPEX and OPEX of the new IL process as compared to the CS process. Unfortunately, the industrial price of IL is not available and it is an important investment parameter for a comparison with the CS process. In this work, a comparison was made by the net present value (NPV) of the IL and the CS. It was observed that in general the IL process gave a lower equipment cost and utility consumption than the CS process. The unknown in the economic comparison is the cost of IL both the initial load (i.e. as part of the CAPEX) and the IL makeup (i.e. as part of the OPEX). Because of its uniqueness and specialty product, the cost of IL is more expensive than the cost of CS. It is assumed that the cost of IL is constant over the lifetime of the project. The cost ratio of IL is given by $(X_{IL}/X_{CS})_{econ}$, where X_{IL} is the cost of IL and X_{CS} is the cost of CS. In this comparison, it was to seek the cost ratio X_{IL}/X_{CS} that gave $NPV_{IL}=NPV_{CS}$. In other words, the IL process is economically viable when the real industrial X_{IL} gives a lower or equal to $(X_{IL}/X_{CS})_{econ}$. This means that the real industrial cost of IL is interesting for an investment and could be a maximum price for bargain.

- Step 1: Calculate equipment sizing

The necessary parameters for the equipment sizing calculation in Econ software are listed in Table 4.4, taken from equations in Biegler et al. (1999) book, "Systematic Methods of Chemical Process Design".

Table 4.4 Necessary parameter for the equipment sizing calculation

Equipment	
CS process	IL process
<p>Extraction column (T1)</p> <ul style="list-style-type: none"> • Column <ul style="list-style-type: none"> - Diameter - Pressure - Material - Number - Height • Tray <ul style="list-style-type: none"> - Diameter - Material - Number - Spacing • Condenser and Reboiler <ul style="list-style-type: none"> - Type - Material - Duty - LMTD - UA - U - A 	<p>Extraction column (T1)</p> <ul style="list-style-type: none"> • Column <ul style="list-style-type: none"> - Diameter - Pressure - Material - Number - Height • Tray <ul style="list-style-type: none"> - Diameter - Material - Number - Spacing • Condenser and Reboiler <ul style="list-style-type: none"> - Type - Material - Duty - LMTD - UA - U - A

Table 4.4 Necessary parameter for the equipment sizing calculation (Continued).

Equipment	
CS process	IL process
Solvent recovery (T2) <ul style="list-style-type: none"> • Column <ul style="list-style-type: none"> - Diameter - Pressure - Material - Number - Height 	Flash drum (U1) <ul style="list-style-type: none"> • Column <ul style="list-style-type: none"> - Type - Pressure - Diameter - Height
<ul style="list-style-type: none"> • Tray <ul style="list-style-type: none"> - Diameter - Material - Number - Spacing • Condenser and Reboiler <ul style="list-style-type: none"> - Type - Material - Duty - LMTD - UA - U 	
Pump (P1, P2) <ul style="list-style-type: none"> - Type - Material - Pressure - Flowrate - Capacity 	Pump (P1, P2) <ul style="list-style-type: none"> - Type - Material - Pressure - Flowrate - Capacity

Table 4.4 Necessary parameter for the equipment sizing calculation (Continued)

Equipment	
CS process	IL process
Mixer (M1) - Material - Capacity	Mixer (M1) - Material - Capacity
Heat exchanger (E1, E2, E3, E4) - Type - Material - Duty - LMTD - UA - U	Heat exchanger (E1, E2, E3, E4, E5) - Type - Material - Duty - LMTD - UA - U

- Step 2: Calculate CAPEX and OPEX

In ECON software, purchase equipment and utility costs can be obtained after adding the information of individual equipment from ProII. The factor of each item can be adjusted or use the default values as shown in Appendix H. However, raw material and solvent costs are not included in CAPEX and OPEX calculation.

- Step 3: Calculate the cost ratio of IL by CS, $(X_{IL}/X_{CS})_{econ}$

To be economically viable, the CAPEX and OPEX of IL process from step 2 must be less than the CS process as shown in Equation 4.1 and Equation 4.2, respectively. Nevertheless, the calculation of CAPEX and OPEX is without the raw material and solvent costs, especially IL cost. To take into account the IL cost, a reasonable assumption has been made: the economic cost ratio of IL by CS $(X_{IL}/X_{CS})_{econ}$ in Equation 4.3 is constant at all lifetime. A net present value was used as an economic tool to compare the IL and CS processes. The NPV of the IL process in Equation 4.4 and CS process in Equation 4.5 were set to be equal as shown in Equation 4.6 or Equation 4.7. Since the same flowrate and concentration of

raw material (azeotropic or close boiling point mixture) and refined product are the same for both IL and CS processes, the cost of raw materials and revenue of both processes can be omitted. The cash flow diagrams of the IL process and CS process are illustrated in Figure 4.17 and Figure 4.18, respectively. Since a lifetime of the project was assumed to be 15 years and a minimum acceptable rate of return (MARR) was set at 15%, the conversion factor in Equation 4.8 can be calculated. Equation 4.13 and 4.6 were then solved to obtain the $(X_{IL}/X_{CS})_{econ}$ that satisfied the $NPV_{IL} = NPV_{CS}$.

$$\text{Comparison 1: } CAPEX_{IL} \leq CAPEX_{CS} \quad (4.1)$$

$$\text{Comparison 2: } OPEX_{IL} \leq OPEX_{CS} \quad (4.2)$$

$$\text{Assumption: } x_{IL}/x_{CS} = \text{constant} = \text{economic cost ratio of IL by CS} \quad (4.3)$$

$$NPV_{IL} = -[CAPEX_{IL} + Q_{IL}x_{IL}] - [(OPEX_{IL} + q_{IL}x_{IL} + \text{Raw materials} - \text{Revenue})(P/A, i, n)] \quad (4.4)$$

$$NPV_{CS} = -[CAPEX_{CS} + Q_{CS}x_{CS}] - [(OPEX_{CS} + q_{CS}x_{CS} + \text{Raw materials} - \text{Revenue})(P/A, i, n)] \quad (4.5)$$

$$NPV_{IL} = NPV_{CS} \text{ or } NPV_{IL} - NPV_{CS} = 0 \quad (4.6)$$

$$[(CAPEX_{IL} - CAPEX_{CS}) + (Q_{IL}x_{IL} - Q_{CS}x_{CS})] + [(OPEX_{IL} - OPEX_{CS})(P/A, i, n) + (q_{IL}x_{IL} - q_{CS}x_{CS})(P/A, i, n)] = 0 \quad (4.7)$$

$$P = A(P/A, i, n) \Rightarrow P = A \left(\frac{(1+i)^n - 1}{i(1+i)^n} \right) \Rightarrow (P/A, i, n) = \left(\frac{(1+i)^n - 1}{i(1+i)^n} \right) \quad (4.8)$$

where,

$CAPEX_{IL}$	is the capital cost of IL process
$CAPEX_{CS}$	is the capital cost of CS process
$OPEX_{IL}$	is the operating cost of IL process
$OPEX_{CS}$	is the operating cost of CS process
NPV_{IL}	is the net present value of IL process
NPV_{CS}	is the net present value of CS process
Q_{IL}	is the initial load of IL
Q_{CS}	is the initial load of CS
q_{IL}	is the quantity of IL make-up
q_{CS}	is the quantity of CS make-up

x_{IL}	is the cost of IL
x_{CS}	is the cost of CS
P	is the present value
A	is the annual value
i	is the interest rate return
n	is the lifetime of project

It is noted that if there is no the best IL after the final evaluation, user has to go back to stage 1 again to select new feasible IL candidates.

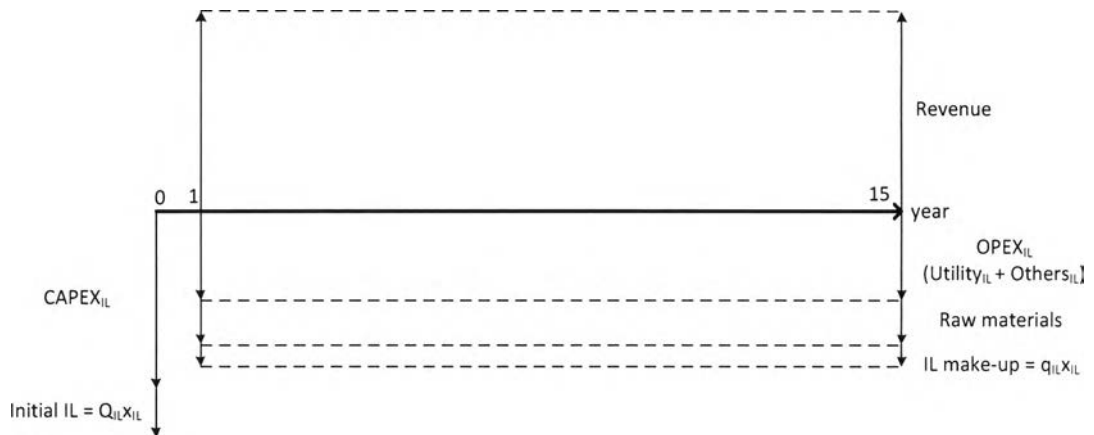

Figure 4.17 Cash flow diagram of IL process.

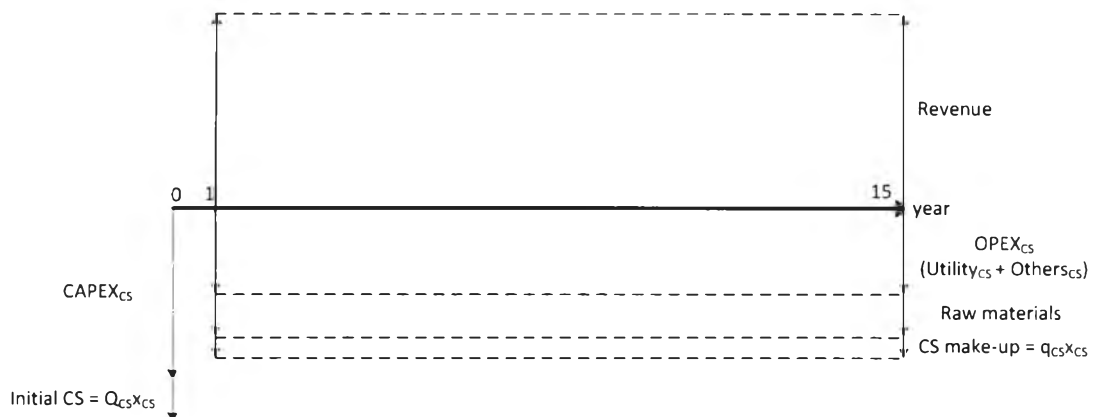

Figure 4.18 Cash flow diagram of CS process.

4.2 Case Studies

The proposed methodology was demonstrated through five case studies: ethanol + water, ethanol + hexane, benzene + hexane, toluene + MCH, and EB + PX mixtures to ensure the viability of the proposed technique.

4.2.1 Stage 1: Selection

4.2.1.1 *Mixture selection*

Several problem mixtures in Table A1 were classified by the number of components, phase and type of solution. Nevertheless, only five problem mixtures were selected to be case studies based on the possibility to demonstrate further and widely used in industry. Although all mixtures are binary homogeneous system, they are categorized differently by type of solution and functional groups, for instance, water + ethanol mixture as a representative of water + alcohol system in aqueous system, ethanol + hexane mixture as a representative of alcohol + aliphatic hydrocarbons system in non-aqueous system, benzene + hexane as a representative of aromatic + aliphatic hydrocarbons system in non-aqueous system, toluene + methylcyclohexane (MCH) as a representative of aromatic + cyclic hydrocarbons system in non-aqueous system and ethylbenzene (EB) + P-xylene (PX) as a representative of aromatic + aromatic system in non-aqueous system. A total of five case studies were covered for all generic systems mostly found in azeotropic mixture separation and should be viable to prove how efficient of the proposed methodology along with the limitations and exception in each system.

The outstanding azeotropic mixture from ethanol production, which has been widely studied and published, is the ethanol + water system and certainly the best candidate for the aqueous system. Two common processes, hydration of ethylene and fermentation of sugars, are involved with ethanol productions and always found problems in their purification due to the strong attraction between ethanol and water. Hydration of ethylene is used in the industrial ethanol production, while fermentation of sugars is manufactured in most alcoholic

beverage industry. Furthermore, ethanol is becoming gradually as an octane booster in gasoline which effects on global energy demand. Nowadays, the common entrainer for extractive distillation is ethylene glycol (EG) (Hernández, 2013). The experimental data of the separation of ethanol + water mixture by ILs have been already studied and continuously reported in literature (Pereiro *et al.*, 2012).

For non-aqueous systems, a diversity of functional groups is remarkable and challenging for demonstrating in this proposed methodology. Four non-aqueous mixtures are selected to cover all generic systems. Ethanol + hexane mixture as a case study in alcohol + aliphatic HC system is the most interesting in the oxygenated additives production for gasoline since ethanol has led to be the replacement of lead in gasoline but the difficulties in separation of either hexane or heptane with methanol or ethanol azeotropes have still been researched and sulfolane has been used as a typical solvent in the extractive distillation (Pucci, 1989).

In petroleum refinery, the reformat gasoline distilled from crude should be qualified by separating aromatic and aliphatic hydrocarbons from each other because reformat gasoline has high aromatic contents approximately 90%wt, which are able to proceed as raw materials for widespread petrochemical processes (Pereiro *et al.*, 2012). The separation of benzene + hexane mixture using NMP as a conventional solvent is practically employed in industry (Pereiro *et al.*, 2012).

The research group of González *et al.* (2010) has studied ILs used in toluene + methylcyclohexane (MCH) mixture for the aromatics + cyclic hydrocarbons systems (Martínez-Reina, 2012). Because of the low relative volatility of mixture, it is classified as close-boiling mixture rather than azeotrope. Around a billion tons of toluene around the world is consumed in the manufactures of plastics, synthetic rubber and fiber.

The last case study represented the system of close-boiling mixture. Ethylbenzene (EB) + p-xylene (PX) mixture was chosen as a case study in aromatic + aromatic system. To upgrade by-products and enhance a high quality value of various products from naphtha cracking unit, the separation and purification of several kinds of aromatics are concerned. A study of a separation of EB + PX

mixture was performed by Lek-utaiwan *et al.* (2008) using the suitable conventional solvents. A total of five case studies are summarized and referenced in Table 4.5.

4.2.1.2 Separation Process Selection

All selected mixtures were employed in IL-based ED.

4.2.1.3 IL Pre-Selection

The chemical data and the activity coefficient at infinite dilution at 298 K of 90 different ILs from 65 literatures are given in Tables 4.6 and 4.7, respectively. In addition, the calculated Hildebrand solubility parameter, capacity and selectivity of ILs are summarized in Table 4.8.

Next, the calculated property parameters from Table 4.8 of each mixture (Step1), namely selectivity and capacity were plotted against Hildebrand solubility parameter as shown in Figure B1- B30. Two groups of feasible target solutes in three types of screening graphs for five case studies showed a dispersion of IL candidates, consequently, the selected target solutes along with the number of figures or graphs are shown in Table B4; water in ethanol + water mixture, ethanol in ethanol + hexane mixture, benzene in benzene + hexane mixture, toluene in toluene + MCH mixture and EB in EB + PX mixtures. It is noted that both EB and PX could be the target solute owing to the similarity of isomer properties.

After that, the minimum and maximum of the Hildebrand solubility parameter, capacity (C_2^∞) and selectivity (S_{12}^∞) of ILs listed in Table 4.9 were determined firstly on the default range which most researchers considered from several literatures, i.e. $\pm 5 \text{ MPa}^{1/2}$ from the Hildebrand solubility parameter of selected target solute, 0.5 to 1.5 of capacity (C_2^∞), and 5 to 15 of selectivity (S_{12}^∞). However, the target ranges of these three parameters could be adjusted with a reasonable flexibility especially when non IL or too little number of ILs was in the default range. For instance, ethanol + water range was fitted with all default range and toluene + MCH and EB + PX were along with the default range of capacity (C_2^∞) and selectivity (S_{12}^∞) but wider range of the Hildebrand solubility parameter between 18 to 28 $\text{MPa}^{1/2}$ and 18 to 30 $\text{MPa}^{1/2}$, respectively, because of the nature polar of ILs as highly hydrophilic. For benzene + hexane range, it had a minor change from the widespread ILs in its graphs which set 18 to 28 $\text{MPa}^{1/2}$ of the Hildebrand solubility

parameter, 0.3 to 2.1 of capacity (C_2^∞), and 6 to 42 of selectivity (S_{12}^∞). A complexity of aqueous system was affected on the default range as follows: 23 to 50 MPa^{1/2} of the Hildebrand solubility parameter, 2 to 12 of capacity (C_2^∞), and 1 to 6 of selectivity (S_{12}^∞); accordingly, water originally forms hydrogen bond and high strong attracts with ethanol.

Finally, the number and abbreviation of feasible IL candidates for all case studies are listed in Table 4.10. Figures 4.18 to 4.22 show the plot of capacity (C_2^∞) and selectivity (S_{12}^∞) against the Hildebrand solubility parameter of water + ethanol, ethanol + hexane, benzene + hexane, toluene + MCH, and EB + PX mixtures, respectively. The target window of each parameter (i.e. Hildebrand solubility parameter, capacity (C_2^∞), and selectivity (S_{12}^∞) of ILs) is highlighted in each plot which all feasible IL candidates passed the screening criteria must appear in the target window.

Table 4.5 List of the selected five problem mixtures or case studies

No.	Solution system	Homogeneous Binary mixture	Azeotrope (%wt. comp)	Conventional solvent	Application	Reference
Aqueous system						
1	Water + Alcohol	Water + Ethanol	89.7% ethanol	Ethylene glycol (EG)	Hydration of ethylene and Fermentation of sugars	Pereiro <i>et al.</i> (2012)
Non-aqueous system						
2	Alcohol + Aliphatic HC	Ethanol + Hexane	79% hexane	Sulfolane	Oxygenated additive processes	Pucci (1989)
3	Aromatic + Aliphatic HC	Benzene + Hexane	91% hexane	NMP	Purification of middle distillate and Steam reforming	Pereiro <i>et al.</i> (2012)
4	Aromatic + Cyclic HC	Toluene + MCH	Close-boiling mixture	NMP	Manufacture of plastics and Synthesis fiber and Rubber	Hernández (2013)
5	Aromatic + Aromatic	Ethylbenzene + P-xylene	Close-boiling mixture	Acyclic-Ester group	Naphtha cracking unit	Lek-utaiwan <i>et al.</i> (2008)

Table 4.6 List of 90 different ILs in this work

No.	Abbreviation	Full name	Chemical Structure	Reference
1	BMIM-BF ₄	1-Butyl-3-methylimidazolium-Tetrafluoroborate		Bahlmann <i>et al.</i> (2009)
2	HMIM-BF ₄	1-Hexyl-3-methylimidazolium-Tetrafluoroborate		Bahlmann <i>et al.</i> (2009)
3	3C6C14P-Cl	Trihexyltetradecylphosphonium-Chloride		Banerjee <i>et al.</i> (2006)

Table 4.6 List of 90 different ILs in this work (Continued)

No.	Abbreviation	Full name	Chemical Structure	Reference
4	3C6C14P-BF ₄	Trihexyltetradecylphosphonium-Tetrafluoroborate	$\begin{array}{c} (\text{CH}_2)_5\text{CH}_3 \\ \\ \text{H}_3\text{C}(\text{H}_2\text{C})_5-\text{P}^+-\text{(CH}_2\text{)}_{13}\text{CH}_3 \\ \\ (\text{CH}_2)_5\text{CH}_3 \end{array} \quad \text{BF}_4^-$	Banerjee <i>et al.</i> (2006)
5	3C6C14P-BTI	Trihexyltetradecylphosphonium-Bis(trifluoromethylsulfonyl)imide	$\begin{array}{c} (\text{CH}_2)_5\text{CH}_3 \\ \\ \text{H}_3\text{C}(\text{H}_2\text{C})_5-\text{P}^+-\text{(CH}_2\text{)}_{13}\text{CH}_3 \\ \\ (\text{CH}_2)_5\text{CH}_3 \\ \text{F}_3\text{CO}_2\text{S}^-\text{N}^-\text{SO}_2\text{CF}_3 \end{array}$	Banerjee <i>et al.</i> (2006)
6	OMIM-Cl	1-Octyl-3-Methylimidazolium-Chloride		David <i>et al.</i> (2003)
7	EMIM-BTI	1-Ethyl-3-Methylimidazolium-Bis(trifluoromethylsulfonyl)imide		Deenadayalu <i>et al.</i> (2005)

Table 4.6 List of 90 different ILs in this work (Continued)

No.	Abbreviation	Full name	Chemical Structure	Reference
8	OMIM-MDEGSO4	1-Octyl-3-Methylimidazolium-2-(2-methoxyethoxy)ethylsulfate		Deenadayalu <i>et al.</i> (2006b)
9	BMPY-BF4	1-Butyl-3-Methylpyridinium-Tetrafluoroborate		Diedenhofen <i>et al.</i> (2003)
10	EM2IM-BTI	1,2-Dimethyl-3-Ethylimidazolium Bis((trifluoromethyl)sulfonyl)imide		Diedenhofen <i>et al.</i> (2003)
11	EMIM-BTI	1-Ethyl-3-Methylimidazolium-Bis(trifluoromethylsulfonyl)imide		Diedenhofen <i>et al.</i> (2003)

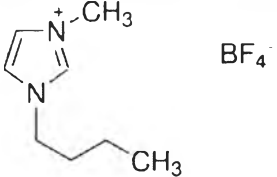
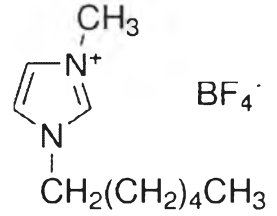
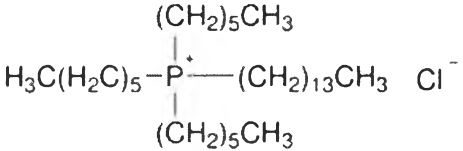
Table 4.6 List of 90 different ILs in this work (Continued)

No.	Abbreviation	Full name	Chemical Structure	Reference
12	EMIM-TFA	1-Ethyl-3-Methylimidazolium- Trifluoroacetate		Domanska <i>et al.</i> (2007)
13	EMIM-SCN	1-Ethyl-3-Methylimidazolium- Thiocyanate		Domanska <i>et al.</i> (2008a)
14	BMIM-CF3SO3	1-Butyl-3-Methylimidazolium- Trifluoromethanesulfonate		Domanska <i>et al.</i> (2008b)
15	C6H13OCH2MIM- BTI	1-hexyloxymethyl-3-Methyl imidazolium bis(trifluoro- methylsulfonyl)imide		Domanska <i>et al.</i> (2009a)

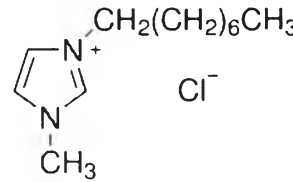
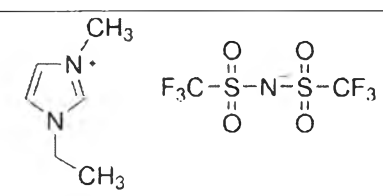
Table 4.6 List of 90 different ILs in this work (Continued)

No.	Abbreviation	Full name	Chemical Structure	Reference
16	(C ₆ H ₁₃ OCH ₂) ₂ IM-BTI	1,3-Dihexyloxymethylimidazolium Bis(trifluoromethylsulfonyl)imide		Domańska <i>et al.</i> (2009a)
17	EMPYR-CF ₃ SO ₃	1-Ethyl-3-Methylpyrrolidinium- Trifluoromethanesulfonate		Domańska <i>et al.</i> (2009b)
18	E3S-BTI	Triethylsulphonium Bis(trifluoromethylsulfonyl)imide		Domańska <i>et al.</i> (2009c)
19	BMPY-BTI	4-methyl-N-Butyl-Pyridinium Bis(trifluoromethylsulfonyl)imide		Domańska <i>et al.</i> (2009d)

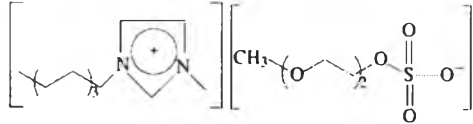
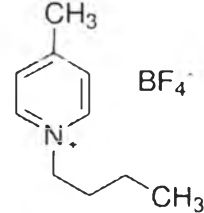
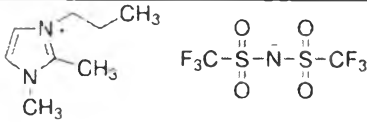
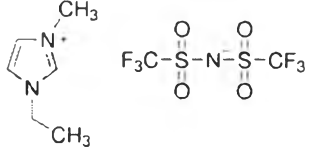
Table 4.6 List of 90 different ILs in this work (Continued)

No.	Abbreviation	Full name	Chemical Structure	Reference
20	BMIM-SCN	1-Butyl-3-Methylimidazolium-Thiocyanate		Domańska <i>et al.</i> (2009e)
21	MMIM-MDEGSO4	1-Methyl-3-Methylimidazolium-2-(2-methoxyethoxy)ethylsulfate		Domańska <i>et al.</i> (2009e)
22	MMIM-MeSO4	1-Methyl-3-Methylimidazolium-Methylsulfate		Domańska <i>et al.</i> (2009e)
23	BMIM-OcSO4	1-Butyl-3-Methylimidazolium-Octylsulfate		Domańska <i>et al.</i> (2009e)
24	DMIM-TCB	1-Decyl-3-Methylimidazolium-Tetracyanoborate		Domanska <i>et al.</i> (2010a)

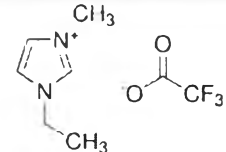
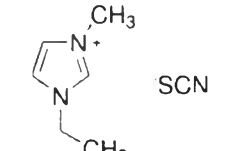
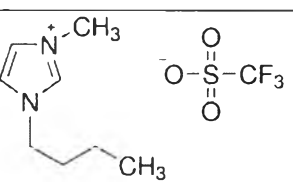
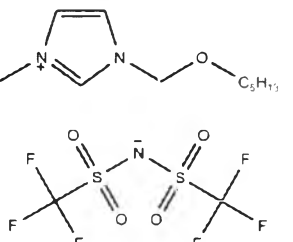
Table 4.6 List of 90 different ILs in this work (Continued)

No.	Abbreviation	Full name	Chemical Structure	Reference
25	HMIM-SCN	1-Hexyl-3-Methylimidazolium- Thiocyanate		Domańska <i>et al.</i> (2010b)
26	PMPiP-BTi	1-Propyl-1-Methylpiperidinium Bis((trifluoromethyl)sulfonyl)imide		Domańska <i>et al.</i> (2010c)
27	P1444-TOS	Tri-iso-butyl-Methylphosphonium Tosylate		Domańska <i>et al.</i> (2010d)
28	BMPY-SCN	1-Butyl-3-Methylpyridinium- Thiocyanate		Domańska <i>et al.</i> (2010e)
29	BMPYR-SCN	1-Butyl-1-Methylpyrrolidinium- Thiocyanate		Domańska <i>et al.</i> (2010e)

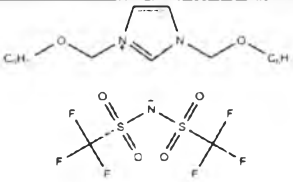
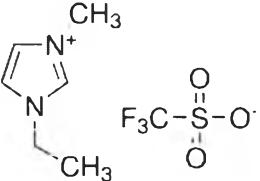
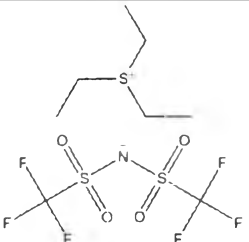
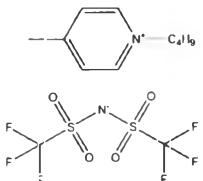
Table 4.6 List of 90 different ILs in this work (Continued)

No.	Abbreviation	Full name	Chemical Structure	Reference
30	BMIM-TOS	1-Butyl-3-Methylimidazolium- Tosylate		Domańska <i>et al.</i> (2010f)
31	BMPYR-TCB	1-Butyl-1-Methylpyrrolidinium- Tetracyanoborate		Domańska <i>et al.</i> (2011a)
32	EMIM-TCB	1-Ethyl-3-Methylimidazolium- Tetracyanoborate		Domańska <i>et al.</i> (2011b)
33	BMPYR-FAP	1-Butyl-1-Methylpyrrolidinium- Trifluorotris(pentafluoroethyl)phosphate		Domańska <i>et al.</i> (2012a)

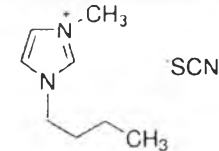
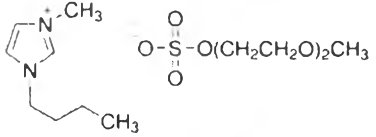
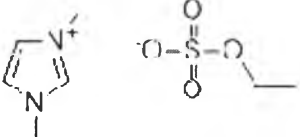
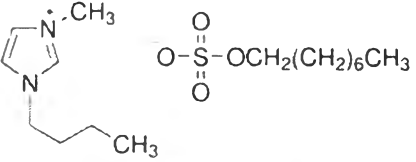
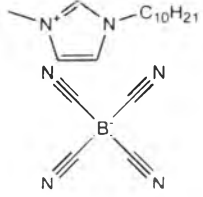
Table 4.6 List of 90 different ILs in this work (Continued)

No.	Abbreviation	Full name	Chemical Structure	Reference
34	HMIM-TCB	1-Hexyl-3-Methylimidazolium Tetracyanoborate		Domańska <i>et al.</i> (2012b)
35	EMIM-BF4	1-Ethyl-3-Methylimidazolium- Tetrafluoroborate		Foco <i>et al.</i> (2006)
36	BMIM-BF4	1-Butyl-3-Methylimidazolium- Tetrafluoroborate		Foco <i>et al.</i> (2006)
37	HMIM-BF4	1-Hexyl-3-Methylimidazolium- Tetrafluoroborate		Foco <i>et al.</i> (2006)

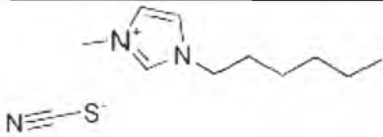
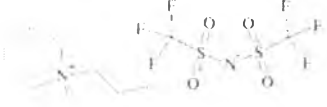
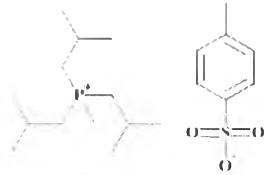
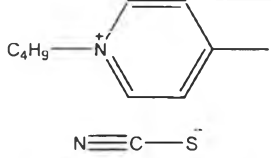
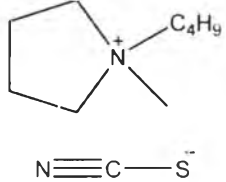
Table 4.6 List of 90 different ILs in this work (Continued)

No.	Abbreviation	Full name	Chemical Structure	Reference
38	OMIM-BF ₄	1-Octyl-3-Methylimidazolium-Tetrafluoroborate		Foco <i>et al.</i> (2006)
39	OMA-BTI	Trioctyl-Methylammonium Bis(trifluoromethylsulfonyl)imide		Gwala <i>et al.</i> (2010)
40	BMPY-BF ₄	1-Butyl-3-Methylpyridinium-Tetrafluoroborate		Heintz <i>et al.</i> (2001)
41	EMIM-BTI	1-Ethyl-3-Methylimidazolium-Bis(trifluoromethylsulfonyl)imide		Heintz <i>et al.</i> (2002)

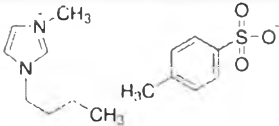
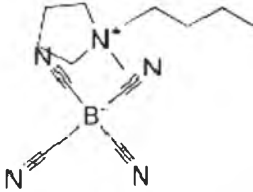
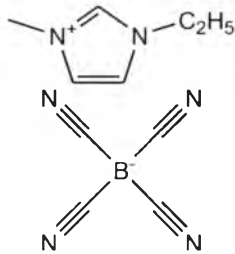
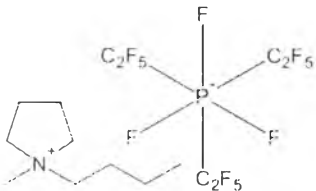
Table 4.6 List of 90 different ILs in this work (Continued)

No.	Abbreviation	Full name	Chemical Structure	Reference
42	EM2IM-BTI	1,2-Dimethyl-3-Ethylimidazolium-Bis(trifluoromethylsulfonyl)imide	 <p>($\text{C}_9\text{H}_{16}\text{S}_2\text{O}_4\text{F}_6\text{N}_3$)</p>	Heintz <i>et al.</i> (2002)
43	BMIM-BTI	1-Butyl-3-Methylimidazolium-Bis(trifluoromethylsulfonyl)imide		Heintz <i>et al.</i> (2005a)
44	OMIM-BF4	1-Octyl-3-Methylimidazolium-Tetrafluoroborate		Heintz <i>et al.</i> (2005b)
45	HMIM-BTI	1-Hexyl-3-Methylimidazolium-Bis(trifluoromethylsulfonyl)imide		Heintz <i>et al.</i> (2006a)
46	BM3A-BTI	Trimethyl-Butylammonium Bis(trifluoromethylsulfonyl) Imide		Heintz <i>et al.</i> (2006b)

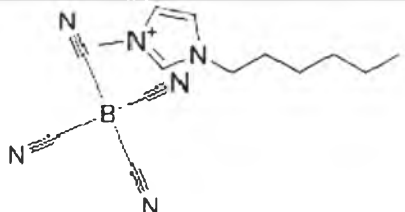
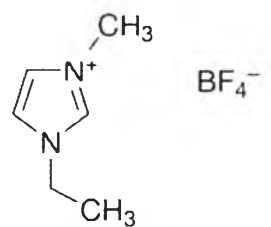
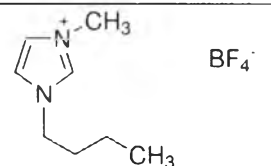
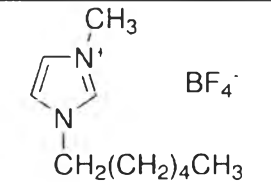
Table 4.6 List of 90 different ILs in this work (Continued)

No.	Abbreviation	Full name	Chemical Structure	Reference
47	BMIM-BF ₄	1-Butyl-3-Methylimidazolium-Tetrafluoroborate		Zhang <i>et al.</i> (2007b)
48	OMIM-BF ₄	1-Octyl-3-Methylimidazolium-Tetrafluoroborate		Zhang <i>et al.</i> (2007b)
49	HMIM-NO ₃	1-Hexyl-3-Methylimidazolium-Nitrate		Kan <i>et al.</i> (2012)
50	HMIM-BTI	1-Hexyl-3-Methylimidazolium-Bis(trifluoromethylsulfonyl)imide		Kato <i>et al.</i> (2005)
51	OMIM-BTI	1-Octyl-3-Methylimidazolium-Bis(trifluoromethylsulfonyl)imide		Kato <i>et al.</i> (2005)

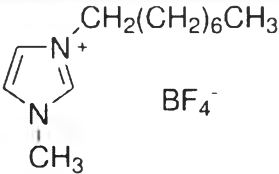
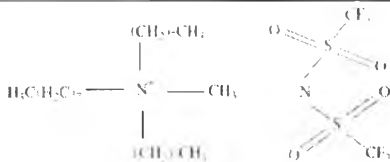
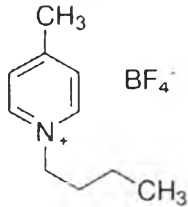
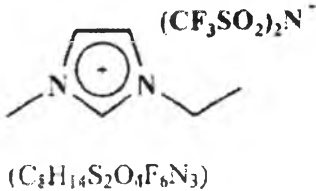
Table 4.6 List of 90 different ILs in this work (Continued)

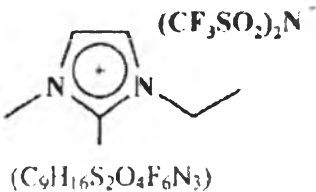
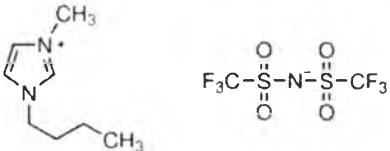
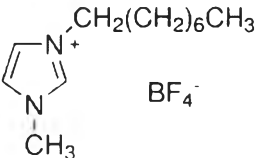
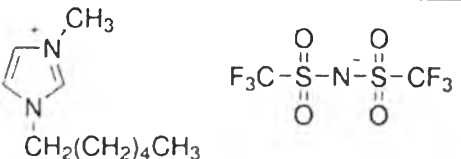
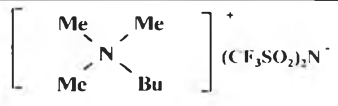

No.	Abbreviation	Full name	Chemical Structure	Reference
52	BMPYR-BTI	1-Butyl-1-Methylpyrrolidinium-Bis(trifluoromethylsulfonyl)imide		Kato <i>et al.</i> (2005)
53	MMIM-BTI	1-Methyl-3-Methylimidazolium-Bis(trifluoromethylsulfonyl)imide		Krummen <i>et al.</i> (2002)
54	EMIM-BTI	1-Ethyl-3-Methylimidazolium-Bis(trifluoromethylsulfonyl)imide		Krummen <i>et al.</i> (2002)
55	BMIM-BTI	1-Butyl-3-Methylimidazolium-Bis(trifluoromethylsulfonyl)imide		Krummen <i>et al.</i> (2002)
56	EMIM-EtSO4	1-Ethyl-3-Methylimidazolium-Ethylsulfate		Krummen <i>et al.</i> (2002)

Table 4.6 List of 90 different ILs in this work (Continued)

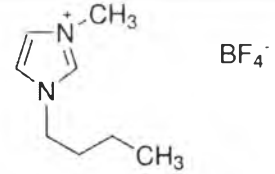
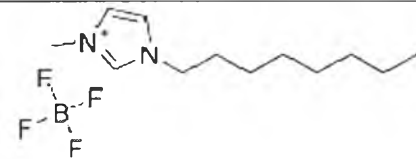
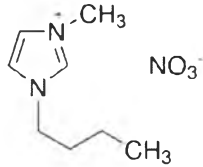
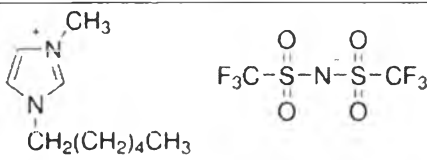
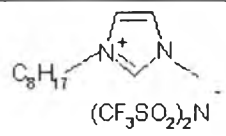
No.	Abbreviation	Full name	Chemical Structure	Reference
57	HMIM-BF ₄	1-Hexyl-3-Methylimidazolium-Tetrafluoroborate		Letcher <i>et al.</i> (2003a)
58	BMPY-BF ₄	1-Butyl-3-Methylpyridinium-Tetrafluoroborate		Letcher <i>et al.</i> (2003a)
59	EMMIM-BTI	1,2-Dimethyl-Ethylimidazolium-Bis(trifluoromethylsulfonyl)imide		Letcher <i>et al.</i> (2003a)
60	HMIM-PF ₆	1-Hexyl-3-Methylimidazolium-Hexafluorophosphate		Letcher <i>et al.</i> (2003b)
61	HMIM-BTI	1-Hexyl-3-Methylimidazolium-Bis(trifluoromethylsulfonyl)imide		Letcher <i>et al.</i> (2005a)

Table 4.6 List of 90 different ILs in this work (Continued)

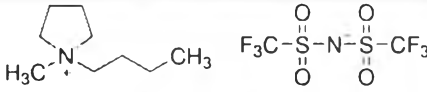
No.	Abbreviation	Full name	Chemical Structure	Reference
67	BMPY-TOS	1-Butyl-4-Methylpyridinium- Tosylate		Letcher <i>et al.</i> (2009)
68	PDMIM-BF4	1-Propyl-2,3-Dimethylimidazolium Tetrafluoroborate		Wang <i>et al.</i> (2007)
69	BMIM-CF3SO3	1-Butyl-3-Methylimidazolium-Trifluoromethanesulfonate		Ge <i>et al.</i> (2007)
70	EMIM-BF4	1-Ethyl-3-Methylimidazolium-Tetrafluoroborate		Ge <i>et al.</i> (2008)
71	BMIM-PF6	1-Butyl-3-Methylimidazolium-Hexafluorophosphate		Mutelet <i>et al.</i> (2005)

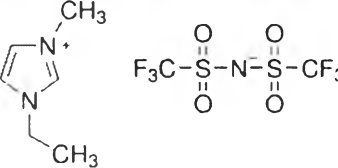
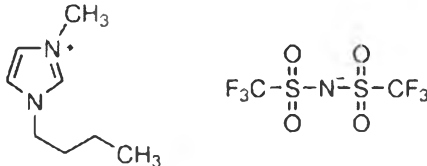
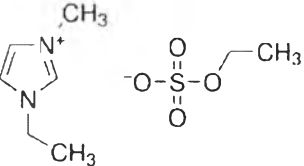
Table 4.6 List of 90 different ILs in this work (Continued)

No.	Abbreviation	Full name	Chemical Structure	Reference
72	BMIM-OcSO4	1-Butyl-3-Methylimidazolium- Octylsulfate		Mutelet <i>et al.</i> (2006)
73	C16MIM-BF4	1-Hexadecyl-3-Methylimidazolium Tetrafluoroborate		Mutelet <i>et al.</i> (2007)
74	EMIM-DCA	1-Ethyl-3-Methylimidazolium- Dicyanamide		Mutelet <i>et al.</i> (2009)
75	TMHA-BTI	Trimethylhexylammonium Bis(trifluoromethylsulfonyl)imide		Mutelet <i>et al.</i> (2009)
76	EMIM-DCA	1-Ethyl-3-Methylimidazolium- Dicyanamide		Mutelet <i>et al.</i> (2009)

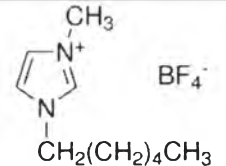
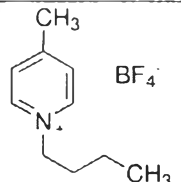
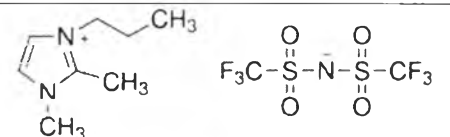
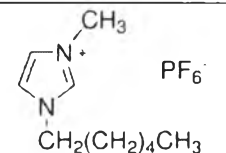
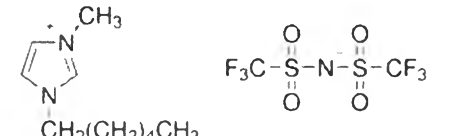
Table 4.6 List of 90 different ILs in this work (Continued)

No.	Abbreviation	Full name	Chemical Structure	Reference
77	PeMPIP-BTI	1-Pentyl-1-Methylpiperidinium-Bis(trifluoromethylsulfonyl)imide	 <p>$[C_n C_1 \text{Pip}][\text{NTf}_2]$ ($n = 3, 4, 5, 6$)</p>	Paduszyński <i>et al.</i> (2013)
78	HMPIP-BTI	1-Hexyl-1-Methylpiperidinium-Bis(trifluoromethylsulfonyl)imide	 <p>$[C_n C_1 \text{Pip}][\text{NTf}_2]$ ($n = 3, 4, 5, 6$)</p>	Paduszyński <i>et al.</i> (2013)
79	BMIM-BF ₄	1-Butyl-3-Methylimidazolium-Tetrafluoroborate	 <p>BF_4^-</p>	Zhou <i>et al.</i> (2006)
80	BMIM-BF ₄	1-Butyl-3-Methylimidazolium-Tetrafluoroborate	 <p>BF_4^-</p>	Revelli <i>et al.</i> (2008)

Table 4.6 List of 90 different ILs in this work (Continued)

No.	Abbreviation	Full name	Chemical Structure	Reference
81	BMIM-PF6	1-Butyl-3-Methylimidazolium-Hexafluorophosphate		Shimoyama <i>et al.</i> (2008)
82	BMPY-BF4	1-Butyl-3-Methylpyridinium-Tetrafluoroborate		Shimoyama <i>et al.</i> (2008)
83	EMIM-EtSO4	1-Ethyl-3-Methylimidazolium-Ethylsulfate		Sumartschenkowa <i>et al.</i> (2006)
84	3C6C14P-PF6	Trihexyltetradecylphosphonium-Hexafluorophosphate		Tumba <i>et al.</i> (2012)
85	3C6C14P-BTI	Trihexyltetradecylphosphonium-Bis(trifluoromethylsulfonyl)imide		Tumba <i>et al.</i> (2013)

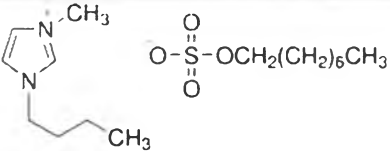
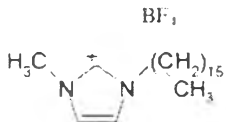
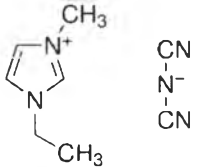
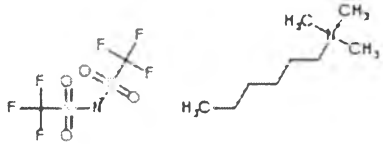
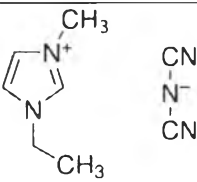
Table 4.6 List of 90 different ILs in this work (Continued)

No.	Abbreviation	Full name	Chemical Structure	Reference
86	HMIM-CF ₃ SO ₃	1-Hexyl-3-Methylimidazolium-Trifluoromethanesulfonate		Yang <i>et al.</i> (2008)
87	OHDMIM-BF ₄	1-(2-Hydroxyethyl)-3-Methylimidazolium Tetrafluoroborate		Zhang <i>et al.</i> (2009)
88	EMIM-FAP	1-Ethyl-3-Methylimidazolium-Trifluorotris(pentafluoroethyl)phosphate		Tan <i>et al.</i> (2011)
89	EMIM-TCB	1-Ethyl-3-Methylimidazolium-tetracyanoborate		Tan <i>et al.</i> (2011)
90	MMIM-DMP	1-Methyl-3-methylimidazolium-dimethylphosphate		Zhou <i>et al.</i> (2006)

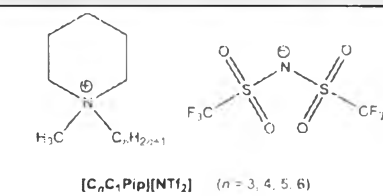
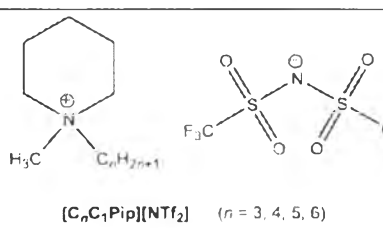
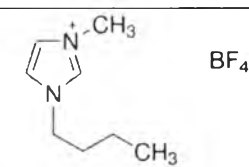
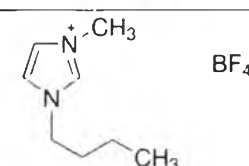
Table 4.7 Activity coefficient at infinite dilution at 298 K for the solutes in ILs

No.	Abbreviation of ILs	Activity coefficients at infinite dilution for the solutes in ILs										References
		Hexane	Heptane	cyclohexane	MCH	ethanol	toluene	Benzene	EB	PX	water	
1	BMIM-BF4	80.967	119.567									Bahlmann <i>et al.</i> (2009)
2	HMIM-BF4		46.154									Bahlmann <i>et al.</i> (2009)
3	3C6C14P-Cl	0.775	0.811	0.634		0.757		0.412				Banerjee <i>et al.</i> (2006)
4	3C6C14P-BF4	1.003	1.022	0.738		5.834		0.372				Banerjee <i>et al.</i> (2006)
5	3C6C14P-BTI	0.777	0.793	0.599		0.875		0.408				Banerjee <i>et al.</i> (2006)
6	OMIM-Cl	17.200	21.300					1.990				David <i>et al.</i> (2003)
7	EMIM-BTI	20.754	0.773	0.773				0.773				Deenadayalu <i>et al.</i> (2005)
8	OMIM-MDEGSO4	12.900	16.000	7.860				1.460				Deenadayalu <i>et al.</i> (2006b)
9	BMPY-BF4	73.118	93.383	32.112	20.790	1.992	2.614	1.620	4.804	4.046		Diedenhofen <i>et al.</i> (2003)
10	EM2IM-BTI	73.118	41.496	16.557	13.381	2.332	1.625	1.106	2.874	2.582		Diedenhofen <i>et al.</i> (2003)
11	EMIM-BTI	27.110	42.425	15.555	13.078	1.699	1.879	1.170	2.883	2.693		Diedenhofen <i>et al.</i> (2003)
12	EMIM-TFA	84.200	132.800	39.600		0.352	4.337	2.747	7.399	7.105	0.103	Domanska <i>et al.</i> (2007)
13	EMIM-SCN	327.000	475.000	113.900		1.000	6.010	3.430	11.750	10.180	0.267	Domanska <i>et al.</i> (2008a)
14	BMIM-CF3SO3	41.600	55.900	20.600		1.070	2.310	1.550		3.473	0.901	Domanska <i>et al.</i> (2008b)

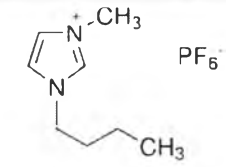
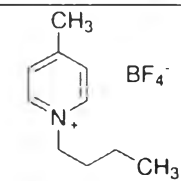
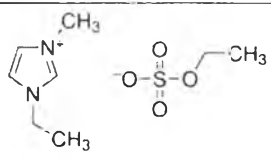
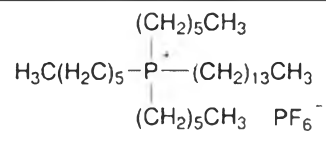
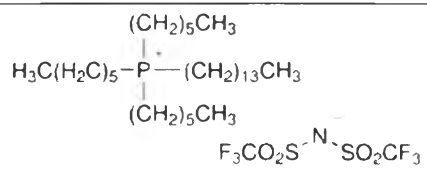
Table 4.7 Activity coefficient at infinite dilution at 298 K for the solutes in ILs (Continued)

No.	Abbreviation of ILs	Activity coefficients at infinite dilution for the solutes in ILs										References
		Hexane	Heptane	cyclohexane	MCH	ethanol	toluene	Benzene	EB	PX	water	
15	C6H13OCH2MIM-BTI	8.360	10.600	5.440		1.590	1.051	0.802	1.471	1.431	4.370	Domanska <i>et al.</i> (2009a)
16	(C6H13OCH2)2IM-BTI	3.220	3.940	2.320		4.337	0.740	0.608	0.968	0.943	4.430	Domanska <i>et al.</i> (2009a)
17	EMPYR-CF3SO3	55.800	71.500	25.700		1.050	2.160	1.410	3.433	3.290	1.700	Domanska <i>et al.</i> (2009b)
18	E3S-BTI	28.600	40.400	16.100		2.150	1.540	1.080	2.420	3.290	4.363	Domanska <i>et al.</i> (2009c)
19	BMPY-BTI	15.400	20.400	8.930		0.359	1.910	0.683	1.402	1.278	4.860	Domanska <i>et al.</i> (2009d)
20	BMIM-SCN	226.000	281.000	62.300		0.743	3.400	2.130	5.860	5.510	0.267	Domanska <i>et al.</i> (2009e)
21	MMIM-MDEGSO4							4.550				Domanska <i>et al.</i> (2009e)
22	MMIM-MeSO4							7.690				Domanska <i>et al.</i> (2009e)
23	BMIM-OcSO4							1.430				Domanska <i>et al.</i> (2009e)
24	DMIM-TCB	6.580	8.367	4.012	4.940	2.720	0.705	0.534	0.951	0.885	2.720	Domanska <i>et al.</i> (2010a)
25	HMIM-SCN		81.400	28.200		0.844	2.790	1.910	4.337		0.572	Domanska <i>et al.</i> (2010b)
26	PMPIP-BTI	25.301	32.205	13.966		2.187	1.243	0.911	1.827	1.637	4.903	Domanska <i>et al.</i> (2010c)

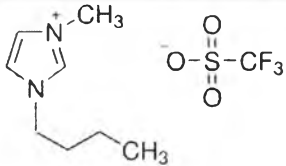
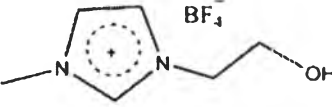
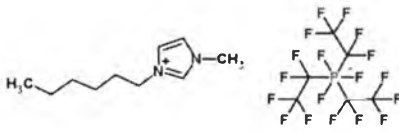
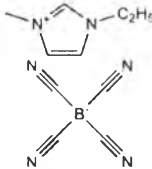
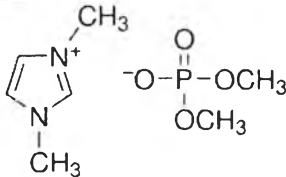
Table 4.7 Activity coefficient at infinite dilution at 298 K for the solutes in ILs (Continued)

No.	Abbreviation of ILs	Activity coefficients at infinite dilution for the solutes in ILs										References
		Hexane	Heptane	cyclohexane	MCH	ethanol	toluene	Benzene	EB	PX	water	
27	P1444-TOS	48.800	35.200	22.500		0.263	1.940	1.530	2.510	2.540	0.619	Domanska <i>et al.</i> (2010d)
28	BMPY-SCN	107.000	147.000	37.300		0.698	2.550	1.660	4.400	3.870	0.283	Domanska <i>et al.</i> (2010e)
29	BMPYR-SCN		183.000	44.050		0.601	2.890	1.770	5.100	4.970	0.283	Domanska <i>et al.</i> (2010e)
30	BMIM-TOS	50.087	65.413	21.016		0.360	3.110	2.015	4.628	4.960	0.171	Domanska <i>et al.</i> (2010f)
31	BMPYR-TCB	18.483	26.233	9.345	13.234	1.483	1.038	0.782	1.520	1.377	2.547	Domanska <i>et al.</i> (2011a)
32	EMIM-TCB	33.800	53.400	16.700	24.900	1.580	1.650	1.130	1.108	1.048	2.240	Domanska <i>et al.</i> (2011b)
33	BMPYR-FAP	11.441	16.783	7.971	10.390	3.528	0.748	0.568	1.350	1.270	12.583	Domanska <i>et al.</i> (2012a)
34	HMIM-TCB	13.000	18.467	7.178	9.864	1.187	0.914	0.722				Domanska <i>et al.</i> (2012b)
35	EMIM-BF4	138.321	210.004	55.456				2.396				Foco <i>et al.</i> (2006)
36	BMIM-BF4	95.207	137.881	46.262		2.258	4.152	2.363				Foco <i>et al.</i> (2006)
37	HMIM-BF4	35.186	49.110	18.915		1.669		1.637				Foco <i>et al.</i> (2006)
38	OMIM-BF4	13.399	16.966	8.678		1.414	1.663	1.278				Foco <i>et al.</i> (2006)
39	OMA-BTI	1.139	1.325	0.851	1.650	0.973	0.505	0.310				Gwala <i>et al.</i> (2010)
40	BMPY-BF4	63.700	93.600	31.800		1.970	2.600	1.630	4.800	4.040		Heintz <i>et al.</i> (2001)
41	EMIM-BTI	27.100	42.300	15.500		1.690	1.720	1.170	2.870	2.680		Heintz <i>et al.</i> (2002)

Table 4.7 Activity coefficient at infinite dilution at 298 K for the solutes in ILs (Continued)

No.	Abbreviation of ILs	Activity coefficients at infinite dilution for the solutes in ILs										References
		Hexane	Heptane	cyclohexane	MCH	ethanol	toluene	Benzene	EB	PX	water	
42	EM2IM-BTI	27.300	41.100	16.400		2.300	1.640	1.090	2.870	2.580		Heintz <i>et al.</i> (2002)
43	BMIM-BTI	15.400	23.000	9.320		1.880	1.400	0.880				Heintz <i>et al.</i> (2005a)
44	OMIM-BF ₄	12.400	16.000	8.060		1.750	1.540	1.190				Heintz <i>et al.</i> (2005b)
45	HMIM-BTI	8.200	11.400	5.800		2.100	1.000	0.780				Heintz <i>et al.</i> (2006a)
46	BM3A-BTI	19.850	31.230	5.760		2.290	1.780	1.370				Heintz <i>et al.</i> (2006b)
47	BMIM-BF ₄	65.900	83.500	30.700	43.700	1.100	2.500	1.500			2.600	Zhang <i>et al.</i> (2007b)
48	OMIM-BF ₄	8.600	11.000	5.300	6.700	0.500	1.000	0.700				Zhang <i>et al.</i> (2007b)
49	HMIM-NO ₃	60.150	71.360	19.510	27.740	0.590	2.940	1.900	4.610	4.410		Kan <i>et al.</i> (2012)
50	HMIM-BTI	9.155	12.700	6.192	6.971	1.897	0.960	0.711				Kato <i>et al.</i> (2005)
51	OMIM-BTI	5.823	7.354	3.997		1.760	0.781	0.608			4.151	Kato <i>et al.</i> (2005)
52	BMPYR-BTI	16.041	23.775	9.834		2.101		0.790				Kato <i>et al.</i> (2005)
53	MMIM-BTI	41.404	69.054	23.517			2.005	1.335			2.005	Krummen <i>et al.</i> (2002)
54	EMIM-BTI	29.017	45.952	16.325		2.039	1.815	1.185			3.440	Krummen <i>et al.</i> (2002)
55	BMIM-BTI	14.667	21.467	8.915			1.230	0.877			3.698	Krummen <i>et al.</i> (2002)
56	EMIM-EtSO ₄	111.857	241.264	59.195			5.245	2.715				Krummen <i>et al.</i> (2002)
57	1MIM-BF ₄	22.100	31.200	12.900				0.960				Letcher <i>et al.</i> (2003a)
58	BMPY-BF ₄	64.860						1.630				Letcher <i>et al.</i> (2003a)
59	EMMIM-BTI	27.700						1.090				Letcher <i>et al.</i> (2003a)
60	HMIM-PF ₆	22.500	30.600	12.650		1.738		1.030				Letcher <i>et al.</i> (2003b)
61	HMIM-BTI	8.330	10.900	5.500				0.674				Letcher <i>et al.</i> (2005a)

Table 4.7 Activity coefficient at infinite dilution at 298 K for the solutes in ILs (Continued)

No.	Abbreviation of ILs	Activity coefficients at infinite dilution for the solutes in ILs										References
		Hexane	Heptane	cyclohexane	MCH	ethanol	toluene	Benzene	EB	PX	water	
62	BMIM-OcSO4	7.210	8.270	4.920			1.980	1.420				Letcher <i>et al.</i> (2005b)
63	BMIM-MDEGSO4	80.900	111.000	34.400			3.720	2.040				Letcher <i>et al.</i> (2005c)
64	3C6C14P-FAP	0.680	0.760	0.520		1.337		0.210				Letcher <i>et al.</i> (2005d)
65	3BMP-MeSO4	11.234	14.933	5.500				1.000				Letcher <i>et al.</i> (2007)
66	3C6C14P-BTI	1.067	1.237	0.760		1.383		0.370				Letcher <i>et al.</i> (2008)
67	BMPY-TOS	47.517	68.231	0.967		0.967		0.967				Letcher <i>et al.</i> (2009)
68	PDMIM-BF4	406.000	740.600	168.100	285.700		7.437	4.473	17.790	11.960		Wang <i>et al.</i> (2007)
69	BMIM-CF3SO3	39.200	58.200	23.100	31.400		2.700	1.800	4.600	4.300		Ge <i>et al.</i> (2007)
70	EMIM-BF4	106.900	160.800	84.030	1.830		3.730	2.160	6.680	5.480		Ge <i>et al.</i> (2008)
71	BMIM-PF6		66.160	25.745		2.945	2.643	1.583	4.144	4.018		Mutelet <i>et al.</i> (2005)
72	BMIM-OcSO4	15.740	3.472	1.992		0.543	0.982	0.591	1.244	1.366		Mutelet <i>et al.</i> (2006)
73	C16MIM-BF4	2.170	2.470	1.710		1.780	0.910	0.790	1.070	1.010		Mutelet <i>et al.</i> (2007)
74	EMIM-DCA	82.289	39.659	20.765	14.837	0.176	0.444	0.868	0.281	0.231		Mutelet <i>et al.</i> (2009)
75	TMHA-BTI	13.847	6.072	6.256	3.948	2.261	0.324	0.799	0.158	0.141		Mutelet <i>et al.</i> (2009)
76	EMIM-DCA	159.294	278.870	62.060	101.560	0.800	4.230	2.581	7.798	7.636	0.400	Mutelet <i>et al.</i> (2009)
77	PeMPIP-BTI	10.934	15.300	7.136	8.443	2.105	0.875	0.680	1.253	1.160		Paduszynski <i>et al.</i> (2013)
78	HMPPIP-BTI	8.281	11.027	5.382	6.655	2.123	0.807	0.645	1.188	1.098		Paduszynski <i>et al.</i> (2013)
79	BMIM-BF4	64.100	95.700	33.900	50.600		2.890	1.720	5.650	4.930		Zhou <i>et al.</i> (2006)

Table 4.7 Activity coefficient at infinite dilution at 298 K for the solutes in ILs (Continued)

No.	Abbreviation of ILs	Activity coefficients at infinite dilution for the solutes in ILs										References
		Hexane	Heptane	cyclohexane	MCH	ethanol	toluene	Benzene	EB	PX	water	
80	BMIM-BF ₄	134.205	264.194	184.200	107.139	2.281	4.592	2.205	7.551	7.749		Revelli <i>et al.</i> (2008)
81	BMIM-PF ₆					3.515	1.926					Shimoyama <i>et al.</i> (2008)
82	BMPY-BF ₄					1.813						Shimoyama <i>et al.</i> (2008)
83	EMIM-EtSO ₄			45.300		0.890	6.200	3.100	13.500		0.230	Sumartschenkowa <i>et al.</i> (2006)
84	3C6C14P-PF ₆	2.337	2.551	1.739	1.000	3.005	0.933	0.822				Tumba <i>et al.</i> (2012)
85	3C6C14P-BTf	1.09	1.28	0.84	0.93	1.64	0.46	0.39				Tumba <i>et al.</i> (2013)
86	HMIM-CF ₃ SO ₃	21.450	26.850	11.040	14.190		1.946	1.412	2.828	2.703		Yang <i>et al.</i> (2008)
87	OHDMIM-BF ₄		489.900	306.900	301.500		18.390	9.142				Zhang <i>et al.</i> (2009)
88	EMIM-FAP	12.813	24.682	11.601	16.512	3.920	1.420	0.988	2.218	2.184		Tan <i>et al.</i> (2011)
89	EMIM-TCB	25.146	44.438	15.742	23.537	1.839	1.834	1.310	3.000	2.721		Tan <i>et al.</i> (2011)
90	MMIM-DMP					0.153					0.090	Zhou <i>et al.</i> (2006)

Table 4.8 Hildebrand solubility parameter, capacity and selectivity of ILs

No	Abbreviation of ILs	Hildebrand Solubility Parameter (MPa ^{1/2})	water - ethanol		ethanol - hexane		benzene - hexane		toluene - MCH		EB - PX		References
			water as target solute		ethanol as target solute		benzene as target solute		toluene as target solute		EB as target solute		
			capacity	selectivity	capacity	selectivity	capacity	selectivity	capacity	selectivity	capacity	selectivity	
1	BMIM-BF4	31.60											Bahlmann <i>et al.</i> (2009)
2	HMIM-BF4	31.12											Bahlmann <i>et al.</i> (2009)
3	3C6C14P-Cl	15.56			1.32	1.02	2.43	1.88					Banerjee <i>et al.</i> (2006)
4	3C6C14P-BF4	23.02			0.17	0.17	2.69	2.70					Banerjee <i>et al.</i> (2006)
5	3C6C14P-BTf	17.13			1.14	0.89	2.45	1.91					Banerjee <i>et al.</i> (2006)
6	OMIM-Cl	23.19					0.50	8.64					David <i>et al.</i> (2003)
7	EMIM-BTf	26.18					1.29	26.87					Deenadayalu <i>et al.</i> (2005)
8	OMIM-MDEGSO4	23.85					0.68	8.84					Deenadayalu <i>et al.</i> (2006b)
9	BMPY-BF4	31.41			0.50	36.70	0.62	45.12	0.38	7.95	0.21	0.84	Diedenhofen <i>et al.</i> (2003)
10	EM2IM-BTf	27.46			0.43	31.36	0.90	66.10	0.62	8.23	0.35	0.90	Diedenhofen <i>et al.</i> (2003)
11	EMIM-BTf	26.18			0.59	15.96	0.85	23.17	0.53	6.96	0.35	0.93	Diedenhofen <i>et al.</i> (2003)

Table 4.8 Hildebrand solubility parameter, capacity and selectivity of ILs (Continued)

No	Abbreviation of ILs	Hildebrand Solubility Parameter (MPa ^{1/2})	water - ethanol		ethanol - hexane		benzene - hexane		toluene - MCH		EB - PX		References
			water as target solute		ethanol as target solute		benzene as target solute		toluene as target solute		EB as target solute		
			capacity	selectivity	capacity	selectivity	capacity	selectivity	capacity	selectivity	capacity	selectivity	
12	EMIM-TFA	25.56	9.68	3.41	2.84	239.00	0.36	30.65	0.23		0.14	0.96	Domanska <i>et al.</i> (2007)
13	EMIM-SCN	25.19	3.74	3.74	1.00	327.00	0.29	95.34	0.17		0.09	0.87	Domanska <i>et al.</i> (2008a)
14	BMIM-CF3SO3	22.66	1.11	1.19	0.93	38.88	0.65	26.84	0.43				Domanska <i>et al.</i> (2008b)
15	C6H13OCH2 MIM-BT1	23.01	0.23	0.36	0.63	5.26	1.25	10.42	0.95		0.68	0.97	Domanska <i>et al.</i> (2009a)
16	(C6H13OCH2) 2IM-BT1	19.60	0.23	0.98	0.23	0.74	1.64	5.30	1.35		1.03	0.97	Domanska <i>et al.</i> (2009a)
17	EMPYR-CF3SO3	23.31	0.59	0.62	0.95	53.14	0.71	39.57	0.46		0.29	0.96	Domanska <i>et al.</i> (2009b)
18	E3S-BT1	21.05	0.23	0.49	0.47	13.30	0.93	26.48	0.65		0.41	1.36	Domanska <i>et al.</i> (2009c)
19	BMPY-BT1	25.52	0.21	0.07	2.78	42.86	1.46	22.55	0.52		0.71	0.91	Domanska <i>et al.</i> (2009d)
20	BMIM-SCN	24.72	3.74	2.78	1.35	304.17	0.47	106.10	0.29		0.17	0.94	Domanska <i>et al.</i> (2009e)
21	MMIM-MDEGSO4	25.51					0.22						Domanska <i>et al.</i> (2009e)
22	MMIM-MeSO4	28.50					0.13						Domanska <i>et al.</i> (2009e)

Table 4.8 Hildebrand solubility parameter, capacity and selectivity of ILs (Continued)

No	Abbreviation of ILs	Hildebrand Solubility Parameter (MPa ^{1/2})	water - ethanol		ethanol - hexane		benzene - hexane		toluene - MCH		EB - PX		References
			water as target solute		ethanol as target solute		benzene as target solute		toluene as target solute		EB as target solute		
			capacity	selectivity	capacity	selectivity	capacity	selectivity	capacity	selectivity	capacity	selectivity	
23	BMIM-OcSO4	24.80						0.70					Domanska <i>et al.</i> (2009e)
24	DMIM-TCB	24.00	0.37	1.00	0.37	2.42	1.87	12.31	1.42	7.01	1.05	0.93	Domanska <i>et al.</i> (2010a)
25	HMIM-SCN	24.24	1.75	1.48	1.18		0.52		0.36		0.23		Domanska <i>et al.</i> (2010b)
26	PMPiP-BTi	23.64	0.20	0.45	0.46	11.57	1.10	27.78	0.80		0.55	0.90	Domanska <i>et al.</i> (2010c)
27	PI444-TOS	19.18	1.62	0.43	3.80	185.56	0.65	31.90	0.52		0.40	1.01	Domanska <i>et al.</i> (2010d)
28	BMPY-SCN	24.53	3.54	2.47	1.43	153.30	0.60	64.46	0.39		0.23	0.88	Domanska <i>et al.</i> (2010e)
29	BMPYR-SCN	24.89	3.54	2.13	1.66		0.56		0.35		0.20	0.97	Domanska <i>et al.</i> (2010e)
30	BMIM-TOS	23.25	5.85	2.11	2.77	138.94	0.50	24.86	0.32		0.22	1.07	Domanska <i>et al.</i> (2010f)
31	BMPYR-TCB	25.60	0.39	0.58	0.67	12.46	1.28	23.65	0.96	12.74	0.66	0.91	Domanska <i>et al.</i> (2011a)
32	EMIM-TCB	25.90	0.45	0.71	0.63	21.39	0.88	29.91	0.61	15.09	0.90	0.95	Domanska <i>et al.</i> (2011b)
33	BMPYR-FAP	24.88	0.08	0.28	0.28	3.24	1.76	20.13	1.34	13.88	0.74	0.94	Domanska <i>et al.</i> (2012a)

Table 4.8 Hildebrand solubility parameter, capacity and selectivity of ILs (Continued)

No	Abbreviation of ILs	Hildebrand Solubility Parameter (MPa ^{1/2})	water - ethanol		ethanol - hexane		benzene - hexane		toluene - MCH		EB - PX		References
			water as target solute		ethanol as target solute		benzene as target solute		toluene as target solute		EB as target solute		
			capacity	selectivity	capacity	selectivity	capacity	selectivity	capacity	selectivity	capacity	selectivity	
34	HMIM-TCB	24.95			0.84	10.95	1.38	18.00	1.09	10.80			Domańska <i>et al.</i> (2012b)
35	EMIM-BF4	32.07					0.42	57.73					Foco <i>et al.</i> (2006)
36	BMIM-BF4	31.60			0.44	42.17	0.42	40.30	0.24	0.00			Foco <i>et al.</i> (2006)
37	HMIM-BF4	31.12			0.60	21.08	0.61	21.49					Foco <i>et al.</i> (2006)
38	OMIM-BF4	30.65			0.71	9.48	0.78	10.49	0.60	0.00			Foco <i>et al.</i> (2006)
39	OMA-BT1	22.16			1.03	1.17	3.23	3.67	1.98	3.27			Gwala <i>et al.</i> (2010)
40	BMPY-BF4	31.41			0.51	32.34	0.61	39.08	0.38		0.21	0.84	Heintz <i>et al.</i> (2001)
41	EMIM-BT1	26.18			0.59	16.04	0.85	23.16	0.58		0.35	0.93	Heintz <i>et al.</i> (2002)
42	EM2IM-BT1	27.46			0.43	11.87	0.92	25.05	0.61		0.35	0.90	Heintz <i>et al.</i> (2002)
43	BMIM-BT1	25.71			0.53	8.19	1.14	17.50	0.71				Heintz <i>et al.</i> (2005a)
44	OMIM-BF4	30.65			0.57	7.09	0.84	10.42	0.65				Heintz <i>et al.</i> (2005b)

Table 4.8 Hildebrand solubility parameter, capacity and selectivity of ILs (Continued)

No	Abbreviation of ILs	Hildebrand Solubility Parameter (MPa ^{1/2})	water - ethanol		ethanol - hexane		benzene - hexane		toluene - MCH		EB - PX		References
			water as target solute		ethanol as target solute		benzene as target solute		toluene as target solute		EB as target solute		
			capacity	selectivity	capacity	selectivity	capacity	selectivity	capacity	selectivity	capacity	selectivity	
45	HMIM-BTI	25.23			0.48	3.90	1.28	10.51	1.00				Heintz <i>et al.</i> (2006a)
46	BM3A-BTI	26.44			0.44	8.67	0.73	14.49	0.56				Heintz <i>et al.</i> (2006b)
47	BMIM-BF4	31.60	0.38	0.42	0.91	59.91	0.67	43.93	0.40	17.48			Zhang <i>et al.</i> (2007b)
48	OMIM-BF4	30.65			2.00	17.20	1.43	12.29	1.00	6.70			Zhang <i>et al.</i> (2007b)
49	HMIM-NO3	27.32			1.69	101.95	0.53	31.66	0.34	9.44	0.22	0.96	Kan <i>et al.</i> (2012)
50	HMIM-BTI	25.23			0.53	4.83	1.41	12.88	1.04	7.26			Kato <i>et al.</i> (2005)
51	OMIM-BTI	24.76	0.24	0.42	0.57	3.31	1.64	9.57	1.28				Kato <i>et al.</i> (2005)
52	BMPYR-BTI	25.88			0.48	7.64	1.27	20.31					Kato <i>et al.</i> (2005)
53	MMIM-BTI	26.42	0.50				0.75	31.02	0.50				Krummen <i>et al.</i> (2002)
54	EMIM-BTI	26.18	0.29	0.59	0.49	14.23	0.84	24.49	0.55				Krummen <i>et al.</i> (2002)
55	BMIM-BTI	25.71	0.27				1.14	16.73	0.81				Krummen <i>et al.</i> (2002)
56	EMIM-EtSO4	24.45					0.37	41.20	0.19				Krummen <i>et al.</i> (2002)

Table 4.8 Hildebrand solubility parameter, capacity and selectivity of ILs (Continued)

No	Abbreviation of ILs	Hildebrand Solubility Parameter (MPa ^{1/2})	water - ethanol		ethanol - hexane		benzene - hexane		toluene - MCH		EB - PX		References
			water as target solute		ethanol as target solute		benzene as target solute		toluene as target solute		EB as target solute		
			capacity	selectivity	capacity	selectivity	capacity	selectivity	capacity	selectivity	capacity	selectivity	
56	EMIM-EtSO4	24.45					0.37	41.20	0.19				Krummen <i>et al.</i> (2002)
57	HMIM-BF4	31.12					1.04	23.02					Letcher <i>et al.</i> (2003a)
58	BMPY-BF4	31.41					0.61	39.79					Letcher <i>et al.</i> (2003a)
59	EMMIM-BTI	27.46					0.92	25.41					Letcher <i>et al.</i> (2003a)
60	HMIM-PF6	28.60			0.58	12.95	0.97	21.84					Letcher <i>et al.</i> (2003b)
61	HMIM-BTI	25.23					1.48	12.36					Letcher <i>et al.</i> (2005a)
62	BMIM-OcSO4	24.80					0.70	5.08	0.51				Letcher <i>et al.</i> (2005b)
63	BMIM-MDEGSO4	24.80					0.49	39.66	0.27				Letcher <i>et al.</i> (2005c)
64	3C6C14P-FAP	16.22			0.75	0.51	4.76	3.24					Letcher <i>et al.</i> (2005d)
65	3BMP-MeSO4	23.72					1.00	11.23					Letcher <i>et al.</i> (2007)
66	3C6C14P-BTI	17.13			0.72	0.77	2.70	2.88					Letcher <i>et al.</i> (2008)

Table 4.8 Hildebrand solubility parameter, capacity and selectivity of ILs (Continued)

No	Abbreviation of ILs	Hildebrand Solubility Parameter (MPa ^{1/2})	water - ethanol		ethanol - hexane		benzene - hexane		toluene - MCH		EB - PX		References
			water as target solute		ethanol as target solute		benzene as target solute		toluene as target solute		EB as target solute		
			capacity	selectivity	capacity	selectivity	capacity	selectivity	capacity	selectivity	capacity	selectivity	
67	BMPY-TOS	23.06			1.03	49.15	1.03	49.15					Letcher <i>et al.</i> (2009)
68	PDMIM-BF4	33.11					0.22	90.77	0.13	38.42	0.06	0.67	Wang <i>et al.</i> (2007)
69	BMIM-CF3SO3	22.66					0.56	21.78	0.37	11.63	0.22	0.93	Ge <i>et al.</i> (2007)
70	EMIM-BF4	32.07					0.46	49.49	0.27	0.49	0.15	0.82	Ge <i>et al.</i> (2008)
71	BMIM-PF6	29.07			0.34		0.63		0.38		0.24	0.97	Mutelet <i>et al.</i> (2005)
72	BMIM-OcSO4	24.80			1.84	28.97	1.69	26.64	1.02		0.80	1.10	Mutelet <i>et al.</i> (2006)
73	C16MIM-BF4	28.75			0.56	1.22	1.27	2.75	1.10		0.93	0.94	Mutelet <i>et al.</i> (2007)
74	EMIM-DCA	25.84			5.67	466.75	1.15	94.85	2.25	33.42	3.55	0.82	Mutelet <i>et al.</i> (2009)
75	TMHA-BTI	25.96			0.44	6.12	1.25	17.34	3.09	12.20	6.33	0.89	Mutelet <i>et al.</i> (2009)
76	EMIM-DCA	25.84	2.50	2.00	1.25	199.12	0.39	61.72	0.24	24.01	0.13	0.98	Mutelet <i>et al.</i> (2009)
77	PeMPIP-BTI	22.93			0.48	5.19	1.47	16.09	1.14	9.64	0.80	0.93	Paduszyński <i>et al.</i> (2013)

Table 4.8 Hildebrand solubility parameter, capacity and selectivity of ILs (Continued)

No	Abbreviation of ILs	Hildebrand Solubility Parameter (MPa ^{1/2})	water - ethanol		ethanol - hexane		benzene - hexane		toluene - MCH		EB - PX		References
			water as target solute		ethanol as target solute		benzene as target solute		toluene as target solute		EB as target solute		
			capacity	selectivity	capacity	selectivity	capacity	selectivity	capacity	selectivity	capacity	selectivity	
78	HMPIP-BTI	22.69			0.47	3.90	1.55	12.84	1.24	8.25	0.84	0.92	Paduszyński <i>et al.</i> (2013)
79	BMIM-BF4	31.60					0.58	37.27	0.35	17.51	0.18	0.87	Zhou <i>et al.</i> (2006)
80	BMIM-BF4	31.60			0.44	58.83	0.45	60.86	0.22	23.33	0.13	1.03	Revelli <i>et al.</i> (2008)
81	BMIM-PF6	29.07			0.28				0.52				Shimoyama <i>et al.</i> (2008)
82	BMPY-BF4	31.41			0.55								Shimoyama <i>et al.</i> (2008)
83	EMIM-EtSO4	24.45	4.35	3.87	1.12		0.32		0.16		0.07		Sumartschenkowa <i>et al.</i> (2006)
84	3C6C14P-PF6	20.50			0.33	0.78	1.22	2.84	1.07	1.07			Tumba <i>et al.</i> (2012)
85	3C6C14P-BTI	17.13			0.61	0.66	2.56	2.79	2.17	2.02			Tumba <i>et al.</i> (2013)
86	HMIM-CF3SO3	22.19					0.71	15.19	0.51	7.29	0.35	0.96	Yang <i>et al.</i> (2008)
87	OHDMIM-BF4	35.11					0.11		0.05	16.39			Zhang <i>et al.</i> (2009)
88	EMIM-FAP	25.18			0.26	3.27	1.01	12.97	0.70	11.63	0.45	0.98	Tan <i>et al.</i> (2011)
89	EMIM-TCB	25.90			0.54	13.68	0.76	19.20	0.55	12.83	0.33	0.91	Tan <i>et al.</i> (2011)
90	MMIM-DMP	27.08	11.11	1.70	6.54								Zhou <i>et al.</i> (2006)

Table 4.8 Hildebrand solubility parameter, capacity and selectivity of ILs (Continued)

No.	Abbreviation of ILs	Hildebrand Solubility Parameter (MPa ^{1/2})	water - ethanol		ethanol - hexane		benzene - hexane		toluene - MCH		EB - PX		References
			ethanol as target solute		hexane as target solute		hexane as target solute		MCH as target solute		PX as target solute		
			capacity	selectivity	capacity	selectivity	capacity	selectivity	capacity	selectivity	capacity	selectivity	
1	BMIM-BF4	31.60			0.01		0.01						Bahlmann <i>et al.</i> (2009)
2	HMIM-BF4	31.12											Bahlmann <i>et al.</i> (2009)
3	3C6C14P-C1	15.56	1.32		1.29	0.98	1.29	0.53					Banerjee <i>et al.</i> (2006)
4	3C6C14P-BF4	23.02	0.17		1.00	5.82	1.00	0.37					Banerjee <i>et al.</i> (2006)
5	3C6C14P-BTI	17.13	1.14		1.29	1.13	1.29	0.52					Banerjee <i>et al.</i> (2006)
6	OMIM-C1	23.19			0.06		0.06	0.12					David <i>et al.</i> (2003)
7	EMIM-BTI	26.18			0.05		0.05	0.04					Deenadayalu <i>et al.</i> (2005)
8	OMIM-MDEGSO4	23.85			0.08		0.08	0.11					Deenadayalu <i>et al.</i> (2006b)
9	BMPY-BF4	31.41	0.50		0.01	0.03	0.01	0.02	0.05	0.13	0.25	1.19	Diedenhofen <i>et al.</i> (2003)
10	EM2IM-BTI	27.46	0.43		0.01	0.03	0.01	0.02	0.07	0.12	0.39	1.11	Diedenhofen <i>et al.</i> (2003)
11	EMIM-BTI	26.18	0.59		0.04	0.06	0.04	0.04	0.08	0.14	0.37	1.07	Diedenhofen <i>et al.</i> (2003)

Table 4.8 Hildebrand solubility parameter, capacity and selectivity of ILs (Continued)

No.	Abbreviation of ILs	Hildebrand Solubility Parameter (MPa ^{1/2})	water - ethanol		ethanol - hexane		benzene - hexane		toluene - MCH		EB - PX		References
			ethanol as target solute		hexane as target solute		hexane as target solute		MCH as target solute		PX as target solute		
			capacity	selectivity	capacity	selectivity	capacity	selectivity	capacity	selectivity	capacity	selectivity	
12	EMIM-TFA	25.56	2.84	0.29	0.01		0.01	0.03			0.14	1.04	Domanska <i>et al.</i> (2007)
13	EMIM-SCN	25.19	1.00	0.27			0.00	0.01			0.10	1.15	Domanska <i>et al.</i> (2008a)
14	BMIM-CF3SO3	22.66	0.93	0.84	0.02	0.03	0.02	0.04			0.29		Domanska <i>et al.</i> (2008b)
15	C6H13OCH2MIM-BTI	23.01	0.63	2.75	0.12	0.19	0.12	0.10			0.70	1.03	Domanska <i>et al.</i> (2009a)
16	(C6H13OCH2)2IM-BTI	19.60	0.23	1.02	0.31	1.35	0.31	0.19			1.06	1.03	Domanska <i>et al.</i> (2009a)
17	EMPYR-CF3SO3	23.31	0.95	1.62	0.02	0.02	0.02	0.03			0.30	1.04	Domanska <i>et al.</i> (2009b)
18	E3S-BTI	21.05	0.47	2.03	0.03	0.08	0.03	0.04			0.30	0.74	Domanska <i>et al.</i> (2009c)
19	BMPY-BTI	25.52	2.78	13.53	0.06	0.02	0.06	0.04			0.78	1.10	Domanska <i>et al.</i> (2009d)
20	BMIM-SCN	24.72	1.35	0.36			0.00	0.01			0.18	1.06	Domanska <i>et al.</i> (2009e)
21	MMIM-MDEGSO4	25.51											Domanska <i>et al.</i> (2009e)
22	MMIM-MeSO4	28.50											Domanska <i>et al.</i> (2009e)

Table 4.8 Hildebrand solubility parameter, capacity and selectivity of ILs (Continued)

No.	Abbreviation of ILs	Hildebrand Solubility Parameter (MPa ^{1/2})	water - ethanol		ethanol - hexane		benzene - hexane		toluene - MCH		EB - PX		References
			ethanol as target solute		hexane as target solute		hexane as target solute		MCH as target solute		PX as target solute		
			capacity	selectivity	capacity	selectivity	capacity	selectivity	capacity	selectivity	capacity	selectivity	
23	BMIM-OcSO4	24.80											Domanska <i>et al.</i> (2009e)
24	DMIM-TCB	24.00	0.37	1.00	0.15	0.41	0.15	0.08	0.20	0.14	1.13	1.07	Domanska <i>et al.</i> (2010a)
25	HMIM-SCN	24.24	1.18	0.68									Domanska <i>et al.</i> (2010b)
26	PMPiP-BTI	23.64	0.46	2.24	0.04	0.09	0.04	0.04			0.61	1.12	Domanska <i>et al.</i> (2010c)
27	P1444-TOS	19.18	3.80	2.35	0.02	0.01	0.02	0.03			0.39	0.99	Domanska <i>et al.</i> (2010d)
28	BMPY-SCN	24.53	1.43	0.41	0.01	0.01	0.01	0.02			0.26	1.14	Domanska <i>et al.</i> (2010e)
29	BMPYR-SCN	24.89	1.66	0.47							0.20	1.03	Domanska <i>et al.</i> (2010e)
30	BMIM-TOS	23.25	2.77	0.47	0.02	0.01	0.02	0.04			0.20	0.93	Domanska <i>et al.</i> (2010f)
31	BMPYR-TCB	25.60	0.67	1.72	0.05	0.08	0.05	0.04	0.08	0.08	0.73	1.10	Domanska <i>et al.</i> (2011a)
32	EMIM-TCB	25.90	0.63	1.42	0.03	0.05	0.03	0.03	0.04	0.07	0.95	1.06	Domanska <i>et al.</i> (2011b)
33	BMPYR-FAP	24.88	0.28	3.57	0.09	0.31	0.09	0.05	0.10	0.07	0.79	1.06	Domanska <i>et al.</i> (2012a)

Table 4.8 Hildebrand solubility parameter, capacity and selectivity of ILs (Continued)

No.	Abbreviation of ILs	Hildebrand Solubility Parameter (MPa ^{1/2})	water - ethanol		ethanol - hexane		benzene - hexane		toluene - MCH		EB - PX		References
			ethanol as target solute		hexane as target solute		hexane as target solute		MCH as target solute		PX as target solute		
			capacity	selectivity	capacity	selectivity	capacity	selectivity	capacity	selectivity	capacity	selectivity	
34	HMIM-TCB	24.95	0.84		0.08	0.09	0.08	0.06	0.10	0.09			Domanska <i>et al.</i> (2012b)
35	EMIM-BF4	32.07			0.01		0.01	0.02					Foco <i>et al.</i> (2006)
36	BMIM-BF4	31.60	0.44		0.01	0.02	0.01	0.02					Foco <i>et al.</i> (2006)
37	HMIM-BF4	31.12	0.60		0.03	0.05	0.03	0.05					Foco <i>et al.</i> (2006)
38	OMIM-BF4	30.65	0.71		0.07	0.11	0.07	0.10					Foco <i>et al.</i> (2006)
39	OMA-BTI	22.16	1.03		0.88	0.85	0.88	0.27	0.61	0.31			Gwala <i>et al.</i> (2010)
40	BMPY-BF4	31.41	0.51		0.02	0.03	0.02	0.03			0.25	1.19	Heintz <i>et al.</i> (2001)
41	EMIM-BTI	26.18	0.59		0.04	0.06	0.04	0.04			0.37	1.07	Heintz <i>et al.</i> (2002)
42	EM2IM-BTI	27.46	0.43		0.04	0.08	0.04	0.04			0.39	1.11	Heintz <i>et al.</i> (2002)
43	BMIM-BTI	25.71	0.53		0.06	0.12	0.06	0.06					Heintz <i>et al.</i> (2005a)
44	OMIM-BF4	30.65	0.57		0.08	0.14	0.08	0.10					Heintz <i>et al.</i> (2005b)

Table 4.8 Hildebrand solubility parameter, capacity and selectivity of ILs (Continued)

No.	Abbreviation of ILs	Hildebrand Solubility Parameter (MPa ^{1/2})	water - ethanol		ethanol - hexane		benzene - hexane		toluene - MCH		EB - PX		References
			ethanol as target solute		hexane as target solute		hexane as target solute		MCH as target solute		PX as target solute		
			capacity	selectivity	capacity	selectivity	capacity	selectivity	capacity	selectivity	capacity	selectivity	
45	HMIM-BTI	25.23	0.48		0.12	0.26	0.12	0.10					Heintz <i>et al.</i> (2006a)
46	BM3A-BTI	26.44	0.44		0.05	0.12	0.05	0.07					Heintz <i>et al.</i> (2006b)
47	BMIM-BF4	31.60	0.91	2.36	0.02	0.02	0.02	0.02	0.02	0.06			Zhang <i>et al.</i> (2007b)
48	OMIM-BF4	30.65	2.00		0.12	0.06	0.12	0.08	0.15	0.15			Zhang <i>et al.</i> (2007b)
49	HMIM-NO3	27.32	1.69		0.02	0.01	0.02	0.03	0.04	0.11	0.23	1.05	Kan <i>et al.</i> (2012)
50	HMIM-BTI	25.23	0.53		0.11	0.21	0.11	0.08	0.14	0.14			Kato <i>et al.</i> (2005)
51	OMIM-BTI	24.76	0.57	2.36	0.17	0.30	0.17	0.10					Kato <i>et al.</i> (2005)
52	BMPYR-BTI	25.88	0.48		0.06	0.13	0.06	0.05					Kato <i>et al.</i> (2005)
53	MMIM-BTI	26.42			0.02		0.02	0.03					Krummen <i>et al.</i> (2002)
54	EMIM-BTI	26.18	0.49	1.69	0.03	0.07	0.03	0.04					Krummen <i>et al.</i> (2002)
55	BMIM-BTI	25.71			0.07		0.07	0.06					Krummen <i>et al.</i> (2002)
56	EMIM-EtSO4	24.45			0.01		0.01	0.02					Krummen <i>et al.</i> (2002)
57	HMIM-BF4	31.12			0.05		0.05	0.04					Letcher <i>et al.</i> (2003a)

Table 4.8 Hildebrand solubility parameter, capacity and selectivity of ILs (Continued)

No.	Abbreviation of ILs	Hildebrand Solubility Parameter (MPa ^{1/2})	water - ethanol		ethanol - hexane		benzene - hexane		toluene - MCH		EB - PX		References
			ethanol as target solute		hexane as target solute		hexane as target solute		MCH as target solute		PX as target solute		
			capacity	selectivity	capacity	selectivity	capacity	selectivity	capacity	selectivity	capacity	selectivity	
58	BMPY-BF4	31.41			0.02		0.02	0.03					Letcher <i>et al.</i> (2003a)
59	EMMIM-BTI	27.46			0.04		0.04	0.04					Letcher <i>et al.</i> (2003a)
60	HMIM-PF6	28.60	0.58		0.04	0.08	0.04	0.05					Letcher <i>et al.</i> (2003b)
61	HMIM-BTI	25.23			0.12		0.12	0.08					Letcher <i>et al.</i> (2005a)
62	BMIM-OcSO4	24.80			0.14		0.14	0.20					Letcher <i>et al.</i> (2005b)
63	BMIM-MDEGSO4	24.80			0.01		0.01	0.03					Letcher <i>et al.</i> (2005c)
64	3C6C14P-FAP	16.22	0.75		1.47	1.97	1.47	0.31					Letcher <i>et al.</i> (2005d)
65	3BMP-MeSO4	23.72			0.09		0.09	0.09					Letcher <i>et al.</i> (2007)
66	3C6C14P-BTI	17.13	0.72		0.94	1.30	0.94	0.35					Letcher <i>et al.</i> (2008)
67	BMPY-TOS	23.06	1.03		0.02	0.02	0.02	0.02					Letcher <i>et al.</i> (2009)
68	PDMIM-BF4	33.11					0.00	0.01	0.00	0.03	0.08	1.49	Wang <i>et al.</i> (2007)

Table 4.8 Hildebrand solubility parameter, capacity and selectivity of ILs (Continued)

No.	Abbreviation of ILs	Hildebrand Solubility Parameter (MPa ^{1/2})	water - ethanol		ethanol - hexane		benzene - hexane		toluene - MCH		EB - PX		References
			ethanol as target solute		hexane as target solute		hexane as target solute		MCH as target solute		PX as target solute		
			capacity	selectivity	capacity	selectivity	capacity	selectivity	capacity	selectivity	capacity	selectivity	
69	BMIM-CF3SO3	22.66			0.03		0.03	0.05	0.03	0.09	0.23	1.07	<i>Ge et al.</i> (2007)
70	EMIM-BF4	32.07			0.01		0.01	0.02	0.55	2.04	0.18	1.22	<i>Ge et al.</i> (2008)
71	BMIM-PF6	29.07	0.34								0.25	1.03	<i>Mutelet et al.</i> (2005)
72	BMIM-OcSO4	24.80	1.84		0.06	0.03	0.06	0.04			0.73	0.91	<i>Mutelet et al.</i> (2006)
73	C16MIM-BF4	28.75	0.56		0.46	0.82	0.46	0.36			0.99	1.06	<i>Mutelet et al.</i> (2007)
74	EMIM-DCA	25.84	5.67		0.01		0.01	0.01	0.07	0.03	4.33	1.22	<i>Mutelet et al.</i> (2009)
75	TMHA-BTI	25.96	0.44		0.07	0.16	0.07	0.06	0.25	0.08	7.09	1.12	<i>Mutelet et al.</i> (2009)
76	EMIM-DCA	25.84	1.25	0.50	0.01	0.01	0.01	0.02	0.01	0.04	0.13	1.02	<i>Mutelet et al.</i> (2009)
77	PeMPIP-BTI	22.93	0.48		0.09	0.19	0.09	0.06	0.12	0.10	0.86	1.08	<i>Paduszynski et al.</i> (2013)
78	HMPIP-BTI	22.69	0.47		0.12	0.26	0.12	0.08	0.15	0.12	0.91	1.08	<i>Paduszynski et al.</i> (2013)
79	BMIM-BF4	31.60			0.02		0.02	0.03	0.02	0.06	0.20	1.15	<i>Zhou et al.</i> (2006)

Table 4.8 Hildebrand solubility parameter, capacity and selectivity of ILs (Continued)

No.	Abbreviation of ILs	Hildebrand Solubility Parameter (MPa ^{1/2})	water - ethanol		ethanol - hexane		benzene - hexane		toluene - MCH		EB - PX		References
			ethanol as target solute		hexane as target solute		hexane as target solute		MCH as target solute		PX as target solute		
			capacity	selectivity	capacity	selectivity	capacity	selectivity	capacity	selectivity	capacity	selectivity	
80	BMIM-BF4	31.60	0.44		0.01	0.02	0.01	0.02	0.01	0.04	0.13	0.97	Revelli <i>et al.</i> (2008)
81	BMIM-PF6	29.07	0.28										Shimoyama <i>et al.</i> (2008)
82	BMPY-BF4	31.41	0.55										Shimoyama <i>et al.</i> (2008)
83	EMIM-EtSO4	24.45	1.12	0.26									Sumartschenkova <i>et al.</i> (2006)
84	3C6C14P-PF6	20.50	0.33		0.43	1.29	0.43	0.35	1.00	0.93			Tumba <i>et al.</i> (2012)
85	3C6C14P-BTI	17.13	0.61		0.92	1.50	0.92	0.36	1.08	0.49			Tumba <i>et al.</i> (2013)
86	HMIM-CF3SO3	22.19			0.05		0.05	0.07	0.07	0.14	0.37	1.05	Yang <i>et al.</i> (2008)
87	OHDMIM-BF4	35.11							0.00	0.06			Zhang <i>et al.</i> (2009)
88	EMIM-FAP	25.18	0.26		0.08	0.31	0.08	0.08	0.06	0.09	0.46	1.02	Tan <i>et al.</i> (2011)
89	EMIM-TCB	25.90	0.54		0.04	0.07	0.04	0.05	0.04	0.08	0.37	1.10	Tan <i>et al.</i> (2011)
90	MMIM-DMP	27.08	6.54	0.59									Zhou <i>et al.</i> (2006)

Table 4.9 Target window for all case studies

Case study	Target solute		Target window					
	Component	Hildebrand Solubility Parameter (MPa ^{1/2})	Hildebrand Solubility Parameter (MPa ^{1/2})		Capacity (C ₂ [∞])		Selectivity (S ₁₂ [∞])	
			Minimum	Maximum	Minimum	Maximum	Minimum	Maximum
Water + Ethanol	Water	45	23	50	2	12	1	6
Ethanol + Hexane	Ethanol	26	21	31	0.5	1.5	5	15
Benzene + Hexane	Benzene	18.8	18	28	0.3	2.1	6	42
Toluene + MCH	Toluene	18.2	18	28	0.5	1.5	5	15
EB + PX	EB	18	18	30	0.5	1.5	5	15

Table 4.10 List of feasible IL candidates for all case studies

Case study	Figure	ILs	Abbreviation of feasible IL candidates
Water + Ethanol	4.20	9	BMIM-TOS, EMIM-EtSO ₄ , BMPY-SCN, BMIM-SCN, BMPYR-SCN, EMIM-SCN, EMIM-TFA, EMIM-DCA, and MMIM-DMP
Ethanol + Hexane	4.21	7	C ₆ H ₁₃ OCH ₂ MIM-BTI, HMIM-TCB, BMIM-BTI, EMIM-TCB, EMIM-BTI, HMIM-PF ₆ , and OMIM-BF ₄
Benzene + Hexane	4.22	34	P1444-TOS, E3S-BTI, HMIM-CF ₃ SO ₃ , BMIM-CF ₃ SO ₃ , HMPIP-BTI, PeMPIP-BTI, C ₆ H ₁₃ OCH ₂ MIM-BTI, OMIM-Cl, BMIM-TOS, EMPYR-CF ₃ SO ₃ , PMPIP-BTI, 3BMP-MeSO ₄ , OMIM-MDEGSO ₄ , EMIM-EtSO ₄ , OMIM-BTI, BMIM-OcSO ₄ , BMIM-MDEGSO ₄ , BMPYR-FAP, HMIM-TCB, EMIM-FAP, HMIM-BTI, BMPY-BTI, EMIM-TFA, BMPYR-TCB, BMIM-BTI, BMPYR-BTI, EMIM-TCB, HM3IM-BTI, EMIM-BTI, MMIM-BTI, BM3A-BTI, HMIM-NO ₃ , EMMIM-BTI, and EM2IM-BTI
Toluene + MCH	4.23	11	HMIM-CF ₃ SO ₃ , HMPIP-BTI, PeMPIP-BTI, BMPY-FAP, HMIM-TCB, EMIM-FAP, HMIM-BTI, BMPYR-TCB, EMIM-TCB, EMIM-BTI, and EM2IM-BTI
EB + PX	4.24	9	(C ₆ H ₁₃ OCH ₂) ₂ IM-BTI, C ₆ H ₁₃ OCH ₂ MIM-BTI, DMIM-TCB, BMIM-OcSO ₄ , BMPYR-FAP, HMIM-TCB, BMPY-Tf ₂ N, BMIM-TOS, and C16MIM-BF ₄

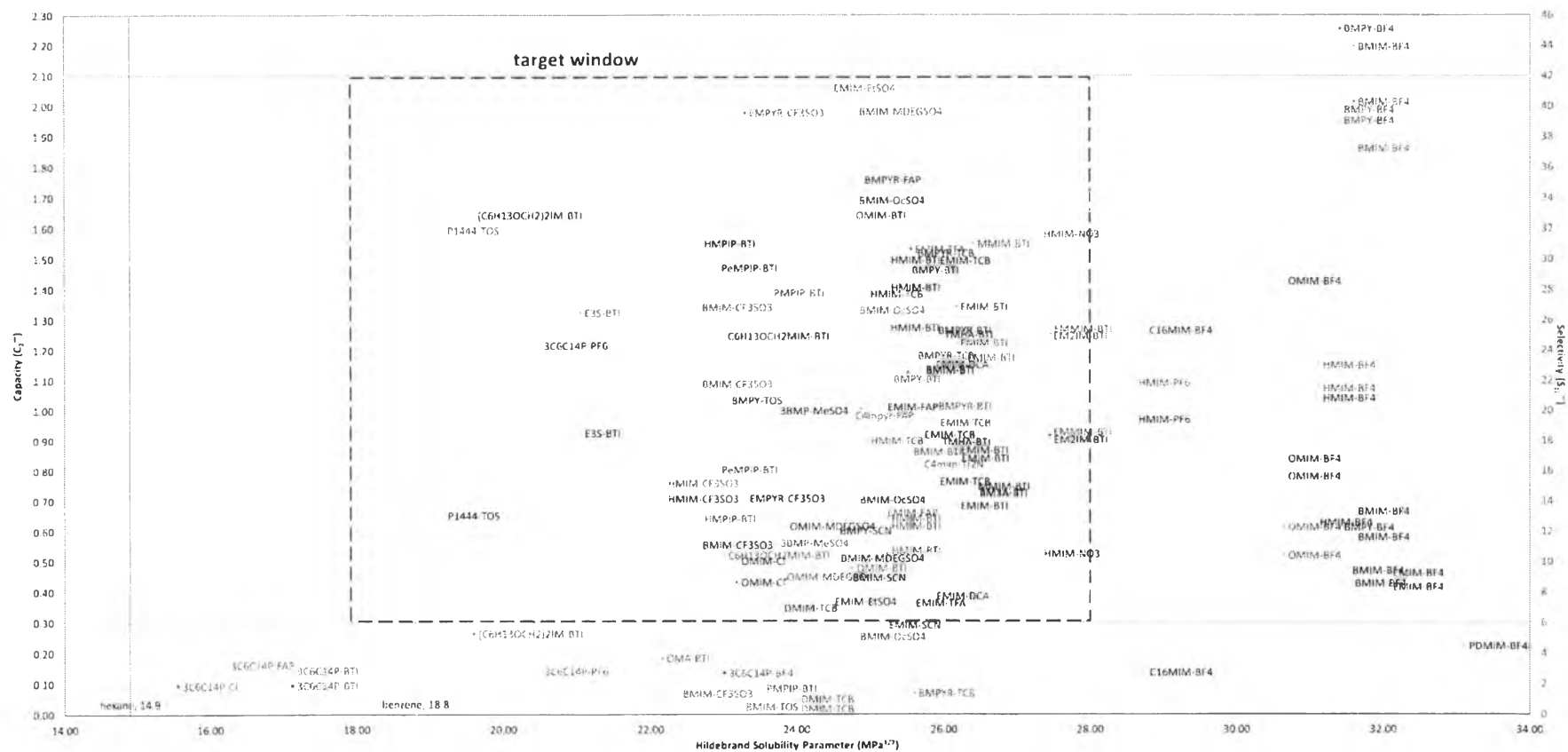

Figure 4.21 Hildebrand solubility parameters of ILs (x -axis) vs Capacity (C_2^∞) of ILs (primary y -axis) and Selectivity (S_{12}^∞) of ILs (secondary y -axis) of the benzene + hexane mixture. Benzene is the target solute.

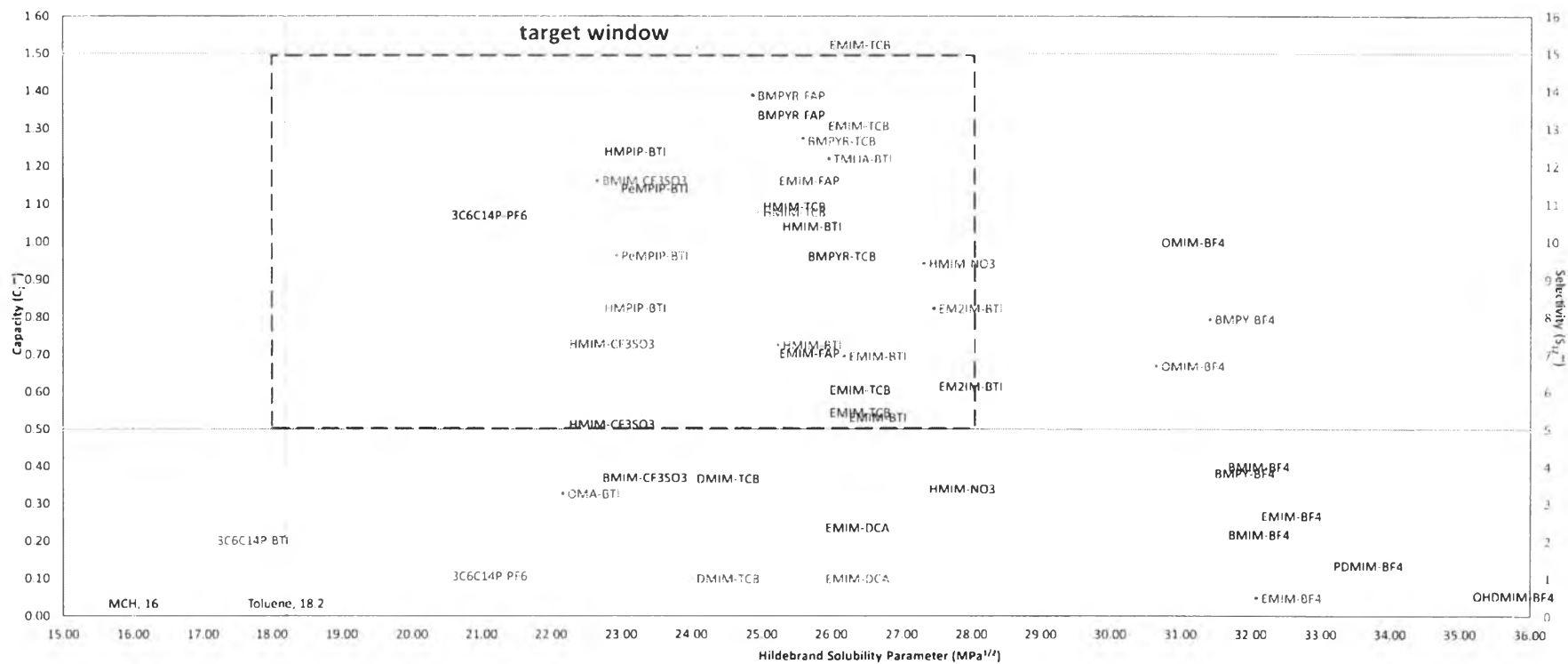

Figure 4.22 Hildebrand solubility parameters of ILs (x -axis) vs Capacity (C_2^∞) of ILs (primary y -axis) and Selectivity (S_{12}^∞) of ILs (secondary y -axis) of the toluene + MCH mixture. Toluene is the target solute.

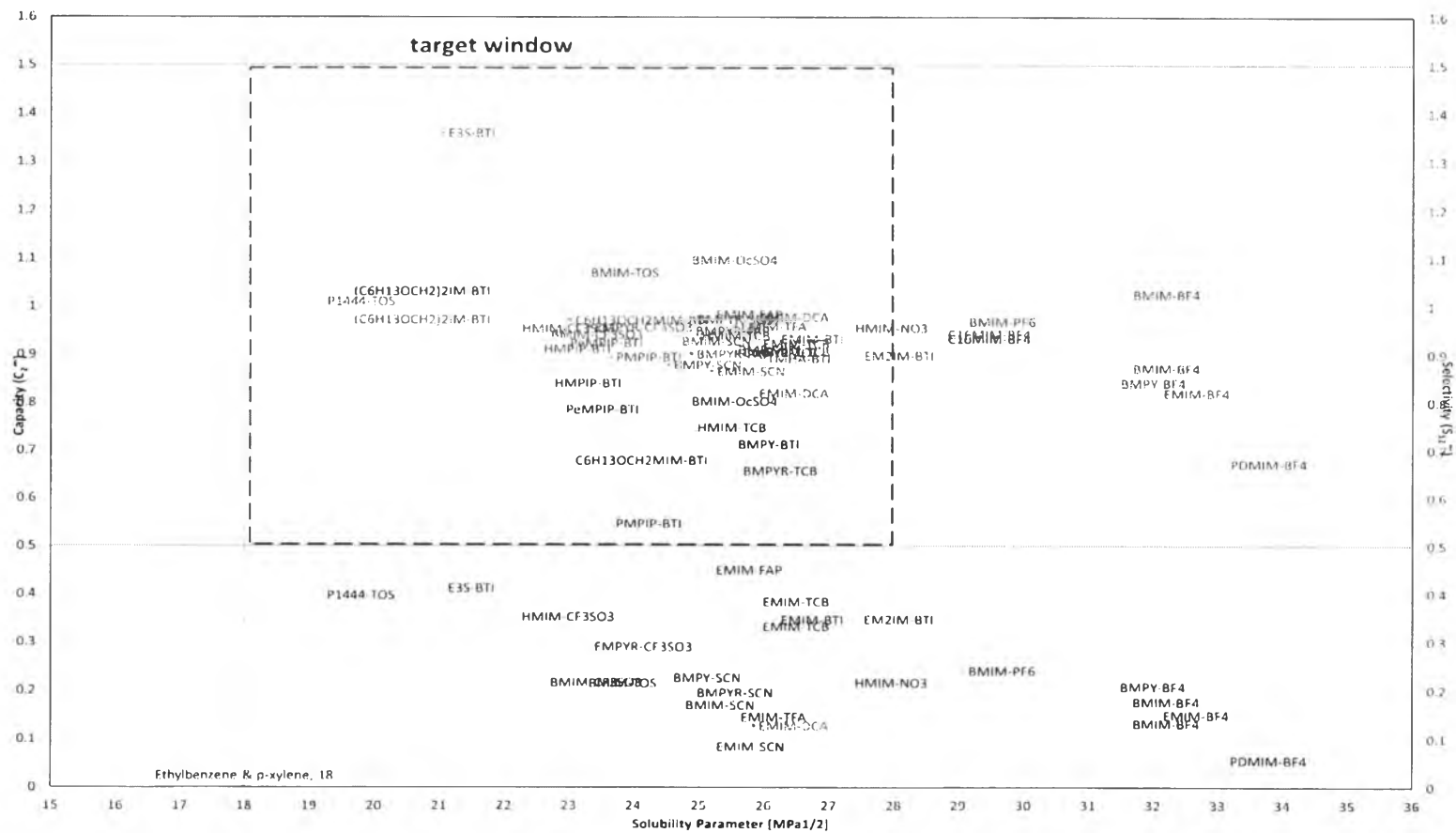

Figure 4.23 Hildebrand solubility parameters of ILs (x -axis) vs Capacity (C_2^∞) of ILs (primary y -axis) and Selectivity (S_{12}^∞) of ILs (secondary y -axis) of the EB + PX mixture. EB is the target solute.

4.2.2 Stage 2: Verification

4.2.2.1 *Verification of Mixture*

The data of vapor pressure and heat of vaporization of each pure component from ProPred program for four case studies, including water + ethanol, ethanol + hexane, benzene + hexane, and toluene + MCH mixtures, are tabulated in Tables 4.11 to 4.14, respectively. A plot of vapor pressure and heat of vaporization were plotted with temperatures of the four case studies are illustrated in Figures 4.23 and 4.24 for water + ethanol, Figures 4.25 to 4.26 for ethanol + hexane, Figures 4.27 to 4.28 for ethanol + benzene, and Figure 4.29 to 4.30 for toluene + MCH. These plots indicate that water, ethanol, benzene, and toluene are the suitable target solute for water + ethanol, ethanol + hexane, benzene + hexane, and toluene + MCH mixtures, respectively. For EB + PX mixture, since EP and PX are isomers, the calculated capacity (C_2^∞), selectivity (S_{12}^∞), and Hildebrand solubility parameters are very close to each other; hence, this screening technique is not suitable for the isomer mixtures. Therefore, there is no further discussion of the EP + PX mixture from this point. The VLE of each mixture as plotted using ICAS program showed the azeotrope point of water + ethanol in Figure 4.31, ethanol + hexane in Figure 4.32, benzene + hexane in Figure 4.33 and the close-boiling point of toluene + MCH in Figure 4.34. All results from the verification of mixture and ILs step are summarized in Table 4.15. In addition, original NRTL binary parameters of four case studies are given in Table D1 (Appendix).

Table 4.11 Vapor pressure and heat of vaporization with various temperature of water + ethanol mixture

T (K)	P°(kPa)		H _{vap} (kJ/mol)	
	water	ethanol	water	ethanol
341	34.82	67.10	42.10	39.15
343	37.72	73.08	42.01	38.97
345	40.80	79.49	41.92	38.79
347	44.06	86.35	41.83	38.6
349	47.50	93.69	41.73	38.41
351	51.11	101.54	41.64	38.23
Comparison	Ethanol > Water		Water > Ethanol	
Suitable Target solute	Water			

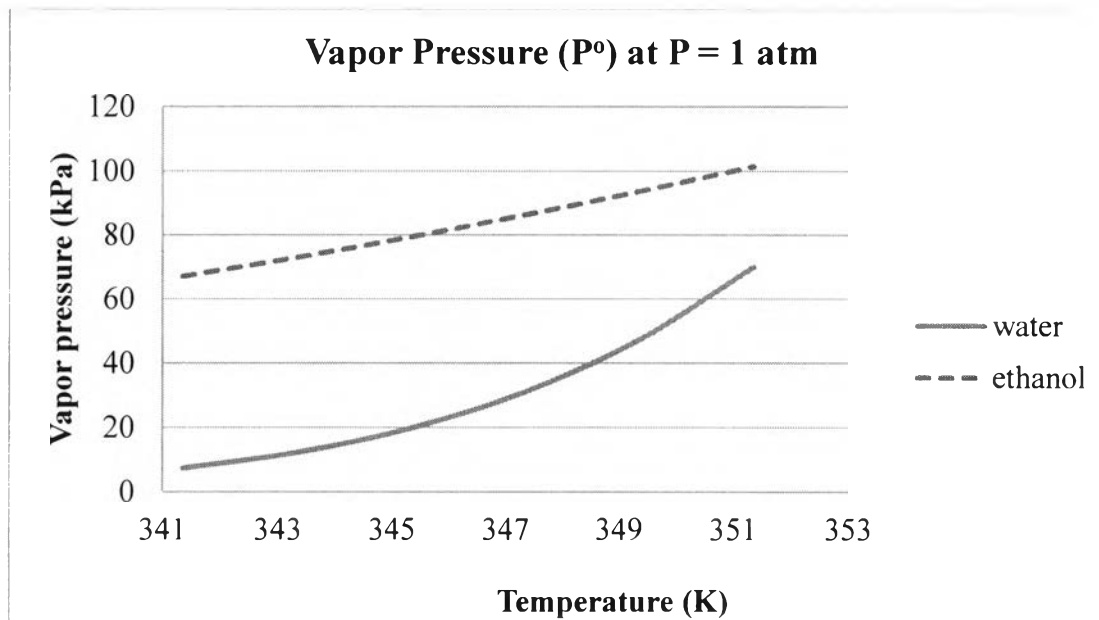

Figure 4.24 Graph between vapor pressure and temperature with various temperature of water + ethanol mixture.

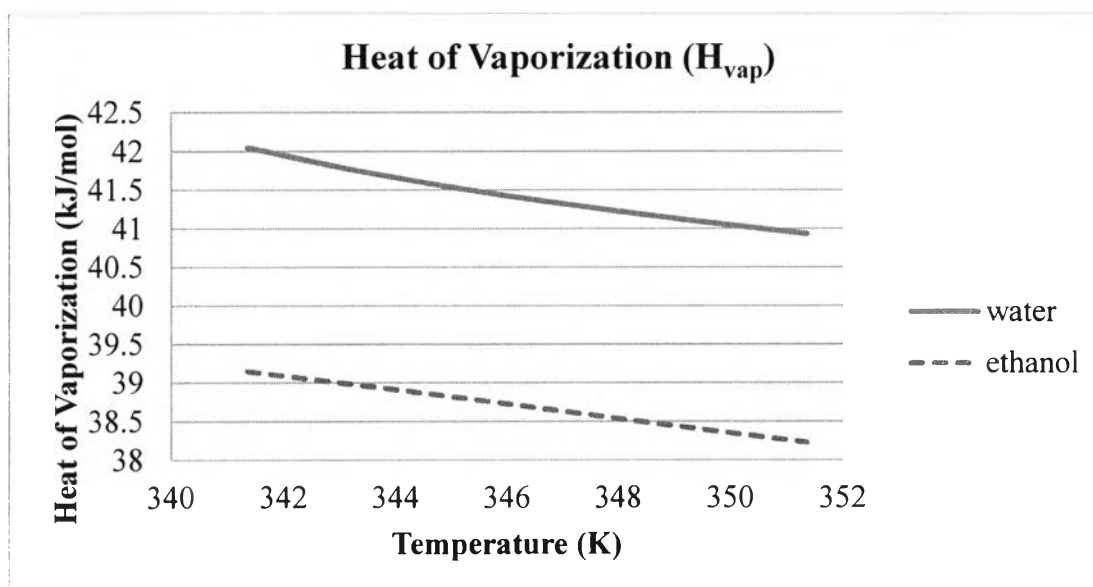

Figure 4.25 Graph between vapor pressure and temperature with various temperature of water + ethanol mixture.

Table 4.12 Vapor pressure and heat of vaporization with various temperature of ethanol + hexane mixture

T (K)	P ^o (kPa)		H _{vap} (kJ/mol)	
	hexane	hexane	ethanol	ethanol
341	101.32	28.87	39.15	67.10
343	107.89	28.75	38.97	73.08
345	114.79	28.63	38.79	79.49
347	122.03	28.50	38.6	86.35
349	129.63	28.38	38.41	93.69
351	137.58	28.25	38.23	101.54
Comparison	Hexane > Ethanol		Ethanol > Hexane	
Suitable Target solute	Ethanol			

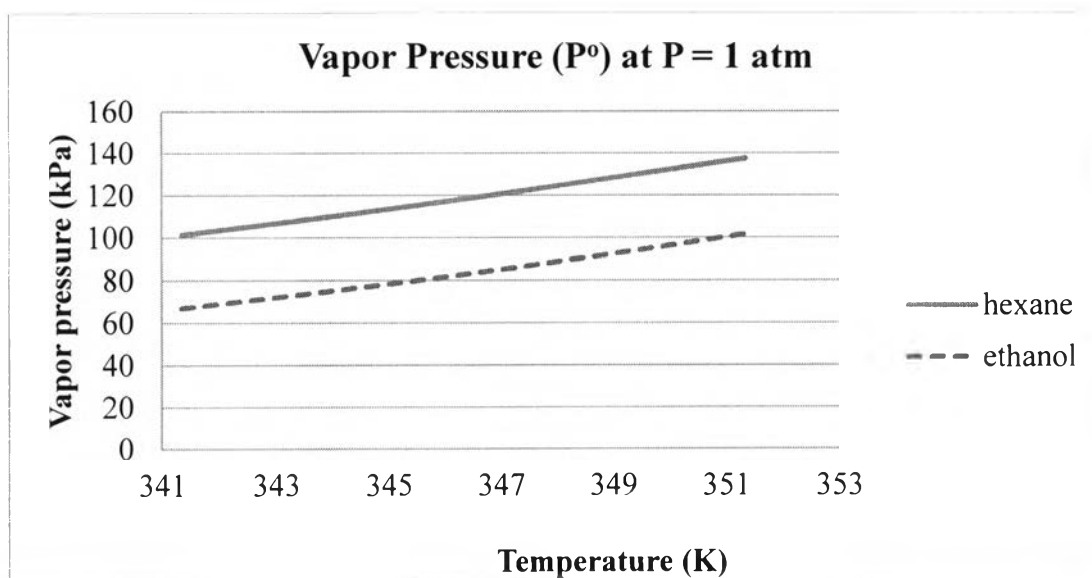

Figure 4.26 Graph between vapor pressure and temperature with various temperature of water + ethanol mixture.

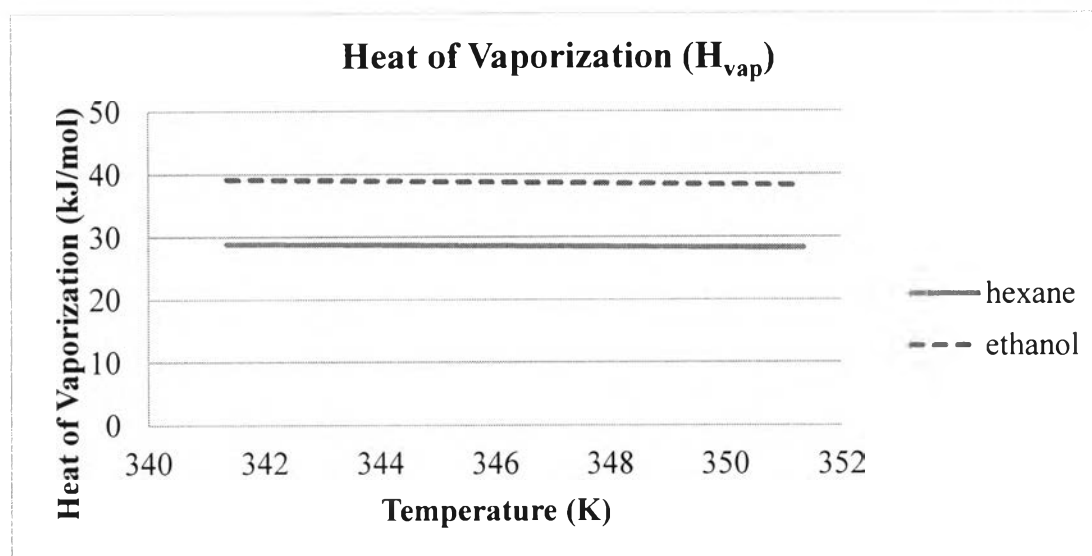

Figure 4.27 Graph between vapor pressure and temperature with various temperature of ethanol + hexane mixture.

Table 4.13 Vapor pressure and heat of vaporization with various temperature of ethanol + benzene mixture

T (K)	P ^o (kPa)		H _{vap} (kJ/mol)	
	hexane	benzene	hexane	benzene
343	28.75	31.03	107.89	73.82
345	28.63	30.93	114.79	78.78
347	28.5	30.84	122.03	84.01
349	28.38	30.74	129.62	89.51
351	28.25	30.64	137.58	95.29
Comparison	Ethanol > Benzene		Benzene > Ethanol	
Suitable Target solute	Benzene			

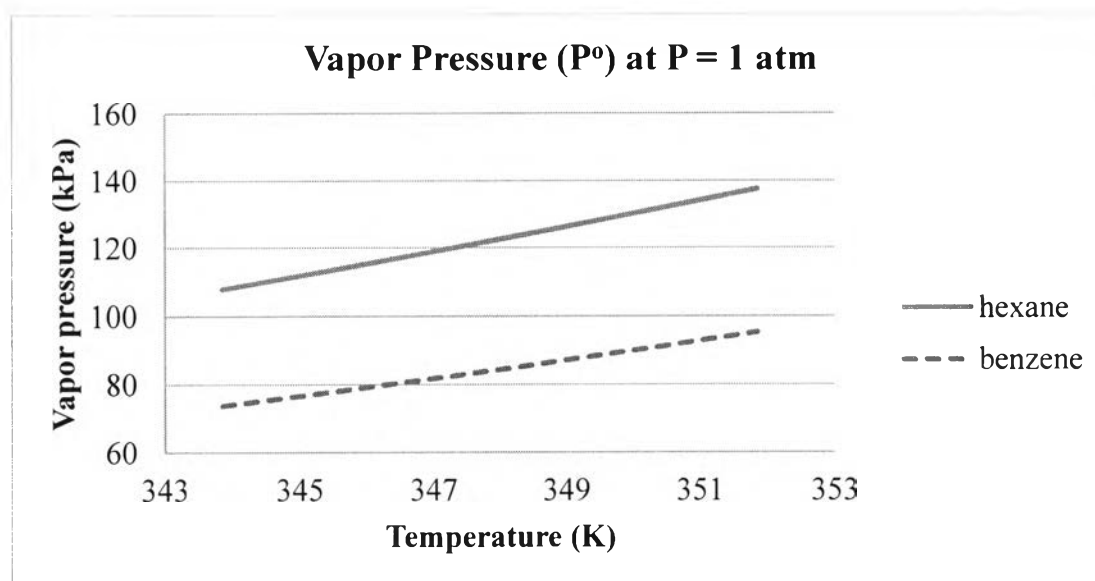

Figure 4.28 Graph between vapor pressure and temperature with various temperature of ethanol + benzene mixture.

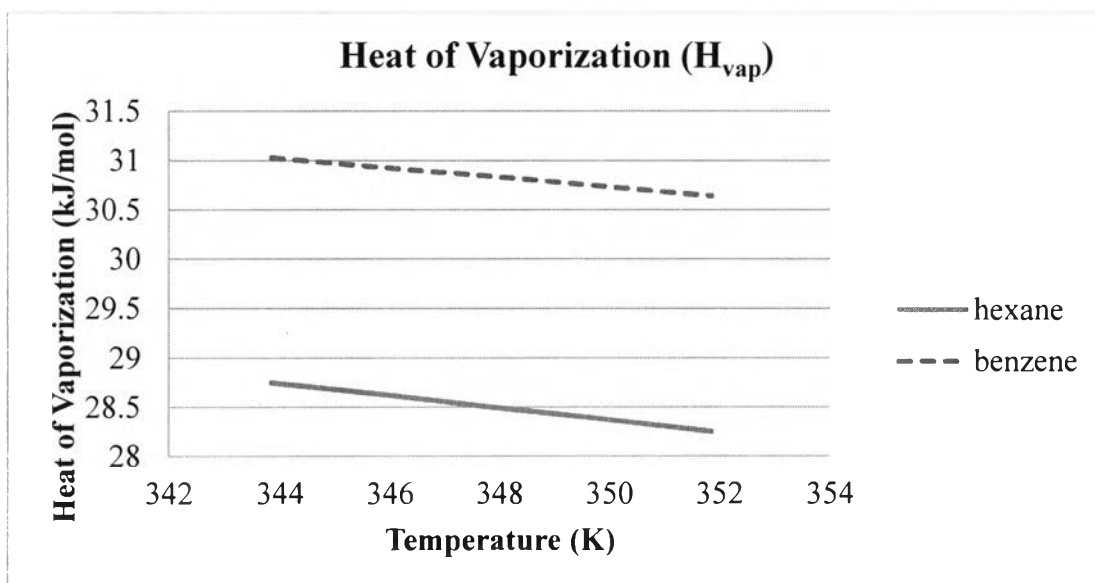

Figure 4.29 Graph between vapor pressure and temperature with various temperature of ethanol + benzene mixture.

Table 4.14 vapor pressure and heat of vaporization with various temperature of toluene + MCH mixture

T (K)	P ^o (kPa)		H _{vap} (kJ/mol)	
	MCH	toluene	MCH	toluene
343	32.97	21.50	33.20	36.46
345	35.32	23.19	33.11	36.36
347	37.82	24.99	33.02	36.26
349	40.45	26.89	32.92	36.16
351	43.23	28.92	32.83	36.06
Comparison	MCH > Toluene		Toluene > MCH	
Suitable Target solute	Toluene			

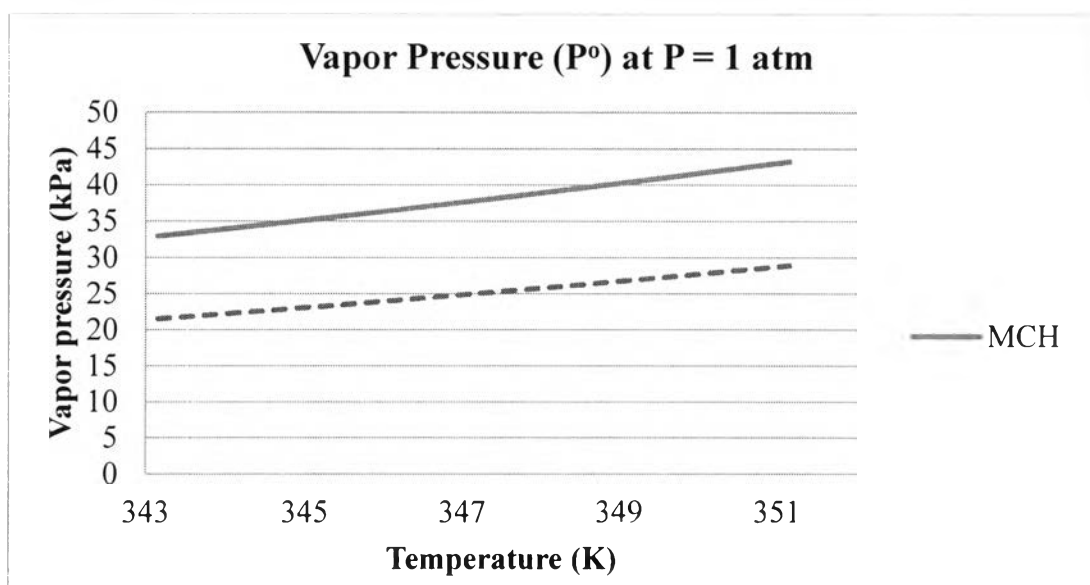

Figure 4.30 Graph between vapor pressure and temperature with various temperature of toluene + MCH mixture.

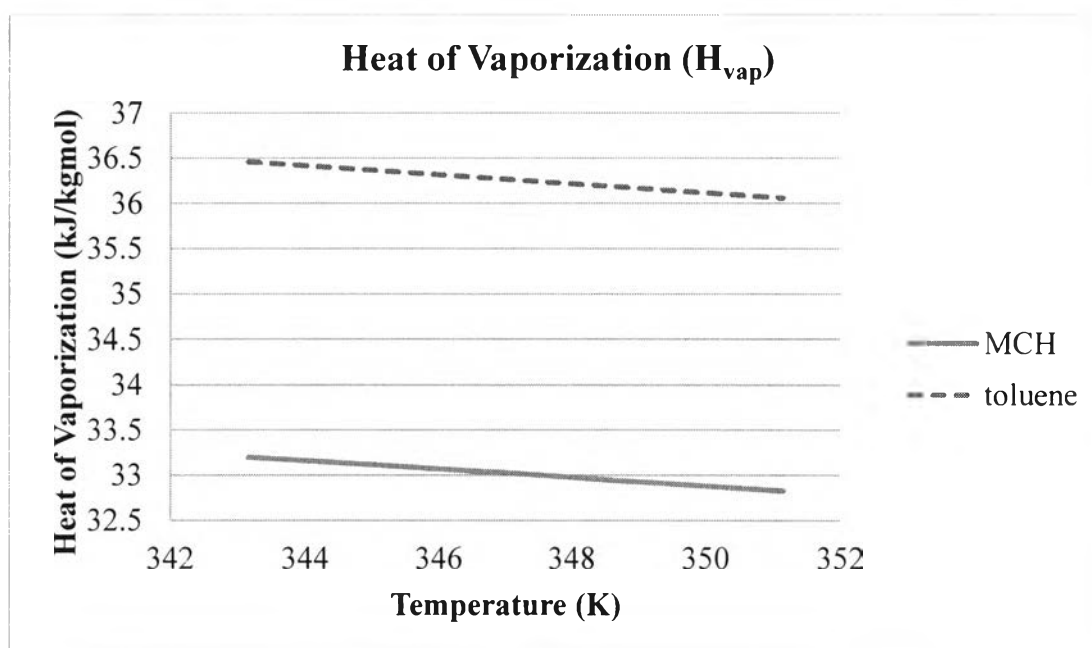

Figure 4.31 Graph between vapor pressure and temperature with various temperature of toluene + MCH mixture.

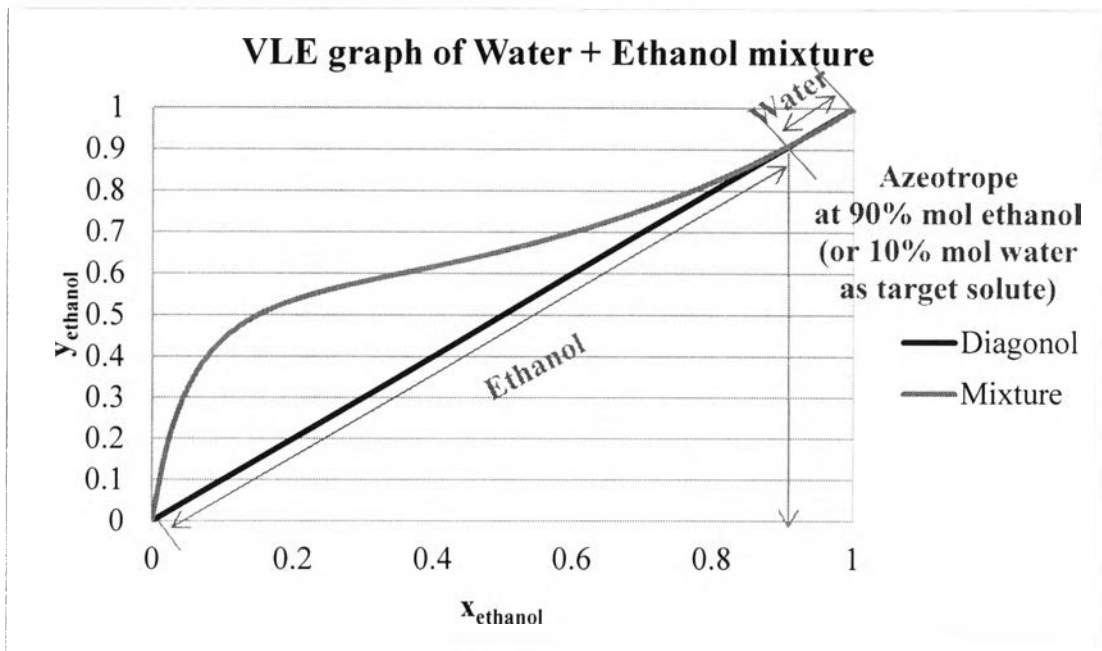

Figure 4.32 VLE graph of water + ethanol mixture.

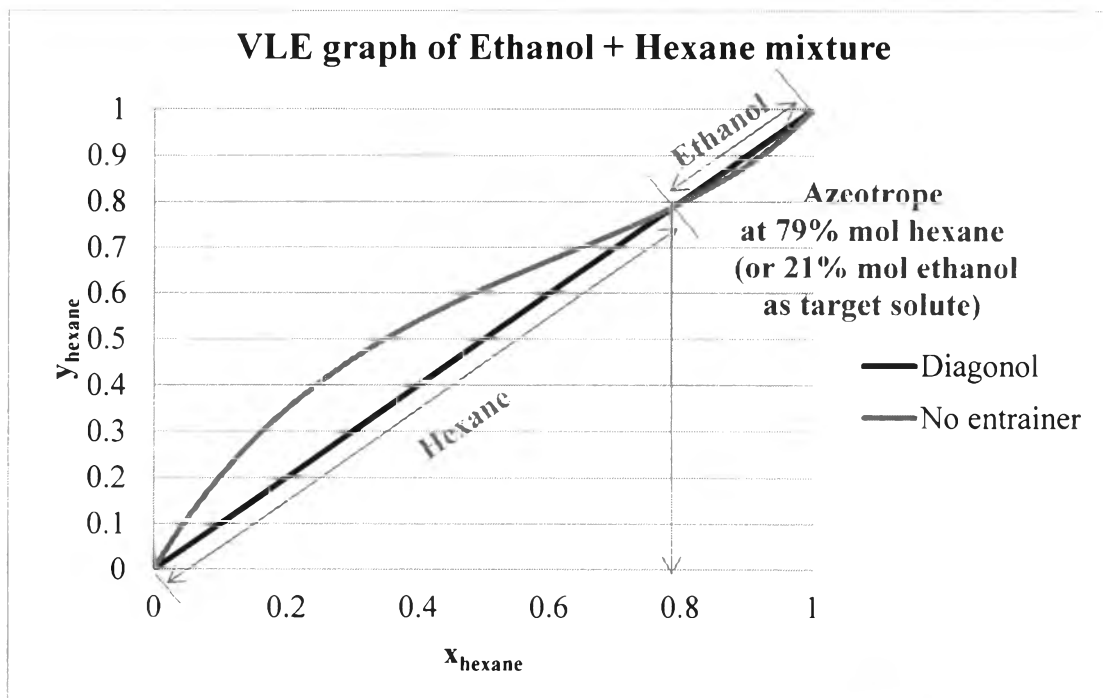

Figure 4.33 VLE graph of ethanol + hexane mixture.

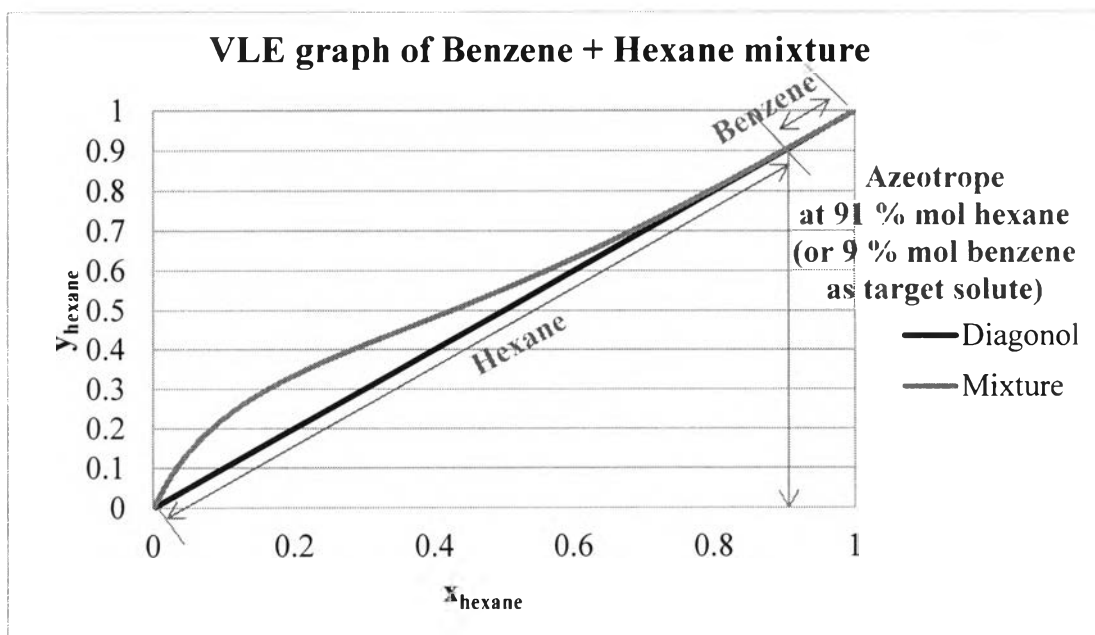

Figure 4.34 VLE graph of benzene + hexane mixture.

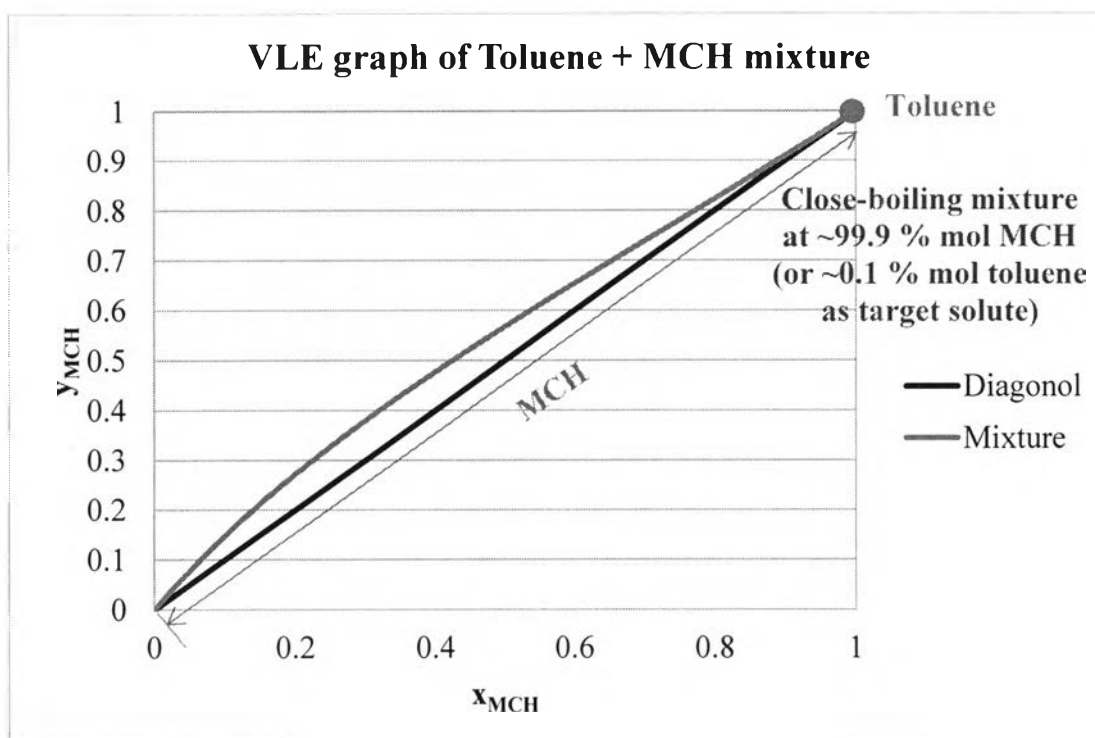

Figure 4.35 VLE graph of toluene + MCH mixture.

Table 4.15 Summarized results from verification of mixture

Mixture	ProPed Program		Suitable target solute	ICAS program
	P° (kPa)	H _{vap} (kJ/mol)		Type of mixture
Water + Ethanol	Ethanol > Water	Water > Ethanol	Water	Azeotropic mixture (at 90% mol ethanol or 10% mol water)
Ethanol + Hexane	Hexane > Ethanol	Ethanol > Hexane	Ethanol	Azeotropic mixture (at 79% mol ethanol or 21% mol water)
Benzene + Hexane	Ethanol > Benzene	Benzene > Ethanol	Benzene	Azeotropic mixture (at 91% mol ethanol or 9% mol water)
Toluene + MCH	MCH > Toluene	Toluene > MCH	Toluene	Close-boiling mixture (at ~99.9 % mol MCH or ~0.1 % mol toluene)

4.2.2.2 Verification of IL

The original NRTL binary parameters of each mixture are given in Table F1-F4 (Step 1) and critical properties of ILs are listed in Table F5-F11 (Step2). To ensure the separation capability for breaking of the azeotrope or increasing relative volatility of all feasible ILs, a VLE graph using ICAS program was employed to plot the VLE of the azeotrope-IL at different IL concentration as shown in Figures 4.35 to 4.37 for water + ethanol, Figures 4.40 to 4.41 for ethanol + hexane, Figures 4.40 to 4.41 for benzene + hexane and Figures 4.42 to 4.43 for toluene + MCH. A summary of these results is tabulated in Table 4.16. One of the criteria for screening feasible ILs in this step includes the limitation of available NRTL binary parameters from experimental data in several literatures. For instance, only 3 out of 9 feasible IL candidates of the water + ethanol system can pass the screening in this step, consisting of [MMIM][DMP], [EMIM][DCA], and

[EMIM][EtSO₄]. For ethanol + hexane, 2 out of 7 ILs were selected, including [EMIM][BTI] and [BMIM][BTI]. Two ILs, including [EMIM][BTI] and [EMIM][EtSO₄] were selected in benzene + hexane mixture, while two ILs (e.g. [HMIM][BTI] and [HMIM][TCB]) were selected in toluene + MCH mixture. Nevertheless, since new ILs have been continuously reported in literature, other new feasible IL candidates may pass this screening criteria, hence, the updated experimental data of ILs should be done before applying this screening technique to ensure all possible ILs are considered.

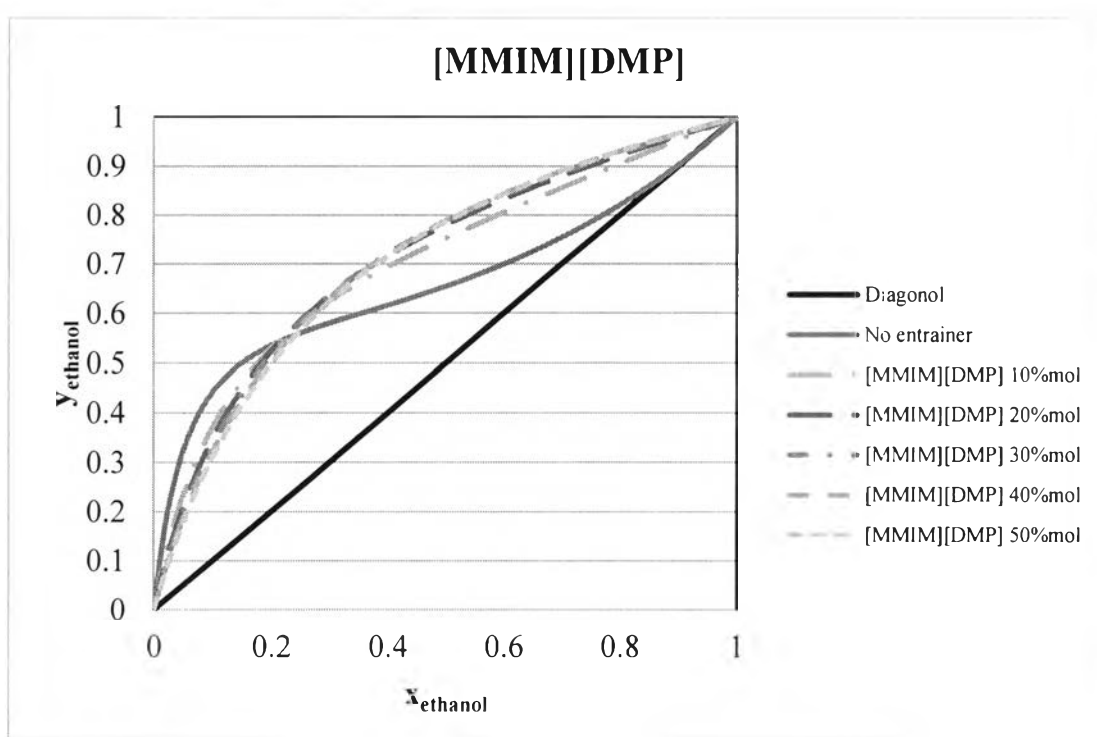

Figure 4.36 VLE graph of [MMIM][DMP] in water + ethanol mixture.

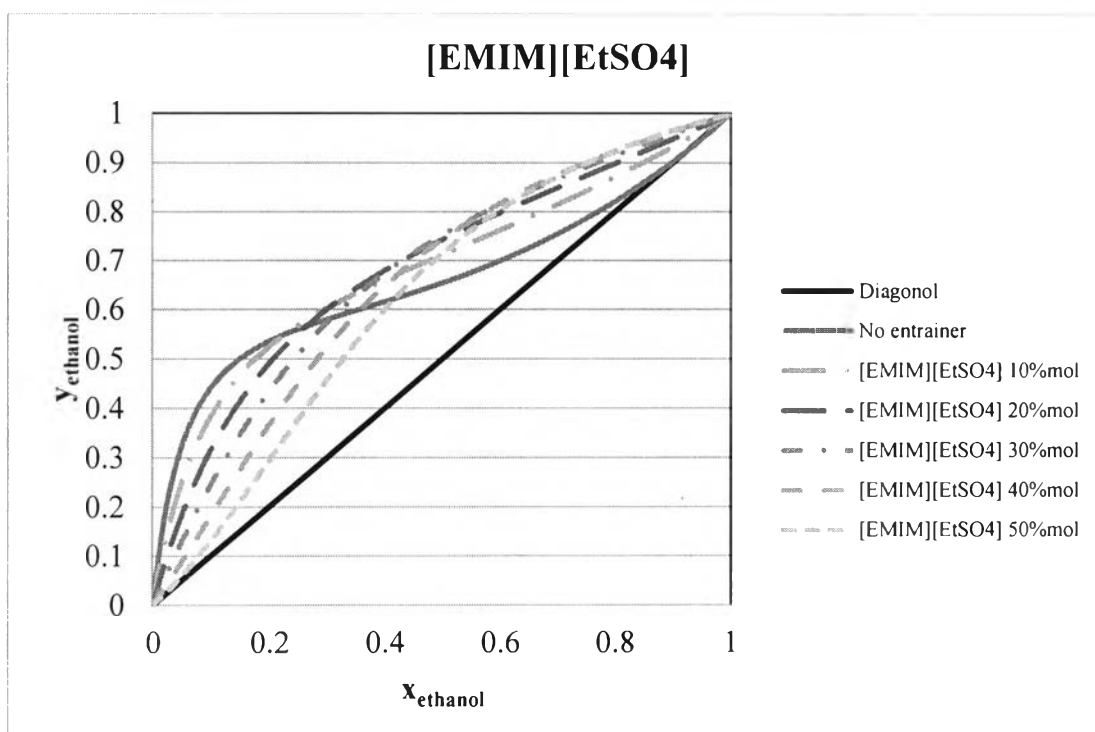

Figure 4.37 VLE graph of [EMIM][EtSO4] in water + ethanol mixture.

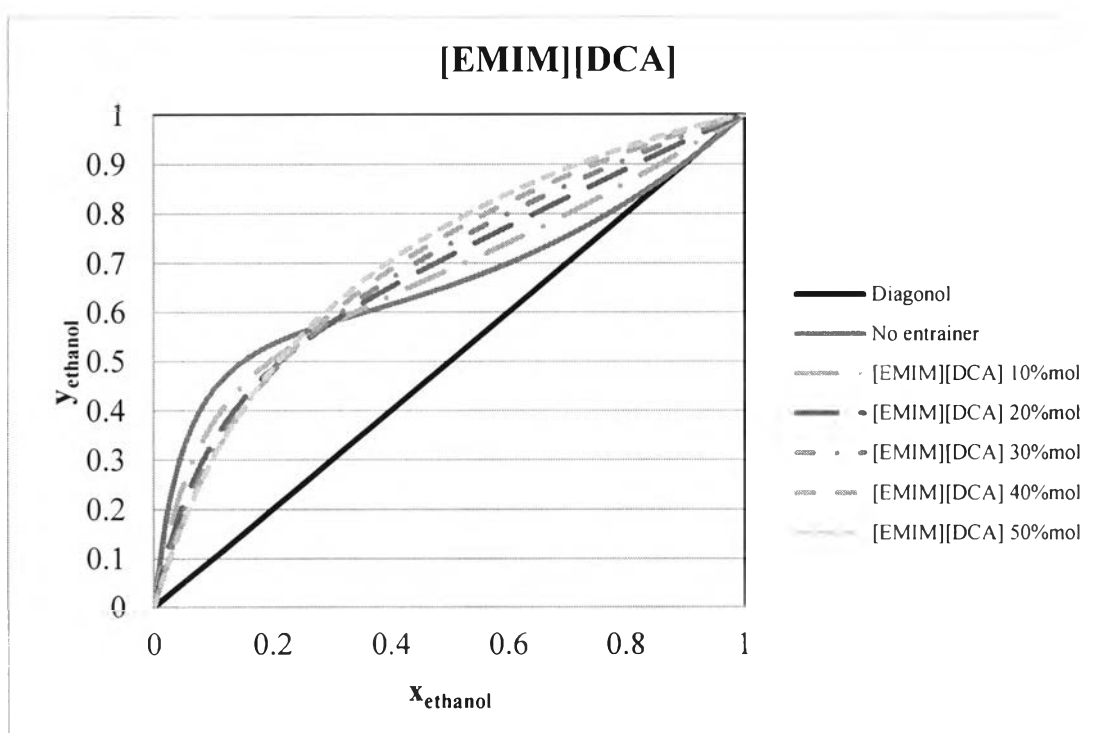

Figure 4.38 VLE graph of [EMIM][DCA] in water + ethanol mixture.

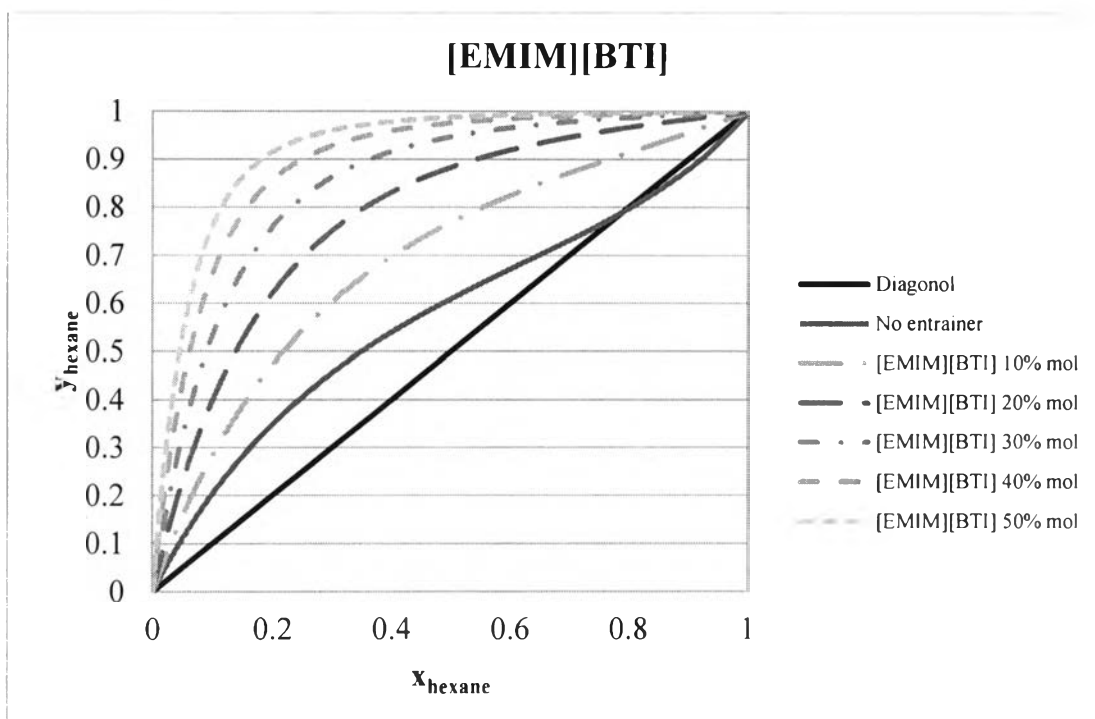

Figure 4.39 VLE graph of [EMIM][BTI] in ethanol + hexane mixture.

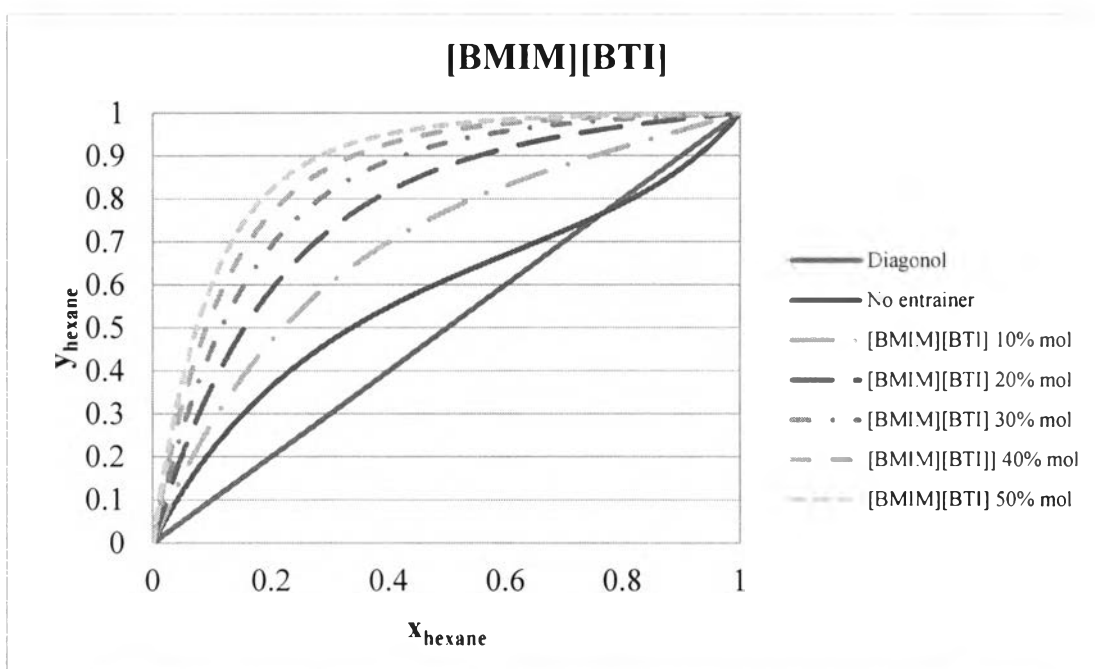

Figure 4.40 VLE graph of [BMIM][BTI] in ethanol + hexane mixture.

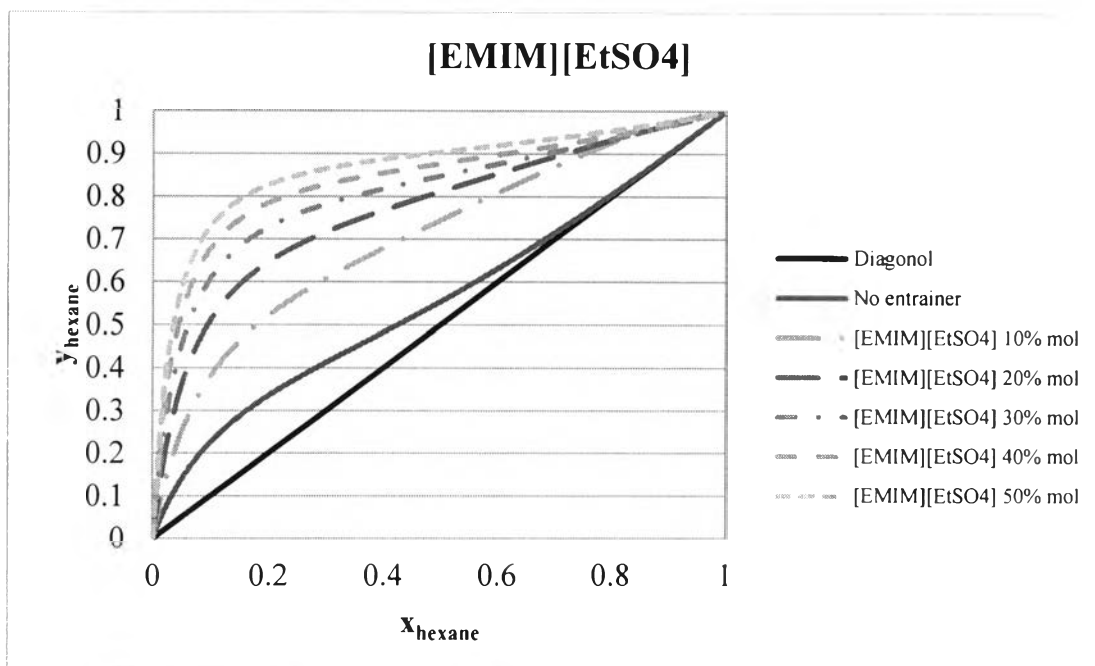

Figure 4.41 VLE graph of [EMIM][EtSO4] in benzene + hexane mixture.

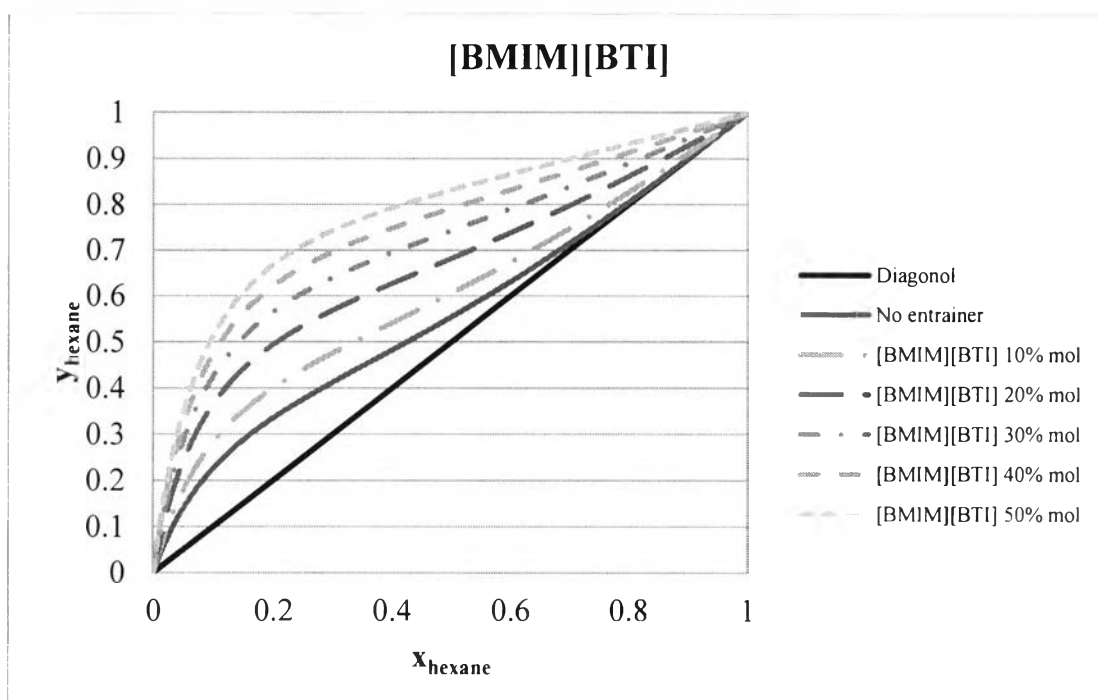

Figure 4.42 VLE graph of [BMIM][BTI] in benzene + hexane mixture.

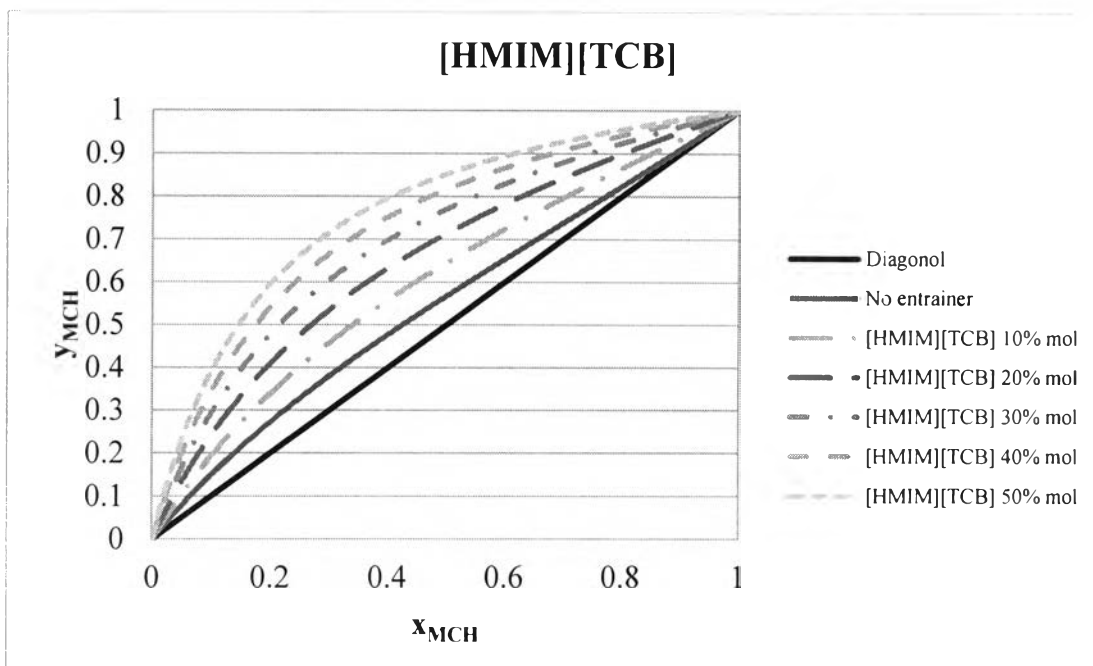

Figure 4.43 VLE graph of [HMIM][TCB] in toluene + MCH mixture.

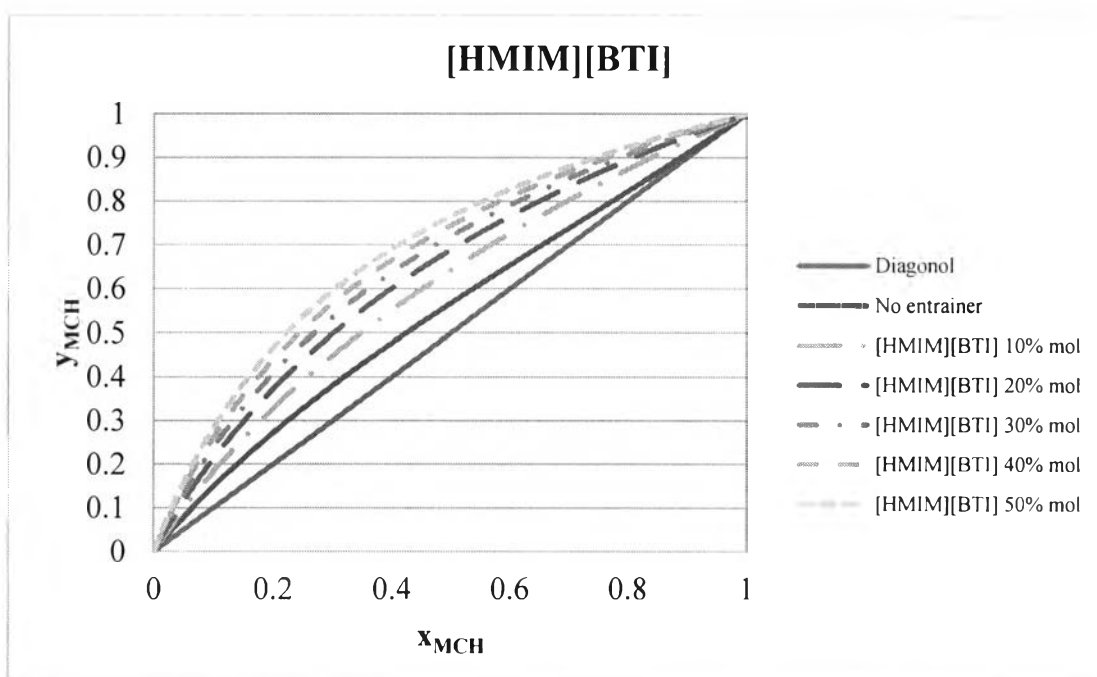

Figure 4.44 VLE graph of [HMIM][BTI] in toluene + MCH mixture.

Table 4.16 Separation capability of feasible IL candidates for comparison

Mixture	All feasible IL candidates from IL pre-selection step	Feasible IL candidates for comparison	Separation capability of feasible IL candidates for comparison from VLE graphs using ICAS program
Water + Ethanol	9	3	[MMIM][DMP], [EMIM][DCA], and [EMIM][EtSO ₄] can break azeotrope
Ethanol + Hexane	8	2	[EMIM][BTI] and [BMIM][BTI] can break azeotrope
Benzene + Hexane	34	2	[EMIM][EtSO ₄] and [EMIM][BTI] can break azeotrope
Toluene + MCH	11	2	[HMIM][TCB] and [HMIM][BTI] can increase the relative volatility

4.2.3 Stage 3: Comparison

4.2.3.1 VLE Comparison

VLE comparison graphs for the separation capability of ILs at the same IL concentration were generated to observe the best IL in each azeotropic mixture. As a technical comparison, a bell-shaped curve should be observed in the VLE plot for a good separation, indicating excellent performance of the best IL. For ethanol + water mixture as shown in Figure 4.44, [MMIM][DMP] is the most efficient IL for breaking of azeotrope comparing among three ILs at 40% mol IL. For the ethanol + hexane mixture, at 30 % mol IL, [EMIM][BTI] shows a better performance as compared to [BMIM][BTI] as shown in Figure 4.45. [EMIM][EtSO₄] in benzene + hexane mixture is able to perfectly break azeotrope as compared to [EMIM][BTI] as shown in Figure 4.46. In the toluene + MCH mixture,

[HMIM][TCB] can efficiently increase the relative volatility of close-boiling mixture as shown in Figure 4.47. All results for a comparison of separation capability of ILs are summarized in Table 4.17. It is noted that the suitable IL concentration was selected from the performance of IL to separate the azeotropic mixture, i.e. the concentration of IL that gave a bell shape VLE plot with a perfect separation.

Table 4.17 Summarized results of separation capability of ILs from VLE graphs

Mixture	Concentration of ILs for comparison	Comparison of separation capability
Water + Ethanol	40% mol	[MMIM][DMP] > [EMIM][DCA] \approx [EMIM][EtSO ₄]
Ethanol + Hexane	30% mol	[EMIM][BTI] > [BMIM][BTI]
Benzene + Hexane	30% mol	[EMIM][EtSO ₄] > [EMIM][BTI]
Toluene + MCH	30% mol	[HMIM][TCB] > [HMIM][BTI]

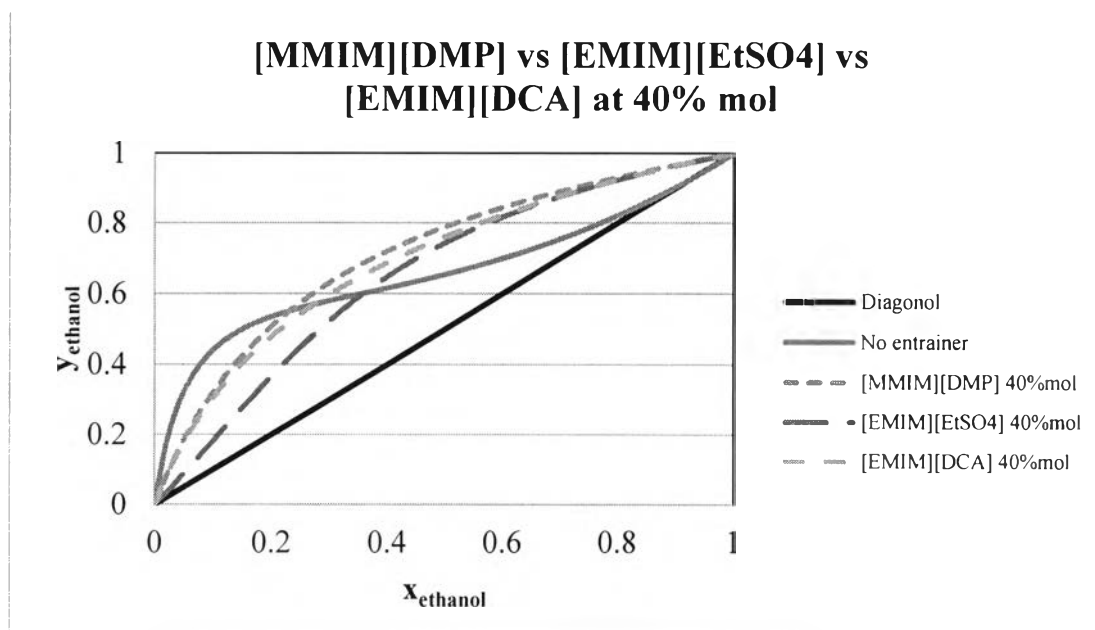

Figure 4.45 VLE comparison graph for separation capability of ILs in water + ethanol mixture.

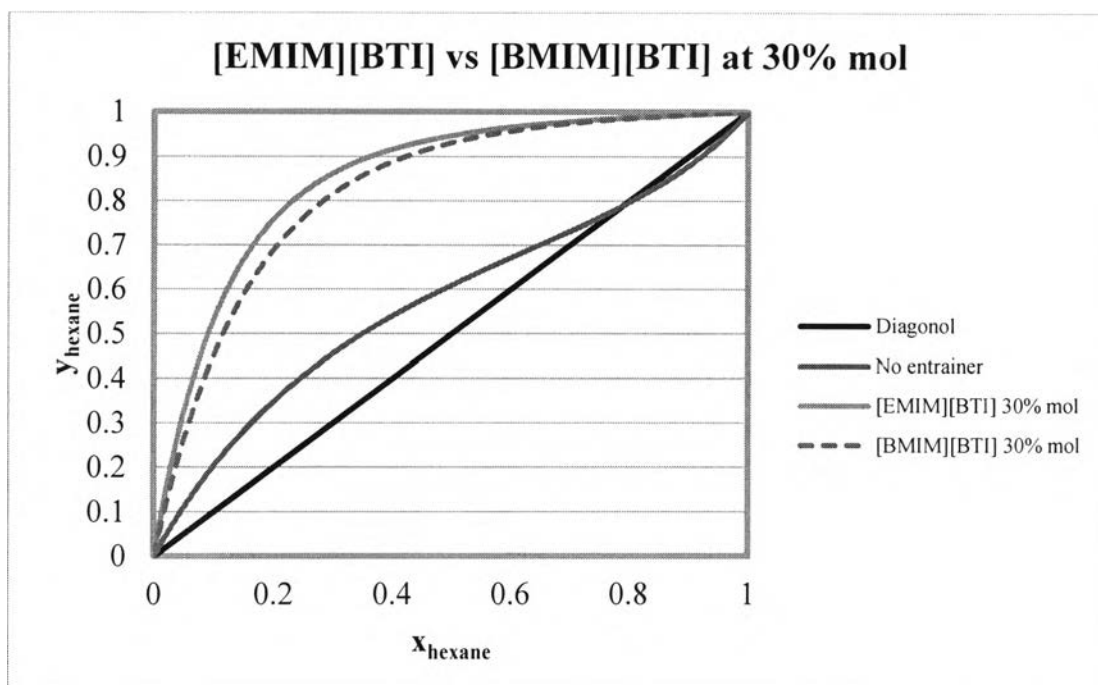

Figure 4.46 VLE comparison graph for separation capability of ILs in ethanol + hexane mixture.

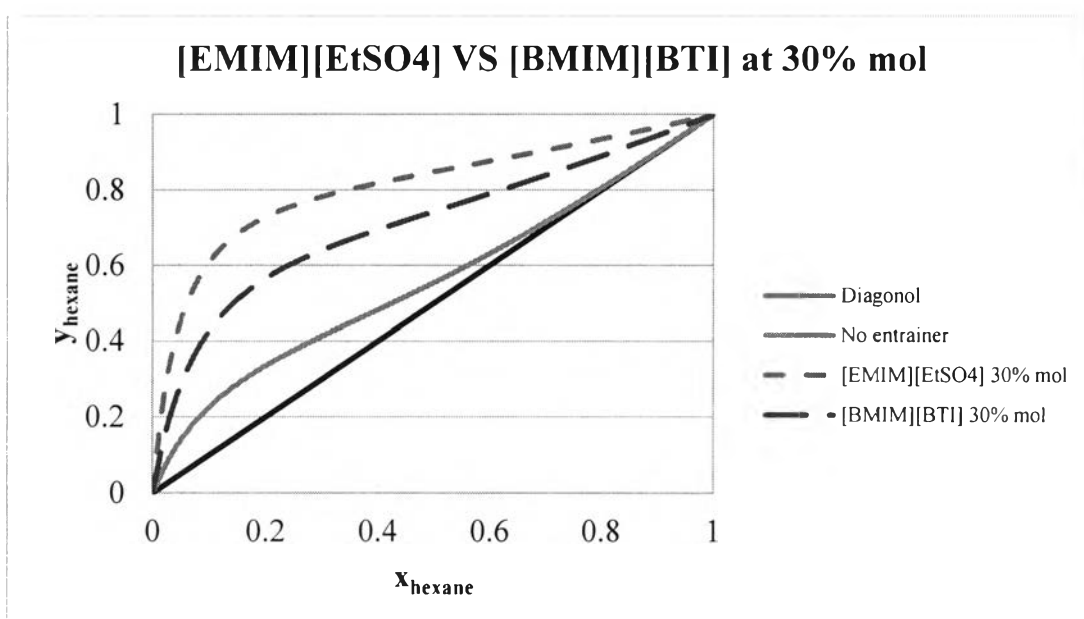

Figure 4.47 VLE comparison graph for separation capability of ILs in benzene + hexane mixture.

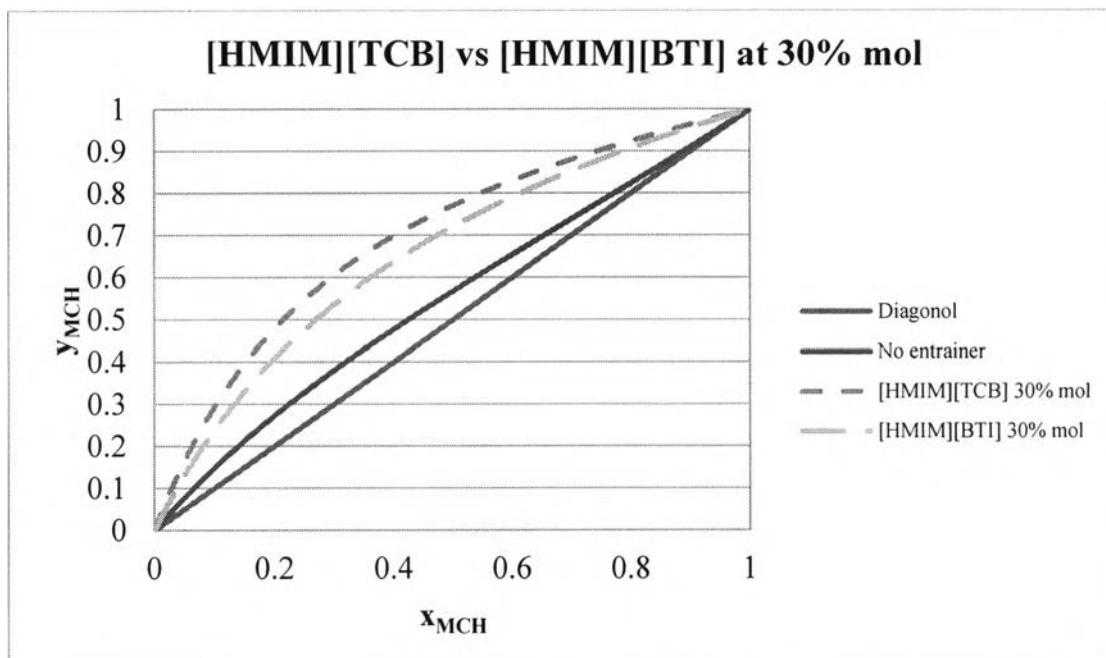

Figure 4.48 VLE comparison graph for separation capability of ILs in toluene + MCH mixture.

4.2.3.2 Simulation Comparison

Even though, feasible IL candidates were roughly compared to each other through VLE graphs in the previous step, the design of simulation process is necessary to confirm the separation capability of each entrainer to achieve all design specifications and to compare each entrainer in terms of minimum energy requirement and solvent usages at fixed target purity (≥ 99.5) of all products. PROII was employed to run the simulation process in this work. Commonly the extractive distillation of the conventional solvent process consists of an extractive distillation column (EDC) and a solvent recovery column (SRC). Hence, a conventional solvents process of each mixture must be created as a base case in each azeotropic system and then compared to the IL processes. In the solvent recovery technology in IL process, flash evaporation technique was selected instead of SRC because a boiling temperature of IL is generally higher than other solute components, providing the ease to separate IL from the solute in a flash evaporator. However, the operating temperature in the flash separator must not exceed the degradation temperature of

each IL as listed Table 4.18. All significant parameters from PROII are illustrated in a process flowsheet in Figures 4.48 to 4.51 for water + ethanol mixture, Figure 4.54 to 4.56 for ethanol + hexane mixture, Figure 4.59 to 4.60 for benzene + hexane mixture, and Figure 4.64 to 4.66 for toluene + MCH. Furthermore, the details of energy requirement and solvent usages in each mixture presented in Table 4.19 (or Figure 4.52 and 4.53) for water + ethanol mixture, Table 4.20 (or Figure 4.57 and 4.58) for ethanol + hexane mixture, Table 4.21 (or Figure 4.62 and 4.63) for benzene + hexane mixture, and Table 4.22 (or Figure 4.67 and 4.68) for toluene + MCH mixture. All results were summarized over into Table 4.23 at the end of this part. Beyond this information here, the in-depth details of simulation process from PROII including unit operation property tables (e.g. distillation column, flash evaporation, pump, and heat exchanger) and stream table for all case studies were overall enclosed in appendix G.

Table 4.18 Degradation temperature of feasible IL candidates for comparison

ILs	Degradation temperature (°C)	Reference
[MMIM][DMP]	274	Salgado <i>et al.</i> (2013)
[EMIM][DCA]	240	Hernández (2013)
[EMIM][EtSO ₄]	251	Salgado <i>et al.</i> (2013)
[EMIM][BTI]	287	Heym <i>et al.</i> (2011)
[BMIM][BTI]	271	Heym <i>et al.</i> (2011)
[HMIM][BTI]	620	Crosthwaite <i>et al.</i> (2005)
[HMIM][TCB]	170	(Hernández (2013))

- Water + Ethanol mixture

A feed stream of 1,000 kmol/h (1:4 mole ratio of ethanol: water) of azeotropic mixture is fed to the EDC at atmospheric condition (100 kPa, 25°C). Before entering the EDC at the 23th stage of EDC, the temperature was adjusted to 78°C to bring the temperature close to the boiling point of ethanol but still consist of a single phase feed stream. EG or the conventional solvent of this system is fed at 210 kmol/h to the 4th stage of the EDC. The pressure of the EDC is maintained at atmospheric pressure or 100 kPa, while the number of theoretical stage is set at 30. The purity of the ethanol product at the top of EDC is specified at the target purity of 99.8% mol and a flowrate of 200 kmol/h. The condition of the ethanol product stream is then adjusted to a sale condition at 100 kPa and 30°C). The bottom product of the EDC consisting of water mixed with EG is fed to the 6th stage of the SRC. The number of theoretical stage of the SRC is set at 15 and SRC is operated under vacuum (20 kPa). 800 kmol/h of water can be separated at the target purity of 99.6% mol at the top of SRC. The water product stream is then adjusted to the suitable condition for sales (100 kPa, 30°C). EG is recovered as a bottom product of SRC at a purity of 99.9% mol at 210 kmol/hr. An EG make-up stream is fed and combined with the recycled EG before feeding back to the EDC. An EG process flowsheet is illustrated in Figure 4.48.

In cases of three feasible IL candidates (i.e. [MMIM][DMP], [EMIM][DCA], and [EMIM][EtSO₄]), the IL processes were successfully simulated as shown in Figures 4.49 to 4.51. IL processes followed the same EDC condition as previously simulated in the EG process and the same suitable condition for sales of every product at the same target purity. In addition, flash evaporation at vacuum pressure (1 kPa) was selected instead of SRC in all IL processes. This high vacuum condition was selected because of the stringent target purity in every product. Whether the target purity was altered to lower quality, the pressure of flash evaporation might have been possibly higher. Nevertheless, the temperature of flash evaporation must be not over the degradation temperature of each IL listed in Table 4.18. To conclude, all significant parameters have flexibility relied on the fixed target purity for a comparison in primary and the limitation of each IL property. Beyond that, water product from flash evaporation must be

condensed from a vapor phase to a liquid phase at constant pressure and then adjusted again to the suitable condition for sales (100 kPa, 30°C). EG process showed the highest energy requirement (6.3 MW) and solvent usage (210 kmol/h) and were higher than other three IL processes; [EMIM][DCA] (5.7 MW, 90 kmol/h), [EMIM][EtSO₄] (5.0 MW, 60 kmol/h), and [MMIM][DMP] (4.8 MW, 40 kmol/h). [EMIM][DCA] showed the highest energy requirement and solvent usage among all IL processes, whereas [MMIM][DMP] performed the least energy requirement and solvent usage, hence, the best ILs in water + ethanol mixture. [MMIM][DMP] is the shortest molecule that tends to have a polarity with high hydrophilic and good interaction with water compared to the other ILs. However, all results were summarized in Table 4.19 (or Figures 4.52 and 4.53) and also the in-depth details of simulation process from PROII including unit operation property tables (e.g. distillation column, flash evaporation, pump, and heat exchanger) and stream table for water + ethanol mixture were enclosed in Figure G1 to G4 and Table G1 to G19.

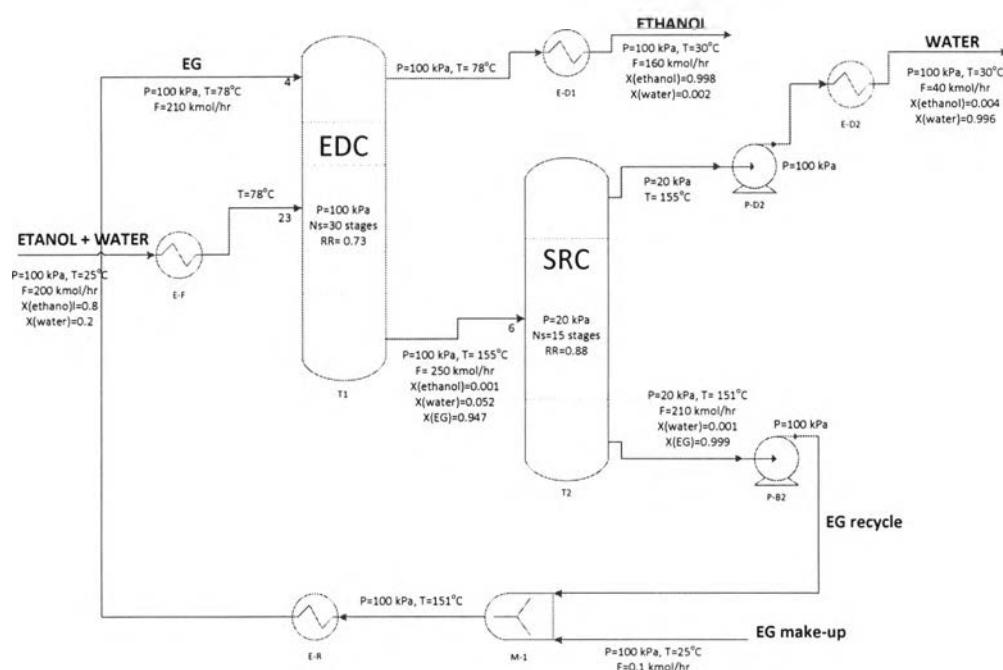

Figure 4.49 CS process flowsheet in water + ethanol mixture using EG.

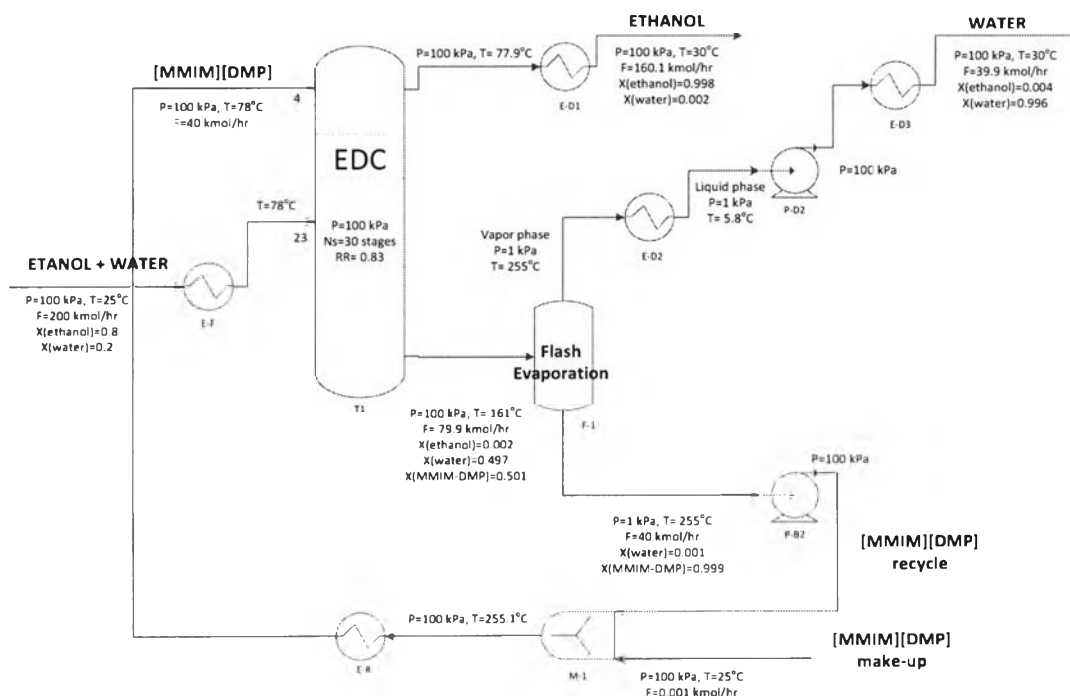

Figure 4.50 IL process flowsheet in water + ethanol mixture using [MMIM][DMP].

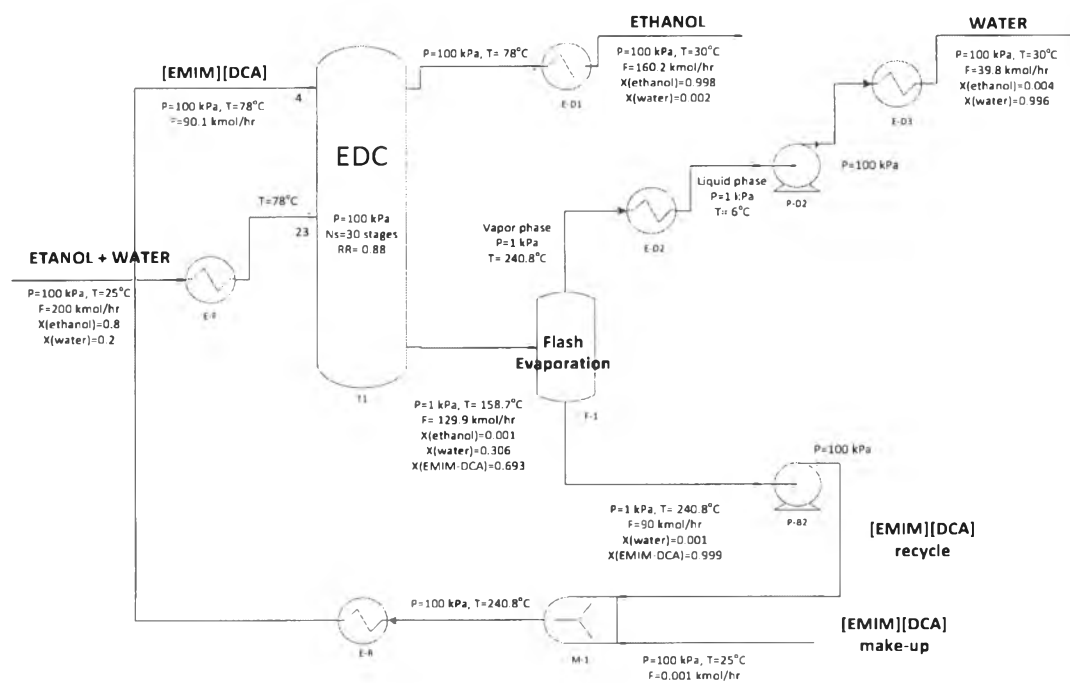

Figure 4.51 IL process flowsheet in water + ethanol mixture using [EMIM][DCA].

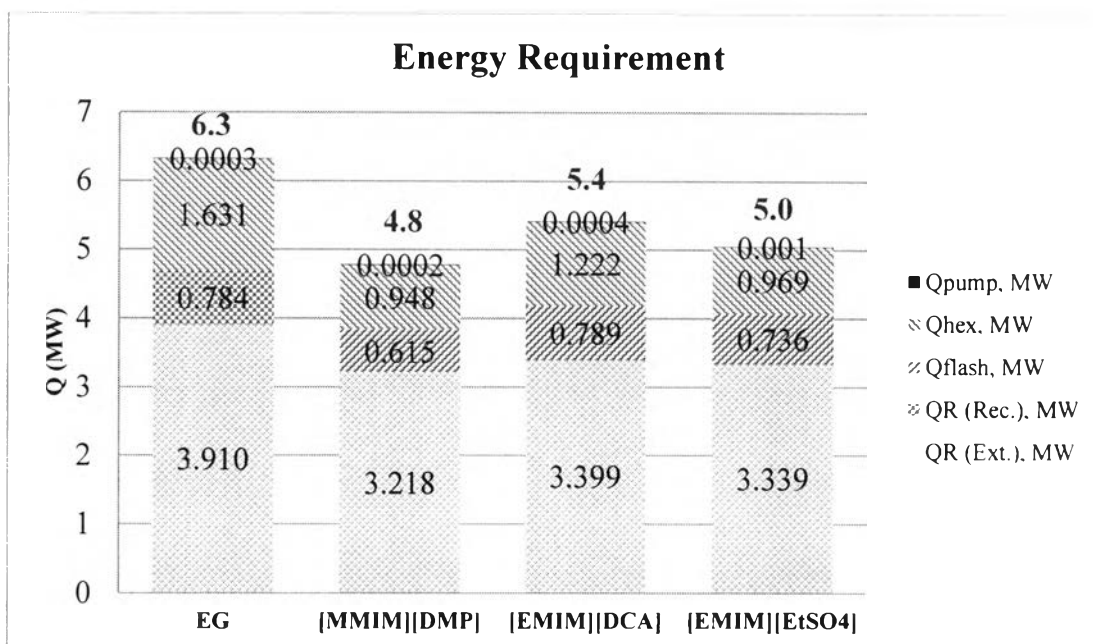

Figure 4.53 Summarized results of energy requirement in water + ethanol mixture.

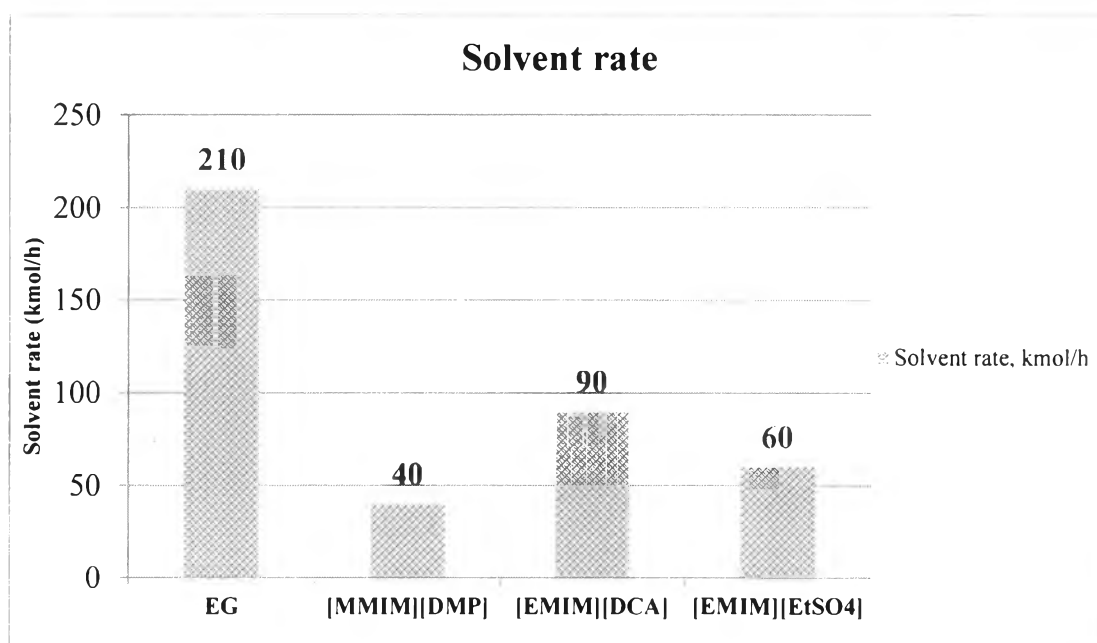

Figure 4.54 Summarized results of solvent rate in water + ethanol mixture.

- Ethanol + Hexane mixture

A feed stream of 1,000 kmol/h (3:7 mole ratio of hexane: ethanol) of azeotropic mixture is fed to the EDC at atmospheric condition (100 kPa, 25°C). Before entering the EDC at the 5th stage of EDC, the temperature was adjusted to 59°C to bring the temperature close to the boiling point of hexane but still consist of a single phase feed stream. sulfolane or the conventional solvent of this system is fed at 1,500 kmol/h to the 2th stage of the EDC. The pressure of the EDC is maintained at atmospheric pressure or 100 kPa, while the number of theoretical stage is set at 7. The purity of the hexane product at the top of EDC is specified at the target purity of 99.8% mol and a flowrate of 300 kmol/h. The condition of the hexane product stream is then adjusted to a sale condition at 100 kPa and 30°C. The bottom product of the EDC consisting of ethanol mixed with sulfolane is fed to the 3th stage of the SRC. The number of theoretical stage of the SRC is set at 5 and SRC is operated under vacuum (75 kPa). 700 kmol/h of ethanol can be separated at the target purity of 99.9% mol at the top of SRC. The ethanol product stream is then adjusted to the suitable condition for sales (100 kPa, 30°C). sulfolane is recovered as a bottom product of SRC at a purity of 99.99% mol at 1,500 kmol/h. A sulfolane make-up stream is fed and combined with the recycled sulfolane before feeding back to the EDC. An sulfolane process flowsheet is illustrated in Figure 4.54.

In case of two feasible IL candidates (i.e. [EMIM][BTI] and [BMIM][BTI]), the IL processes were successfully simulated as shown in Figures 4.55 to 4.56. IL processes followed the same EDC condition as previously simulated in the sulfolane process and the same suitable condition for sales of every product at the same target purity. In addition, flash evaporation at vacuum pressure (0.1 kPa) was selected instead of SRC in all IL processes. This high vacuum condition was selected because of the stringent target purity in every product. Whether the target purity was altered to lower quality, the pressure of flash evaporation might have been possibly higher. Nevertheless, the temperature of flash evaporation must be not over the degradation temperature of each IL listed in Table 4.18. To conclude, all significant parameters have flexibility relied on the fixed target purity for a comparison in primary and the limitation of each IL property. Beyond that, ethanol product from flash evaporation must be condensed from a vapor phase

to a liquid phase at constant pressure and then adjusted again to the suitable condition for sales (100 kPa, 30°C). Sulfolane process showed the highest energy requirement (57.4 MW) and solvent usage (1,500 kmol/h) and were higher than other two IL processes; [BMIM][BTI] (35.7 MW, 1,100 kmol/h), and [EMIM][BTI] (32.3 MW, 1,100 kmol/h). [BMIM][BTI] showed the higher energy requirement than [EMIM][BTI] but the same as solvent usage, hence, [EMIM][BTI] became the best ILs in ethanol + hexane mixture. [EMIM][BTI] is the shortest molecule that tends to have a polarity with high hydrophilic and good interaction with ethanol than [BMIM][BTI]. However, all results were summarized in Table 4.20 (or Figures 4.57 and 4.58) and also the in-depth details of simulation process from PROII including unit operation property tables (e.g. distillation column, flash evaporation, pump, and heat exchanger) and stream table for water + ethanol mixture were enclosed in Figure G5 to G7 and Table G20 to G33.

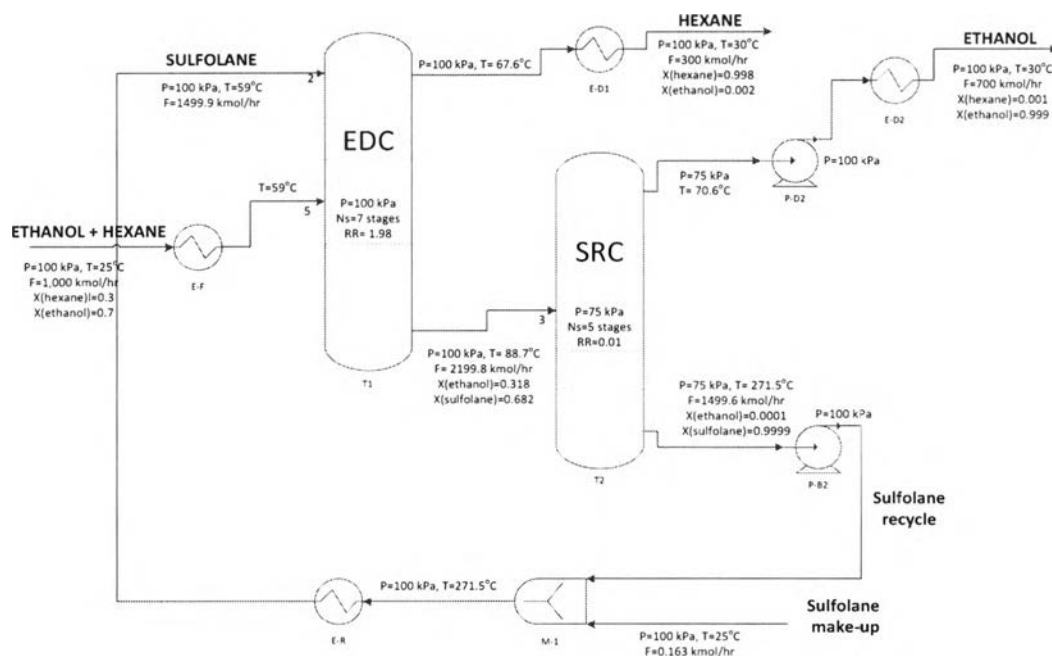

Figure 4.55 CS process flowsheet in ethanol + hexane mixture using sulfolane.

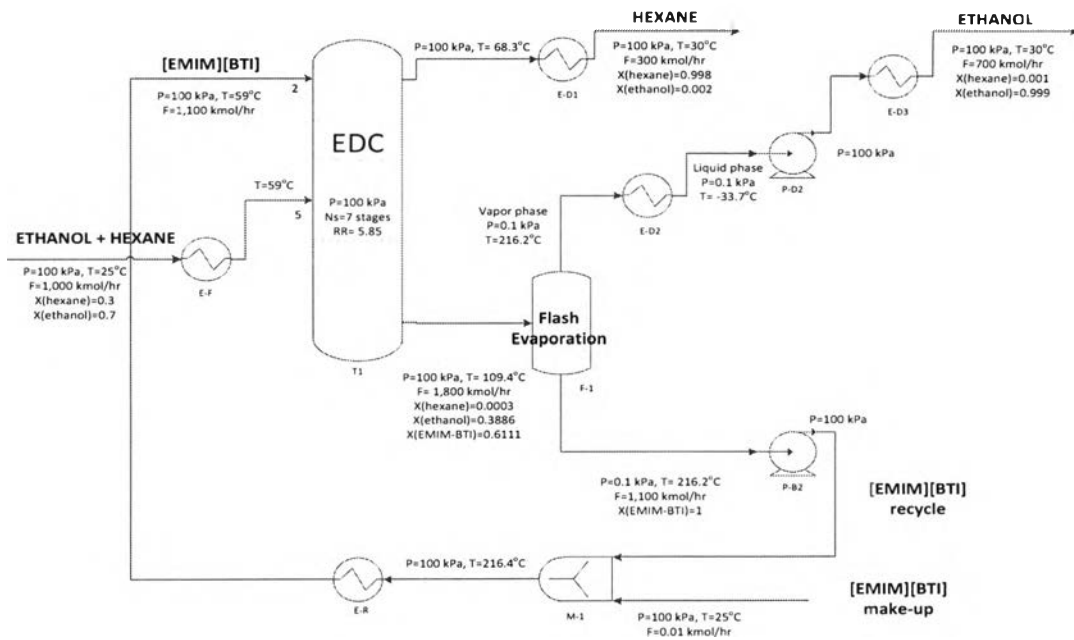

Figure 4.56 IL process flowsheet in ethanol + hexane mixture using [EMIM][BTI].

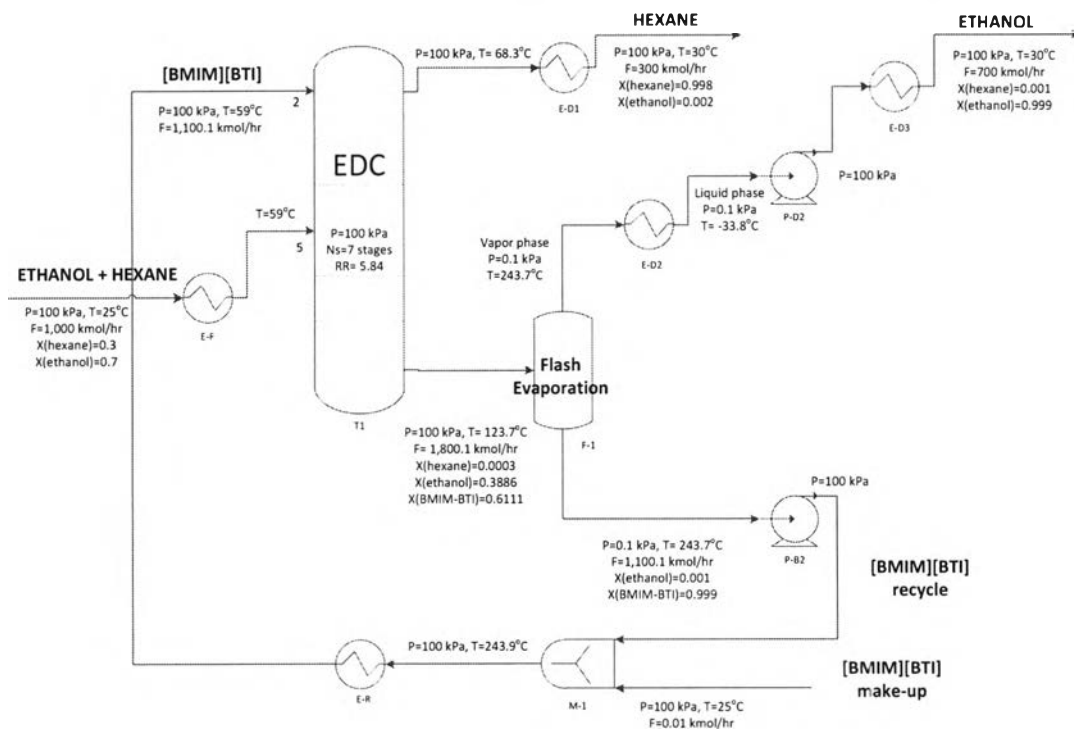

Figure 4.57 IL process flowsheet in ethanol + hexane mixture using [BMIM][BTI].

Table 4.20 Summarized results of energy requirement and solvent rate in ethanol + hexane mixture

Energy requirement and Solvent rate				
Topic	CS	Ionic liquids		Unit
	Sulfolane	[BMIM][BTI]	[EMIM][BTI]	
Solvent rate	1,500	1,100	1,100	kmol/h
QR (Extraction Column)	6.413	8.469	6.402	MW
QR (Solvent recovery)	27.566			MW
Qflash		20.321	19.700	MW
Qhex	23.394	6.932	6.173	MW
Qpump	0.001	0.012	0.010	MW
Qtotal	57.4	35.7	32.3	MW

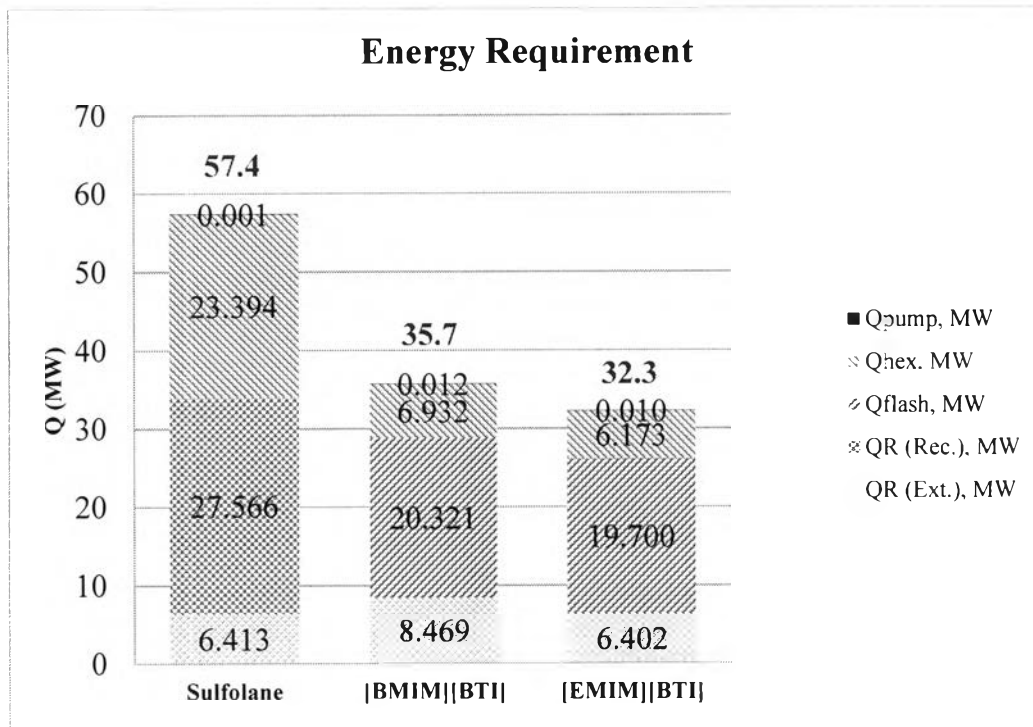

Figure 4.58 Summarized results of energy requirement in ethanol + hexane mixture.

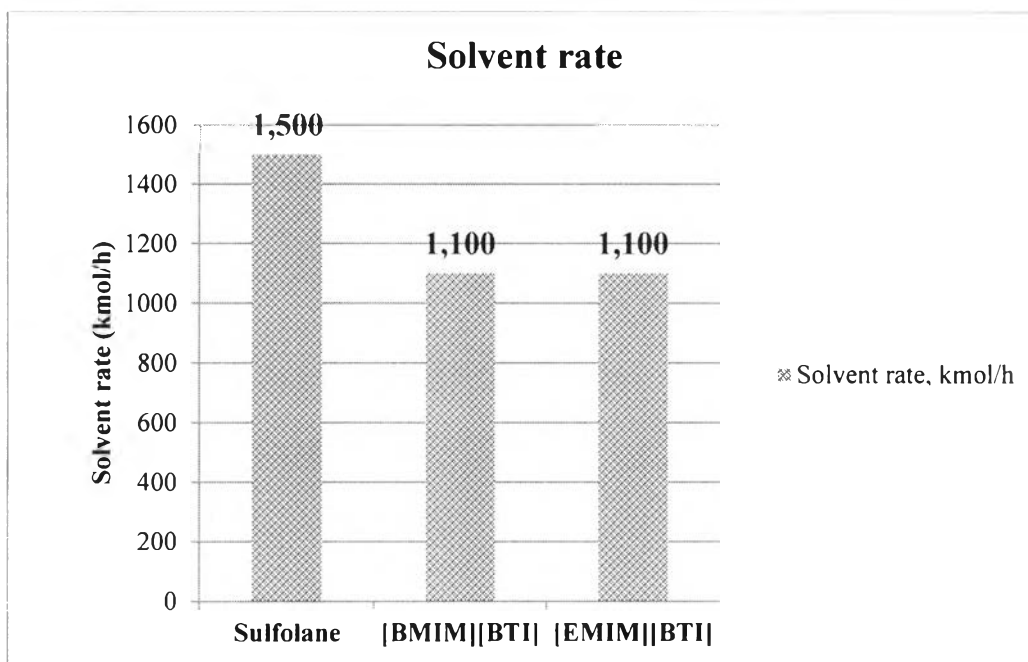

Figure 4.59 Summarized results of solvent rate in ethanol + hexane mixture.

- Benzene + Hexane mixture

A feed stream of 1,000 kmol/h (3:7 mole ratio of hexane: benzene) of azeotropic mixture is fed to the EDC at atmospheric condition (100 kPa, 25°C). Before entering the EDC at the 11th stage of EDC, the temperature was adjusted to 68°C to bring the temperature close to the boiling point of hexane but still consist of a single phase feed stream. NMP or the conventional solvent of this system is fed at 1,300 kmol/h to the 4th stage of the EDC. The pressure of the EDC is maintained at atmospheric pressure or 100 kPa, while the number of theoretical stage is set at 17. The purity of the hexane product at the top of EDC is specified at the target purity of 99.7% mol and a flowrate of 300 kmol/h. The condition of the hexane product stream is then adjusted to a sale condition at 100 kPa and 30°C. The bottom product of the EDC consisting of benzene mixed with NMP is fed to the 4th stage of the SRC. The number of theoretical stage of the SRC is set at 8 and SRC is operated under vacuum (20 kPa). 700 kmol/h of benzene can be separated at the target purity of 99.9% mol at the top of SRC. The benzene product stream is then adjusted to the suitable condition for sales (100 kPa, 30°C). NMP is recovered as a bottom product

and combined with the recycled NMP before feeding back to the EDC. An NMP process flowsheet is illustrated in Figure 4.59.

In case of two feasible IL candidates (i.e. [EMIM][EtSO₄] and [BMIM][BTI]), the IL processes were successfully simulated as shown in Figures 4.60 to 4.61. IL processes followed the same EDC condition as previously simulated in the NMP process and the same suitable condition for sales of every product at the same target purity. In addition, flash evaporation at vacuum pressure (0.1 kPa) was selected instead of SRC in all IL processes. This high vacuum condition was selected because of the stringent target purity in every product. Whether the target purity was altered to lower quality, the pressure of flash evaporation might have been possibly higher. Nevertheless, the temperature of flash evaporation must be not over the degradation temperature of each IL listed in Table 4.18. To conclude, all significant parameters have flexibility relied on the fixed target purity for a comparison in primary and the limitation of each IL property. Beyond that, benzene product from flash evaporation must be condensed from a vapor phase to a liquid phase at constant pressure and then adjusted again to the suitable condition for sales (100 kPa, 30°C). NMP process showed the highest energy requirement (25.6 MW) and solvent usage (1,300 kmol/h) and were higher than other two IL processes; [BMIM][BTI] (18.1 MW, 600 kmol/h), and [EMIM][EtSO₄] (14.1 MW, 400 kmol/h). [BMIM][BTI] showed the higher energy requirement and solvent usage than [EMIM][EtSO₄], hence, [EMIM][EtSO₄] became the best ILs in ethanol + hexane mixture. The functional anion group of [EMIM][EtSO₄] trends to have a good interaction with benzene than [BMIM][BTI]. However, all results were summarized in Table 4.21 (or Figures 4.62 and 4.63) and also the in-depth details of simulation process from PROII including unit operation property tables (e.g. distillation column, flash evaporation, pump, and heat exchanger) and stream table for water + ethanol mixture were enclosed in Figure G8 to G10 and Table G34 to G47.

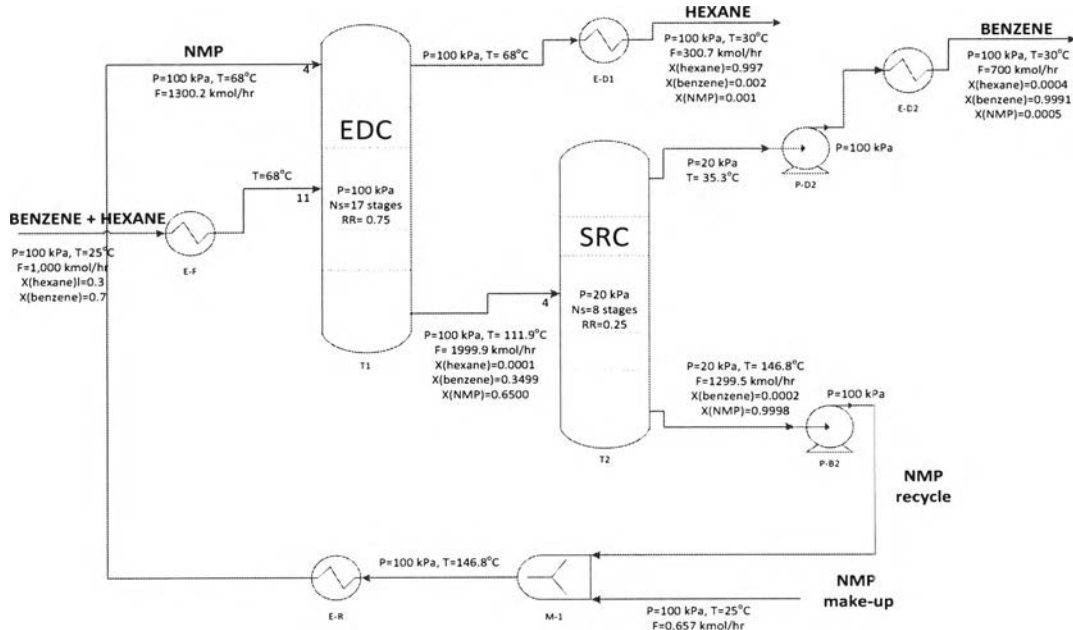

Figure 4.60 CS process flowsheet in benzene + hexane mixture using NMP.

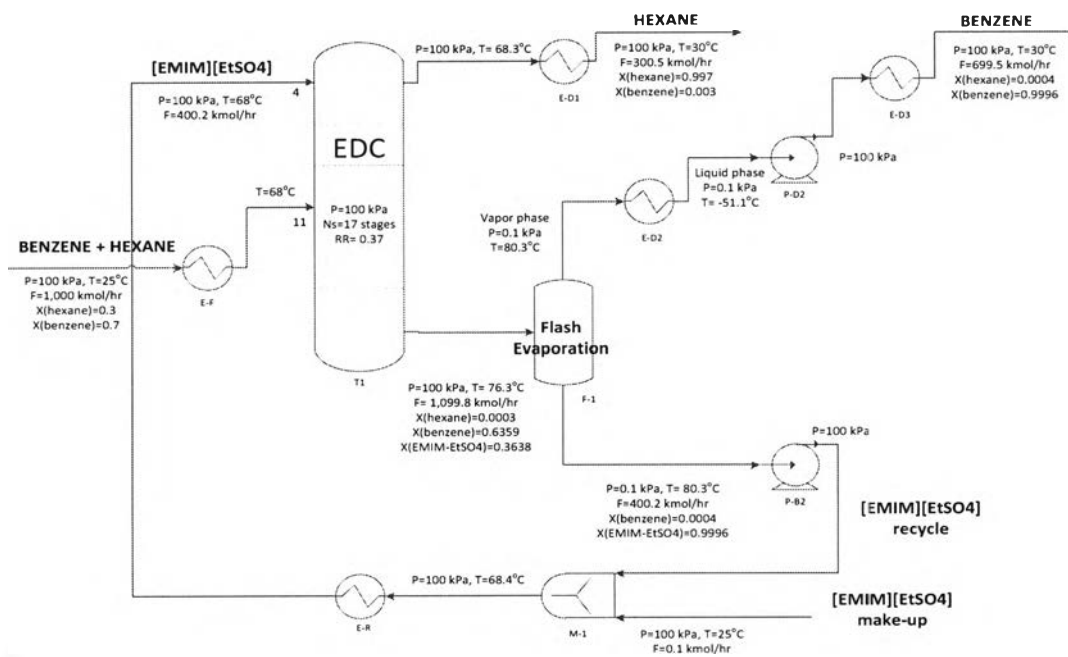

Figure 4.61 IL process flowsheet in benzene + hexane mixture using [EMIM][EtSO₄].

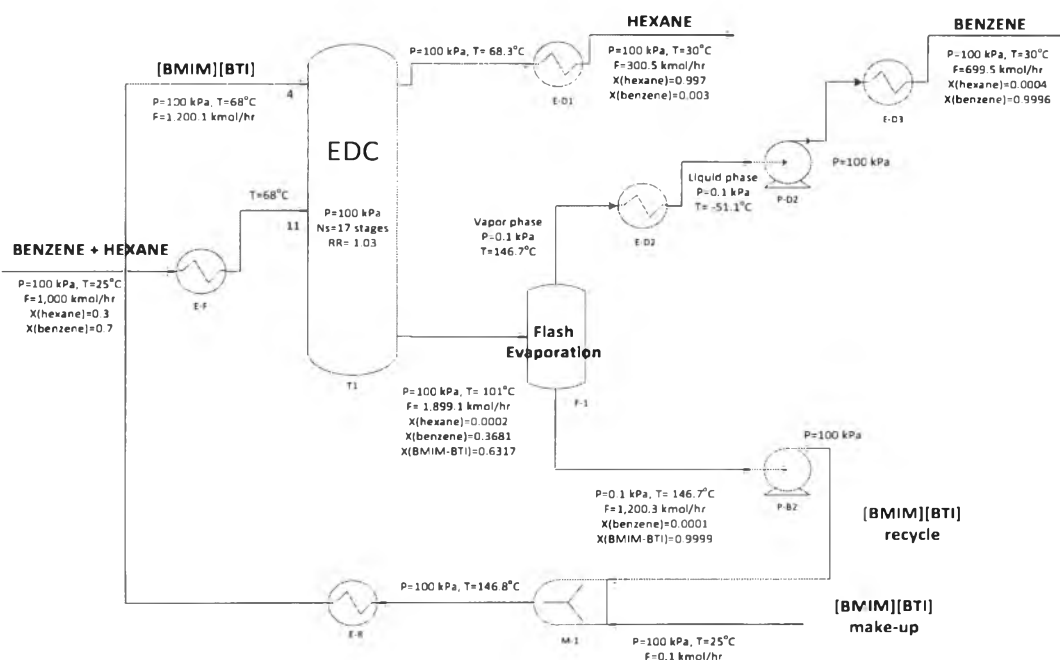

Figure 4.62 IL process flowsheet in benzene + hexane mixture using [BMIM][BTI].

Table 4.21 Summarized results of energy requirement and solvent rate in benzene + hexane mixture

Energy requirement and Solvent rate				
Topic	CS	Ionic liquids		Unit
	NMP	[EMIM][EtSO ₄]	[BMIM][BTI]	
Solvent rate	1,297	400	1,200	kmol/h
QR (Extraction Column)	8.974	3.421	3.852	MW
QR (Solvent recovery)	8.127			MW
Qflash		6.248	8.836	MW
Qhex	8.513	4.469	4.795	MW
Qpump	0.005	0.004	0.007	MW
Qtotal	25.6	14.1	18.1	MW

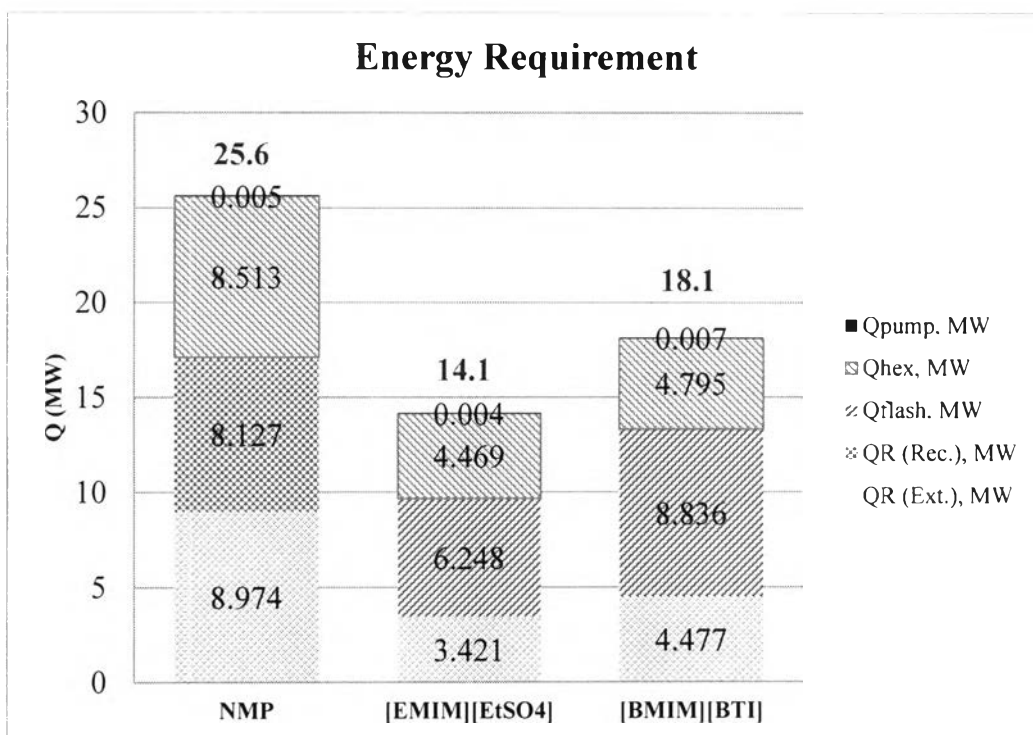

Figure 4.63 Summarized results of energy requirement in benzene + hexane mixture.

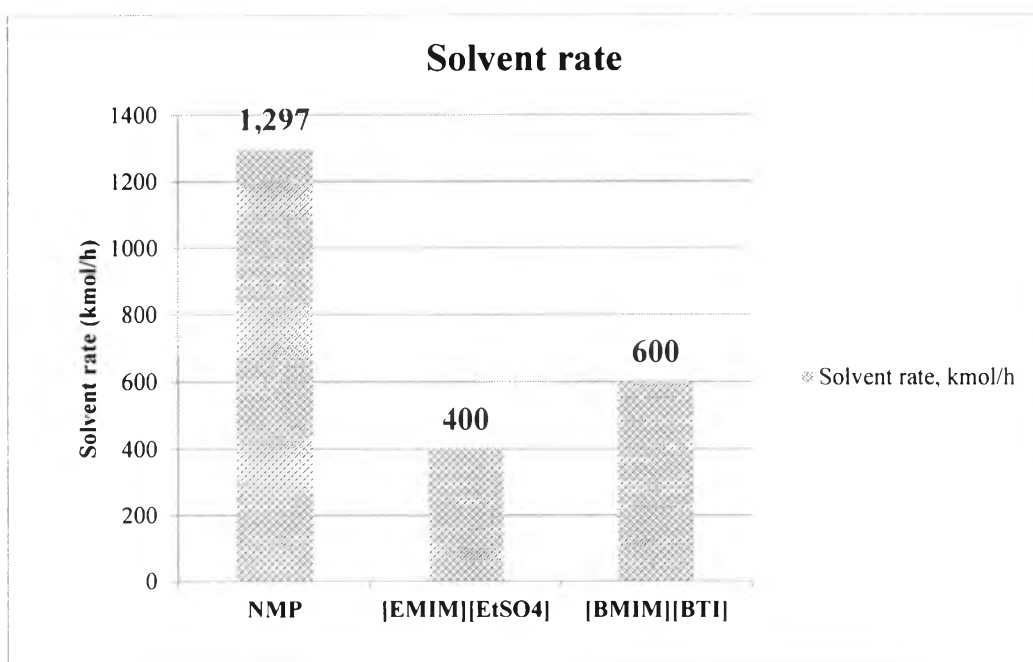

Figure 4.64 Summarized results of solvent rate in benzene + hexane mixture.

- Toluene + MCH mixture

A feed stream of 1,000 kmol/h (3:7 mole ratio of MCH: toluene) of azeotropic mixture is fed to the EDC at atmospheric condition (100 kPa, 25°C). Before entering the EDC at the 19th stage of EDC, the temperature was adjusted to 101°C to bring the temperature close to the boiling point of hexane but still consist of a single phase feed stream. NMP or the conventional solvent of this system is fed at 1,373 kmol/h to the 7th stage of the EDC. The pressure of the EDC is maintained at atmospheric pressure or 100 kPa, while the number of theoretical stage is set at 30. The purity of the MCH product at the top of EDC is specified at the target purity of 99.5% mol and a flowrate of 300 kmol/h. The condition of the MCH product stream is then adjusted to a sale condition at 100 kPa and 30°C. The bottom product of the EDC consisting of toluene mixed with NMP is fed to the 9th stage of the SRC. The number of theoretical stage of the SRC is set at 14 and SRC is operated under vacuum (40 kPa). 700 kmol/h of toluene can be separated at the target purity of 99.9% mol at the top of SRC. The toluene product stream is then adjusted to the suitable condition for sales (100 kPa, 30°C). NMP is recovered as a bottom product of SRC at a purity of 99.97% mol at 1,372 kmol/h. A NMP make-up stream is fed and combined with the recycled NMP before feeding back to the EDC. An NMP process flowsheet is illustrated in Figure 4.64.

In case of two feasible IL candidates (i.e. [HMIM][TCB] and [HMIM][BTI]), the IL processes were successfully simulated as shown in Figures 4.65 to 4.66. IL processes followed the same EDC condition as previously simulated in the NMP process and the same suitable condition for sales of every product at the same target purity. In addition, flash evaporation at vacuum pressure (0.1 kPa) was selected instead of SRC in all IL processes. This high vacuum condition was selected because of the stringent target purity in every product. Whether the target purity was altered to lower quality, the pressure of flash evaporation might have been possibly higher. Nevertheless, the temperature of flash evaporation must be not over the degradation temperature of each IL listed in Table 4.18. To conclude, all significant parameters have flexibility relied on the fixed target purity for a comparison in primary and the limitation of each IL property. Beyond that, toluene product from flash evaporation must be condensed from a vapor phase

to a liquid phase at constant pressure and then adjusted again to the suitable condition for sales (100 kPa, 30°C). NMP process showed the highest energy requirement (37.3 MW) and solvent usage (1,370 kmol/h) and were higher than other two IL processes; [HMIM][BTI] (31.6 MW, 500 kmol/h), and [HMIM][TCB] (23.5 MW, 250 kmol/h). [HMIM][BTI] showed the higher energy requirement and solvent usage than [HMIM][TCB], hence, [HMIM][TCB] became the best ILs in ethanol + hexane mixture. The functional anion group of [HMIM][TCB] trends to have a good interaction with toluene than [HMIM][BTI]. However, all results were summarized in Table 4.22 (or Figures 4.67 and 4.68) and also the in-depth details of simulation process from PROII including unit operation property tables (e.g. distillation column, flash evaporation, pump, and heat exchanger) and stream table for water + ethanol mixture were enclosed in Figure G11 to G13 and Table G48 to G61.

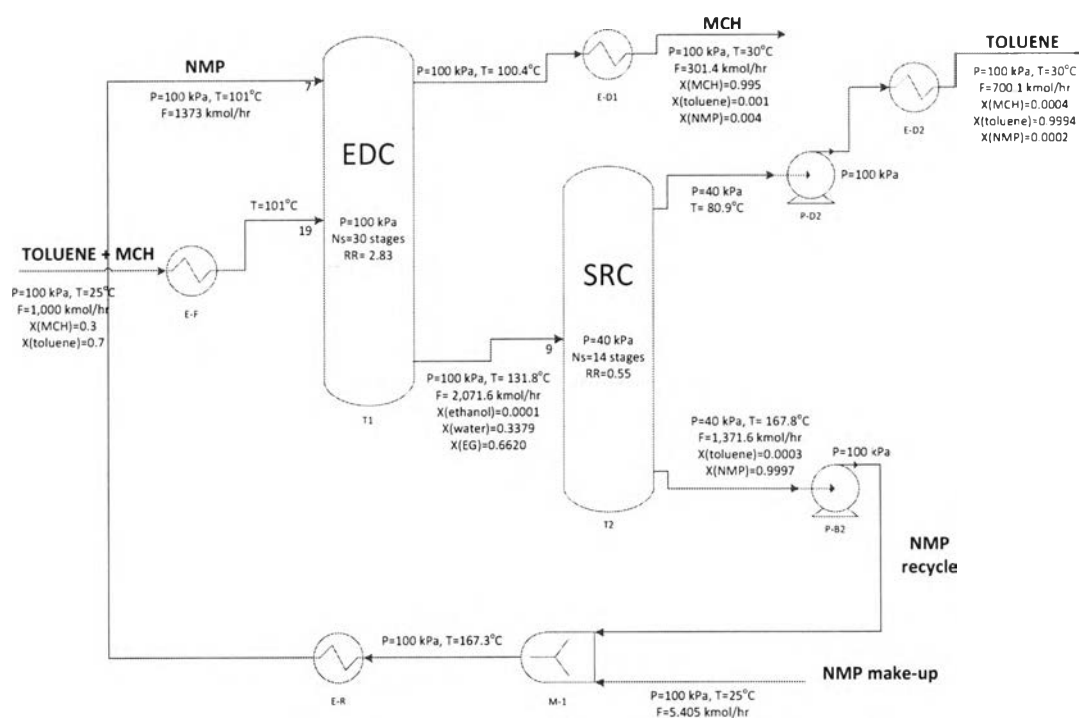

Figure 4.65 CS process flowsheet in toluene + MCH mixture using NMP.

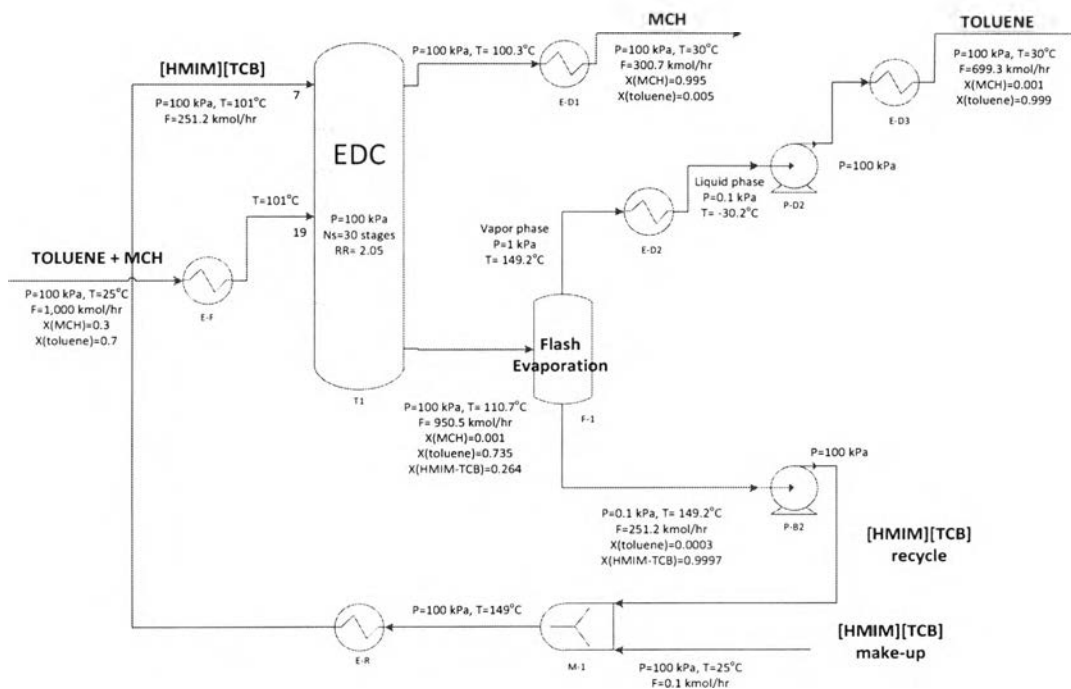

Figure 4.66 IL process flowsheet in toluene + MCH mixture using [HMIM][TCB].

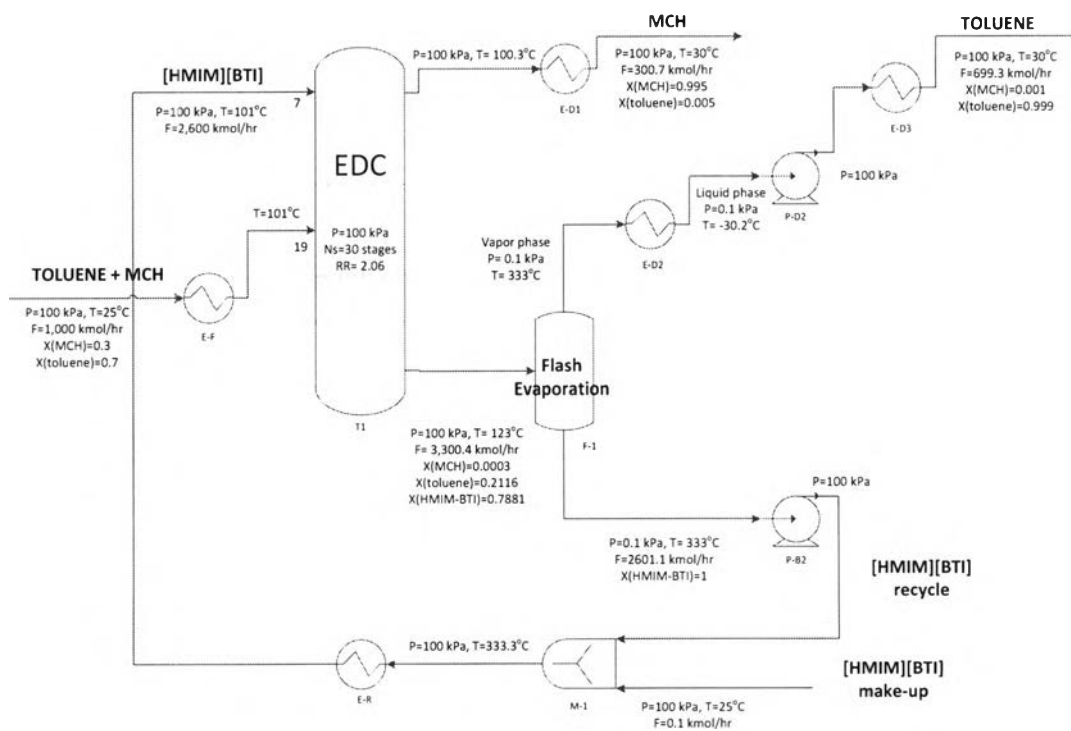

Figure 4.67 IL process flowsheet in toluene + MCH mixture using [HMIM][BTI].

Table 4.22 Summarized results of energy requirement and solvent rate in toluene + MCH mixture

Energy requirement and Solvent rate				
Topic	CS	Ionic liquids		Unit
	NMP	[HMIM][TCB]	[HMIM][BTI]	
Solvent rate	1368.933	251.084	2650.015	kmol/h
QR (Extraction Column)	13.897	11.351	7.017	MW
QR (Solvent recovery)	11.326			MW
Qflash		4.940	11.987	MW
Qhex	12.101	7.182	7.562	MW
Qpump	0.006	0.004	0.007	MW
Qtotal	37.3	23.5	31.6	MW

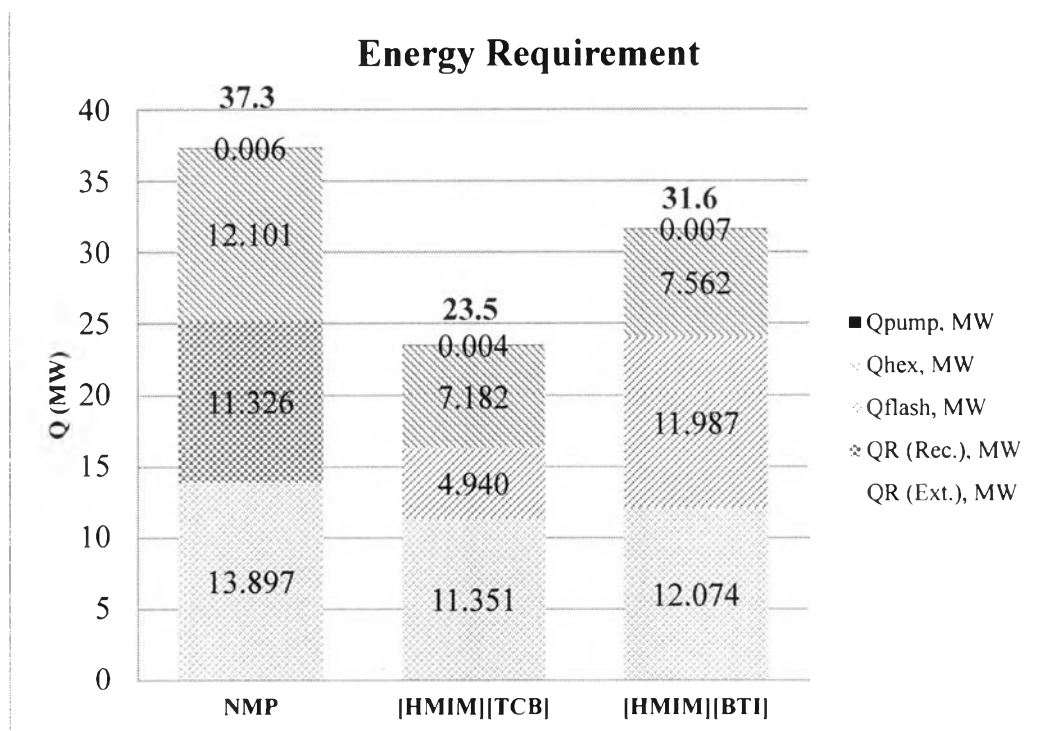

Figure 4.68 Summarized results of energy requirement in toluene + MCH mixture.

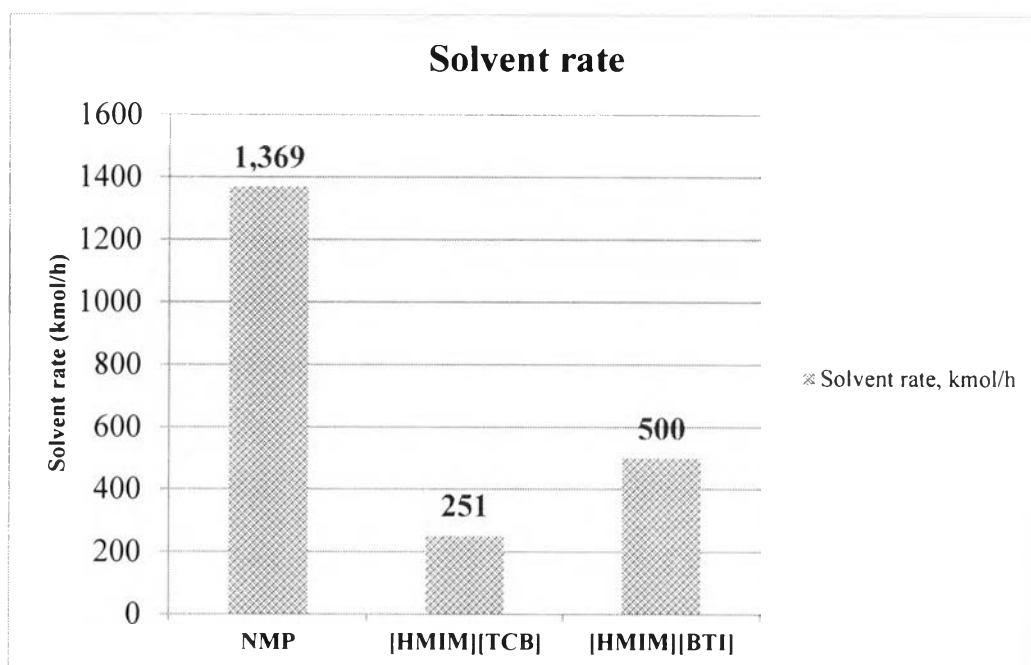

Figure 4.69 Summarized results of solvent rate in toluene + MCH mixture.

Table 4.23 Summarized results from PROII program of all case studies

Mixture	Water + ethanol	Ethanol + hexane	Benzene + hexane	Toluene + MCH
Target purity (%mol)	ethanol (99.8) and water (99.6)	hexane (99.8) and ethanol (99.9)	hexane (99.7) and benzene (99.9)	MCH (99.5) and toluene (99.9)
Energy requirement (MW)	[MMIM][DMP] (4.8) < [EMIM][EtSO4] (5.0) < [EMIM][DCA] (5.4) < EG (6.3)	[EMIM][BTI] (32.3) < [BMIM][BTI] (35.7) < Sulfolane (57.4)	[EMIM][EtSO4] (14.1) < [EMIM][BTI] (18.1) < NMP (25.60)	[HMIM][TCB] (23.5) < [HMIM][BTI] (31.6) < NMP (37.30)
Solvent usage (kmol/h)	[MMIM][DMP] (40) < [EMIM][EtSO4] (60) < [EMIM][DCA] (90) < EG (210)	[EMIM][BTI] ≈ [BMIM][BTI] (1,100) < Sulfolane (1,500)	[EMIM][EtSO4] (400) < [EMIM]BTI (600) < NMP (1200)	[HMIM][TCB] (250) < [HMIM][BTI] (500) < NMP (1370)

4.2.3.2 Economic Comparison

Although, the best ILs have been selected from the results of VLE and simulation comparison. Nevertheless, the expectation from industry is more strongly interested in economic comparison since the challenge for investment is always the determination on lower total costs or higher profits while achieving the same product quality and quantity as compared to a current commercial process. Hence, a comparison between conventional solvent process and the best IL process were studied in this contribution. Prior to the calculation of all necessary equipment sizing from the simulation using the method and equations for the equipment sizing calculation followed by Biegler et al. (1999), then these data were taken into ECON software for the calculation of CAPEX and OPEX.

In ECON software, CEPCI and utility (e.g. cooling water, low pressure steam, electricity and natural gas) cost data in Thailand are listed in Table 4.24, referring to available online websites. Purchased equipment and utility costs were immediately calculated after adding all equipment into ECON software. Next, CAPEX and OPEX were calculated from the default factor of each sector shown in Table 4.25 and 4.26 as a percentage of the total purchased equipment cost but the results did not include raw material and solvent costs due to unavailable industrial cost of raw materials and ILs at the present. A comparison between the IL and CS process was achieved by using the net present value (NPV). It is assumed that i or IRR (interest rate of return) = 15%, n (lifetime operation) = 15 years, $(P/A, i, n) = 5.847$, and 300 operating days per year. By equating $NPV_{IL} = NPV_{CS}$, the ratio of $(X_{IL}/X_{CS})_{econ}$, where X_{IL} is the cost of IL and X_{CS} is the cost of CS, can be calculated (see Equation 4.3-4.8). $(X_{IL}/X_{CS})_{econ}$ means the maximum solvent cost ratio that gives the IL process economic viability. If the actual industrial cost ratio is less than $(X_{IL}/X_{CS})_{econ}$, IL process might have a competition for investment.

By excluding the cost of solvent, Figures 4.69 to 4.72 show a plot of CAPEX and OPEX of CS and ILs in bar graphs for the systems of water + ethanol, ethanol + hexane, benzene + hexane and toluene + MCH, respectively. All of the four case studies showed that IL process gave a lower CAPEX and OPEX than the CS process. After considering the cost of solvent in term of the economic cost ratio of IL by CS, $(X_{IL}/X_{CS})_{econ}$, and solving Equation 4.4 (i.e. $NPV_{IL} = NPV_{CS}$). All

four case studies gave the $(X_{IL}/X_{CS})_{econ}$ equal to 5.24, 1.36, 5.57, and 5.57 for the mixtures of water + ethanol, ethanol + hexane, benzene + hexane and toluene + MCH, respectively. If the actual industrial cost of CS (X_{CS}) (i.e. EG, NMP, sulfolane, etc.) is estimated to 1,000 \$ for all types, the maximum economic cost of ILs ($X_{IL})_{econ}$ in all four case studies showed; 5,241.1 \$ of [MMIM][DMP] in water + ethanol mixture, 1,364.3 \$ of [EMIM]BTI] in ethanol + hexane mixture, 3,247.3 \$ of [EMIM][EtSO₄] in benzene + hexane mixture, and 5,565.3 \$ of [HMIM][TCB] in toluene + MCH mixture. Hence, actual industrial cost of ILs should be less than the maximum economic cost of ILs for competing in investment. In case of ethanol + hexane mixture, either the ratio of IL by CS, $(X_{IL}/X_{CS})_{econ}$, or the maximum economic cost of [EMIM]BTI] was the lowest as compared to the other case studies since CAPEX and OPEX of IL were similar to the CS process and the results of toluene + MCH mixture were vice versa. All results are summarized in Table 4.27. Beyond that, in-depth details of equipment sizing, purchased equipment cost, utility cost, CAPEX and OPEX from ECON software were enclosed in appendix H.

Table 4.24 CEPCI and utility cost for Econ software

CEPCI (2014)	631.2	Biegler <i>et al.</i> (1999)	
Operating days per year	300 days		
Cost Utility:			
Cooling water (CW: 25-45°C)	3.768	\$/GJ	(Provincial-Waterworks-Authority)
Low Pressure Steam (LPS: 500 kPa, 160°C)	0.015	\$/GJ	(IRPC)
Electricity (kW)	23.25	\$/GJ	(Metropolitan-Electricity-Authority)
Natural gas (>95%methane at 1 atm)	1,177	\$/GJ	(RHB&OSK-Energy)

Table 4.25 Factor of basis in each sector of capital cost (CAPEX)

Sectors of Capital cost (CAPEX)		
Direct costs	Factor of basis	Basis
Purchased Equipment Delivered	1.10	Purchase equipment cost
Purchased Equipment Installation	0.47	Purchased Equipment Delivered
Instrumentation and Controls (installed)	0.36	Purchased Equipment Delivered
Piping (Installed)	0.68	Purchased Equipment Delivered
Electrical Systems (Installed)	0.11	Purchased Equipment Delivered
Buildings (Including Services)	0.18	Purchased Equipment Delivered
Yard Improvement	0.10	Purchased Equipment Delivered
Service Facilities (Installed)	0.70	Purchased Equipment Delivered
Indirect costs	Factor of basis	Basis
Engineering and Supervision	0.33	Purchased Equipment Delivered
Construction Expenses	0.41	Purchased Equipment Delivered
Legal Expenses	0.04	Purchased Equipment Delivered
Contractor's Fees	0.22	Purchased Equipment Delivered
Contingency	0.44	Purchased Equipment Delivered
Fixed-capital Investment (FCI) = Total Direct cost + Total Indirect cost		
Working capital Investments (WC)	Factor of basis	Basis
	0.89	Purchased Equipment Delivered
CAPEX or Total capital investment (TCI)		
= Fixed-capital Investment (FCI) + Working capital Investments (WC)		

Table 4.26 Factor of basis in each sector of operating cost (OPEX)

Sectors of Operating cost (OPEX)		
Variable Cost	Factor of basis	Basis
Raw Material	0.00	-
Operating Labor	10.00	Fixed Capital Investment
Operating Supervision	15.00	Operating Labor
Utilities	100.00	Utilities
Maintenance and Repairs	6.00	Fixed Capital Investment
Operating Supplies	15.00	Maintenance and Supplies
Laboratory Charges	15.00	Operating Labor
Royalties	1.00	Total Product Cost
Fixed charges	Factor of basis	Basis
Property Taxes	2.00	Fixed Capital Investment
Financing (interest)	0.00	Fixed Capital Investment
Insurance	1.00	Fixed Capital Investment
Rent	0.00	Fixed Capital Investment
Manufacturing Cost	Factor of basis	Basis
Plant Overhead	60.00	Labor + Supervision + Maintenance
General Expense	Factor of basis	Basis
Administration	20.00	Labor + Supervision + Maintenance
Distribution & selling	4.00	Total Product Cost
Research & Development	4.00	Total Product Cost
OPEX or Total Product Cost with Out Depreciation = Total Variable Cost + Total Fixed Charges + Total Manufacturing Cost + Total General Expense		

Table 4.27 Summarized results from economic comparison of all case studies

Mixture		Water + Ethanol		Ethanol + Hexane		Benzene + Hexane		Toluene + MCH	
Solvent		CS	IL	CS	IL	CS	IL	CS	IL
		EG	[MMIM][DMP]	Sulfolane	[EMIM][BTI]	NMP	[EMIM][EtSO4]	NMP	[HMIM][TCB]
CAPEX (\$)¹		5,708,411.68	3,407,249.16	5,632,836.53	5,149,078.77	8,027,897.46	5,519,262.30	11,758,926.41	8,166,140.20
OPEX (\$/yr)¹		2,405,950.75	1,565,982.75	5,647,679.00	4,846,468.00	4,630,596.00	3,216,366.75	9,285,825.00	4,980,494.00
Solvent Flowrate (kmol/hr)	q	0.01	0.00	0.16	0.00	1.00	0.10	5.41	0.10
	Q	210.07	40.09	1,499.86	1,100.04	1,296.97	400.00	1,368.93	251.08
Solvent Quantity (kmol)	q	69.95	7.20	1,172.16	0.00	7,200.00	720.00	38,917.44	720.00
	Q	1,512,489.60	288,640.80	10,798,992.00	7,920,252.00	9,338,162.40	2,880,000.00	9,856,317.60	1,807,804.80
Molecular weight (kg/kmol)		62.07	222.20	120.17	391.30	99.13	282.16	99.13	282.16
Solvent Quantity (ton)	q	4,341.67	446.90	72,755.97	0.09	446,904.00	44,690.40	2,415,605.50	44,690.40
	Q	93,880,229.47	17,915,934.46	670,293,433.44	491,610,041.64	579,619,740.17	178,761,600.00	611,781,633.43	112,210,443.94
Solvent price (\$/ton)	x	1000.0	5241.1	1000.0	1364.3	1000.0	3247.3	1000.0	5565.3
Comparison 1) CAPEX_{IL} ≤ CAPEX_{CS}		Yes		Yes		Yes		Yes	
Comparison 2) OPEX_{IL} ≤ OPEX_{CS}		Yes		Yes		Yes		Yes	
(x_{IL}/x_{CS})_{econ} @ NPV_{IL}-NPV_{CS} = 0 (see Note 2)		5.241		1.364		5.565		5.565	
<p>Note: excluding cost of solvent</p> <p>²Assumption: x_{IL}/x_{CS} = constant = economic cost ratio of IL by CS</p> <p>NPV_{IL} - NPV_{CS} = 0 or [(CAPEX_{IL} - CAPEX_{CS}) + (Q_{IL}x_{IL} - Q_{CS}x_{CS})] + [(OPEX_{IL} - OPEX_{CS})(P/A,i,n) + (q_{IL}x_{IL} - q_{CS}x_{CS})(P/A,i,n)] = 0;</p> <p>i (interest rate of return) = 15%, n (lifetime operation) = 15 years, (P/A,i,n) = 5.847, and 300 operating days per year</p>									

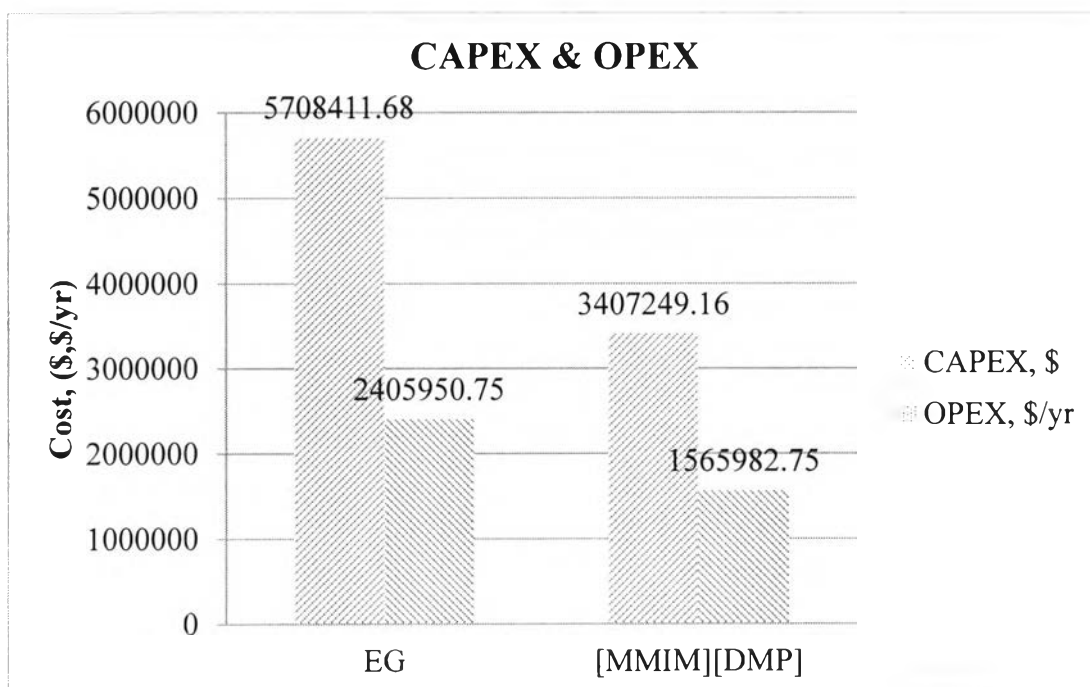

Figure 4.70 CAPEX and OPEX of CS and IL processes in water + ethanol mixture.

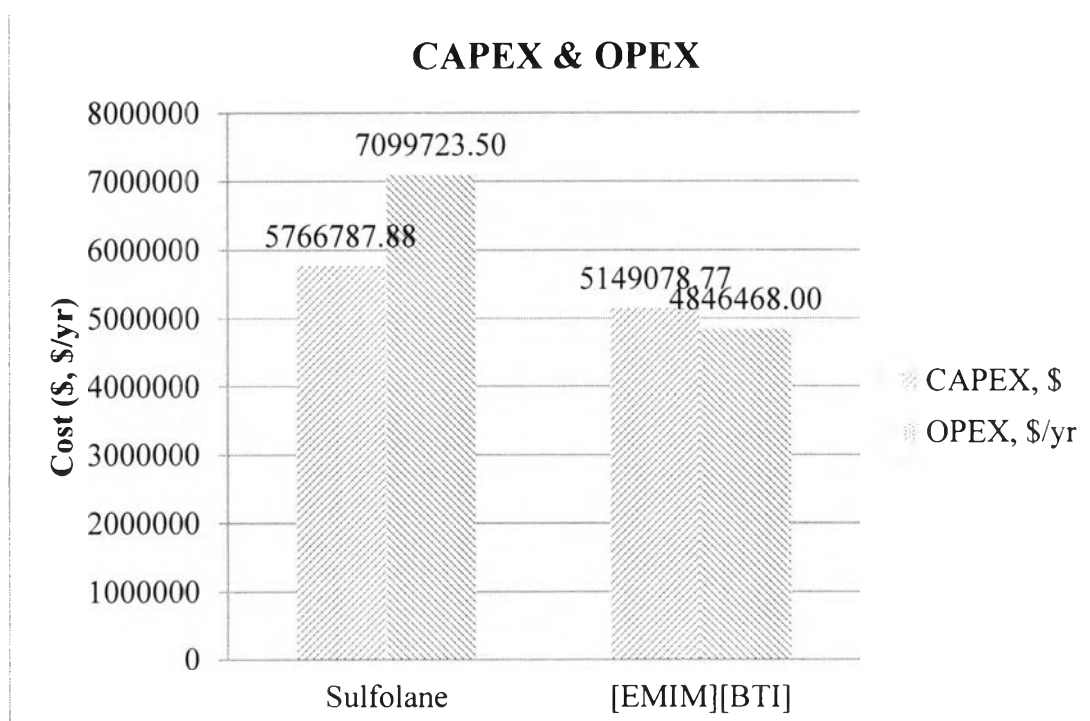

Figure 4.71 CAPEX and OPEX of CS and IL processes in ethanol + hexane mixture.

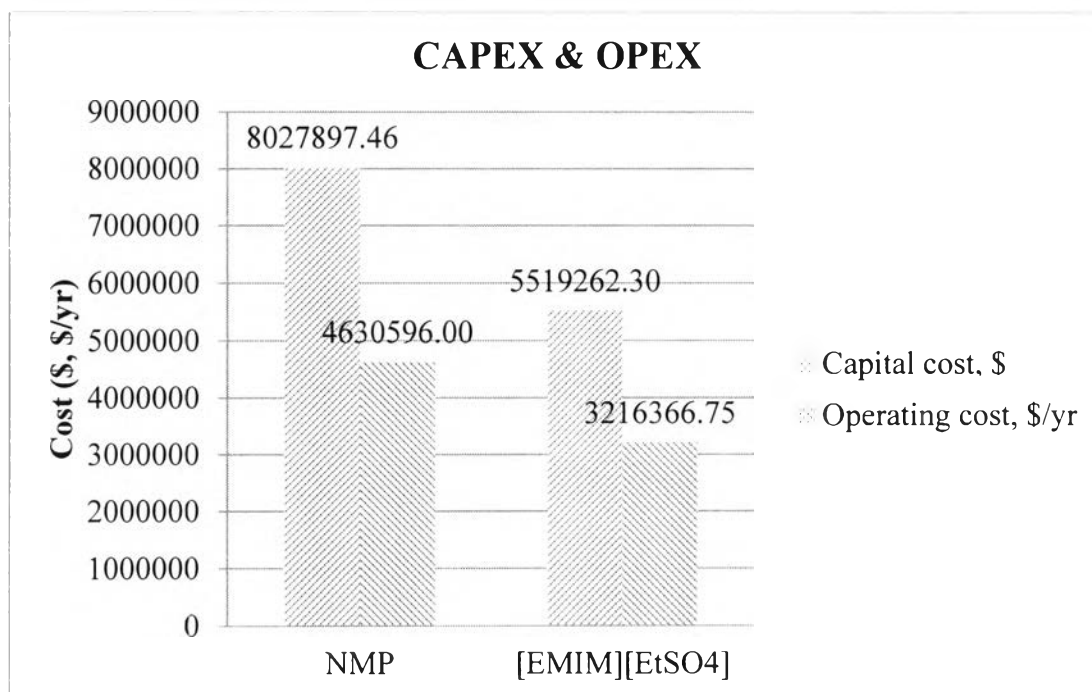

Figure 4.72 CAPEX and OPEX of CS and IL processes in benzene + hexane mixture.

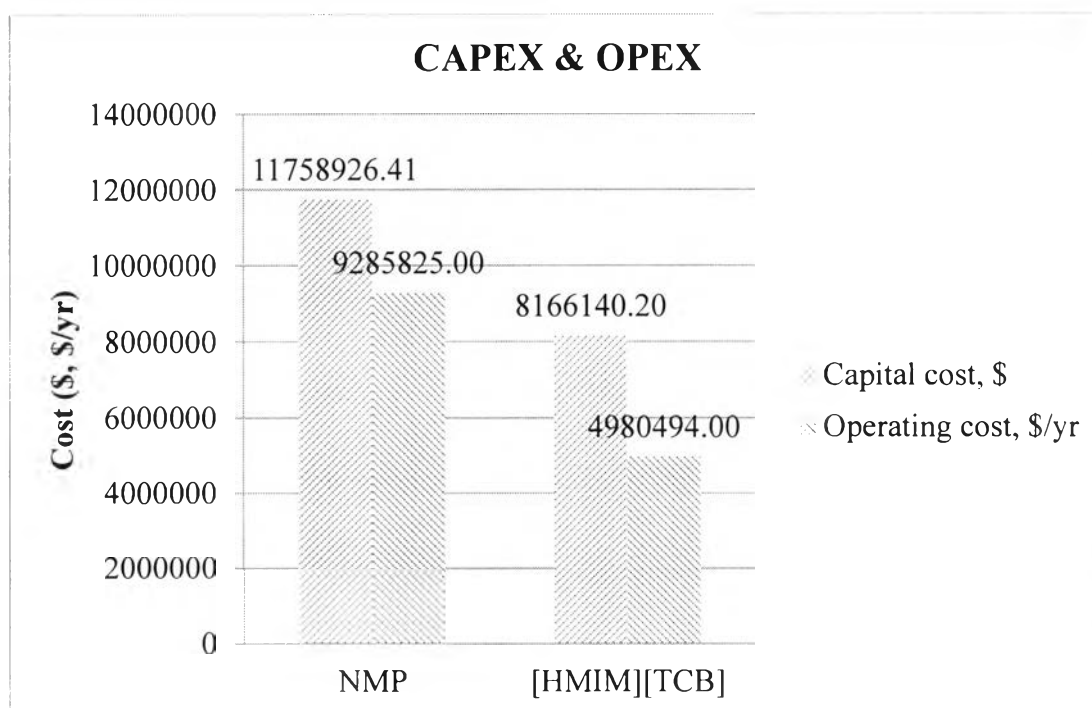

Figure 4.73 CAPEX and OPEX of CS and IL processes in toluene + MCH mixture.

To summarize and confirm the best ILs, final evaluation was accomplished by synthesizing and analyzing all results of the best ILs with good separation capability from VLE comparison graph, good performance from simulation process and the attractive economic assessments. In addition, exceptions and recommendations in the period of demonstration should be described here (if any).

All significant results from every step in each stage of this proposed systematic methodology are summarized in Table 4.28. In conclusion, the best ILs in all case studies were [MMIM][DMP] for water + ethanol mixture, [EMIM][BTI] for ethanol + hexane mixture, [EMIM][EtSO₄] for benzene + hexane mixture, and [HMIM][TCB] for toluene + MCH mixture. All of the best ILs showed the best performance of the results in the same manner, for example, the best IL gave the most perfect separation capability to break azeotrope or increase the relative volatility of the mixture, provided the lowest energy requirement and solvent usage, and also gave the most economical process as compared to other ILs and the conventional solvent. It is worth noting that the best ILs in this contribution was obtained from available IL data from literature database at the moment. Since IL data have been updating continuously, the IL database is suggested to be updated and re-run to seek for the best ILs of a particular azeotropic system.

In the case of water + ethanol mixture, [MMIM][DMP] was the best ILs whereas other two ILs (i.e. [EMIM][DCA] and [EMIM][EtSO₄]) could be either used as entrainer since both ILs provided lower energy requirement and solvent usage in the simulation process but they were not further discussed in economic comparison. Also, the target window in the screening graph was apparently dissimilar to other organic-organic azeotropic case studies due to the influence of hydrogen-bond interaction between water and ethanol. In the case of ethanol + hexane mixture, although [EMIM][BTI] was the best ILs but another IL (i.e. [BMIM][BTI]) could also performed well in the separation of this system as confirmed by the simulation result. For [EMIM][EtSO₄] in benzene + hexane mixture and [HMIM][TCB] in toluene + MCH mixture, these ILs were the best IL in each case study since all other ILs were completely not able to compete with the conventional solvents as confirmed by the simulation results.

Table 4.28 Summarized results from all steps in each stage of the improved systematic methodology

Stage 1: Selection					
Mixture selection	Aqueous system Ethanol + Water (Organic solvent: EG)	Non-aqueous system Ethanol + Hexane (Organic solvent: Sulfolane)	Non-aqueous system Benzene + Hexane (Organic solvent: NMP)	Non-aqueous system Toluene + MCH (Organic solvent: NMP)	Non-aqueous system Ethylbenzene (EB) + P-xylene (PX) (Organic solvent: Unknown)
Separation process selection	ED	ED	ED	ED	ED
IL pre-selection	Target window: Capacity (2-12), Selectivity (1-6) and Solubility (23-50 MPa ^{1/2}) Feasible IL candidates: 9 ILs	Target window: Capacity (0.5-1.5), Selectivity (5-15) and Solubility (23-31 MPa ^{1/2}) Feasible IL candidates: 7 ILs	Target window: Capacity (0.3-2.1), Selectivity (6-42) and Solubility (18-28 MPa ^{1/2}) Feasible IL candidates: 34 ILs	Target window: Capacity (0.5-1.5), Selectivity (5-15) and Solubility (18-28 MPa ^{1/2}) Feasible IL candidates: 11 ILs	Target window: Capacity (0.5-1.5), Selectivity (5-15) and Solubility (18-30 MPa ^{1/2}) Feasible IL candidates: 11 ILs
Stage 2: Verification					
Verification of mixture	Azeotropic mixture (Target solute: Water)	Azeotropic mixture (Target solute: Ethanol)	Azeotropic mixture (Target solute: Benzene)	Close-boiling mixture (Target solute: Toluene)	No further demonstration and discussion
Verification of IL	Verified ILs for comparison: 3 ILs ([MMIM][DMP], [EMIM][DCA], and [EMIM][EtSO ₄])	Verified ILs for comparison: 2 ILs ([EMIM][BTI] and [BMIM][BTI])	Verified ILs for comparison: 2 ILs ([EMIM][BTI] and [EMIM][EtSO ₄])	Verified ILs for comparison: 2 ILs ([HMIM][BTI] and [HMIM][TCB])	
Stage 3: Comparison					
VLE comparison	Separation capability for increasing relative volatility: [MMIM][DMP] > [EMIM][DCA] ≈ [EMIM][EtSO ₄]	Separation capability for increasing relative volatility: [EMIM][BTI] > [BMIM][BTI]	Separation capability for increasing relative volatility: [EMIM][EtSO ₄] > [EMIM][BTI]	Separation capability for increasing relative volatility: [HMIM][TCB] > [HMIM][BTI]	

Table 4.28 Summarized results from all steps in each stage of the improved systematic methodology (Continued)

Stage 3: Comparison					No further demonstration and discussion
Simulation comparison	Target purity (%mol): Ethanol (99.8) and Water (99.6)	Target purity (%mol): Hexane (99.8) and Ethanol (99.9)	Target purity (%mol): Hexane (99.7) and Benzene (99.9)	Target purity (%mol): MCH (99.5) and Toluene (99.9)	
	Energy requirement (MW): [MMIM][DMP] (4.8) < [EMIM][EtSO4] (5.0) < [EMIM]DCA] (5.4) < EG (6.3)	Energy requirement (MW): [EMIM][BTI] (32.3) < [BMIM][BTI] (35.7) < Sulfolane (57.4)	Energy requirement (MW): [EMIM][EtSO4] (14.1) < [EMIM][BTI] (18.1) < NMP (25.6)	Energy requirement (MW): [HMIM][TCB] (23.5) < [HMIM][BTI] (31.6) < NMP (37.30)	
	Solvent usage (kmol/hr): [MMIM][DMP] (40) < [EMIM][EtSO4] (60) < [EMIM][DCA] (90) < EG (210)	Solvent usage (kmol/hr): [EMIM][BTI] ≈ [BMIM][BTI] (1,100) < Sulfolane (1,500)	Solvent usage (kmol/hr): [EMIM][EtSO4] (400) < [EMIM][BTI] (600) < NMP (1,200)	Solvent usage (kmol/hr): [HMIM][TCB] (250) < [HMIM][BTI] (500) < NMP (1,370)	
Economic comparison	CAPEX (\$): [MMIM][DMP] (3,407,249) < EG (5,708,411)	CAPEX (\$): [EMIM][BTI] (5,149,079) < Sulfolane (5,632,836)	CAPEX (\$): [EMIM][EtSO4] (5,519,262) < NMP(8,027,897)	CAPEX (\$): [HMIM][TCB] (8,166,140) < NMP(11,758,926)	
	OPEX (\$/yr): [MMIM][DMP] (1,565,982) > EG (2,405,950)	OPEX (\$/yr): [EMIM][BTI] (4,846,468) < Sulfolane (5,647,679)	OPEX (\$/yr): [EMIM][BTI] (3,216,367) < NMP (4,630,596)	OPEX (\$/yr): [HMIM][TCB] (4,980,494) < NMP (9,285,825)	
	$(X_{IL}/X_{CS})_{econ} = 5.24$	$(X_{IL}/X_{CS})_{econ} = 1.36$	$(X_{IL}/X_{CS})_{econ} = 3.25$	$(X_{IL}/X_{CS})_{econ} = 5.57$	
Final evaluation (the best IL)	[MMIM][DMP]	[EMIM][BTI]	[EMIM][EtSO4]	[HMIM][TCB]	