

CHAPTER III

THEORY

One of the most important achievements in the field of synthetic polymer chemistry during the past 50 years has been the discovery in 1953 by Ziegler and his co-workers [2,3] that aluminum alkyl compounds used along with many transition metal halides in an inert hydrocarbon medium could polymerize ethylene under conditions of normal temperatures and pressures to yield a solid polymer of high molecular weight and of linear structure.

Using a combination of titanium tetrachloride and aluminum triethyl Natta and co-workers [14] established that propylene could be polymerized to give a product which could be separated into largely crystalline and amorphous fractions. Subsequently Natta and his co-workers [15] extended the type of transition metal halide used to solid crystalline transition metal salts in a lower valence state, e.g. $TiCl_3$, VCl_3 , etc. It was also established that stereoregular polymers of butene-1, styrene, dienes, etc., could be prepared.

Ziegler's discovery, together with the ensuing work into the polymerization of propylene and other α -alkenes by Natta, has given rise to the development of new classes both of catalysts and polymers. In the case of ethylene, the essential advance which was achieved was the preparation of a more linear type of polyethylene, while in the case of propylene and other α -alkenes, it was the control of the propagation step so as to give linear unbranched stereoregular molecules [14]. The commercial advantage was that this control could be achieved in the polymerization of such readily available and cheap monomers as ethylene and propylene. In recognition of their contributions the 1963 Nobel Prize for Chemistry was awarded to Ziegler and to Natta.

Interest in isotactic polypropylene was so high that only three years elapsed between the laboratory discovery and the first commercial production. The excellent

combination of thermal and mechanical properties was quickly exploited in a variety of applications, such as injection molding and film and fiber production. This versatility, combined with favorable economics, encouraged a rapid expansion in the use of this material in the 1960s and the early 1970s. At present, polypropylene is one of the most important commercial thermoplastics; its consumption is still increasing more rapidly than the total for all thermoplastics. This situation is likely to continue into the future for the following reasons:

1. The relatively low cost of the product is due to low monomer cost and efficient polymerization technology, compared with other thermoplastics. Competition in licensing technology and production methods promotes further cost reduction by technical improvements.

2. The polymer can be modified for a variety of applications. Through copolymerization, orientation, and other techniques the physical properties of the product can be varied to meet a wide range of thermal and mechanical requirements.

3. The ease in processing these polymers allows their economic use in most commercial fabrication techniques. Modifications of the melt rheology increase this versatility [50].

3.1 POLYMER STRUCTURES

In polymerization with Ziegler-Natta catalysts, propene or longer-chained-olefins are inserted into the growing chain in a head-to-tail fashion with high selectivity. Every CH₂ group (head) is followed by a CH(R) group (tail) with a tertiary carbon atom bearing a methyl or even larger alkyl group:

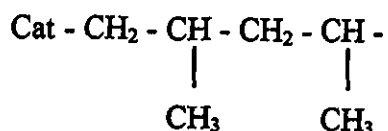

This construction principle is mandatory for the stereoregular structure of the polypropylene molecule. In addition, head-to-head

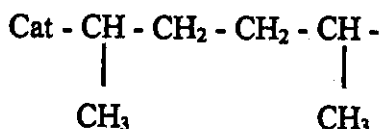

and tail-to-tail

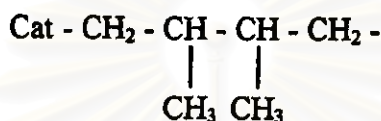

arrangements occur. Exclusive head-to-tail bonding is a mandatory but not a sufficient condition for stereoregularity. Another important detail is the sterical orientation of the pendant methyl groups with respect to the main C-C axis of the polymer molecule.

Natta formulated three different structures as shown in Figure 3.1:

1. In the structure all pendant methyl groups are located on one side of the zigzag plane; these polymers are called isotactic.
2. For polymers in which the position of the pendant methyl groups is alternatingly above and below the backbone plane, the term syndiotactic is used.
3. When the pendant methyl groups are randomly positioned above and below the plane, the polymer is said to be atactic.

The tertiary carbon atoms in polyalkene chains are not strictly asymmetric since two substituents are constructed from infinite monomer sequences, and are thus similar, and so the symbols of asymmetric carbon atoms, R and S, cannot be usefully applied. Normally the symbols D and L are used to designate the two possible configurations of the tertiary carbon atoms in polyalkene chains: DDDDDDD or LLLLLLL, an isotactic sequence; DLDDLDDL, a syndiotactic sequence; DLDDLDDLLDLLLDDDDLL, an atactic sequence.

In reality the polymer chain never adopts the flat extended forms shown in Figure 3.1 but is coiled in a helix since such a structure results in the least crowding

between the hydrogen atoms. Helical structures for isotactic and syndiotactic polypropylene are shown in Figure 3.2.

The polymerization of propylene by heterogeneous Ziegler-Natta catalysts produces a mixture of isotactic and atactic polymer, and one of the many significant contributions made by Natta and his co-workers was a rapid method they devised for catalyst characterization which was based on simple stereoisometric fractionation procedures involving the use of boiling solvents, e.g. ether, heptane, xylene, etc. However, different solvents tend to extract varying fractions of lower molecular weight material, as well as removing atactic polymer. The most common procedure adopted in industrial laboratories is extraction using boiling n-heptane, and the percentage of polymer insoluble in this solvent under these conditions is normally referred to as the Isotactic Index (I.I.). It should, however, be realized that the term atactic is used loosely since the soluble fraction may contain chains made up of blocks of isotactic or syndiotactic placements in addition to purely atactic material [50].

The properties of isotactic, syndiotactic, and atactic polypropylene are given in Table 1.1. Syndiotactic polypropylene is of a more scientific than practical interest. Furthermore, it is difficult to synthesize (particularly because of the required temperature of -70°C) [51].

Isotactic structure

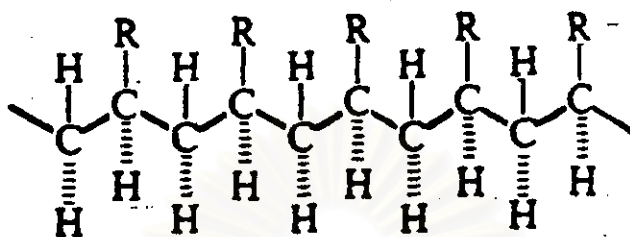

Syndiotactic structure

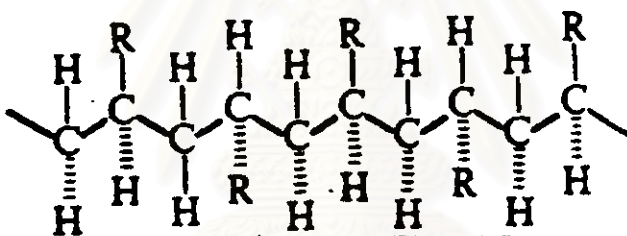

Atactic structure

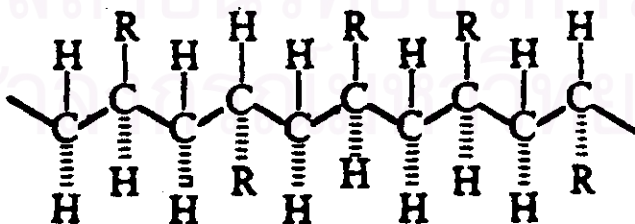
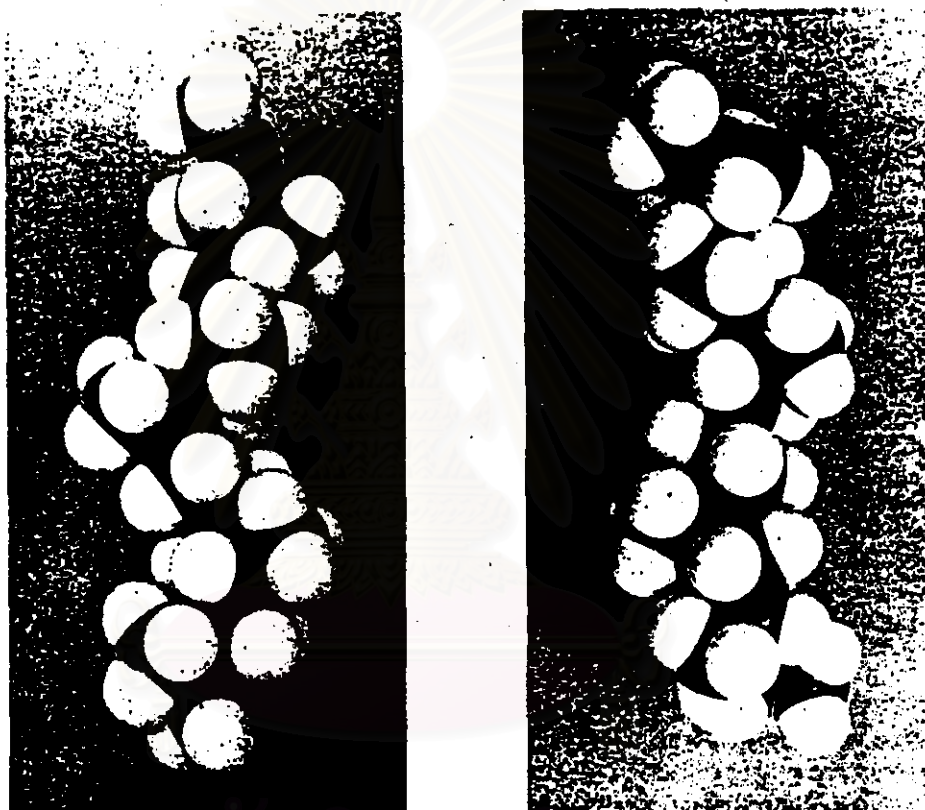

Figure 3.1 Planar representation of chains of polypropylene. [118]



สถาบันวิทยบริการ
จุฬาลงกรณ์มหาวิทยาลัย

Figure 3.2 Chain models of helices of (a) isotactic and (b) syndiotactic polypropylene [118]

3.2 DEFINITION OF THE ZIEGLER-NATTA CATALYST

Ziegler-Natta catalysts are broadly defined in terms of their preparation which involves reacting compounds (commonly halides) of groups IV - VIII transition metals (e.g. Ti, V, Cr, Zr) with organometallic compounds (e.g. alkyls, aryls or hydrides) of groups I - III metals (e.g. Al, Mg, Li) as shown in eq. 3.1. This definition is in fact too broad since not all such reactions yield catalysts suitable for preparing stereoregular polymers. Nevertheless, for each monomer there is a wide range of catalysts that are suitable [52].

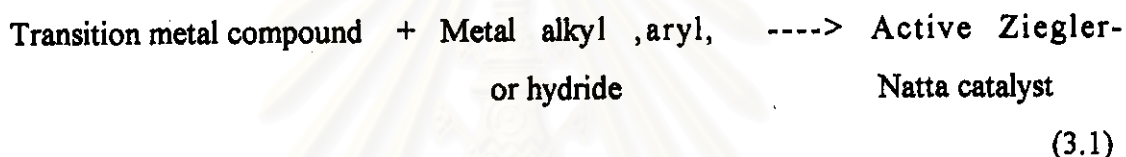

The type of solvent or diluent should not be omitted in reporting a catalyst system. Ziegler-Natta polymerization are usually carried out in inert solvents, e.g. heptane or toluene. The use of polar solvents can drastically alter the reaction mechanism. Both monomer and diluent or solvent must be clearly specified in defining a particular Ziegler-Natta catalyst system. [50].

3.3 MECHANISM OF PROPYLENE POLYMERIZATION

3.3.1 Mechanism of Propagation Site Formation

The Ziegler-Natta catalyst systems for the stereoregular polymerization of α -olefins generally contain a crystalline solid phase which consists essentially of a transition metal halide. The physicochemical condition at the surface of these crystals undoubtedly plays a major role in governing stereospecificity. Various mechanisms have been proposed to describe the surface condition. Several basic ideas have been brought forth [53-55].

The proposed mechanisms are classified according to the structure of the growth center [1] :

- (1) the center is a transition metal-carbon bond,
- (2) the center is a base metal-carbon bond,
- (3) the center is a bound radical , and
- (4) the center is a bound anion.

The literature uses the terminology "monometallic" and "bimetallic" in describing both mechanisms and catalysts. When talking about mechanisms, the notations monometallic and bimetallic have been used to show that one or two metal atoms are involved (and are essential) in the growth step, respectively. On the other hand, some workers refer to metal alkyl-free catalysts and Ziegler-Natta catalysts as monometallic- and bimetallic-coordination anionic catalysts, respectively.

Natta and co-workers judiciously avoided this problem by using the simple designation Me-C (or M-C or cat-E) for the active center without requiring M to be the base metal or the transition metal [37].

Natta and co-workers accepted the bottom scheme (b) as applicable to isotactic polymerizations and used it advantageously in kinetic treatments.

This mono and bimetallic nomenclature can get cumbersome for certain mechanistic proposals. Consider, for example, three types of active centers that have been proposed for the active metal-carbon bond M-Pn (Pn is the growing polymer chain, M is Ti or Al, and Cl is chlorine ligands of $TiCl_3$ crystal surface or attached to Al) (see structures I, II, and III in Figure 3.4). A common feature of growth at all three structures is the complexing of olefin at the Ti center. In structures I and II, however, growth takes place in the Ti-Pn bond, while in structures III, the Al-Pn is the growth bond. According to some authors, the presence of AlR_3 as part of the complex is essential for a number of reasons : (1) it stabilizes the transition metal-carbon bond and prevents its decomposition, (2) it makes the transition metal-carbon bond more active for polymerization, and/or (3) it is necessary to orient the complexed α -olefin in the isotactic configuration.

Surface of Catalyst

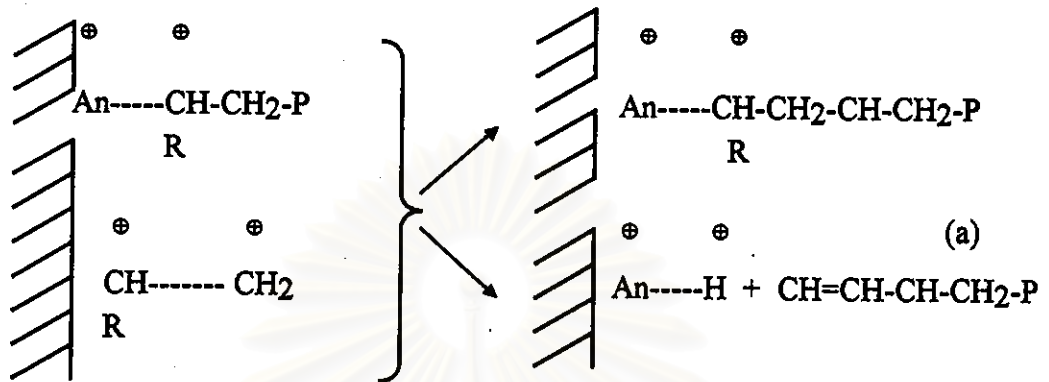

Surface of Catalyst

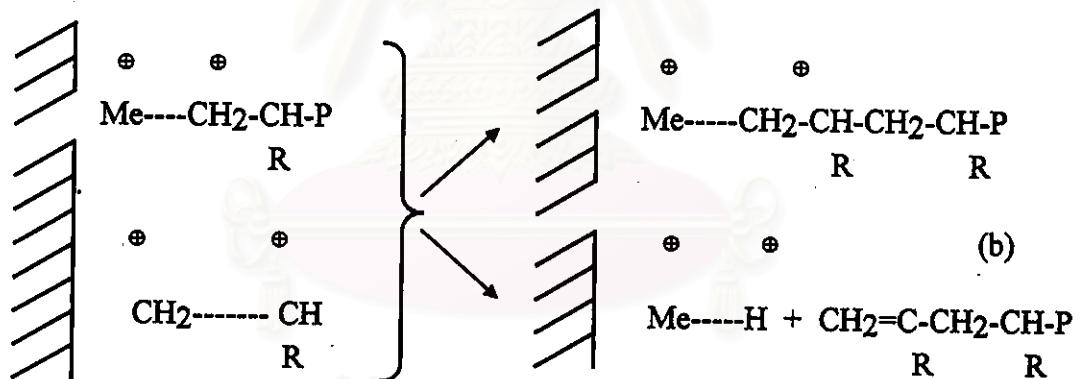

Figure 3.3 Scheme of polymerization of vinyl monomers under formation of isotactic polymer. [115]

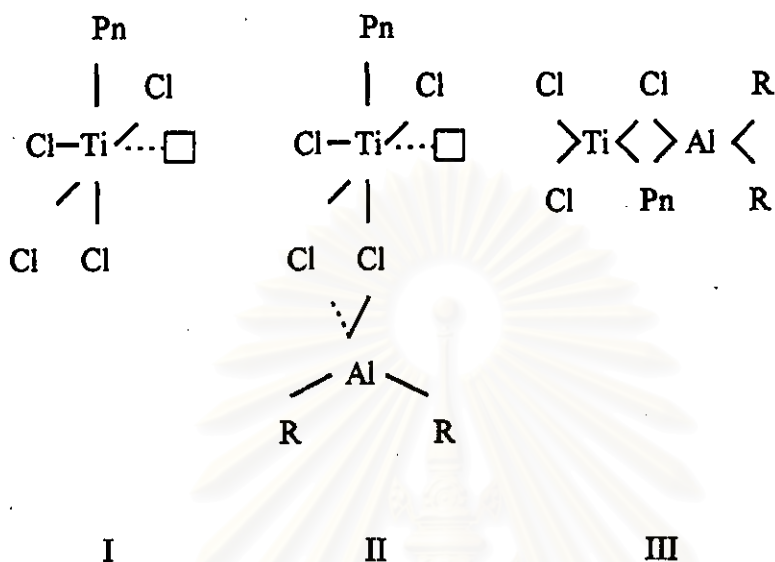

Figure 3.4 Three proposed models of active sites. [1]

3.3.2 Proposed Mechanisms

The proposed mechanistic schemes are presented here in four classification that serving a worth-while purpose in advancing Ziegler-Natta chemistry. They deserve some attention even though most are now outdated.

3.3.2.1 Propagation at a transition metal-carbon bond

The most generally accepted and the most comprehensive mechanism for olefin polymerization is that of Cossee[53,56-58]. He proposed that the active site was a transition metal atom in an octahedral configuration and that one position was vacant, □, due to a missing ligand, the remaining position being occupied by one alkyl and four ligands [53]. In structure shown below, M is the transition metal ion, R is the alkyl derived from metal alkyl or growing polymer chain, X is the ligands of crystal (Cl in TiCl_3) and □ is the vacant octahedral position.

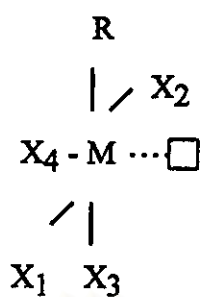

One growth step in Cossee's mechanism is shown here, as R is the growing polymer chain and \square is the vacant octahedral position.

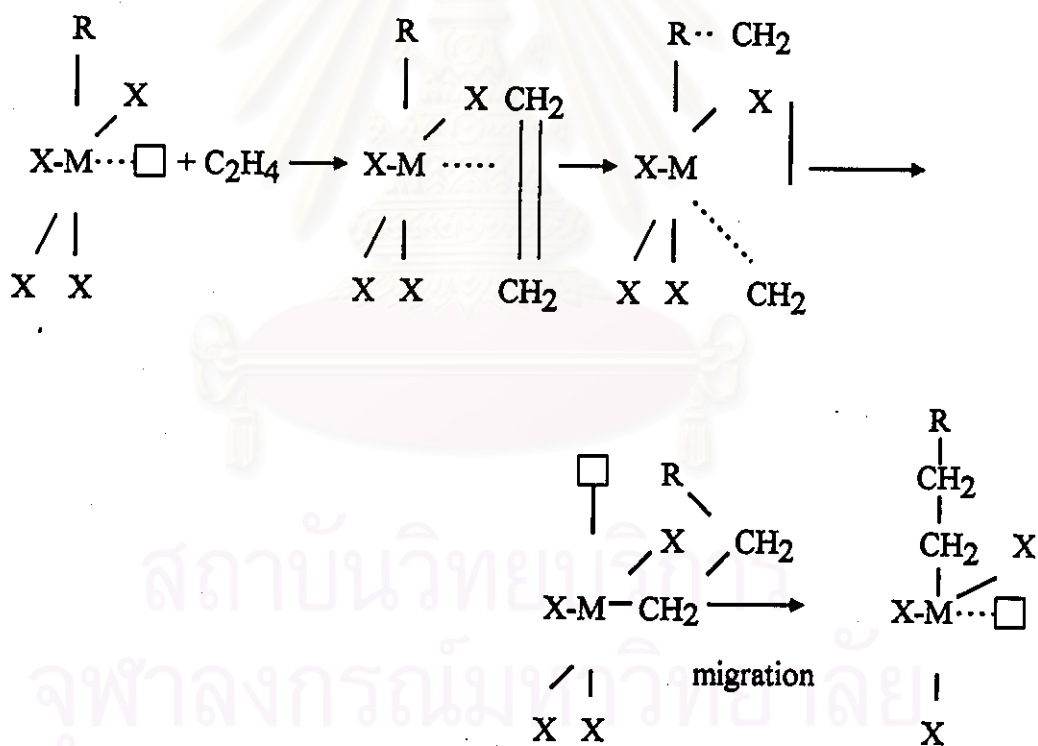

Figure 3.5 Cossee's monometallic mechanism for stereospecific polymerization [53]

Repetition of this growth step is responsible for the polymerization of the olefin to a high molecular weight polymer. In Cossee's scheme, the growing alkyl group and the vacancy exchange octahedral positions after each insertion of monomer, and the R group must migrate back to its former position.

A mechanism was proposed by De Brujin [54] in which the olefin coordinated at one titanium but is interposed into a metal-carbon bond of another titanium atom, as shown in Figure 3.6). The growing alkyl migrated between two adjacent titaniums on the surface of the TiCl_3 crystal surface.

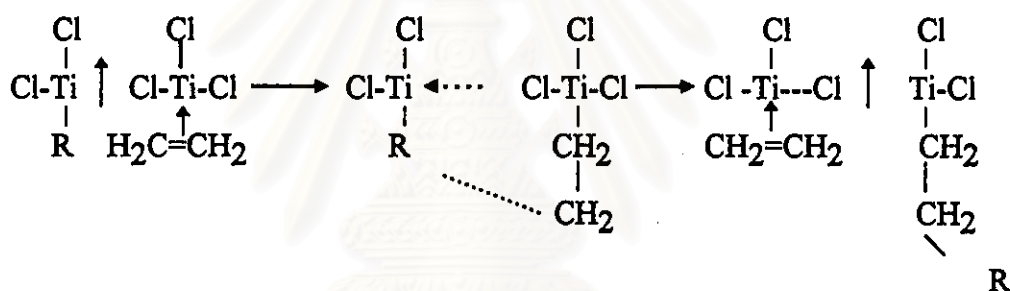

Figure 3.6 De Brujin's monometallic mechanism. [54]

Rodriguez and van Looy [55] require a complexed aluminum alkyl as an integral part of the center, even though growth takes place at a transition metal-carbon bond, as shown in Figure 3.7, where \bullet Ti and \square denotes a chlorine vacancy. This mechanism has features of the Cossee model[53], as well as of earlier bimetallic models proposed by Natta and co-workers[59], and Patat and Sinn[60]. Steric interactions between the metal alkyl and the complexed α -olefin are said to be responsible for stereochemical control.

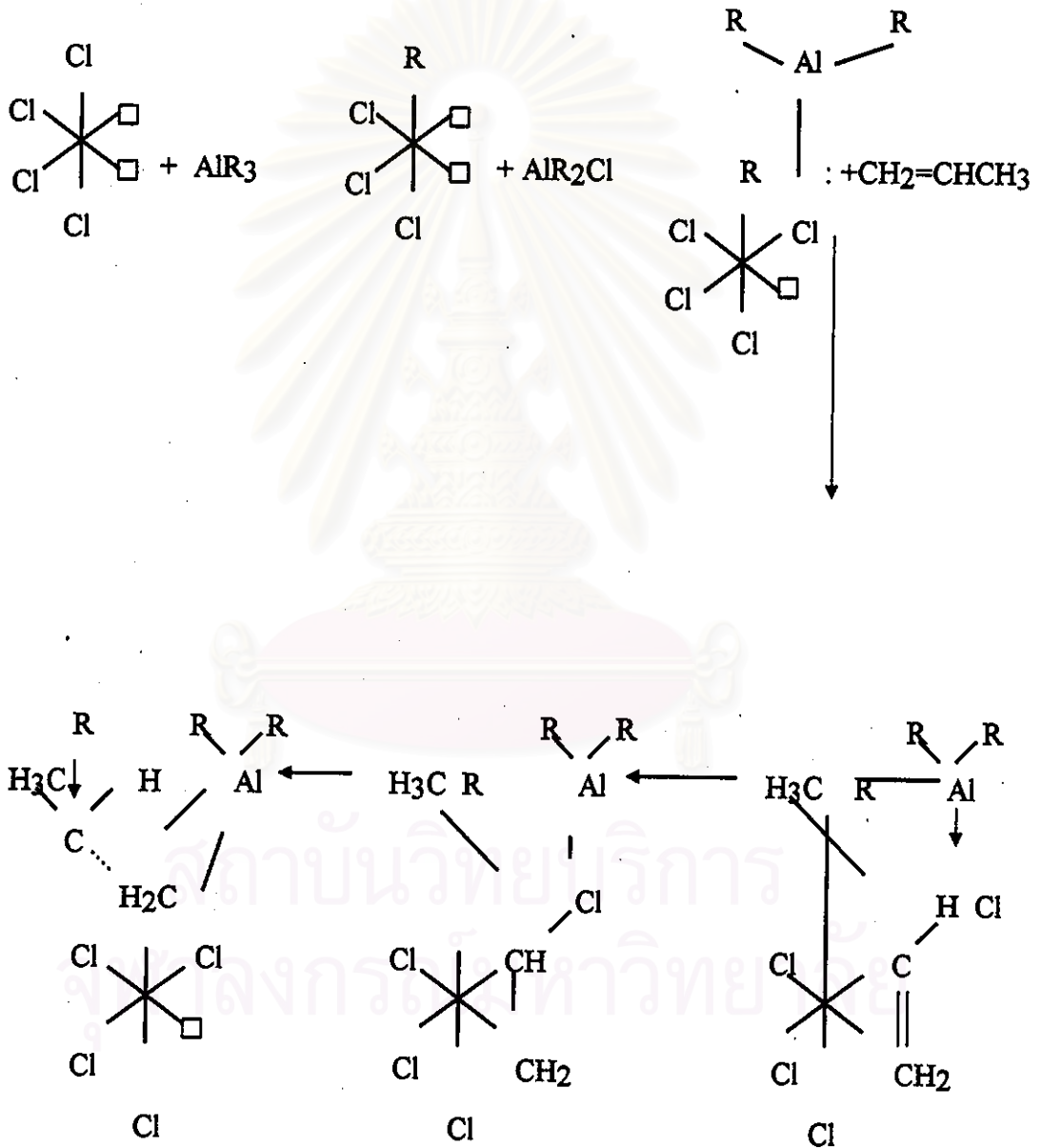

Figure 3.7 Rodriguez and van Looy's mechanism. [55]

3.3.2.2 Propagation at a base metal-carbon bond

In the early days of Ziegler-Natta history, most workers believed the growth center to be the base metal-carbon bond, that is, the Al-C bond in the catalyst $\text{AlEt}_3\text{-TiCl}_3$. Of these mechanisms, those proposed in 1960 by Natta and in 1958 by Patat and Sinn contain the most cogent features.



The structure shown above (where Pn is the growing polymer chain and X is halogen) is common to both bimetallic mechanisms. The monomer is coordinated to the titanium while the Ti-polymer partial bond is simultaneously broken.

In the Natta mechanism [59], the olefin becomes polarized and inserted into the aluminum-carbon bond.

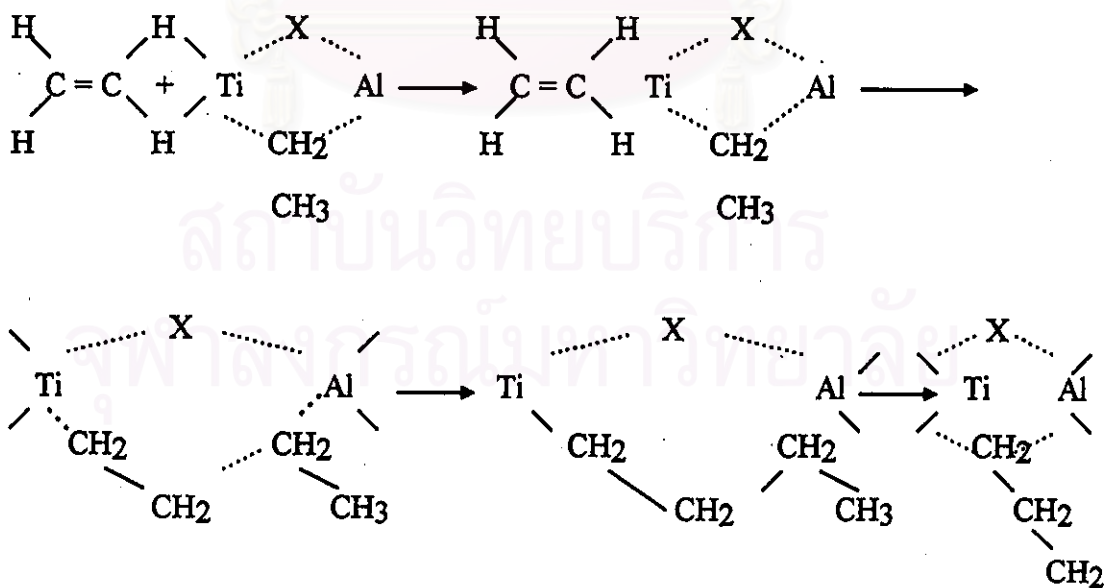

Figure 3.8 Natta's mechanism. [59]

In the Patat-Sinn mechanism [60], the olefin becomes partially bonded between the methylene of the last added monomer unit and the titanium atom. The latter is partially bonded via an alkyl bridge to the aluminum. When a bond forms between the olefin and the methylene, the methylene unit becomes detached from the aluminum and now the new methylene unit becomes partially bonded to both metal atoms.

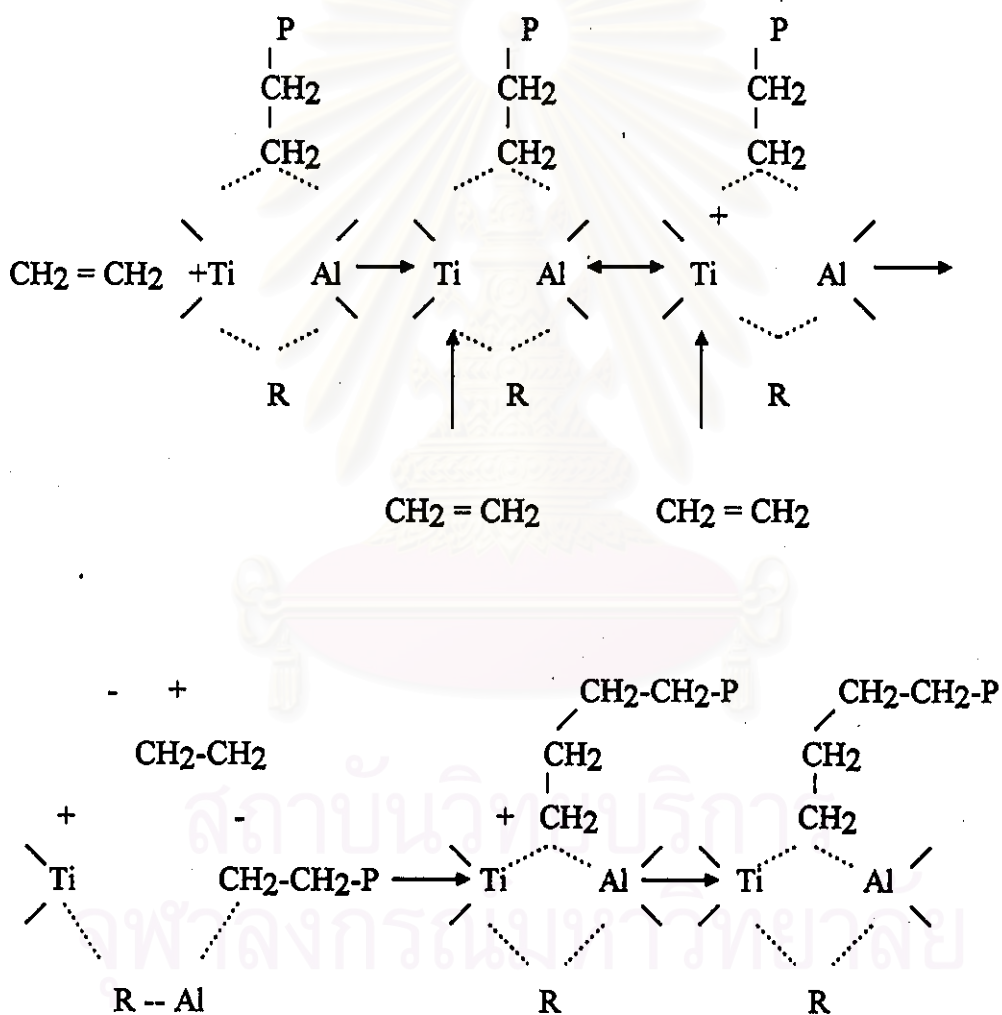

Figure 3.9 Patat-Sinn's mechanism. [60]

Other mechanistic schemes were proposed in with the Al-C was stated to be the growth center. These are mentioned briefly here, emphasizing only the salient feature of each proposal.

Boor[27] proposed a concerted mechanism as shown below, in which bond breaking and making occurred simultaneously.

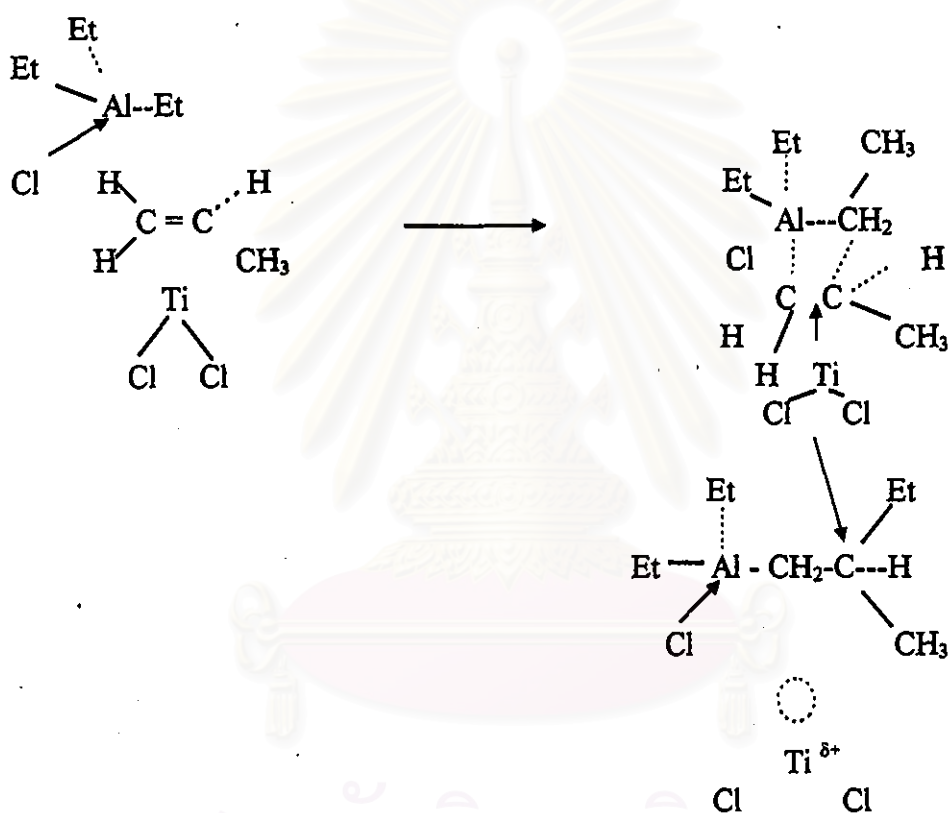
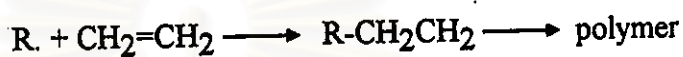

Figure 3.10 Boor's mechanism. [27]

3.3.2.3 Radical mechanism

Nenitzescu and co-workers [61] suggested the possibility of a radical mechanism, shown below.



About the same time (1956), Friedlander and Oita proposed a free radical mechanism in which initiation occurred when an electron was transferred from the metal to the olefin (Figure 3.11)

cross section

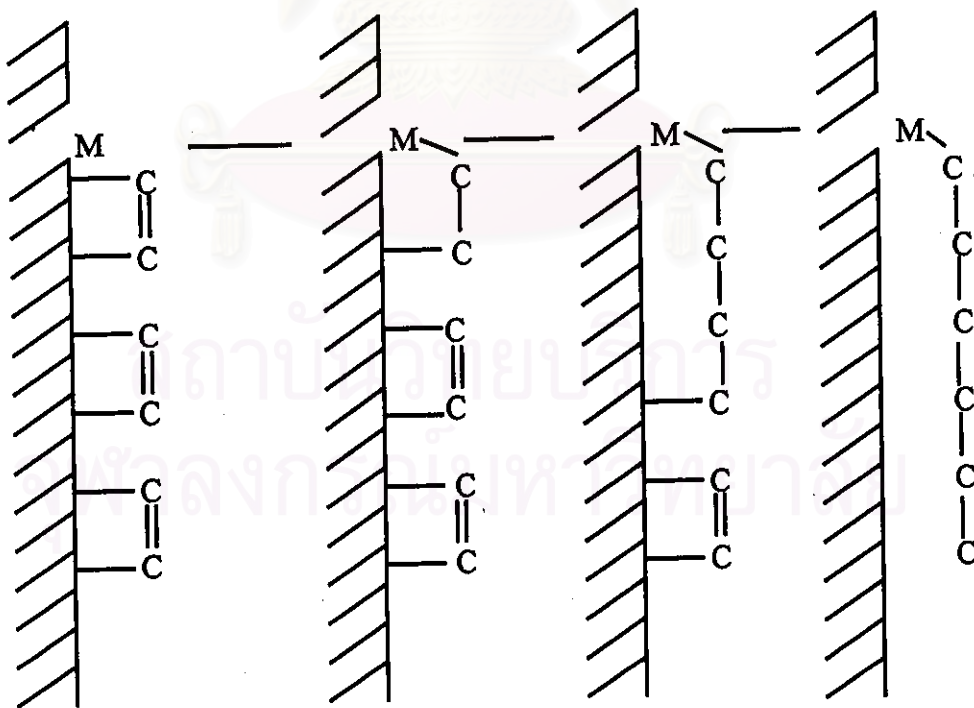

Figure 3.11 Friedlander and Oita's radical mechanism where initiation is affected by the transfer of an electron from the transition metal to the olefin. [1]

The source of the radical is the aluminum in the mechanisms of Duck [62] and Van Helden, Kooyman, and coworkers [63]. In the Duck mechanism, one aluminum center is involved,

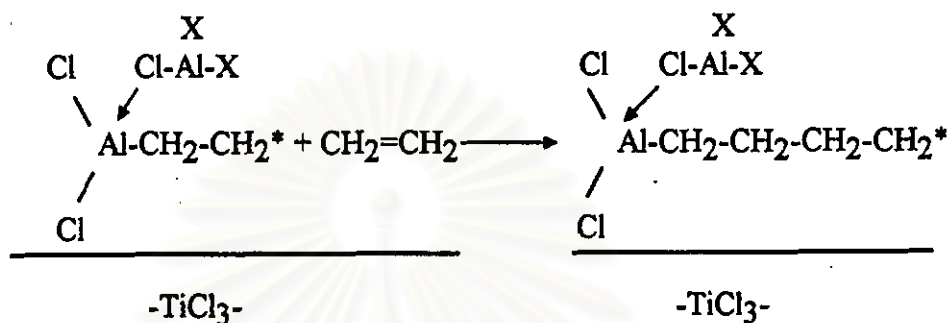

Figure 3.12 Duck's radical mechanism. [62]

while in the Van Helden, Kooyman mechanism two aluminum atoms participate (Figure 3.13). In both mechanisms, the TiCl_3 stabilizes the radical species.

3.3.2.4 Anionic mechanism

Gilchrist [64] suggested an anionic mechanism that differs from the coordinative-anionic types in that the anionic end of the polymer chain is not fixed to a metal center (Figure 3.14). A transfer of R anion from the adsorbed metal alkyl to the adsorbed olefin initiates the polymerization. Propagation occurs because this anionic end continues to add to adsorbed olefin molecules.

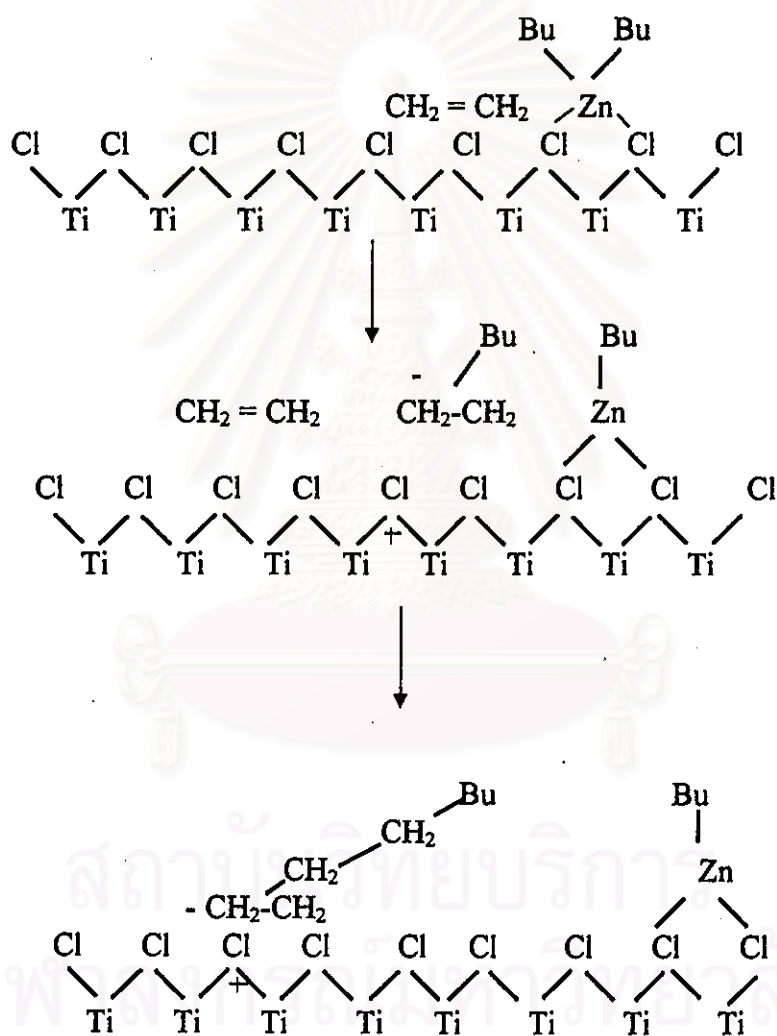

Figure 3.14 Gilchrist's anionic mechanism. [64]

3.4 MECHANISM FOR STEREOCHEMICAL CONTROL OF α -OLEFINS

3.4.1 Mode of Addition

This section considers the importance of complexing, cis- vs. trans-addition and primary vs. secondary addition.

Most workers such as Danusso and Sianesi [65] and Henrici-Olive and Olive [66] have taken the view that the olefin molecule forms a complex with the transition metal atom of the active center just before it is inserted into the metal-carbon bond.

The addition of olefin molecules in both isotactic and syndiotactic propagations was cis-insertion, or more accurately, by cis-ligand migration was shown by Natta [18], Miyazawa [67], and Zambelli and their co-workers [68].

The α -olefin can potentially add in two ways, primary addition, as shown in (3.2), or secondary addition, as in (3.3).

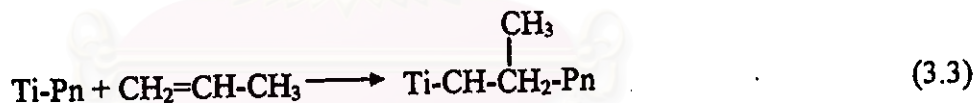
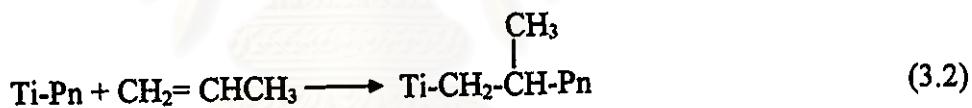

These two-modes differ in the way the α -olefin becomes inserted, that is, the unsubstituted end becomes attached to Ti in a primary addition, while in the secondary addition, it is the substituted end that becomes attached to Ti.

3.4.2 Isotactic Propagation

The discovery by Natta and co-workers that some binary mixtures of metal alkyls and transition metal salts were able to polymerize α -olefin to isotactic polymers is just as remarkable as their ability to polymerize these olefins at all. It was also Natta who

first recognized the importance of crystal surface as the primary driving force for the isotactic propagation of α -olefin. These are presented here according to the following themes : (1) active participation of metal alkyl molecule, (2) steric repulsions between the α -olefin and the ligands of the center, (3) active participation of the helix, and (4) other models.

3.4.2.1. Active Participation of the Metal Alkyl

Natta [22] suggested that the active centers in the isotactic-specific heterogeneous catalyst were bimetallic complexes of metal alkyl molecules and transition metal atoms that were located on the surface of the crystal. Rokiguez and Van Looy [55] agreed with Natta and proposed the path of isotactic propagation, as shown in (3.4).

From their experiment data, they concluded that these titanium centers were present on lateral faces and defects. They proposed that each Ti had two missing chlorines (vacancies). Isotactic orientation was favored because the propylene molecule can complex with the exposed Ti center only in one configuration, that is, with its methyl group directed away from the alkyl groups of the aluminum atoms.

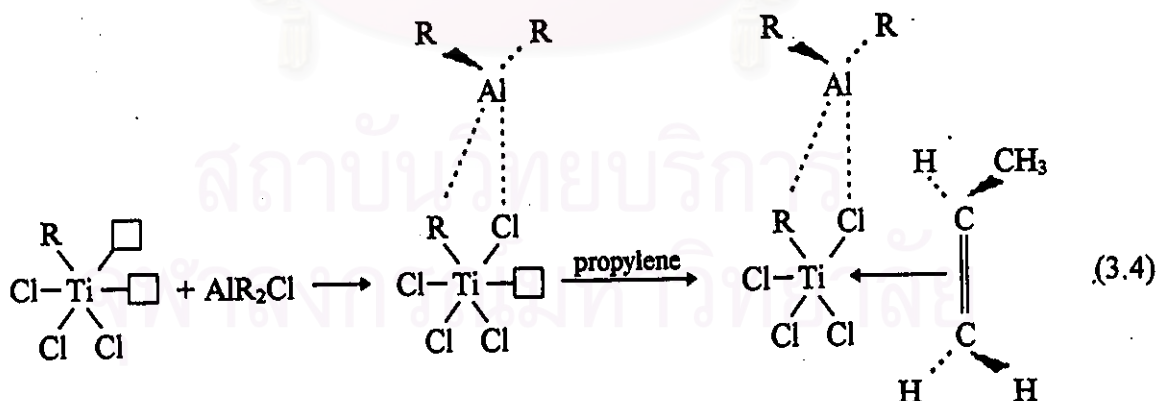

3.4.2.2. Steric Repulsions between the Olefin and Ligands of the Center

The basic idea of these proposals is that the preferred complexing mode minimized steric interactions between the pendent group of the α -olefin and the ligands of the active center to which it is complexed as well as adjacent atoms. The isotactic scheme had its beginning in the recognition by Natta in 1955 that the isotactic propagation required an specific surface of crystalline transition metal salts.

The idea that isotactic propagation is intimately linked to the geometry of an exposed Ti (chlorine vacancy) was worked out independently for both bimetallic complexes and monoalkylated titaniums as active centers. The exposed Ti is an important feature of these mechanisms in two ways: (1) the olefin can complex at the vacant octahedral position and thereby its energetics become more suitable for addition, and (2) the unique ligand environment can force or favor an complexing mode corresponding to one or the other configuration.

3.4.2.3. Active Participation of the Helix

Coover [69] speculated that the rate of placement preserving the symmetry of the helix was faster than the rate of the alternate placement. Thus, the driving force was due to preferential placement of the α -olefin as a result of interactions between the α -olefin and the helix.

3.4.2.4. Other Models

Luisi and Mazo [70] have developed a statistical model that would predict the formation of isotactic, atactic, syndiotactic, and stereoblock polymer in terms of the asymmetry of the active center and the interactions of the incoming monomers, as well as those added last. Since these parameters are not measurable, predictions cannot yet be made with this model.

3.5 GROWTH AND REPLICATION OF POLYMER PARTICLE

The growth of the polymer particle has aroused much interest in both academic and industrial laboratories. The reasons are twofold : on one hand, it was felt that if we understood the mechanistic path by which olefin is converted in polymer particles, then our knowledge of Ziegler-Natta catalysts will be more complete. We might, for example, learn how active centers distributed on the surface of the catalyst.

The second reason was more practical and of much importance for the commercial producers of polyolefins. The industrial motivation stemmed from the observation that heterogeneous Ziegler-Natta catalysts are uniquely capable of replicating their morphology into the morphology of the progeny polymer particles. This discovery was very important because it enabled workers to easily control the polymer particle morphology by controlling the morphology of the transition metal salt, such as $TiCl_3$. By morphology, we mean the size, shape, density, and texture which the particle has.

During the formation of the polymer, the $TiCl_3$ particle becomes dispersed throughout the polymer particle. The architecture of the $TiCl_3$ particle is largely determined by the method used for its synthesis. Secondary $TiCl_3$ particles formed by reduction of $TiCl_4$ with aluminum alkyls can be very large (40 μm) but they are in fact comprised of many much smaller primary particles, about 0.01 to 0.1 μm diameters. Growth of the polymer takes place on these primary particles, and they remain within the same polymer particle because the formed polymer acts to cement them. Several substructures have been identified. How the polymer chains are assembled to form the substructures and eventually the optically visible polymer particle is not yet completely understood. The whole particle consists of substructured that are formed polymer chains by one or more paths. Very probably, the paths by which polymer chains are assembled are affected by the catalyst surface, the mechanics of growth and crystallization, and external conditions such as stirring.

3.6 MODIFICATION OF ZIEGLER-NATTA CATALYSTS BY THIRD COMPONENTS

Most of the third components cited in the literature can complex or react with aluminum alkyls[87]. When they also complex or react with the transition metal salt or with the reaction by-product formed when the aluminum, alkyl and the transition metal salt react, several equilibria or reaction paths are possible. Consider, for example, the following complexes formed when Et_3N is added to a mixture of AlEt_2Cl and TiCl_3 .

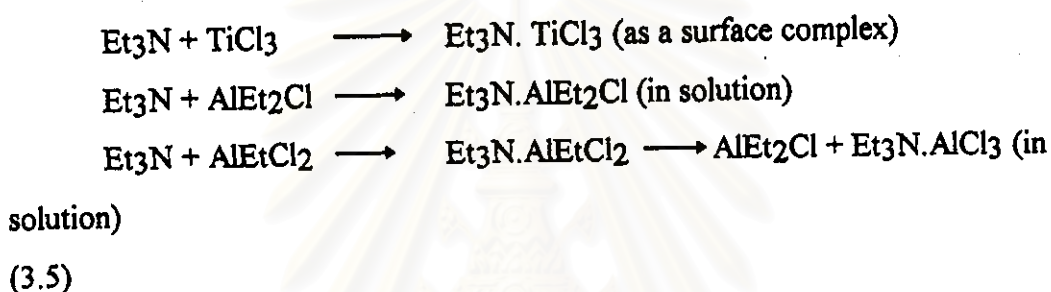

(AlEtCl_2 can be formed during site formation, that is, alkylation by AlEt_2Cl of the TiCl_3 species located on surface of the TiCl_3 crystallite.)

If the third component reacts with both the metal alkyl and transition metal salt, then the actual catalyst is a mixture of several reactants, as shown in (3.6).

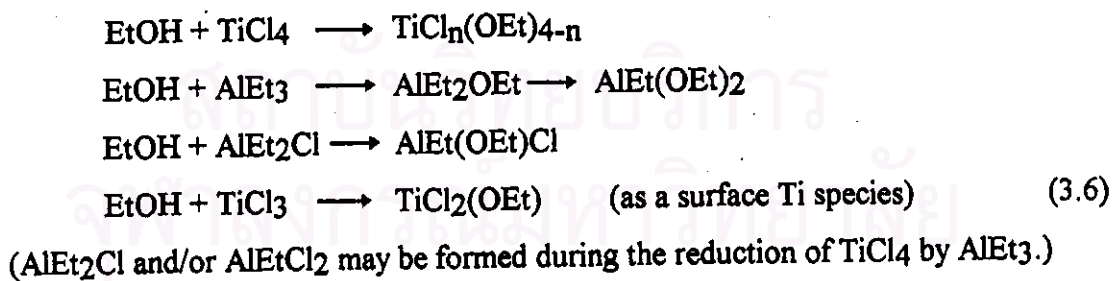

Depending on the concentration of reactants, mode of mixing, temperature and time of reaction and use in polymerization, and other factors, the working catalyst may have a variable composition. It is most difficult, if not impossible, in many of these cases to explain the role of the third component precisely.

3.6.1 The Different Ways that a Donor (or Reactant) Can Affect a Ziegler-Natta Polymerization

1. Activity and Isotacticity

As mentioned in Chapter 2, electrons always increase isotacticity of Ziegler-Natta catalyst but decrease catalyst's activity [7,8,11].

This behavior was described by Kashiwa, Yoshitake and Toyota [8]. They proposed two assumptions about the action of electron donor to active center.

Assumption (1) ; The change of propagation rate constant by electron donor. Electron donor would associated with the active center mildly or strongly depending on the concentration of electron donor and stereospecificity of the active centers having the different acidity (the more specificity would be less acidic). The mild association would result in the increase of both propagation rate constant (k_p) by the unknown effects and the steric hindrance at the subject active center, while the strong one would in the deactivation by the saturation of the coordination sites (Figure 3.15). Thus the increase of isotactic polymer would be explained by the mild association of electron donor to the highly stereospecific active centers.

Assumption (2); The change of the number of active centers by electron donor. A part of electron donor would transform the less or non-stereospecific active centers into the highly stereospecific active centers to result in the increase of isotacticity, for example, by the partial saturation of the plural vacant coordination sites, increasing the steric hindrance at the active centers. Another part of electron donor would lower the number of the active centers by the complete saturation as shown in Figure 3.16.

In summary, electron donor directly takes part in the formation of apart of the highly stereospecific active centers to increase yield and stereospecificity and at the same time, electron donor would deactivate the less or non-stereospecific active centers with high efficiency.

1) strong association

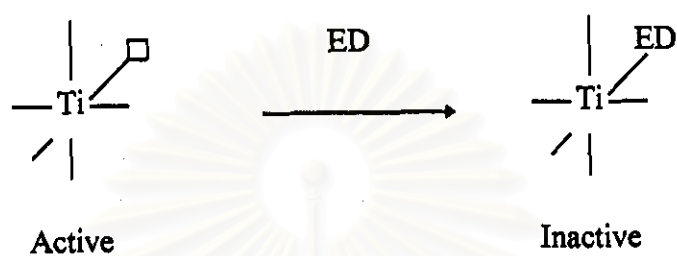

2) mild association

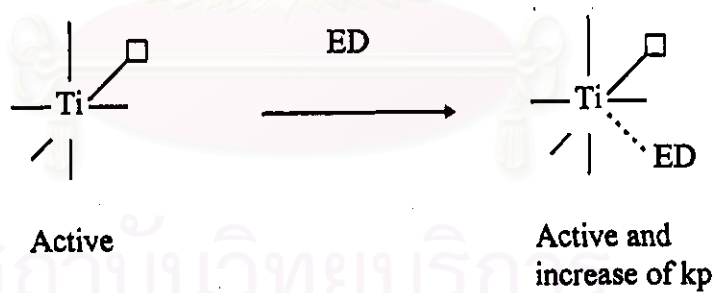

Figure 3.15 Assumption (1) the change of propagation ratio constant by Electron donor (\square = vacant site and ED = electron donor) [8]

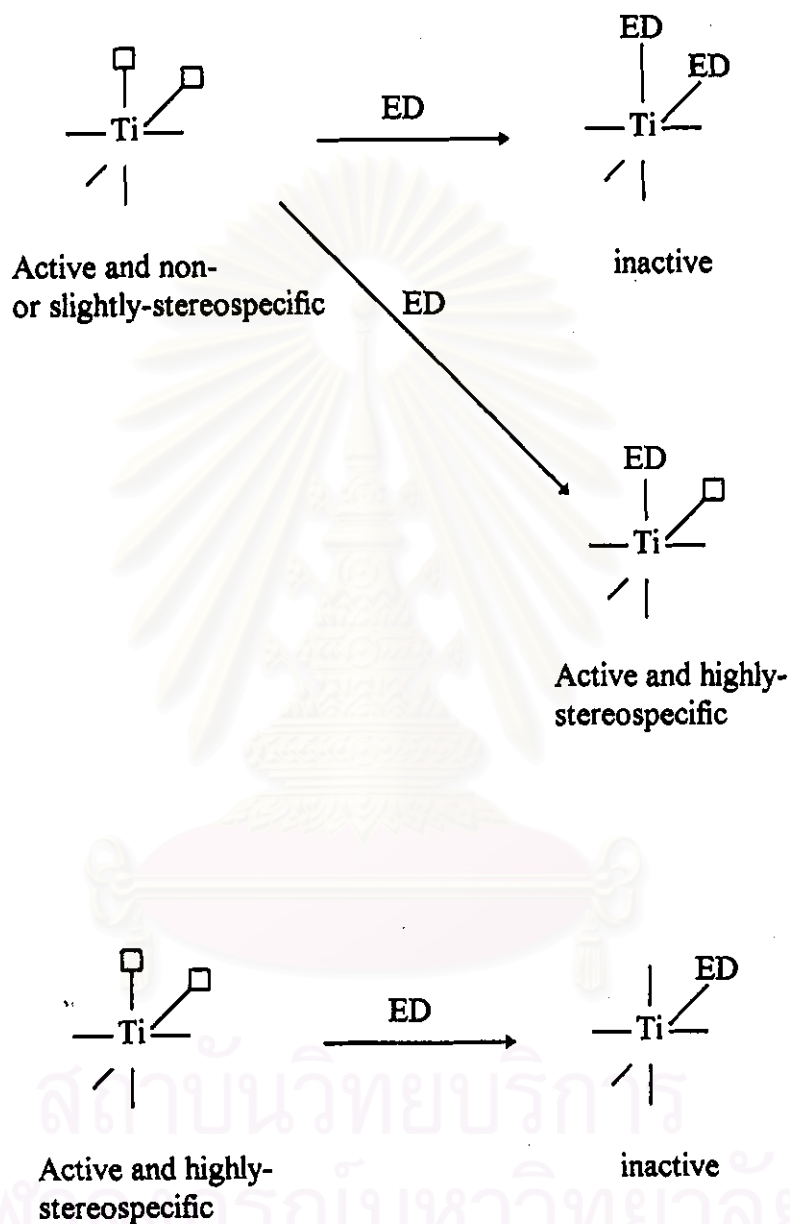

Figure 3.16 Assumption (2) the change of the number of active center by electron donor (\square = vacant site and ED = electron donor) [8]

2. Copolymerization Behavior

The copolymerization behavior of a catalyst can be altered. An improved copolymerization catalyst was reported if VCl_3 was reacted with R_4NCl , as shown in (3.7), and the product was combined with $Al-i-Bu_2Cl$ [72].



The molecular weight of ethylene-propylene copolymer was regulated by use of pyridine N-oxide when the catalyst $Al_2Et_3Cl_3 - VOCl_3$ was used [73]

3. Molecular Weight Control

Dost and co-workers [74] recognized that electron donors can increase or lower molecular weights of formed polyethylene when added to Ziegler-Natta catalysts; for example, aldehydes, esters and amines were added to the $AlR_3 - TiCl_4$ catalysts. The molecular weight distribution can be altered by presence of donors. Erofeev [55] reported that the width of the molecular weight distribution was narrowed by the presence of anisole in the $AlEt_2Cl - TiCl_4$ catalyst. This was attributed to diminution of low molecular weight fractions. M_w / M_n values 4.3 to 9.4 were observed, compared to values 13 to 16 for unmodified catalysts.

3.6.2 Selected Mechanistic Proposals

1. Inactivation of the Poison by a Donor

A poison is formed during site formation, and the donor removes this poison by complexing it. This argument was put forth by Caunt to explain the activating affect of inorganic halides (KCl) and electron donors (amines) when added to the $AlEt_2Cl - TiCl_3$ catalyst [75]. Specially he proposed that third components complex and inactivate the poison $AlEtCl_2$, which was formed when $AlEt_2Cl$ and $TiCl_3$ were mixed.

2. Lowered Concentration of the Metal Alkyl

An electron donor complexes the metal alkyl and decreases its effective concentration. Processes such as site formation and chain transfer reactions are affected. Vinogradov and co-workers [76] studied the effect of electron donors and

acceptors on the polymerization of butadiene in the presence of the Al-*i*-Bu₂Cl-CoCl₂ catalyst. They suggested that the effect of the additives was to shift the equilibrium as shown in (3.8).

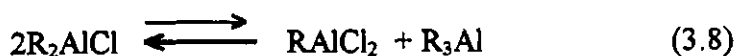

Those donors which shifted the equilibrium to the right (RSR, ROR, R₃N, KCl and NaCl) enhanced the reduction efficiency of the system. Consequently, the catalyst was less active, lower molecular weight polymers were formed, and 1, 2 - microstructure was favored. But if donors that shifted the equilibrium to the left (such as AlCl₃, RAlCl₂, Br₂, H₂O, and aioxane of AlEt₂Cl) were added, an increase in catalyst activity, an increase in cis-1, 4 structure, and higher molecular weight polymers were obtained.

3. Formation of the New Metal Alkyl

The third component reacts with the metal alkyl to generate a new metal alkyl ; for example

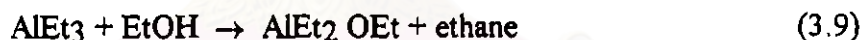

The catalyst may exclusively contain the new metal alkyl or a mixture of AlEt₃ and AlEt₂ Oet. Any compound that can react with the active metal-carbon bonds of the metal alkyl may act similarly, such as EtSH, COS, CS₂ O₂, RCHO, R₂CO, alkyl halides. If the reaction of the third component and the metal alkyl is incomplete, then unreacted molecules may also react with the active centers (the transition metal-carbon bonds). Thus, a decline in rate due to the reactant may also occur in this way [77] . Inorganic salts such as KCl and NaF form complexes with aluminium alkyls [77], and it has been proposed that the complex is inactive [77] or the complex is more active. Again, the choices of donor and condition of use are critical.

4. Activation of Dead Centers.

Under the condition of the polymerization, the active centers undergo reduction to a lower valence state metal species that are no longer active for polymerization of the olefin. The third component oxidizes this inactive species to a higher valence state compound, which is easily realkylated to form an active center.

Chirstman [78] examined the effect of a series of polyhaloorganic molecules on the activity of several soluble vanadium-based catalysts for the polymerization of ethylene at 120°C in some details. In the absence of a promotor, yields were low. When promotor was added continuously throughout the polymerization, high yields of polymer per mmole vanadium were obtained.

5. Change in the Physical State of the Transition Metal Salt.

Some distinct schemes were suggested. Minsker and Bykhovskii [79] suggested that amine molecules that complexed on the surface of $TiCl_3$ facilitate the breakdown of the crystals along the plane of cleavage. By virtue of a greater surface area, more sites can form for polymerization of propylene.

Razuvaev, Minsker, and Chernovskaya [80,81] proposed that aromatic type electron donors in the $AlEt_3-TiCl_3$ catalyst (propylene) changed the energetic conditions at the surface of $TiCl_3$ and the strength of the $AlEt_3-TiCl_3$ complex. Compounds at concentrations of 0.2 to 3 moles per liter solvent increased activity but lowered polymer isotacticity and molecular weight. But in other experiments, they observed that ethers increased catalyst activities and molecular weights and proposed that the donor aids in the complexing of propylene at the center [82].

3.7 SUPPORTED ZIEGLER-NATTA CATALYSTS

The term supported catalyst is used in a very wide sense and includes not only systems in which the transition metal compound is linked to the substrate by means of a chemical bond but also systems in which the transition metal atom may occupy a

position in a lattice structure, or where complexation, absorption, or even occlusion may take place.

1. Catalyst based on reaction products of hydroxyl-containing compounds with transition metal compounds

The use of SiO_2 , Al_2O_3 , etc. to chemically anchor transition metal compounds has been widespread since the early 1960s. Heat treatment of SiO_2 can control the number and type of surface hydroxyl groups and indirectly the amount and distribution of transition metal atoms which are anchored to the surface (3.10). [83-89]

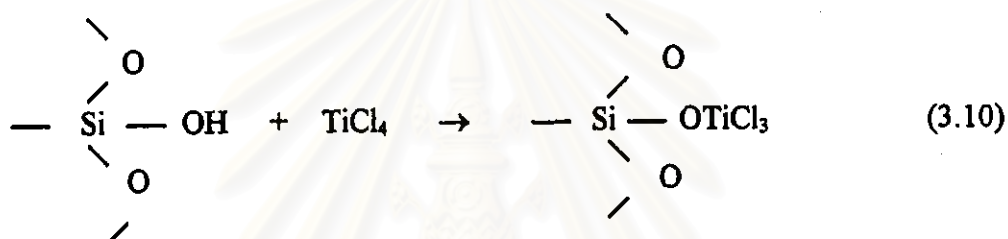

Chemically anchored transition metal catalysts have been used industrially for the preparation of high density linear polyethylene and ethylene- α -alkene copolymer. Karol [90] has divided such catalysts into three classes: (i) metal oxide, particularly $\text{CrO}_3/\text{SiO}_2$; (ii) Ziegler, particularly $\text{Mg}(\text{OH})\text{Cl}/\text{TiCl}_4 + \text{AlR}_3$; and (iii) organotransition metal, particularly $(\text{C}_3\text{H}_5)_2\text{Cr}/\text{SiO}_2$.

Many of these catalyst systems exhibit high activity in the polymerization of ethylene, but are not, however, useful for the polymerization of propylene and α -alkenes. Typical examples are listed in Table 3.1.

2. Catalysts based on reaction products of magnesium alkoxides with transition metal compounds

Superactive catalysts for ethylene polymerization have been prepared by reacting titanium tetrachloride with magnesium alkoxides. The original structure of the alkoxides is usually destroyed during reaction and new species of increased surface area produced.

Böhm [91] has described the use of a highly active catalyst containing 8.5 % by weight Ti, derived from $\text{Mg}(\text{OEt})_2$ and TiCl_4 and using AlEt_3 as cocatalyst. The solid catalyst produced from $\text{Mg}(\text{OEt})_2$ and TiCl_4 was amorphous and had a surface area of $60 \text{ m}^2\text{g}^{-1}$ and a high porosity, 61 % of the catalyst particles consisting of cavities. These hollow-type structures would account for the complete disintegration of the catalyst particles observed during polymerization. Final catalyst residues were reported to be smaller than $0.0005 \mu\text{m}$ in diameter.

High ratios of Al:Ti are required for maximum activities. Böhm reported the use of Al:Ti of 80-100:1. These catalysts show no settling periods and reach their high activity right at the start of the polymerization.

Some typical examples are listed in Table 3.2.

3. Catalysts based on reaction products of magnesium alkyls and titanium compounds

The reaction between magnesium alkyls and titanium compounds have been used as a means of preparing highly active catalyst systems. Stamicarbon [92] have prepared highly active catalysts using AlEt_2Cl_2 , Bu_2Mg and TiCl_4 . Shell International Research [92,93] have used the reduction of TiCl_4 with organomagnesium compounds to prepare highly active catalysts for ethylene polymerization. These catalyst systems have been extensively investigated by Haward and co-workers, [32] as well as by Radenkov et al. [94-97]. Characterization studies have revealed that the catalysts contain appreciable amounts of magnesium chloride and that they have nodular structures. The size of the primary particles is believed to be less than $0.05 \mu\text{m}$.

4. Catalysts based on reaction products of magnesium chloride with transition metal compounds

Some of the most promising catalysts, especially for propylene polymerization, have resulted from the use of magnesium chloride as support. An early patent in 1960 described the use of ground MgCl_2 with electron donors in propylene polymerization. [5]. However, it was the discoveries by Montecatini-Edison Co. [4] and Mitsui Petrochemicals Ind. [5] that catalysts, prepared from MgCl_2 , TiCl_4 and

electron donors, and activated by a mixture of trialkylaluminum and electron donor, could polymerize propylene with a high yield [$> 50 \text{ kgPP}(\text{gTi})^{-1}$] and with good stereospecificity

(isotactic index $> 90\%$), that have set the scene for much of the present explosion in catalyst development. The initial patents describe two basic routes for catalyst preparation.

Typically at 30-fold molar excess of very carefully dried anhydrous MgCl_2 in ball milled with a TiCl_4 -electron donor complex, such as TiCl_4 :ethylbenzoate, washed with n-heptane, and dried. The catalyst is then activated using a cocatalyst mixture consisting of trialkylaluminum (TAA) and ethyl benzoate (EB) such that TAA:EB:Ti = 300:10:1.

Alternatively, dried anhydrous MgCl_2 is ball milled for 20 h at $0-5^\circ\text{C}$ with EB ($\text{MgCl}_2 : \text{EB} = 1 : 0.15$) and then treated with neat TiCl_4 at $80-130^\circ\text{C}$ for 2 h, washed with n-heptane, and finally dried, yielding a pale yellow solid catalyst containing typically 1-5 % Ti and 5-20 % EB. This catalyst is then activated by treatment with a mixture of trialkylaluminum and electron donor (e.g. ethyl benzoate, p-ethyl benzoate, p-ethyl anisate, p-methyl toluate, etc.).

Since 1968 many hundreds of related catalysts have been claimed in the patent literature for ethylene, propylene and other α -alkene polymerization. Some selected examples are listed in Table 3.3 with additional examples to be found in the literature.

'Activated' MgCl_2 , a key ingredient of these catalyst systems, has been known for some time, being mentioned by Bryce-Smith [37] in 1959, and described by Kamienski [38] in 1967. A number of preparation methods are available and include; (i) treatment of MgCl_2 with activating agents such as electron donors; (ii) ball milling MgCl_2 ; and (iii) reaction of compounds such as Grignard reagents with chlorinating agents. All three procedures have been found useful in catalyst preparation.

(a) Effect of ball milling. Magnesium dichloride seems almost uniquely suitable as a support in propylene polymerization, other possible substrates including calcium hydride [98] and manganese dichloride. The reason for this unique behavior is believed to be associated with similarities between the ionic radii of Ti^{4+} and Mg^{2+} which are 0.68 and 0.65 \AA respectively. Magnesium dichloride may exist as a cubic

close-packed structure of double chlorine layers with interstitial Mg^{2+} ions in six-fold coordination. [99] This layer structure is of the CdCl_2 type and leads to a characteristic X-ray diffraction spectrum with a strong reflection 104 at $d = 2.78 \text{ \AA}$.

The introduction of structural faults is believed to explain the activity of ball-milled magnesium dichloride.

Giannini has reported that during ball milling the X-ray diffraction at $d = 2.5 \text{ \AA}$ gradually disappears and is replaced by a broad halo at $d = 2.65 \text{ \AA}$, a position intermediate between diffractions 104 for cubic and hexagonal structures, and Giannini has attributed this behavior as arising from stacking faults induced by the rotation of Cl-Mg-Cl layers [100]. From their extensive studies on activated MgCl_2 (in presence of TiCl_4) is similar to that proposed for $\delta\text{-TiCl}_3$. [101] Additional factors such as surface area and porosity are also believed to be important in determining activity. However, studies by Gerbasi et al. [102] would indicate that activity is related to the introduction of defects alone.

Representations of commercial and ball-milled MgCl_2 crystallites are shown in Figure 3.18.

Goodall [103] has proposed the existence of three different types of surface magnesium ions in milled MgCl_2 : (i) type 1, present on lateral faces, with single vacancy Mg ions, having an effective charge of $0e$; (ii) type 2, present on corners, with single vacancy Mg ions having an effective charge of $-2/3e$; and (iii) type 3, present on corners, with double vacancy Mg ions having an effective charge of $+1/3e$. The various types of surface magnesium ions are shown in Figure 3.19.

Table 3.1 Catalysts Based on Reaction Products of Surface Hydroxyl-containing Compounds with Transition Metal Compounds [118]

Catalyst	Company	Patent Number
Transition metal compounds reacted with SiO_2 , Al_2O_3 , $\text{SiO}_2\text{-Al}_2\text{O}_3$, ZrO_2 , TiO_2 , ThO , MgO , etc	Cabot	Br. 969 761 (1960-1963) 969 767 916 132 1 038 882
Transition metal compound reacted with a hydroxy chloride of a bivalent metal preferably Mg(OH)Cl	Solvay & Cie	Belg. 650 679 (1963) Br. 1 024 336 (1963)
Transition metal halide reacted with Mg(OH)_2	Mitsui Petrochem. Ind. Solvay & Cie Montecatini Hoechst AG	Jpn. 70 40 295 (1967) Belg. 726 839 (1968) Belg. 728 002 (1968) Belg. 735 291 (1968)
Transition metal benzyl and allyl compounds reacted with SiO_2 , Al_2O_3 , $\text{Al}_2\text{O}_3\text{-ZnO}$, $\text{Al}_2\text{O}_3\text{-MgO}$	Imperial Chemical Industries	Br. 1 265 747 (1969) Br. 1 314 828 (1969)
Bis(triphenylsilyl) chromate reacted with $\text{SiO}_2\text{-Al}_2\text{O}_3$ or SiO_2	Union Carbide	US 3 324 095 (1967)

Table 3.2 Selected Catalysts Based on Reaction Products of Magnesium Alkoxides with Transition Metal Compounds[18]

Catalyst	Company	Patent Number
1. Transition metal halide reacted with Mg(OR)_2 , etc.	Hoechst AG	Belg. 737 778 (1968) US 3 644 318 (1968)
2. Transition metal halide reacted with Mg(OR)_2 , etc.	Solvay & Cie	Belg. 743 325 (1969)
3. Transition metal compound reacted with Mg(OR)_2 and acid halide	Hoechst AG	Belg. 780 530 (1971)
4. $\text{Ti(OPr)}_4 + \text{Mg(OEt)}_2 + \text{SiCl}_4$	Hoechst AG	Br. 1 357 474 (1974)
5. $\text{TiCl}_4 + \text{Mg(OEt)}_2 + \text{THF}$, etc.	Hoechst AG	Ger. 3 231 031 (1984)
6. $(\text{Mg(OEt)}_2 + \text{AlEt}_3) + \text{TiCl}_4 + 1,2\text{-dichloroethane} + \text{EB}$	Standard Oil (Amoco)	US 4 567 155 (1986)
7. $\text{Mg(OEt)}_2 + \text{TiCl}_4 + \text{EB}$	Shell Int. Res. Mij. BV	Eur. 0 159 736 (1985) US 4 535 068 (1985)
8. $(\text{Mg(OEt)}_2 + \text{SiHCl}_3) + \text{TiCl}_4$	Toa Nenryo Kogyo KK	Eur. 0 227 455 (1987)
9. $\text{Ti(OBu)}_4 + \text{Mg(OSiMeBuPh)}_2$	Conoco	US 4 440 869 (1984)
10. $\text{Mg[OCH(CF}_3)_2]_2 + \text{TiCl}_4 + \text{HSiCl}_3$	Phillips Petroleum Co.	US 4 559 317 (1985)

Table 3.3 Some Selected Magnesium Chloride Catalysts [118]

Company	Catalyst System	Patent Number
Phillips Petroleum Co.	MgCl ₂ milled with TiCl ₄ ethyl benzoate complex and durene; used with AlEt ₃ + ethyl anisate	Belg. 843 224 (1975)
Montedison Spa	MgCl ₂ milled with TiCl ₄ ethyl benzoate complex; used with AlEt ₃ + methyl <i>p</i> -toluate	Belg. 845 593 (1975)
Mitsui Petrochem. Ind. KK	Mg(OPh) ₂ milled with ethyl benzoate; reacted with TiCl ₄ ; used with AlEt ₃ and <i>p</i> -toluate	Belg. 856 189 (1976)
Mitsui Toatsu Chem. Inc.	MgCl ₂ milled with AlCl ₃ ethyl benzoate; treated with TiCl ₄ ; used with AlEt ₃	Ger. 2 734 652 (1976)
Mitsui Petrochem. Ind. KK	MgCl ₂ milled with ethyl benzoate and silicone oil; <i>p</i> -cresol added then AlEt ₃ ; then TiCl ₄ ; used with AlEt ₃ + methyl <i>p</i> -toluate	Ger. 2 809 318 (1977)
Exxon Res. and Eng. Co.	MgCl ₂ milled with TiCl ₄ ethyl benzoate complex; product treated with TiCl ₄ ; used with (Me ₃ SiCH ₂) ₂ AlEt	Eur. 4739 (1978)
BASF AG	Mg(OEt) ₂ milled with PhCOCl; treated twice with TiCl ₄ ; used with Et ₃ Al + ethyl anisate	Ger. 2 831 830 (1978)
Montedison Spa	MgO treated with SOCl ₂ ; product treated with ethyl benzoate and EtOH and then TiCl ₄	Belg. 875 494 (1978)

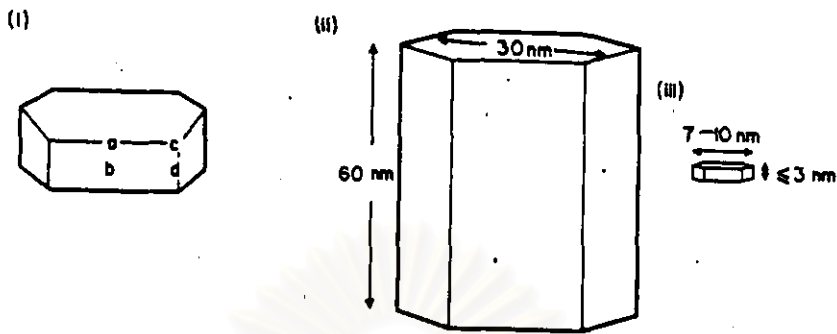

Figure 3.17 Influence of milling on magnesium chloride (I) MgCl_2 crystalline in which a = basal edge, b = lateral facet, c = corner, d = lateral edge; (ii) commercially available MgCl_2 ; and (iii) ball milled MgCl_2 [118]

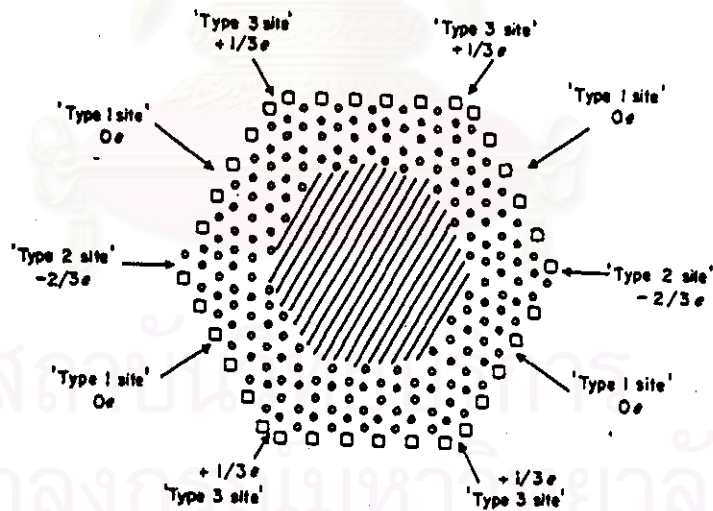

Figure 3.18 MgCl_2 crystalline (two-dimensional view in which \bigcirc = Mg, \bigcirc = Cl and \square = vacancy) [118]

As the size of the crystallite decreases, the fraction of double vacancy Mg ions increases more rapidly than that of single vacancy ions.

During the ball-milling procedure of MgCl_2 in the presence of ethyl benzoate, the agglomerates are broken down to yield primary crystallites, when the freshly cleaved surfaces are coated with ethyl benzoate preventing reaggregation (cf. protected colloids). At the same time absorption of ethylbenzoate between layers in the MgCl_2 structure, or even solid solution formation can take place.

(b) Interaction of MgCl_2 with electron donors. The use of aromatic esters as internal donors seems the only choice for high stereospecificities although some sterically hindered alcohols offer distinct possibilities. Keszler et al. [104] have concluded from thermal studies that rapid adsorption of ethyl benzoate occurs followed by slower complex formation. Chien et al. [105] have investigated the effects of ball-milling MgCl_2 with ethyl benzoate by means of BET, mercury porosity and X-ray techniques, and have concluded that the milled material (60h) has higher surface areas, ($5.1\text{-}7.3 \text{ m}^2\text{g}^{-1}$), smaller pore radii, higher pore surface area and smaller crystallite dimensions than unmilled material.

The interaction between MgCl_2 and ethyl benzoate has been extensively studied using IR techniques. Goodall [103] has reported shifts in the $\text{C}=\text{O}$ stretching frequency from 1721 cm^{-1} in the free ester to $1678\text{-}1688 \text{ cm}^{-1}$ in the MgCl_2 complex. Kashiwa [106] and Chien [107] reported similar observations. Goodall [103] concluded that virtually all the surface sites were complexed with ethyl benzoate. Absorption at around 1680 cm^{-1} was assigned to molecules bound via their carbonyl groups to the basal edges and corners of crystallites, whilst that around 1700 cm^{-1} was assigned to molecules absorbed at lateral faces. Chien et al. [107] have proposed complexes (1) and (2) to explain the observed shifts.

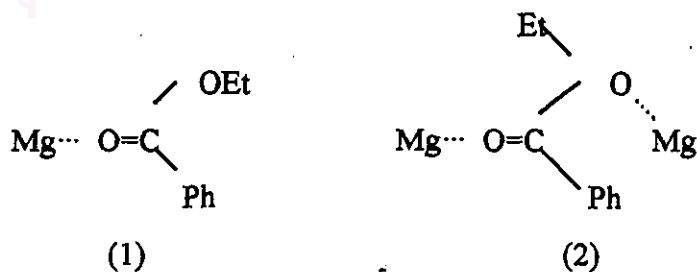

(c) Effect of TiCl_4 treatment. The second step in the catalyst preparation involves treatment of the solid products from ball milling with hot neat TiCl_4 at 80-130°C. During treatment with TiCl_4 some ethyl benzoate is extracted by the TiCl_4 and typical catalyst will contain only 5-20% ethyl benzoate after treatment. Ethyl benzoate is lost not only from weakly bonded sites on the lateral faces (1700 cm^{-1} absorption) but also from the more strongly coordinating corner sites (1650 cm^{-1} absorption). It is believed that the TiCl_4 coordinates to these sites by replacing the ethyl benzoate molecules.

Electron micrographs of polymer growth when using MgCl_2 supported catalysts show [108] that growth is more evident on the edges and corners rather than on the basal faces, which is consistent with the belief that these sites may accommodate Ti atoms with higher activity.

The oxidation state of the titanium complexed to MgCl_2 has been investigated by several authors. [109,110] Baulin et al. [109] have concluded from electron paramagnetic and elemental analytical studies that all the titanium exists as Ti^{IV} . Chien's CW catalyst is more complex since the procatalyst preparation involved AlEt_3 treatment. [110] Figures of 8% Ti^{II} , 38% Ti^{III} and 54% Ti^{IV} have been reported for this catalyst. On the basis of their results Chien and Wu [110] have proposed structures (3), (4) and (5) for the surface Ti^{III} species. Activation of the procatalyst by a cocatalyst system involves reduction of Ti^{IV} to lower valence states.

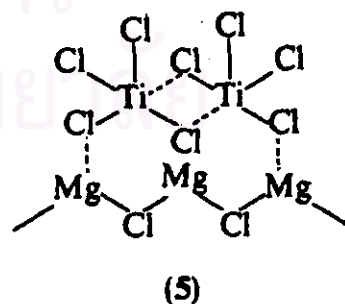
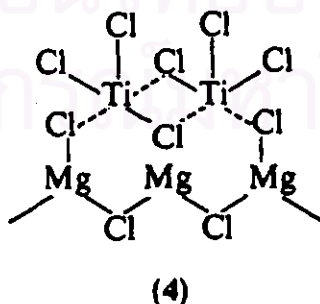
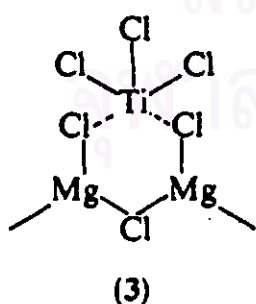

(d) The cocatalyst system. These $\text{MgCl}_2/\text{EB}/\text{TiCl}_4$ catalyst systems may be activated with trialkylaluminium compounds and used for the polymerization of ethylene. However, for propylene polymerization the addition of an electron donor (external donor) to the trialkylaluminium solution is necessary in order to achieve high stereospecificity. Benzoates, toluates, anisates and various amines have been successfully used with $\text{MgCl}_2/\text{EB}/\text{TiCl}_4$ catalyst systems, whilst various di- and tri-alkoxysilanes have been used with $\text{MgCl}_2/\text{phthalate}/\text{TiCl}_4$ systems.

The role of the external donor is complex and includes the following reactions. [111] (i) Complex formation with the aluminium alkyl compound leading to a reduction in its capacity to reduce the titanium entity. (ii) Deactivation of the specific centres. (iii) Alkylation and reduction of the donor compounds; these reactions have been extensively investigated and it has been suggested that the products may themselves act as catalyst modifiers.

The exact role of the external electron donors is still unresolved but their presence is a crucial feature of these polymerizations, affecting both catalyst activity and stereospecificity. Under experimental conditions where extensive chemical reaction between the donor and aluminium alkyl takes place [103,112] the use of large concentrations of alkyl is necessary. Hence the use of modifiers already built into the procatalyst system itself may obviate the need to use high alkyl concentrations.

(e) Super high activity catalysts. A new class of super high activity MgCl_2 -supported catalysts have been developed by Shell [113] which were believed to have only one type of active center. Activities of up to $2000 \text{ kg PP (g Ti)}^{-1}$ are claimed (cf. $500\text{-}1000 \text{ kg PP (g Ti)}^{-1}$ for more conventional based catalyst systems) together with high stereospecificities (isotacticity around 95 %). In addition lower concentrations of activator are required and the usual inverse relationship between isotactic index and polymer yield is virtually absent.

(f) The use of phthalate esters as internal donors. A major disadvantage of $\text{MgCl}_2/\text{EB}/\text{TiCl}_4$ catalyst system is the rapid as internal decrease in activity with time which is normally observed. More stable kinetic rate-time profiles are often shown by catalysts incorporating phthalate esters.

Preparation of phthalate-based catalysts may involve conventional ball-milling procedures or the use of magnesium chloride-alcoholate supports. The latter procedure produces completely spherical catalyst particles and so offers a distinct commercial advantage. A wide range of phthalate esters is available but the diisobutyl and diisooctyl compounds have been found to be the most useful. Longer chain esters may form colloids, while diaryl causes fragmentation of the MgCl_2 -alcoholate supports.

The patent literature is particularly rich with examples of phthalates. Details from these references are shown in Schemes 3.1, 3.2 and 3.3 respectively.

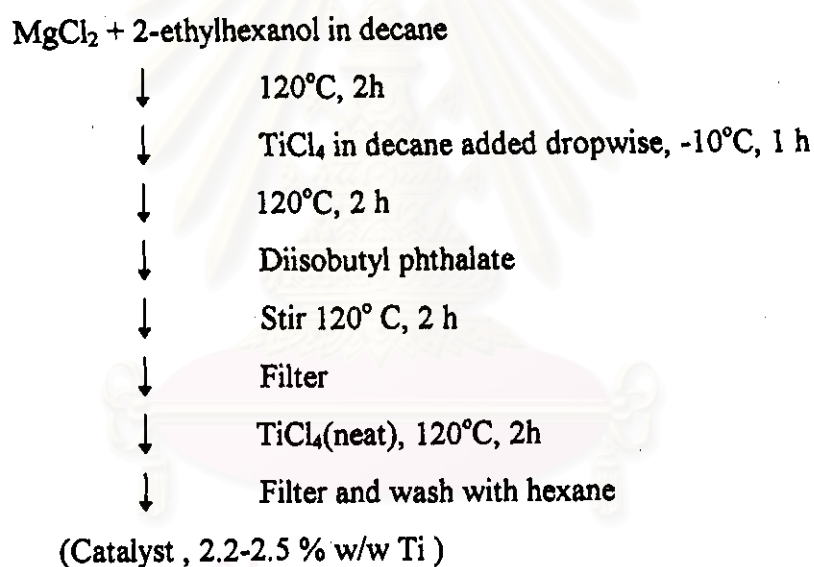

Scheme 3.1

MgCl_2 + 2-ethylhexanol in decane

↓ 130°C, 2h
 ↓ Phthalic anhydride
 ↓ TiCl_4 added dropwise, -20°C, 20 min
 ↓ Stir, -20°C, 1h
 ↓ 120°C
 ↓ Dioctyl phthalate
 ↓ Stir 2 h
 ↓ Filter
 ↓ TiCl_4 (neat), 120°C, 2h
 ↓ Filter
 (Catalyst , 2.0 % w/w Ti)

Scheme 3.2

$\text{Mg}(\text{OEt})_2$ (spray dried)

↓ TiCl_4 , 20°C
 ↓ 85°C
 ↓ Diisooctyl phthalate
 ↓ 110 °C, 1h
 ↓ Filter
 ↓ TiCl_4 , 110°C, 1h
 ↓ Filter, wash
 (Catalyst , 2.0 % w/w Ti)

Scheme 3.3

Alkoxysilanes such as dimethoxydiphenylsilane and phenyltriethoxysilane have been used with particular success as external donors for $MgCl_2$ /phthalate/ $TiCl_4$ catalyst systems.

Although it is apparent that external donors need to be matched with particular internal donors in order to achieve high stereoregularity, the principles which determine donor selection are still poorly understood.

(g) Catalyst replication effects. It has been established that the polymer granules produced in propylene polymerization replicate the shape of the catalyst particles. This effect is shown Figure 3.19.

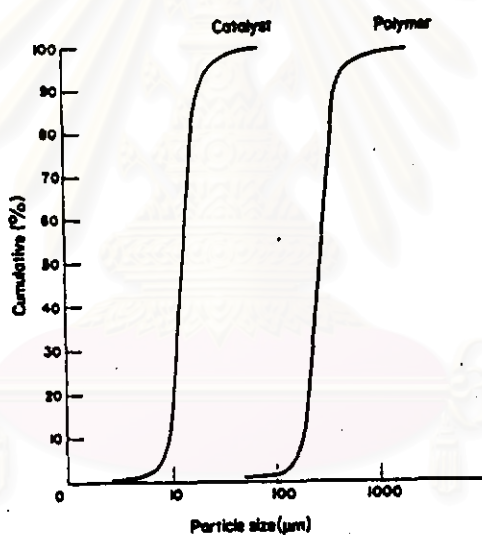

Figure 3.19 Particle size distributions for a $MgCl_2$ Supported Catalyst. [118]