

ประจักษ์ภาพของตัวอักษรไทยขนาดเล็บบนแผ่นพิมพ์ภายใต้ความสว่างต่างๆ
โดยใช้แว่นจำลองสายตาคู่เป็นต่อกระจก

นายบุญชัย วลีธรรมสวัสดิ์

วิทยานิพนธ์นี้เป็นส่วนหนึ่งของการศึกษาตามหลักสูตรปริญญาวิทยาศาสตรดุษฎีบัณฑิต
สาขาวิชาเทคโนโลยีทางภาพ ภาควิชาวิทยาศาสตร์ทางภาพถ่ายและเทคโนโลยีทางการพิมพ์
คณะวิทยาศาสตร์ จุฬาลงกรณ์มหาวิทยาลัย

ปีการศึกษา 2555

ลิขสิทธิ์ของจุฬาลงกรณ์มหาวิทยาลัย

LEGIBILITY OF PRINTED SMALL-SIZED THAI CHARACTERS UNDER
DIFFERENT ILLUMINATION BY MEANS OF CATARACT EXPERIENCING
GOGGLES

Mr. Boonchai Waleetorncheepsawat

A Dissertation Submitted in Partial Fulfillment of the Requirements
for the Degree of Doctor of Philosophy Program in Imaging Technology
Department of Imaging and Printing Technology
Faculty of Science
Chulalongkorn University
Academic Year 2012
Copyright of Chulalongkorn University

Thesis Title	LEGIBILITY OF PRINTED SMALL-SIZED THAI CHARACTERS UNDER DIFFERENT ILLUMINATION BY MEANS OF CATARACT EXPERIENCING GOGGLES
By	Mr. Boonchai Waleetorncheepsawat
Field of Study	Imaging Technology
Thesis Advisor	Associate Professor Pontawee Pungrassamee
Thesis Co-advisor	Professor Mitsuo Ikeda, Ph.D. Tomoko Obama, Ph.D.

Accepted by the Faculty of Science, Chulalongkorn University in Partial
Fulfillment of the Requirements for the Doctoral Degree

..... Dean of the Faculty of Science
(Professor Supot Hannongbua, Dr. rer. nat.)

THESIS COMMITTEE

..... Chairman
(Associate Professor Aran Hansuebsai, Ph.D.)

..... Thesis Advisor
(Associate Professor Pontawee Pungrassamee)

..... Thesis Co-advisor
(Professor Mitsuo Ikeda, Ph.D.)

..... Thesis Co-advisor
(Tomoko Obama, Ph.D.)

..... Examiner
(Assistant Professor Chawan Koopipat, Ph.D.)

..... Examiner
(Assistant Professor Suchitra Sueeprasan, Ph.D.)

..... External Examiner
(Uravis Tangkijviwat, Ph.D.)

บุญชัย วลีธรชีพสวัสดิ์ : ประสิทธิภาพของตัวอักษรไทยขนาดเล็กบนแผ่นพิมพ์ภายใต้
ความสว่างต่างๆ โดยใช้แว่นจำลองสายตาผู้เป็นต้อกระจก (LEGIBILITY OF PRINTED
SMALL-SIZED THAI CHARACTERS UNDER DIFFERENT ILLUMINATION BY
MEANS OF CATARACT EXPERIENCING GOGGLES) อ.ที่ปรึกษาวิทยานิพนธ์หลัก :
รศ. พรทวี พึ่งรัมย์, อ.ที่ปรึกษาวิทยานิพนธ์ร่วม : Prof. Mitsuo Ikeda, Ph.D., Tomoko
Obama, Ph.D., 144 หน้า.

การรับข้อมูลจากภายนอกที่ระบบการมองเห็นอย่างมาก สัดส่วนประชากรสูงอายุใน
ประเทศไทยเพิ่มมากขึ้นอย่างรวดเร็ว จึงมีความจำเป็นต้องสร้างโครงสร้างพื้นฐานที่เหมาะสมกับ
การมองเห็นของผู้สูงอายุให้เกิดขึ้นในประเทศไทย โดยเฉพาะการมองฉลากสินค้าที่มีข้อจำกัดจาก
ขนาดตัวอักษรเล็กมากเกินไป อีกทั้งผู้สูงอายุมักมีภาวะต้อกระจก เกิดการฟุ้งกระจายแสงที่ส่องเข้าตา
ทำให้การมองเห็นถดถอยลง ซึ่งการศึกษาที่ผ่านมาพบว่าการมองเห็นของผู้สูงอายุยังคงได้รับผลเสีย
จากแสงไฟส่องสว่างแบบทั่วไปคือไฟจากเพดาน แต่หากมีการควบคุมแสงไฟอย่างเหมาะสม
โดยเฉพาะการออกแบบการทดลองแบบสองห้อง ให้ตัวหนังสือทดสอบอยู่ในห้องที่ควบคุมความ
สว่างไว้คงที่ ส่วนผู้ทดลองอยู่ในอีกห้องหนึ่งที่ลดแสงสว่างลง การกระเจิงของแสงเข้าตาจะลดลง
ด้วย ซึ่งจะช่วยเพิ่มประสิทธิภาพการมองเห็น โดยการทดลองนี้ใช้แว่นจำลองสายตาผู้เป็นต้อกระจก
ทดลองกับคนหนุ่มสาว

ผลการทดลองแบบหนึ่งห้องพบว่า สายตาจำลองต้อกระจกประสิทธิภาพถดถอยมากเมื่อ
ความสว่างลดต่ำลง แผ่นทดสอบแบบเนกาทีฟให้ผลดีกว่าแบบโพสิทีฟเล็กน้อย ในขณะที่แบบ
ตัวอักษรต่างกันไม่มีผลต่อประสิทธิภาพ แผ่นทดสอบที่มีความเปรียบต่างต่ำให้ผลการมองเห็นที่ถดถอย
มากแก่สายตาจำลองต้อกระจก ส่วนผลการทดลองแบบสองห้องแสดงให้เห็นถึงข้อดีในการรักษา
ประสิทธิภาพให้แก่สายตาจำลองต้อกระจก โดยเฉพาะให้ผลดีเด่นในกรณีแผ่นทดสอบมีความ
เปรียบต่างต่ำ ซึ่งเป็นสิ่งยืนยันสถานะการจัดแสงที่เหมาะสมกับผู้สูงอายุควรเป็นแบบป้องกันการฟุ้ง
กระจายของแสงที่เข้าตา การทดลองได้นำไปสู่การสร้างแบบจำลองในการแปลงค่าการมองเห็น
ของคนปกติเป็นค่าการมองเห็นที่ต้องการสำหรับผู้สูงอายุ

ภาควิชา วิทยาศาสตร์ทางภาพถ่ายลายมือชื่อ.....
และเทคโนโลยีทางการพิมพ์ลายมือชื่อ อ.ที่ปรึกษาวิทยานิพนธ์หลัก.....
สาขาวิชา เทคโนโลยีทางภาพลายมือชื่อ อ.ที่ปรึกษาวิทยานิพนธ์ร่วม.....
ปีการศึกษา 2555ลายมือชื่อ อ.ที่ปรึกษาวิทยานิพนธ์ร่วม.....

5273823823 : MAJOR IMAGING TECHNOLOGY

KEYWORDS : LEGIBILITY / VISUAL ACUITY / ILLUMINATION /
CATARACT EXPERIENCING GOGGLES

BOONCHAI WALEETORNCHEEPSAWAT : LEGIBILITY OF PRINTED
SMALL-SIZED THAI CHARACTERS UNDER DIFFERENT
ILLUMINATION BY MEANS OF CATARACT EXPERIENCING
GOGGLES. ADVISOR: ASSOC. PROF. PONTAWEE PUNGRASSAMEE,
CO-ADVISOR : PROF. MITSUO IKEDA, Ph.D., TOMOKO OBAMA,
Ph.D., 144 pp.

Most of the outside information is collected to us through the visual system. Since the ratio of population of elderlies to young people in Thailand is increasing rapidly, the proper infrastructure of the visual environment suitable for elderlies is one of the urgent tasks of the country. The printed labels representing visual environment have been found to be expressed by so small letters and are too difficult for elderlies to read. A serious problem of the visual performance of the elderly comes from the cloudy crystalline lens of the cataract that scatters the incoming light all over the retina and worsen the legibility of letters. The deterioration of the visual acuity investigated in the forgoing experiments should be because of the scattered light and cannot be avoided as far as the reading condition stays normal, that is the subjects read labels under illumination provided by ceiling light.

To control scattered light from the environment, the two-room concept is introduced. A test stimulus is placed in one room and a subject stays in the connecting room with window on the separating wall. If the illumination of the subject room is lowered, while the luminance of the test stimulus is kept the same, the scattered light should be decreased and the visual performance should be improved. This research aims to investigate the visual acuity of printed small-sized letters under various illumination conditions by using cataract experiencing goggles.

Results of one-room experiment showed that legibility of the eyes with goggles decreased highly with decreasing illuminance. Negative contrast gave slightly better legibility than positive contrast font. The three fonts tested gave no significant different in legibility. Low contrast stimulus causes high deterioration for eyes with goggles. Result from two-room experiment showed the advantage of two-room illumination system on preserving legibility for the eyes with goggles especially on the low contrast stimulus. The model for transferring letter height seen by young eyes to the letter height needed for the elderly for different backgrounds has been set up.

Department : Imaging and Printing Technology Student's Signature.....
Field of Study : Imaging Technology Advisor's Signature.....
Academic Year : 2012 Co-advisor's Signature.....
Co-advisor's Signature.....

ACKNOWLEDGEMENTS

To the appreciation of this thesis fulfillment, I would like to acknowledge the memorable people that take part in this success.

First of all I would like to acknowledge my supervisor, Assistant Professor Pontawee Pungrassamee at the Department of Imaging and Printing Technology, Chulalongkorn University, for the enduring support of my study, and the co-supervisors: Professor Mitsuo Ikeda, a distinguished professor at Chulalongkorn University, who supervised me patiently and properly during my studentship at Chulalongkorn University and Dr. Tomoko Obama, from Panasonic company Japan, who guided me to many advanced tasks for the research and always encouraged me on the continuing work. I would thank Assistant Professor Chawan Koopipat, Associate Professor Aran Hansuebsai, Assistant Professor Suchitra Sueeprasan at Chulalongkorn University and Dr. Uravis Tangkijviwat, a lecturer at Rajamangala University of Technology Thanyaburi, who gave me valuable comments as committee members of my Ph.D. defending.

I shall mention my special thanks to Professor Mitsuo Ikeda who accepted me as the supervisee when I made decision for the research theme. Throughout this 4 years course I have learnt many invaluable basic to be a good researcher. I wholeheartedly trust and respect his coaching. I would like to give my sincere thanks to Dr. Chanprapha Phuangsuwan who advised me in figures preparation and thesis documentation. Her help simplified the narration of thesis style and format.

I would like to thank Sukhothai Thammathirat Open University for giving me the opportunity to study for Ph.D. at Chulalongkorn University. I gratefully thank Associate Professor Pakamas Pachonklaew, who encouraged me to pursue the Ph. D. and handled many tasks for me during my absent. I also thank my friendly colleagues at the School of Science and Technology who kindly shared my load of work during my absent for Ph.D. study.

I faithfully thank Chulalongkorn University for granting the 72nd Birthday Anniversary of His Majesty the King's Scholarship for supporting the 3 years course of Ph.D. study, and the 90th anniversary of Chulalongkorn University Fund (Ratchadaphiseksomphot Endowment Fund) for promoting the Ph.D. research.

Many thanks to the laboratory members and students at the Department of Imaging and Printing Technology, Chulalongkorn University who spent a lot of time and energy as subjects for my experiment.

I gratefully admire my beloved family, my wife who support this lengthen study, my son and daughter who inspire me to work hard.

CONTENTS

	Page
ABSTRACT IN THAI	iv
ABSTRACT IN ENGLISH	v
ACKNOWLEDGEMENTS	vi
CONTENTS	vii
LIST OF TABLES	ix
LIST OF FIGURES	x
CHAPTER I INTRODUCTION	1
1.1 Background and rationale	1
1.2 Objectives	3
1.3 Outline of thesis	4
CHAPTER II LITERATURE REVIEW	6
CHAPTER III SURVEY OF ILLUMINATION ENVIRONMENT FOR READING LABELS	11
3.1 Introduction	11
3.2 Experiment	11
3.3 Results	13
3.4 Discussion on survey of illumination environment	16
CHAPTER IV ONE-ROOM EXPERIMENT	20
4.1 Introduction	20
4.2 Apparatus	21
4.3 Experimental condition	29
4.4 Procedure	29
4.5 Results	35
4.6 Discussion on one-room experiment	47
CHAPTER V TWO-ROOM EXPERIMENT	53
5.1 Introduction	53
5.2 Apparatus	53
5.3 Experimental condition	54
5.4 Procedure	55
5.5 Results	56
5.6 Discussion on two-room experiment	61
CHAPTER VI SUPPLEMENTAL EXPERIMENTS	64
6.1 Introduction	64
6.2 Apparatus	65
6.3 Experimental condition	67

	Page
6.4 Procedure	68
6.5 Results	69
6.6 Discussion on supplemental experiments	80
CHAPTER VII READABILITY EXPERIMENTS	86
7.1 Introduction	86
7.2 Apparatus	86
7.3 Experimental condition	93
7.4 Procedure	93
7.5 Results	94
7.6 Discussion on readability experiments	111
CHAPTER VIII GENERAL DISCUSSION AND CONCLUSION	119
8.1 General discussion	119
8.2 Conclusion	124
8.3 Suggestion for future research	125
REFERENCES	126
APPENDIX	129
BIOGRAPHY	142

LIST OF TABLES

TABLE	Page
3-1 Illuminance in supermarkets and households.....	17
3-2 The assigned illuminance and the conversion into log unit.....	19
4-1 Letter height and point size for each line of letter charts.....	26
4-2 One-room experimental conditions.....	29
4-3 Codes for matching of datasheets and letter charts.....	32
5-1 Experimental conditions of two-room experiment.....	55
6-1 Experimental conditions of supplemental one-room experiment.....	67
6-2 Experimental conditions of supplemental two-room experiment.....	68
7-1 Card numbers with corresponding font size, background, and coding.....	91
7-2 Experimental conditions of one-room readability experiment.....	93
7-3 Experimental conditions of two-room readability experiment.....	93
8-1 Letter height for legibility of different backgrounds.....	120
8-2 Equations to obtain proper letter size for elderly people.....	122

LIST OF FIGURES

Figure	Page
1-1 Population pyramid graph of Thailand.....	1
1-2 Letters comparison among English, Thai, and Japanese.....	2
1-3 Percentage of cataract patient by age.....	3
2-1 Dimension of the standard Landolt C.....	7
2-2 Snellen chart composes of 10 Sloan letters.....	7
3-1 Visual acuity for retinal illuminance determined by Landolt C and grating.....	11
3-2 The Minolta Chroma Meter CL-200 illuminometer.....	12
3-3 Positions and directions of light measurement.....	13
3-4 Distribution of vertical plane illuminance in supermarket (V-150).....	14
3-5 Distribution of horizontal plane illuminance in supermarket (H-100).....	14
3-6 Distribution of vertical plane illuminance in supermarket (V-60).....	15
3-7 Distribution of vertical plane illuminance in household (V-Day).....	15
3-8 Distribution of horizontal plane illuminance in household (H-Day).....	15
3-9 Distribution of vertical plane illuminance in household (V-Night).....	16
3-10 Distribution of horizontal plane illuminance in household (H-Night).....	16
4-1 The Panasonic Cataract Experiencing Goggles.....	21
4-2 Spectral transmittance curve of the goggles.....	22
4-3 One-room experimental room.....	23
4-4 Chart holder for vertical chart movement.....	24
4-5 Chin rest and demo for controlling the correct viewing distance.....	24
4-6 Actual layout of letter charts in negative and positive contrast.....	25
4-7 Constant retinal image size subtended by constant visual angle α	26
4-8 Three fonts for one-room experiment.....	27
4-9 The microscopic measurement of printed letter size.....	28
4-10 The overlay graph of log letter height for each line number.....	29
4-11 Example of the datasheet corresponded to the letter chart.....	31
4-12 Samples of chart sets showing letters written out from letter charts.....	33
4-13 Example of recorded datasheets of subject PW.....	36
4-14 Example of data entry from session 1 of subject PW.....	37
4-15 Examples of probability-of-seeing curve.....	38
4-16 Probability of seeing curves with regression lines from 5 sessions.....	39
4-17 Example of results obtained from the subject PW.....	40
4-18 Results from 5 sessions of the subject PW.....	41
4-19 Results of two subjects: PW and PP for TF Srivichai font.....	41
4-20 Averaged results of 5 subjects of letter height-illuminance curve.....	42

	Page	
4-21	Comparison of contrast effect of three fonts.....	43
4-22	Graphs comparing the 3 fonts under different goggles conditions.....	44
4-23	The similarity of identification power of Thai letters and Snellen E.....	45
4-24	The visual angle-illuminance curves for three fonts.....	46
4-25	The visual acuity-illuminance curves for three fonts.....	46
4-26	Letter height-illuminance curves compensated for transmittance factor....	47
4-27	Letter height difference between normal eyes and eyes with goggles.....	48
4-28	Visual acuity for illuminance.....	49
4-29	Forty four consonants of Thai letter arranged by order.....	50
4-30	The similarity of Thai letters on the circular initial of the letter stroke.....	51
4-31	The more obvious cues for identifying Thai letters.....	52
5-1	Two-room experimental room.....	54
5-2	Averaged result from 5 sessions of 2 subjects plotted in letter height.....	56
5-3	Averaged result of 5 subjects in positive and negative contrast.....	57
5-4	Letter height-illuminance curves of positive and negative contrast.....	58
5-5	Standard deviation of the positive contrast.....	58
5-6	Comparison of letter height of the one-room and two-room.....	59
5-7	Comparison of visual angle of the one-room and two-room.....	60
5-8	Comparison of visual acuity of the one-room and two-room.....	61
6-1	Sample of product labels in different contrasts.....	64
6-2	Letter charts of the background, White, N5, and N4.....	66
6-3	Illustration of chart adjustment.....	67
6-4	Results of 2 subject experimented by one-room on three backgrounds.....	70
6-5	Averaged line number from 3 backgrounds experimented by one-room.....	71
6-6	Standard deviation of the letter height from averaged 4 subjects.....	71
6-7	Letter height from different contrast under the same eye condition.....	72
6-8	Letter height difference between eyes with goggles and normal eyes.....	72
6-9	Results in letter height of 2 subjects for two-room on three backgrounds..	73
6-10	Averaged results from 4 subjects of two-room on three backgrounds.....	74
6-11	Standard deviation of averaged letter height from 4 subjects.....	75
6-12	Letter height by contrast from normal eyes and eyes with goggles.....	75
6-13	Letter height difference between eyes with goggles and normal eyes.....	76
6-14	Letter height comparison of supplemental two-room and one-room.....	77
6-15	Visual angles comparison of supplemental two-room and one-room.....	78
6-16	Visual acuity comparison of supplemental two-room and one-room.....	79
6-17	Letter height comparison of one-room and supplemental one-room.....	80

	Page	
6-18	Probability-of-seeing curves of subject PP with 50% and 80%	81
6-19	Probability-of-seeing curves of subject BW	82
6-20	Probability-of-seeing curves in log letter height	83
6-21	Letter height comparison for 50% seeing, interpolated 100% seeing, and supplemental one-room experiment	83
6-22	Standard deviation comparison for one-room and supplemental one-room experiment	84
7-1	Sample of label card showing white text on gray background	87
7-2	Two polarity contrasts and its background variation of a same font size ..	88
7-3	Samples of label text in different font sizes	89
7-4	Samples of eight cards with card numbering at the top left corner	90
7-5	Card-holder for one-room readability experiment	92
7-6	Card-holder for two-room readability experiment	92
7-7	Data of subject ET's one-room readability experiment at 20 and 80 lx	96
7-8	Data of subject ET's one-room readability experiment at 280 and 800 lx ..	97
7-9	Results with normal eyes of one-room readability experiment from subject ET and PC	99
7-10	Results with eyes with goggles of one-room readability experiment from subject ET and PC	100
7-11	Letter height for category Difficult to Read and Can Read on N7 negative and N3 Positive from 5 subjects	102
7-12	Comparison of the four response categories on N7 negative and N3 positive	103
7-13	Letter height for category Can Read in different backgrounds of negative and positive contrast	105
7-14	Results with normal eyes of two-room readability experiment in four categorical responses from subject OB and AP	106
7-15	Results with eyes with goggles of two-room readability experiment in four categorical responses from subject OB and AP	107
7-16	Letter height for category Difficult to Read and Can Read on N7 negative and N3 Positive backgrounds from 5 subjects	108
7-17	Letter height for category Can Read on N7 negative and N3 Positive backgrounds from 5 subjects	109
7-18	Comparison of the four response categories on N7 negative and N3 positive in the two-room experiment	110
7-19	Letter height for category Can Read in different backgrounds from the two-room experiment	111

	Page
7-20 Letter height plotted for different backgrounds in negative contrast of category Can Read from one-room and two-room	113
7-21 Letter height plotted for different backgrounds in positive contrast of category Can Read from one-room and two-room	114
7-22 Visual angles plotted for different backgrounds of negative contrast in one-room and two-room in category Can Read	116
7-23 Visual angles plotted for different backgrounds of positive contrast in one-room and two-room in category Can Read	117
7-24 Visual angles for category Can Read at room illuminance 80 lx for each background in positive and negative contrast	118
8-1 Sample demonstrating the letter size of label text, recommended size for young people, and recommended size for elderly people	121
8-2 Log ratio of letter height of elderly by young in different backgrounds	122
8-3 Visual angles of the readability in category Can Read under illuminance of 80 and 280 lx in different backgrounds	123

CHAPTER I

INTRODUCTION

1.1 Background and rationale

The elderly population in Thailand is increasing gradually, and Thailand is emerging the elderly society. As defined by UN, the elderlies are those aged 65 and over[1]. As shown in population pyramid graph in Figure 1-1, in the year 2010, the population ratio of elderly in Thailand was 8.9% [2]. If we compare this value to 22.7% of Japan [3], it is still small, but the statistic prediction says that in the year 2050 the elderly population in Thailand goes up to 25.1%, compared to 35.6% in Japan. When people get older they get cataract and their visual performance deteriorates [4-7]. Therefore, it is an urgent matter to investigate the performance of elderly vision and to provide proper infrastructure and environment to assure them the quality of life. In the present study we pay particular attention to letter size of product labels as the elderly people get information from labels for their daily living.

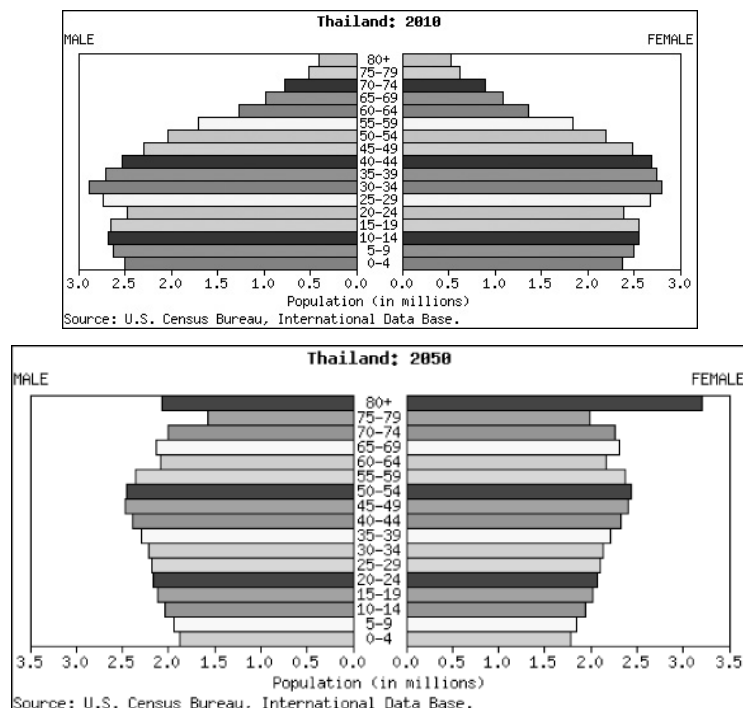

Figure 1-1 Population pyramid graph of Thailand in the year 2010 (upper) compared to the year 2050 (below) [8]. The different shades in horizontal bars do not have special meaning, but to ease the illustration.

Legibility by elderly people has been investigated by many researchers, Elliott et al. [6] for English, Funakawa [9] and Ayama et al. [10] for Japanese to mention only few. They all showed deterioration of the visual acuity by elderly people. Follow intensive investigation, there is national standard of JIS 0032 [11] that defines Japanese standard letter size suitable for elderly. But in our knowledge, none investigated for Thai letters and no proposal was made for the Thai letter size recommended for labels to suit elderly people. Thai letters are different from English or Japanese letters as seen in Figure 1-2.

Xx นป 標標

Figure 1-2 Letters comparison among English, Thai, and Japanese.

We can see that Thai letters are similar to Roman letters in terms of the symbolic-like structure. The formation of words also made up from letters. But Thai letters are more complex than Roman letters. While Japanese kanji or Chinese letters are in the form of a single word per letter. Hence, the readability of a kanji word is based on the legibility of that letter, while the readability of a Thai or English word is based on the legibility of letters in that word and the comprehensibility of the word.

It is needed to investigate the minimum letter height of Thai letter visible by elderly people, which will be done in this research. We employ the cataract experiencing goggles developed by Panasonic in stead of employing real elderly observers. Statistics shows that almost every person gets cataract when he/she becomes older as shown in Figure 1-3. It is reasonable to use the cataract experiencing goggles to investigate the visual performance of elderly people. The goggles are composed of three filters, density filter, color filter, and haze filter and simulate elderly vision that has cataract in the eyes which begin to cause some inconvenience in their daily life [12]. By applying the goggles to young observers we can accurately investigate the visual acuity under various illumination conditions set up in the laboratory, which was not possible if we employ real elderly observers as already shown by Ikeda et al. in investigating the color appearance by the same goggles [13, 14].

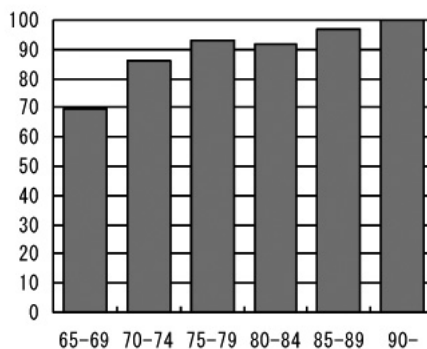

Figure 1-3 Percentage of cataract patient by age [14].

The visual performance changes depending on the illuminance level where people look at anything and we first survey illuminating environments where elderly people might need to identify labels. The data will be used to determine the illuminance level that is employed for the laboratory experiment. We then measure the minimal Thai letter size legible with goggles worn by young subjects under the various illuminance levels. The same experiment is done for the same young subjects without the goggles so that we can compare how the visual performance deteriorates when people get older. We propose some standard letter size suitable for elderly people in Thailand. It is anticipated that the deterioration of the visual performance to read letters is caused severely by the scattered light in the eyeballs because of cataract crystalline lenses, which overlay the retinal image of letters. In the third experiment of the present study we employ the 2-room concept developed by Ikeda et al. [15], where the subject room and the test room where letter charts are placed are separated by a wall with a viewing window. By that technique the environmental light which caused the scattered light into the eyes was reduced. So we can expect the visual acuity of the observer to be preserved at a normal level.

1.2 Objectives

Two objectives are set up for the present research.

Objective 1; To investigate minimal font size, font type, polarity contrast, and illumination level that affect the legibility of elderly on printed small-sized Thai characters by means of cataract simulating goggles. (Survey Experiment, Experiment I, Supplemental Experiment, and Experiment III)

Objective 2; To investigate illumination environment suitability for elderly. (Experiment II, Supplemental Experiment, and Experiment III)

1.3 Outline of thesis

The thesis is composed of eight chapters, Chapter I Introduction, Chapter II Literature review, Chapter III Survey experiment, Chapter IV One-room experiment, Chapter V Two-room experiment, Chapter VI Supplement experiment, Chapter VII Experiment III, and Chapter VIII General discussion.

In Chapter I Introduction the importance of study on the elderly vision is explained and two objectives of the present research are set.

Some related papers to the present research were selected and they are cited in Chapter II Literature review.

To start the measurement of visual acuity with goggles it was necessary to determine under what illumination the measurement should be made. We particularly chose the illumination environment in supermarkets and in residences where elderly people often and mostly spend their life. The survey of the illumination was done by going to these places and the illuminance levels to be employed in main experiments were determined. The survey showed that illuminance in supermarket was relatively high compared to illuminance in the house hold. Survey of product labels were also found variety of fonts usage. Fonts were categorized into 3 main groups and sample fonts for the experiment were selected. Chapter III Survey experiment explains about the measurement and results of the survey.

Chapter IV One-room experiment explains about the first main experiment in the present research. The experiment is sometime called one-room illumination system because the measurement of visual acuity is done in one room where a proper illumination is provided and a subject observes visual acuity chart placed in the room. Subjects looked at a chart made of Thai letters of different size and the limit of readable letter size was determined with and without the goggles. The measurement was carried out for different illuminance levels that were determined in the survey experiment stated in Chapter III, for three different fonts, and negative and positive representation of letters. The difference of the visual acuity or the minimum readable letter size with and without goggles was determined for each condition. The results showed deterioration of the visual acuity with goggles and suggested a need to improve visual environment to improve their visual performance.

In Chapter V Two-room experiment, a visual environment that is expected to improve the visual performance with goggles was introduced as two-room illumination system. A hypothesis was made that the deterioration of the visual acuity with goggles is mainly due to the scattering light getting into the eyes caused by the foggy filter of the goggles. The scattering light originates from the ceiling lamps. If

we can cut the light directly entering the eyes by some way the visual performance should improve. To realize this a test chart was placed in a test room separated from the room where a subject stays, thus the two-room illumination system.

Some improvement was found but not as much as we expected. The reason was put forward and the supplement experiment was suggested, which was explained in the next chapter, Chapter VI.

Chapter VI was for the supplement experiment. The reason for no improvement of the visual performance with the two-room illumination system was considered because of the high contrast of the acuity chart, almost 100 % contrast. Even with the goggles that gave foggy visual field subjects could see strokes of letters, particularly under high illuminance. It was considered that if the contrast is reduced the visual acuity should drop radically with goggles, and new acuity charts with different contrast were prepared. Both one-room illumination system employed for One-room experiment and two-room illumination system employed for Two-room experiment were used here. A large difference of the visual acuity was found between with and without goggles with the visual acuity chart with low contrast of visual acuity chart as expected.

Chapter VII Experiment III was to confirm the results obtained in the forgoing experiments applicable to readability rather than legibility. Subjects were asked to judge the label card and response with 4 categories; “Can Not Read”, “Difficult to Read”, “Can Read”, or “Comfortable to Read”. The test cards were designed to simulate labels of consumer products. Each card composed of same letter size and contrast. The response of “Can Read” represented 75%-80% correct reading and were used to judge the recommended letter size for label under certain condition.

Chapter VIII is the general discussion. It focused on the goggles affect on legibility and the possibility on improving the legibility of goggled vision. Some recommendations about font size, letter contrast, and illuminating environment were proposed to provide elderly people with life of better quality.

CHAPTER II

LITERATURE REVIEW

Arditi [7] pointed out that declining visual functions is a natural part of aging. He aimed on how to best design environments for people with the typical visual decline that we accept as normal, and for those with low vision, to best optimize the ability of senior to use visual information. The factors affecting human vision function and age-related vision deterioration have been investigated by many authors from the past. Among many basic vision functions, visual acuity is one of the key function that guarantee our normal living, and is the main function in our current study. Other functions that also relate to this study is the contrast sensitivity. The current study utilized cataract experiencing goggles to simulate elderly vision with cataract that want to be seen by young observers. There were many relevant papers on the subject. Here we review only papers that are closely related to our present research.

Visual acuity is the ability of the eyes to discriminate fine detail. It is a basic visual function that is important for many human tasks. It measures the resolution capability of the visual system in terms of the smallest high-contrast detail perceived at a given distance. By the definition of Arditi the major methods of measuring acuity are resolution and identification tasks [7].

The resolution task is the task where subjects are required to discriminate a separation between the parts of a target. Landolt rings or Landolt C was adopted as the international chart to measure the visual acuity and it is widely used in eye clinics nowadays. One Landolt C is shown in Figure 2-1. The gap size in the letter is one fifth of the entire letter and patients respond the direction of the gap when the letters are shown in different size and in different orientation in a visual acuity chart. It was decided that the chart should shown to patients with the illuminance between 500 and 1,000 lx on the surface. A similar chart called E chart is also used in some countries. Instead of Landolt C a letter E is presented in different size and in different orientation, and patients are asked its direction.

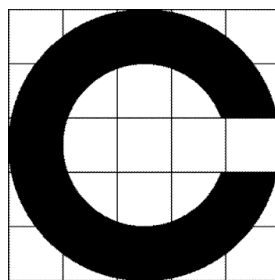

Figure 2-1 Dimension of the standard Landolt C.

The identification tasks are the tasks where subjects are asked to read letters presented in different size. One example is Snellen chart which is composed of only ten Sloan letters, C, D, E, F, L, N, O, P, T and Z as shown in Figure 2-2. In Japan phonetic letters are used. The experimenter notes the row with the smallest letters that the subject can name correctly. These tasks measure minimum separable and recognition acuity in terms of letter recognition or legibility. Subjects for these tasks need to be literated to be able to name the chart correctly. In this research we employ the identification or recognition task as the tool for obtaining the minimum legible font size of Thai characters.

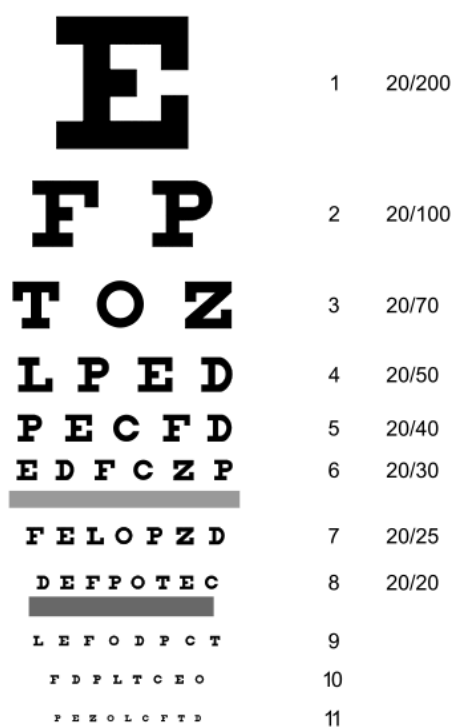

Figure 2-2 Snellen chart composes of 10 Sloan letters [17]. The top horizontal gray bar is green color bar, and the bottom horizontal gray bar is red color bar.

We want to simulate the actual product labels that are printed. However, due to the advancement in digital video display, some recent research on visual acuity utilized the computer monitors. Zhang et al. [18] studied the legibility variations of Chinese characters and implication for visual acuity measurement in Chinese reading population. They used high contrast achromatic stimuli generated by computer and presented on 21" color monitor in a dim test room. Ayama et al. [10] studied the effects of contrast and character size upon legibility of Japanese text stimuli presented on visual display terminal. They used Japanese text stimuli generated in computer and display on 17" CRT display with black facet in the 500 lx test room. Funakawa [9] did psychophysical experiment on the legibility of letters. His experiment was performed extensively on Color Display Monitor rather than printed chart, and the legibility target was only numerals rather than letters. Elliott et al. [6] studied the relation of visual acuity versus letter contrast sensitivity in early cataract. His letters stimuli presented on the video monitor in a dimmy lit room.

The stimuli for acuity test used either standard acuity targets or letter charts in different language. The studied of Zhang et. al. [18] used Snellen E, Landolt C, and the Sloan letters in comparison to the Chinese optotypes. They tried to develop the new visual acuity measurement tool for the Chinese reading population by matching Chinese letters to the standard optotypes. They found that more complex optotypes had lower acuity. However, result from Sloan letters had significantly better acuity than the simplest group of Chinese characters, even though the two groups had comparable spatial complexity. This implied that the Roman letters are highly abstracted symbols that consist of many regularities, symmetry, repetition, and uniformity, hence easier to recognize. Contrary, Chinese characters are either pictographs, do not have the regularities, hence the stroke types and their placement in Chinese characters are much less predictable. This phenomena could apply to other non-roman characters like Thai characters.

Concerning the contrast of stimuli, the visual acuity task mainly utilized polarity contrast, either positive or negative. However, contrast variation on stimuli was used in some studies. Ayama et. al. [10] experimented the subjective rating task for positive and negative contrast Japanese text on the polarity background and gray background. They found that not only luminance contrast, but also character size and background luminance, that affects readability. On the contrast polarity, performance of reading speed on white background is clearly better than black background. It showed that the contrast and the size of characters contribute to legibility in a

complementary fashion.

Visual acuity and contrast sensitivity have some degree of correlation. Contrast is created by the difference in luminance, the amount of reflected light, reflected from two adjacent surfaces. Contrast between the object and background is one of the key factors for visual discrimination power. The legibility of a symbol or text is strongly influenced by the relationship between its luminance and the luminance of its immediate background than by its own absolute luminance. Luminance contrast describes the stimulus power which calculated from the luminance of symbol and luminance of its adjacent background. There are 2 main formulas for calculating contrast, Weber formula and Michelson formula. In this research we employ Weber contrast as the luminance contrast for our study.

Even we did not investigate the contrast sensitivity directly in our study, but the result of our investigation involved the explanation of it. Contrast sensitivity is the measure of the ability to see details at low contrast levels. Visual information at low contrast levels is particularly important for elderly or even young people to live their efficient daily life. Owsley et al. [5] revealed that contrast sensitivity changes throughout adulthood, and it decline as the person getting aged. Elloit et al. [6] also confirmed that contrast sensitivity significantly correlates with visual acuity.

Owsley et. al. [5] investigated the contrast sensitivity throughout adulthood for people aged ranging from 19-87 years old. They revealed that visual acuity and contrast sensitivity decreased as age increased. The decreased in contrast sensitivity was due to impairment of the temporal processing in the elderly. Reduced retinal illuminance characteristic of the aged eye could account for a large part of older adult deficit in spatial vision, but appeared to play little role in their deficit in temporal vision. Weale [4] has estimated that the crystalline lens of the average 60-year-old eye transmits approximately one-third the light transmitted by the average 20-year-old eye.

Adaptation curves were obtained by Domey et al. [19], which showed the deterioration of threshold in elderly people.

There were binocular and monocular vision tested in the past, which result comparison should be conducted with caution. Spatial contrast sensitivity for monocular and binocular vision of normal subjects from the study of Valberg and Fosse (2002) [20] showed that binocular vision is better than monocular vision by about 40%.

One of the serious problems of the visual performance of the elderly comes from the cloudy crystalline lens of the cataract. Cataract is a clouding of the lens that

produce an overall haze, resulting in the deteriorated visual acuity and contrast sensitivity, and the increased sensitivity to glare. Cataract starts in the crystalline lens of every body when he/she gets old and it becomes worse as aged. It scatters the incoming light all over the retina. There is a lot of environment light, which is normally white, in our surrounding. The light is scattered by the cloudy lens and it falls upon the retinal image of objects that a person is looking at. Cataracts diminish the sharpness of detail. In the advanced stage of cataracts, print appears faded and words become harder to read.

In order for young people to have the simulated cataract vision of the elderly, the cataract experiencing goggles were developed by Obama et al. [12]. The goggles are composed of three filters: a color filter, a neutral density filter, and a haze filter. The first two reduced the light transmitted but the last haze filter scatter incoming light. When putting together they simulate the elderly vision with cataract. The goggles particularly simulate the cataract eyes that start to cause the owner some daily inconveniences such as difficulty in reading labels and signs, identification mistake for faces of acquaintances, mistake to choose a pair socks of dark color, and so on.

The effect of the scattered light on the color appearance was investigated thoroughly by Ikeda et al. [13-14]. It is considered that the scattered light also makes the legibility of letters worse as the scattered foggy light lays over the retinal image of letters. The deterioration of the visual acuity investigated in the forgoing experiments should be because of the scattered light and can't be avoided as far as the reading condition stays normal, that is the subjects read labels under illumination provided by ceiling light.

To manipulate or control scattered light from the environment, Ikeda et al. introduced the 2-room concept [14]. A test stimulus is placed in one room and a subject stays in the connecting room with window on the separating wall. If the illumination of the subject room is lowered, while the luminance of the test stimulus remains the same, the scattered light should be decreased and the visual performance should be improved.

CHAPTER III

SURVEY OF ILLUMINATION ENVIRONMENT FOR READING LABELS

3.1 Introduction

For elderly it is important to be able to see and read products label clearly when they do shopping for their daily use. The purpose of this research is to find out the visual environment in terms of illuminance level at supermarkets and at household where they have to do the action every day. There are factors affecting letters legibility and labels readability such as visual acuity and contrast sensitivity. Visual acuity is the key factor for the seeing efficiency. Shlaer [21] revealed that visual acuity directly corresponds to the level of retinal illuminance, as shown in Figure 3-1. In both visual acuity charts, grating and Landolt C, the visual acuity increases for higher illuminance. We need to find out illuminance levels at supermarkets and household so that we can properly set experimental condition for illuminance.

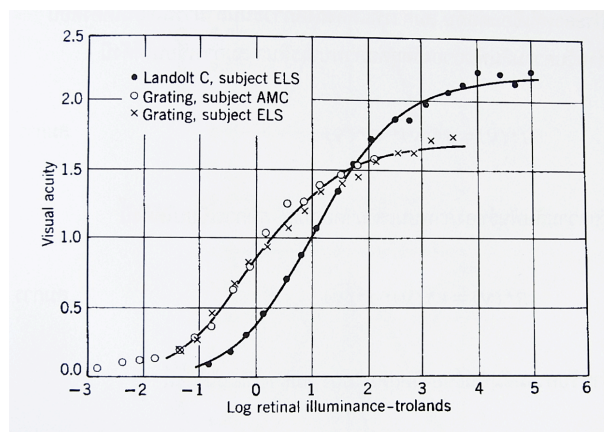

Figure 3-1 Visual acuity for retinal illuminance determined by Landolt C (●) and grating (○, ×) [20].

3.2 Experiment

The concern for illumination environment was on illumination levels and illumination settings. We measured the light vertically and horizontally under conditions that applicable to our intended experimental setting. A Minolta CL200 illuminometer as shown in Figure 3-2 was used for measuring the illuminance at the spot of targeted area.

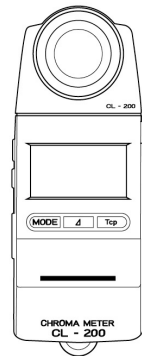

Figure 3-2 The Minolta Chroma Meter CL-200 illuminometer.

For supermarket measurement, 3 measuring conditions were made. The first condition measured vertical plane illuminance in the direction outward from the shelf at the position of 150 cm above ground (V-150) as shown in Figure 3-3 (a). This situation simulates when one is looking at products on shelves standing on the floor. The second condition measured horizontal plane illuminance toward the ceiling at the position of 100 cm above ground (H-100) as shown in Figure 3-3(b). This situation simulates when one looks at products on hands. The third condition measured vertical plane illuminance in the direction outward from the shelf at the position of 60 cm above ground (V-60) as shown in Figure 3-3(c). This situation simulates when one is looking at products on shelves while they are crouching on the floor.

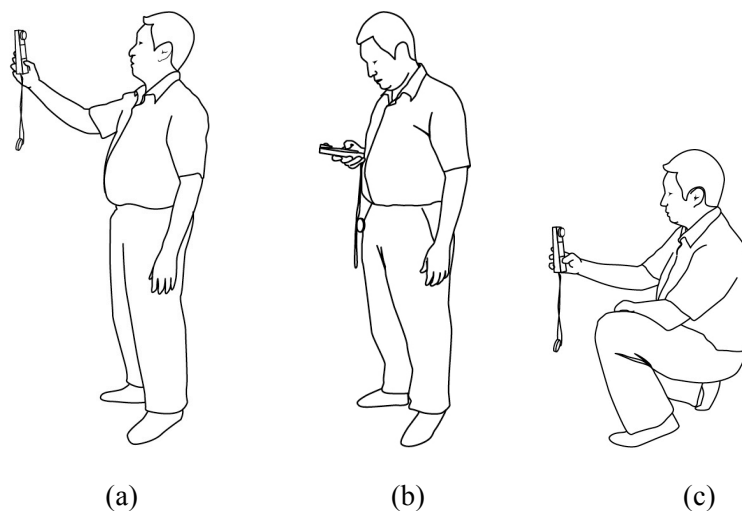

Figure 3-3 Positions and directions of light measurement: (a) measuring vertical plane illuminance at 150 cm above ground (V-150); (b) measuring horizontal plane illuminance at 100 cm above ground (H-100); (c) measuring vertical plane illuminance at 60 cm above ground (V-60).

The supermarket in our survey includes 4 modern supermarkets in downtown Bangkok, which represent the general supermarket in Thailand. The date of survey was on August 13, 2009. Objects in supermarkets for which we measured the illuminance included daily products, meat products, health care products, shampoo, dried food, canned food, and beverage.

The survey of household lighting was conducted on August 12-13, 2009 at the house of PP and on November 10, 2009 at the house of BW and NR. For household lighting measurement, the measuring conditions simulated the actual label reading of elderly in their daily living. Lighting measurement for households was conducted during daytime and nighttime. Both vertical plane and horizontal plane illuminance were measured. The 4 conditions were daytime vertical plane illuminance (V-Day), daytime horizontal plane illuminance (H-Day), nighttime vertical plane illuminance (V-Night), and nighttime horizontal plane illuminance (H-Night). The measuring places included living room, bedroom, pantry, kitchen, bathroom, corridor, stock room, etc. The measuring spots and directions include refrigerator front, objects in refrigerators, shelf by the window, inside shelf, TV shelf, telephone shelf, memo side, side table, main table toward inside, main table toward outside, main table toward entrance, gas range, etc. Double measurements were carried out at every targeted spots to average data.

3.3 Results

3.3.1 Supermarket survey

For supermarket survey, there were 16 points of measured data altogether in each condition of V-150, H-100, and V-60 from 4 supermarkets. They were put together for analysis. The illuminance levels were divided with intervals of 200 lx and number of cases included in each interval was counted. The result of V-150 is shown in Figure 3-4. The abscissa shows the illuminance in lux and the ordinate the number of cases of that illuminance. The actual illuminance depends on the illumination system adopted by supermarkets but the result shows the most frequent illuminance occurred at 500 lx. The illuminance distributed from 155 to 1153 lx with the average 585 lx as shown by a short vertical line on the abscissa.

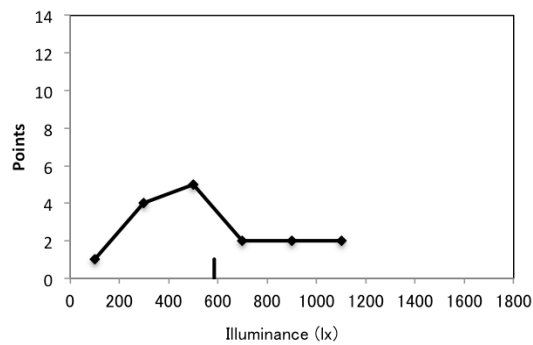

Figure 3-4 Distribution of vertical plane illuminance in supermarket (V-150).

The result from condition H-100 is shown in Figure 3-5. The actual illuminance varied from 232 to 1737 lx and the average was 825 lx.

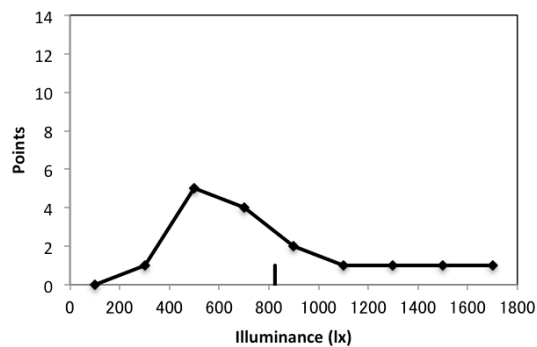

Figure 3-5 Distribution of horizontal plane illuminance in supermarket (H-100).

The result from condition V-60 is shown in Figure 3-6. The actual illuminance varied from 124 to 427 lx and the average was 301 lx. It is interesting to note that the distribution is rather narrow around 300 lx.

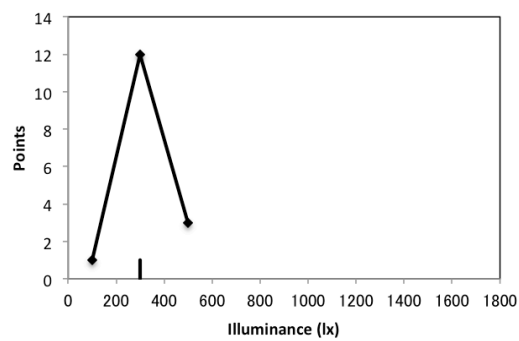

Figure 3-6 Distribution of vertical plane illuminance in supermarket (V-60).

3.3.2 Household survey

Points of measurement in household in 4 conditions, V-Day, H-Day, V-Night, and H-Night, varied among conditions depending on the actual situation. For the daytime measurement, there were 19 points of V-Day condition and 13 points of H-Day condition. For the nighttime measurement, there were 19 points of V-Night condition and 33 points of H-Night condition. The data of each condition was put together for analysis. The illuminance levels were divided with intervals of 20 lx and the number of cases included in each interval was counted.

The result from condition V-Day is shown in Figure 3-7. The abscissa shows the illuminance in lux and the ordinate the number of cases of that illuminance. The illuminance distributed from 9 to 95 lx with the average of 34 lx as shown by a short vertical line on the abscissa.

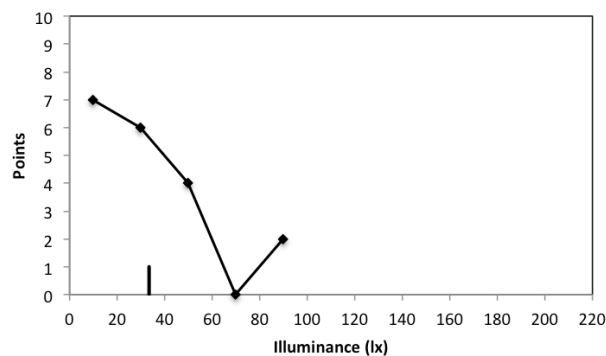

Figure 3-7 Distribution of vertical plane illuminance in household (V-Day).

The result from condition H-Day is shown in Figure 3-8. The actual illuminance varied from 14-125 lx and the average was 41 lx.

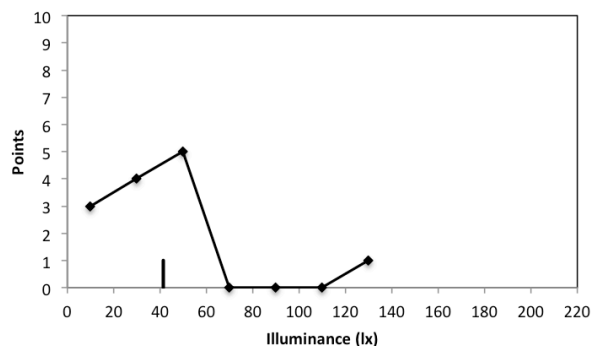

Figure 3-8 Distribution of horizontal plane illuminance in household (H-Day).

The result from condition V-Night is shown in Figure 3-9. The actual illuminance varied from 12-155 lx and the average was 52 lx.

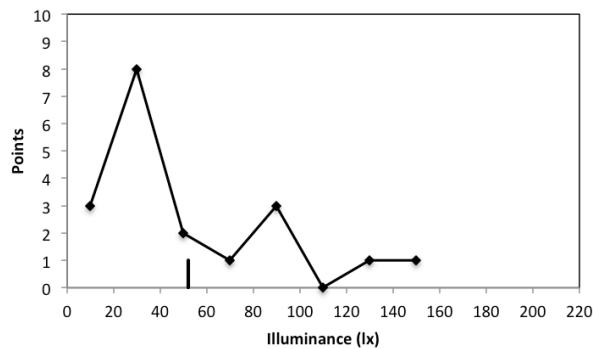

Figure 3-9 Distribution of vertical plane illuminance in household (V-Night).

The result from condition H-Night is shown in Figure 3-10. The actual illuminance varied from 28-545 lx, with the average of 100 lx as shown by the dotted vertical line on the abscissa. There was only one scattered data point of 545 lx which was the spot inside the shelf in the bathroom where the lamp was close to the shelf floor. It was the only scattered illuminance that jumped out far from the group which were ranging continually from 28-204 lx. We decided to take the point of 545 lx out. Then the adjusted data had the illuminance varied from 28-204 lx and the average was 86 lx, as shown by the black short vertical line on the abscissa.

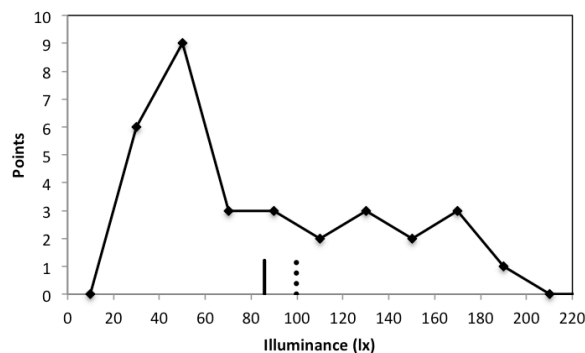

Figure 3-10 Distribution of horizontal plane illuminance in household (H-Night).

3.4 Discussion on survey of illumination environment

The purpose of this research is to find out the proper visual environment in terms of illumination levels at supermarkets and at household where elderly do the

action in their daily life. It is important that elderly be able to see and read products label clearly when they do shopping for their daily use.

The range and mean of illuminance in supermarket and household from our survey are summarized in Table 3.1. We found that with the same plane of measurement, mean illuminance in supermarket are obviously higher than illuminance of the household. This is due to the standard setting of lighting in the supermarket which is the commercial place. The standard lighting has to guarantee that normal customers can see the products and read the labels efficiently to promote the sales. On the other hand, the illuminance in the household was much lower even reaching only 9 lx.

Table 3.1 Illuminance in supermarkets and households

Place	Conditions	Vertical plane		Horizontal plane	
		Range of illuminance (lx)	Mean illuminance (lx)	Range of illuminance (lx)	Mean illuminance (lx)
Supermarket	V-150	155 - 1153	582	-	-
	H-100	-	-	232 -1737	825
	V-60	124 - 427	301	-	-
Household	V-Day	9 - 95	34	-	-
	H-Day	-	-	14 - 125	41
	V-Night	12-155	52	-	-
	H-Night	-	-	28-204	86

The illuminance for seeing and reading product labels are mostly vertical plane illuminance as most of the products display on the shelf while labels shown vertically to our eyes. In some case we grasp the product to closely see the label, then the reading distance is reduced to near distance and the almost horizontal plane illuminance is applied, which is normally the much better visual condition compared to the condition of seeing product label on the shelf. So we will not worry about the reading in short distance under horizontal plane illuminance. In our experiment we aim to use only vertical plane illuminance.

To do the research experiment we want to assign as much necessary variable conditions as possible to get the full coverage of result. However, we have to avoid the overwhelming of data and the pain from unnecessary redundancy. In terms of illuminance setting for the experiment, we concerned with the coverage from low illuminance to high illuminance. The illuminance setting between the low and high should also provide enough points of transition and proper gap between each points.

For the lower limit of experimental setting, we looked into the V-Day and V-Night of the household. The mean illuminances were 34 and 52 lx, which concerned as low illuminance. The actual illuminance of V-Day even as low as 9-10 lx which were the area of window shelf and table measured during daytime. But if we concern that low light in daytime may easily be covered by turning the labels into the sunlight reaching area. However, for the V-Night, the actual illuminances went low to around 20 lx for the table, except 12 lx for the refrigerator. So we will set the low illuminance for our experiment to 20 lx to find out how efficient it will be for the legibility of product labels.

The high illuminance for our experiment should reflect the high illuminance from our survey, which is condition V-150. In this condition that illuminance ranged from 155-1153 lx, the mean of 582 lx may be assigned for high illuminance. However, concerning the coverage for upper end illuminance, we adjusted the high illuminance to 800 lx which is approximately in the middle of higher distributed illuminance range.

To assign the in between illuminance, we concern the concept of “ the design of experiment”. Due to many parameters required for the research, we keep illumination conditions as minimal as possible. By adding 2 control points between low and high illuminance, we will be able to get the trend of result properly. We also have to make the total 4 illuminance conditions spread apart evenly in terms of logarithmic scale as shown in Figure 3-11. So we set the vertical plane illuminance for our experiment starting from 20 lx to 800 lx with 2 more steps in between. The proposed illuminance set up for experiment were 20, 80, 280 and 800 lx as shown in Table 3-2.

Table 3.2 The assigned illuminance of 20, 80, 280, and 800 lx and the conversion into log unit

Experimental conditions	Illuminance (lx)	Log Illuminance (lx)
1	20	1.30
2	80	1.90
3	280	2.45
4	800	2.90

The common distance for conducting visual acuity can be near and far. It depends on the chart used that predefined for measurement at certain distance. The near distance visual acuity test normally conducted at standard 40 cm distance, while the far distance measure acuity at 20 feet or 6.1 meters away. However, our actual condition for supermarket shopping is that customers stand in front of the shelf and scan their eyes across to see labels of products that they need. The distance for that action is approximately 120 cm. By this real situation, none of the standard testing distance matches our criteria. However, we know that under a certain visual acuity, the visual angle becomes constant. Then the distance for size can be interpolated into another distance when the size of optotype changes. Actually we want to do acuity experiment at the distance of 120 cm so that it will be most matched the actual distance. We also try to avoid the hidden fault that may occur under different conditions which is not so simple as the plain interpolation.

CHAPTER IV

ONE-ROOM EXPERIMENT

4.1 Introduction

The most important perception that allows people to live their daily life efficiently is certainly the effective visual function. The basic elements of human visual perception compose of light, stimulus objects, and the human visual system that include eyes and brain. People depend on effective visual function to be able to deal with activities in their daily life. Young people and elderly people have different visual efficiency especially the elderly people's handicap on visual acuity and contrast sensitivity, as we discussed in Chapters 1 and 2. Normally in daily life, we depend on our visual system to see and identify things that we want to use. In most cases we also need to read texts displayed on the product labels to get information that is important for the correct usage of the product, and even safety warning. Elderly people face more difficulties than young people on these visual tasks since their visual system are deteriorated.

People spend their daily life at home and some other places such as street, public transportation, office, shopping center, and supermarket. However, our interest for this research was scoped on the household and supermarket, since they are the basic living places, especially for the elderly people. When people do their shopping for their daily needs at supermarkets, they depend on the visual system to look and find ~~the~~ certain products of their need. It is important to investigate how small letters elderly people can read in circumstances like supermarket and household. In this chapter we investigate how the visual stimulus parameters such as letter size and contrast will affect visual acuity of the elderly people and young people. Illumination of the visual scene plays an important role on this visual efficiency. At low illuminance, visual acuity dropped significantly. The survey in Chapter 3 revealed that illuminance in supermarkets is relatively high compared to illuminance in the household. We will find out how efficient certain illuminance has on visual acuity of elderly people and young people.

One-room experiment is to simulate people's situation at their shopping and at their living in a house. Every experiment is carried out in one room where some illumination is given just as in a supermarket or in a household. Test chart for measuring the visual acuity is placed in an experimental room, where subjects also stay to look at the chart.

4.2 Apparatus

4.2.1 Cataract experiencing goggles

One of the serious problems of the visual performance of the elderly comes from the cloudy crystalline lens of the cataract. Cataract is a clouding of the lens that produce an overall haze, resulting in the deteriorated visual acuity and contrast sensitivity, and the increased sensitivity to glare. Cataract starts in the crystalline lens of every body when he/she gets old and it becomes worse as aged. It scatters the incoming light all over the retina and diminishes the sharpness of detail. In the advanced stage of cataracts, print appears faded and words become harder to read. In order for young people to have the simulated cataract vision of the elderly, we let them put on and see through the cataract experiencing goggles.

Cataract experiencing goggles are the goggles made of filters that simulate the properties of cataract eyes. Obama et al. [12] developed the goggles so that young people can experience the elderly vision. They are sometimes called Panasonic cataract experiencing goggles, as shown in Figure 4-1. Principally, they are composed of three filters which are: a color filter, a neutral density filter, and a haze filter. The first two reduced the light transmitted but the last haze filter scatter incoming light. When putting together they simulate the elderly vision with cataract.



Figure 4-1 The Panasonic Cataract Experiencing Goggles.

The spectral transmitted curve of the first two filters combined together is shown in Figure 4-2 [22]. Said and Weale [4] measured spectral transmittance for different ages and showed that the transmittance decreases with age but particularly it decreases more evidently at short wavelengths decreases. The curve in Figure 4-2 shows the property. The photometric transmittance was calculated to have the value of 58% [23]. Then we know the actual retinal illuminance of the young eyes that put goggles on, which is 58% of the measured illuminance. The property of the haze filter is specified by the haze value, which is the percentage of scattered light to the total

transmitted light. The Panasonic goggles have 14% of the haze value [24].

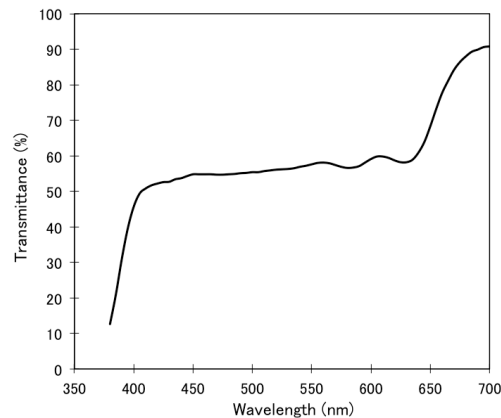

Figure 4-2 Spectral transmittance curve of color filter and brightness filter of the goggles [22].

We may call the goggles the Panasonic goggles if it is necessary to distinguish it from other goggles. The goggles particularly simulate the cataract eyes that start to cause the owner some daily inconveniences such as difficulty in reading labels and signs, identification mistake for faces of acquaintances, mistake to choose a pair socks of dark color, and so on. The investigation of visual performance by using the cataract experiencing goggle will provide better visual environment for the elderly at this stage. For young observers, visual acuity will be decreased with cataract experiencing goggles wearing on [13]. We employ cataract experiencing goggles in one-room experiment to get the visual acuity of elderly eyes that simulated with young eyes.

4.2.2 Experimental room

To experiment the influence on visual acuity of various parameters under certain illuminance, we need a specially designed experimental room. The experimental room with the dimension of 100 cm wide, 150 cm deep, and 210 cm high was built to simulate the normal room as shown in Fig 4-3. The room was big enough to fit an experimenter and a subject together in the room. The 150 cm depth of the room was enough to accommodate the 120 cm viewing distance for the experiment. A subject sat back to one end of the room and looked at the vertical chart C at the other end of the wall. The experimenter sat in left front side of the subject to control the test chart and record the response of observer. The room was decorated to be similar to a normal living room. The walls were covered by light beige color smooth surface paper. The shelf and walls were decorated with scenery pictures, dolls,

artificial flowers, etc. There were 6 fluorescent daylight lamps of 18 watts installed to the ceiling at the middle of the ceiling. The direction of the lamps was perpendicular to the front wall. The 6 ceiling lamps altogether were able to light up to 1500 lx vertical plane illuminance at the chart holder position. Two lamps at the center (lamp #1 & #2) were individually attached to light controller for the fine tuning of illuminance, while the other 4 lamps (lamps # 3-6) that position off center by 2 lamps to each sides, were attached to individual switches.

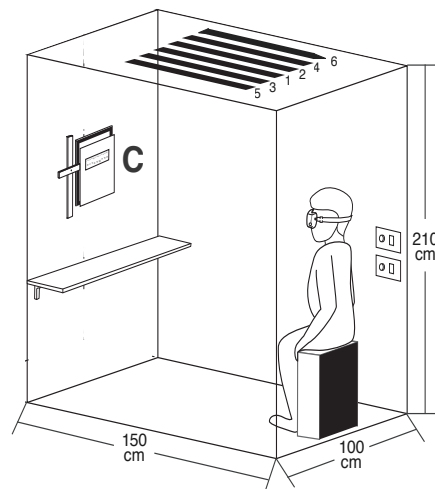

Figure 4-3 One-room experimental room.

The chart holder was placed at the front wall of the experimental room. It was designed to hold the test chart of A4 size to move vertically behind the window facet, and showed only one line of letters to the observer, as shown in Figure 4-4. The gray color facet of window was 33 cm wide x 21.5 cm high and the window was 17.2 cm wide x 1.8 cm high. Test chart was placed into the slot of the chart holder and experimenter move the chart up and down to show the line of letters for subject to respond. The chart holder was used for all font sizes, font types, and contrast throughout the one-room experiment.

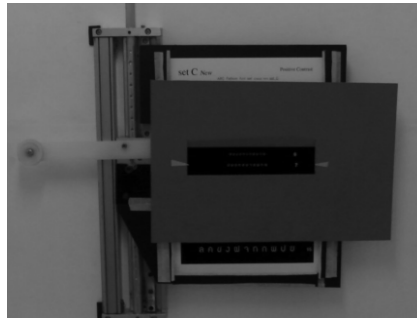

Figure 4-4 Chart holder for vertical chart movement behind the static facet window.

Chin rest was designed to act as the reminder for subject during experiment, as shown in Fig 4-5. With its adjustable length and correct setting, the upper tip of the chin rest aligned at the chin of subject. Subject then was reminded not to move the head forward to look at the chart closer than the assigned distance.



Figure 4-5 Chin rest (left) and demo (right) for controlling the correct viewing distance.

4.2.3 Letter chart

Adopting the concept for designing new visual acuity charts for clinical research by Ferris et al. (1982) [25], the printed Thai letters test chart was designed in the principle that each line are of equal difficulty. There was a geometric progression in letter size from line to line, which provided a similar task for each line on the chart with the letter size being the only variable. Each letter chart was in A4 size of portrait orientation. Each chart represented one font of one polarity contrast. There were 16 lines of letters graduating size from small to large, with even geometrically even size distribution. Each line contained 10 different letters with the same letter height that intended to have similar difficulty. The layout of letters position utilized the grid system. All letters of all sizes in the same chart were placed to the grid position. The same baseline was applied to base line distance for all 16 lines, which was 1.48 cm. The distance between the center of each letter in the same line was 1.28 cm. The

letters for the letter chart were all placed into the fixed position. Layout samples layout of letter charts of the same font in negative and positive contrast are shown in Figure 4-6.

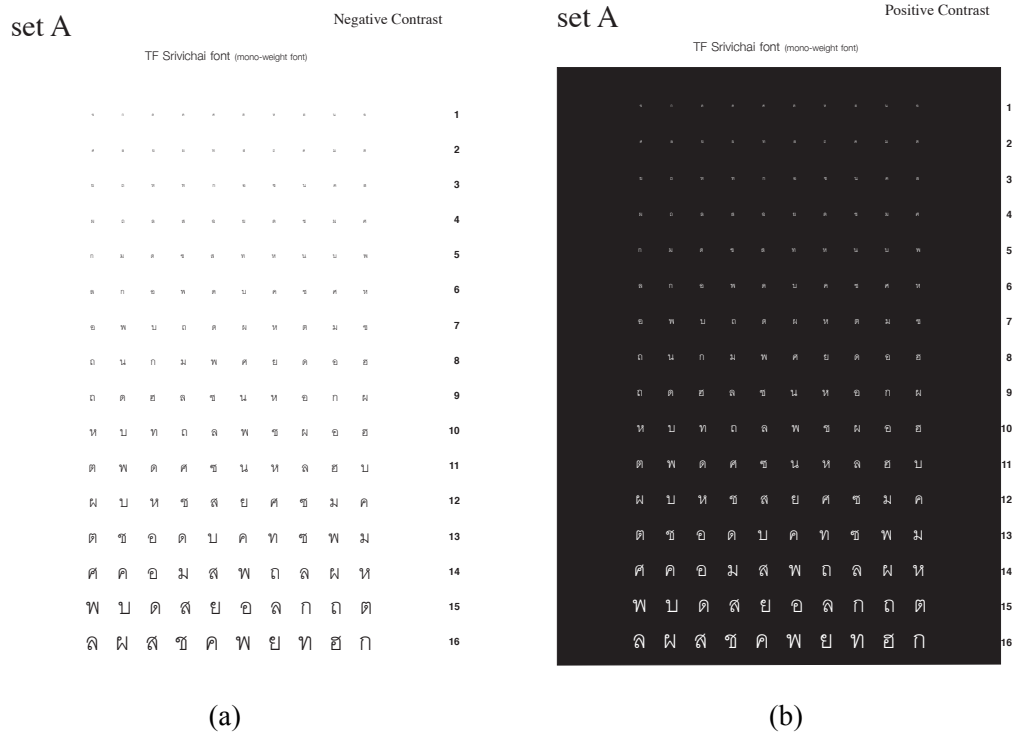

Figure 4-6 Actual layout of letter charts of font TF Srivichai or font A in negative contrast (a) and positive contrast (b).

To test visual acuity, we test the power of eye that discriminate the stimulus cue point. In case of Landolt C, the broken gap of symbol “C” represent the α , which is the subtended angle of the gap to the eye. Size of the whole letter C is 5 times of that gap size. By the same concept, we applied Thai letters in our letter chart design for testing visual acuity. The retinal image size is constant under a certain subtended angle that the eye sees the stimulus, as shown in Figure 4-7. The retinal distance is fixed to the length from the center of crystalline lens to the retinal plane which is about 17 mm. But with the same retinal image size under the same visual angle or α , stimulus size can vary depending on the stimulus distance from the eye.

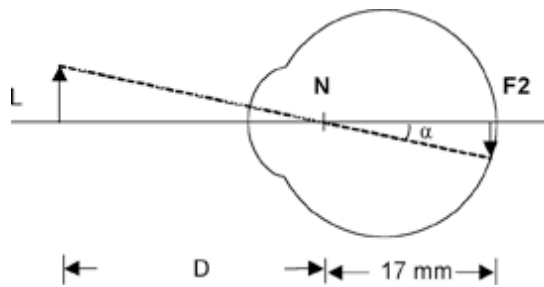

Figure 4-7 Constant retinal image size subtended by constant visual angle α [26].

When viewing distance fixed at 120 cm, we vary the stimulus size to test the acuity power of the eye. The variation of letter size among each line was made into the even interval in term of $\log \alpha$. The α that represent normal visual acuity is called Minimum Angle of Resolution, or MAR. Then the even interval of letter size in term of $\log \text{MAR}$ is used to test acuity power under each condition. The proper variation among each stimulus size was made into equal interval in the logarithmic value of the visual angle or $\log \alpha$. For our chart design, the visual angle interval between each line of letter was made into $0.05 \log \alpha$. With the viewing distance of 120 cm, the letter height comparable to each visual angle interval was ranged from 0.981 mm of the smallest in line #1 to 5.518 mm of the biggest in the line #16. The line number, $\log \alpha$, letter height, and point size for each line of letter chart are shown in Table 4-1.

Table 4-1 Letter height and point size for each line of letter charts

Line number	$\log \alpha$	Letter height (mm)	Equivalent point size
1	-0.551	0.981	6.7
2	-0.501	1.101	7.6
3	-0.451	1.235	8.5
4	-0.401	1.386	9.5
5	-0.351	1.555	10.6
6	-0.301	1.745	12
7	-0.251	1.958	14
8	-0.201	2.197	16
9	-0.151	2.465	18
10	-0.101	2.766	20
11	-0.051	3.103	22

Table 4-1 (cont.)

Line number	$\log \alpha$	Letter height (mm)	Equivalent point size
12	-0.001	3.482	25
13	0.049	3.907	28
14	0.099	4.383	32
15	0.149	4.918	36
16	0.199	5.518	40

Chart design and layout was made with Adobe InDesign CS3 version 5.0 on Apple Macintosh computer. The finished layout was converted into Adobe PDF file format for print out. The 3 fonts selected for the test were TF Srivichai, TF Pimpakarn, and ABC Pathom. TF Srivichai font (font A for our experiment) represented the text font with mono-weighted stroke that normally be used as text font. TF Pimpakarn font (font B for our experiment) represented the text font with variable-weighted stroke that also normally be used as text font. ABC Pathom font (font C for our experiment) represented the casual font that intended to use as display font at large size, but usually be mis-used as text font, and may has draw back on readability. The 3 fonts are shown in Figure 4-8. There were 20 letters from each font selected for making the letter chart.

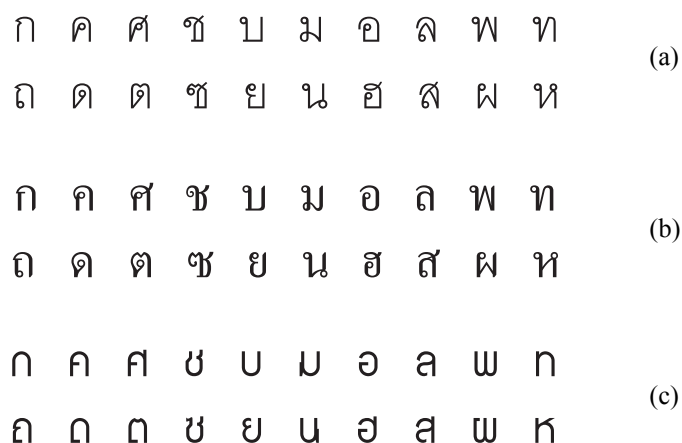

Figure 4-8 Three fonts for one-room experiment: (a) TF Srivichai or font A; (b) TF Pimpakarn or font B; (c) ABC Pathom or font C.

Charts reproduction were made in black and white with digital printers. The negative contrast chart was printed using Canon Pixma inkjet printer onto the 260 gsm glossy coated IJ inkjet paper. The positive contrast chart was printed using Canon BLP 50 laser printer onto the 160 gsm matte coated paper. Charts printing were made at Canon showroom at the Canon head office in Bangkok.

The polarity contrast from black and white printing can be achieved by printing solid black ink onto white paper. For negative contrast, the stimulus letters were printed with solid stroke line in black ink which give minimal luminance, while the white unprinted paper act as the background which give maximum luminance. For positive contrast, the background was printed with solid area of toner covering white paper which give minimal luminance, while the stimulus letters stroke line were left unprinted to act as white letters which give maximum luminance. In our chart reproduction, the negative contrast chart that printed with liquid ink by inkjet printer on ultra-white paper gave higher contrast than the positive contrast chart that printed with toner by laser printer on matte coated standard white paper. The two different contrasts printing cannot be made with the same printer due to the limitation of quality control for letter size and stroke width. The reproduction quality control mainly concerned that the same letter size and stroke width be achieved for the same font under different contrast.

Letter size of the 3 fonts in negative contrast and positive contrast were microscopically measured as shown in Figure 4-9 to verify the correct letter height for each line. The overlay plot of 6 different letter charts for log letter height of each line number is shown in Figure 4-10. It demonstrated that the distribution of letter height among each line numbers were evenly distributed in term of visual angle interval.

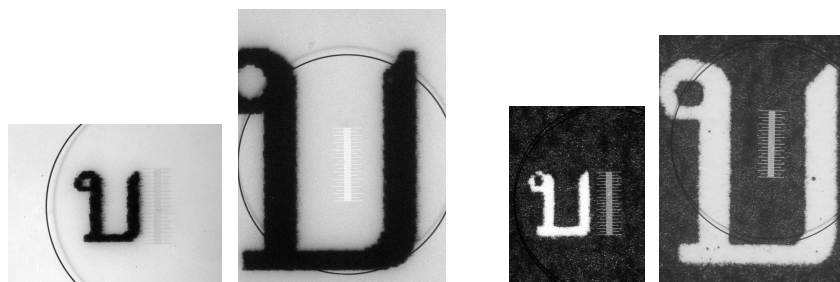

Figure 4-9 The microscopic measurement of printed letter size in negative contrast (left pair), and positive contrast (right pair).

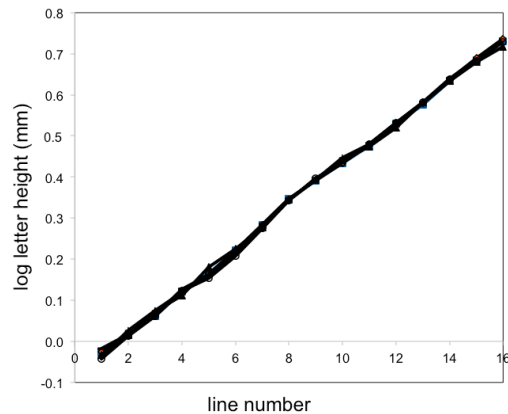

Figure 4-10 The overlay graph of log letter height for each line number of font TF Srivichai, TF Pimpakarn, and ABC Pathom in negative and positive contrast.

4.3 Experimental condition

The experimental conditions in one-room experiment include illuminance, font types, polarity contrast, goggles, and viewing distance, and they are summarized in Table 4-2. The illuminance levels were determined after surveying illuminance used in supermarkets and households as given in Table 3.2.

Table 4-2 One-room experimental conditions

Experiment	Conditions
Illumination levels (lx)	20, 80, 280, 800
Font types	TF Srivichai, TF Pimpakarn, ABC Pathom
Polarity contrast	Negative, Positive
Goggles	Off, On
Viewing distance (cm)	120

4.4 Procedure

4.4.1 Orientation for subjects

Subjects were recruited from students of Department of Imaging and Printing Technology, Faculty of Science, Chulalongkorn University. There were 5 subjects in the one-room experiment who are 3 males (SN, PP, ET) and 2 females (CP, PW). All subjects aged 25-35 years old during experimental time (2010). They all have normal vision, or wear their best-corrected vision aid to have normal vision during the

experiment.

Subjects were expected to understand and be aware of psychophysical experiment. They were informed of their task to respond honestly to provide correct result of the experiment. They were recommended to do experiments by the procedure set by the experimenter, which is proper for both experimenter and subject. They also understood that as volunteers, they had the right to pause the experiment at any time, or withdraw from being the subject if they did not want to continue. Subjects did not receive any money or reward for conducting the experiment, but the experimenter provided snack and drink for refreshing to subjects during experiments.

When a subject starts the experiment for the first time, he/she will be introduced about the task they are required to do. The subject was welcomed to the experimental room and was introduced to each facility in the room. He sat on a chair and the experimenter checked for the correct chair height to confirm correct height of eye level. The chin rest was equipped and adjusted so that the upper end point almost touch the chin of subject. The subject was advised not to bend the head or body forward to maintain correct viewing distance, otherwise he/she will be reminded as the chin touches the chin rest. Goggles were hung on the wall next to subject and ready for subject to put on for the experiment under goggles vision.

4.4.2 Datasheet

The datasheet for one-room experiment was made for checking the correct response. Each datasheet corresponded to a letter chart as shown in Figure 4-11 (a) and (b). Each line of letter chart comprised 10 randomized letters. In the datasheet, there were 2 check boxes under each letter of every line. The left box was for marking response with normal eyes or response experimented without goggles, which described as Cataract Goggles “Off”. The right box was for marking response with goggles or eyes with goggles, which described as Cataract Goggles “On”. Line numbers were written to each side of the line for accurate data checking. Relevant experimental information such as font set, contrast, illuminance, date and time, trial of experiment, and the name of subject, also collected in the datasheet form as shown in Figure 4-11 (a). The datasheet corresponded to each letter chart was made for easy checking of correct response to the letters on the chart. It used large size answer letters for easy looking even in the dim light.

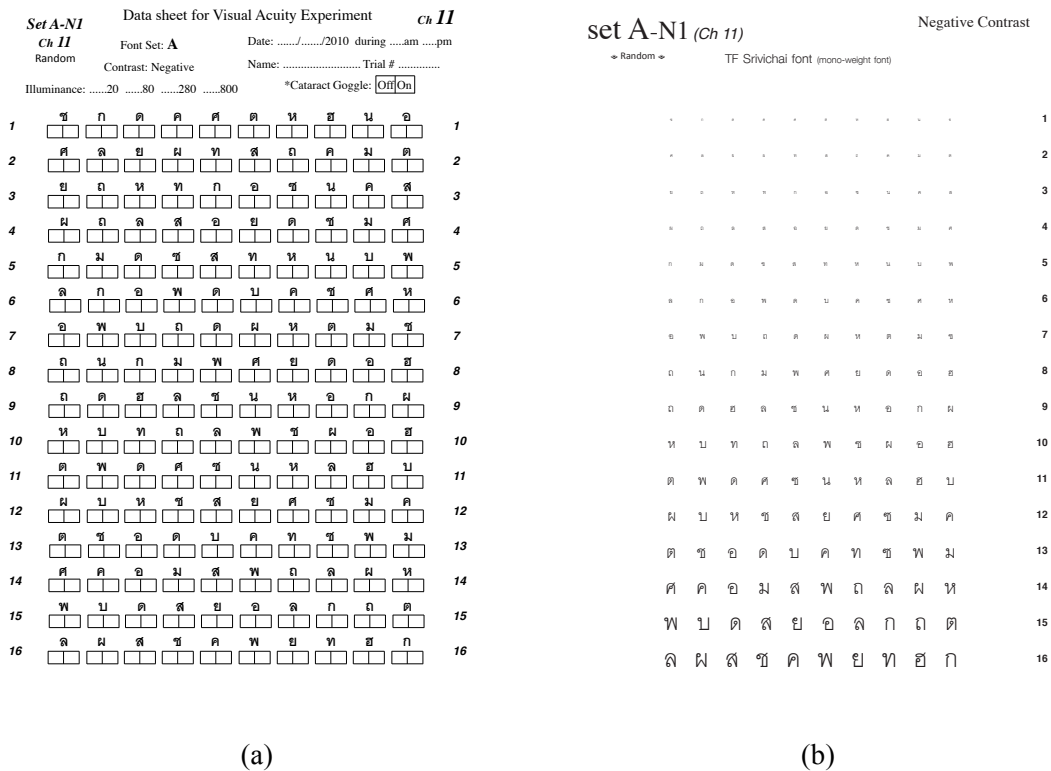

Figure 4-11 Example of the datasheet for font A in negative contrast (a) which corresponded to the letter chart for font TF Srivichai in negative contrast (b).

There were series of 6 letter charts for experimenting with one illuminance, called one set. A set of letter charts comprised of charts in TF Seivichai font (font A), TF Pimpakarn font (font B), or ABC Pathom font (font C), and each fonts comprised of one negative contrast and one positive contrast chart. In order to prevent subject from remembering the letter charts, 4 sets of chart were made in the same manner, but with randomized letters. In each session of experiment, all 4 sets of letter charts were used each by an illuminance condition. This made total of 24 letter charts in one session of experiment.

The letters in 24 letter charts were all randomized. To ease experimenter on picking the correct datasheet that corresponded to its matching letter chart, codes were assigned to each datasheet and letter charts. Table 4-3 shows the codes used for each chart and data sheet, and its information.

Table 4-3 Codes for matching of datasheets and letter charts.

Code	Chart Set	Font Name	Font Set	Contrast
Ch11	1	TF Srivichai	A	Negative
Ch12	1	TF Pimpakarn	B	Negative
Ch13	1	ABC Pathom	C	Negative
Ch14	1	TF Srivichai	A	Positive
Ch15	1	TF Pimpakarn	B	Positive
Ch16	1	ABC Pathom	C	Positive
Ch21	2	TF Srivichai	A	Negative
Ch22	2	TF Pimpakarn	B	Negative
Ch23	2	ABC Pathom	C	Negative
Ch24	2	TF Srivichai	A	Positive
Ch25	2	TF Pimpakarn	B	Positive
Ch26	2	ABC Pathom	C	Positive
Ch31	3	TF Srivichai	A	Negative
Ch32	3	TF Pimpakarn	B	Negative
Ch33	3	ABC Pathom	C	Negative
Ch34	3	TF Srivichai	A	Positive
Ch35	3	TF Pimpakarn	B	Positive
Ch36	3	ABC Pathom	C	Positive
Ch41	4	TF Srivichai	A	Negative
Ch42	4	TF Pimpakarn	B	Negative
Ch43	4	ABC Pathom	C	Negative
Ch44	4	TF Srivichai	A	Positive
Ch45	4	TF Pimpakarn	B	Positive
Ch46	4	ABC Pathom	C	Positive

The letters were randomly distributed. There were letters corresponded to letter chart of TF Srivichai font in negative contrast, letters corresponded to letter chart of TF Srivichai font in positive contrast, letters corresponded to letter chart of TF Pimpakarn font in negative contrast, letters corresponded to letter chart of TF Pimpakarn font in positive contrast, letters corresponded to letter chart of ABC Pathom font in negative contrast, and letters corresponded to letter chart of ABC Pathom font in positive contrast, as demonstrated in Table 4-3. The samples of letters which were written out in each coded datasheet were shown in Figure 4-12.

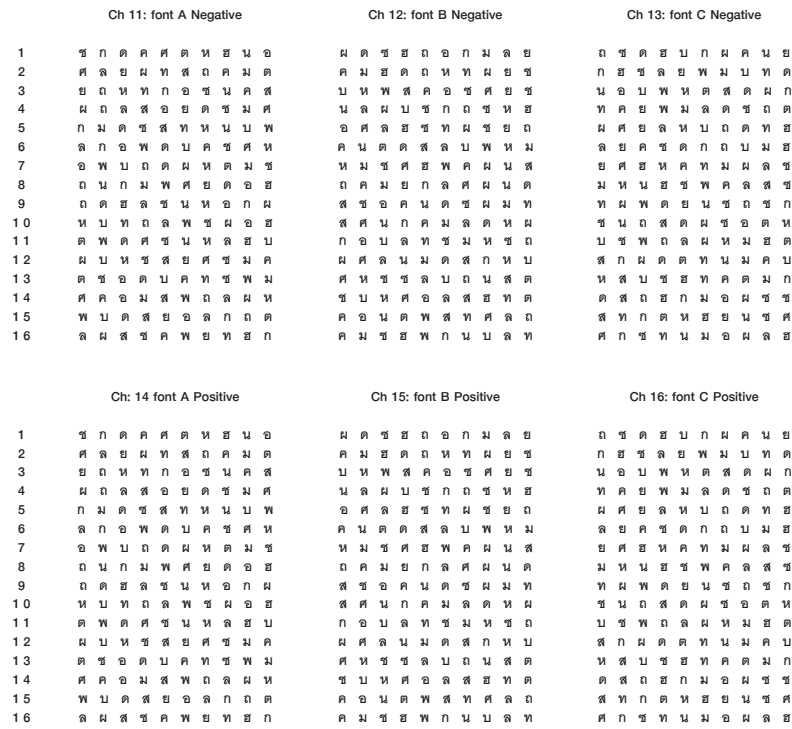

(a)

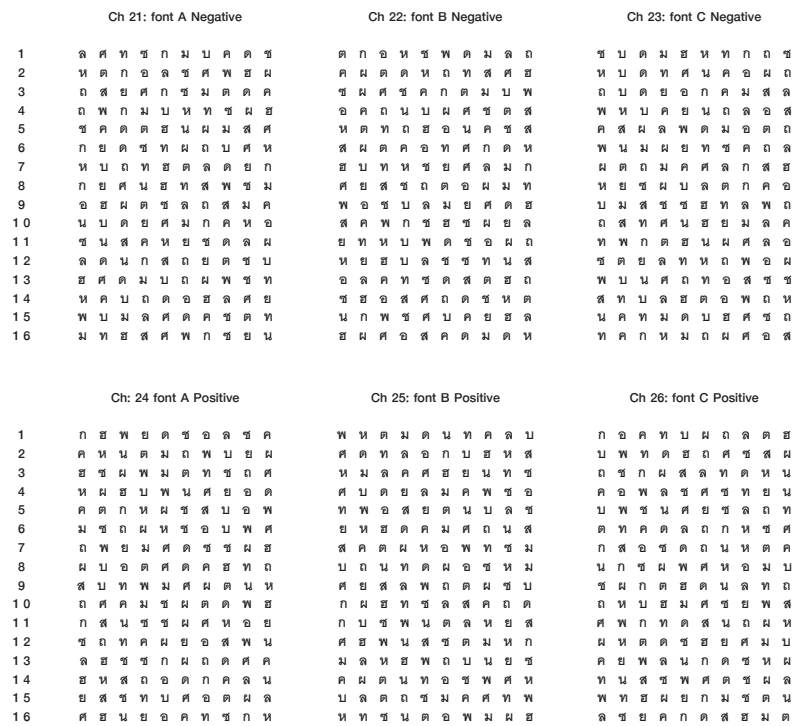

(b)

Figure 4-12 Samples of chart sets showing letters written out from letter charts. Letters are shown under code and description of source chart. (a) set 1; (b) set 2.

4.4.3 Experimental procedure

To start a session of experiment, an illumination level among 20, 80, 280, or 800 lx was set to the vertical plane illuminance. A letter chart of TF Srivichai font in negative contrast and the corresponding datasheet were prepared. The letter chart was placed in the chart holder where vertical movement of chart was controlled by the experimenter. A subject looked at the line of letters shown through the facet window and read out one by one from the left to the right. The experimenter recorded the correct response and judged for the next movement of chart. If subject's correct response was 30% or lower, then do not move chart to any smaller line. If subject's correct response was 80% or higher, then do not move chart to any bigger line. The response for each chart must cover the small size to the big size, which actually covered the sizes that provide 50% correct response.

Experimenter managed the experiment and made data collecting. When the line of letters shown to subject, he/she looked at the line of letter and responded by read out all 10 letters one by one from left to right. Experimenter checked with the answer and mark in the corresponding box in the datasheet. If the letter read out by subject correctly, experimenter marked with "✓" symbol in the box. If the letter read out wrong or the subject said "I can not read", the experimenter marked with "×". For the line that had been tested, all relevant boxes were checked. There were many lines in the chart that had not been tested because it was outside of the test criteria, then check box for those letters were left blank or unchecked. In the case that the subject tried to read a line of small letter but could not read or read out wrong for the 10 letters, then the experimenter marked with "×" for the 10 letters.

After the experiment with normal eyes, the subject put the goggles on to have the vision of eyes with goggles. The chart movement was in the same manner as did for normal eyes. Then experiment for TF Srivichai font in negative contrast with normal eyes and eyes with goggles were accomplished. Letter charts of TF Srivichai font in positive contrast and its corresponding datasheets were prepared for the ongoing experiment, which conducted under the same illuminance. After completion of TF Srivichai font, then follow with TF Pimpakarn font in negative contrast and positive contrast. Finally ABC Pathom font in negative contrast and positive contrast were experimented. The round of 3 fonts in negative and positive contrast experimented with goggles and without goggles were done for 1 illuminance.

The second illuminance was set and the whole round of experiment as described above was conducted. After completion of the second illuminance, then

moved to the third illuminance and the fourth illuminance. Then one session of experiment or one trial was fulfilled. It took about 3-4 hours to complete one session. Each subject was required to conduct 5 trials of experiment. If experiment shall be paused or stopped, experimenter tried to stop at the completion of each chart.

4.5 Results

Figure 4-13 shows 4 data sheets filled with the subject PW's responses for the TF Srivichai font in positive contrast under illuminance of 20 lx (a), 80 lx (b), 280 lx (c), and 800 lx (d). All charts were experimented with goggles and without goggles. Each letter specified in the position of each line on the datasheet corresponded to the same letter displayed with actual parameters in the letter chart.

In this example subject started with 20 lx illuminance. For experiment on TF Srivichai font in positive contrast with letter chart coded Ch34, the data recorded in datasheet Ch34 as shown in Figure 4-13 (a). The data for normal eyes shown that subject responded 10% correct in line #3, 60% correct in line #4 and #5, and 70% correct in line #6. For the experiment of eyes with goggles, subject responded 30% correct in line #7, 60% correct in line #8, and 80% correct in line #9. When experimented under 80 lx illuminance, data were recorded in datasheet Ch14 as shown in Figure 4-13 (b). The result of normal eyes were 20% correct in line #3, 50% correct in line #4, and 70% correct in line #5. The result of eyes with goggles were 0% correct in line #5, 40% correct in line #6, 50% correct in line #7, and 80% correct in line #8.

The next lighting was 280 lx, which used the chart corresponded to datasheet Ch44, as result shown in Figure 4-13 (c). The result of normal eyes were 30% correct in line #2, 50% correct in line #3, and 70% correct in line #4. The result of eyes with goggles were 30% correct in line #4, 50% correct in line #5, 60% correct in line #6, and 70% correct in line #7. And for the last lighting of 800 lx to complete one session of TF Srivichai font in positive contrast, the datasheet Ch24 was used to collect the test result, as shown in Figure 4-13 (d). Under 800 lx, the result of normal eyes were 30% correct in line #2, 40% correct in line #3, and 80% correct in line #4. The result of eyes with goggles were 0% correct in line #3, 60% correct in line #4, 70% correct in line #5, and 80% correct in line #6.

Set A-P3 Data sheet for Visual Acuity Experiment **ch 34**
Ch 34 Font Set: **A** Date: ...4./...1.../2010 during ...am...pm
 Random Contrast: **Positive** Name:PW..... Trial #1.....
 Illuminance: 20 80 280 800 *Cataract Goggle: Off On

1	ม	ถ	พ	บ	ก	ศ	ย	ห	น	ด		
2	ย	ด	ม	ล	ก	อ	ส	พ	ช	ธ		
3	อ	ม	ด	ห	น	ส	ก	ค	ย	บ		
4	ม	ย	ห	ด	พ	ก	ล	ธ	น			
5	ศ	ม	น	ด	ย	อ	น	ธ	ด	ช		
6	บ	ม	ล	พ	ธ	ย	ส	ช	ย	น		
7	ม	น	ส	ศ	ย	พ	ช	ย	ด			
8	ค	ย	อ	ย	ล	ธ	น	ส	น			
9	ย	ช	ห	ศ	ล	พ	ม	น	ส	ด		
10	ย	ส	บ	ม	พ	ธ	ก	อ	ศ	ช		
11	ม	ด	ส	ล	พ	ค	ช	ย	น	ห		
12	น	ย	น	ช	ล	อ	ด	ก	ม			
13	บ	ก	พ	น	ช	ด	ก	น	ส	ม		
14	ส	ย	ด	ก	พ	น	ด	ก	ค			
15	บ	พ	ห	ย	อ	ก	น	ธ	ศ	ล		
16	ด	น	ส	ศ	ด	ช	อ	ล	พ	อ		

(a)

Set A-P1 Data sheet for Visual Acuity Experiment **ch 14**
Ch 14 Font Set: **A** Date: ...4./...1.../2010 during ...am...pm
 Random Contrast: **Positive** Name:PW..... Trial #1.....
 Illuminance: 20 80 280 800 *Cataract Goggle: Off On

1	ช	ก	ด	ค	ศ	ด	ห	ธ	น	อ		
2	ศ	ล	ย	น	ส	ก	ค	ม	ด			
3	ย	ถ	ห	ย	ก	อ	ช	น	ค	ส		
4	น	อ	ล	ส	อ	ย	ด	น	ศ			
5	ก	ม	ด	ช	ส	ย	ห	น	บ	พ		
6	ล	ก	อ	พ	ด	บ	ค	ช	ศ	ห		
7	อ	พ	บ	อ	ด	น	ห	ด	ม	ย		
8	ถ	น	ก	ม	พ	ศ	ย	ด	อ	ย		
9	ถ	ด	ย	ล	ช	น	ห	อ	ก	น		
10	ห	บ	ย	ล	พ	ช	น	อ	ย			
11	ด	พ	ด	ศ	ช	น	ห	ล	ธ	บ		
12	น	บ	ห	ช	ย	ศ	ช	ม	ค			
13	ด	ช	อ	ด	บ	ค	ห	ช	พ	ม		
14	ศ	ค	อ	ม	ส	พ	อ	ล	น	ห		
15	พ	บ	ด	ส	ย	อ	ล	ก	ถ	ด		
16	ล	น	ส	ช	ค	พ	ย	ย	ธ	ก		

(b)

Set A-P4 Data sheet for Visual Acuity Experiment **ch 44**
Ch 44 Font Set: **A** Date: ...4./...1.../2010 during ...am...pm
 Random Contrast: **Positive** Name:PW..... Trial #1.....
 Luminance: 20 80 280 800 *Cataract Goggle: Off On

1	ย	อ	ศ	ด	ม	ก	น	ช	ห	พ		
2	ช	ก	ธ	ส	บ	ห	พ	ด	อ	ล		
3	ก	ค	ห	บ	อ	ส	ช	ย	ด	ด		
4	ม	ย	ค	ค	อ	น	ช	บ	น	ห		
5	ส	ล	ย	ช	ก	ย	ด	พ	อ	น		
6	พ	ส	ธ	บ	ก	ด	ล	น	ม	ศ		
7	ด	ด	ห	ย	ช	ก	ถ	ช	ล	ด		
8	ธ	น	อ	ม	พ	ช	ค	ด	บ	ด		
9	ม	ส	ช	ด	อ	ด	ย	บ	พ	น		
10	ล	ค	ช	อ	พ	ส	ด	ย	ย	ช		
11	ม	ย	ด	ห	อ	พ	ช	ย	ธ	ย		
12	ห	พ	ช	บ	ย	ม	ค	ก	ศ	ถ		
13	ค	ย	ด	น	ล	ธ	อ	ย	พ	ด		
14	น	อ	ส	ช	ย	ห	น	ก	ม	ย		
15	ก	ถ	ม	ด	น	ค	ด	น	ช	ศ		
16	บ	ส	ธ	อ	ห	ช	พ	น	ค	ล		

(c)

Set A-P2 Data sheet for Visual Acuity Experiment **ch 24**
Ch 24 Font Set: **A** Date: ...4./...1.../2010 during ...am...pm
 Random Contrast: **Positive** Name:PW..... Trial #1.....
 Illuminance: 20 80 280 800 *Cataract Goggle: Off On

1	ก	ธ	พ	ย	ด	ช	อ	ล	ช	ค		
2	ค	ห	น	ด	ม	ถ	พ	บ	ย	น		
3	ธ	ช	น	พ	ม	ด	ย	ด	อ	ศ		
4	ห	น	ส	บ	พ	น	ศ	ย	อ	ด		
5	ค	ด	ก	ห	น	ย	ส	บ	อ	พ		
6	ม	ช	ถ	น	ห	ช	อ	บ	พ	ศ		
7	ถ	พ	ย	ม	ศ	ด	ช	ช	น	ย		
8	น	บ	อ	ด	ศ	ค	ค	ย	ห	ถ		
9	ส	บ	ห	พ	ม	ศ	น	ค	น	ห		
10	ถ	ศ	ค	ม	ช	น	ด	ค	พ	ย		
11	ก	ส	น	ช	น	ศ	ห	อ	ย			
12	ช	ถ	ย	ค	น	ย	อ	ส	พ	น		
13	ล	ย	ช	ช	ก	น	อ	ด	ศ	ค		
14	ย	ห	ส	ถ	อ	ด	ก	ค	ล	น		
15	ย	ส	ช	ห	บ	ศ	อ	ด	น	ล		
16	ศ	ย	น	ย	อ	ค	ห	ช	ก	ห		

(d)

Figure 4-13 Example of recorded datasheets of subject PW experimented on TF Srivichai font in positive contrast under 4 illuminance levels of 20 lx (a), 80 lx (b), 280 lx (c), and 800 lx (d).

The raw response data in the datasheets were scored for percent of correct response of each tested line number. Since we have 10 letters in each line of chart, each correct answer accounted for 10% correct response. The percent of correct response of each line then input in the form in spreadsheet program as seen in Figure 4-14. With result experimented under 20 lx illuminance, response from the experiment by normal eyes was input in the left column, and response from the experiment by eyes with goggles was input in the right column. With the same pattern for 80 lx, 280 lx, and 800 lx, response data by normal eyes and eyes with goggles was input to demonstrate the response result of TF Srivichai font in positive contrast under 4 lighting conditions and 2 goggles conditions, which represented one session of experiment for TF Srivichai font in positive contrast, as shown in Figure 4-14. Subject continued to experiment for the rest 4 sessions to complete the whole experiment for TF Srivichai font in positive contrast. Practically, under each illuminance setting, subject also did parallel experiment on negative contrast of TF Srivichai font, and parallel experiment with positive and negative contrast of TF Pimpakarn font and ABC Pathom font. That means by 1 illuminance, the experiment on the 3 fonts in negative and positive contrast, or the total of 6 letter charts were conducted. The data of each testing was collected and analyzed separately.

line #	20 lx		80 lx		280 lx		800 lx	
	Normal eyes	Eyes w/ Goggles	Normal eyes	Eyes w/ Goggles	Normal eyes	Eyes w/ Goggles	Normal eyes	Eyes w/ Goggles
1								
2					30		30	
3	10		20		50		40	0
4	60		50		70	30	80	60
5	60		70	0		50		70
6	70			40		60		80
7		30		50		70		
8		60		80				
9		80						
10								
11								
12								
13								
14								
15								
16								

Figure 4-14 Example of data entry of TF Srivichai font in positive contrast from session 1 of subject PW, showed the percent of correct response in each experimented line number under illumination levels of 20, 80, 280, and 800 lx.

The data in Figure 4-14 then plotted into probability-of-seeing curve, as shown in Figure 4-15. Along the abscissa the line number is taken and along the

ordinate the percentage of correct response is taken. Probability-of-seeing curve in each graph here represented one session of experiment. The 50% seeing can be acquired by two ways. The first method was by calculating the regression line equation. The second method was by plotting the 50% seeing from the regression line in the graph. By either ways, the result of 50% seeing will be agreed.

To calculate the 50% seeing from regression formula, we need the regression equation. With the plotted probability-of-seeing curve, the regression and its equation can be found in Figure 4-15. For the condition of 20 lx experimented by eyes without goggles, the regression equation is $y = 18x - 31$. Since we want 50% seeing in the ordinate, the equation becomes $50 = 18x - 31$. Then $x = (50+31)/18 = 4.5$. The abscissa corresponding to 50% seeing is the line number 4.5.

To get 50% seeing by the second method, we looked at a regression line in the graph. From 50% seeing in the ordinate, the horizontal dotted line was drawn to reflect the regression line into the same scale in the abscissa. Then the line number for 50% seeing of the condition 20 lx experimented by eyes without goggles was approximately 4.5, which was the same result as from the first method.

In this experiment, we used the first method to get the line number corresponding to 50% seeing. By the known line number, we can convert into letter height, and re-convert into visual angle and visual acuity.

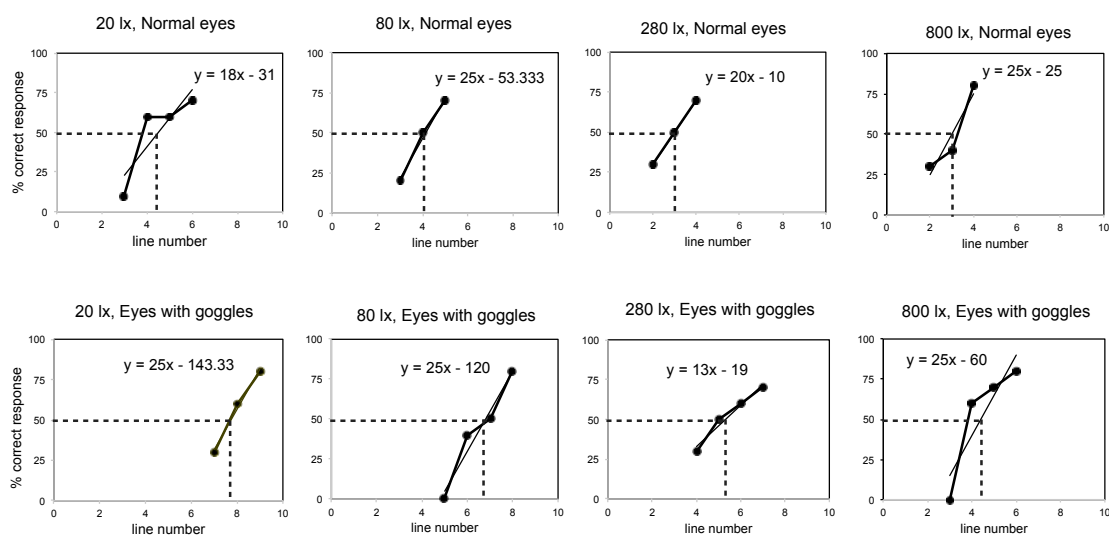

Figure 4-15 Examples of probability-of-seeing curve. Dotted lines illustrate how to get line number for 50% seeing traced from regression line. They are all results of PW experimented with TF Srivichai font in positive contrast under 20 lx illuminance.

Each probability-of-seeing curve and the line number corresponded to 50% seeing from each session of experiment was acquired separately. There was normally variance among each session. Figure 4-16 shows the probability-of-seeing curves with regression lines from 5 sessions superimposed in a same graph. Graph (a) shows the variance among 5 sessions experimented by normal eyes, and graph (b) by eyes with goggles. This was the result from PW experimented on TF Srivichai font in positive contrast letter chart under 20 lx illuminance.

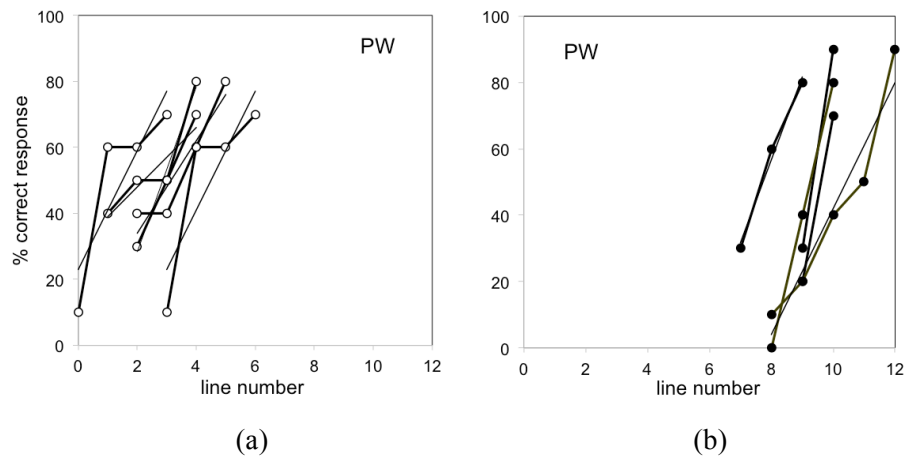

Figure 4-16 Probability of seeing curves with regression lines from 5 sessions superimposed in the same graph. They are all results of PW experimented with TF Srivichai font in positive contrast under 20 lx illuminance. (a) normal eyes; (b) eyes with goggles.

The line numbers corresponding to 50% seeing were obtained for 5 sessions, respectively, and were averaged. Figure 4-17 shows an example of results obtained from the subject PW and for TF Srivichai font in positive contrast. The abscissa gives illuminance of the subject room in logarithmic unit and the ordinate the line number at 50% seeing. Open circles represent normal eyes, and filled circles eyes with goggles. Vertical bars show the standard deviation from 5 sessions. The intra-subject variance data of the one-room experiment is available in Appendix.

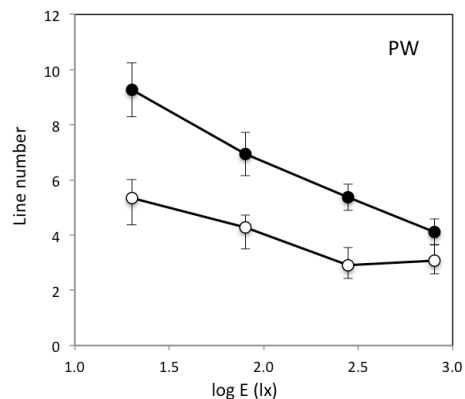

Figure 4-17 Example of results obtained from the subject PW for TF Srivichai font in positive contrast. ○, normal eyes; ●, eyes with goggles.

So far we expressed the results by line number at 50 % of seeing but we are interested in the letter height at 50 % of seeing. To convert the line number LN to the letter height LH in mm we used the viewing distance of 120 cm and the following equation.

$$LH = 10^{((0.0513 \times LN) - 0.0829)} \quad (1)$$

Figure 4-18 is the re-plot of Figure 4.17 in the letter height. It shows that the letter height decreased when the illuminance was increased. This tendency happened to the normal eyes as well as eyes with goggles, but eyes with goggles needed much higher letter size compared with the normal eyes. At 20 lx or 1.30 in log unit the eyes with goggles required the letter height of 2.5 mm while the normal eyes needed only 1.6 mm. The difference decreased for higher illuminance and at 800 lx or 2.90 in log unit, the letter height by eyes with goggles came rather close to that by normal eyes. It is noticed that the standard deviation increased for lower illuminance with goggles eyes.

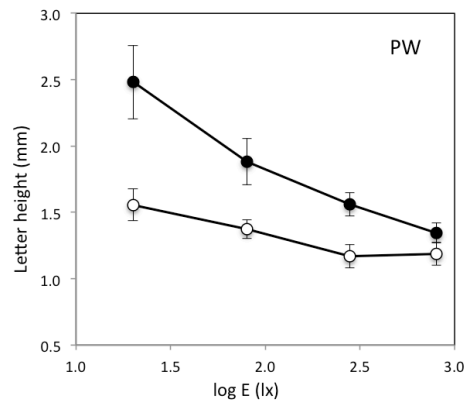

Figure 4-18 Results from 5 sessions of the subject PW on TF Srivichai font in positive contrast shown by the letter height at 50% seeing. ○, normal eyes; ●, eyes with goggles.

Other four subjects, PP, SN, ET, and CP showed similar results in tendency of the letter height-illuminance curve as the subject PW. The inter-subject variance data of the one-room experiment is available in Appendix. In Fig 4-19 the results for the case of TF Srivichai font and of the negative contrast are shown for the subjects PW and PP. The curves of the subject PW are very similar to those in Figure 4-18 for the positive contrast case to imply that the contrast polarity does not affect much for the readability of letters. The vertical position of the curves differ between the subjects PW and PP in Figure 4-19 but the tendency of the curves, namely a slow decrease with the normal eyes and a rapid decrease with the goggled eyes is common in the subjects.

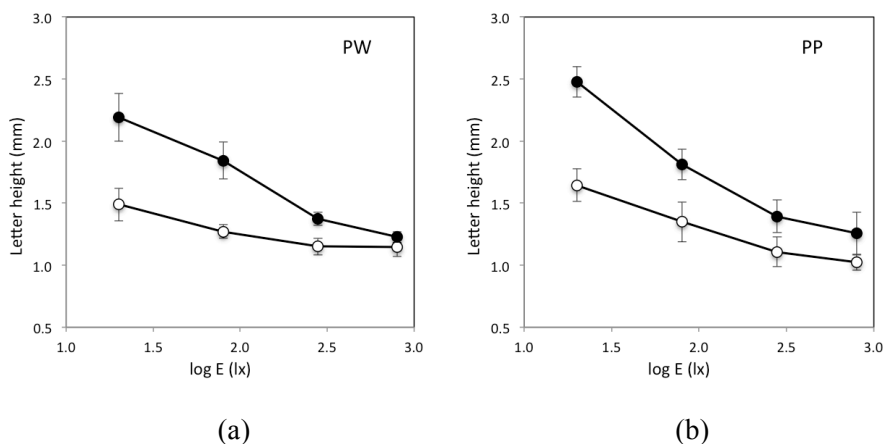

Figure 4-19 Results of two subjects for TF Srivichai font in negative contrast. (a) PW; (b) PP.

○, normal eyes; ●, eyes with goggles.

The averaged results of 5 subjects, PW, PP, SN, ET, and CP are shown in Figure 4-20 for different conditions: (a) for TF Srivichai font positive; b, TF Pimpakarn font positive; c, ABC Pathom font positive; d, TF Srivichai font negative; e, TF Pimpakarn font negative; f, ABC Pathom font negative. Short vertical bars indicate the standard deviation among five subjects. Standard deviation is small for all the conditions except for the condition of eyes with goggles at 20 lx. For eyes with goggles, the decrease of letter height took place rapidly for increasing the room illuminance, while it was slow with normal eyes.

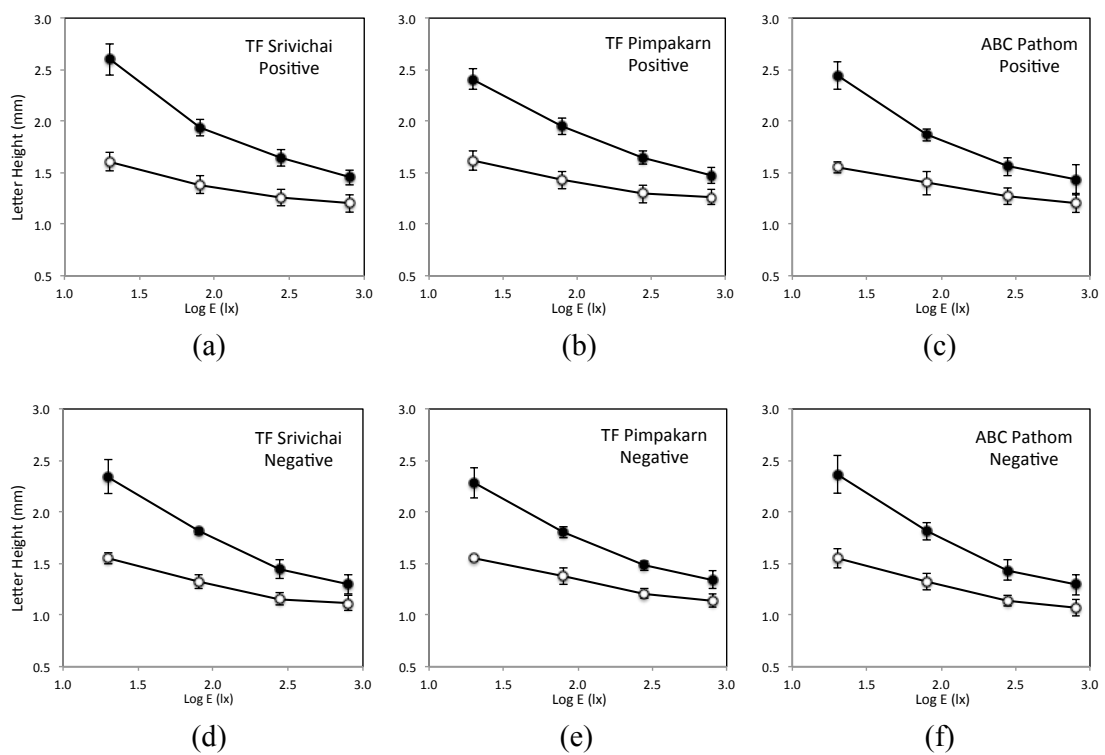

Figure 4-20 Averaged results of 5 subjects of letter height-illuminance curve in the case of positive contrast: (a) TF Srivichai; (b) TF Pimpakarn; (c) ABC Pathom. Result of negative contrast: (d) TF Srivichai; (e) TF Pimpakarn; (f) ABC Pathom. ○, normal eyes; ●, eyes with goggles.

To compare the effect of polarity of contrast precisely the figures of upper line and the lower lines are plotted together in Figure 4-21. The positive contrast needed approximately 0.1 mm bigger letter height than the negative contrast. Comparison between eyes with goggles in a font of positive contrast needed approximately 0.2-0.3 mm bigger letter height than the negative contrast in all the

illuminance. In the ABC Pathom font, the tendency of curves are all the same as in the other two fonts, but letter height difference between positive contrast and negative contrast are small about 0-0.1 mm at 20 lx, but bigger with higher illuminance to the gap of 0.2 mm in both normal eyes and eyes with goggles. The negative contrast always gave better result than the positive contrast in all three fonts. The advantage of negative contrast over positive contrast fonts experimented with normal eyes was found slight compared to the more significant result that experimented by eyes with goggles.

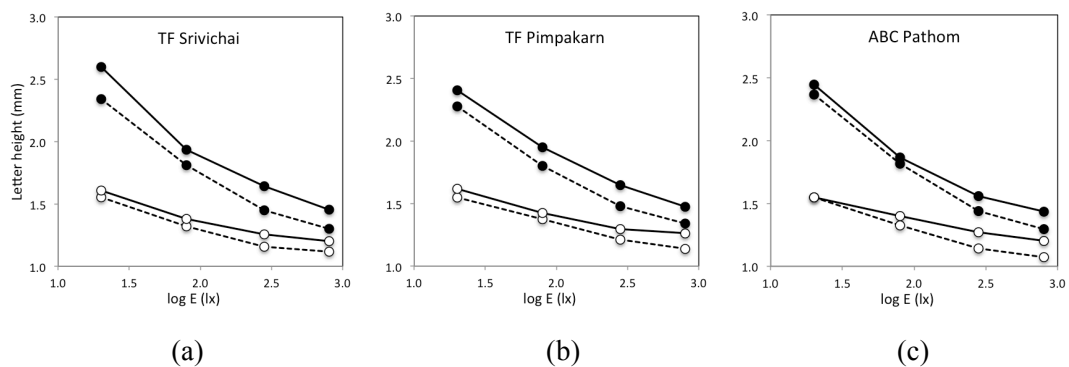

Figure 4-21 Comparison of contrast effect: (a) TF Srivichai; (b) TF Pimpakarn; (c) ABC Pathom. Solid lines, positive contrast; dotted lines, negative contrast. ○, normal eyes; ●, eyes with goggles.

To see difference among fonts the curves of three fonts are plotted together in Figure 4-22 for positive and negative contrast, respectively. Three curves with normal eyes almost overlapped, and the curves with goggles also almost overlapped but with slight difference in the positive case.

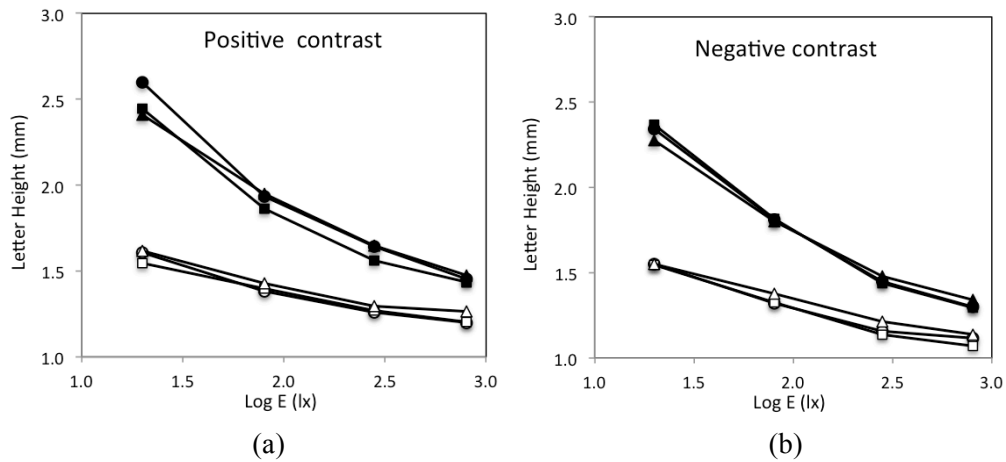

Figure 4-22 Graphs comparing letter height-illuminance curves from average 5 subjects of the 3 fonts under different goggles conditions in (a) positive contrast; (b) negative contrast. ○, TF Srivichai normal eyes; ●, TF Srivichai eyes with goggles; △, TF Pimpakarn normal eyes; ▲, TF Pimpakarn eyes with goggles; □, ABC Pathom normal eyes; ■, ABC Pathom eyes with goggles.

The letter height used in the above graphs is meaningful for the viewing distance of 120 cm only and it is desirable to use a more universal unit, namely the visual angle which is not affected by the viewing distance. The visual angle is the stimulus' angular height or the angle that stimulus height subtended in the eye. We state the visual angle here in minute so that it can be directly converted to the visual acuity. The visual angle θ can be calculated from the letter height LH and viewing distance D by the following equation.

$$\theta = 2 \arctan(LH/2D) \quad (2)$$

Visual acuity is a measure to show spatial resolution of the eye and defined a reciprocal of a letter gap that a subject can discriminate as explained in Figure 2-1 of Chapter 2. The gap is expressed by the visual angle in minutes. In the case of International Standard which used Landolt C the gap is made 1/5 of the whole letter. In Thai letters, cue for letters' identification is the top, bottom, middle, or tail and its size is about 1/5 of letter size or letter height as shown in Figure 4-23. So we took 1/5 of the letter size to calculate the visual acuity from the letter height.

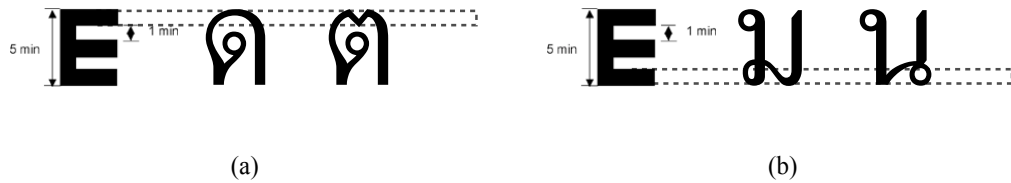

Figure 4-23 The similarity of identification power of Thai letters compared to Snellen E optotype. a, cue at letter top; b, cue at letter bottom. Font: TF Pimpakarn.

The visual acuity VA is finally given as in the following equation.

$$VA = 1/\theta \quad (3)$$

Figure 4-24 shows the averaged visual angle of 50% seeing from 5 subjects for the positive and negative contrast: a, TF Srivichai font; b, TF Pimpakarn font; c, ABC Pathom font. With normal eyes for TF Srivichai font, the visual angle of the positive contrast decreased from 4.7 to 3.4 min with increased illuminance, while that of the negative contrast gave the decrease from 4.5 to 3.1 min. The eyes with goggles in the same font gave more rapid decreased of visual angle from 7.4 to 4.2 min for positive contrast, and from 6.8 to 3.8 min for negative contrast. This tendency of decreased visual angle with the increased illuminance and the curve shape of positive and positive contrast maintained with TF Pimpakarn font and ABC Pathom font, except some small difference of the vertical point.

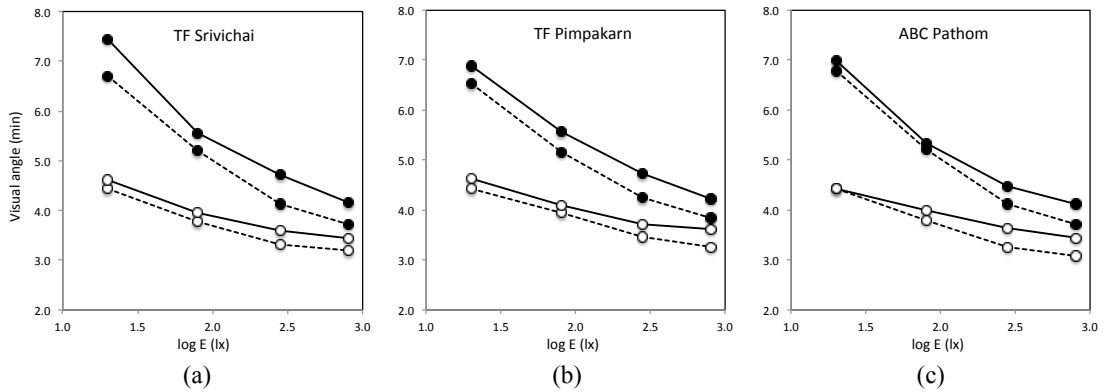

Figure 4-24 The visual angle-illuminance curves for three fonts: a, TF Srivichai; b, TF Pimpakarn; c, ABC Pathom. Solid lines, positive contrast; dotted lines, negative contrast. ○, normal eyes; ●, eyes with goggles.

Curves plotted for the visual acuity are shown in Figure 4-25 for three fonts: a, TF Srivichai; b, TF Pimpakarn; c, ABC Pathom. The visual acuity increased with the increased illuminance in all the conditions. The visual acuity of normal eyes shows the superiority over eyes with goggles, being higher by 0.4 with normal eyes with TF Srivichai font in positive contrast at 20 lx, and by 0.3 at 800 lx. The same tendency also took place for the negative contrast. Result from the other two fonts also showed the same tendency. Compared to visual acuity of 1.0 which is considered normal visual acuity, the illuminance that gives comparable visual acuity was 280 lx of eyes with goggles and 20 lx for normal eyes.

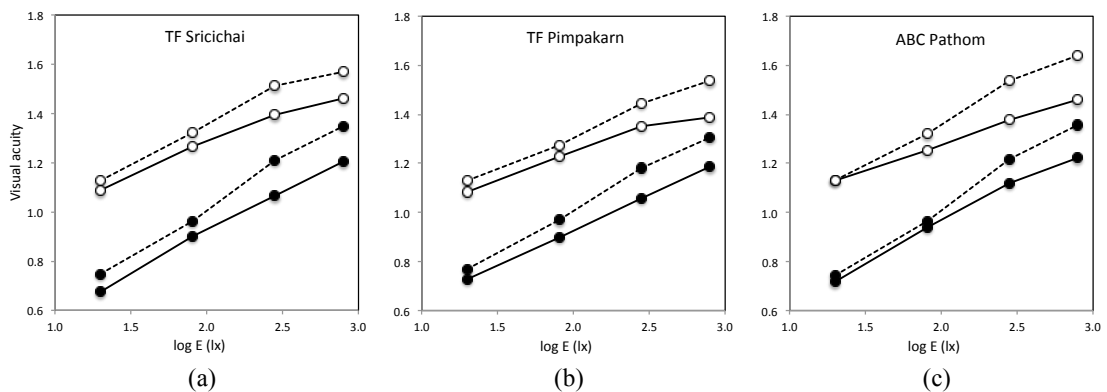

Figure 4-25 The visual acuity-illuminance curves for three fonts: (a) TF Srivichai; (b) TF Pimpakarn; (c) ABC Pathom. Solid lines, positive contrast; dotted line, negative contrast. ○, normal eyes; ●, eyes with goggles.

4.6 Discussion on one-room experiment

The goggles are composed of a color filter and a haze filter. As we see the spectral transmittance curve of the color filter shown in Figure 4-2, the photometric transmittance was calculated to have the value of 58%. Amount of light by the illuminance of 20, 80, 280, and 800 lx were actually 11.6, 46.4, 162.4 and 464 lx for the retinal illuminance for eyes with goggles without considering the reduced illuminance due to the foggy filter. The dotted curves in Figure 4-26 were obtained by shifting the curves with goggles by the amount -0.23 or $\log .58$ along the abscissa. The results show that even without the reduced illuminance caused by the goggles, the visual performance of eyes with goggles is still worse than the normal eyes. The main cause of visual deterioration then should come from the scatter of the foggy filters.

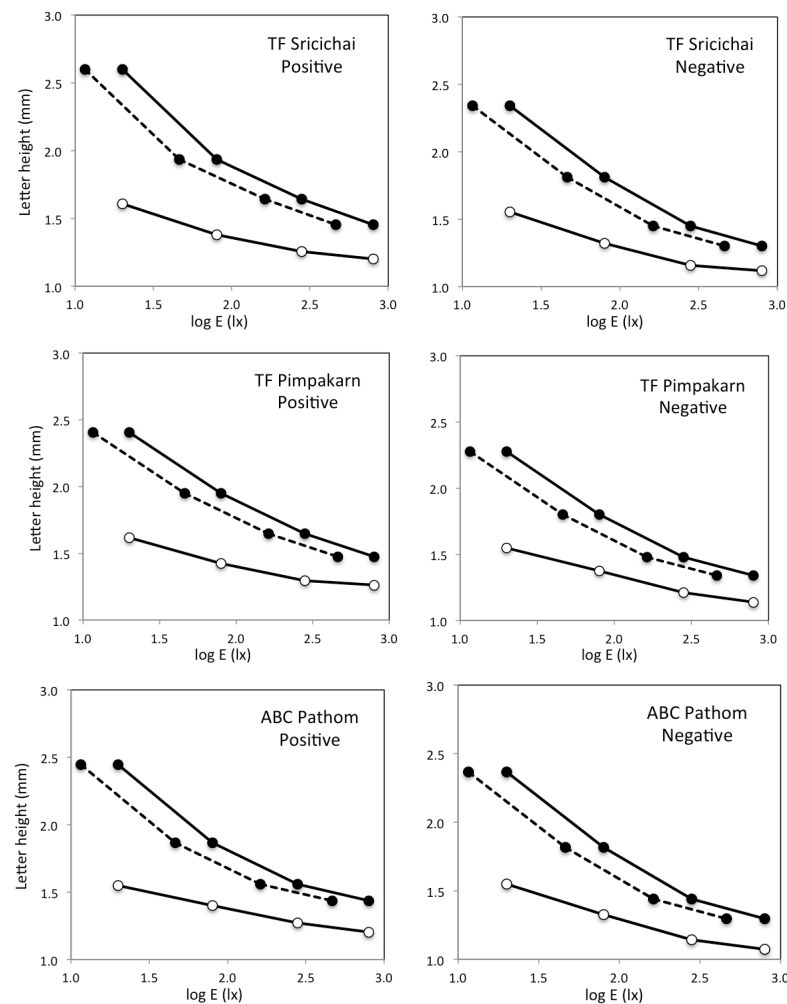

Figure 4-26 Letter height-illuminance curves compensated for transmittance factor of goggles shown by dotted lines for different fonts and contrast.

Letter height for 50 % seeing showed that the difference between normal eyes and eyes with goggles decreased for higher illuminance. Figure 4-27 shows the difference for illuminance. Positive contrast shown by solid lines exhibited more difference than negative contrast shown by dotted lines in TF Srivichai and TF Pimpakarn font. But ABC Pathom font gave no difference except at 20 lx. The difference is large at 20 lx showing that the visual performance with goggles became very poor at low illuminance. It improves for higher illuminance and the difference becomes very small. Although we did not investigate for a further illuminance it looks like the letter height from the eyes with goggles becomes even same with the letter height of normal eyes. Would this mean that if we illuminate a room very high elderly people have no problem to identify labels of products at supermarkets? In relation to this we need to point out that we used a high contrast for letter charts. Therefore, we can't draw a general conclusion about the visual performance of elderly people until we investigate letter charts of low contrast.

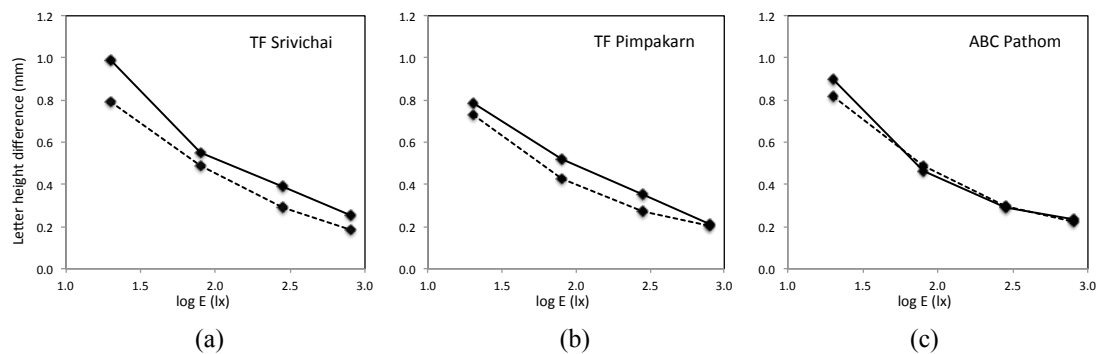

Figure 4-27 Letter height difference between normal eyes and eyes with goggles. Solid lines, positive contrast; dotted lines, negative contrast. (a) TF Srivichai font; (b) TF Pimpakarn font; (c) ABC Pathom font.

We plotted our results in the visual acuity in Figure 4-25. In Chapter 3 we introduced results of visual acuity obtained by Shlaer[21]. We read out his data and converted their log Td to our log E for the abscissa, and plotted them on Figure 4-25, which is shown in Figure 4-28. Shlaer measured the visual acuity for two symbols, Landol C and grating pattern, which are shown by a solid line and a dashed line, respectively. Shlaer's visual acuity is much higher than ours, particularly his Landolt's letter. He used an optical setup to deliver the stimulus, which normally gives a higher visual acuity. More relevant data can be found in Zhang et al. research[18], who used a monitor to present a stimulus. They were particularly

interested to investigate the effect of symbols for the visual acuity, including Landolt C, Snellen letter, and Chinese letters of different complexity. Their results are also inserted in Figure 4-28 by different symbols for different letters, + for Landolt C, × and * for Chinese letters, the former letters being simpler than the latter letters. By the visual inspection we judge the complexity of our Thai letters comes between these two Chinese letters. Their results show that the visual acuity obtained by Landolt C is better than the Chinese letters but their Chinese letters show lower acuity than ours, implying that the visual acuity differs depending on the measuring conditions.

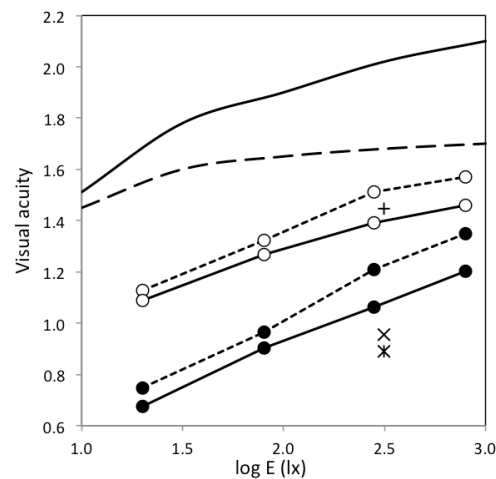

Figure 4-28 Visual acuity for illuminance.

Thai words compose of consonants, vowels and tonal marks as a compounded word. There are 44 consonants for which are quite symbolic and similar to the language structure of Roman letters. The definition of the visual acuity for Thai letters could be the same as the visual acuity definition of the International Standard. Compared to the 20 selected Thai letters of the three fonts for the test chart in Figure 4-8 to the full set of 44 consonants in Figure 4-29, the letters for the test chart were well represented the rest of letters in each font. The 44 letters of different fonts may look different by their design, but they are all readable.

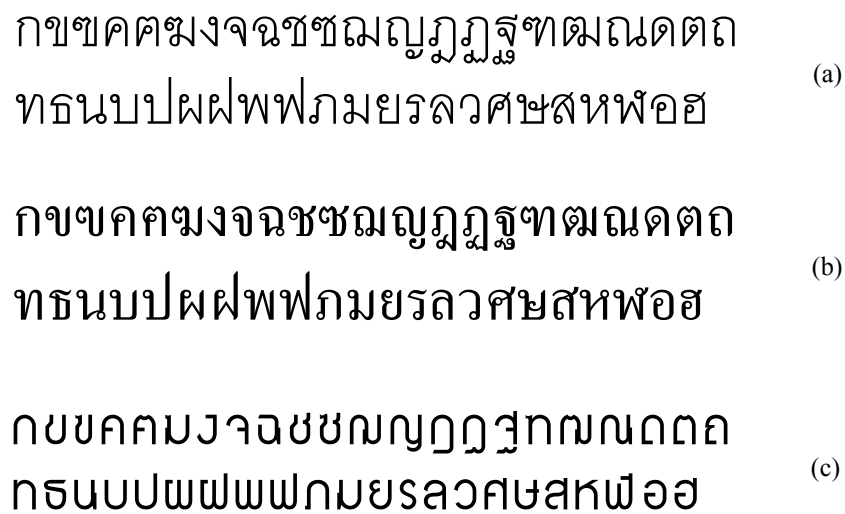

Figure 4-29 Forty four consonants of Thai letter arranged by order. (a) TF Srivichai font; (b) TF Pimpakarn font; (c) ABC Pathom font.

Each Thai letter has its cue for identifying itself from other letters. Thai letters initiated from hand written of the stroke line to draw a letter shape. Most of the Thai letters composed of the circular initial before drawing the stroke line. The circular initial are drawn in the clockwise or counter clockwise direction as exhibited in Figure 4-30. The rounded head of many letters shown in Figure 4-30c also have influence on the legibility of Thai letters. The letters selected for the test chart of this research included these letters but without the letters that have extended head or tail. The visual acuity result from the one-room experiment represented the visual acuity for Thai letters specifically.

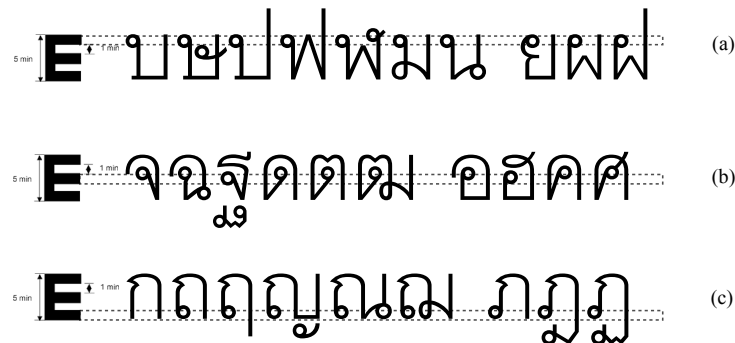

Figure 4-30 The similarity of Thai letters on the circular initial of the letter stroke. Circular initial direction in clockwise and counterclockwise, separated by space. (a) initial circular at top of letter; (b) initial circular at middle of letter; (c) circular initial at bottom of letter and same shape for top of letters. Font: TF Srivichai.

The cues of letters are approximately 1/5 of the letter height as shown in Figure 4-23. This makes the visual acuity of Thai letters comparable to visual acuity acquired from standard optotype such as Randolt C or Snellen E. However, there are also some Thai letters that are unique and quite easy to identify such as the letters with extended head or tail as shown in Figure 4-31. But those letters tend to be easier to identify compared to the similar letters we included in the letter chart. The visual acuity of Thai letters from our result at least guarantee the minimum required acuity to recognize the Thai letters in general.

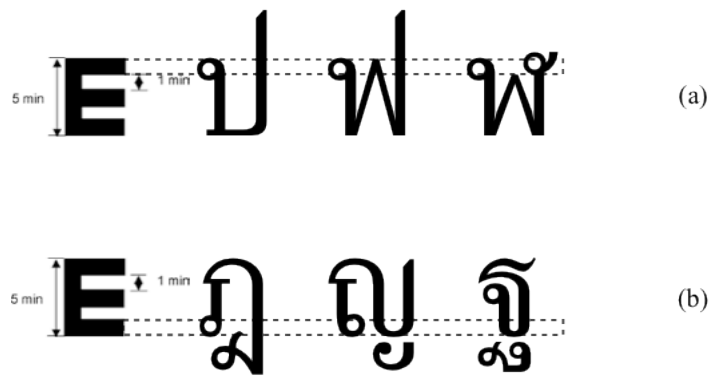

Figure 4-31 The more obvious cues for identifying Thai letters. (a) extended head or upper tail; (b) extended bottom or lower tail. Font: TF Pimpakarn.

CHAPTER V

TWO-ROOM EXPERIMENT

5.1 Introduction

Result from the one-room experiment showed that at low illuminance the eyes with goggles needed much bigger letter height than the normal eyes. That means legibility of the eyes with goggles at low illuminance was very poor. Eyes with goggles represent the eyes with cataract that is the usual symptom for elderly. We concluded in Chapter 4 that the main cause for visual deterioration should come from the scatter of the foggy filters in the eyes. We can then hope that the legibility can be improved if we can reduce the scattering light when the eyes with goggles look at the letter charts.

Ikeda et al. developed the technique called the two-room experiment in which light in each room was independently controlled while subject and the test chart are in separate room[13,14,23]. If the illuminance in the subject room is kept low and the illuminance in test room remains normal, the subject can see stimulus clearly because the scattering light into the subject is reduced while he/she can still see the stimulus placed in the test room with a normal illumination.

Some previous researches[13,14,23] showed that the color saturation was preserved even with the eyes with the cataract experiencing goggles as good as normal eyes by employing the two-room technique. In this chapter we investigate if the legibility can be improved by the two-room technique.

5.2 Apparatus

The cataract experiencing goggles used in the previous experiment are used in this experiment also.

Experimental room was modified from the one-room experimental room. The test room with the dimension of 100 cm wide, 60 cm deep, and 210 cm high was added next to the one-room experimental room as shown in the Figure 5-1. The test room and subject room were connected with a window at the height of 125 cm from the ground at the subject eye level. The lamp TL in the test room was a fluorescent lamp of 18 watts with a light controller for the fine tuning of illuminance. It was installed above the window in the horizontal direction. The chart holder was placed vertically in the test room at the distance 30 cm from the window. The window was 1.2 cm high by 12.2 cm wide in a black facet of the size 28 cm high by 26 cm wide so

that subjects could see only one line of letter chart at a time.

A subject sat at the same place as the previous experiment and looked at the chart C in the test room through the window. The experimenter sat beside the test room to control the test chart and to record the response of subject.

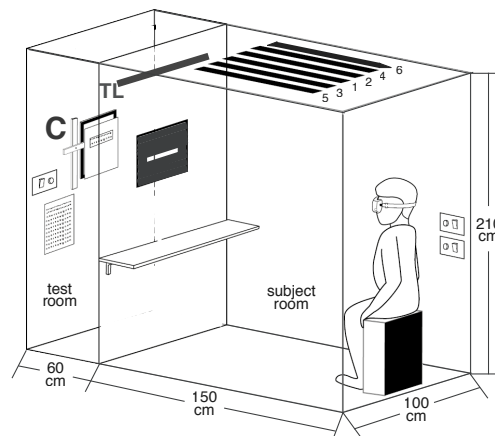

Figure 5-1 Two-room experimental room.

Letter charts for this experiment were the same as the previous experiment. Since the result from the one-room experiment showed that the three fonts gave high similarity, we then employ only one font for this experiment. The TF Srivichai font is generally more popular and more widely used for text. So we choose TF Srivichai font in negative and positive contrast for the two-room experiment.

5.3 Experimental condition

We employed seven illuminance levels 0, 5, 20, 80, 280, 800, and 1500 lx for the subject room. We added here three levels 0, 5, and 1500 lx to four levels of the previous experiment. The two lower illuminances could show the influence of dark environment light to the letter legibility in the normal light. The higher illuminance could show the effect of scattering from environment light.

The illuminance of the test room was set at 280 lx constant which is one of the illuminance level employed for the subject room in the previous experiment. We want to simulate the test room as the normal lighting in general places public or household. From our observation, 280-300 lx gave good legibility and it agreed with the standard lighting recommended of approximately 300 lx for the public. The 280 lx was selected for the test room experiment so that it would be convenient for the data calculation and analysis. The polarity contrast of positive and negative were employed.

Experimental conditions are summarized in Table 5-1.

Table 5-1 Experimental conditions of two-room experiment.

Experiment	Conditions
Subject room illuminance (lx)	0, 5, 20, 80, 280, 800, 1500
Test room illuminance (lx)	280
Font type	TF Srivichai
Polarity contrast	Negative, Positive
Goggles	Off, On
Viewing distance (cm)	150

5.4 Procedure

Five subjects, ET, PP, PS, PW and SN were students of Department of Imaging and Printing Technology, Faculty of Science, Chulalongkorn University. The first four subjects participated in the one-room experiment but the last one was new at this experiment. The four subjects were not asked to repeat orientation but the new subject proceeded an orientation process to assure that she was qualified and understood the task of this experiment. The orientation for subjects was the same as for the one-room experiment.

The same datasheets were used for recording as for the one-room experiment.

Experimental procedure was similar to the one-room experiment. The test room illuminance was set constant at 280 lx. The illuminance of the subject room was controlled by experimenter from outside of the subject room. The vertical plane illuminance for 0, 5, 20, 80, 280, 800, or 1500 lx measured by illuminometer at the window area of the subject room were transferred to the illuminance of 0, 5.3, 22.5, 87, 232, 315, and 920 lx measured horizontally on the front shelf under the window. To start a session of experiment, an illumination level among 0, 5, 20, 80, 280, 800, or 1500 lx was set to the vertical plane illuminance of the subject room.

A letter chart of TF Srivichai font in negative contrast in the chart holder and prepared the corresponding datasheet. A subject looked at the line of letters shown through the facet window and read out one by one from the left to the right. The experimenter recorded the correct response and judged for the next movement of chart as the same procedure of one-room experiment to cover the sizes that provide 50% correct response. Experimenter managed the experiment and recorded the response in the datasheet by the same procedure as one-room experiment. After normal eyes

followed by eyes with goggles, and then moved to next illuminance. The one session completed when seven illuminance levels of subject room were done. Each session of experiment took about 1.5 – 2 hours. Each subject was required to conduct 5 trials of experiment. If experiment shall be paused or stopped, experimenter tried to stop at the completion of each chart.

5.5 Results

Results of subjects PW and PP are given for letter height in Figure 5-2. The abscissa gives illuminance lx in the subject room in logarithmic unit and the ordinate letter height in mm. Open circles are for normal eyes and filled circles for eyes with goggles. Short vertical bars indicate standard deviation after five sessions. The intra-subject variance data of the two-room experiment is available in Appendix. The lowest illuminance that we employed was 0 lx, and the position was shown at the extreme left on the abscissa with minus infinity.

The standard deviations are much larger with the eyes with goggles than the normal eyes indicating the more difficulty for reading letters by the eyes with goggles.

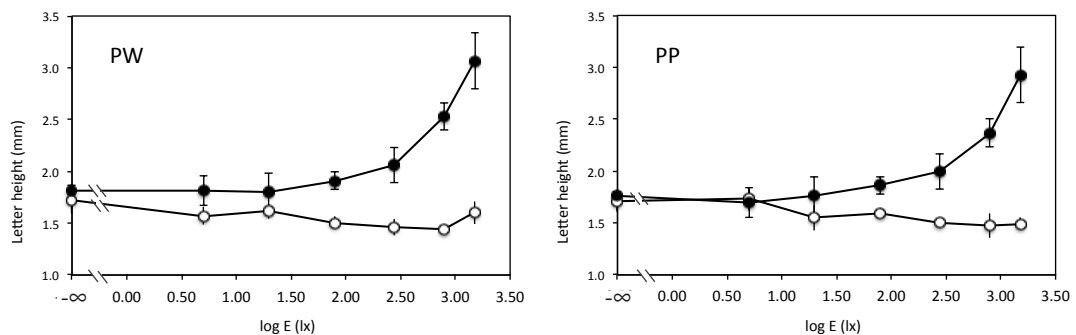

Figure 5-2 Averaged result from 5 sessions of two-room experiment plotted in letter height from 2 subjects PW and PP. ○, normal eyes; ●, eyes with goggles.

Curves from five subjects were in the same tendency and we took the average, which is shown in Figure 5-3 for positive and negative contrast. Standard deviation is shown at each data point. The inter-subject variance data of the two-room experiment is available in Appendix. The letter height for normal eyes remained almost same throughout illuminance level but the letter height for eyes with goggles remain about the same until 280 lx when both room has the same illuminance. After that the letter height rapidly increased showing the effect of scattered light in the eyes caused by the foggy filters of the goggles.

Appearance of the visual field was not same at different room illuminances. From 0 lx to 80 lx the chart seen through the window was very clear as it was illuminated by the brighter light in the test room. At 280 lx that test room and subject room illuminance were equated, subjects felt comfortable and could see the letter chart clearly with normal eyes but a little worse by eyes with goggles. At 800 and 1500 lx where the room was very bright, subjects' vision under eyes with goggles became very foggy and the contrast of letters looked deteriorated. The foggy appearance did not appear to the normal eyes.

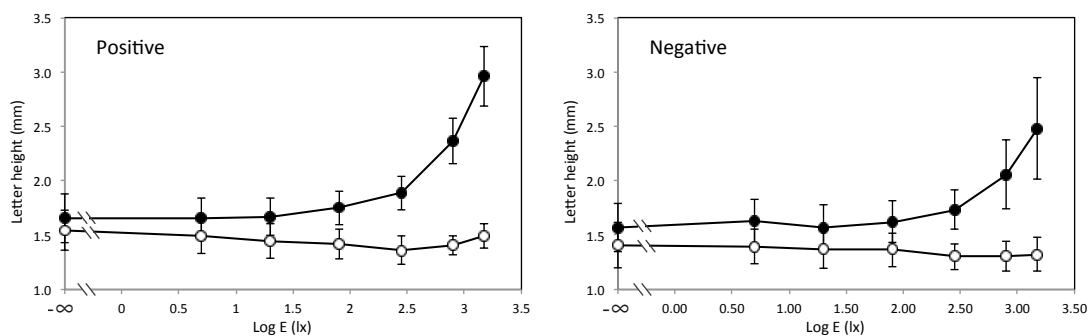

Figure 5-3 Averaged result of 5 subjects in positive and negative contrast.

○, normal eyes; ●, eyes with goggles.

Results of positive and negative contrast are compared by plotting them together as shown in Figure 5-4. Positive results are shown by solid lines and negative results by dotted lines. In both eyes, normal eyes and eyes with goggles, letter height of positive contrast always larger than negative contrast. The letter height for the eyes with goggles increased rapidly when the illuminance of subject room was higher than the test room illuminance indicated by a short vertical bar on the abscissa. In the normal eyes, letter heights of positive contrast gradually decreased when illuminance increased from 0 to 280 lx and gradually increased with the further increasing illuminance from 800 to 1500 lx. Similar tendency also occurred with the negative contrast but with smaller letter height difference among each illuminance.

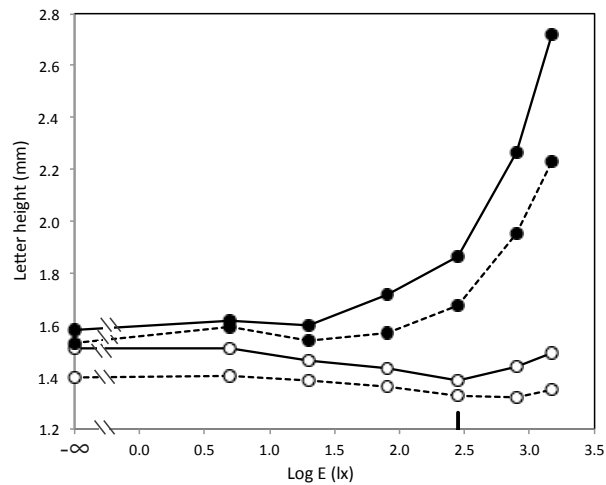

Figure 5-4 Letter height versus illuminance curves of positive contrast and negative contrast shown by solid line and dotted line respectively. ○, normal eyes; ●, eyes with goggles.

Standard deviations given in Figure 5-3 were plotted in Figure 5-5 with solid lines for positive contrast and dotted lines for negative contrast. In both eyes, normal eyes and eyes with goggles, standard deviation decreased gradually from 0 lx to 280 lx and increased rapidly for higher illuminance with eyes with goggles. But the standard deviation with the normal eyes stayed more or less constant or increased slightly if any for the higher illuminance.

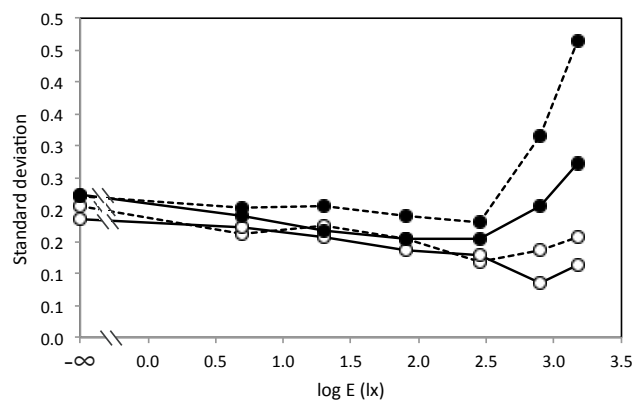

Figure 5-5 Standard deviation of the positive contrast, solid lines, and negative contrast, dotted line. ○, normal eyes; ●, eyes with goggles.

Results of the present two-room experiment were compared to results of the one-room experiment in Figure 5-6 for letter height. They are shown solid lines and by dotted lines respectively. For eyes with goggles, the letter height of two-room

increased with increasing subject room illuminance while it decreased in the case of one-room in both positive and negative contrast. For the normal eyes the letter height maintained almost constant for the increased illuminance in the two-room but gradually decreased for the one-room. Letter height with normal eyes of one-room and two-room intersected at about 80 lx and with the eyes with goggles at about 160 lx for both positive and negative contrast.

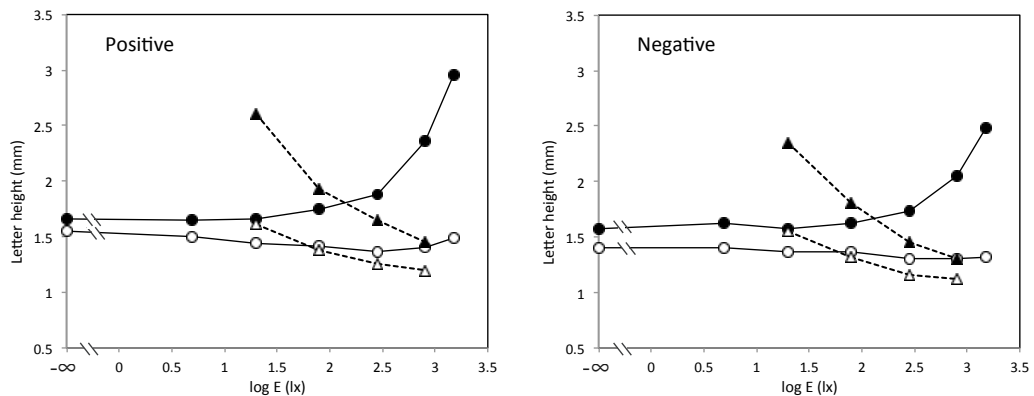

Figure 5-6 Comparison of letter height of the one-room and two-room in positive and negative contrast. ○, normal eyes in two-room; ●, eyes with goggles in two-room; △, normal eyes in one-room; ▲, eyes with goggles in one-room. Solid line, two-room; dotted line, one-room.

Figure 5-7 shows the results of Figure 5-6 in terms of visual angle for the ordinate so that we can directly compare the results of two experiments. At 280 lx where illuminance of subject room and test room were the same as the one-room experiment, we think that visual angle should be the same. However, the result showed that visual angle from the two-room experiment was smaller than the one-room in both positive and negative contrast. The precise comparison will be given in the next figure in visual acuity.

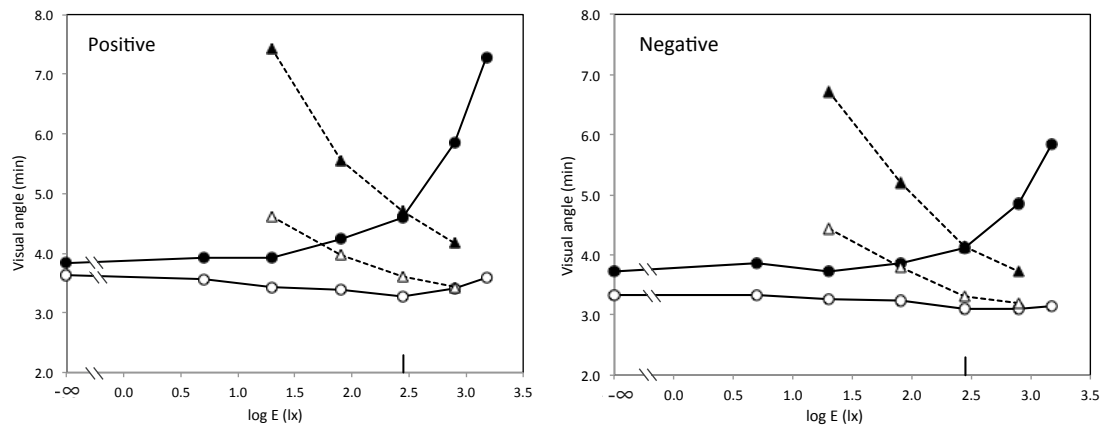

Figure 5-7 Comparison of visual angle of the one-room and two-room in positive and negative contrast. \circ , normal eyes in two-room; \bullet , eyes with goggles in two-room; \triangle , normal eyes in one-room; \blacktriangle , eyes with goggles in one-room. Solid line, two-room; dotted line, one-room.

Visual angles from Figure 5-7 were calculated into visual acuity and plotted for the ordinate as shown in Figure 5-8. For eyes with goggles, visual acuity maintained from 0 to 280 lx and decreased rapidly from 800 to 1500 lx in the two-room while it increased monotonically with the increased illuminance in the one-room. At 280 lx where illuminance of subject room and test room were the same as the one-room experiment, visual acuity of the two-room experiment was higher than the one-room in both positive and negative contrast. Visual acuity advantage of the two-room over the one-room at 280 lx was about 0.2 for eyes with goggles and 0.5 for normal eyes in positive contrast. The difference was also more or less the same in negative contrast. For normal eyes, visual acuity of the two-room was higher than the one-room in both positive and negative contrast.

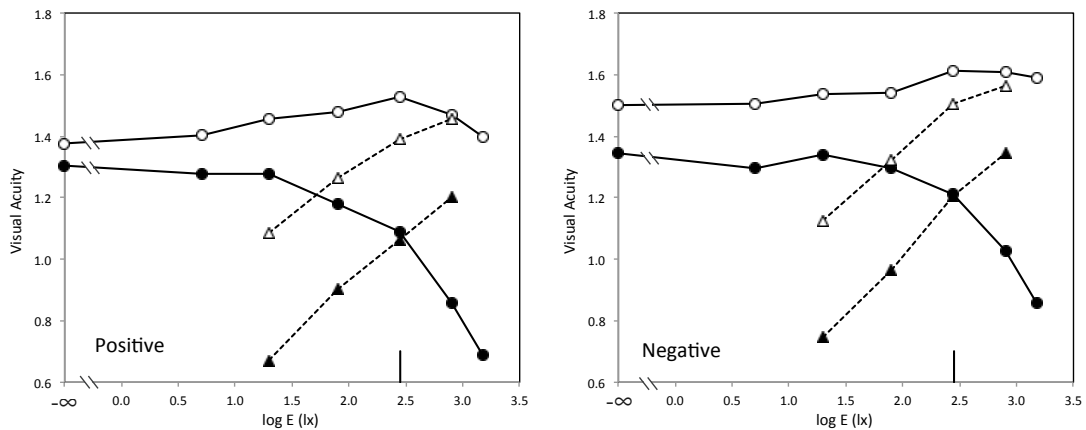

Figure 5-8 Comparison of visual acuity of the one-room and two-room in positive and negative contrast. ○, normal eyes in two-room; ●, eyes with goggles in two-room; △, normal eyes in one-room; ▲, eyes with goggles in one-room. Solid line, two-room; dotted line, one-room.

5.6 Discussion on two-room experiment

The two-room technique showed superiority over the one-room in terms of visual acuity improvement. At the same illuminance of 280 lx, visual acuity of normal eyes and eyes with goggles of the two-room were all better than the one-room. Both contrast showed the same agreement. However, keep in mind that we illuminated the letter chart at 280 lx in the two-room experiment, we should expect that result from the two-room should not worse than visual acuity of the same illuminance in the one-room. We achieved that for normal eyes in all illuminance and eyes with goggles in illuminance up to 280 lx. The higher subject room illuminance proved that high environmental illuminance affect legibility for the eyes with goggles that we have to avoid. The two-room technique was to improve the legibility by decreasing the excessive environment light that affect the visibility of the cataract eyes.

Concerning the equal illuminance of subject room and test room as the neutral illuminance as shown by the short vertical bar on the abscissa in Figure5-4, the lower or higher subject room illuminance should be considered the less balanced illuminance. In the case of normal eyes, letter height increased with the decreasing and increasing of illuminance form 280 lx. Positive contrast exhibited larger letter height than negative contrast in all equivalent positions. Does positive contrast really has more effect than negative? Refer to the visual perception in the experimental observation, we noticed the visual appearance differences between both contrasts. While charts were always illuminated at 280 lx, the darker subject room will be more

influenced by the ratio of light at the letter chart and light in the subject room. The higher the ratio, the more discomfort subject experienced for reading the chart. The simultaneous brightness contrast phenomenon becomes more significant when it comes to positive contrast chart. The white letter strokes on the black background in the positive contrast chart looked darkened in the higher degree than black strokes of the white background in negative contrast chart. So the letter height of positive contrast became larger than negative contrast in all illuminance, and exhibited larger difference for increasing and decreasing illuminance from the neutral point.

In the case of eyes with goggles, the smallest letter height was not at 280 lx as it was in the case of normal eyes. It started to gradually increase from 20 to 280 lx and rapidly increase from 280 to 1500 lx. Why it is not lowest at 280 lx? The scattering effect of the goggles together with enriched environment brightness in the subject room are the causes for the deteriorated vision for the eyes with goggles. The subject room illuminance was measured at the vertical plane of the window area, but the wall of subject room was rather white and cause environment brightness to be higher compared to the actual illuminance of the chart illuminance in the test room. How much illuminance difference to compensate for the enriched brightness in the subject room? The illuminance for smallest letter height was about 80 lx for positive and negative contrast. So between 80 to 280 lx in the subject room could be compromising point for normal eyes and eyes with goggles.

The illuminance of the test room was kept constant at 280 lx while the illuminance of the subject was varied from 0 lx through 1,500 lx. Both vertical plane illuminance were measured at the equivalent positions, on the letter charts in the test room and on facet of the subject room. When the illuminance of the subject room was 280 lx the illumination situation must be the same as the one room experiment at that illuminance. In Figure 5-7 the illuminance is shown by a short vertical bar on the abscissa. The curve obtained with the normal eyes in the two-room experiment gradually increased to larger visual angle for lowered illuminance as shown by open circles. Subjects needed larger visual angle to read letters when the illuminance of the subject room was decreased. This was certainly caused by the scattering light as in the case of the goggles and something else should caused the deterioration than the scattering light. Subjects noticed the inside of the facet appeared darker and darker for lower illuminance. The simultaneous brightness contrast phenomenon took place and the letter strokes in the facet became darker. This darkened letter strokes are considered to cause the deterioration.

The same deterioration must take place for the eyes with goggles of which is

shown by filled circles. But such increase of the visual angle did not appear in the curve with filled circles. It only gradually decreased or stayed constant. This implies that the effect to reduce the scattering light to improve the reading ability with the goggles should be larger than that shown by the decrease of the curve with filled circles for lower illuminance.

CHAPTER VI

SUPPLEMENTAL EXPERIMENTS

6.1 Introduction

The result from one-room experiment given in Chapter 4 showed the high legibility of eyes with goggles when the room illuminance was made high. Letters of the almost same height as the normal eyes could be read out by eyes with goggles when the room illuminance was 800 lx. This would mean that elderly people can read letters same as young people when the environment was illuminated high and there is no need to specifically prepare infrastructure for elderly people. It must be pointed out, however, that in the experiment the letter charts were printed in high contrast of almost 100% whether positive or negative. The high contrast chart might have helped the legibility with goggles. But in real life many product labels were printed at low contrast as Figure 6-1 shows some examples and the low contrast might present elderly people difficulty to read the letters. We thought it necessary to find out the effect of letter contrast for legibility. The present supplemental experiment investigates the effect of letter contrast by repeating one room and two room experiments but with letters with lower contrast.



Figure 6-1 Sample of product labels in different contrasts. (a) Thai herbal medicine; (b) ready mixed dried food; (c) ginger powder for instant drink

We experience in the one-room and two-room experiment that subjects had to spend quite a long time to carry out the observation. That was mainly caused by the method to determine line number for 50% readability. It was the constant stimuli method. We will employ here the method of adjustment to speed up the experiment.

The previous results showed a high correlation between positive and negative polarity contrast. Tendency of curves in the same contrast among fonts were also similar. In this experiment we employed only negative contrast charts and only TF Srivichai font.

6.2 Apparatus

The same cataract experiencing goggles used in one-room and two-room experiment were used in this supplemental one-room and supplemental two-room experiment. The same experimental room as for the previous experiments was used. The viewing distances were 120 cm and 150 cm at the supplemental one-room and the supplemental two-room experiment, respectively.

Letters were printed black and the charts were made in 3 different backgrounds, white, Munsell Value N5 and N4. The white background was the paper surface itself. The N5 background was the printed background equivalent to N5 or L^* of about 50. It was achieved by printing the 78% dot from Canon iP4800 inkjet printing onto the 260 gsm gloss-coated inkjet paper board. The N4 background is the background of lightness about 40 and was made the same way as N5 but with 89% dot assigned to the background. White background chart was also printed by the same printing and paper. The letter strokes were solid image and were printed with black ink

The letter charts were composed of 24 lines of letters, with the letter height difference comparable to the equal interval of 0.05α among each consecutive line. Here α represents Minimum Angle of Resolution (MAR). The letter height increment for each line was in the same manner as shown in Table 4-1, but with bigger letter size up to line number 24 as shown in Figure 6-2. The letter heights from line 1 to line 16 were the same as the previous experiments, but letter height for line 17 to line 24 were increased in the same manner as used up to the line 16. The line numbers were placed to the right side of each line and a subject could read the number shown in a small number window.

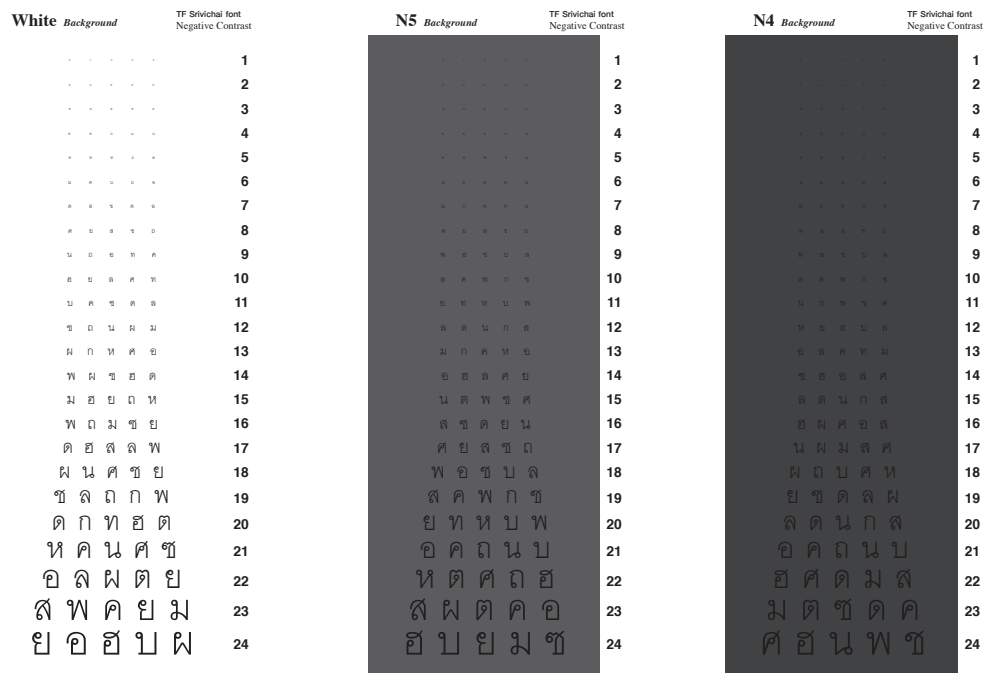

Figure 6-2 Letter charts of the background, White, N5, and N4 from the left respectively.

A different method of obtaining letter height was employed to speed up the measurement time. Each letter chart was pasted on a plate of ply wood of the size 18 cm wide by 55 cm high and the plate was fit to the chart holder to allow the vertical movement by a string controlled by a subject as illustrated in Figure 6-3. The subject could see only one line of the letter chart as before through the letter window LW of the size 28 cm wide and 1.4 cm high. Another small number window NW was opened at the right hand side of the letters line so that the subject could see the line number. The chart plate was fit in a socket of the window that allowed vertical sliding of chart. Line number was clearly and exactly shown in the small number window. Subjects could control the letter chart up and down by pulling or loosening the string at his/her will.

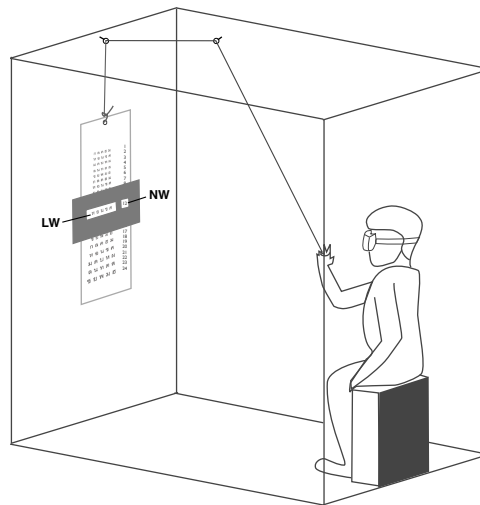

Figure 6-3 Illustration of chart adjustment.

6.3 Experimental condition

One more illuminance of 1500 lx was added in the supplemental one-room experiment as shown in Table 6-1 compared to the experiment given in Chapter IV. Other conditions are summarized in the table. Experimental conditions for the supplemental two-room experiment are summarized in Table 6-2. Here two more levels of illumination, 0 and 5 lx were added. The same illuminance 280 lx was employed for the test room as for Chapter V.

Table 6-1 Experimental conditions of supplemental one-room experiment.

Experiment	Conditions
Subject room illuminance (lx)	20, 80, 280, 800, 1500
Font type	TF Srivichai
Polarity contrast	Negative, Positive
Goggles	Off, On
Viewing distance (cm)	120
Repeating (sessions)	10

Table 6-2 Experimental conditions of supplemental two-room experiment.

Experiment	Conditions
Subject room illuminance (lx)	0, 5, 20, 80, 280, 800, 1500
Test room illuminance (lx)	280
Font type	TF Srivichai
Polarity contrast	Negative, Positive
Goggles	Off, On
Viewing distance (cm)	150
Repeating (sessions)	5

6.4 Procedure

Four subjects, BW, PC, PS and SS participated in the supplemental experiment in one-room and two-room. They were students of Department of Photographic Science and Printing Technology, Faculty of Science, Chulalongkorn University. The age of subjects were in the range of 25-35 years old except BW for 48 years. The first subject participated in the two-room experiment of the previous experiment but the other three subjects participated here for the first time. The datasheets for recording the response by writing down the line number were prepared.

Experimental procedure was similar to the previous one-room and two-room experiment. Only the subject stayed in the subject room and the experimenter stayed outside the experimental booth to record the response and to control the illuminance. Method of adjustment was employed to determine the line number corresponding to just 100% legibility. A line of letters was shown in the window LW and the corresponding line number was shown in the window NW as shown in Figure 6-3. Subjects controlled the chart up and down by the pulling or releasing the string that connected to the chart.

The subject estimated by himself the line number that gave just 100% legibility. If the subject could read all five letters, say, for line number 15 but could read 3 to 4 letters for the previous line number 14 he/she estimated half line number smaller and answered line number 14.5.

The supplemental one-room and supplemental two-room experiment were conducted separately. At each illuminance, subject started with normal eyes first and then by eyes with goggles. After one chart of a background level was experimented for all illuminances, the next chart was brought in and the experiment with the same procedure followed. After the three charts of different background levels were

experimented, one session for the one-room was fulfilled. It took about 20-30 minutes to finish one session of supplemental one-room experiment and 30-40 minutes to finish one session of supplemental two-room experiment, compared to about 90-180 minutes in the previous experiments. Each subject was required to conduct 10 sessions of experiment for supplemental one-room experiment and 5 sessions for supplemental two-room experiment. The number of sessions in supplemental two-room experiment reduced to 5 mainly to save time after the result of supplemental one-room experiment showed no significant variance for 5 or 10 sessions of experiment. If experiment was paused or stopped, experimenter tried to stop at the completion of a session instead of the completion of a chart.

6.5 Results

6.5.1 Result for supplemental one-room experiment

It was not difficult with normal eyes to estimate the just 100 % legible line. The subject looked and assumed that he can read all 5 letters of the line to give the answer for the exact line number. But if he could not see all 5 letters but only most of them, and the adjacent smaller line number was somewhat too small to read, then gave answer to the line number that was half line smaller. The normal eyes could easily estimate that procedure. However, the eyes with goggles had difficulty to exactly estimate since the sharpness of letters reduced from lower contrast. The latitude of readable line number was quite large. The factors were not only to the legibility due to sharpness, but also the reduced contrast and fogginess. Letters looked like somewhat readable but with annoying vision. In this case subjects were advised to judge the legibility together with the ease of seeing to give the answer for the 100% legibility.

The line number corresponding to the 100% correct response was recorded. Then the line numbers were converted to letter height by using Eq. 4.2. Letter height versus log illuminance of three backgrounds were plotted respectively. Results of subjects PS and SS are given in Figure 6-4. The abscissa gives illuminance (lx) in the subject room in logarithmic unit and the ordinate letter height in mm. Open circles are for normal eyes and filled circles for eyes with goggles. Short vertical bars indicate standard deviation after ten sessions. The standard deviation was small with normal eyes but it was rather large for low contrast letter charts and at low illuminance. The intra-subject variance data of the supplemental one-room experiment is available in Appendix.

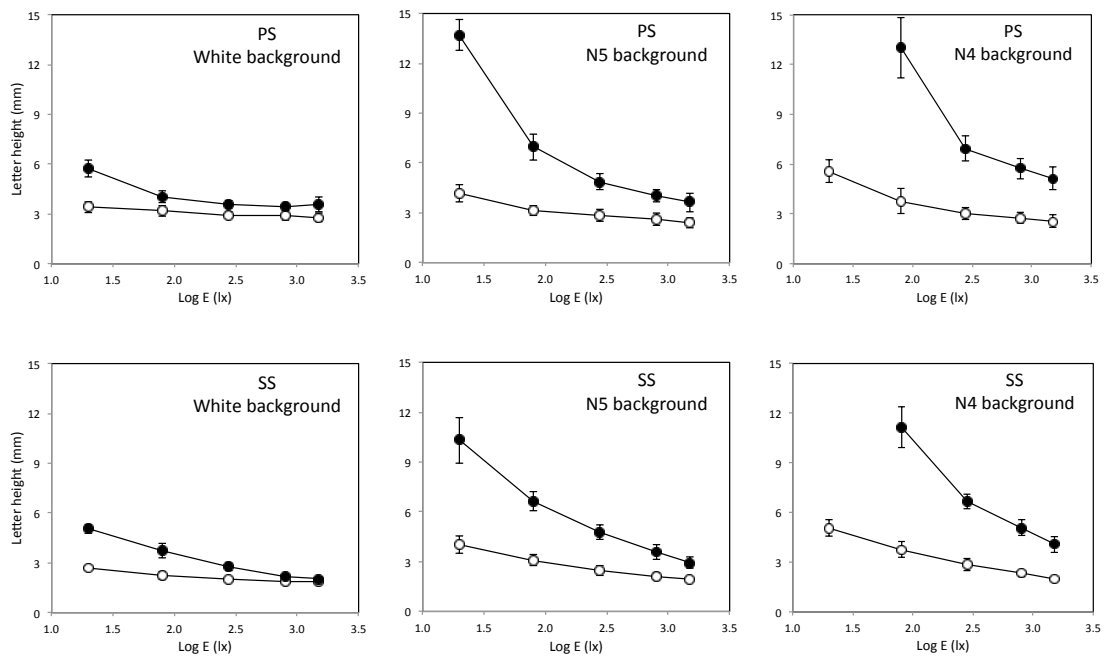

Figure 6-4 Results of subject PS and SS experimented by one-room on three backgrounds of charts shown in letter height versus log illuminance. ○, normal eyes; ●, eyes with goggles.

The chart in white background was the control chart since it was in the same high contrast used in the previous one room experiment. The N5 background chart showed the larger letter height compared to the white background chart, and also exhibited still larger difference between normal eyes and eyes with goggles. The eyes with goggles could not read even the largest letters when the illuminance of the subject room was 20 lx and the data point at under the illuminance was not obtainable.

Curves from four subjects were in the same tendency and we took the average, which is shown in Figure 6-5 for White, N5 and N4 background. Standard deviation of four subjects is shown in each data point. The inter-subject variance data of the supplemental one-room experiment is available in Appendix. The letter height for eyes with goggles were larger than the letter height for normal eyes, and the letter height difference became larger for lower illuminance. The darkest background of N4 employed in the present experiment gave worse performance of eyes with goggles compared to N5 and White background. The data points of N4 background at 20 lx in the abscissa for eyes with goggles were not obtainable from all the four subjects.

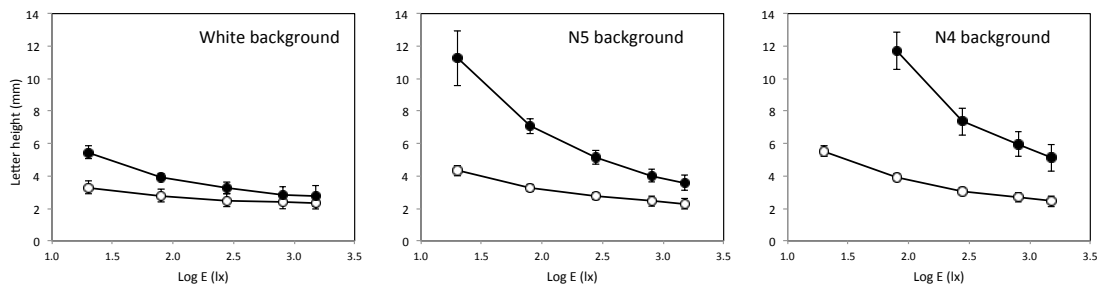

Figure 6-5 Results from three background contrast charts experimented by one-room shown in averaged line number versus log illuminance. ○, normal eyes; ●, eyes with goggles.

Standard deviation given in Figure 6-5 are plotted in Figure 6-6 with solid lines for eyes with goggles and dotted line for normal eyes. The abscissa gives illuminance lx in the subject room in logarithmic unit and the ordinate standard deviation. Circles are for white background, squares for N5 background, and triangles for N4 background. The standard deviation was relatively low in all three backgrounds of normal eyes. But for the eyes with goggles, standard deviation was fluctuated. The standard deviation was large with the N4 background at all illuminance and with the N5 background only at 20 lx illuminance.

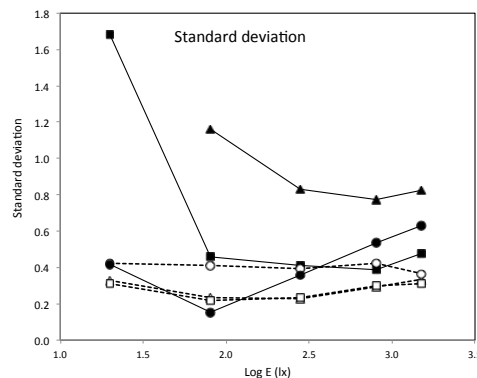

Figure 6-6 Standard deviation of the letter height from averaged result of 4 subjects. Solid lines, eyes with goggles; dotted lines, normal eyes. ● ○, White background; ■ □, N5 background; ▲ △, N4 background.

Results of the same eye condition were plotted together in Fig 6-7 to compare the effect of contrast. Filled circles were from white background, filled squares from N5 background, and filled triangles from N4 background. The results showed small difference among contrast with normal eyes, but large difference with

goggles. Effect of low contrast to make the visual performance worse is quite evident with goggles.

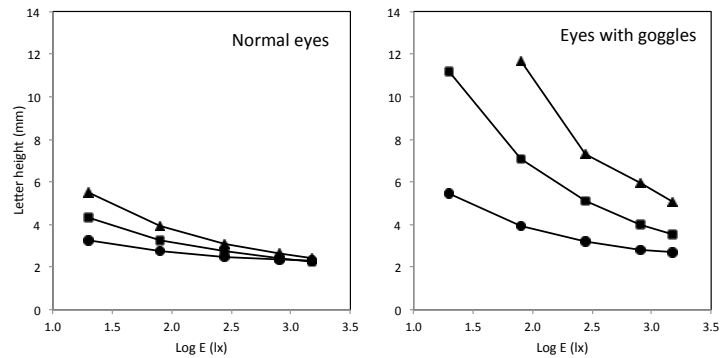

Figure 6-7 Letter height from different contrast under the same eye condition. ●, white background; ■, N5; ▲, N4.

The letter heights of eyes with goggles were much higher than the letter height of the normal eyes. The letter height differences for each background were plotted in Figure 6-8. Darker background gave wider letter height difference. Since the letter height of the normal eyes were relatively low as shown in Figure 6-7, it means that the lower the contrast of letter chart, the worse the eyes with goggles can see clearly.

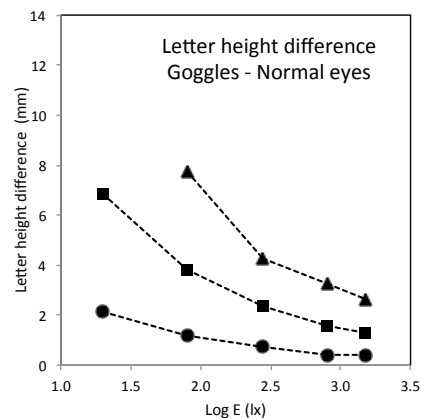

Figure 6-8 Letter height difference between eyes with goggles and normal eyes. ●, white background; ■, N5; ▲, N4.

The visual angles and visual acuity for the supplemental one-room experiment were calculated by Eq. 2 and 3. They will be plotted together with the

result of the supplemental two-room experiment and be shown in the next section.

6.5.2 Result for supplemental two-room experiment

Results of subjects PS and SS are shown in Figure 6-9. The abscissa gives illuminance lx in the subject room in logarithmic unit and the ordinate letter height in mm. Open circles are from normal eyes and filled circles from eyes with goggles. Short vertical bars indicate standard deviation after five sessions. The standard deviation is not shown with goggles at 1,500 lx of the subject room illuminance with N5 and N4 because the subjects could not determine the threshold as they needed still larger letters to read in some sessions. The point in the figure is the averaged value of two or three sessions.

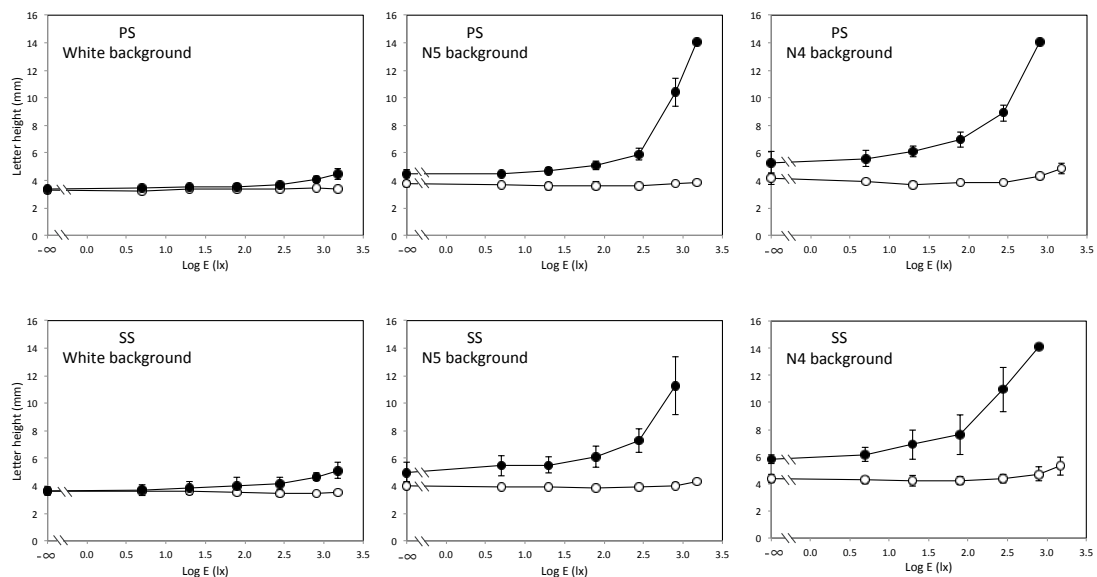

Figure 6-9 Results of two-room experiment for three background contrast charts plotted for letter height of subject PS and SS. ○, normal eyes; ●, eyes with goggles.

The result of white background chart appears same as the two-room experiment of Chapter 5 that was shown in Figure 5.3, except the ordinate value that shifted to the bigger letter height due to the required 100% correct response instead of 50% correct response of the previous experiment. The letter height here was 3.2 mm for 100% correct response instead of 1.4 mm for 50% correct response in Figure 5-3.

Curves from four subjects were in the same tendency and we took the average, which is shown in Figure 6-10 for white, N5 and N4 background. Standard deviation of four subjects is shown in each data point by short vertical bar. The letter

height for eyes with goggles was larger than the letter height for normal eyes, and the letter height difference became larger for higher illuminance. The background of N4 gave worse deterioration of eyes with goggles compared to N5 and white background. The data points at 800 and 1500 lx of N4 background and at 1500 lx of N5 background for eyes with goggles were out of range and could not be obtained.

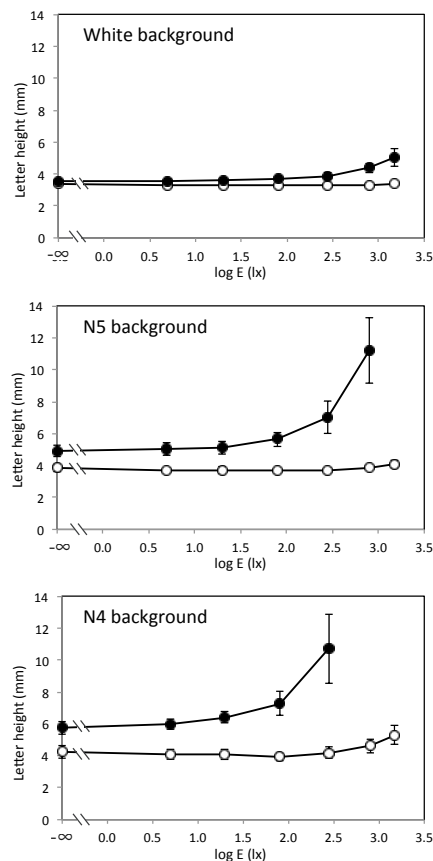

Figure 6-10 Averaged result from 4 subjects showing letter height of normal eyes and eyes with goggles plotted for different backgrounds. ○, normal eyes; ●, eyes with goggles.

The standard deviations given in Figure 6-10 were re-plotted in Figure 6-11 with solid lines for eyes with goggles and dotted line for normal eyes. With the eyes with goggles and for the background N4 and N5 the standard deviation rapidly increased for higher room illuminance beyond 280 lx.

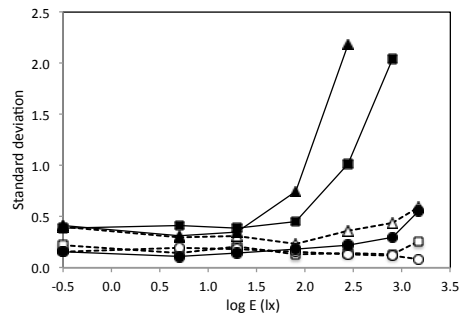

Figure 6-11 Standard deviation of averaged letter height from 4 subjects in different backgrounds. Solid lines, eyes with goggles; dotted lines, normal eyes. ● ○, White background; ■ □, N5 background; ▲ △, N4 background.

Results of the same eye condition were plotted together in Fig 6-12 to see the effect of contrast. The curves are more or less same except slight vertical difference with normal eyes, while the curves with eyes with goggles are significantly separated with each other.

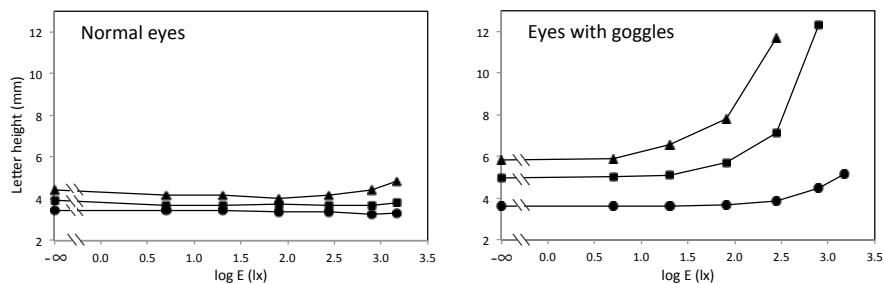

Figure 6-12 Letter height from different contrast with normal eyes and eyes with goggles, respectively. ●, white background; ■, N5 background; ▲, N4 background.

The letter heights of eyes with goggles were higher than the letter height of the normal eyes, and the shapes of curves were different. The letter height differences between eyes with goggles and normal eyes for each background were plotted with the value of difference in the ordinate as shown in Figure 6-13. The darker the background, the higher difference between eyes with goggles and normal eyes. Since the letter height of the normal eyes were relatively low as shown in Figure 6-12, it means that the lower the contrast of letter chart was, the worse the eyes with goggles.

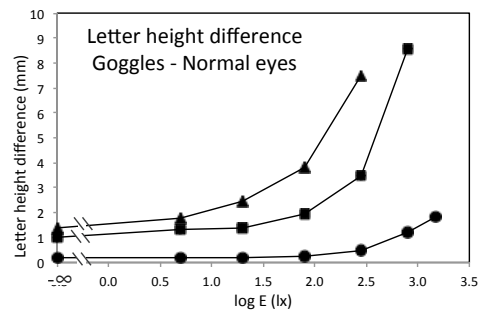

Figure 6-13 Letter height difference between eyes with goggles and normal eyes. ●, White background; ■, N5 background; ▲, N4 background

6.5.3 Integrated result for supplemental one-room and two-room experiment

Letter height of different backgrounds from supplemental one-room experiment in Figure 6-5 and supplemental two-room experiment in Figure 6-10 were integrated in the same graph and showed in Figure 6-14 for different background. The solid lines were letter height from supplemental two-room experiment and dotted lines supplemental one-room experiment. A short vertical bar on the abscissa indicates 280 lx under which both subject room and test room were equated in the vertical plane illuminance on the letter charts. At the same 280 lx of the subject room illuminance, letter height of the supplemental one-room was smaller than the supplemental two-room because of the closer viewing distance of 120 cm instead of 150 cm.

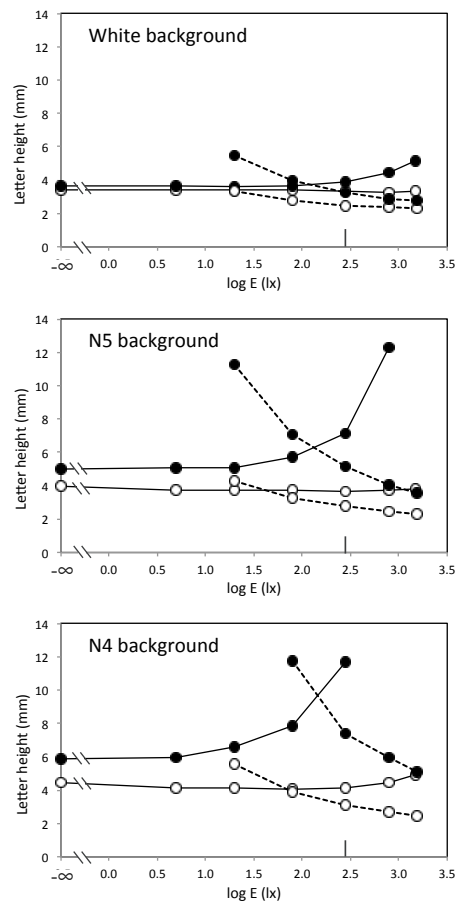

Figure 6-14 Letter height comparison between supplemental two-room experiment (solid lines) and supplemental one-room experiment (dotted lines) for different backgrounds. ○, normal eyes; ●, eyes with goggles.

The visual angle was calculated from the letter height LH and viewing distance D by Equation (2). The visual angles of 100% seeing for different background charts experimented by different viewing distance in the supplemental one-room and two-room experiment were integrated in the same graphs for direct comparison as shown in Figure 6-15 for different contrast. A short vertical bar on the abscissa indicates 280 lx under which both subject room and test room were equated in the vertical plane illuminance on the letter charts in the case of the present supplemental two-room experiment. The result here showed similar visual angles of one-room and two-room, which is different from the previous results that showed smaller visual angles from two-room compared to one-room experiment. From this point to the lower illuminance of the subject room the letter height decreased quite much particularly in the case of N4, or the lowest contrast in the present experiment.

This shows the two-room technique is very effective to improve the visual performance of the eyes with goggles. Such improvement was not clear in the previous experiment shown in Chapter 5 where a high contrast of the letters was employed.

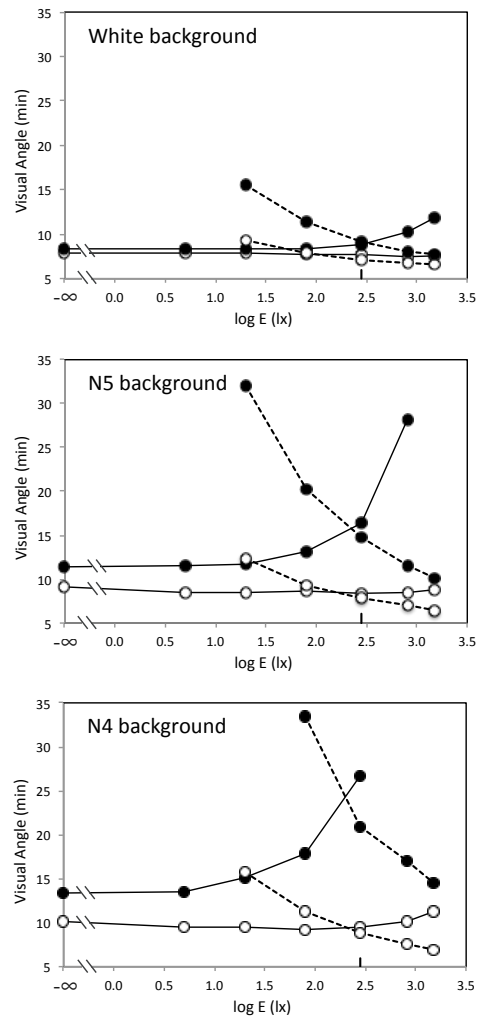

Figure 6-15 Visual angles from one-room and two-room experiment shown for three charts of different backgrounds. Solid lines, supplemental two-room; dotted line, supplemental one-room. \circ , normal eyes; \bullet , eyes with goggles.

The letter height was transferred to the visual acuity and plotted in Fig 6-16. For the eyes with goggles, visual acuity maintained with the higher contrast or brighter background of charts. In the same background of chart, the visual acuity maintained from 0 lx to a certain illuminance before decreased rapidly toward the higher illuminance. The darker background showed the higher degree of deterioration

in terms of visual acuity dropping toward lower subject room illuminance. Visual acuity still increased monotonically with the increased illuminance in the supplemental one-room experiment, but with much higher deterioration between normal eyes and eyes with goggles when chart background became darker from white to N5 and N4. Concerning the normal eyes changed minimally, the deterioration was happen to mostly caused by the goggles effect.

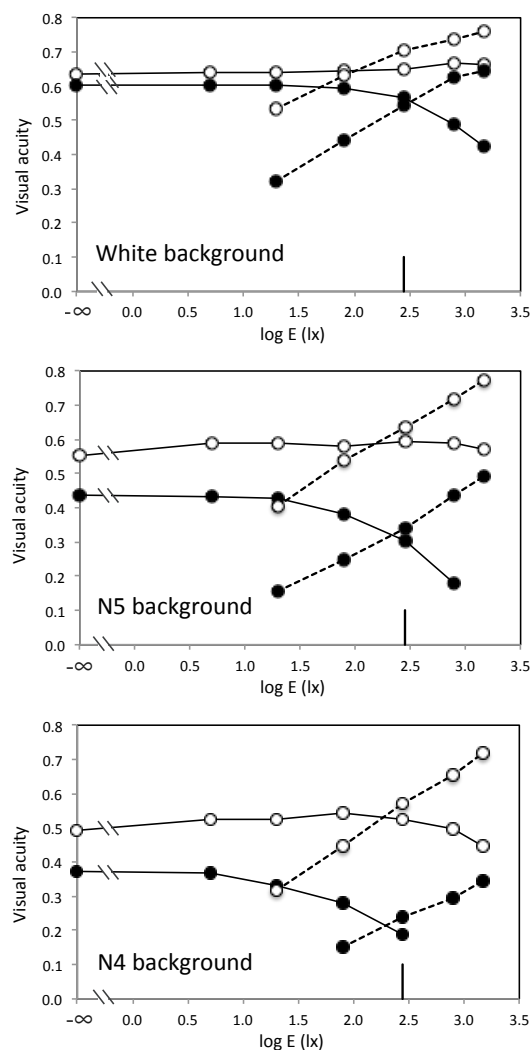

Figure 6-16 Visual acuity of the one-room and two-room for different background charts. Solid lines, supplemental two-room; dotted line, supplemental one-room. ○, normal eyes; ●, eyes with goggles.

6.6 Discussion on supplemental experiments

We introduced in supplemental experiments the method of adjustment to determine the letter height quickly while we employed the constant stimuli method in the previous experiments to determine the threshold accurately. We plotted the curves from both experiments together in Figure 6-17 for the comparison. The letter height results of negative contrast TF Srivichai font from one-room experiment were plotted in dotted lines and the letter height results of white background negative contrast of supplemental one-room experiment in solid lines. Both have the same condition as far as the contrast and the background are concerned. Short vertical bars indicate standard deviation among subjects.

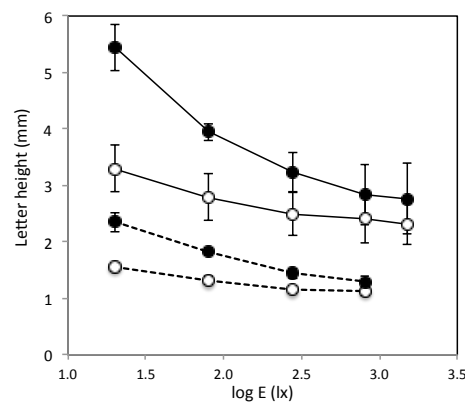

Figure 6-17 Letter height with standard deviation comparison on negative contrast from one-room experiment in dotted lines and white background from supplemental one-room experiment in solid lines. \circ , normal eyes; \bullet , eyes with goggles.

We see here three differences among two methods. Firstly the present results shown by solid lines are higher than the previous results in the vertical direction. That is the letter height is larger. Secondly the difference between normal eyes and eyes with goggles is larger in the present results for all the room illuminance. Thirdly the standard deviation is larger in the present experiment.

About the first point we should point out that the letter height in the previous experiment was determined for 50% of seeing while in the present experiment it was determined for 100% seeing of letters. To transfer the 50% letter height to 100% letter height we need to know the probability-of-seeing curve, which were used to obtain the 50% letter height in Chapter 4 such as shown in Figure 4-15 or Figure 4-16. The probability-of-seeing curve there was obtained for narrow range of line numbers just to cover 50% point and we can not utilize them in this discussion. So we decided to

obtain a full shape of the curve from two subjects PP and BW asking them to repeat 10 times. Letter charts of TF Srivichai font in negative contrast used in the previous experiment were used and 20 lx and 280 lx room illuminances were investigated. Figure 6-18 shows the results obtained from the subject PP, who also participated in the previous experiment. Along the abscissa letter height in mm is taken in the logarithmic unit and along the ordinate the percentage of correct response. Although it is the percentage along the ordinate we call the curves the probability-of-seeing curves to follow usual expression. Symbols connected by solid lines are the averaged results from ten repetitions; open squares from normal eyes at 280 lx, filled squares from eyes with goggles at 280 lx, open circles with normal eyes at 20 lx, and filled circles from eyes with goggles at 20 lx.

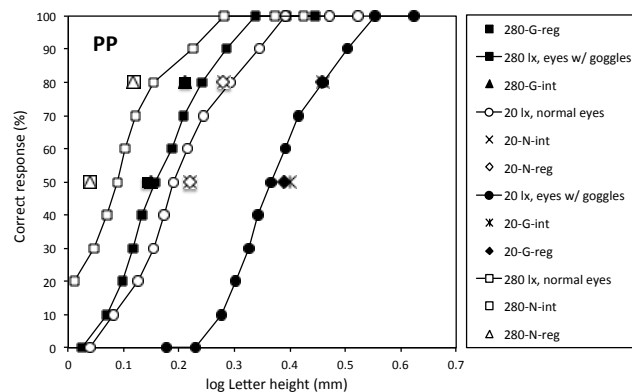

Figure 6-18 Probability-of-seeing curves of subject PP together with data points of 50% and 80% correct response from previous results in each condition indicated in the graph legend. ○, normal eyes at 20 lx; ●, eyes with goggles at 20 lx; □, normal eyes at 280 lx; ■, eyes with goggles at 280 lx.

Results from the previous experiment are also plotted for 50 and 80% that were obtained by two ways from data shown as in Figure 4-16. One way was to obtain a regression line for each session and to average points at 50% and at 80%. Another way was to average data of ten sessions to obtain one final curve of probability-of-seeing curve, from which points at 50 and 80% were obtained. Two open squares and two open triangles were obtained for the normal eyes at 280 lx. They come quite close to the probability-of-seeing curve obtained presently, particularly the slopes from both experiments are quite close. It was considered, therefore, that the result of the present experiment and that of the previous experiment showed the same result about the probability-of-seeing curve.

Figure 6-19 was obtained from the subject BW. He did not serve a subject in the previous experiment and there are no data points to show the results of the present experiment. The shapes of the curve of the subject BW are quite similar to those of PP and we took the average of all the curves shown in Figure 6-18 and Figure 6-19 except the curve of PP of normal eyes at 280 lx which lack data point at the probability 0 and 10.

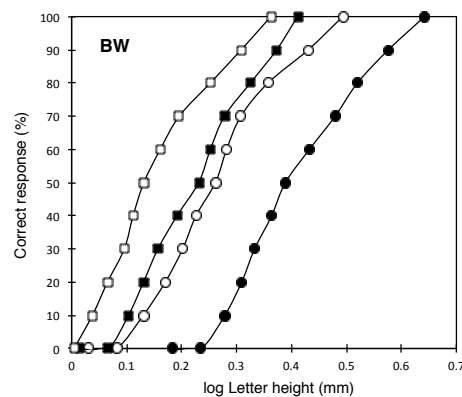

Figure 6-19 Probability-of-seeing curves of subject BW. ○, normal eyes at 20 lx; ●, eyes with goggles at 20 lx; □, normal eyes at 280 lx; ■, eyes with goggles at 280 lx.

The second point about the difference between normal eyes and eyes with goggles, the latter being larger at all the illuminance level. It is noted that the difference increased if the dotted curves were elevated. This was caused as mentioned above by the change of unit from logarithmic to linear for the ordinate. In fact the difference that we are discussing here increased with dashed curves compared to the dotted curves.

The result is shown in Figure 6-20. The abscissa is shown by log letter height in mm, not the linear unit of letter height in mm as shown in Figure 6-17. From this curve we can correct the data of Chapter 4 which based on 50% point to the data at 100%.

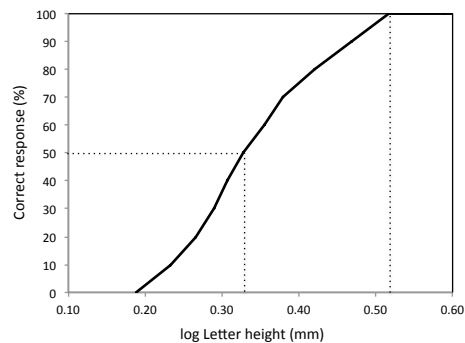

Figure 6-20 Probability-of-seeing curves in log letter height.

Figure 6-21 shows the results. Note that the ordinate is in letter height not in log letter height. Previous curves expressed by dotted lines from Figure 6-17 are now shifted upper ward by the amounts which can be read out from Figure 6-20 and they are shown by dashed lines. There are still difference between the solid curves and dashed curves in vertical position. The present results gave higher letter height than the previous experiment. In the method of adjustment that we employed in the present experiment subjects determined the line number on the letter chart for which they were certain to be able to read the letters. In the previous experiment subjects read letters and the experimenter recorded. They could guess letters with some uncertainty and the answer might be correct. This difference of subject's criterion between the two methods might have caused the larger letter height in the present experiment.

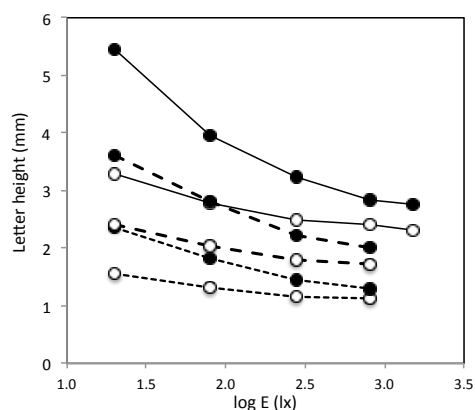

Fig 6-21 Letter height comparison on negative contrast from the 50% seeing one-room experiment in dotted lines, interpolated 100% seeing one-room experiment in dashed lines, and white background charts 100% seeing of supplemental one-room experiment in solid lines. ○, normal eyes; ●, eyes with goggles.

The third point was about the standard deviation. Standard deviations in Figure 6-17 were plotted in Figure 6-22 for supplemental one-room experiment in solid lines and one-room experiment in dotted lines. The adjustment method of supplemental one-room experiment clearly exhibited higher standard deviation of the experiment compared to the constant stimuli method. The high standard deviation happened to all range of illuminance except 80 lx for eyes with goggles. We don't know exactly what caused the difference but suppose that subjects had more freedom to determine the line numbers as they themselves could move the letter chart up and down. This freedom might caused a large value of standard deviation.

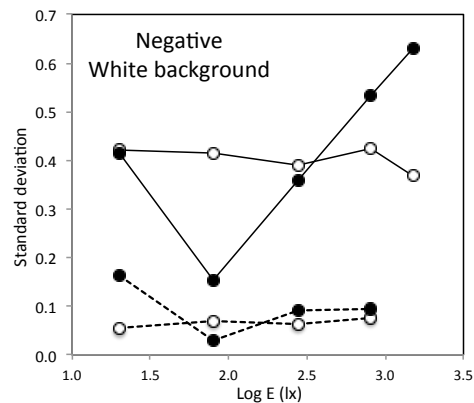

Figure 6-22 Standard deviation comparison on negative contrast from one-room experiment in dotted lines and white background from supplemental one-room experiment in solid lines.

○, normal eyes; ●, eyes with goggles.

The benefit of using two-room experiment proposed in Chapter 5 was not clearly confirmed. It was found in Chapter 4 that the letter height necessary to read letters 50% became close with each other whether with normal eyes or with eyes with goggles when the room illuminance was increased as seen in Figure 4-22. Thus not much benefit was found with the two-room experiment as seen in Figure 5-7. We supposed then that the letter chart of high contrast helped eyes with goggles to read letters and introduced in this chapter letter charts with low contrast. Our supposition was correct as the letter height became much larger with letter charts with the background of N4 and N5 as shown in Figure 6-7 and Figure 6-12. So we may say that the low contrast product labels highly affect the legibility of cataract vision. With introduction of the two-room technique the improvement of the visual performance was clearly seen as shown in Figure 6-12.

Referring to the visual acuity graphs in Figure 6-16, the low contrast product

labels similar to N4 background contrast could be benefit from two-room technique by reducing the subject room illuminance to the levels lower than stimulus illuminance. In this case the equi-illuminance was 280 lx in test room and subject room. For N4 background in the supplemental two-room experiment, the visual acuity increase 2.0 from 1.9 to 3.9 when subject room illuminance lower from 280 lx to 0 lx. The N5 background also benefit from visual acuity increase of 1.2 from 3.1 to 4.3 under the same conditions. However, the white background high contrast chart was minimally benefit form visual acuity increase of only 0.4 from 5.6 to 6.0. The result here confirms the benefit of two-room technique especially for the eyes with goggles that it improves the vision of low contrast stimulus. It also explains the previous result of two-room experiment that use high contrast charts to have small benefit of the two-room technique. The result from supplemental two-room experiment proved that the two-room technique is very effective to improve visual performance for the eyes with goggles and could confirm two-room technique as the proper illumination environment for improving cataract vision.

CHAPTER VII

READABILITY EXPERIMENT

7.1 Introduction

The one-room experiment presented in Chapter 4 and the two-room experiment in Chapter 5 used letter charts of high contrast and employed the constant stimuli method to find the 50% correct response. Their results did not show a clear advantage of two-room technique to improve the visual performance of the eyes with goggles. But it was proven by the supplemental experiment (Chapter 6) that the two-room experiment improved the visual performance if we used letter charts with low contrast. In the above experiments we investigated the legibility of letters. However, in our real life we should read words and sentences of product labels that give us message. The readability of words and sentences plays more important role rather than legibility of letters. The readability comprises of basic legibility and comprehension of the words. People should be able to see over all text in the label reasonably clear to be able to comprehend the message. In this chapter we simulated product labels with different text sizes and background contrasts and the readability was investigated.

The categorical response method was used for subjects to judge the readability of labels to be more practical and two techniques of one-room and two-room experiment were adopted. Since the previous results showed a high correlation among the three fonts of TF Srivichai, TF Pimpakarn, and ABC Pathom, we selected only TF Srivichai font for the readability experiment to represent the font for body text that is most widely used.

7.2 Apparatus

The same cataract experiencing goggles used in previous experiments were used in this readability experiment. The same one-room and two-room experimental rooms with their illuminance control facilities were also used with modification for setting label cards which worked as stimulus for reading.

Label cards were designed to simulate actual daily product labels. The rule of label design was set to control the similarity of text elements for each label cards. The labels were composed of three lines of text in the same size on the smooth background. The text was composed of at least one Thai numeric symbol, a product name, and other general words for label expression to fill up the text area at the center

of the label, as one example is shown in Figure 7-1.

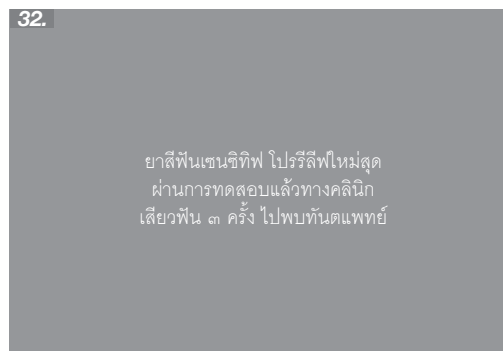

Figure 7-1 Sample of label card number 32 showing white text on gray background.

The polarity contrast of text was in white stroke of positive contrast and black stroke of negative contrast. For positive contrast, the background darkness varied from black, Munsell Value N3, N5, and N7 respectively. The black background achieved by printing solid coverage area of black ink from Canon iP4800 inkjet printer onto 260 gsm glossed coated white inkjet paper board. The N3 background is the printed equivalent to N3 or L* of about 30. It was achieved by printing the 95% dot from the same printer onto the same paper. The N5 background is the background of lightness about 50 that was printed with 78% dot, and the N7 background of lightness 70 was printed with 49% dot assigned to the background respectively.

In contrary, the negative contrast chart of black stroke text comprised of charts in the background of white, Munsell Value N7, N5, and N3 respectively. The white background and black text strokes configured the negative high contrast chart. The variation of background N7, N5, and N3 was achieved by the same way of background in positive contrast. The two polarity contrasts with four of its background variation were demonstrated in Figure 7-2.



Figure 7-2 Two polarity contrasts and its background variation of a same font size.

Font size assigned to the label cards followed the result of one-room and two-room experiment. The concept was to have only minimally required font sizes distribution that enough to cover the range of visual efficiency in this experiment. The smallest font size of 9.5 point was to simulate the smallest legible for 80% seeing under optimal condition. The 80% seeing was roughly designate by the topping of one line number above the result of 50% seeing. The biggest font size of 40 point was to simulate the worst seeing of the eyes with goggles under bad situation from the result of one-room and two-room experiment. The font size in between was put as logarithmically even distributed. The seven font sizes were 9.5, 12, 16, 20, 25, 32, 40 in point size, respectively. Figure 7-3 showed samples of label text in all seven sizes.

font size 9.5 pt	กล้วยหอมอบเนยตราศาลาไทย สินค้าดีจากเมืองไทย ผลิตจากกล้วยหอมทองพันธุ์ดี คัดพิเศษ อร่อยง่าย ๆ ในถุงพอยล์กันชื้น ขนาด ๒๗๕ กรัม
font size 12 pt	แคปหมูไร้มันตราแม่คะนึ่ง ของดีพะเยา ผ่านการทอดด้วยเทคนิคพิเศษ ๓ ขั้นตอน รับประทานได้ทุกวัน ไม่ทำให้อ้วนพลี
font size 16 pt	น้ำตาลโตนดแท้ ตราคนป็นต้นตาล สูงสุขรับประกันคุณภาพ อร่อยติดใจ ขึ้นตาลด้วยตนเองมานานกว่า ๓๐ ปี
font size 20 pt	ครีมνωดผมสุตรสมุโนไพรน้ำอัญชัน ปรับสภาพเส้นผมให้นุ่มลื่นขึ้น ใช้เป็นประจำวันละ ๑ ครั้งเท่านั้น
font size 25 pt	ดีมอร่อย ได้คุณค่า ราคาเบา ตรามาลี สิ่งดี ๆ มีได้ทุกวัน สินค้าเลือกได้กว่า ๔๐ ชนิด
font size 32 pt	ทับทิมไสพร้อมดีม คุณค่าจากสวนถึงคุณ แปดขวด ๑๐๐ บาท
font size 40 pt	ขิงผงตราชินจังกิ มี ๔ รสให้เลือกดีม วันละแก้ว สุขภาพดี

Figure 7-3 Samples of label text in different font sizes.

Label cards were designed in the size of 13.5 cm wide and 9 cm high. Label text was placed at the center of the card. Since there were quite number of cards, the card numbers were given at the top left corner of each card. The letter size, contrast, and coding of each card was governed by the cards list in Table 7-1. There were 56 label cards altogether. Samples of actual label cards are shown in Figure 7-4.



Figure 7-4 Samples of eight cards with card numbering at the top left corner. Left column, negative contrast; right column, positive contrast.

Table 7-1 Card numbers with corresponding font size, background, and coding for each card.

Negative contrast					Positive contrast				
Card #	Font size (pt)	LH (mm)	Background	Code	Card #	Font size (pt)	LH (mm)	Background	Code
1	9.5	1.386	white	NW-n1	29	9.5	1.386	N7	N7-p1
2	12	1.745	white	NW-n2	30	12	1.745	N7	N7-p2
3	16	2.197	white	NW-n3	31	16	2.197	N7	N7-p3
4	20	2.766	white	NW-n4	32	20	2.766	N7	N7-p4
5	25	3.482	white	NW-n5	33	25	3.482	N7	N7-p5
6	32	4.383	white	NW-n6	34	32	4.383	N7	N7-p6
7	40	5.518	white	NW-n7	35	40	5.518	N7	N7-p7
8	9.5	1.386	N7	N7-n1	36	9.5	1.386	N5	N5-p1
9	12	1.745	N7	N7-n2	37	12	1.745	N5	N5-p2
10	16	2.197	N7	N7-n3	38	16	2.197	N5	N5-p3
11	20	2.766	N7	N7-n4	39	20	2.766	N5	N5-p4
12	25	3.482	N7	N7-n5	40	25	3.482	N5	N5-p5
13	32	4.383	N7	N7-n6	41	32	4.383	N5	N5-p6
14	40	5.518	N7	N7-n7	42	40	5.518	N5	N5-p7
15	9.5	1.386	N5	N5-n1	43	9.5	1.386	N3	N3-p1
16	12	1.745	N5	N5-n2	44	12	1.745	N3	N3-p2
17	16	2.197	N5	N5-n3	45	16	2.197	N3	N3-p3
18	20	2.766	N5	N5-n4	46	20	2.766	N3	N3-p4
19	25	3.482	N5	N5-n5	47	25	3.482	N3	N3-p5
20	32	4.383	N5	N5-n6	48	32	4.383	N3	N3-p6
21	40	5.518	N5	N5-n7	49	40	5.518	N3	N3-p7
22	9.5	1.386	N3	N3-n1	50	9.5	1.386	black	NB-p1
23	12	1.745	N3	N3-n2	51	12	1.745	black	NB-p2
24	16	2.197	N3	N3-n3	52	16	2.197	black	NB-p3
25	20	2.766	N3	N3-n4	53	20	2.766	black	NB-p4
26	25	3.482	N3	N3-n5	54	25	3.482	black	NB-p5
27	32	4.383	N3	N3-n6	55	32	4.383	black	NB-p6
28	40	5.518	N3	N3-n7	56	40	5.518	black	NB-p7

The card-holder was a static slot for inserting the card and let the card drop in place as shown in Figure 7-5. The slot frame was 1.5 cm wide and cover the card edge of 0.5 cm on each side and bottom part. The card center position was at 125 cm above ground, which was the subject's eyes level. The card insertion was conducted by experimenter. For the one-room readability experiment, card insertion was made from the back of the card-holder as illustrated in Figure 7-5 with display area of 12.5 cm wide by 8 cm high. The gray facet of 26 x 26 cm with the window size of 10.1 cm wide by 6 cm high was cover in front of the card-holder on the wall in the subject room to crop the visible area of the label card centrally. But for the two-room readability, card-holder was installed in the test room and card insertion was made in the front of slot as shown in Figure 7-6. The display area of the card on the slot was 12.5 cm wide by 8.5 cm high. The window between the two rooms was adjusted to exactly fit the visual frame of the label on the card-holder. The window size on the

wall between the two-room was 7.8 cm wide by 4.2 cm high in the gray color facet of 26 x 26 cm so that subjects could see the entire label card with two eyes. Experimenter inserted the card one by one for subject to evaluate. The viewing distances were 120 cm and 150 cm for the one-room and the two-room experiment, respectively.

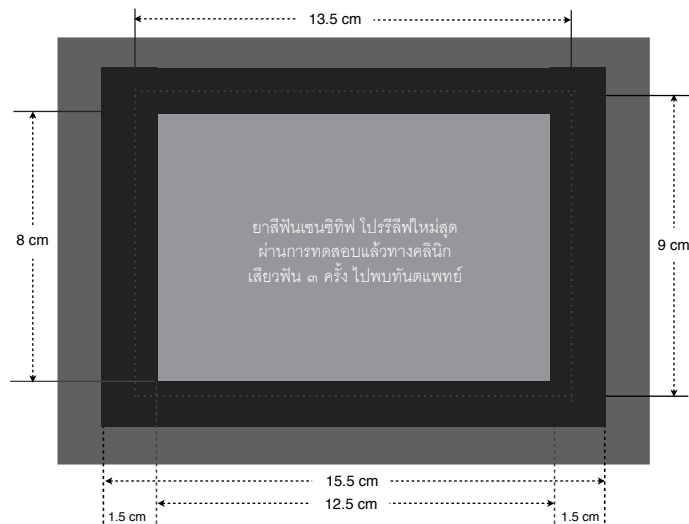

Figure 7-5 Card-holder for one-room readability experiment, placing label card from the back.

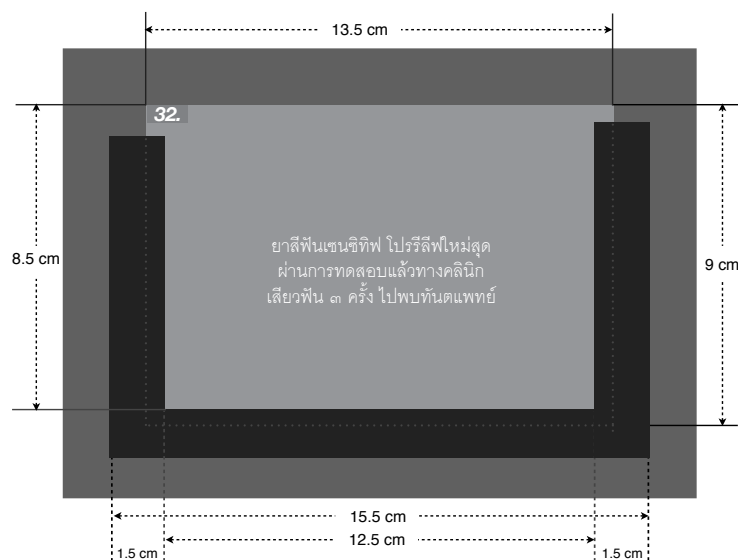

Figure 7-6 Card-holder for two-room readability experiment, placing label card from the front.

7.3 Experimental condition

The experimental conditions for one-room readability experiment was mostly same as the one-room experiment given in Chapter IV except the label cards to be used instead of letter charts. They are summarized in Table 7-2. Experimental conditions for two-room readability experiment was also adopted from the two-room experiment given in Chapter V and utilized the label cards in this experiment. The experimental conditions for two-room readability experiment are summarized in Table 7-3. Only TF Srivichai font was investigated in this experiment to take benefit of the similarity result from the three fonts shown in Chapter IV and V.

Table 7-2 Experimental conditions of one-room readability experiment.

Experiment	Conditions
Subject room illuminance (lx)	20, 80, 280, 800
Font type	TF Srivichai
Label cards	56 cards
Goggles	Off, On
Viewing distance (cm)	120
Repeating (sessions)	3

Table 7-3 Experimental conditions of two-room readability experiment.

Experiment	Conditions
Subject room illuminance (lx)	20, 80, 280, 800, 1500
Test room illuminance (lx)	280
Font type	TF Srivichai
Label cards	56 cards
Goggles	Off, On
Viewing distance (cm)	150
Repeating (sessions)	3

7.4 Procedure

Five subjects, AP, ET, OB, PC, and PS participated in the readability experiment in one-room and two-room. They were students of Department of Imaging and Printing Technology with the age of between 25-35 years old. Subjects ET and PS participated in the previous experiments and subjects AP, OB and PC participated

here for the first time.

Orientation was made for all subjects on the readability experiment task. Subjects were trained for the judgment criteria to response to one of the four categories: Cannot Read, Difficult to Read, Can Read, and Comfortable to Read. If a subject could not see the detail in the card or any of the label content, the subject responded with “Cannot read”. If a card was partly readable he/she responded with “Difficult to read”. If a card was totally readable but needed an effort to read he responded with “Can read”. If a card was readable comfortably he/she responded with “Comfortable to read”.

When a certain experimental condition was set a label card was chosen from 56 cards and was put in the slot. A subject looked at the label card and responded verbally with one of four categories. The experimenter recorded the response on a datasheet as shown in Figure 7-7 in the result section. The number 1, 2, 3, 4 was prepared for each card number in the datasheet. If subject response for Cannot Read, the number 1 in the datasheet was circled for that card number. The similar way of recording response was number 2 for the Difficult to Read, number 3 for the Can Read, and number 4 for the Comfortable to Read.

The one-room and two-room readability experiment was conducted separately. At each illuminance of the subject room subjects chose to start the experiment with either normal eyes or eyes with goggles to finish the 56 cards. Then the cards were reshuffled and subject experimented with the other goggles condition under the same illuminance until the 56 cards were observed again.

After completion of both goggles conditions in the same illuminance, one round of experiment was over and the experimenter set the next illuminance. When all the illuminances were investigated one session was over. Subjects were asked to conduct 3 sessions of experiment for both the one-room and two-room readability experiments. It took about 60-70 minutes to finish one session of one-room readability experiment and 105-120 minutes to finish one session of two-room readability experiment. If experiment was paused or stopped, experimenter tried to stop at the completion of a session.

7.5 Results

7.5.1 One-room readability experiment

The result of ET for one session of one-room readability experiment conducted with normal eyes and eyes with goggles under 20, 80, 280, and 800 lx is shown in datasheets in Figure 7-7. The circled number at each card number represents

the category of the response for that card, 1 for Cannot Read, 2 for Difficult to Read, 3 for Can Read, and 4 for Comfortable to Read. For example the normal eyes under 20 lx illuminance, card #1 response for Cannot Read, card # 2 for Difficult to Read, card # 3-5 for Can Read, and card # 6-7 for Comfortable to Read. There were seven different sizes of letters and they are grouped in Figure 7-7 and Figure 7-8 by different background color, white or gray. Figure 7-7 shows result from the experiment under illuminance of 20 and 80 lx and Figure 7-8 for the experiment under illuminance 280 and 800 lx.

Exp 3 Readability Name: ET Trial: 1 Date: 24 Jan 2012 Time: .am

Room: ① 2 Illuminance: 20 lx				Room: ① 2 Illuminance: 80 lx			
Chart#	Naked	Chart#	Goggle	Chart#	Naked	Chart#	Goggle
1	① . 2 . 3 . 4	1	① . 2 . 3 . 4	1	① . 2 . 3 . 4	1	① . 2 . 3 . 4
2	1 . ② . 3 . 4	2	① . 2 . 3 . 4	2	1 . ② . 3 . 4	2	① . 2 . 3 . 4
3	1 . 2 . ③ . 4	3	① . 2 . 3 . 4	3	1 . 2 . ③ . 4	3	1 . ② . 3 . 4
4	1 . 2 . ③ . 4	4	1 . ② . 3 . 4	4	1 . 2 . 3 . ④	4	1 . 2 . ③ . 4
5	1 . 2 . ③ . 4	5	1 . ② . 3 . 4	5	1 . 2 . 3 . ④	5	1 . 2 . ③ . 4
6	1 . 2 . 3 . ④	6	1 . 2 . ③ . 4	6	1 . 2 . 3 . ④	6	1 . 2 . 3 . ④
7	1 . 2 . 3 . ④	7	1 . 2 . 3 . ④	7	1 . 2 . 3 . ④	7	1 . 2 . 3 . ④
8	① . 2 . 3 . 4	8	① . 2 . 3 . 4	8	① . 2 . 3 . 4	8	① . 2 . 3 . 4
9	① . 2 . 3 . 4	9	① . 2 . 3 . 4	9	1 . ② . 3 . 4	9	① . 2 . 3 . 4
10	1 . ② . 3 . 4	10	① . 2 . 3 . 4	10	1 . 2 . ③ . 4	10	① . 2 . 3 . 4
11	1 . 2 . ③ . 4	11	① . 2 . 3 . 4	11	1 . 2 . ③ . 4	11	1 . ② . 3 . 4
12	1 . 2 . ③ . 4	12	① . 2 . 3 . 4	12	1 . 2 . ③ . 4	12	1 . 2 . ③ . 4
13	1 . 2 . ③ . 4	13	1 . ② . 3 . 4	13	1 . 2 . ③ . 4	13	1 . 2 . ③ . 4
14	1 . 2 . 3 . ④	14	1 . 2 . ③ . 4	14	1 . 2 . ③ . 4	14	1 . 2 . ③ . 4
15	① . 2 . 3 . 4	15	① . 2 . 3 . 4	15	① . 2 . 3 . 4	15	① . 2 . 3 . 4
16	① . 2 . 3 . 4	16	① . 2 . 3 . 4	16	① . 2 . 3 . 4	16	① . 2 . 3 . 4
17	① . 2 . 3 . 4	17	① . 2 . 3 . 4	17	1 . ② . 3 . 4	17	① . 2 . 3 . 4
18	1 . ② . 3 . 4	18	① . 2 . 3 . 4	18	1 . 2 . ③ . 4	18	① . 2 . 3 . 4
19	1 . ② . 3 . 4	19	① . 2 . 3 . 4	19	1 . 2 . ③ . 4	19	① . 2 . 3 . 4
20	1 . 2 . ③ . 4	20	① . 2 . 3 . 4	20	1 . 2 . ③ . 4	20	1 . ② . 3 . 4
21	1 . 2 . ③ . 4	21	① . 2 . 3 . 4	21	1 . 2 . ③ . 4	21	1 . ② . 3 . 4
22	① . 2 . 3 . 4	22	① . 2 . 3 . 4	22	① . 2 . 3 . 4	22	① . 2 . 3 . 4
23	① . 2 . 3 . 4	23	① . 2 . 3 . 4	23	① . 2 . 3 . 4	23	① . 2 . 3 . 4
24	① . 2 . 3 . 4	24	① . 2 . 3 . 4	24	① . 2 . 3 . 4	24	① . 2 . 3 . 4
25	① . 2 . 3 . 4	25	① . 2 . 3 . 4	25	1 . ② . 3 . 4	25	① . 2 . 3 . 4
26	1 . ② . 3 . 4	26	① . 2 . 3 . 4	26	1 . ② . 3 . 4	26	① . 2 . 3 . 4
27	1 . ② . 3 . 4	27	① . 2 . 3 . 4	27	1 . 2 . ③ . 4	27	① . 2 . 3 . 4
28	1 . 2 . ③ . 4	28	① . 2 . 3 . 4	28	1 . 2 . ③ . 4	28	① . 2 . 3 . 4
29	① . 2 . 3 . 4	29	① . 2 . 3 . 4	29	① . 2 . 3 . 4	29	① . 2 . 3 . 4
30	① . 2 . 3 . 4	30	① . 2 . 3 . 4	30	① . 2 . 3 . 4	30	① . 2 . 3 . 4
31	① . 2 . 3 . 4	31	① . 2 . 3 . 4	31	1 . ② . 3 . 4	31	① . 2 . 3 . 4
32	1 . ② . 3 . 4	32	① . 2 . 3 . 4	32	1 . 2 . ③ . 4	32	① . 2 . 3 . 4
33	1 . 2 . ③ . 4	33	① . 2 . 3 . 4	33	1 . 2 . ③ . 4	33	1 . ② . 3 . 4
34	1 . 2 . ③ . 4	34	① . 2 . 3 . 4	34	1 . 2 . ③ . 4	34	1 . 2 . ③ . 4
35	1 . 2 . ③ . 4	35	1 . ② . 3 . 4	35	1 . 2 . ③ . 4	35	1 . 2 . ③ . 4
36	① . 2 . 3 . 4	36	① . 2 . 3 . 4	36	① . 2 . 3 . 4	36	① . 2 . 3 . 4
37	① . 2 . 3 . 4	37	① . 2 . 3 . 4	37	① . 2 . 3 . 4	37	① . 2 . 3 . 4
38	1 . ② . 3 . 4	38	① . 2 . 3 . 4	38	1 . ② . 3 . 4	38	① . 2 . 3 . 4
39	1 . ② . 3 . 4	39	① . 2 . 3 . 4	39	1 . 2 . ③ . 4	39	1 . ② . 3 . 4
40	1 . 2 . ③ . 4	40	① . 2 . 3 . 4	40	1 . 2 . ③ . 4	40	1 . 2 . ③ . 4
41	1 . 2 . ③ . 4	41	1 . ② . 3 . 4	41	1 . 2 . ③ . 4	41	1 . 2 . ③ . 4
42	1 . 2 . ③ . 4	42	1 . 2 . ③ . 4	42	1 . 2 . 3 . ④	42	1 . 2 . ③ . 4
43	① . 2 . 3 . 4	43	① . 2 . 3 . 4	43	① . 2 . 3 . 4	43	① . 2 . 3 . 4
44	① . 2 . 3 . 4	44	① . 2 . 3 . 4	44	1 . ② . 3 . 4	44	① . 2 . 3 . 4
45	1 . ② . 3 . 4	45	① . 2 . 3 . 4	45	1 . ② . 3 . 4	45	① . 2 . 3 . 4
46	1 . 2 . ③ . 4	46	1 . ② . 3 . 4	46	1 . 2 . ③ . 4	46	1 . ② . 3 . 4
47	1 . 2 . ③ . 4	47	1 . ② . 3 . 4	47	1 . 2 . ③ . 4	47	1 . 2 . ③ . 4
48	1 . 2 . ③ . 4	48	1 . 2 . ③ . 4	48	1 . 2 . 3 . ④	48	1 . 2 . 3 . ④
49	1 . 2 . 3 . ④	49	1 . 2 . ③ . 4	49	1 . 2 . 3 . ④	49	1 . 2 . 3 . ④
50	① . 2 . 3 . 4	50	① . 2 . 3 . 4	50	① . 2 . 3 . 4	50	① . 2 . 3 . 4
51	① . 2 . 3 . 4	51	① . 2 . 3 . 4	51	① . 2 . 3 . 4	51	① . 2 . 3 . 4
52	1 . ② . 3 . 4	52	① . 2 . 3 . 4	52	1 . ② . 3 . 4	52	① . 2 . 3 . 4
53	1 . ② . 3 . 4	53	① . 2 . 3 . 4	53	1 . 2 . ③ . 4	53	① . 2 . 3 . 4
54	1 . 2 . ③ . 4	54	1 . ② . 3 . 4	54	1 . 2 . ③ . 4	54	1 . 2 . ③ . 4
55	1 . 2 . 3 . ④	55	1 . 2 . ③ . 4	55	1 . 2 . 3 . ④	55	1 . 2 . 3 . ④
56	1 . 2 . 3 . ④	56	1 . 2 . ③ . 4	56	1 . 2 . 3 . ④	56	1 . 2 . 3 . ④

Figure 7-7 Data from one session of subject ET experimented with normal eyes and eyes with goggles under illuminance conditions 20 and 80 lx.

Exp 3 Readability Name: ET Trial: 1 Date: 24 Jan 2012 Time: .am

Room: ① 2 Illuminance: 280 lx				Room: ① 2 Illuminance: 800 lx			
Chart#	Naked	Chart#	Goggle	Chart#	Naked	Chart#	Goggle
1	1. ②. 3. 4	1	①. 2. 3. 4	1	1. ②. 3. 4	1	①. 2. 3. 4
2	1. ②. 3. 4	2	1. ②. 3. 4	2	1. ②. 3. 4	2	1. ②. 3. 4
3	1. 2. ③. 4	3	1. 2. ③. 4	3	1. 2. ③. 4	3	1. 2. ③. 4
4	1. 2. 3. ④	4	1. 2. ③. 4	4	1. 2. ③. 4	4	1. 2. ③. 4
5	1. 2. 3. ④	5	1. 2. ③. 4	5	1. 2. ③. 4	5	1. 2. ③. 4
6	1. 2. 3. ④	6	1. 2. 3. ④	6	1. 2. 3. ④	6	1. 2. 3. ④
7	1. 2. 3. ④	7	1. 2. 3. ④	7	1. 2. 3. ④	7	1. 2. 3. ④
8	①. 2. 3. 4	8	①. 2. 3. 4	8	1. ②. 3. 4	8	①. 2. 3. 4
9	1. ②. 3. 4	9	①. 2. 3. 4	9	1. ②. 3. 4	9	①. 2. 3. 4
10	1. 2. ③. 4	10	1. ②. 3. 4	10	1. 2. ③. 4	10	①. 2. 3. 4
11	1. 2. ③. 4	11	1. 2. ③. 4	11	1. 2. ③. 4	11	1. 2. ③. 4
12	1. 2. ③. 4	12	1. 2. ③. 4	12	1. 2. ③. 4	12	1. 2. ③. 4
13	1. 2. ③. 4	13	1. 2. ③. 4	13	1. 2. ③. 4	13	1. 2. ③. 4
14	1. 2. ③. 4	14	1. 2. ③. 4	14	1. 2. 3. ④	14	1. 2. ③. 4
15	①. 2. 3. 4	15	①. 2. 3. 4	15	①. 2. 3. 4	15	①. 2. 3. 4
16	1. ②. 3. 4	16	①. 2. 3. 4	16	1. ②. 3. 4	16	①. 2. 3. 4
17	1. 2. ③. 4	17	①. 2. 3. 4	17	1. 2. ③. 4	17	①. 2. 3. 4
18	1. 2. ③. 4	18	1. ②. 3. 4	18	1. 2. ③. 4	18	1. ②. 3. 4
19	1. 2. ③. 4	19	1. 2. ③. 4	19	1. 2. ③. 4	19	1. 2. ③. 4
20	1. 2. ③. 4	20	1. 2. ③. 4	20	1. 2. ③. 4	20	1. 2. ③. 4
21	1. 2. ③. 4	21	1. 2. ③. 4	21	1. 2. 3. ④	21	1. 2. ③. 4
22	①. 2. 3. 4	22	①. 2. 3. 4	22	①. 2. 3. 4	22	①. 2. 3. 4
23	①. 2. 3. 4	23	①. 2. 3. 4	23	1. ②. 3. 4	23	①. 2. 3. 4
24	1. ②. 3. 4	24	①. 2. 3. 4	24	1. ②. 3. 4	24	①. 2. 3. 4
25	1. 2. ③. 4	25	①. 2. 3. 4	25	1. 2. ③. 4	25	①. 2. 3. 4
26	1. 2. ③. 4	26	①. 2. 3. 4	26	1. 2. ③. 4	26	①. 2. 3. 4
27	1. 2. ③. 4	27	①. 2. 3. 4	27	1. 2. ③. 4	27	①. 2. 3. 4
28	1. 2. ③. 4	28	①. 2. 3. 4	28	1. 2. ③. 4	28	①. 2. 3. 4
29	①. 2. 3. 4	29	①. 2. 3. 4	29	①. 2. 3. 4	29	①. 2. 3. 4
30	1. ②. 3. 4	30	①. 2. 3. 4	30	1. ②. 3. 4	30	①. 2. 3. 4
31	1. ②. 3. 4	31	①. 2. 3. 4	31	1. 2. ③. 4	31	1. ②. 3. 4
32	1. 2. ③. 4	32	1. ②. 3. 4	32	1. 2. ③. 4	32	1. 2. ③. 4
33	1. 2. ③. 4	33	1. 2. ③. 4	33	1. 2. ③. 4	33	1. 2. ③. 4
34	1. 2. ③. 4	34	1. 2. ③. 4	34	1. 2. ③. 4	34	1. 2. ③. 4
35	1. 2. 3. ④	35	1. 2. ③. 4	35	1. 2. ③. 4	35	1. 2. ③. 4
36	①. 2. 3. 4	36	①. 2. 3. 4	36	①. 2. 3. 4	36	①. 2. 3. 4
37	1. ②. 3. 4	37	①. 2. 3. 4	37	1. ②. 3. 4	37	①. 2. 3. 4
38	1. 2. ③. 4	38	1. ②. 3. 4	38	1. 2. ③. 4	38	1. ②. 3. 4
39	1. 2. ③. 4	39	1. 2. ③. 4	39	1. 2. ③. 4	39	1. 2. ③. 4
40	1. 2. ③. 4	40	1. 2. ③. 4	40	1. 2. ③. 4	40	1. 2. ③. 4
41	1. 2. 3. ④	41	1. 2. ③. 4	41	1. 2. 3. ④	41	1. 2. 3. ④
42	1. 2. 3. ④	42	1. 2. 3. ④	42	1. 2. 3. ④	42	1. 2. 3. ④
43	①. 2. 3. 4	43	①. 2. 3. 4	43	①. 2. 3. 4	43	①. 2. 3. 4
44	1. ②. 3. 4	44	①. 2. 3. 4	44	1. ②. 3. 4	44	1. ②. 3. 4
45	1. 2. ③. 4	45	1. ②. 3. 4	45	1. 2. ③. 4	45	1. ②. 3. 4
46	1. 2. ③. 4	46	1. 2. ③. 4	46	1. 2. ③. 4	46	1. 2. ③. 4
47	1. 2. ③. 4	47	1. 2. ③. 4	47	1. 2. ③. 4	47	1. 2. ③. 4
48	1. 2. 3. ④	48	1. 2. ③. 4	48	1. 2. 3. ④	48	1. 2. 3. ④
49	1. 2. 3. ④	49	1. 2. 3. ④	49	1. 2. 3. ④	49	1. 2. 3. ④
50	①. 2. 3. 4	50	①. 2. 3. 4	50	①. 2. 3. 4	50	①. 2. 3. 4
51	1. ②. 3. 4	51	①. 2. 3. 4	51	1. ②. 3. 4	51	①. 2. 3. 4
52	1. 2. ③. 4	52	1. ②. 3. 4	52	1. 2. ③. 4	52	1. ②. 3. 4
53	1. 2. ③. 4	53	1. 2. ③. 4	53	1. 2. ③. 4	53	1. 2. ③. 4
54	1. 2. ③. 4	54	1. 2. ③. 4	54	1. 2. ③. 4	54	1. 2. ③. 4
55	1. 2. 3. ④	55	1. 2. 3. ④	55	1. 2. 3. ④	55	1. 2. 3. ④
56	1. 2. 3. ④	56	1. 2. 3. ④	56	1. 2. 3. ④	56	1. 2. 3. ④

Figure 7-8 Data from one session of subject ET experimented with normal eyes and eyes with goggles under illuminance conditions 280 and 800 lx.

The size of stimulus or the body height of the letters are the major variation factor for the visual perception. Legibility and readability efficiency are based on the letter height. For the even distribution of height, the even angular size was assigned and the letter height was calculated. Letter height for this research is defined as the body height or x-height. The font size unit in point is the size for the display of letters. The point size is the line height from baseline to the next baseline of font. It has to accommodate the text body and all relevant strokes including the upper and lower extensions of the letter. Hence the body height is always smaller than the point size. One point equal $1/72$ of an inch. The point size of font where its body height equal to the calculated letter height is the equivalent point size for that letter height. The angular size, calculated letter height, and equivalent point size mainly used in this research is listed in Table 4-1. In this readability experiment, seven equivalent point sizes were used. They are 9.5, 12, 16, 20, 25, 32, and 40 point respectively

The response size numbers were converted to letter height in mm from the LH data in Table 7-1. Since we conducted only three sessions of experiment we do not use the standard deviation for the variance analysis but results of the three sessions from the same condition were plotted in a same graph. Figure 7-9 and Figure 7-10 show the letter height versus log illuminance from subject ET and PC on label cards of N3 background in positive contrast. Thin solid lines show raw data of three sessions and thick dotted lines show the average. Figure 7-9 from normal eyes and Figure 7-10 from eyes with goggles. It must be remembered that subjects was asked to respond with four categories and not to interpolate between two categories. Therefore, raw data points fall at fixed letter heights causing overlap of points in the figure. However, the average was simply taken for three letter heights as tendency of three curves appeared similar. Actually the average should have done in log letter height and convert back to letter height. Since the variance among three sessions in letter height is small, the difference between averaged letter height and average log letter height was not much different. We use normal average for letter height among the three sessions. Comfortable reading response was not possible even with the largest letter with eyes with goggles if the room illuminance was low. No data points exist there.

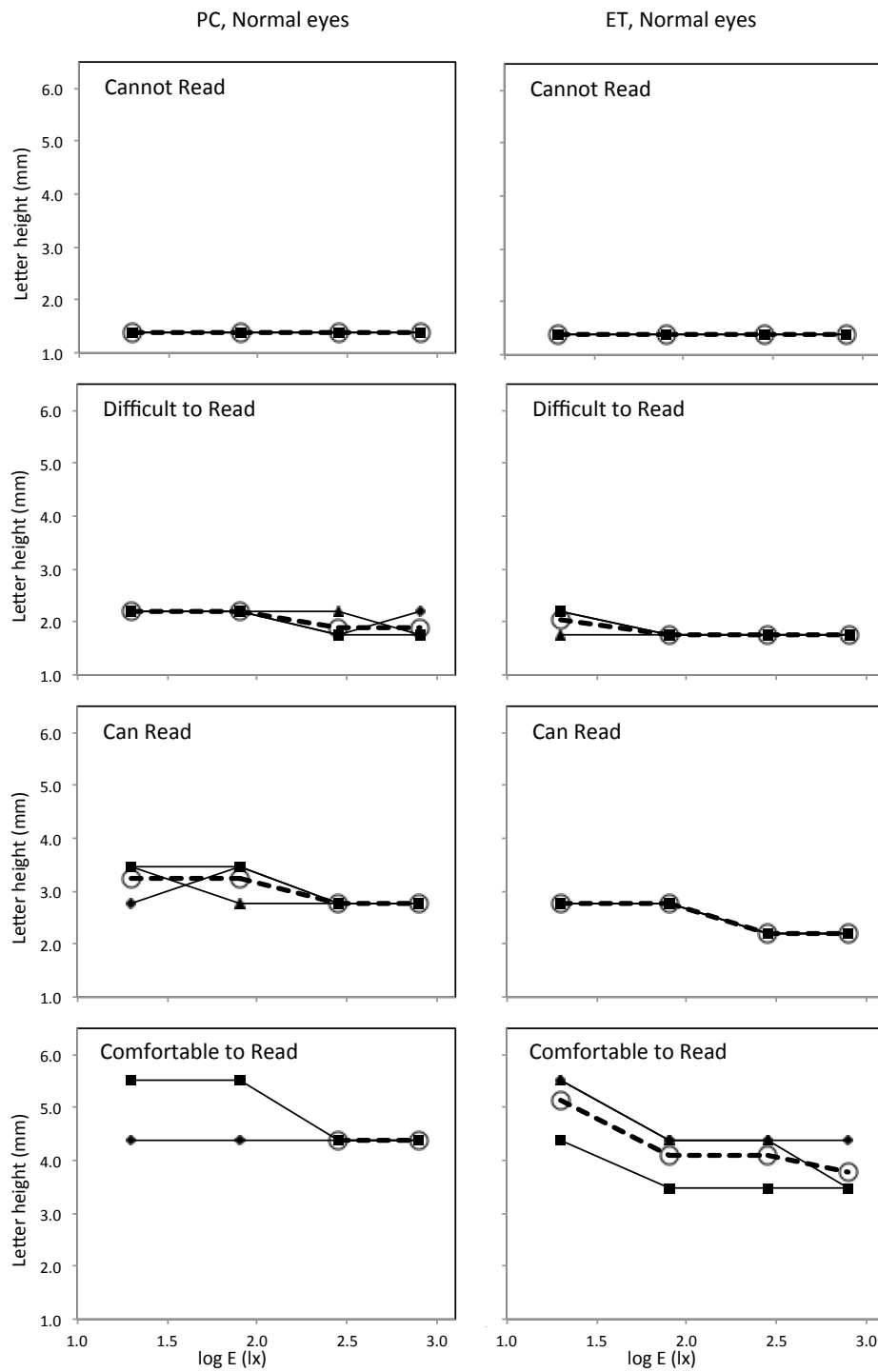

Figure 7-9 Results with normal eyes of one-room readability experiment from subject ET and PC. Label card of N3 background and of positive contrast. Thin solid lines, results from three sessions; thick dotted line, average.

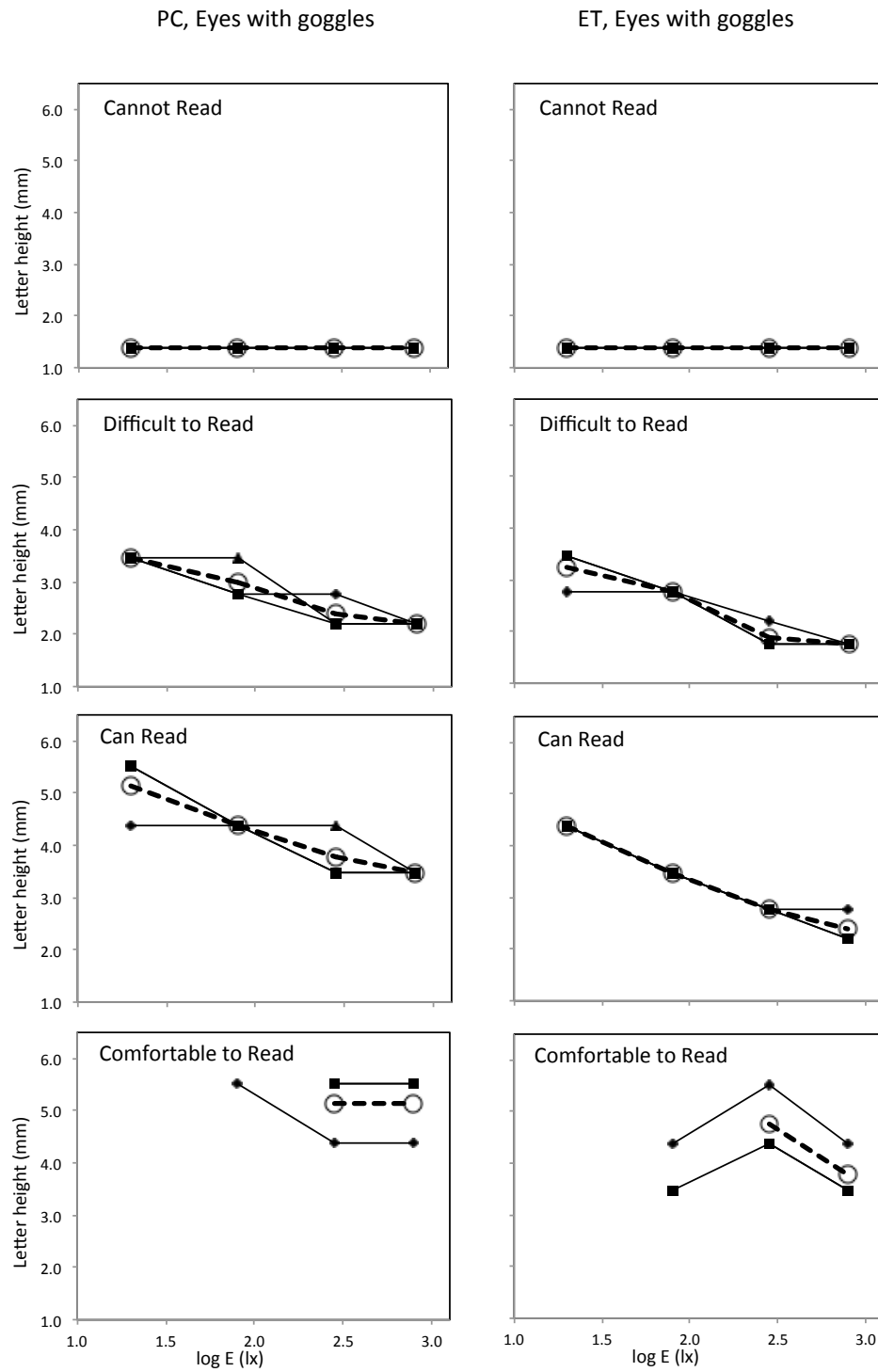
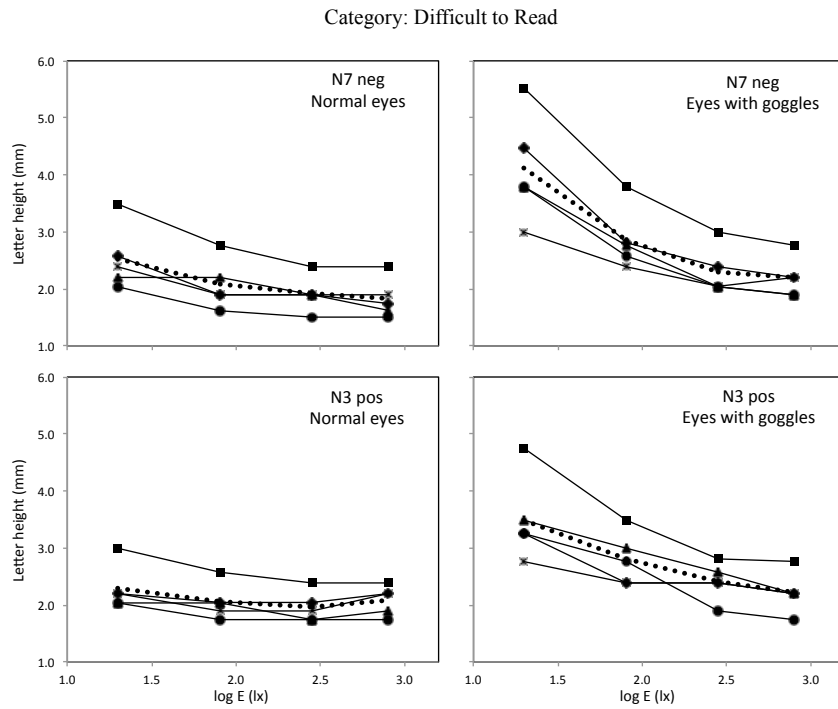

Figure 7-10 Results with eyes with goggles of one-room readability experiment from subject ET and PC. Label card of N3 background and of positive contrast. Thin solid lines, results from three sessions; thick dotted line, average.

It is clearly seen that for more readable response the larger letter size was needed. The same categorical response was possible for smaller letters when the room illuminance was increased. The category Comfortable to Read exhibited highest variance among the four categories for both subjects. The intra-subject variance data of the one-room readability experiment is available in Appendix.

The results in letter height from the three sessions of experiment were averaged. The results of each subject on N7 background of negative contrast and N3 background of positive contrast were compared for variance among subjects. Figure 7-11 shows the result in category Difficult to Read (a) and category Can Read (b) by normal eyes and eyes with goggles for each subject. Thin solid lines show averaged letter height of each subject and thick dotted lines show the average among five subjects. The variance among subjects was not high except for subject AP that exhibited scattered bigger letter height compared to the rest of subjects that results were conglomerated. However the tendencies of curves for AP were quite parallel to the average curves. We took average of letter height from the five subjects for the further analysis. The inter-subject variance data of the one-room readability experiment is available in Appendix.

The N7 background of negative contrast and N3 background of positive contrast are opposite in contrast polarity, but similar in contrast value. The averaged results from both contrasts of the same goggles condition shows the similarity in letter heights and curves tendency.



(a)

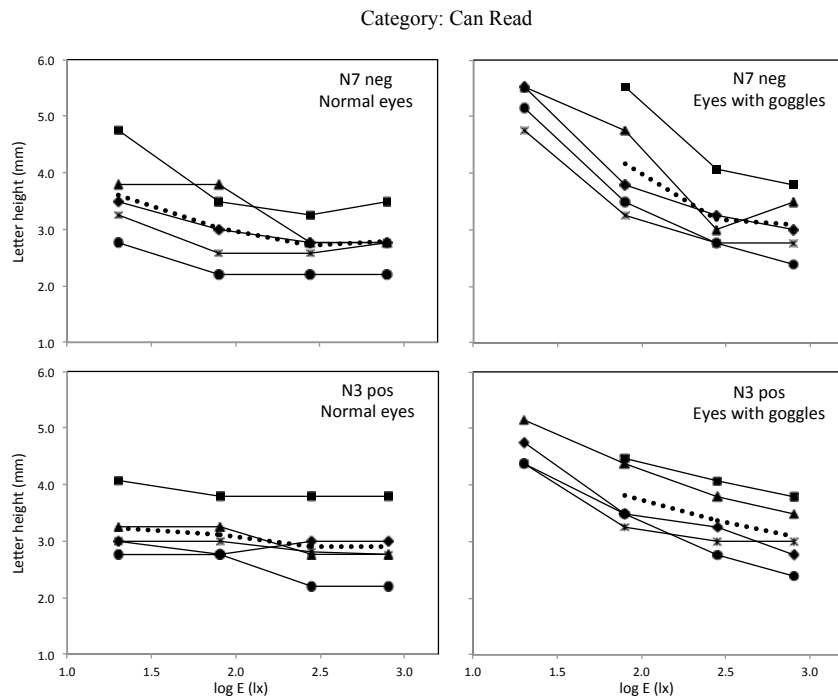

(b)

Figure 7-11 Letter height for category Difficult to Read and Can Read on N7 negative and N3 Positive backgrounds by normal eyes and eyes with goggles from 5 subjects: \blacklozenge , OB; \blacksquare , AP; \blacktriangle , PC; \bullet , ET; \times , PS. Thin solid lines, results from five subjects; thick dotted line, average.

(a) Difficult to Read; (b) Can Read.

By the same background darkness, the category Difficult to Read is reflected from the smaller letter height in the cards, as compared to the category Can Read. Both categories can reflect the readability quality in wide dimension compared to Difficult to Read and Comfortable to Read. To see the relation of each response category, the four categories of response were plotted together in the graph of same background. Figure 7-12 shows the relation of each category on N7 background of negative contrast and N3 background of positive contrast. For normal eyes the letter height increase slightly for the decreasing illuminance. But for eyes with goggles letter height increased with the decreasing illuminance. Letter height difference between the Difficult to Read and Can Read was about 1.0 mm and was maintained throughout the illuminance to show the correlation of both categories. Letter height difference between Cannot Read and Difficult to Read was not show the natural interaction here since the Cannot Read response always corresponded to the smallest letter height. The curves of Comfortable to Read also contain high variance as we saw in Figure 7-8.

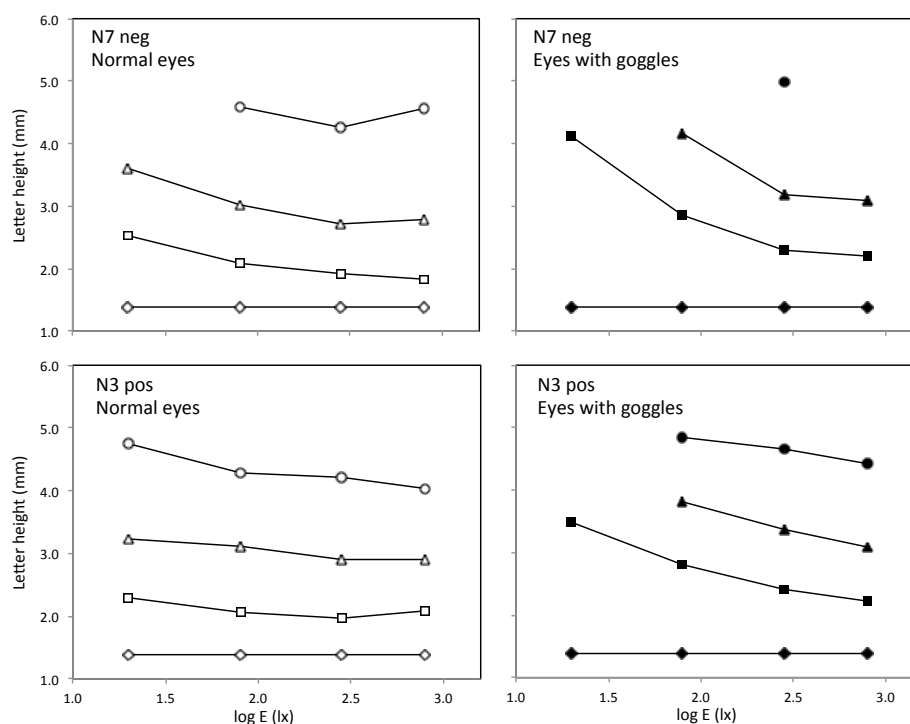

Figure 7-12 Comparison of the four response categories by normal eyes and eyes with goggles on N7 background negative contrast and N3 background positive contrast. ◇ ◆, Cannot Read; □ ■, Difficult to Read; △ ▲, Can Read; ○ ●, Comfortable to Read.

While subjects response as Can Read on their perceived image of letters in the label cards equivalent to 75-80% correct response, category Can Read will be more practical for applying to the label seeing in daily life. We select category Can Read for our further analysis. Figure 7-13 shows the letter height of each background for the category Can Read by normal eyes and eyes with goggles. Filled symbols are for negative contrast and open symbols for positive contrast. Letter heights for eyes with goggles were higher than letter heights of normal eyes in both positive and negative contrast. The low contrast label cards in N3 background of negative contrast and N7 background of positive contrast were scattered from the rest of contrast and not perceivable as Can Read for eyes with goggles in low illuminance. Letter height for low contrast cards were significantly scattered from the rest of backgrounds in the same polarity contrast. For the eyes with goggles, cards in N3 and N5 background of negative contrast were not perceivable as Can Read, compared to the only perceivable at 800 lx of N3 background with normal eyes. In positive contrast letter height of Can Read for N5, N3 and Black backgrounds were close to each other, left only background of N7 which is relatively low contrast to show the scattered result of bigger letter height.

The letter height for the eyes with goggles was substantially higher than the letter height for normal eyes of the same condition. Letter height of Can Read between each backgrounds in negative contrast was well distributed in normal eyes and eyes with goggles.

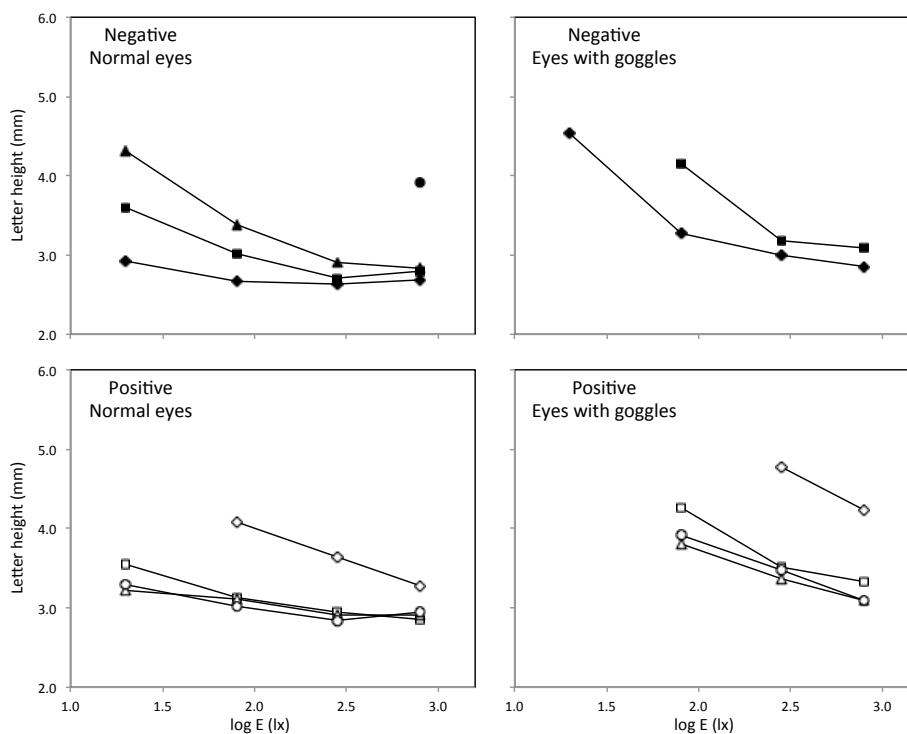

Figure 7-13 Letter height for category Can Read in different backgrounds of negative and positive contrast by normal eyes and eyes with goggles. Negative contrast backgrounds: Legends for negative contrast backgrounds: ◆, white; ■, N7; ▲, N5; ●, N3. Legends for positive contrast backgrounds: ◇, N7; □, N5; △, N3; ○, black.

7.5.2 Two-room readability experiment

The two-room readability experiment was conducted on the same label cards as used in the one-room readability experiment and for the same group of subjects. The intra-subject variance data of the two-room readability experiment is available in Appendix. The letter heights of three sessions were averaged normally. Figure 7-14 and Figure 7-15 show the letter height versus log illuminance from subject OB and PC on the label card of N7 background in negative contrast. Thin solid lines show raw data of three sessions and thick dotted lines show the average. Figure 7-14 is result experimented with normal eyes and Figure 7-15 is result with eyes with goggles. A short vertical bar on the abscissa shows the illuminance level 280 lx of the test room. Three curves did not scatter much and we can say that the average represents character of that subject. Tendency of average from both subjects in the same condition was also agreed to add confident for averaging the results of five subjects.

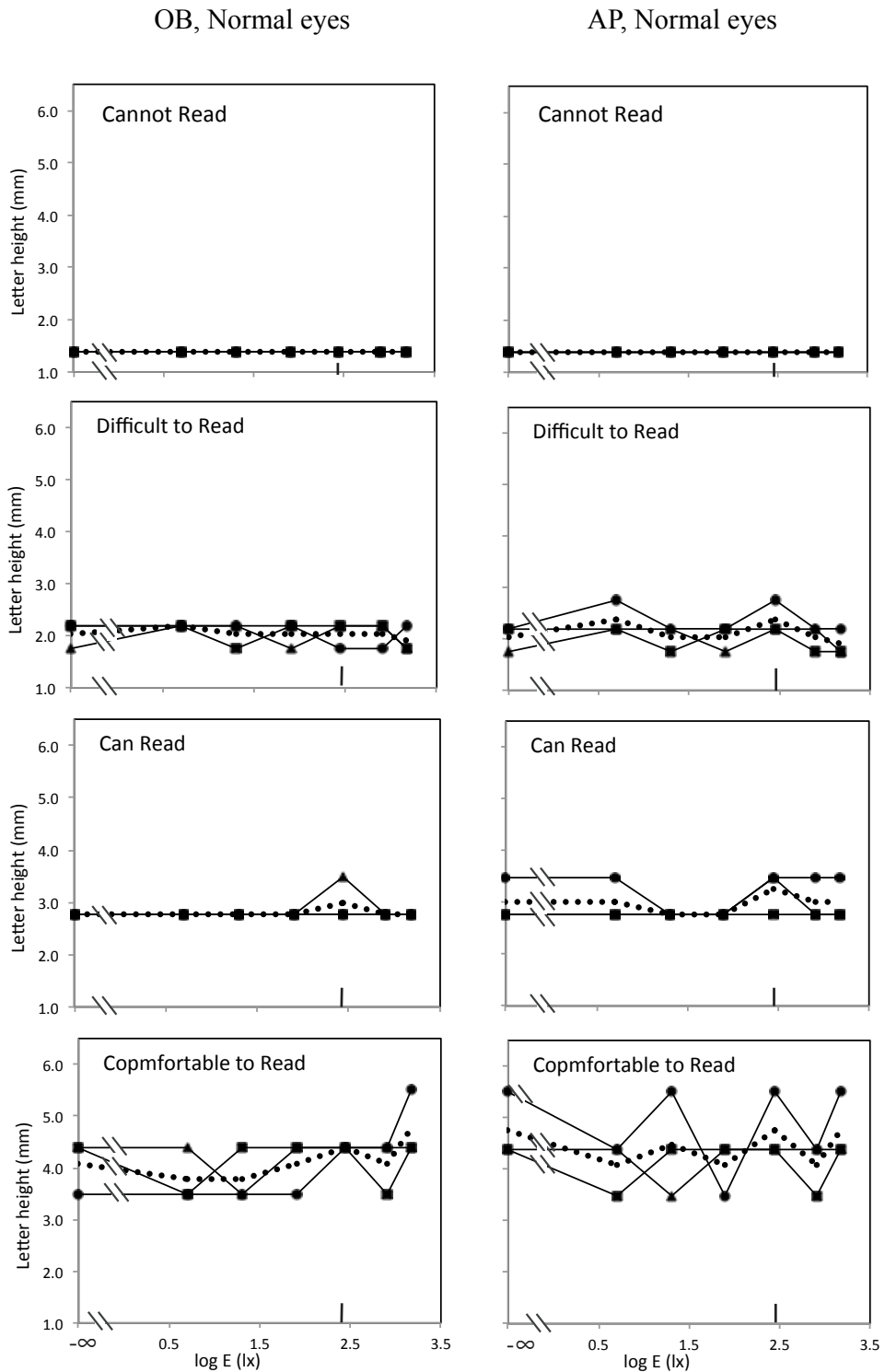

Figure 7-14 Results with normal eyes of two-room readability experiment in four categorical responses from subject OB and AP. Label card of N7 background and of negative contrast.

Thin solid lines, results from three sessions; thick dotted line, average

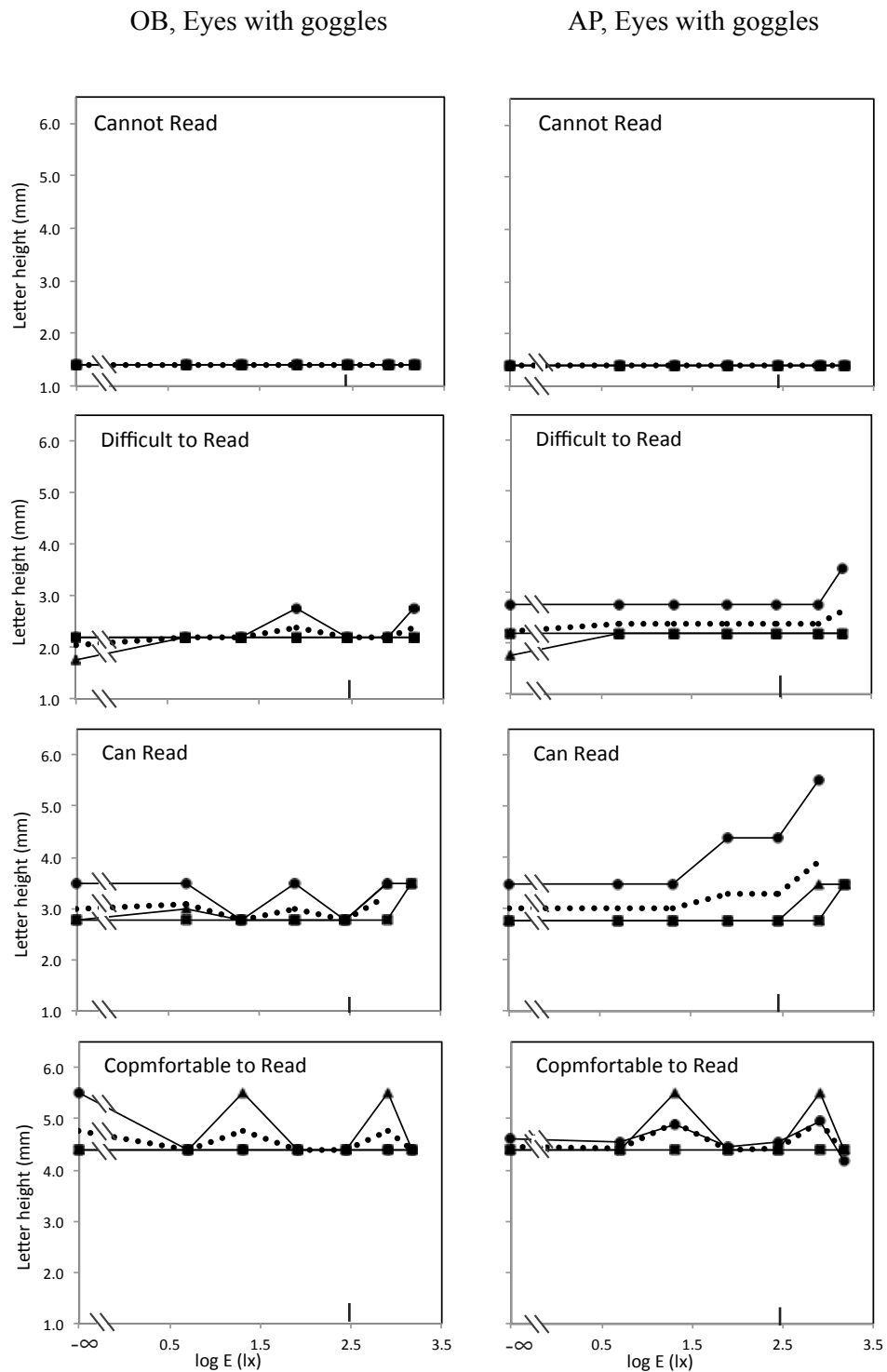

Figure 7-15 Results with eyes with goggles of two-room readability experiment in four categorical responses from subject OB and AP. Label card of N7 background and of negative contrast. Thin solid lines, results from three sessions; thick dotted line, average.

Results of five subjects by normal eyes and eyes with goggles are shown by thin solid lines for categories Difficult to Read in Figure 7-16 and category Can Read in Figure 7-17. The result from all subjects are quite conglomerate and in the same tendency in each condition and the average was taken as shown by dotted lines. The inter-subject variance data of the two-room readability experiment is available in Appendix. It is interesting to notice that the tendency of curves for the N7 background of negative contrast and N3 background of positive contrast are quite similar especially for the response category of Difficult to Read both with normal eyes and with eyes with goggles. But for the category of Can Read with eyes with goggles all the five subjects exhibited the bouncing effect at high illuminance for N3 positive label card. The letter height decreased from illuminance of 250 to 800 lx to show increase of visual performance, and went up at 1500 lx. This might be the correlation of positive contrast effect that the brightness from the white stroke on the label cards matched the discounted illuminance of goggles at around 800 lx and the perceived brightness from both room are relatively equal.

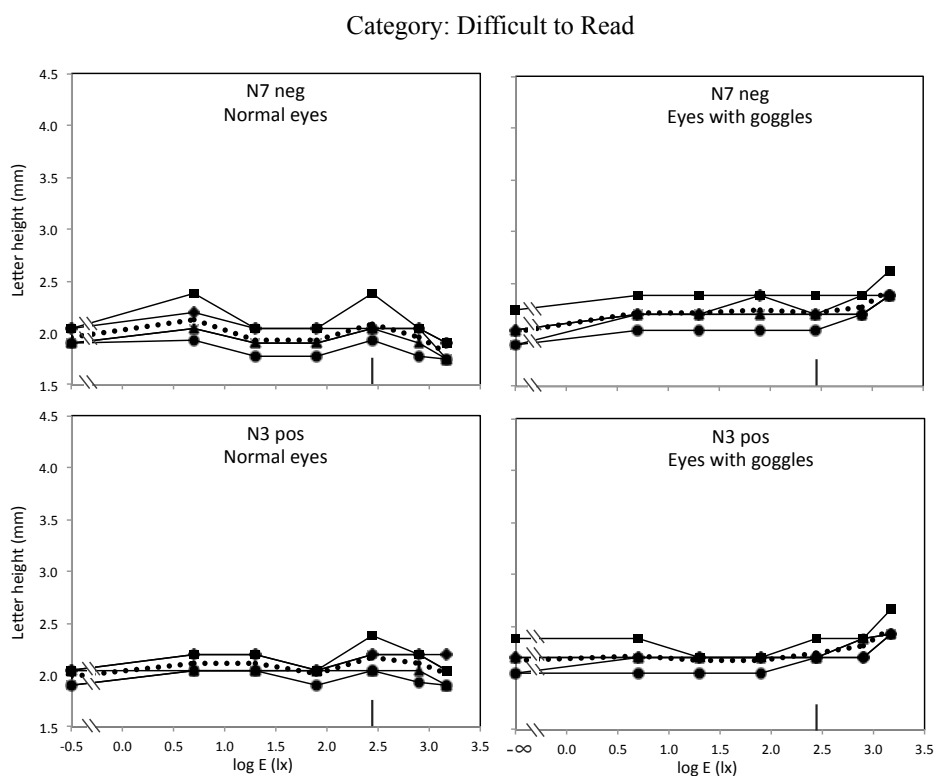

Figure 7-16 Letter height for category Difficult to Read on N7 negative and N3 Positive backgrounds by normal eyes and eyes with goggles from 5 subjects: \blacklozenge , OB; \blacksquare , AP; \blacktriangle , PC; \bullet , ET; \times , PS. Thin solid lines, results from five subjects; thick dotted line, average.

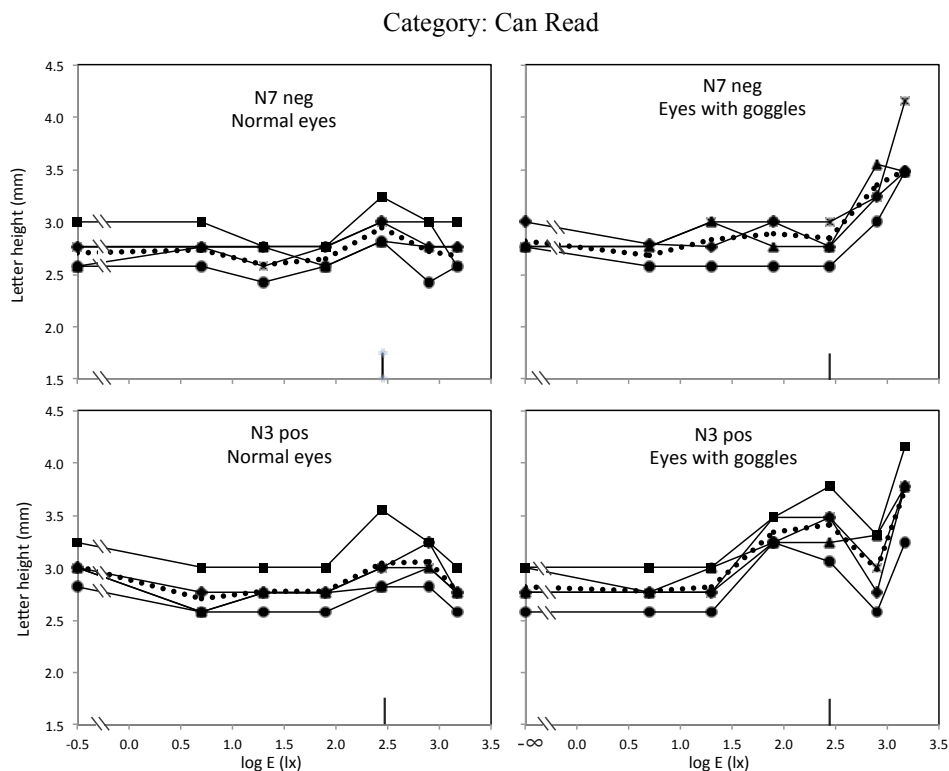

Figure 7-17 Letter height for category Can Read on N7 negative and N3 Positive backgrounds by normal eyes and eyes with goggles from 5 subjects: \blacklozenge , OB; \blacksquare , AP; \blacktriangle , PC; \bullet , ET; \times , PS.

Thin solid lines, results from five subjects; thick dotted line, average.

Figure 7-18 shows the relation of each category on N7 background of negative contrast and N3 background of positive contrast. The letter heights between Difficult to Read and Can Read were more or less 1.0 mm different for that the Can Read require bigger letter height. But the category Comfortable to Read required much bigger letter height than the Can Read, about 1.5 mm bigger than letter height for Can Read. For the two-room experiment, the high illuminance with eyes with goggles tends to give fluctuated result. It showed as the swing up or down from the smooth curves.

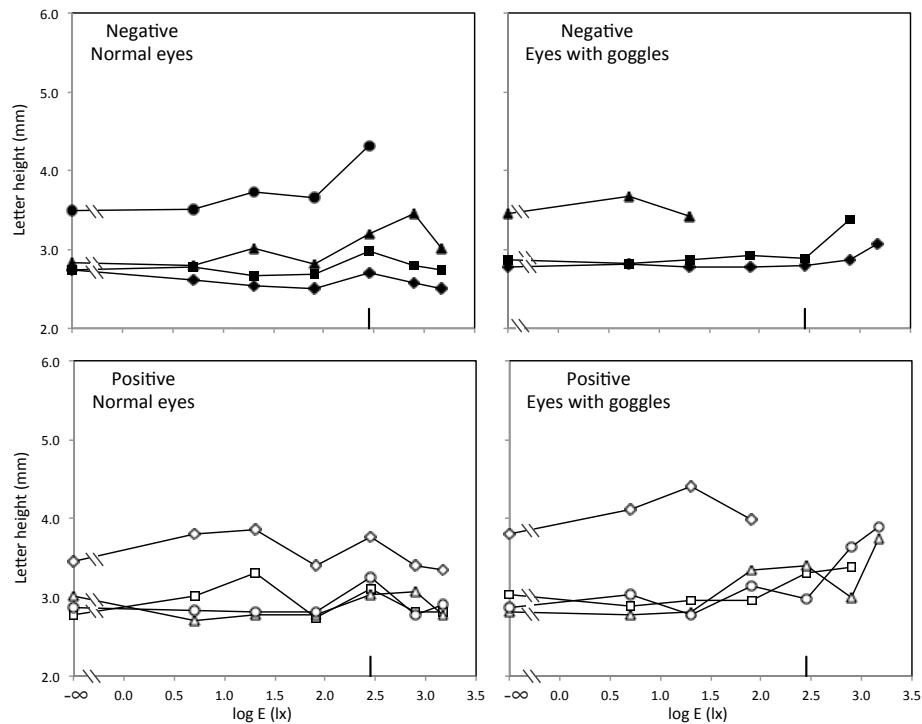

Figure 7-18 Comparison of the four response categories by normal eyes and eyes with goggles on N7 background negative contrast and N3 background positive contrast in the two-room experiment. ◇ ◆, Cannot Read; □ ■, Difficult to Read; △ ▲, Can Read; ○ ●, Comfortable to Read.

Results for Can Read category of the five subjects were averaged and shown in Figure 7-19 for each backgrounds, White, N7, N5, N3, and Black, and contrasts. We can see that the readability was most affected with goggles for the negative contrast. Subjects did not feel comfortable to read even for the largest letters available.

Letter heights for eyes with goggles were higher than letter heights of normal eyes in both positive and negative contrast. The low contrast label cards in N3 background of negative contrast and N7 background of positive contrast were scattered from the rest of contrast and not perceivable as Can Read for eyes with goggles in low illuminance. Letter height for low contrast cards were significantly scattered from the rest of backgrounds in the same polarity contrast. For the eyes with goggles, cards in N3 and N5 background of negative contrast were not perceivable as Can Read, compared to the only perceivable at 800 lx of N3 background with normal eyes. In positive contrast letter height of Can Read for N5, N3 and Black backgrounds were close to each other, left only background of N7 which is relatively low contrast to show the scattered result of bigger letter height. The letter height needed to

perceive as Can Read for dark background in negative contrast which is the low contrast stimulus was much higher compared to the equivalent positive contrast.

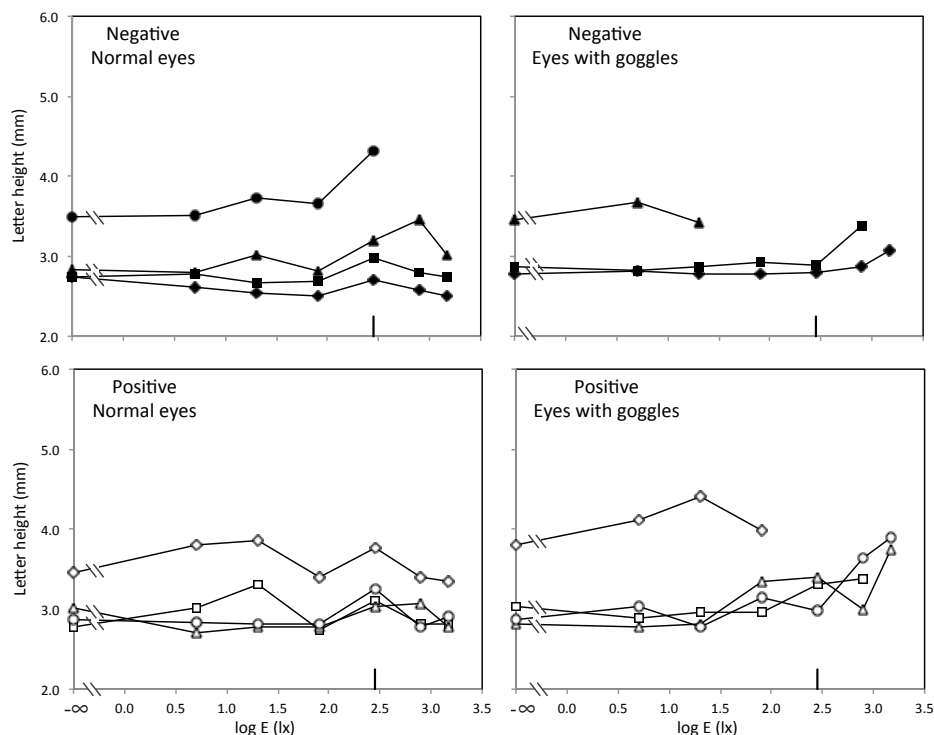

Figure 7-19 Letter height for category Can Read in different backgrounds of negative and positive contrast by normal eyes and eyes with goggles from the two-room experiment.

Legends for negative contrast backgrounds: \blacklozenge , white; \blacksquare , N7; \blacktriangle , N5; \bullet , N3. Legends for positive contrast backgrounds: \diamond , N7; \square , N5; \triangle , N3; \circ , black.

7.6 Discussion on readability experiment

We have found in supplemental experiment in Chapter VI that contrast of stimulus really affected legibility and the two-room environment could preserve the visual acuity for the eyes with goggles. In this readability experiment we want to find out the proper condition for the efficient reading of label cards. The categorical response of Can Read was selected for the judgement of readability. The result in Figure 7-13 shows the Can Read readability on eight backgrounds in the one-room and Figure 7-19 for the two-room. Each result of one-room and two-room in the same condition was plotted together in the same graph of background as shown in Figure 7-20 and Figure 7-21. Left column for normal eyes and right column for eyes with goggles. Solid lines represent result from two-room and dotted lines for one-room. Negative contrast results are in Figure 7-20 and positive contrast results are in Figure

7-21. The letter height results of one-room and two-room were directly compared by each background. There are some curves that do not show or partly show. The out of range data point or the incomplete raw data was not put to average and no data shown at that point.

Let us first look at the negative and white background case shown at the top of Figure 7-20. Letter appears black on a white background under this condition, which is common in books or newspapers that we read in our daily life. With normal eyes the letter height to assure readability of Can Read stays more or less constant whether label cards were presented in one-room or in two-room situation. Results from positive contrast showed similar tendency as from negative contrast but with some difference as seen in Figure 7-21.

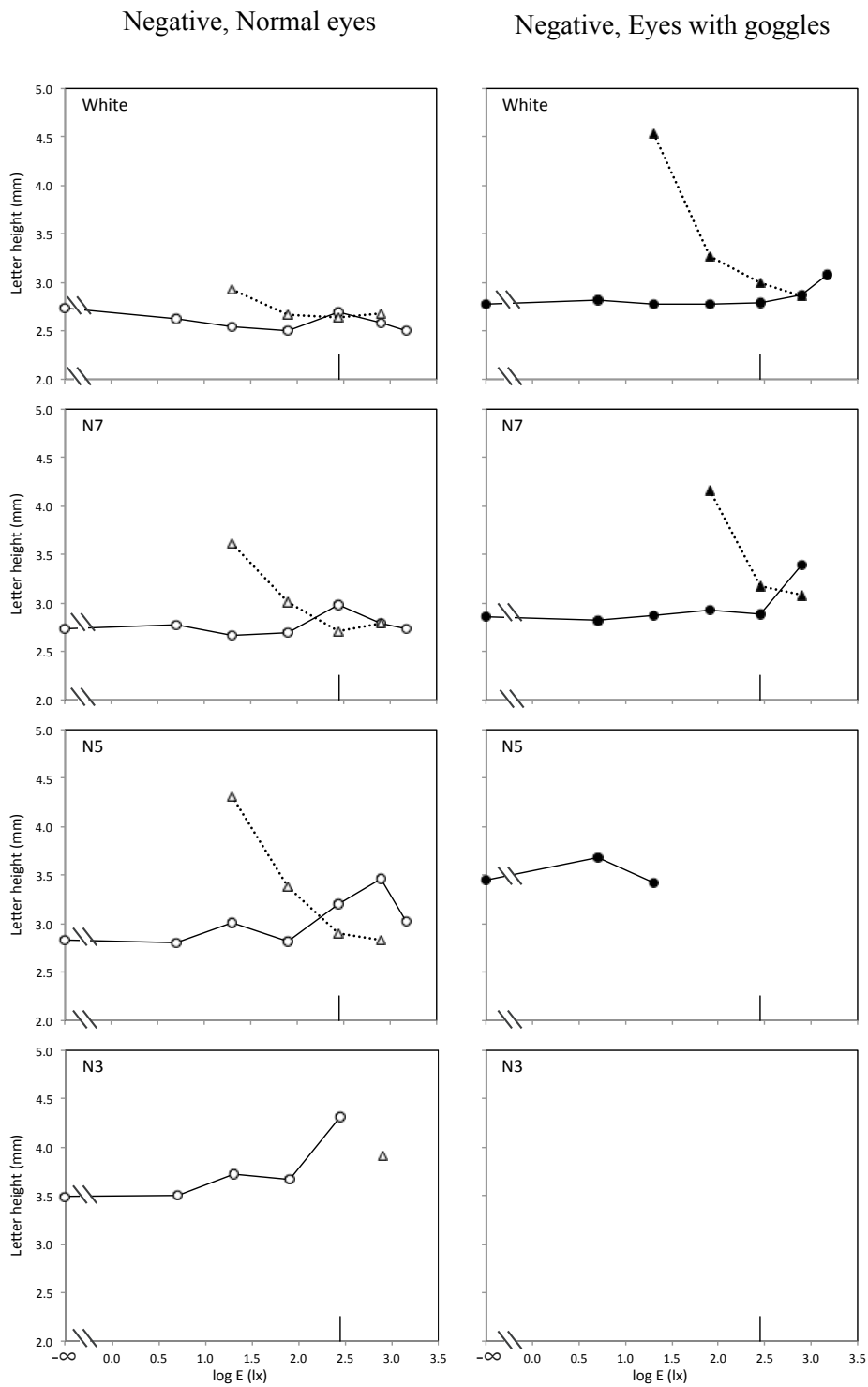

Figure 7-20 Results in letter height of negative contrast for different backgrounds in one-room and two-room in category Can Read. Solid lines, two-room; dotted lines, one-room. $\circ\Delta$, normal eyes; $\bullet\blacktriangle$, eyes with goggles.

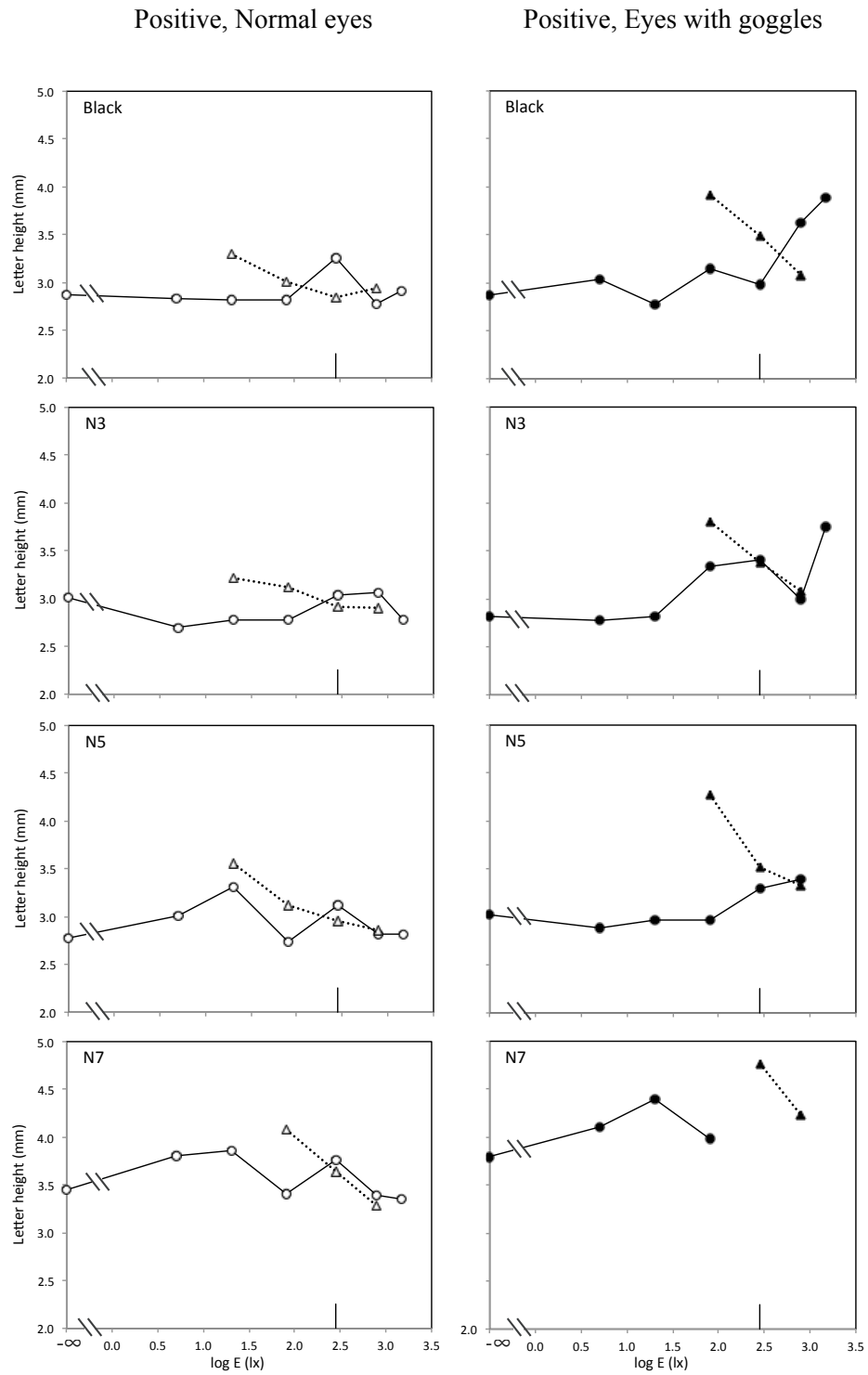

Figure 7-21 Results in letter height of positive contrast for different backgrounds in one-room and two-room in category Can Read. Solid lines, two-room; dotted lines, one-room. $\circ\Delta$, normal eyes; $\bullet\blacktriangle$, eyes with goggles.

In order to directly compare the result of one-room and two-room, the visual angle result was compared. The result in letter height of the Can Read readability on eight backgrounds in Figure 7-13 for the one-room and Figure 7-19 for the two-room were calculated into visual angle for direct comparison of legibility performance. Each result in visual angle of one-room and two-room in the same condition was plotted together in the same graph of background as shown in Figure 7-22 and Figure 7-23. Left column for normal eyes and right column for eyes with goggles. Solid lines represent result from two-room and dotted lines for one-room. Negative contrast results are in Figure 7-22 and positive contrast results are in Figure 7-23. The visual angle results of one-room and two-room were directly compared by each background.

Looking at the visual angle comparison of one-room and two-room on negative contrast in Figure 7-22, the environment light of the subject room did not affect the readability for the normal eyes. But in the case of eyes with goggles, the environment light affected notably the readability when subjects had to read label cards placed in the same subject room. Particularly when the room illuminance was reduced the visual angle had to be increased in a great amount. Eyes with goggles are very weak for the low illuminated environment. This weakness was completely removed by the illuminating system of two-rooms. Subjects could read labels almost equally as normal eyes even when the room illuminance was reduced. When the contrast of the label was reduced to N7 background the normal eyes also suffered the reduction of illumination for lower illuminance in one-room technique. The deterioration of the visual performance was much strong with eyes with goggles and label of highest letter height was not readable. But the readability remained almost same as normal eyes if labels were read in the two-room experiment. The advantage of two-room system is quite clear.

Results from positive contrast showed similar tendency as from negative contrast but with some difference as seen in Figure 7-23. Results with eyes with goggles under one-room condition show better visual performance compared with normal eyes. With background of N5 and N7, which gives low contrast of letters, subjects still could see letter with the category Can Read while they could not see with negative contrast. This might suggest that for elderly people positive contrast is better for reading. Under two-room condition the superiority of positive contrast also existed with eyes with goggles as seen for N5 and N7 backgrounds. Subjects could not respond with Can Read at high illuminance with normal eyes for these backgrounds but eyes with goggles could respond.

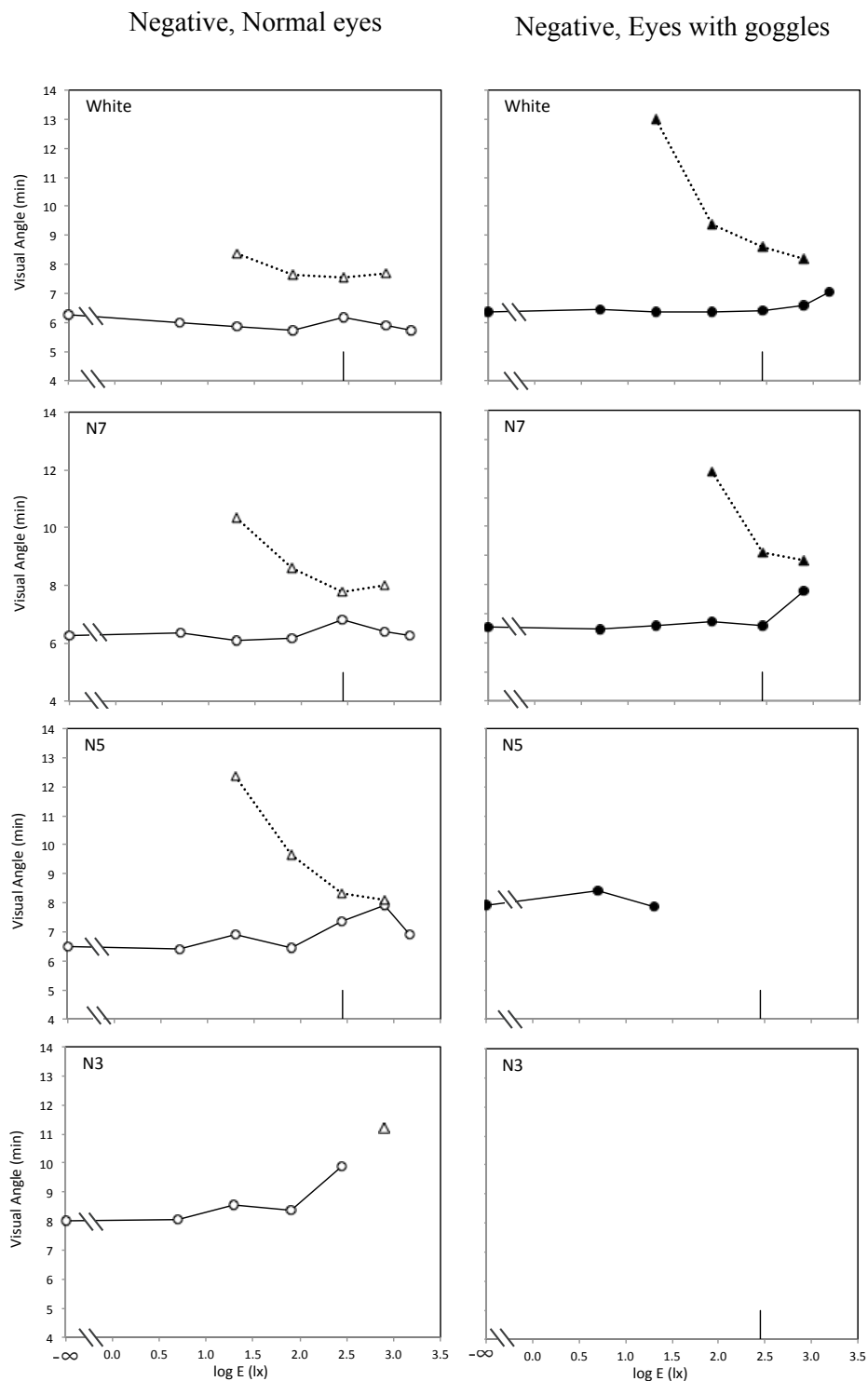

Figure 7-22 Visual angle plotted for different backgrounds of negative contrast in one-room and two-room in category Can Read. Solid lines, two-room; dotted lines, one-room. ○△, normal eyes; ●▲, eyes with goggles.

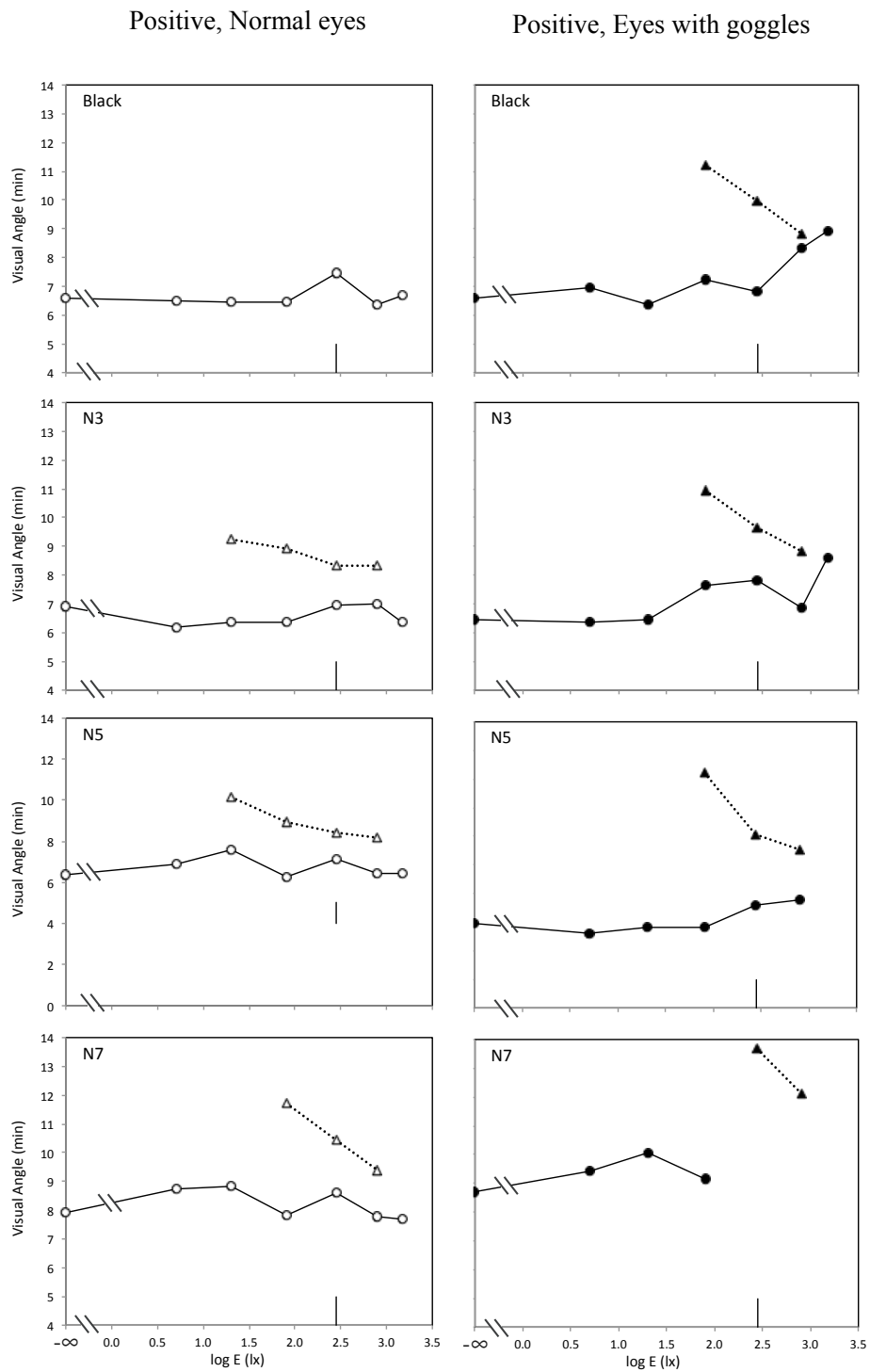

Figure 7-23 Visual angle plotted for different backgrounds of positive contrast in one-room and two-room in category Can Read. Solid lines, two-room; dotted lines, one-room. ○△, normal eyes; ●▲, eyes with goggles.

To compare results of different conditions in Figure 7-22 and Figure 7-23 the visual angles at the room illuminance 80 lx were read out and plotted in Figure 7-24 and. The abscissa shows the contrast of letters against the background and the ordinate the letter height. Open symbols show results of normal eyes and filled symbols eyes with goggles. Dotted lines are for one-room and solid lines for two-rooms. It is clearly seen that by employing the two-room system the letter height for Can Read improves significantly when subjects wore the cataract experiencing goggles. The evidence is particularly significant for positive contrast. The two room system should benefit elderly people for reading labels.

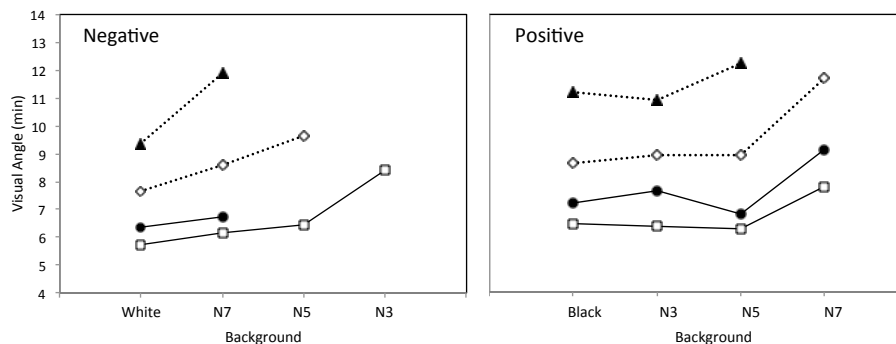

Figure 7-24 Visual angles for category Can Read at room illuminance 80 lx for each background in positive and negative contrast. Solid line, two-room; dotted line, one-room. Open symbols, normal eyes; filled symbols, eyes with goggles. □, two-room with normal eyes; ●, two-room with eyes with goggles; ◇, one-room with normal eyes; ▲, one-room with eyes with goggles.

CHAPTER VIII

GENERAL DISCUSSION AND CONCLUSION

8.1 General discussion

We focus our study on the legibility of printed small-sized Thai characters that are suitable for elderly. The survey of products label found that the letter height for headline in the label was ranging from 1.25 to 2.0 mm and the body text was about 0.95 to 1.5 mm. If the products label were to be readable by the young and elderly at the distance of 120 cm as in our survey simulation, the letter height of the label text must have overcome the minimal legible size under certain condition. The use of cataract experiencing goggles throughout the study intended to investigate the cataract vision simulated by the goggles to represent the elderly vision in general. The normal eyes mean the vision from young subjects that see the stimulus without wearing the goggles. So the terms young eyes - normal eyes and the terms elderly vision – goggled vision are interchangeable in our scope.

We have investigated the normal illumination system as one-room experiment to find the legibility of normal eyes and eyes with goggles under the range of illuminance from 20 to 800 lx by the use of constant stimuli method. The result obtained for 50% seeing was finally extrapolated into 100% seeing by the use of probability-of-seeing curve transfer function. We found that the legibility of eyes with goggles was substantially reduced especially at the low illuminance. But at high illuminance the goggled vision was not much different compared to the normal eyes. Negative contrast and positive contrast chart exhibited close result, with a little bit smaller letter height for negative contrast. Since there were only high contrast charts investigated in the one-room experiment, we added more backgrounds to the charts for the supplemental one-room experiment and used adjustment method to acquire the result. The contrasts of chart really affected the legibility of normal eyes and eyes with goggles as we summarize in Table 8-1.

Table 8-1 Letter height for legibility of different backgrounds and ratio of eyes with goggles by normal eyes.

Illuminance (lx)	Letter height (mm)						Ratio Eyes with goggles / Normal eyes		
	White background (high contrast)		N5 background (contrast -1)		N4 background (contrast -2)		White	N5	N4
	Normal eyes	Eyes with goggles	Normal eyes	Eyes with goggles	Normal eyes	Eyes with goggles			
20	3.28	5.44	4.31	11.16	5.53		1.66	2.59	0.00
80	2.77	3.95	3.24	7.06	3.92	11.68	1.43	2.18	2.98
280	2.48	3.22	2.74	5.12	3.07	7.32	1.30	1.87	2.39
800	2.37	2.80	2.43	4.00	2.66	5.93	1.18	1.65	2.23
1500	2.29	2.71	2.26	3.54	2.42	5.07	1.18	1.57	2.09

From the table we can see that the actual letter height of around 1-2 mm was not big enough for any criteria from our study, no matter of normal eyes or highest illuminance. If we want the products label to really friendly to customers especially the elderly, the letter height for the label must be enlarged.

To get the idea of how big actual letter size in label compare to the minimal legible size needed in certain condition for normal eyes and eyes with goggles, we made three sample labels in actual sizes for direct comparison as shown in Fig. 8-1. The three labels were composed with TF Srivichai font in negative contrast with black text on white background for high contrast label. The general product label (a) composed with the same letter size as found in our survey that is the letter height of 1.5 mm equivalent to 10.7 point. The conditions for simulating the sample labels are based on the viewing distance of 120 cm and vertical plane illuminance of 280 lx. The label with minimal legible letter size suitable for young people (b) composed with letter height of 2.48 mm equivalent to 17.5 point. The label suitable for elderly (c) composed with letter height of 3.22 mm equivalent to 22.8 point.

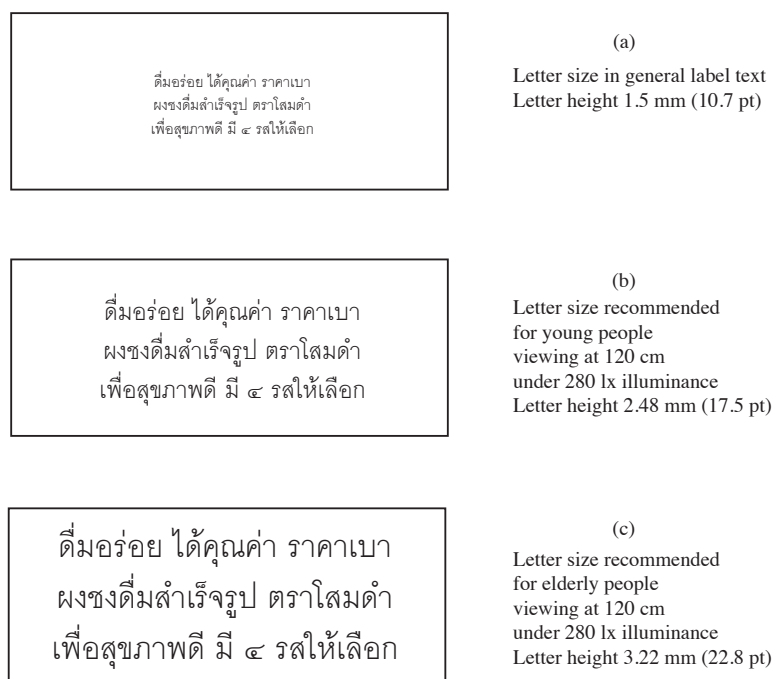

Fig. 8-1 Sample in actual size demonstrating the letter size of label text in general (a), recommended size for normal eyes or young people (b), and recommended size for cataract eyes or elderly people (c) for viewing distance of 120 cm under 280 lx illuminance.

The letter height comparison of normal eyes and eyes with goggles in the same background under each illuminance can be put into ratio for convenient reference. Each background constituted a ratio that can be referred to even with different experimental method such as constant stimuli and adjustment. The ratio of eyes with goggles by normal eyes was then converted to log ratio and plotted for log illuminance in Fig. 8-2 for three backgrounds, white, N5, and N4. All the curves show straight lines and we obtained the regression lines. They are summarized in Table 8-2.

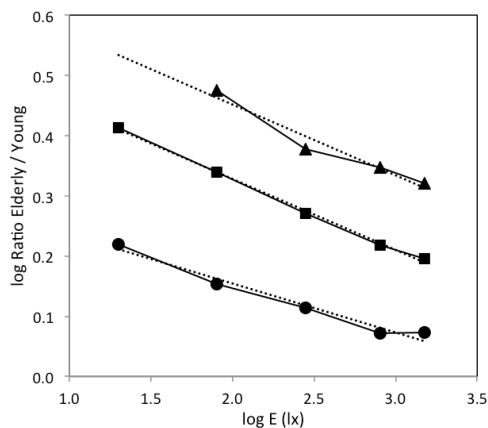

Fig. 8-2 Log ratio of eyes with goggles by normal eyes for letter height on different backgrounds. Solid lines, log ratio curve; dotted lines, regression line. ●, white background; ■, N5 background; ▲, N4 background.

The three backgrounds mentioned above are quite general as the representative of contrast on products label. The equations in Table 8-2 can be used to obtain letter heights suitable for cataract eyes of elderly people based on the letter height of normal eyes from young people.

Table 8-2 Equations to obtain proper letter size for elderly people.

Background	Regression equation
White	$\log \text{Ratio}_{\text{white}} = -0.08 \log E + 0.3169$
N5	$\log \text{Ratio}_{\text{N5}} = -0.12 \log E + 0.5636$
N4	$\log \text{Ratio}_{\text{N4}} = -0.12 \log E + 0.6864$
$\text{Ratio} = \text{LH}_{\text{goggles}} / \text{LH}_{\text{normal}}$	

The two-room illumination environment that we proposed for improving the legibility of elderly has been confirmed in the result of two-room experiment, two-room supplemental experiment, and two-room readability experiment. The legibility with eyes with goggles was preserved to nearly the legibility of normal eyes when the subject room illuminance was not higher than the test room illuminance. The benefit shown in the result from high contrast letter chart was not significant,

until we experimented with lower contrasts to show the distinction of legibility preserve benefit from the two-room system. The visual angle comparison between one-room and two-room for backgrounds of White, N5 and N4 shown in Fig. 6-15 show the higher deterioration of eyes with goggles over normal eyes, but the two-room system can highly benefit from the low contrast by preserving more visual angle from the point of equi-illuminance to the low illuminance.

The two-room readability experiment on label cards with different backgrounds was clearly confirmed the advantage of two-room illumination system. It preserved the readability of eyes with goggles to be as close as the normal eyes. Fig. 8-3 shows the visual angle of category Can Read from negative contrast label cards of background white, N7 and N5 under illuminance of 80 and 280 lx. The dotted lines are one-room results and solid lines are two-room result. Open symbols are normal eyes and filled symbols are eyes with goggles. The readability of one-room was much deteriorated with eyes with goggles but for two-room the readability was well preserved. Visual angle of the two-room also smaller than that of the one-room to show the superiority of readability under 80 and 280 lx illuminance, which are the most common illuminance in household. Concerning the 80 and 280 lx as the common illuminance in Thai household, the two-room illumination system was clearly show the benefit of enhancing readability over the one-room or normal lighting system.

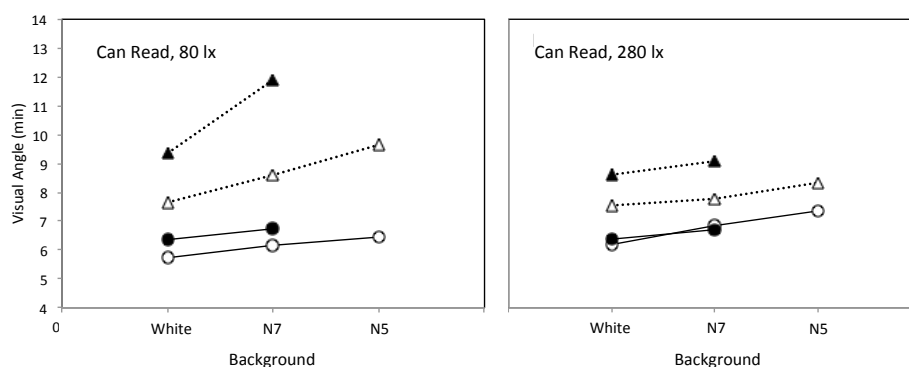

Fig. 8-3 Visual angles of the readability in category Can Read under illuminance of 80 and 280 lx by different backgrounds of label cards in negative contrast. solid lines, two-room; dotted lines, one-room. open symbols, normal eyes; filled symbols, eyes with goggles.

The above finding simply confirms the superiority of two-room illumination environment over the one-room or the normal lighting. The principle of the two-room system could be applied to many illumination settings for the friendliness to the

elderly. Illumination in supermarkets can be modified for elderly people. Of course it is firstly important to increase label letters but the illumination system can be improved for elderly people. We recommend to use spot lights to products to increase illuminance on them and to reduce illuminance coming from ceiling. In residence we can introduce a similar illumination. Spot lights should be very effective. Another example might be the controlled lighting setting for museum and gallery. They are the places for fine appreciation of display image and objects. The label or caption text should be carefully illuminated with enough brightness for the efficiency of readability and at the same time not to disturb the display items. The indoor or outdoor walk way with reduced ceiling light but added floor illuminance or the reflected illuminance to avoid the scattering of light into the eyes of elderly. In general the light that causes scattering into the eyes should be avoided by using the direction controlled lighting or modify the environment that prevents the scattering into the eyes of the elderly.

8.2 Conclusion

The study has fulfilled the proposed two objectives.

The first objective stated: To investigate minimal font size, font type, polarity contrast, and illumination level that affect the legibility of elderly on printed small-size Thai characters by means of cataract simulating goggles, the study has completely fulfilled the area proposed. The findings are: minimal font sizes under each illuminance for normal eyes and eyes with goggles in different backgrounds. The negative contrast chart gave a little bit better legibility than positive contrast. The three fonts investigated showed indifferent result. The eyes with goggles gave worse legibility than normal eyes especially in the low contrast, but the legibility was improved by the use of two-room system.

The second objective stated: To investigate illumination environment suitability for elderly. We have proved that the proposed two-room illumination environment was superior over the one-room illumination environment or the normal lighting. We found at least two advantages of two-room system. Firstly it preserves the legibility of eyes with goggles to almost the same as normal eyes when the subject room illuminance is not higher than the test room illuminance. Secondly it preserves the legibility of eyes with goggles on low contrast stimulus to nearly as good as the legibility of normal eyes. The application on the principle of two-room illumination system could highly benefit for the elderly visual performance and for their safety.

8.3 Suggestion for future research

Our suggestion for future research could be for the ongoing research and the diversifying research.

For the ongoing research, the penetration experiment with the real elderly might be considered to see the agreement or different of our result to the result of the real elderly. The function for transferring result from young people to elderly people might be further update for the most accurate.

For the diversifying research, the experiment in the similar way might be adopted to experiment with the regional language letters that use similar lettering system but with different font faces. Basically our result could be adopted to other language of similar system, but the confirmation study should be done for the confident of proposing standard in each language.

REFERENCES

- [1] United States Census Bureau. U.S. Department of Commerce, International Programs [Online] 2013. Available from http://www.nationmaster.com/graph/peo_eld_pop_eld_pop_by_reg_per_of_eld_pop_by_cou-elderly-population-region-percentage-country[2013, April]
- [2] Aging population in Asia: experience of Japan, Thailand and China, JICA, Institute for International Cooperation, Japan International Cooperation Agency (2007).
- [3] Population statistics document 2012 Table 2-15, National Institute of Population and Security Research, Japan (2012).
- [4] Said, F. S., and Weale, R. A. The variation with age of the spectral transmissivity of the living human crystalline lens. Gerontologia 3 (1959):213-231. Cited in Katemake, P., and Ikeda, M. Visual Psychophysics Basic and Applied. Bangkok : Aksarapipat, 2012.
- [5] Owsley, C., Sekuler, R., and Siemen, D. Contrast sensitivity throughout adulthood. Vision Research 23 (1983):689-699.
- [6] Elloit, D. B., and Situ, P. Visual acuity versus letter contrast sensitivity in early cataract. Vision Research 38 (1998):2047-2052.
- [7] Arditi, A. Enhancing the visual environment for older and visually impaired persons. Alzheimer's Care Quarterly 64 (2005):294-299
- [8] United States Census Bureau. U.S. Department of Commerce, International Programs [Online] 2013. Available from : http://www.nationmaster.com/country/th-thailand/Age-_distribution[2013, January]
- [9] Funakawa, M. Psychophysical experiment on the legibility of letters. Journal of Illumination Engineering Institute of Japan 84 (2000):785-792 [in Japanese]
- [10] Ayama, M., Ujike, H., Iwai, W., Funakawa, M., and Okajima, K. Effects of contrast and character size upon legibility of Japanese text stimuli presented on visual display terminal. Optical Review 14 (2007): 48-56.
- [11] Guidelines for the elderly and people with disabilities —Visual signs and displays—Estimation of minimum legible size for a Japanese single character. Japanese Industrial Standard, JIS S 0032 (2003)
- [12] Obama, T., Uozato, H., Terauchi, H., and Matsuoka, H. A qualitative determination of senile cataract experiencing filters. Journal of Color Science Association of Japan 28 (2004):245-252. [in Japanese]

- [13] Ikeda, M., and Obama, T. Desaturation of color by environment light in cataract eyes. Color Research and Application 33 (2008):142-147.
- [14] Ikeda, M., Pungrassamee, P., and Obama, T. Size effect of color patches for their color appearance with foggy goggles simulating cloudy crystalline lens of elderly people. Color Research and Application 34 (2009):351-358.
- [15] Ministry of Health and Welfare. Investigation report according to social care course of medical treatment (1996)
- [16] Ikeda, M., and Fukumura, S. Formation of a recognized visual space of illumination with increasing initial visual information. J. Illumi. Engng. Inst. Jpn 79 (1995):392-399. [in Japanese]
- [17] File:Snellen chart.svg. Wikipedia The Free Encyclopedia. [Online] 2013, Available from : http://en.wikipedia.org/wiki/File:Snellen_chart.svg[2013, February]
- [18] Zhang, J. Y., Zhang, T., Xue, F., Liu, L., and Yu, C. Legibility variations of Chinese characters and implication for visual acuity measurement in Chinese reading population. Ophthalmology & Visual Science 48 (2007):2383-2390.
- [19] Domey, R. G., McFaland, R. A., and Chadwick, E., Threshold and rate of dark adaptation as a function of age and time, Human Factors 2 (1960):109-119. Cited in Katemake, P., and Ikeda, M. Visual Psychophysics Basic and Applied. Bangkok : Aksarapipat, 2012.
- [20] Valberg, A., and Fosse, P. Binocular contrast inhibition in subject with age related macular degeneration. Journal of Optical Society of America 19 (2002):223-228. Cited in Valberg, A. Light Vision Color. West Sussex, UK:John Wiley & Sons, 2005.
- [21] Shlaer, S. The relation between visual acuity and illumination. Journal of General Physiology. 21 (1937):165-188. Cited in Katemake, P., and Ikeda, M. Visual Psychophysics Basic and Applied. Bangkok : Aksarapipat, 2012.
- [22] Obama, T. Goggles transmittance curve. 14 February 2013.
- [23] Wongsompipatana, P., Ikeda, M., and Katemake, P. Equivalent lightness of elderly investigated by cataract experiencing goggles. Color Research and Application [Online]. 2011. Available from : <http://onlinelibrary.wiley.com/doi/10.1002/col.20737/pdf>[2013,February]
- [24] Katemake, P., and Ikeda, M. Visual Psychophysics Basic and Applied. Bangkok : Aksarapipat, 2012.

- [25] Ferris F. L., Kassoff A., and Bresnick G.H., New visual acuity charts for clinical research. *American Journal of Ophthalmology*. 94 (1982):91–96.
- [26] Eye math. Craig Blackwell MD. *Ophthalmology* [Online] 2013, Available from : <http://www.blackwelleyesight.com/eye-math/> [2013, January]

APPENDIX

2. Variance of two-room experiment

Two-room experiment

Normal eyes

TF Srivichai Negative

E (lx)	Intra-subject					Inter-subject
	ET	PP	PS	PW	SN	
0	0.15	0.13	0.10	0.16	0.60	0.51
5	0.23	0.17	0.67	0.19	0.53	0.25
20	0.34	0.16	0.14	0.85	0.43	0.27
80	0.30	0.35	0.10	0.93	0.60	0.30
280	0.35	0.63	0.14	0.07	0.07	0.08
800	0.17	0.16	0.05	0.22	0.08	0.10
1500	0.11	0.09	0.24	0.15	0.51	0.21

Eyes with goggles

TF Srivichai Negative

E (lx)	Intra-subject					Inter-subject
	ET	PP	PS	PW	SN	
0	0.83	0.20	0.42	0.10	0.17	0.65
5	0.31	0.06	0.17	0.28	0.30	0.30
20	0.58	0.14	0.06	0.10	0.46	0.35
80	0.28	0.32	0.11	0.29	0.43	0.34
280	0.09	0.11	0.13	0.39	0.62	0.17
800	1.60	0.37	0.17	0.11	0.10	0.69
1500	0.86	0.16	0.41	0.19	0.62	1.20

TF Srivichai Positive

E (lx)	Intra-subject					Inter-subject
	ET	PP	PS	PW	SN	
0	0.86	0.25	0.15	0.46	0.99	0.60
5	1.14	0.30	0.08	0.22	0.08	0.62
20	0.98	0.46	0.95	0.14	0.28	0.45
80	1.02	0.07	0.06	0.11	0.36	0.62
280	0.60	0.08	0.03	0.21	0.12	0.32
800	0.60	0.45	0.50	0.07	0.43	0.10
1500	0.49	0.12	0.81	0.32	0.39	0.08

TF Srivichai Positive

E (lx)	Intra-subject					Inter-subject
	ET	PP	PS	PW	SN	
0	0.76	0.06	0.36	0.04	0.16	0.45
5	0.83	0.12	0.42	0.47	0.10	0.35
20	1.55	0.55	0.26	0.80	0.05	0.54
80	0.44	0.16	0.24	0.14	0.48	0.19
280	1.56	0.23	0.29	0.52	0.46	0.57
800	2.41	0.14	0.01	0.19	0.81	0.78
1500	1.37	0.77	0.09	0.56	1.28	0.66

(Variance based on line number 1-16)

3. Variance of supplemental experiment

3.1 Variance of supplemental one-room experiment

Supplemental one-room experiment

Normal eyes

N4 background

E (lx)	Intra-subject				Inter-subject
	PS	SS	BW	PC	
20	1.21	0.73	1.08	0.30	0.27
80	3.18	1.34	1.86	1.01	0.26
280	1.28	1.14	2.07	0.16	0.38
800	1.29	0.62	0.90	0.30	0.88
1500	1.56	0.19	1.34	0.96	1.44

Eyes with goggles

N4 background

E (lx)	Intra-subject				Inter-subject
	PS	SS	BW	PC	
20	0.00	0.00	0.00	0.00	0.00
80	1.96	0.94	0.22	0.25	0.71
280	0.75	0.34	2.79	0.94	0.86
800	0.89	0.67	2.08	0.21	1.22
1500	1.27	1.14	0.78	0.79	2.01

N5 background

E (lx)	Intra-subject				Inter-subject
	PS	SS	BW	PC	
20	1.17	1.34	1.80	0.47	0.37
80	0.63	0.93	1.91	0.61	0.31
280	1.21	0.95	1.18	0.27	0.54
800	1.43	0.66	1.07	0.57	1.10
1500	1.60	0.04	1.45	0.34	1.36

N5 background

E (lx)	Intra-subject				Inter-subject
	PS	SS	BW	PC	
20	0.40	1.29	1.11	0.10	1.45
80	1.00	0.49	1.32	0.34	0.30
280	0.69	0.62	1.39	0.66	0.45
800	0.60	1.11	1.67	0.17	0.67
1500	2.16	1.07	1.00	0.28	1.38

White background

E (lx)	Intra-subject				Inter-subject
	PS	SS	BW	PC	
20	0.69	0.28	0.10	0.43	1.31
80	0.78	0.73	0.07	0.56	1.79
280	0.35	0.19	0.11	0.61	1.88
800	0.79	0.00	0.16	0.34	2.30
1500	0.68	0.04	0.17	0.25	1.86

White background

E (lx)	Intra-subject				Inter-subject
	PS	SS	BW	PC	
20	0.66	0.18	0.93	0.44	0.42
80	0.54	1.01	0.39	0.57	0.11
280	0.28	0.45	0.25	0.94	0.95
800	0.36	0.06	0.72	0.77	2.74
1500	1.00	0.29	1.04	0.47	3.79

(Variance based on line number 1-24)

3.2 Variance of supplemental two-room experiment

Supplemental two-room experiment

Normal eyes

N4 background

E (lx)	Intra-subject				Inter-subject
	PS	SS	BW	PC	
0	0.80	0.30	0.45	0.18	0.64
5	0.08	0.30	0.68	0.20	0.37
20	0.30	0.58	0.58	0.18	0.44
80	0.00	0.33	1.88	0.20	0.24
280	0.00	0.43	0.80	0.33	0.54
800	0.18	0.83	0.43	0.50	0.62
1500	0.50	1.20	0.38	0.30	0.85

Eyes with goggles

N4 background

E (lx)	Intra-subject				Inter-subject
	PS	SS	BW	PC	
0	1.68	0.25	0.30	0.25	0.38
5	0.80	0.50	0.30	0.08	0.20
20	0.30	1.55	0.25	0.13	0.22
80	0.50	2.45	1.18	0.30	0.75
280	0.30	1.70	0.20	0.30	2.71
800	0.20	0.30	0.20	0.20	0.14
1500	0.00	0.00	0.00	0.00	0.00

N5 background

E (lx)	Intra-subject				Inter-subject
	PS	SS	BW	PC	
0	0.33	0.30	0.93	0.18	0.24
5	0.18	0.05	0.58	0.08	0.11
20	0.43	0.08	0.20	0.43	0.22
80	0.50	0.00	0.30	0.18	0.08
280	0.13	0.05	0.20	0.18	0.10
800	0.05	0.18	0.33	0.20	0.08
1500	0.13	0.00	0.63	0.08	0.28

N5 background

E (lx)	Intra-subject				Inter-subject
	PS	SS	BW	PC	
0	0.33	1.55	0.93	1.00	0.43
5	0.08	1.30	1.70	0.58	0.51
20	0.20	0.88	1.55	0.63	0.42
80	0.30	1.30	0.70	0.13	0.47
280	0.43	0.93	1.13	0.33	1.48
800	0.68	2.50	0.00	0.75	2.20
1500	0.00	0.20	0.00	0.00	0.23

White background

E (lx)	Intra-subject				Inter-subject
	PS	SS	BW	PC	
0	0.30	0.30	2.57	0.18	0.14
5	0.25	0.25	2.18	0.13	0.24
20	0.08	0.30	2.30	0.08	0.22
80	0.08	0.20	1.80	0.18	0.15
280	0.08	0.38	1.58	0.13	0.12
800	0.00	0.13	1.18	0.05	0.09
1500	0.05	0.08	0.08	0.05	0.04

White background

E (lx)	Intra-subject				Inter-subject
	PS	SS	BW	PC	
0	0.33	0.50	2.07	0.18	0.15
5	0.13	0.80	1.68	0.13	0.07
20	0.08	1.05	0.56	0.08	0.11
80	0.33	1.70	0.68	0.08	0.17
280	0.18	0.70	0.68	0.05	0.22
800	0.25	0.30	2.68	0.45	0.34
1500	0.58	0.80	1.30	0.05	0.86

(Variance based on line number 1-24)

4. Variance of readability experiment

4.1 Variance of readability one-room experiment

Readability one-room experiment

Difficult to Read, Negative contrast

Normal eyes

NW-n background

E (lx)	Intra-subject					Inter-subject
	AR	ET	OB	PC	PS	
20	0.00	0.00	0.33	0.00	0.00	0.02
80	0.00	0.33	0.33	0.33	0.33	0.02
280	0.33	0.00	0.33	0.00	0.33	0.03
800	0.33	0.00	0.33	0.33	0.33	0.02

N7-n background

E (lx)	Intra-subject					Inter-subject
	AR	ET	OB	PC	PS	
20	0.00	0.33	0.33	0.00	0.33	0.03
80	0.00	0.33	0.33	0.00	0.33	0.03
280	0.33	0.33	0.33	0.33	0.33	0.00
800	0.33	0.33	0.00	0.33	0.33	0.02

N5-n background

E (lx)	Intra-subject					Inter-subject
	AR	ET	OB	PC	PS	
20	0.33	0.33	1.00	0.00	0.00	0.17
80	0.33	0.33	0.33	0.00	0.00	0.03
280	0.33	0.00	0.33	0.00	0.33	0.03
800	0.33	0.00	0.33	0.33	0.33	0.02

N3-n background

E (lx)	Intra-subject					Inter-subject
	AR	ET	OB	PC	PS	
20	0.33	0.33	0.33	0.00	0.00	0.03
80	0.00	0.33	0.33	0.00	0.00	0.03
280	0.33	0.00	0.33	0.00	0.00	0.03
800	1.00	0.00	0.00	0.00	0.33	0.19

Eyes with goggles

NW-n background

E (lx)	Intra-subject					Inter-subject
	AR	ET	OB	PC	PS	
20	0.33	0.00	0.33	0.00	0.00	0.03
80	0.33	0.00	0.33	0.33	0.33	0.02
280	0.33	0.00	0.33	0.33	0.33	0.02
800	0.00	0.33	0.33	0.33	0.33	0.02

N7-n background

E (lx)	Intra-subject					Inter-subject
	AR	ET	OB	PC	PS	
20	0.00	0.33	1.00	0.33	0.33	0.13
80	0.33	0.33	1.00	0.00	0.33	0.13
280	0.33	0.33	0.33	0.00	0.33	0.02
800	0.00	0.33	0.00	0.33	0.00	0.03

N5-n background

E (lx)	Intra-subject					Inter-subject
	AR	ET	OB	PC	PS	
20	0.00	0.33	0.00	1.00	1.33	0.37
80	0.33	0.33	0.33	0.33	0.33	0.00
280	0.00	0.33	1.33	0.00	0.33	0.30
800	0.33	0.00	0.00	0.33	0.33	0.03

N3-n background

E (lx)	Intra-subject					Inter-subject
	AR	ET	OB	PC	PS	
20	0.00	0.00	0.00	0.00	0.00	0.00
80	0.00	0.00	0.00	0.00	0.00	0.00
280	0.00	1.33	0.00	0.00	0.00	0.36
800	0.00	0.00	1.33	1.33	0.00	0.53

(Variance based on size number 1-7)

Readability one-room experiment

Difficult to Read, Positive contrast

Normal eyes

N7-p background

E (lx)	Intra-subject					Inter-subject
	AR	ET	OB	PC	PS	
20	0.33	0.00	0.33	0.00	1.00	0.17
80	0.33	0.00	0.33	0.00	0.00	0.03
280	0.33	0.33	0.00	0.00	0.00	0.03
800	1.00	0.00	0.33	0.33	0.33	0.13

N5-p background

E (lx)	Intra-subject					Inter-subject
	AR	ET	OB	PC	PS	
20	0.00	0.00	0.33	0.00	0.00	0.02
80	0.33	0.33	0.00	0.00	0.33	0.03
280	0.00	0.00	0.33	0.00	0.33	0.03
800	0.00	0.00	0.33	0.33	0.00	0.03

N3-p background

E (lx)	Intra-subject					Inter-subject
	AR	ET	OB	PC	PS	
20	0.33	0.33	0.00	0.00	0.00	0.03
80	0.33	0.00	0.33	0.00	0.33	0.03
280	0.33	0.00	0.33	0.33	0.33	0.02
800	0.33	0.00	0.00	0.33	0.00	0.03

NB-p background

E (lx)	Intra-subject					Inter-subject
	AR	ET	OB	PC	PS	
20	0.33	0.00	0.33	0.00	0.00	0.03
80	0.00	0.33	0.00	0.00	0.00	0.02
280	0.33	0.00	0.33	0.00	0.00	0.03
800	0.00	0.00	0.33	0.00	0.00	0.02

Eyes with goggles

N7-p background

E (lx)	Intra-subject					Inter-subject
	AR	ET	OB	PC	PS	
20	0.00	0.33	0.33	0.33	0.33	0.02
80	0.33	0.33	0.33	0.33	0.00	0.02
280	0.33	0.00	0.33	0.00	0.33	0.03
800	1.00	0.00	0.33	0.00	0.33	0.17

N5-p background

E (lx)	Intra-subject					Inter-subject
	AR	ET	OB	PC	PS	
20	0.33	0.33	4.00	0.33	0.33	2.69
80	0.00	0.00	1.00	0.33	0.33	0.17
280	0.33	0.00	1.33	0.00	0.33	0.30
800	0.33	0.00	0.00	0.00	0.00	0.02

N3-p background

E (lx)	Intra-subject					Inter-subject
	AR	ET	OB	PC	PS	
20	0.33	0.33	0.33	0.00	0.00	0.03
80	0.00	0.00	0.33	0.33	0.33	0.03
280	1.00	0.33	0.33	0.33	0.33	0.09
800	0.00	0.00	0.00	0.00	0.00	0.00

NB-p background

E (lx)	Intra-subject					Inter-subject
	AR	ET	OB	PC	PS	
20	0.00	0.00	0.33	0.33	0.00	0.03
80	0.00	0.00	0.33	0.33	0.33	0.03
280	0.00	0.00	0.00	0.33	0.33	0.03
800	0.00	0.33	0.00	0.00	0.33	0.03

(Variance based on size number 1-7)

Readability one-room experiment

Can Read, Negative contrast

Normal eyes

NW-n background

E (lx)	Intra-subject					Inter-subject
	AR	ET	OB	PC	PS	
20	0.00	0.33	0.00	0.33	0.00	0.03
80	1.33	0.00	0.00	0.00	0.33	0.33
280	1.33	0.00	0.33	0.00	0.33	0.30
800	3.00	0.00	0.00	0.00	0.00	1.80

N7-n background

E (lx)	Intra-subject					Inter-subject
	AR	ET	OB	PC	PS	
20	0.33	0.00	0.00	0.33	0.33	0.03
80	0.33	0.00	0.33	0.33	0.33	0.02
280	0.33	0.00	0.00	0.00	0.33	0.03
800	0.00	0.00	0.00	0.00	0.00	0.00

N5-n background

E (lx)	Intra-subject					Inter-subject
	AR	ET	OB	PC	PS	
20	0.00	0.33	0.33	0.00	0.33	0.03
80	0.00	0.00	0.33	0.33	0.33	0.03
280	0.33	0.00	0.00	0.33	0.00	0.03
800	0.33	0.00	0.33	0.33	0.33	0.02

N3-n background

E (lx)	Intra-subject					Inter-subject
	AR	ET	OB	PC	PS	
20	0.00	0.33	0.33	0.00	0.00	0.03
80	0.00	0.33	1.00	0.33	0.33	0.13
280	0.00	0.33	0.33	0.33	0.33	0.02
800	0.50	0.00	0.33	1.00	0.33	0.13

Eyes with goggles

NW-n background

E (lx)	Intra-subject					Inter-subject
	AR	ET	OB	PC	PS	
20	0.33	0.33	0.33	0.00	0.33	0.02
80	0.00	0.00	0.33	0.00	0.33	0.03
280	0.33	0.00	0.33	0.33	0.00	0.03
800	1.33	0.00	0.00	0.33	0.00	0.33

N7-n background

E (lx)	Intra-subject					Inter-subject
	AR	ET	OB	PC	PS	
20	0.00	0.33	0.33	0.33	0.33	0.02
80	0.33	0.00	0.33	0.33	0.33	0.02
280	0.00	0.00	0.33	0.33	0.00	0.03
800	0.33	0.33	0.33	0.00	0.00	0.03

N5-n background

E (lx)	Intra-subject					Inter-subject
	AR	ET	OB	PC	PS	
20	0.00	0.00	0.00	0.00	0.00	0.00
80	0.00	0.33	1.33	0.00	0.33	0.30
280	0.00	0.00	1.00	1.00	2.33	0.92
800	0.00	0.33	0.33	1.33	0.33	0.26

N3-n background

E (lx)	Intra-subject					Inter-subject
	AR	ET	OB	PC	PS	
20	0.00	0.00	0.00	0.00	0.00	0.00
80	0.00	0.00	0.00	0.00	0.00	0.00
280	0.00	0.00	0.00	0.00	0.00	0.00
800	0.00	0.00	0.00	0.00	0.00	0.00

(Variance based on size number 1-7)

Readability one-room experiment

Can Read, Positive contrast

Normal eyes

Eyes with goggles

N7-p background

E (lx)	Intra-subject					Inter-subject
	AR	ET	OB	PC	PS	
20	0.33	0.00	0.33	0.00	0.00	0.03
80	0.00	0.33	0.00	0.33	0.33	0.03
280	0.33	0.00	0.00	0.33	1.00	0.17
800	0.33	0.33	0.00	0.33	0.33	0.02

N7-p background

E (lx)	Intra-subject					Inter-subject
	AR	ET	OB	PC	PS	
20	0.00	0.33	0.00	0.00	0.00	0.02
80	0.00	0.33	0.33	0.00	0.00	0.03
280	0.33	0.00	0.00	0.33	1.00	0.17
800	0.33	0.00	0.33	0.33	2.33	0.89

N5-p background

E (lx)	Intra-subject					Inter-subject
	AR	ET	OB	PC	PS	
20	0.00	0.33	0.00	0.00	0.00	0.02
80	0.33	0.33	0.00	0.00	0.33	0.03
280	0.33	0.00	0.33	0.00	0.33	0.03
800	0.33	0.00	0.00	0.00	0.00	0.02

N5-p background

E (lx)	Intra-subject					Inter-subject
	AR	ET	OB	PC	PS	
20	0.00	0.33	0.33	0.33	0.00	0.03
80	0.33	0.33	0.33	0.33	0.00	0.02
280	0.33	0.00	0.33	0.33	0.33	0.02
800	0.00	0.00	0.33	0.33	0.00	0.03

N3-p background

E (lx)	Intra-subject					Inter-subject
	AR	ET	OB	PC	PS	
20	0.00	0.00	0.33	0.33	0.33	0.03
80	0.33	0.00	0.00	0.33	0.33	0.03
280	0.33	0.00	0.33	0.00	1.00	0.17
800	0.33	0.00	0.33	0.00	0.00	0.03

N3-p background

E (lx)	Intra-subject					Inter-subject
	AR	ET	OB	PC	PS	
20	0.00	0.00	0.33	0.33	0.00	0.03
80	0.33	0.00	0.00	0.00	0.33	0.03
280	0.00	0.00	0.33	0.33	0.33	0.03
800	0.33	0.33	0.00	0.00	0.33	0.03

NB-p background

E (lx)	Intra-subject					Inter-subject
	AR	ET	OB	PC	PS	
20	0.33	0.33	0.33	0.00	0.33	0.02
80	0.00	0.33	0.00	0.00	0.00	0.02
280	0.33	0.00	0.33	0.00	0.00	0.03
800	0.00	0.00	0.33	0.33	0.00	0.03

NB-p background

E (lx)	Intra-subject					Inter-subject
	AR	ET	OB	PC	PS	
20	0.00	0.00	0.33	0.00	0.33	0.03
80	0.33	0.00	0.00	0.33	0.33	0.03
280	0.00	0.00	0.00	0.33	0.33	0.03
800	0.33	0.33	0.00	0.00	0.33	0.03

(Variance based on size number 1-7)

Readability one-room experiment

Cannot Read

Normal eyes

N7-n background

E (lx)	Intra-subject					Inter-subject
	AR	ET	OB	PC	PS	
20	0.00	0.00	0.00	0.00	0.00	0.00
80	0.00	0.33	0.00	0.00	0.00	0.02
280	0.00	0.33	0.00	0.00	0.00	0.02
800	0.00	0.33	0.00	0.33	0.00	0.03

Eyes with goggles

N7-n background

E (lx)	Intra-subject					Inter-subject
	AR	ET	OB	PC	PS	
20	0.00	0.00	0.00	0.00	0.00	0.00
80	0.00	0.00	0.00	0.00	0.00	0.00
280	0.00	0.00	0.00	0.00	0.00	0.00
800	0.00	0.00	0.00	0.00	0.00	0.00

N3-p background

E (lx)	Intra-subject					Inter-subject
	AR	ET	OB	PC	PS	
20	0.00	0.00	0.00	0.00	0.00	0.00
80	0.00	0.00	0.00	0.00	0.00	0.00
280	0.00	0.00	0.00	0.00	0.00	0.00
800	0.00	0.00	0.00	0.00	0.00	0.00

N3-p background

E (lx)	Intra-subject					Inter-subject
	AR	ET	OB	PC	PS	
20	0.00	0.00	0.00	0.00	0.00	0.00
80	0.00	0.00	0.00	0.00	0.00	0.00
280	0.00	0.00	0.00	0.00	0.00	0.00
800	0.00	0.00	0.00	0.00	0.00	0.00

Comfortable to Read

Normal eyes

N7-n background

E (lx)	Intra-subject					Inter-subject
	AR	ET	OB	PC	PS	
20	0.33	3.00	0.00	0.00	0.00	0.00
80	0.33	6.33	0.33	0.33	1.33	0.02
280	0.33	6.33	0.33	0.33	0.33	0.02
800	0.33	4.00	0.33	0.00	0.00	0.03

Eyes with goggles

N7-n background

E (lx)	Intra-subject					Inter-subject
	AR	ET	OB	PC	PS	
20	0.00	1.33	0.00	0.00	0.33	0.00
80	0.00	2.33	0.33	0.00	1.33	0.00
280	0.33	4.33	1.00	0.33	0.33	0.00
800	0.00	7.00	0.33	0.00	2.33	0.00

N3-p background

E (lx)	Intra-subject					Inter-subject
	AR	ET	OB	PC	PS	
20	0.00	0.33	0.33	1.00	0.33	0.00
80	0.33	0.33	0.33	1.00	0.33	0.02
280	0.33	0.33	0.33	0.00	0.33	0.02
800	0.00	0.33	1.00	0.00	0.33	0.03

N3-p background

E (lx)	Intra-subject					Inter-subject
	AR	ET	OB	PC	PS	
20	0.00	1.33	0.33	0.00	0.00	0.00
80	0.33	0.33	0.33	0.33	0.00	0.00
280	0.00	2.33	0.33	0.33	0.00	0.00
800	0.33	2.33	0.00	0.33	0.00	0.00

(Variance based on size number 1-7)

4.2 Variance of readability two-room experiment

Readability two-room experiment

Difficult to Read, Negative contrast

Normal eyes

NW-n background

E (lx)	Intra-subject					Inter-subject
	AR	ET	OB	PC	PS	
0	0.00	0.33	0.33	0.33	0.33	0.33
5	0.33	1.00	0.33	0.33	1.00	1.00
20	0.33	1.00	0.33	0.33	0.33	0.33
80	0.00	1.00	0.33	0.00	0.33	0.33
280	0.33	1.00	0.33	0.33	0.33	0.33
900	0.00	1.00	0.33	0.33	0.33	0.33
1500	0.33	0.33	0.33	0.33	0.33	0.33

N7-n background

E (lx)	Intra-subject					Inter-subject
	AR	ET	OB	PC	PS	
0	0.33	0.33	0.33	0.33	0.33	0.33
5	0.33	1.33	0.00	0.33	0.33	0.33
20	0.33	1.00	0.33	0.33	0.33	0.33
80	0.33	1.00	0.33	0.33	0.33	0.33
280	0.33	1.33	0.33	0.33	0.33	0.33
900	0.33	1.00	0.33	0.33	0.33	0.33
1500	0.33	0.00	0.33	0.00	0.00	0.00

N5-n background

E (lx)	Intra-subject					Inter-subject
	AR	ET	OB	PC	PS	
0	0.33	0.33	0.00	0.00	0.00	0.00
5	0.33	0.33	0.00	0.33	0.33	0.33
20	0.33	0.33	0.00	0.00	0.33	0.33
80	0.33	1.00	0.33	0.33	0.33	0.33
280	1.00	0.33	0.33	0.33	0.33	0.33
900	0.00	0.33	0.33	0.00	0.00	0.00
1500	0.33	0.33	0.33	0.33	0.33	0.33

N3-n background

E (lx)	Intra-subject					Inter-subject
	AR	ET	OB	PC	PS	
0	1.33	0.00	0.00	0.00	0.00	0.00
5	0.33	0.00	0.00	0.00	0.33	0.33
20	0.33	0.33	0.33	0.33	0.00	0.00
80	0.33	0.00	0.33	0.00	0.33	0.33
280	0.33	0.33	0.33	0.33	0.33	0.33
900	0.33	0.33	0.33	0.33	0.33	0.33
1500	1.00	0.33	1.33	0.33	1.00	1.00

Eyes with goggles

NW-n background

E (lx)	Intra-subject					Inter-subject
	AR	ET	OB	PC	PS	
0	0.33	0.33	0.33	0.33	0.33	0.33
5	0.33	0.33	0.33	0.33	0.33	0.33
20	0.00	0.33	0.00	0.00	0.00	0.00
80	0.33	0.33	0.00	0.00	0.00	0.00
280	0.00	1.33	0.00	0.33	0.00	0.00
900	0.33	0.33	0.00	0.00	0.00	0.00
1500	0.33	0.33	0.33	0.33	0.33	0.33

N7-n background

E (lx)	Intra-subject					Inter-subject
	AR	ET	OB	PC	PS	
0	1.00	0.33	0.33	0.33	0.33	0.33
5	0.33	0.33	0.00	0.00	0.00	0.00
20	0.33	0.33	0.00	0.00	0.00	0.00
80	0.33	0.33	0.33	0.00	0.00	0.00
280	0.33	0.33	0.00	0.00	0.00	0.00
900	0.33	0.00	0.00	0.00	0.33	0.33
1500	1.33	0.33	0.33	0.33	0.33	0.33

N5-n background

E (lx)	Intra-subject					Inter-subject
	AR	ET	OB	PC	PS	
0	1.33	0.00	0.33	0.33	0.00	0.00
5	1.33	0.00	0.33	0.33	0.00	0.00
20	1.33	0.00	0.33	0.00	0.00	0.00
80	1.33	0.00	1.33	0.33	0.33	0.33
280	3.00	0.00	0.33	0.33	1.33	1.33
900	4.33	0.33	0.33	0.00	1.33	1.33
1500	8.33	2.33	3.00	3.00	3.00	3.00

N3-n background

E (lx)	Intra-subject					Inter-subject
	AR	ET	OB	PC	PS	
0	1.33	0.00	0.33	0.33	0.33	0.33
5	2.33	0.33	1.00	0.33	1.00	1.00
20	0.33	1.00	0.33	0.33	2.33	2.33
80	1.00	1.00	2.33	0.33	6.33	6.33
280	0.00	1.33	0.00	0.33	8.33	8.33
900	0.00	0.00	0.00	0.00	1.33	1.33
1500	0.00	0.00	0.00	0.00	0.00	0.00

(Variance based on size number 1-7)

Readability two-room experiment

Difficult to Read, Positive contrast

Normal eyes

N7-p background

E (lx)	Intra-subject					Inter-subject
	AR	ET	OB	PC	PS	
0	0.33	0.00	0.00	0.00	0.00	0.00
5	0.33	0.33	0.33	0.33	0.33	0.33
20	0.33	0.33	0.33	0.33	0.33	0.33
80	0.00	0.33	0.33	0.00	0.00	0.00
280	0.33	1.00	0.33	0.33	0.33	0.33
900	0.00	1.33	0.33	0.33	0.33	0.33
1500	0.33	0.33	0.00	0.00	0.00	0.00

N5-p background

E (lx)	Intra-subject					Inter-subject
	AR	ET	OB	PC	PS	
0	0.00	0.33	0.00	0.00	0.00	0.00
5	0.00	0.33	0.00	0.00	0.00	0.00
20	0.00	0.33	0.00	0.33	0.33	0.33
80	0.33	0.33	0.33	0.33	0.33	0.33
280	0.33	0.33	0.33	0.33	0.00	0.00
900	0.33	1.00	0.33	0.33	0.33	0.33
1500	1.00	0.33	0.33	0.33	0.33	0.33

N3-p background

E (lx)	Intra-subject					Inter-subject
	AR	ET	OB	PC	PS	
0	0.33	0.33	0.33	0.33	0.33	0.33
5	0.00	0.33	0.00	0.33	0.33	0.33
20	0.00	0.33	0.00	0.33	0.33	0.33
80	0.33	0.33	0.33	0.33	0.33	0.33
280	0.33	0.33	0.00	0.33	0.00	0.00
900	0.00	1.33	0.00	0.33	0.00	0.00
1500	0.33	0.33	0.00	0.33	0.33	0.33

NB-p background

E (lx)	Intra-subject					Inter-subject
	AR	ET	OB	PC	PS	
0	0.33	0.33	0.00	0.00	0.33	0.33
5	0.33	0.33	0.00	0.00	0.33	0.33
20	0.00	0.33	0.00	0.00	0.33	0.33
80	0.00	0.33	0.00	0.00	0.00	0.00
280	0.33	0.33	0.00	0.33	0.00	0.00
900	0.33	0.33	0.00	0.00	0.00	0.00
1500	0.00	0.00	0.00	0.33	0.00	0.00

Eyes with goggles

N7-p background

E (lx)	Intra-subject					Inter-subject
	AR	ET	OB	PC	PS	
0	0.33	0.33	0.00	0.00	0.33	0.33
5	0.33	0.33	0.33	0.33	0.33	0.33
20	0.33	1.00	0.33	0.33	1.00	1.00
80	0.33	0.33	0.33	0.00	0.33	0.33
280	1.00	0.33	0.33	0.33	0.33	0.33
900	1.00	0.33	0.33	0.33	0.33	0.33
1500	1.00	0.33	0.33	0.33	0.33	0.33

N5-p background

E (lx)	Intra-subject					Inter-subject
	AR	ET	OB	PC	PS	
0	0.33	0.00	0.00	0.00	0.33	0.33
5	1.00	0.33	1.00	0.33	1.00	1.00
20	1.33	0.00	0.33	0.00	0.33	0.33
80	0.33	0.00	0.33	0.00	0.33	0.33
280	0.33	0.00	0.00	0.00	0.33	0.33
900	1.00	0.33	0.33	0.33	1.00	1.00
1500	1.00	0.33	0.33	0.33	2.33	2.33

N3-p background

E (lx)	Intra-subject					Inter-subject
	AR	ET	OB	PC	PS	
0	0.33	0.33	0.00	0.00	0.33	0.33
5	0.33	0.33	0.00	0.00	0.00	0.00
20	0.00	0.33	0.00	0.00	0.00	0.00
80	0.00	0.33	0.00	0.00	0.00	0.00
280	0.33	0.00	0.00	0.00	0.00	0.00
900	0.33	0.00	0.00	0.33	0.33	0.33
1500	2.33	1.33	1.33	1.33	1.33	1.33

NB-p background

E (lx)	Intra-subject					Inter-subject
	AR	ET	OB	PC	PS	
0	0.33	0.00	0.00	0.00	0.33	0.33
5	0.33	0.33	0.00	0.00	0.33	0.33
20	0.33	0.33	0.00	0.00	0.00	0.00
80	0.33	0.00	0.33	0.00	0.33	0.33
280	0.33	0.33	0.33	0.00	0.33	0.33
900	0.00	0.33	0.00	0.00	0.00	0.00
1500	0.33	0.00	0.33	0.00	0.33	0.33

(Variance based on size number 1-7)

Readability two-room experiment

Can Read, Negative contrast

Normal eyes

NW-n background

E (lx)	Intra-subject					Inter-subject
	AR	ET	OB	PC	PS	
0	0.33	0.33	0.00	0.33	0.00	0.00
5	0.00	1.33	0.00	0.33	0.33	0.33
20	1.00	0.33	0.33	0.33	0.33	0.33
80	0.33	0.33	0.33	0.33	0.33	0.33
280	0.33	0.33	0.00	0.33	0.33	0.33
900	0.33	1.33	0.00	0.33	0.33	0.33
1500	0.33	0.33	0.33	0.33	0.33	0.33

N7-n background

E (lx)	Intra-subject					Inter-subject
	AR	ET	OB	PC	PS	
0	0.33	0.33	0.00	0.33	0.00	0.00
5	0.33	0.33	0.00	0.00	0.00	0.00
20	0.00	1.33	0.00	0.00	0.33	0.33
80	0.00	0.33	0.00	0.33	0.00	0.00
280	0.33	1.00	0.33	1.00	0.33	0.33
900	0.33	1.33	0.00	0.00	0.33	0.33
1500	0.33	0.33	0.00	0.00	0.33	0.33

N5-n background

E (lx)	Intra-subject					Inter-subject
	AR	ET	OB	PC	PS	
0	1.33	0.33	0.00	0.00	0.00	0.00
5	1.33	0.33	0.00	0.33	0.00	0.00
20	0.33	1.00	0.33	0.33	0.33	0.33
80	0.33	0.33	0.33	0.00	0.00	0.00
280	1.00	0.33	0.33	0.33	0.33	0.33
900	0.33	1.33	0.00	0.00	0.00	0.00
1500	1.33	0.00	0.33	0.33	0.00	0.00

N3-n background

E (lx)	Intra-subject					Inter-subject
	AR	ET	OB	PC	PS	
0	0.33	0.00	0.00	0.00	0.33	0.33
5	0.33	0.00	0.33	0.33	0.33	0.33
20	0.33	0.00	0.33	0.33	0.33	0.33
80	0.33	0.00	0.33	0.00	0.33	0.33
280	0.33	0.33	1.33	0.33	0.33	0.33
900	3.00	4.33	2.33	2.00	3.00	3.00
1500	0.33	1.00	0.00	2.00	0.33	0.33

Eyes with goggles

NW-n background

E (lx)	Intra-subject					Inter-subject
	AR	ET	OB	PC	PS	
0	0.33	0.33	0.00	0.00	0.00	0.00
5	0.33	0.33	0.33	0.00	0.00	0.00
20	0.33	0.33	0.00	0.00	0.00	0.00
80	0.00	0.33	0.00	0.00	0.33	0.33
280	0.33	1.33	0.00	0.00	0.33	0.33
900	0.33	0.33	0.00	0.33	0.33	0.33
1500	1.33	0.00	0.33	1.33	0.33	0.33

N7-n background

E (lx)	Intra-subject					Inter-subject
	AR	ET	OB	PC	PS	
0	0.33	0.00	0.33	0.00	0.00	0.00
5	0.33	0.33	0.33	0.00	0.00	0.00
20	0.33	0.33	0.00	0.33	0.33	0.33
80	1.33	0.33	0.33	0.00	0.33	0.33
280	1.33	0.33	0.00	0.00	0.33	0.33
900	2.33	0.33	0.33	1.00	0.33	0.33
1500	3.00	0.00	3.00	3.00	1.33	1.33

N5-n background

E (lx)	Intra-subject					Inter-subject
	AR	ET	OB	PC	PS	
0	2.33	0.33	0.00	0.33	1.00	1.00
5	1.33	0.00	0.00	0.00	0.00	0.00
20	1.00	0.33	0.33	1.00	0.33	0.33
80	4.33	0.33	0.33	0.33	1.00	1.00
280	2.33	1.00	0.33	0.33	1.33	1.33
900	0.00	0.00	0.00	0.00	0.00	0.00
1500	0.00	0.00	0.33	0.00	0.00	0.00

N3-n background

E (lx)	Intra-subject					Inter-subject
	AR	ET	OB	PC	PS	
0	1.33	1.00	1.00	0.50	1.33	1.33
5	0.00	1.00	0.33	0.50	0.33	0.33
20	1.33	1.00	1.33	2.00	1.33	1.33
80	0.00	0.00	0.00	0.00	0.00	0.00
280	0.00	0.00	0.00	0.00	0.00	0.00
900	0.00	0.00	0.00	0.00	0.00	0.00
1500	0.00	0.00	0.00	0.00	0.00	0.00

(Variance based on size number 1-7)

Readability two-room experiment

Can Read, Positive contrast

Normal eyes

N7-p background

E (lx)	Intra-subject					Inter-subject
	AR	ET	OB	PC	PS	
0	0.33	0.33	0.00	0.00	0.33	0.33
5	0.33	1.00	0.33	1.00	0.33	0.33
20	0.33	1.00	0.33	0.33	0.33	0.33
80	0.00	1.33	0.33	0.33	0.00	0.00
280	0.33	1.00	1.00	1.00	0.33	0.33
900	0.00	0.33	0.33	0.33	0.33	0.33
1500	0.00	1.33	0.33	0.00	0.00	0.00

N5-p background

E (lx)	Intra-subject					Inter-subject
	AR	ET	OB	PC	PS	
0	0.33	0.33	0.00	0.00	0.00	0.00
5	0.33	1.00	0.33	0.33	0.33	0.33
20	0.33	1.33	0.33	0.33	0.33	0.33
80	0.33	0.33	0.00	0.33	0.00	0.00
280	1.00	0.33	0.33	0.33	0.33	0.33
900	0.33	0.33	0.00	0.00	0.33	0.33
1500	0.33	0.33	0.33	0.00	0.00	0.00

N3-p background

E (lx)	Intra-subject					Inter-subject
	AR	ET	OB	PC	PS	
0	0.33	1.00	0.33	0.33	0.33	0.33
5	0.33	0.33	0.00	0.33	0.33	0.33
20	0.33	0.33	0.00	0.00	0.00	0.00
80	0.33	0.33	0.00	0.00	0.00	0.00
280	1.00	1.00	0.33	1.00	0.33	0.33
900	0.33	1.00	0.33	0.33	0.33	0.33
1500	0.33	0.33	0.00	0.00	0.00	0.00

NB-p background

E (lx)	Intra-subject					Inter-subject
	AR	ET	OB	PC	PS	
0	1.33	0.00	0.00	0.00	0.00	0.00
5	1.33	0.33	0.00	0.00	0.00	0.00
20	0.33	0.00	0.00	0.00	0.00	0.00
80	0.33	0.00	0.00	0.00	0.00	0.00
280	0.00	0.33	0.33	1.33	0.33	0.33
900	0.33	0.33	0.00	0.00	0.00	0.00
1500	0.33	0.00	0.33	0.00	0.33	0.33

Eyes with goggles

N7-p background

E (lx)	Intra-subject					Inter-subject
	AR	ET	OB	PC	PS	
0	1.33	0.00	0.33	0.33	0.33	0.33
5	1.00	0.33	1.00	0.33	0.33	0.33
20	0.00	0.33	0.00	0.00	0.33	0.33
80	0.33	1.00	0.33	0.33	1.00	1.00
280	2.33	1.00	0.33	0.33	2.33	2.33
900	0.33	2.33	1.00	0.00	0.33	0.33
1500	1.33	0.00	1.33	1.33	1.33	1.33

N5-p background

E (lx)	Intra-subject					Inter-subject
	AR	ET	OB	PC	PS	
0	1.33	0.00	0.00	1.33	0.33	0.33
5	1.33	0.33	0.33	0.00	0.00	0.00
20	1.33	0.00	0.33	0.33	0.00	0.00
80	1.33	0.00	0.33	0.00	0.33	0.33
280	1.00	0.33	0.33	0.33	0.33	0.33
900	2.33	0.33	0.33	1.00	0.33	0.33
1500	4.33	0.33	0.33	2.33	1.00	1.00

N3-p background

E (lx)	Intra-subject					Inter-subject
	AR	ET	OB	PC	PS	
0	0.33	0.33	0.00	0.00	0.33	0.33
5	0.33	0.33	0.00	0.00	0.00	0.00
20	0.33	0.33	0.00	0.33	0.00	0.00
80	0.00	0.33	0.33	0.33	0.00	0.00
280	0.33	1.33	0.00	0.33	0.00	0.00
900	1.33	0.33	0.00	1.33	0.33	0.33
1500	1.33	0.33	0.33	0.33	0.33	0.33

NB-p background

E (lx)	Intra-subject					Inter-subject
	AR	ET	OB	PC	PS	
0	1.33	0.00	0.00	0.00	0.00	0.00
5	1.00	1.00	0.33	0.33	1.00	1.00
20	0.33	0.33	0.00	0.00	0.00	0.00
80	0.33	0.33	0.33	0.33	0.33	0.33
280	1.33	0.33	0.33	0.33	0.33	0.33
900	1.33	0.33	0.00	0.33	0.00	0.00
1500	1.33	0.00	1.33	1.33	0.00	0.00

(Variance based on size number 1-7)

Readability two-room experiment

Cannot Read

Normal eyes

N7-n background

E (lx)	Intra-subject					Inter-subject
	AR	ET	OB	PC	PS	
0	0.00	0.00	0.00	0.00	0.00	0.00
5	0.00	0.33	0.00	0.00	0.00	0.00
20	0.00	0.00	0.00	0.00	0.00	0.00
80	0.00	0.00	0.00	0.00	0.00	0.00
280	0.00	0.33	0.00	0.00	0.00	0.00
900	0.00	0.33	0.00	0.00	0.00	0.00
1500	0.00	0.00	0.00	0.00	0.00	0.00

Eyes with goggles

N7-n background

E (lx)	Intra-subject					Inter-subject
	AR	ET	OB	PC	PS	
0	0.00	0.00	0.00	0.00	0.00	0.00
5	0.00	0.00	0.00	0.00	0.00	0.00
20	0.00	0.00	0.00	0.00	0.00	0.00
80	0.00	0.00	0.00	0.00	0.00	0.00
280	0.00	0.00	0.00	0.00	0.00	0.00
900	0.00	0.00	0.00	0.00	0.00	0.00
1500	0.00	0.00	0.00	0.00	0.00	0.00

N3-p background

E (lx)	Intra-subject					Inter-subject
	AR	ET	OB	PC	PS	
0	0.00	0.00	0.00	0.00	0.00	0.00
5	0.00	0.00	0.00	0.00	0.00	0.00
20	0.00	0.00	0.00	0.00	0.00	0.00
80	0.00	0.00	0.00	0.00	0.00	0.00
280	0.00	0.00	0.00	0.00	0.00	0.00
900	0.00	0.33	0.00	0.00	0.00	0.00
1500	0.00	0.00	0.00	0.00	0.00	0.00

N3-p background

E (lx)	Intra-subject					Inter-subject
	AR	ET	OB	PC	PS	
0	0.00	0.00	0.00	0.00	0.00	0.00
5	0.00	0.00	0.00	0.00	0.00	0.00
20	0.00	0.00	0.00	0.00	0.00	0.00
80	0.00	0.00	0.00	0.00	0.00	0.00
280	0.00	0.00	0.00	0.00	0.00	0.00
900	0.00	0.00	0.00	0.00	0.00	0.00
1500	0.00	0.00	0.00	0.00	0.00	0.00

Comfortable to Read

Normal eyes

N7-n background

E (lx)	Intra-subject					Inter-subject
	AR	ET	OB	PC	PS	
0	0.33	0.33	0.33	0.33	0.33	0.33
5	0.33	0.33	0.33	0.33	1.00	1.00
20	1.00	0.33	0.33	0.33	0.33	0.33
80	0.33	0.33	0.33	0.33	0.33	0.33
280	0.33	1.33	0.00	0.33	0.00	0.00
900	0.33	2.33	0.33	2.33	0.33	0.33
1500	0.33	0.33	0.33	1.33	0.33	0.33

Eyes with goggles

N7-n background

E (lx)	Intra-subject					Inter-subject
	AR	ET	OB	PC	PS	
0	1.33	0.33	0.33	0.33	0.00	0.00
5	0.33	0.33	0.00	1.33	0.00	0.00
20	0.33	0.33	0.33	1.00	0.33	0.33
80	1.33	0.00	0.00	0.33	0.00	0.00
280	1.33	0.33	0.00	0.00	0.33	0.33
900	1.00	1.00	0.33	1.00	0.33	0.33
1500	1.33	1.33	1.33	1.33	1.33	1.33

N3-p background

E (lx)	Intra-subject					Inter-subject
	AR	ET	OB	PC	PS	
0	0.33	0.00	0.00	0.00	0.33	0.33
5	0.33	0.33	0.33	0.33	0.33	0.33
20	0.33	1.00	0.33	0.33	0.33	0.33
80	0.00	0.00	0.33	0.33	0.00	0.00
280	0.33	0.33	0.33	0.33	0.00	0.00
900	0.00	0.00	0.00	0.33	0.00	0.00
1500	0.33	0.33	1.00	0.33	0.33	0.33

N3-p background

E (lx)	Intra-subject					Inter-subject
	AR	ET	OB	PC	PS	
0	1.33	0.33	0.33	0.00	0.33	0.33
5	1.00	0.33	0.33	0.33	0.33	0.33
20	0.33	0.33	0.33	0.33	0.33	0.33
80	0.33	0.33	0.00	0.33	0.33	0.33
280	1.33	0.00	0.00	0.00	0.33	0.33
900	2.33	0.33	0.33	2.33	1.00	1.00
1500	1.33	0.33	1.33	1.33	1.33	1.33

(Variance based on size number 1-7)

BIOGRAPHY

Mr. Boonchai Waleetorncheepsawat

Date of birth: 19th March 1964 at Phetburi, Thailand

Education:

- 1988: Bachelor's Degree of Science in Photographic Science and Printing Technology
At Department of Photographic Science and Printing Technology, Faculty of Science, Chulalongkorn University, Bangkok, Thailand.
- 1992: Master's Degree of Science in Graphic Arts System
At School of Printing Management and Science, Rochester Institute of Technology, New York, USA.

Work experience:

- 1988 -2003: Technologist and Management at Kurusapa Press, Kurusapa Business Organization, Bangkok, Thailand
- 2003 – 2008: Management at National Printing Technology Training Center, Sukhothai Thammathirat Open University, Nonthaburi, Thailand.
- 2008 – Present: Lecturer at School of Science and Technology, Sukhothai Thammathirat Open University, Nonthaburi, Thailand.

Academic publications:

- Waleetorncheepsawat, B., Pungrassamee, P., Ikeda, M., and Obama, T. Visual acuity of Thai letters with and without cataract experiencing goggles, Journal of the Color Science Association of Japan 36(2012): 216-217.
- Waleetorncheepsawat, B., Pungrassamee, P., Ikeda, M., and Obama, T. Proper-sized Thai letters suitable for elderlies and improvement of their visual performance, Conference Proceedings for Interim Meeting of the International Colour Association (AIC) 22-25 Sep. 2012 Taipei, Taiwan. (2012): 346-349.