

ผลของโปรแกรมการออกกำลังกายเดินแกว่งแขนสมาธิตามวิธีพุทธต่อการขยายหลอดเลือดผ่านการ
ทำงานของเซลล์เยื่อผนังหลอดเลือดและสมรรถภาพทางกายในผู้สูงอายุที่มีภาวะซึมเศร้า

นางสุสารี ประคินกิจ

วิทยานิพนธ์นี้เป็นส่วนหนึ่งของการศึกษาตามหลักสูตรปริญญาวิทยาศาสตรดุษฎีบัณฑิต
สาขาวิชาวิทยาศาสตร์การกีฬา
คณะวิทยาศาสตร์การกีฬา จุฬาลงกรณ์มหาวิทยาลัย
ปีการศึกษา 2555
ลิขสิทธิ์ของจุฬาลงกรณ์มหาวิทยาลัย

บทคัดย่อและแฟ้มข้อมูลฉบับเต็มของวิทยานิพนธ์ตั้งแต่ปีการศึกษา 2554 ที่ให้บริการในคลังปัญญาจุฬาฯ (CUIR)
เป็นแฟ้มข้อมูลของนิสิตเจ้าของวิทยานิพนธ์ที่ส่งผ่านทางบัณฑิตวิทยาลัย

The abstract and full text of theses from the academic year 2011 in Chulalongkorn University Intellectual Repository (CUIR)
are the thesis authors' files submitted through the Graduate School.

EFFECTS OF ARM SWING WALKING INCORPORATE WITH BUDDHIST MEDITATION
EXERCISE PROGRAM ON ENDOTHELIAL DEPENDENT VASODILATION AND PHYSICAL
FITNESS IN ELDERLY WITH DEPRESSION

Mrs. Susaree Prakhinkit

A Dissertation Submitted in Partial Fulfillment of the Requirements
for the Degree of Doctor of Philosophy Program in Sports Science

Faculty of Sports Science

Chulalongkorn University

Academic Year 2012

Copyright of Chulalongkorn University

Thesis Title EFFECTS OF ARM SWING WALKING INCORPORATE WITH
BUDDHIST MEDITATION EXERCISE PROGRAM ON
ENDOTHELIAL DEPENDENT VASODILATION AND
PHYSICAL FITNESS IN ELDERLY WITH DEPRESSION

By Mrs. Susaree Prakhinkit

Field of Study Sports Science

Thesis Advisor Associate Professor Daroonwan Suksom, Ph.D.

Thesis Co-advisor Associate Professor Siriluck Suppakitiporn, M.D.
Associate Professor Hirofumi Tanaka, Ph.D.

Accepted by the Faculty of Science, Chulalongkorn University in Partial
Fulfillment of the Requirements for the Doctoral Degree

.....Dean of the Faculty of Science
(Assistant Professor Chaninchai Intiraporn, Ph.D.)

THESIS COMMITTEE

.....Chairman
(Associate Professor Vijit Kanungsukkasem, Ed.D.)

.....Thesis Advisor
(Associate Professor Daroonwan Suksom, Ph.D.)

.....Thesis Co-advisor
(Associate Professor Siriluck Suppakitiporn, M.D.)

.....Thesis Co-advisor
(Associate Professor Hirofumi Tanaka, Ph.D.)

.....Examiner
(Associate Professor Thanomwong Kritpet, Ph.D.)

.....Examiner
(Associate Professor Suchitra Sukonthasab, Ph.D.)

.....External Examiner
(Tossaporn Yimlamai, Ph.D.)

สุสารี ประคินกิจ : ผลของโปรแกรมการออกกำลังกายเดินแกว่งแขนสมาธิตามวิธีพุทธต่อการขยายหลอดเลือดผ่านการทำงานของเซลล์เยื่อบุผนังหลอดเลือดและสมรรถภาพทางกายในผู้สูงอายุที่มีภาวะซึมเศร้า. (EFFECTS OF ARM SWING WALKING INCORPORATE WITH BUDDHIST MEDITATION EXERCISE PROGRAM ON ENDOTHELIAL DEPENDENT VASODILATION AND PHYSICAL FITNESS IN ELDERLY WITH DEPRESSION) อ.ที่ปรึกษาวิทยานิพนธ์หลัก : รศ.ดร.ดรอุณวรรณ สุขสม, อ.ที่ปรึกษาวิทยานิพนธ์ร่วม : รศ.พญ.ศิริลักษณ์ ศุภปีติพร, ASSOC. PROF. HIROFUMI TANAKA, Ph.D., 183 หน้า.

การวิจัยนี้มีวัตถุประสงค์เพื่อศึกษาผลของโปรแกรมการออกกำลังกายเดินแกว่งแขนสมาธิตามวิธีพุทธต่อการขยายหลอดเลือดผ่านการทำงานของเซลล์เยื่อบุผนังหลอดเลือดและสมรรถภาพทางกายในผู้สูงอายุ กลุ่มตัวอย่างเป็นผู้สูงอายุที่มีภาวะซึมเศร้าเล็กน้อยถึงปานกลาง จำนวน 40 คน แบ่งเป็น 3 กลุ่ม ได้แก่ กลุ่มควบคุม จำนวน 13 คน กลุ่มออกกำลังกายโดยการเดิน จำนวน 13 คน และกลุ่มออกกำลังกายโดยการเดินแกว่งแขนสมาธิ จำนวน 14 คน โปรแกรมการออกกำลังกายกำหนดที่ระดับความหนักของการออกกำลังกายเท่ากับเล็กน้อย (20-39%HRR) ถึงปานกลาง (40-50%HRR) ความถี่การออกกำลังกาย 3 ครั้ง/สัปดาห์ เป็นระยะเวลา 12 สัปดาห์

ผลการศึกษาพบว่า น้ำหนัก ดัชนีมวลกาย และความดันโลหิต ลดลงทั้งในกลุ่มที่ออกกำลังกายโดยการเดินและกลุ่มที่ออกกำลังกายโดยการเดินแกว่งแขนสมาธิ แต่เปอร์เซ็นต์ไขมันในร่างกายลดลงเฉพาะกลุ่มที่ออกกำลังกายโดยการเดินแกว่งแขนสมาธิ อย่างมีนัยสำคัญทางสถิติที่ระดับ .05 สมรรถภาพทางกาย ได้แก่ สมรรถภาพการใช้ออกซิเจนสูงสุด, ความแข็งแรงของกล้ามเนื้อ, ความอ่อนตัว, ความคล่องตัว และการทรงตัว เพิ่มขึ้นอย่างมีนัยสำคัญทางสถิติที่ระดับ .05 ในทั้งสองกลุ่มของการออกกำลังกาย นอกจากนี้ยังพบว่า ทั้งสองกลุ่มการออกกำลังกายมีระดับไขมันในกระแสเลือดและเอนไซม์ ซีรีแอกทีฟโปรตีนที่ลดลง และมีการขยายหลอดเลือดผ่านการทำงานของเซลล์เยื่อบุผนังหลอดเลือดเพิ่มขึ้นอย่างมีนัยสำคัญทางสถิติที่ระดับ .05 แต่กลุ่มออกกำลังกายโดยการเดินแกว่งแขนสมาธิมีการทำงานของหลอดเลือดที่ดีกว่ากลุ่มออกกำลังกายโดยการเดิน อีกทั้งยังลดระดับไซโตไคน์ อินเตอร์ลูคิน 6, คอร์ติซอลและ ภาวะซึมเศร้า

สรุปได้ว่า การออกกำลังกายโดยการเดินและการเดินแกว่งแขนสมาธิมีผลดีต่อการขยายหลอดเลือดผ่านการทำงานของเซลล์เยื่อบุผนังหลอดเลือด และสมรรถภาพทางกายในผู้สูงอายุที่มีภาวะซึมเศร้า แต่ออกกำลังกายโดยการเดินแกว่งแขนสมาธิมีผลต่อการทำงานของหลอดเลือด และลดภาวะซึมเศร้าได้ดีกว่ากลุ่มที่ออกกำลังกายโดยการเดิน

สาขาวิชา.....วิทยาศาสตร์การกีฬา.....ลายมือชื่อ.....
ปีการศึกษา.....2555.....ลายมือชื่อ อ.ที่ปรึกษาวิทยานิพนธ์หลัก.....
ลายมือชื่อ อ.ที่ปรึกษาวิทยานิพนธ์ร่วม.....
ลายมือชื่อ อ.ที่ปรึกษาวิทยานิพนธ์ร่วม.....

5378964639 : MAJOR SPORTS SCIENCE

KEYWORDS : ARM SWING WALKING / MEDITATION / ENDOTHELIAL DEPENDENT VASODILATION / DEPRESSION / ELDERLY

SUSAREE PRAKHINKIT : EFFECTS OF ARM SWING WALKING INCORPORATE WITH BUDDHIST MEDITATION EXERCISE PROGRAM ON ENDOTHELIAL DEPENDENT VASODILATION AND PHYSICAL FITNESS IN ELDERLY WITH DEPRESSION. ADVISOR:ASSOC. PROF. DAROONWAN SUKSOM, Ph.D., CO-ADVISOR : ASSOC. PROF. SIRILUCK SUPPAPITIPORN, M.D., ASSOC. PROF. HIROFUMI TANAKA, Ph.D., 183 pp.

This study was carried out to determine the effects of the novel Buddhism-based walking meditation (arm swing walking incorporating with Buddhist meditation; ASW) program on functional fitness, endothelium-dependent vasodilation and depression scores. A total of 40 participants with mild to moderate depressive symptoms were randomly allocated to the sedentary control (n=13), Traditional walking (TW; n=13), and ASW groups (n=14). Both exercise training programs were designed to yield the mild (20-39%HRR) to moderate (40-50%HRR) intensity, 3 times/ week for 12 weeks.

The results showed that body mass, BMI, systolic and diastolic blood pressure decreased in both TW and ASW groups and a significant decrease in body fat percentage was observed only in the ASW group ($p<0.05$). Maximal oxygen consumption, muscle strength, flexibility, agility, and dynamic balance increased in both exercise groups ($p<0.05$). Moreover, significant reduction in plasma cholesterol, triglyceride, and C-reactive protein and flow-mediated dilation induction were found in both exercise groups ($p<0.05$); however, the improvement of endothelial-dependent vasodilation was greater in the ASW group more than traditional walking group. Also, interleukin-6 concentrations, depression score were decreased only in the ASW group.

We concluded that both TW and ASW were effective in improving endothelial-dependent vasodilation and physical fitness. But the ASW program appears to confer greater improvements in vascular function and depression than the TW program.

Field of Study :Sports Science.....Student's Signature.....

Academic Year :2012.....Advisor's Signature.....

Co-advisor's Signature.....

Co-advisor's Signature.....

ACKNOWLEDGEMENTS

I would like to express my deepest and sincere gratitude and appreciation to Assoc. Prof. Dr. Daroonwan Suksom, my advisor, for her valuable guidance, supervision, encouragement and kindness which has enabled me to carry out my success. I am greatly in debt to Assoc. Prof. Dr. Siriluck Suppapatiporn and Assoc. Prof. Dr. Hirofumi Tanaka, my co-advisor, for their valuable suggestion, helpful comments and kindness in this research.

Sincere appreciation and gratitude are also expressed to Assoc. Prof. Dr. Vijit Kanungsukkasem, Assoc. Prof. Dr. Thanomwong Kritpet, Assoc. Prof. Dr. Suchitra Sukonthasab and Dr. Tossaporn Yimlamai, the thesis examining committee, for their magnificent comments and the correction of this thesis.

I am very grateful to the entire volunteers for their participation as subjects in this study. I would like to gratefully acknowledge that this thesis is successfully supported by Chulalongkorn University in 90th anniversary fund (Ratchadaphisek somphot endowment fund) and Faculty of Sports Science fund, Chulalongkorn University.

Special thanks is extended Assist. Prof. Dr. Orntipa Songsiri, for her kindness and giving a chance to develop their own progress, and Dr. Somrudee Chuenkitiyanon, for research assistance and encouragement throughout the study.

Finally, I would like to express my profound gratitude and appreciation to my mother, my father and my family for their encouragement, moral support and understanding throughout my life.

CONTENTS

	PAGE
ABSTRACT IN THAI.....	iv
ABSTRACT IN ENGLISH.....	v
ACKNOWLEDGEMENTS.....	vi
CONTENTS.....	vii
LIST OF TABLES.....	ix
LIST OF FIGURES.....	xii
CHAPTER I INTRODUCTION.....	1
1.1 Background and rationale.....	1
1.2 Research question.....	5
1.3 Objectives.....	5
1.4 Hypothesis.....	6
1.5 Scope of research.....	6
1.6 Operational definition.....	9
1.7 Expected benefits and applications.....	10
CHAPTER II LITERATURE REVIEW.....	11
2.1 The elderly.....	12
2.2 Depression.....	19
2.3 Endothelial cell.....	29
2.4 Exercise in the elderly.....	42
2.5 Related research studies.....	48
2.6 Conceptual framework.....	54
CHAPTER III METHODOLOGY.....	55
3.1 Participants.....	55
3.2 Data collection.....	56
3.3 Instruments.....	57

CHAPTER III METHODOLOGY	PAGE
3.4 Method	58
3.5 Data analysis.....	70
CHAPTER IV RESULTS.....	71
CHAPTER V DISCUSSION AND CONCLUSION.....	120
REFERENCES.....	134
APPENDICES.....	151
APPENDIX A The certificate approval.....	152
APPENDIX B Information sheet for research participant.....	156
APPENDIX C Informed consent form.....	162
APPENDIX D Thai Geriatric Depression Scale.....	164
APPENDIX E Interleukin-6 measurement.....	168
APPENDIX F Nitric oxide measurement.....	174
APPENDIX G Physical fitness measurement.....	179
BIOGRAPHY.....	183

LIST OF TABLE

TABLE		PAGE
2.1	Prevalence of diseases in Thai elderly.....	16
2.2	Vasoregulatory substances synthesized by endothelium.....	32
3.1	Traditional walking exercise program.....	61
3.2	Arm swing walking incorporating with Buddhist meditation exercise program.....	62
4.1	The comparison of physiological characteristics and between group.....	74
4.2	The comparison of resting heart rate(bpm) between pre and post training in Three group : sedentary control group(CON), traditional walking exercise training.....	75
4.3	The comparison of systolic blood pressure (mmHg) between pre and post training in three groups: sedentary control group (CON), traditional walking exercise training group (TW) and arm swing walking incorporating Buddhist meditation exercise training group (ASW).....	76
4.4	The comparison of diastolic blood pressure (mmHg) between pre and post training in three groups: sedentary control group(CON), traditional walking exercise training group(TW) and arm swing walking incorporating Buddhist meditation exercise training group (ASW).....	77
4.5	The comparison of body mass (kg) between pre and post training in three groups : sedentary control group (CON), traditional walking exercise training group (TW) and arm swing walking incorporating Buddhist meditation exercise training group (ASW)...	78

TABLE	PAGE	
4.6	The comparison of body mass index (kg/m^2) between pre and post training in three groups: sedentary control group (CON), traditional walking exercise training group (TW) and arm swing walking incorporating Buddhist meditation exercise training group (ASW)...	79
4.7	The comparison of body fat (percentage) between pre and post training in three groups: sedentary control group (CON), traditional walking exercise training group (TW) and arm swing walking incorporating Buddhist meditation exercise training group(ASW)..	80
4.8	The comparison of maximum oxygen consumption (VO_2max ; ml/kg/min) between pre and post training in three groups: sedentary control group (CON), traditional walking exercise training group (TW) and arm swing walking incorporating Buddhist meditation exercise training group (ASW).....	81
4.9	The comparison of forced vital capacity; FVC (liters) between pre and post training in three groups: sedentary control group (CON), traditional walking exercise training group (TW) and arm swing walking incorporating Buddhist meditation exercise training group (ASW).....	82
4.10	The comparison of forced expiratory volume at 1 second; FEV1 (liters) between pre and post training in three groups: sedentary control group (CON), traditional walking exercise training group (TW) and arm swing walking incorporating Buddhist meditation exercise training group (ASW).....	83

TABLE	PAGE	
4.11	The comparison of physiological characteristics data among in sedentary control group (CON), traditional walking exercise training group (TW) and arm swing walking incorporating Buddhist meditation exercise training group (ASW) in pre-test.....	84
4.12	The comparison of physiological characteristics data among in sedentary control group (CON), traditional walking exercise training group (TW) and arm swing walking incorporating Buddhist meditation exercise training group (ASW)in post-test.....	85
4.13	The comparison of arm curl test (rep) between pre and post training in three groups: sedentary control group (CON), traditional walking exercise training group (TW) and arm swing walking incorporating Buddhist meditation exercise training group (ASW)..	86
4.14	The comparison of chair stand (rep/30 sec) between pre and post training in three groups: sedentary control group (CON), traditional walking exercise training group (TW) and arm swing walking incorporating Buddhist meditation exercise training group (ASW)...	87
4.15	The comparison of back scratch (cm) between pre and post training in three groups: sedentary control group (CON), traditional walking exercise training group (TW) and arm swing walking incorporating Buddhist meditation exercise training group (ASW)..	88
4.16	The comparison of chair sit and reach (cm) between pre and post training in three groups: sedentary control group (CON), traditional walking exercise training group (TW) and arm swing walking incorporating Buddhist meditation exercise training group (ASW).	89
4.17	The comparison of timed up-and-go (s) between pre and post training in three groups: sedentary control group (CON), traditional walking exercise training group (TW) and arm swing walking incorporating Buddhist meditation exercise training group (ASW)...	90

TABLE	PAGE	
4.18	The comparison of 6-minute walk test (m) between pre and post training in three groups: sedentary control group (CON), traditional walking exercise training group (TW) and arm swing walking incorporating Buddhist meditation exercise training group (ASW)...	91
4.19	The comparison of physical fitness data among in sedentary control group (CON), traditional walking exercise training group (TW) and arm swing walking incorporating Buddhist meditation exercise training group (ASW) in pre-test	92
4.20	The comparison of physical fitness data among in sedentary control group (CON), traditional walking exercise training group (TW) and arm swing walking incorporating Buddhist meditation exercise training group (ASW) in post-test	93
4.21	The comparison of resting diameter (mm) between pre and post training in three groups: sedentary control group (CON), traditional walking exercise training group (TW) and arm swing walking incorporating Buddhist meditation exercise training group (ASW)...	94
4.22	The comparison of peak diameter (mm) between pre and post training in three groups: sedentary control group (CON), traditional walking exercise training group (TW) and arm swing walking incorporating Buddhist meditation exercise training group (ASW)...	95

TABLE	PAGE	
4.23	The comparison of flow-mediated dilatation (%) between pre and post training in three groups: sedentary control group (CON), traditional walking exercise training group (TW) and arm swing walking incorporating Buddhist meditation exercise training group (ASW).....	96
4.24	The comparison of time to peak diameter (s) between pre and post training in three groups: sedentary control group (CON), traditional walking exercise training group (TW) and arm swing walking incorporating Buddhist meditation exercise training group (ASW)...	97
4.25	The comparison of shear rate at rest (s^{-1}) between pre and post training in three groups: sedentary control group (CON), traditional walking exercise training group (TW) and arm swing walking incorporating Buddhist meditation exercise training group (ASW)...	98
4.26	The comparison of peak shear rate (s^{-1}) between pre and post training in three groups: sedentary control group (CON), traditional walking exercise training group (TW) and arm swing walking incorporating Buddhist meditation exercise training group (ASW)...	99
4.27	The comparison of endothelial- dependent vasodilation variables among in sedentary control group (CON), traditional walking exercise training group (TW) and arm swing walking incorporating Buddhist meditation exercise training group (ASW) in pre-test.....	100

TABLE	PAGE	
4.28	The comparison of endothelial- dependent vasodilation variables among in sedentary control group (CON), traditional walking exercise training group (TW) and arm swing walking incorporating Buddhist meditation exercise training group (ASW) in post-test.....	101
4.29	The comparison of depression (score) between pre and post training in three groups: sedentary control group (CON), traditional walking exercise training group (TW) and arm swing walking incorporating Buddhist meditation exercise training group (ASW)..	102
4.30	The comparison of cortisol concentration (ug%) between pre and post training in three groups: sedentary control group (CON), traditional walking exercise training group (TW) and arm swing walking incorporating Buddhist meditation exercise training group (ASW).....	103
4.31	The comparison of depression score and cortisol concentration among in sedentary control group (CON), traditional walking exercise training group (TW) and arm swing walking incorporating Buddhist meditation exercise training group (ASW) in pre-test...	104
4.32	The comparison of depression score and cortisol concentration among in sedentary control group (CON), traditional walking exercise training group (TW) and arm swing walking incorporating Buddhist meditation exercise training group (ASW) in post-test.....	105
4.33	The comparison of cholesterol (mg/dl) between pre and post training in three groups: sedentary control group (CON), traditional walking exercise training group (TW) and arm swing walking incorporating Buddhist meditation exercise training group (ASW)...	106

TABLE	PAGE	
4.34	The comparison of triglyceride (mg/dl) between pre and post training in three groups: sedentary control group (CON), traditional walking exercise training group (TW) and arm swing walking incorporating Buddhist meditation exercise training group (ASW)...	107
4.35	The comparison of low density lipoprotein cholesterol (mg/dl) between pre and post training in three groups: sedentary control group (CON), traditional walking exercise training group (TW) and arm swing walking incorporating Buddhist meditation exercise training group (ASW).....	108
4.36	The comparison of high density lipoprotein cholesterol (mg/dl) between pre and post training in three groups: sedentary control group (CON), traditional walking exercise training group (TW) and arm swing walking incorporating Buddhist meditation exercise training group (ASW).....	109
4.37	The comparison of C-reactive protein (mg/l) between pre and post training in three groups: sedentary control group (CON), traditional walking exercise training group (TW) and arm swing walking incorporating Buddhist meditation exercise training group (ASW)..	110
4.38	The comparison of nitric oxide (nmol/ml) between pre and post training in three groups: sedentary control group (CON), traditional walking exercise training group (TW) and arm swing walking incorporating Buddhist meditation exercise training group (ASW)...	111
4.39	The comparison of interleukin-6 (pg/ml) between pre and post training in three groups: sedentary control group (CON), traditional walking exercise training group (TW) and arm swing walking incorporating Buddhist meditation exercise training group (ASW)..	112

TABLE	PAGE	
4.40	The comparison of white blood cell (cells/mm ³) between pre and post training in three groups: sedentary control group(CON), traditional walking exercise training group(TW) and arm swing walking incorporating Buddhist meditation exercise training group (ASW).....	113
4.41	The comparison of red blood cell (Mcell/mm ³) between pre and post training in three groups: sedentary control group (CON), traditional walking exercise training group (TW) and arm swing walking incorporating Buddhist meditation exercise training group (ASW).....	114
4.42	The comparison of hemoglobin (g/dl) between pre and post training in three groups: sedentary control group (CON), traditional walking exercise training group (TW) and arm swing walking incorporating Buddhist meditation exercise training group (ASW)...	115
4.43	The comparison of hematocrit (%) between pre and post training in three groups: sedentary control group (CON), traditional walking exercise training group (TW) and arm swing walking incorporating Buddhist meditation exercise training group (ASW).....	116
4.44	The comparison of blood chemical data in sedentary control group (CON), traditional walking exercise training group (TW) and arm swing walking incorporating Buddhist meditation exercise training group (ASW)in pre-test.....	117
4.45	The comparison of blood chemical data in sedentary control group (CON), traditional walking exercise training group (TW) and arm swing walking incorporating Buddhist meditation exercise training group (ASW)in post-test.....	118

LIST OF FIGURES

FIGURE		PAGE
2.1	Step care model for depression.....	28
2.2	Endothelial cell.....	29
2.3	Increasing oxidative stress in endothelial dysfunction associated to the elderly	36
2.4	Mechanism contributing to endothelial dysfunction and activation of inflammatory pathways	38
2.5	A proposed conceptual framework for the pathways connecting depression and cardiovascular disease.....	41
2.6	Conceptual framework.....	54
3.1	Arm swing walking incorporate with Buddhist meditation exercise.....	63
3.2	Procedure in part II.....	64
3.3	Protocol for ultrasound imaging.....	66
3.4	Imaging brachial artery diameters	66
4.1	Flowchart of participants flow.....	72
4.2	The comparison of resting heart rate (bpm) between pre and post training in three groups: CON, TW, ASW.....	75
4.3	The comparison of systolic blood pressure (mmHg) between pre and post training in three groups: sedentary control group (CON), traditional walking exercise training group (TW) and arm swing walking incorporating Buddhist meditation exercise training group (ASW).....	76
4.4	The comparison of diastolic blood pressure (mmHg) between pre and post training in three groups: sedentary control group (CON), traditional walking exercise training group (TW) and arm swing walking incorporating Buddhist meditation exercise training group	77

FIGURE		PAGE
4.5	The comparison of body mass (kg) between pre and post training in three groups: sedentary control group (CON), traditional walking exercise training group (TW) and arm swing walking incorporating Buddhist meditation exercise training group (ASW).	78
4.6	The comparison of body mass index (kg/m^2) between pre and post training in three groups: sedentary control group (CON), traditional walking exercise training group (TW) and arm swing walking incorporating Buddhist meditation exercise training group (ASW).....	79
4.7	The comparison of body fat (percentage) between pre and post training in three groups: sedentary control group (CON), traditional walking exercise training group (TW) and arm swing walking incorporating Buddhist meditation exercise training group (ASW).....	80
4.8	The comparison of maximum oxygen consumption (VO_2max ; ml/kg/min) between pre and post training in three groups : sedentary control group (CON), traditional walking exercise training group (TW) and arm swing walking incorporating Buddhist meditation exercise training group (ASW).....	81
4.9	The comparison of forced vital capacity; FVC (liters) between pre and post training in three groups: sedentary control group (CON), traditional walking exercise training group (TW) and arm swing walking incorporating Buddhist meditation exercise training group (ASW).....	82

FIGURE		PAGE
4.10	The comparison of forced expiratory volume at 1 second; FEV1 (liters) between pre and post training in three groups: sedentary control group (CON), traditional walking exercise training group (TW) and arm swing walking incorporating Buddhist meditation exercise training group (ASW).....	83
4.11	The comparison of arm curl test (rep) between pre and post training in three groups: sedentary control group (CON), traditional walking exercise training group (TW) and arm swing walking incorporating Buddhist meditation exercise training	87
4.12	The comparison of chair stand (rep/30 sec) between pre and post training in three groups: sedentary control group (CON), traditional walking exercise training group (TW) and arm swing walking incorporating Buddhist meditation exercise training group (ASW).....	88
4.13	The comparison of back scratch (cm) between pre and post training in three groups: sedentary control group (CON), traditional walking exercise training group (TW) and arm swing walking incorporating Buddhist meditation exercise training group (ASW).....	89
4.14	The comparison of chair sit and reach (cm) between pre and post training in three groups: sedentary control group (CON), traditional walking exercise training group (TW) and arm swing walking incorporating Buddhist meditation exercise training group (ASW).....	90

FIGURE	PAGE	
4.15	The comparison of timed up-and-go (s) between pre and post training in three groups: sedentary control group (CON), traditional walking exercise training group (TW) and arm swing walking incorporating Buddhist meditation exercise training group (ASW).....	91
4.16	The comparison of 6-minute walk test (m) between pre and post training in three groups: sedentary control group (CON), traditional walking exercise training group (TW) and arm swing walking incorporating Buddhist meditation exercise training group (ASW).....	92
4.17	The comparison of resting diameter (mm) between pre and post training in three groups: sedentary control group (CON), traditional walking exercise training group (TW) and arm swing walking incorporating Buddhist meditation exercise training .	95
4.18	The comparison of peak diameter (mm) between pre and post training in three groups: sedentary control group (CON), traditional walking exercise training group (TW) and arm swing walking incorporating Buddhist meditation exercise training group (ASW).....	96
4.19	The comparison of flow-mediated dilatation (%) between pre and post training in three groups: sedentary control group (CON), traditional walking exercise training group (TW) and arm swing walking incorporating Buddhist meditation exercise training group (ASW).....	97

FIGURE		PAGE
4.20	The comparison of time to peak diameter (s) between pre and post training in three groups: sedentary control group (CON), traditional walking exercise training group (TW) and arm swing walking incorporating Buddhist meditation exercise training group (ASW).....	98
4.21	The comparison of shear rate at rest (s^{-1}) between pre and post training in three groups: sedentary control group (CON), traditional walking exercise training group (TW) and arm swing walking incorporating Buddhist meditation exercise training group (ASW).....	99
4.22	The comparison of peak shear rate (s^{-1}) between pre and post training in three groups: sedentary control group (CON), traditional walking exercise training group (TW) and arm swing walking incorporating Buddhist meditation exercise training group (ASW).....	100
4.23	The comparison of depression (score) between pre and post training in three groups: sedentary control group (CON), traditional walking exercise training group (TW) and arm swing walking incorporating Buddhist meditation exercise training	103
4.24	The comparison of cortisol concentration ($\mu g\%$) between pre and post training in three groups: sedentary control group (CON), traditional walking exercise training group (TW) and arm swing walking incorporating Buddhist meditation exercise training group (ASW).....	104

FIGURE		PAGE
4.25	The comparison of cholesterol (mg/dl) between pre and post training in three groups: sedentary control group (CON), traditional walking exercise training group (TW) and arm swing walking incorporating Buddhist meditation exercise training group (ASW).....	107
4.26	The comparison of triglyceride (mg/dl) between pre and post training in three groups: sedentary control group (CON), traditional walking exercise training group (TW) and arm swing walking incorporating Buddhist meditation exercise training group (ASW).....	108
4.27	The comparison of low density lipoprotein cholesterol (mg/dl) between pre and post training in three groups: sedentary control group (CON), traditional walking exercise training group (TW) and arm swing walking incorporating Buddhist meditation exercise training group (ASW).....	109
4.28	The comparison of high density lipoprotein cholesterol (mg/dl) between pre and post training in three groups: sedentary control group (CON), traditional walking exercise training group (TW) and arm swing walking incorporating Buddhist meditation exercise training group (ASW).....	110
4.29	The comparison of C-reactive protein (mg/l) between pre and post training in three groups: sedentary control group (CON), traditional walking exercise training group (TW) and arm swing walking incorporating Buddhist meditation exercise training group (ASW).....	111

FIGURE		PAGE
4.30	The comparison of nitric oxide (nmol/ml) between pre and post training in three groups: sedentary control group (CON), traditional walking exercise training group (TW) and arm swing walking incorporating Buddhist meditation exercise training group (ASW).....	111
4.31	The comparison of interleukin-6 (pg/ml) between pre and post training in three groups: sedentary control group (CON), traditional walking exercise training group (TW) and arm swing walking incorporating Buddhist meditation exercise training group (ASW).....	112
4.32	The comparison of white blood cell (cells/mm ³) between pre and post training in three groups: sedentary control group (CON), traditional walking exercise training group (TW) and arm swing walking incorporating Buddhist meditation exercise training group (ASW).....	113
4.33	The comparison of red blood cell (Mcell/mm ³) between pre and post training in three groups: sedentary control group (CON), traditional walking exercise training group (TW) and arm swing walking incorporating Buddhist meditation exercise training group (ASW).....	114
4.34	The comparison of hemoglobin (g/dl) between pre and post training in three groups: sedentary control group (CON), traditional walking exercise training group (TW) and arm swing walking incorporating Buddhist meditation exercise training group (ASW).....	115

FIGURE		PAGE
4.35	The comparison of hematocrit (%) between pre and post training in three groups: sedentary control group (CON), traditional walking exercise training group (TW) and arm swing walking incorporating Buddhist meditation exercise training group (ASW).	116
5.1	Mechanism of the effects of arm swing walking incorporating Buddhist meditation exercise and traditional walking exercise	132

CHARPTER I

INTRODUCTION

Background and Rationale

Depression is a mental health problem that occur frequently in the elderly (Djernes,JK., 2006). The prevalence rate of depression was 10.9% in Europe, 8.4% in America and 4.2% in Asia (Lobo, A, et al.,1995; Barua, A. et al., 2011). Social theory of depression is that the ideas, perception, negative feeling about themselves lead to depression is often accompanied by the emotional disorder, loss of cognition, behavior change, and physical illness (Vink, D. et al., 2008). Similar to depression, vascular disease is very common in the elderly.

Depression and vascular disease may be bi-directionally related in the pathogenesis of respective diseases. Indeed, depression is a risk factor for the development and progression of coronary heart disease (CHD) (Skala, JA. et al., 2006; Parker, G. et al., 2010). Growing evidence suggests that depression may contribute to the onset of CHD by triggering endothelial injury (Skala, JA. et al., 2006; Parker, G. et al., 2011; Mae, M. et al., 2010). Recently research has also produced evidence of relationship between depression and attenuated Flow-mediated dilation (FMD) , Sherwood and co-worker (Sherwood, A. et al., 2005) reported that patients with depressive symptomatology had attenuated FMD when compared with patients that were not depressed. Recently, Cooper and co-worker (Cooper, DC. et al., 2011) reported that flow mediated dilatation (FMD) correlates with clinical or subclinical depression in healthy adults and cardiovascular patients. In addition, the lower of circulating EPC and impaired brachial FMD was associated with high depression score (Chen, H. et al., 2011). Depression is a accompanied by an increased expression of inflammatory markers including C-reactive protein (CRP) and Interleukin-6 (IL-6)

(Santos, M. et al., 2009). Baune and colleagues (Baune, B.T. et al., 2012) reported that significant increasing IL-6 level in the elderly aged 70-90 years. Inflammation markers especially IL-6 and CRP were increased more strongly in depressed when compared non-depressed participants (Weinstein, AA. et al., 2010). The inflammatory pathway underpin the common pathophysiology of depression results in pro-atherogenic effects and should be regarded as a risk factor to cardiovascular disorders (Maes, M. et al., 2010). The impairment of endothelial function may be a consequence of the inflammatory phenomena that occur in elderly with depression, and inflammatory was seen as key determinants of coronary disease progression (Santos, M. et al., 2009). CHF and MDD had significantly higher mean level of CRP, but not in those with CHF without MDD (Andrel, AM. et al., 2007).

Depressed patients have more sedentary lifestyle and decreased levels of physical activity due to low motivation and energy (Roshanaei-Moghaddam, B. et al., 2009). This is unfortunate because habitual exercise has been shown to decrease risk of CHD, diabetes and stroke in aging populations (Gordon, NF. et al., 2004; Metkus, TS. et al., 2010) and is a non-pharmacological method that used for the treatment on depression (National Institute for Health and Clinical Excellence, 2007). Many countries, including Thailand, choose a holistic concept in health promotion and use the mind and body approach that combines physical activities and mental exercises. Currently, the potential of mind and body modalities, such as yoga, tai chi, qigong, meditation have received much of interest. Yoga can improve psychological distress and physical problem. Accordingly, seven days intensive residential yoga program can reduce depression, improves spinal mobility in patients with chronic low back pain (Tekur, P. et al., 2012). Moreover, yoga improved maximal oxygen consumption and decreased inflammatory marker according to Pullen and co-worker (Pullen, PR. et al., 2008) reported that yoga in patients with chronic heart failure improved exercise tolerance and positively affected level of inflammatory marker. Tai chi has also found to be an

antidepressant effect (Krogh, J. et al., 2010). According to Yeung and co-worker (Yeung, A. et al., 2012), they reported that tai chi is feasible and safe in Chinese American patients with major depressive disorder for decreasing depressive symptoms. For the other mind-body modalities, Buddhist meditation practices have demonstrated efficacy in improving metabolic risk factors and decreasing psychological distress (Anderson, JG. And Taylor, AG., 2010). Buddhist meditation practices have been shown to reduce blood pressure similar to primary antihypertensive medication and then improving depressive symptoms (Matousek, RH. et al., 2010). Marchand (2012) reported mindfulness-based stress reduction (MBSR) that is systematic, attention-based strategy that focuses on the promotion of present moment awareness, have broad spectrum antidepressant effects and decrease general psychological distress. Although the mechanisms associated the changes of physiological and psychological effects of the mind-body modalities are not yet well understand, the observed changes likely occur through reducing the reactivity of the sympathoadrenal system, the hypothalamic pituitary adrenal axis and promoting feeling of well-being. Mind-body modalities may be association neuroendocrine responses, metabolic function and related inflammatory responses (Krough, J. et al., 2010).

In Thailand, beginning lead holistic concept applied to exercise since 1988. There was evidence demonstrated that jogging meditation exercise significantly improved the physical fitness and mental fitness when compared pre-post training (Kanungsukkasem, V. et al., 1991). Subsequently, Vorasetawut, T. and Suksom, D. (2010) found that running meditation can improve cardiorespiratory fitness and decreased side effect of menstruation in women and premenstrual syndrome and dysmenorrhea.

However, the mechanisms of mind and body exercise on depression is less clear. Moreover, the effect of mind and body exercise on aging endothelial dysfunction is still controversial. Some investigators found yoga and meditation appear to improve

endothelial function in subjects with CAD (Sivasankaran, S. et al., 2006). In contrast, some studies failed to show the improvement of aerobic capacity and endothelial function after Tai chi and Yoga practices (Suksom, D. et al., 2011; Hunter et al., 2012). Developing effective preventive and treatment programs that can act on both depression and vascular disease and are suitable for the elderly populations will be of paramount importance.

Walking meditation or mindful walking is a well-practiced form of Buddhist practices that focus on mind and body interactions (Matousek, RH., Dobkin, P.L., Pruessner, J., 2010). It incorporates the basic principles of traditional meditation performed in the sitting position, including breathing, awareness, concentration, and relaxation, with rhythmic exercise of walking (Luangpor Teean, 2005). In the present study, we created the customized walking meditation exercise that incorporates the spiritual movements of the arm swing by praying Budd-Dha during walking. In the practice, each step is taken after each breath being aware of the alternating intervals of contraction and relaxation involved with walking exercise. This form of exercise is amenable to the modern lifestyle and can be practiced easily by the elderly who has a number of limitations. The primary aim of this investigation was to determine the effects of arm swing walking incorporating with Buddhist meditation exercise on physical fitness, endothelium-dependent vasodilation, and depression levels in the elderly with depression. In order to assess the relative efficacy of this spiritual exercise, the results were compared with those obtained with the traditional walking exercises. Moreover, the associations between depression, inflammatory markers, and endothelium function were also examined.

Key Words

Arm swing walking, Meditation, Depression, Vascular function, Elderly

Research questions

1. What is the difference between the effects of arm swing walking incorporating with Buddhist meditation exercise program and traditional walking exercise program on endothelial dependent vasodilation in the elderly with depressive symptoms?

2. What is the difference between the effects of arm swing walking incorporating with Buddhist meditation exercise program and traditional walking exercise program on physical fitness in the elderly with depressive symptoms?

3. What is the difference between the effects of arm swing walking incorporating with Buddhist meditation exercise program and traditional walking exercise program on depression score in the elderly with depressive symptoms?

4. What is the difference between the effects of arm swing walking incorporating with Buddhist meditation exercise program and traditional walking exercise program on blood chemistry in the elderly with depressive symptoms?

Objectives

Main objectives

1. To determine the effects of arm swing walking incorporating with Buddhist meditation exercise program on endothelial dependent vasodilation in the elderly with mild to moderate depressive symptoms compared to traditional walking exercise.

2. To determine the effects of arm swing walking incorporating with Buddhist meditation exercise program on physical fitness in the elderly with mild to moderate depressive symptoms compared to traditional walking exercise.

Minor objectives

1. To determine the effects of arm swing walking incorporating with Buddhist meditation exercise program on depression score in the elderly with mild to moderate depressive symptoms compared to traditional walking exercise.

2. To determine the effects of arm swing walking incorporating with Buddhist meditation exercise program on blood chemistry in the elderly with mild to moderate depressive symptoms compared to traditional walking exercise.

Hypothesis

1. Arm swing walking incorporating with Buddhist meditation exercise program can improve endothelial dependent vasodilation in elderly with depressive symptoms more than traditional walking exercise.

2. Arm swing walking incorporating with Buddhist meditation exercise program can improve physical fitness in elderly with depressive symptoms more than traditional walking exercise.

3. Arm swing walking incorporating with Buddhist meditation exercise program can improve depression in elderly with depressive symptoms more than traditional walking exercise.

4. Arm swing walking incorporating with Buddhist meditation exercise program can improve depression in elderly with depressive symptoms more than traditional walking exercise.

Scope of the research.

This research aimed to create arm swing walking incorporating with Buddhist meditation exercise program and evaluate the effectiveness of the exercise program in the elderly. The scope of this study were as following:

1. A total of 45 female elderly with mild to moderate depression aged 60-90 years were recruited from the two welfare centers in Bangkok, Thailand. The inclusion criteria included mild to moderate depression as defined by Geriatric Depression Scale of 13-24 scores (Yasavage et al., 1986) and Thai Geriatric Depression Scale (TGDS;Train the Brain Forum Committee,1994);

normal mobility and independent self-care, no cardiovascular disease, no hypertension, and no diabetes mellitus; adequate ability for communication; no history of psychiatric illness and no current psychiatric medications.

The eligible subjects were randomly allocated into three groups; sedentary control group (CON; n=15), traditional walking exercise training (TW; n=15) and arm swing walking exercises incorporating Buddhist meditation (ASW, n=15).

1.1 The sedentary control group did not participate in exercise program and lived normal daily life.

1.2 The traditional walking exercise group was conducted at mild intensity (20-39% individually-determined heart rate reserve) to moderate intensity (40-50% heart rate reserve) performed for 30 minutes, 3 times a week for 3 months.

1.3 The arm swing walking incorporating with Buddhist meditation exercise group was conducted at mild intensity (20-39% individually-determined heart rate reserve) to moderate intensity (40-50% heart rate reserve) performed for 30 minutes, 3 times a week for 3 months.

2. The variables in this study included;

2.1 Independent variables included arm swing walking incorporating with Buddhist meditation exercise program and traditional walking exercise.

2.2 Dependent variables included physiological parameter, endothelium dependent vasodilation variables, biochemical parameters, physical fitness variables classified as follows.

- *Physiological parameters* including body mass , fat percentage, resting heart rate, blood pressure.
- *Endothelial dependent vasodilation variables* including flow mediated dilation, resting diameter, peak diameter, time to peak diameter, shear rate at rest and peak shear rate .
- *Biochemical parameters* including inflammatory marker composed of interleukin (IL-6) and C- reactive protein ,blood chemistry including white blood cells, red blood cells, hematocrit, lipid profile, nitric oxide and cortisol .
- *Physical fitness variables* including body composition, muscular strength, flexibility, balance and agility, maximum oxygen consumption (Vo₂max) and lung function.
- *Mental health variables* including the score of depression through measuring Thai Geriatric Depression Screening Scale (TGDS) instrument.

Operational definitions

The elderly is the person aged more than 60 years. In this study, we recruited the person aged 60-90 years with full consciousness to be participants.

The arm swing walking incorporating with Buddhist meditation exercise program is arm swing combine with Buddhism-based walking meditation by walking while

rhythmically swinging both arms by voiced “Budd” with arm swing up 30 ° and “Dha” with arm swing down 60°. The workload of the training program was increased by holding water bottle weight 500 ml in each hand in phase two (period 7-12 wk) of training.

Endothelial dependent vasodilation is the capacity of blood vessels to respond to physical and chemical stimuli in the lumen confers the ability to self regulate tone and to just blood flow and distribution in response to changes in the local environment. In this research we measured the endothelial dependent vasodilation using by ultrasound brachial artery , diameter change in response to reactive hyperemia (flow mediated dilatation ; FMD) .

Cytokine is small protein or glycoprotein substances formation of red blood cells and white cells response to physical stimuli. Cytokine effects on target cells by binding to receptor stimulate the immune system cells and cells of the inflammatory process. The inflammatory cytokine in this study included Interleukin6 (IL-6).

Depression is a syndrome with expression changes in four areas: emotion, cognition, physical and behavior. This study measured depression by Thai Geriatric Depression Scale (TGDS), created by medical professionals neurology, psychiatry, medicine, diseases of the elderly, psychiatric nurses, psychologists from 14 institutions across the country. The accuracy was 0.93 (Train The brain Forum Committee, 1994) consists of 30 questions and a score of 30 points to answer yes / no scores 0 and 1 is divided into 3 levels of depression.

Normal	0-12	points.
Mild depression	13-18	points.
Moderate depression	19-24	points.
Severe depression	25-30	points.

Lung function is total lung capacity refers to volume of air to breathe in and out of the lungs. This study using Spirometer.

Maximum oxygen consumption (Vo₂max) is the maximal oxygen uptake or the maximal volume of oxygen that can be utilized in one minute during maximal or exhaustive exercise. The Vo₂max in this study measured by submaximal oxygen uptake refer to maximal volume of oxygen using by 6 minute walk test.

Expected benefits and applications

1. An innovative exercise program appropriate to elderly with depressive symptoms was created. It could be extended to other aging society, community and country.
2. A new knowledge of the benefits of exercise with a combination of both mental and physiological changes and the empirical evidence were occurred. It can be applied from research to practice for the elderly.
3. The results of this study can be a guide for improving physical, mental health, and promoting a better quality of life.

CHAPTER II

LITERATURE REVIEW

The literatures associated this study were explored and present in this chapter as followed:-

1. The elderly

1.1 Definition of the elderly

1.2 Situation of the elderly in Thailand

1.3 Changing physiology in the elderly

1.4 Health problems in the elderly

1.5 Policy of government involve the elderly

2. Depression

2.1 Definition of depression

2.2 Prevalence and epidemiology of depression in the elderly

2.3 Theory and concepts depression in the elderly

2.4 Sign and symptoms of depression

2.5 Assessment of depression

2.6 Measuring depression in the elderly

2.7 Treatment of depression

3. Endothelial cell

3.1 Anatomy and physiology of endothelial cell

3.2 Endothelial cell dysfunctions in the elderly

3.3 Depression and endothelial dysfunction

3.4 Clinical assessment of endothelial function

4. Exercise in the elderly

4.1 Principle of exercise

4.2 Components of the training session

4.3 Benefits of exercise

4.4 Mind and body exercise

5. Related research studies

5.1 National studies

5.2 International studies

6. Conceptual framework

1. The elderly

1.1 Definition of the elderly

The elderly was defined the person aged more than 60 years (UNEP, 2006). In Japan, the term "elderly" has been defined as a chronological age of 65 years or more (Orimo, H., Kamiya, N., 2008). In Thailand, " the elderly" was defined as people over 60 years old(Knodel, J. and Chayowan, N., 2008).

1.2 Situation of the elderly in Thailand

Thailand entered into period of "the aging society" since 2005 and completely in 2010. The number of the elderly person is continuous increasing over the next 25 years. In 1950, population of elderly enlarged 5 percent in total population and seventh range from eleven countries in South-East Asia, and then the elderly moved up to be the second range in present (more than 10 percent). In 2015, the proportion of the elderly in Thailand will increase 14 percent, 19 percent in 2025, approximately 30 percent in 2030. This is a result of mortality rate and birth rate decline, medical service advances therefore, effects to longevity the person. The life expectancy of the elderly at aged 80 years. Currently, the elderly with aged 80 or more than increase approximately to 590 thousand, expected will increase 1.3 million in 2025 (UNEP, 2006). The dependency

ratio in the elderly increased approximately 17.6-24.6 percent in 2010-2020 (Ministry of public health and ministry of social development and human security, Thailand, 2007).

1.3 Changing physiology in the elderly

The physiological in the elderly mostly changes that become with increasing of age. The physiological changes cause by deterioration of organ systems and tissues consequently impairs functional of these organ system. The physiological changes that frequently occur in the elderly are considered below.

Respiratory system

Total respiratory systems in the elderly compliance including lung and chest wall compliance decrease. Lung volumes are declining. Total lung capacity (TLC), Forced vital capacity (FVC), and Vital capacity are decreasing when entered to the elderly. Whereas, residual volume (RV) rising and functional residual capacity (FRC) remains constant. Arterial oxygen pressure decreases due to imbalance in ventilation and perfusion functions of the elderly. The alveolar dead space increases whereas the elasticity of lung decrease thus affects alveoli collapse simplicity. The maximum voluntary ventilation and forced expiratory volume in 1 second (FEV_1) was decreased (Sharma, G. and Goodwin, J., 2006).

Cardiovascular system

Cardiac functions in the elderly decrease due to cardiac muscle hypertrophy specially left ventricle and less response to catecholamine affects to reduce stroke volume, ventricle contractility , cardiac output then blood supply to peripheral vascular decline. The vessels are medium-large become loss elasticity and imbalance vasoconstriction and vasodilation. Cardiac conducting cell decrease function therefore, induces arrhythmias simplicity in the elderly (Lata, H. and Alia, L.W., 2007).

Musculo-skeletal system

Lean body mass is declined due to atrophy of the muscle cell. Muscle tone and muscle strength decrease especially muscle of diaphragm affect to effectiveness breathing.

Impairment function of bones and joints, bone density reduction affect to bone disease in elderly specially osteoporosis. Weight bearing capacity decrease lead to possibility spontaneous fracture in the elderly. The inflammatory process in the joints increase leading to arthritis (Lata, H. and Alia, L.W., 2007).

Skin

The elasticity of skin reduce due to impairment functions of sebaceous gland, secretion sebum decline. Pacinian's corpuscle, Meissner's corpuscle decrease lead to perception to pain, heat, cold, and injury reduced. There is also an "age spots" due to a decreased in melanin pigment. The hair loses production of pigment and changed the color from black to gray. The nails is thickness due to decrease blood supply to the connective tissue (Lata, H. and Alia, L.W., 2007).

Gastrointestinal system

The digestive enzymes and saliva decrease production result in gastrointestinal function impairment, delayed swallowing. The esophagus reduces peristaltic response, an increased non peristaltic response and slow empty of the stomach. The absorption of nutrients delay consequent the elderly have nutrition deficiency. The colon hypotonic and motility decreased lead to constipation. Loss of regulation of internal and external anal sphincters in the elderly result in fecal incontinence (Lata, H. and Alia, L.W., 2007).

Endocrine system

The endocrine system in the elderly associated decline production of hormone. Estrogen and testosterone concentration decrease whereas luteinizing hormone, follicle-stimulating hormone and sex hormone-binding globulin increase. Furthermore, growth hormone, insulin-like growth factor-I decrease production. The function of hypothalamic-

pituitary-adrenal axis impairs. These are caused of organ functions impairment with related hormone deficiencies such as declined protein synthesis, reduced in lean body mass and bone mass, induced fat mass, insulin resistance, higher cardiovascular disease risk, increase in vasomotor symptoms, fatigue, depression, anemia, poor libido, erectile deficiency and a decline in immune function (Chahal, HS. and Drake, WM., 2007)

Nervous system

The central nervous system and peripheral nervous system in the elderly are impairment. The central nervous system impairs consist of reduction in brain weight , gathering of lipofuscin, iron and other pigment bodies, reduction in the concentration of acetylcholine, noradrenaline, dopamine, GABA and NMDA receptors, and decreased in the components of myelin and intracellular enzyme. These causes affect to delayed sensory stimuli. The peripheral nervous system decreased compose deterioration of the anterior horn cell, neuromuscular junction, muscle and dorsal root ganglia, decreased in density of myelinated fibres in spinal roots affect to delayed of motor and sensory conduction velocity (Wickremaratchi, M. and Llewelyn, JG., 2006).

1.4 Health problems in the elderly

Health status is an important indicator of well-being and quality of life of the elderly. In addition to, there are no financial problems and must have a good mental and physical health as well. However, past studies have shown that more people live longer. Does not mean that health can be improved by finding that the elderly are faced with a chronic illness increases, disability, dependent on the others for daily activity. The many health problems caused by the aging process in the elderly. The survey of prevalence of health problems in the elderly found that prevalence of hypertension is 29.9% in female live in urban more than rural(17.1%). Second, Osteoarthritis is 24.2% in urban more than

18% in rural. Third, heart diseases are 12.1 in urban more than 8.5 in rural (Ministry of Public Health and Ministry of Social Development and Human Security, 2007).

Table 2.1 prevalence of diseases (percent) Thai elderly.

Diseases	Male		Female	
	Urban	Rural	Urban	Rural
Hypertension	19.2	12.9	29.9	17.1
Osteoarthritis	12.9	12.7	24.2	18
Heart diseases	8.1	3.8	12.1	8.5
Diabetes mellitus	11.0	2.3	12.7	4.6
Paralysis (major stroke)	6.1	2.1	2.8	1.2

(Ministry of Public Health and Ministry of Social Development and Human Security, 2007)

Hypertension is the most common chronic diseases in the elderly. The prevalence is higher in female and living in urban (29.9 %). The hypertension increases in the elderly due to changing hormone, vascular structure and increased peripheral vascular resistance. Hypertension can lead to cardiovascular diseases, renal failure, and stroke (Joseph, L. and Izzo, JR., 2001).

Osteoarthritis increase frequency in the elderly. Osteoarthritis is complex etiology of this disease, which includes joint stability, imbalance between anabolic morphogens, growth factors and catabolic cytokines (Reddi, A.H., 2006) .

Heart diseases are the most common cause of mortality rate in the elderly. The prevalence of valvular heart diseases, congestive heart disease and cardiac arrhythmias increases. In addition to, hyperlipidemia is risk factor of cardiovascular diseases in the elderly. Hyperlipidemia is a major cause of vascular dysfunctions. Lipid

play an important role in vessels dysfunctions as result of the formation fatty steak, fibrous plaque (Aronow, WS., 2006).

Diabetes mellitus has increased in the elderly due to changing in beta cell function and insulin resistance. The prevalence of diabetes mellitus is higher in men as same as female (Aronow, WS., 2006).

1.5 Policy of government involve the elderly

The policy of the elderly was presented within The National Plan for the older person. Currently, Thailand developed into the second National Plan for the older person period (2002-2021) and developed the five strategies for practice are as follows (Sutichai Jitapunkul and Suvinee Wivatvanit, 2009).

1. Strategies in the preparation for the elderly with quality consists of 3 measures which cover the following issues:

- extension of income security for old age to cover the population in general
- life-long education
- public education of the importance and the dignity of old age

2. Strategies for encouraging and promoting in the elderly consists of 6 measures which cover the following issues:

- health promotion, disease prevention and self care among the elderly
- enhancing the co-operation and strength of organizations and networks dealing with elderly
- promoting income security and employment for the elderly

- supporting the potential and value of elderly
- encouraging the mass media to broadcast programs and encouraging for the elderly to have access to various forms of information
- providing the elderly with proper living environments

3. Strategies of social security for the elderly

- income security and employment in old age
- health security
- family - caregivers and protection rights of older persons
- service systems and support networks.

4. Strategies of management systems for elderly at the national level and in personnel development

- management systems at the national level
- personnel and caregiver education and training.

5. Strategies of research to support policy and program development including monitoring and evaluation of the Second National Plan for Older Persons

- promoting and supporting research on older persons which focus on policy and program development
- promoting and supporting research relevant to older persons (The research should focus on policy and program development, service improvement and other knowledge which is useful for the improvement of older persons' quality of life)

- developing mechanisms for continuous monitoring and evaluation of the Second National Plan for Older Persons.

2. Depression

2.1 Definition of depression

Depression is a person feels sad about something in particular, and the feeling is usually associated with some loss. Sometime depression was used to describe the sense of grief, bereavement, despair and hopelessness (Mondimore, FM., 2006).

Depression is defined as a mood disorder expressed through emotions, such as feeling unworthy, tearful, down hearted and weary, and expressed through thought of being unworthy or bad including behavior expressed, they are aggressive or isolate themselves (Department of Mental Health, 2006).

2.2 Prevalence and epidemiology of depression in the elderly

Depression is mental problem in worldwide. In Japan, the study showed that the prevalence of depression was 3 percent, 17percent in US , In North America, was 3–5 percent for males and 8–10 percent for females (Andrade, L. & Caraveo, A., 2003; Kessler, RC., Berglund, P., Demler, O., 2003; Jin, R., Merikangas, KR., Walters, EE., 2005).

In Thailand , the prevalence of depression was 12.78 percent, of which 8.23 percent had only depressive symptomatology (male 5.43%, female 9.63%) while 4.55 percent had both depression and cognitive impairment (male 2.8%, female 5.54%). The point incidence (one year) of depression was 7.27 (male 1.58%, female 5.68%). The major cause in depression was financial, poor family relationships and physical illness (Orapun Thongtang, 2002).

2.3 Theory and concept of depression in the elderly

Theorists, psychologists, educators and the others involved describe the process of depression using by the psychological theory as follows:

2.3.1 Physical concepts were described by genetic transmission and biochemical Theory.

2.3.1.1 Genetic transmission believe that depression is something that people carry with congenital hereditary. The results show that if one parent is suffering from depression. The chance of depression by 27 percent, while both parents are depressed. Children are likely to be suffering from depression and 54 percent in groups genuine twin brothers who were born from the same egg depression as high as 70 percent . There is evidence found that X chromosome has a direct effect on the depression of a person so that chromosome is characterized by a female (XX) gene expression to depression higher than male (XY). This is consistent with numerous studies found that prevalence of depression in women is higher than men about 2-3 times (Yulug, B., Ozan, E., Gonul, AS., Kilic, E., 2009).

2.3.1.2 Biochemical Theory believes that depression caused by the imbalance concentration of neurotransmitter in the brain which is primarily focused on monoamines (especially norepinephrine and serotonin). There is some evidence that the concentration of neurotransmitters norepinephrine and serotonin is declined in the elderly and decreased sensitivity of postsynaptic cell receptors. These are responsible for the physiological effect on mood (Jylha, P., Melartin, T., and Sometsa, E., 2009). In addition to, depression involve the dysregulation of hypothalamus-pituitary-adrenal feedback. Depression in the elderly leads to elevated cortisol concentration (Vreeburg, S.A. et al., 2009).

2.3.2 Psychological concepts were described by cognitive theory, psychoanalytic theory and grief and loss theory.

2.3.2.1 *Cognitive theory* believes that depression is caused by the accumulation of negative thoughts, dysfunctional beliefs. There are three domains dysfunctional belief themes such as thoughts of self, environment, future. These are described as the negative cognitive triad. This affects to failure of information processing. Depressed person will demonstrate worthless, separated from friends and society, feeling hopeless about the future (Pedersen, D.D., 2005).

2.3.2.2 *Psychoanalytic Theory*: Sigmund Freud, who introduced psychoanalysis. Freud described depression (melancholia) as loss of an internal quality such as self-esteem during the crisis deriving from a child's discovery of his inability to assume the social and sexual role of the same sex parent. Freud believes that depression due to a conflict between the ego (the conscious self) and the superego (an inner voice, something like an internalized parent). The superego punishes the ego for having forbidden wishes result in guilt, self-hate and anger leading to depression (Berry, K., Barrowclough, C., Wearden, A., 2008).

2.3.2.3 *Grief and Loss Theory*: John Bowlby who introduced adult mental health required a young child to experience a close and loving relationship with its mother. There are important two ideas, one idea reveal that a traumatic loss early in life may predispose depression of the person and the other reveal that a subsequent loss or separation in adulthood may serve as stimulus to depression (Maurit, M. and Meijel, B.V., 2009).

2.3.2.4 *Learned helplessness Theory*: This theory believe that depression is based on the sense that one has no control over life events and the sense that no one can do anything about life's event. This theory reveal that it is no specific event that causes depression but, it is the individual's belief that there is nothing either anyone else can do to make thing better.

2.3.3 *Environmental stimulus concepts were* described by social theory. This theory believes that depression is based on social environment of person. Changing in

environment including job change, any major loss, such as a divorce or death of loved one, a problem in the study, failure to work, sickness can lead depression. In addition, the severity of situation and social support will affect adaptation, stress, anxiety, guilt, separation from social lead to depression at the last.

2.4 Symptoms of depression

The symptoms point to depression as follows:

Depressed mood

- Pervasive, constricted quality of depression
- Feeling of guilt and inadequacy
- Fearful, overwhelmed feelings
- Onset of fear of being alone
- Diurnal variation in mood
- Preoccupation with failure, illness, or other unpleasant themes
- Nightmares, especially with theme of loss, pain, or death
- loss of ability to experience pleasure
- Indecision
- Onset of unexplained anxiety, panic attacks

Vegetative signs

- Sleep disturbance (too much or too little, especially with early morning awakening)
- Appetite disturbance (increased or decreased, usually enough to cause weight change)

- Fatigue, low energy
- Vague aches and pains, heaviness in chest
- Constipation
- Loss of interest in sex
- Poor concentration, slowed thinking(psychomotor retardation)

2.5 Assessment of depression

Depressive symptoms in persons are vary and the person complaint not clear, then assessment process is important. Identifying person with depression as follow:

1. Assessment alert to possible depression (particularly in persons with a past history of depression or chronic physical health problem related to functional impairment) using by the questions: During the last month, have you often been feeling down, depressed or hopeless?
2. If the person answer “yes” to either question, practitioner who is competent in mental health assessment should review the person ’s mental state and associated functional, interpersonal and social difficulties using by a validate measure for symptoms.
3. Explore how the following may have affected the development, course and severity of the depression: history of depression and comorbid mental health or physical disorders, any past history of mood elevation, response to previous treatments, the quality of interpersonal relationships, living conditions and social isolation,
4. In conditioning, the person has a learning disability or acquired cognitive impairment. The practitioner must consider consulting a relevant specialist when

developing treatment plans (National Institute for Health and Clinical Excellence, 2007).

2.6 Measuring depression in the elderly

2.6.1 Hamilton Rating Scale for Depression (HAM-D)

The HAM-D was created as a measure of treatment outcome rather than a screening or diagnostic tool for depression (Hamilton, M., 1960). However, the HAM-D is commonly used as a screening scale, particularly in the context of clinical trials to try to identify participants with depressive disorders. The HAM-D consists of a 21-item rating scaled used to systematize clinical observations of features related to depression. Ten items are ranked on a scale from 0 to 4; 9 items are ranked 0 to 2; and 2 items are ranked 0 to 3. Typically, a break score of 18-20 is used to differentiate persons with probable depressive disorder (Clayton, AH. et al., 1997).

2.6.2 Zung Self-Rating Depression Scale (SDS)

The SDS was initially created as a self-rating scale (Zung, WWK., 1965). It has been used widely in epidemiological studies and composes of 20 items. One criticism of the SDS is that it uses graded responses (i.e. never, sometimes, usually, always) that may be confusing to elderly patients; thus, they may require some assistance from the examiner or others to complete the form. Another problem with the test is that the mean score for elders is significantly higher than that for younger subjects, with many normal elders assessed as false-positives (Zung, WWK, 1975). Moreover, the SDS often misses depression in the elderly if depression takes the form of multiple somatic complaints (Raft D. et al., 1977). Many problems, the SDS not be used for either research or clinical assessment of geriatric depression (Carroll, BJ., Fielding, JM., Blashki, TG., Myers, JK., Weissman, MM., 1980).

2.6.3 *Montgomery-Asberg Depression Rating Scale (MADRS)*

The MADRS is particularly sensitive to measuring change in symptoms with outcome of treatment (Montgomery, SA., Asberg, M., 1979). The MADRS is an observer-rated scale that is based on a clinical interview that moves from broad questions to more detailed ones. There are 10 questions, but each question has 6 possible ratings and covers core symptoms of depression, such as sadness; sleep difficulties; changes in appetite and concentration; and pessimistic and suicidal thoughts. It does not assess somatic symptoms, which may be important in the elderly population (Waltis, JP. et al., 1993).

2.6.4 Geriatric Depression Scale (GDS)

The GDS was designed to identify the pattern of depressive symptoms from the general characteristics of the elderly population. It originally contained 100 items, but this number was condensed to 30 questions that indicate presence of depression. The scale was designed as a self-administered test, although it has been used in observer-administered formats as well. One advantage of the test is the "yes/no" question format, which may be more acceptable in the elderly population. It was initially validated among patients hospitalized for depression and among normal elderly living in the community without complaints of depression or history of psychiatric illness (Yesavage, JA., 1982). A cutoff score of 11 on the GDS yields an 84% sensitivity rate and a 95% specificity rate. Thus, it has been suggested that scores of 0-10 be viewed as in the normal range and scores of 11 or more being a possible indicator of depression (Brink, TL. et al., 1982). The GDS is a valid measure of depression in elderly, but not valid in the elderly with cognitive impairment. The GDS is available in several languages, which may be useful in a variety of epidemiological and clinical settings. A collateral source version of the GDS has been developed, although not extensively tested, which may prove useful as a screening instrument in those with aphasia, other communication deficits, or cognitive impairment (Burke, WJ. et al., 1995).

2.6.5 Depression Scales for Patients with Dementia (DSD)

Depression scales for patients with dementia was developed for use in demented populations, which use outside informants (caregivers, nursing home staff) to provide history and reliable symptoms reporting. As noted above, GDS has not been validated in a demented population. The studies have suggested that information gathered by outside sources reveals more depressive symptoms than dementia patients admit themselves. One study that instructed caregivers to fill out traditional depression scales showed that caregivers are reliable surrogate reporters of depressive symptoms in patients with Alzheimer's disease (Logsdon, RG., Teri, L., 1995). The best validated scale for dementia patients is the Cornell Scale for Depression in Dementia (CSDD). The CSDD is an interviewer-administered scale that uses information both from the patient and an outside informant. The scale has correlated well with depression as classified by the Research Diagnostic Criteria. Factor structure analysis reveals 4 to 5 factors that are assessed by the CSDD, including general depression, biologic rhythm disturbances, agitation/psychosis, and negative symptoms. However, even the CSDD has been better validated in patients with mild to moderate dementia, compared with patients with severe dementia (Holroy, S.D. and Clayton, AH., 2000).

2.7 Treatment of depression

Depression can be managed in primary and general medical care. NICE recommends stepped –care approach for person with mild depression (Figure 2.1), recent onset. Psychosocial treatment, antidepressant medication are used for treatment. The medication is used base on the balance of risk and benefits (Symond, S. and Anderson, I., 2012).

2.7.1 Medication: Medication is used to treat people with severe depression or depression with complications. Antidepressant medications affect the function of the brain that control thought, emotion, perception, and behavior expression and affect to

the synthesis or destruction of neurotransmitters in the brain which have a direct effect on depression.

2.7.2 Electroconvulsive therapy (ECT): ECT is used for severe depression with complication, failure using medications, high risk suicidal case. ECT used recording electroencephalogram (a measurement of electrical activity of the brain) through the same electrodes use to deliver the stimulus, so that the physician can see how long the induce seizure, usually twenty-five to forty-five seconds.

2.7.3 Limiting behavior: Limiting behavior is used for those with severe depression and cannot control themselves.

2.7.4 Psychotherapy consisted of as follow:

Low-intensity (subthreshold and mild depression)

- Guided self-help based on CBT principles
- Computerized CBT
- Structured group physical exercise.

High-intensity (persistent milder depression, moderate to severe depression)

i) Individual therapy

- CBT (addressing negative thoughts and associated behavioral patterns)
- Behavioral activation (addressing unrewarding behavioral patterns and withdrawal)
- Interpersonal psychotherapy (addressing relationship and role difficulties)

ii) Group therapy

- Individual therapies delivered in a group settings

- Couples therapy (focusing on partner interactions and conflicts)
- Mindfulness-based cognitive therapy for relapse prevention (includes meditation techniques, bodily awareness and self-acceptance)

iii) CBT, cognitive behavioral therapy

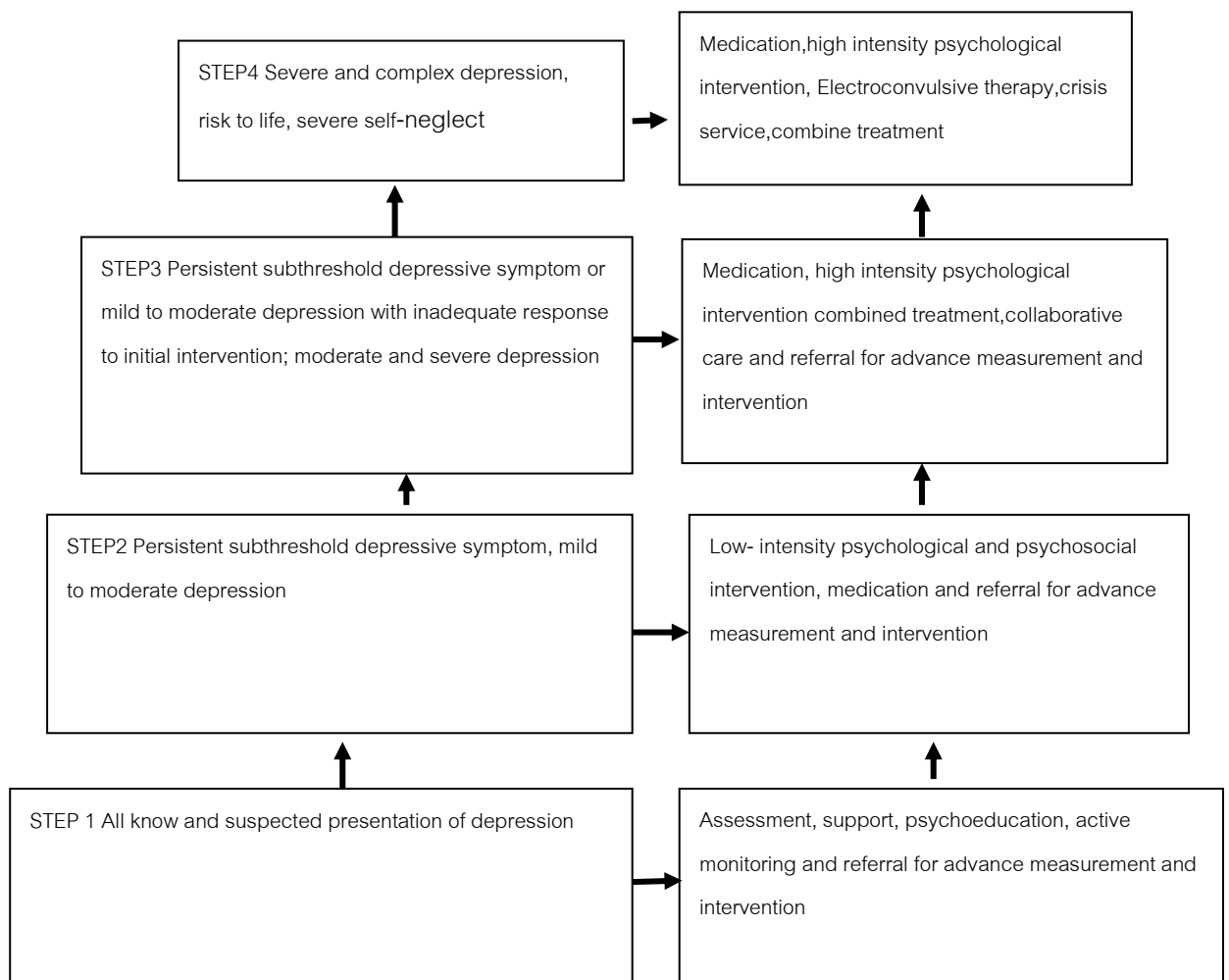

Figure 2.1 Step care model for depression (National Institute for Health and Clinical Excellence, 2007)

3. Endothelial cell

3.1 Anatomy and physiology of endothelial cell

The endothelium is a monolayer of cells lining the inside of all blood vessels (Figure 2.2).

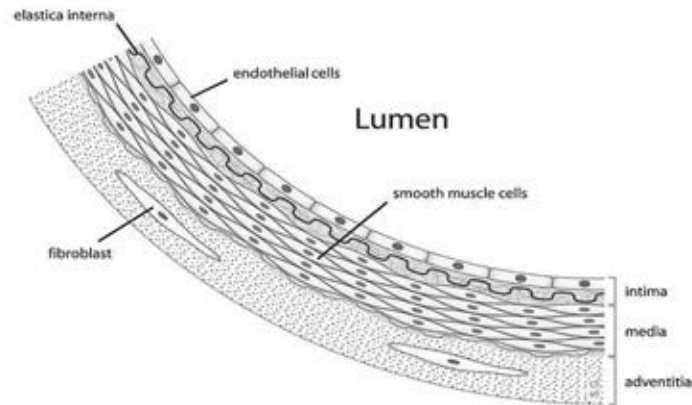

Figure 2.2 Endothelial cell (Herrera, MD. et al., 2010)

The total weight of the vascular endothelium in a normal adult is approximately 3 kg. In larger blood vessels, the endothelial cells form a selective barrier preventing the transfer of most substance contained in blood, while permitting, or facilitating (active transport), the transfer of the others (i.e. insulin, lipoproteins). Additionally, the endothelial cells are metabolically active, in that they take up and transform different substances such as norepinephrine and various prostaglandins, as well as the serotonin released by platelets. The endothelial membrane also contains converting enzyme which not only transforms angiotensin I into a potent vasoconstrictor peptide, angiotensin II, but also breaks down kinins, in particular bradykinin, to inactive peptide (Caterina, RD., Libbly, P., Gimbrone, M A., 2007)..

In 1980, Furchgott and Zawadzki explained yet another endothelial cell function. They discovered that the presence of endothelial cells was required to elicit relaxation in an isolated artery in response to acetylcholine. This discovery triggered a major inquiry into the role of endothelial cells in the local control of vasomotor tone. Endothelial-

dependent relaxation was shown to be due to the release of one or more vasodilator substances termed endothelium-derived relaxing factor (EDRF). In recent years, it has become evident that not only acetylcholine but a host of other neurohumoral mediators can trigger the release of these substances. The principle of endothelium-mediated vasodilation is now established not only in vitro but also in the whole organism, and in particular in the human. After that it also became evident that in some blood vessels, particularly peripheral veins, stimuli causing endothelium-dependent relaxation of large arteries could produce the reverse, namely endothelium-dependent contractions and then endothelial control is exerted by release of vasoactive substances termed endothelium-derived contracting factors (EDCF). Endothelial cells can produce at least three substances which cause relaxation of vascular smooth muscle: nitric oxide, endothelium-derived hyperpolarizing factor (EDHF) and prostacyclin (Caterina, RD., Libbly, P., Gimbrone, M A., 2007).

3.1.1 *Regulatory functions of endothelium*

The normal endothelium regulates vascular tone and structure and exerts anticoagulant, antiplatelet, and fibrinolytic properties. The maintenance of vascular tone is accomplished by the release of numerous dilator and constrictor substances (Table 2.2). A major vasodilative substance released by the endothelium is nitric oxide (NO), originally identified as endothelium-derived relaxing factor (EDRF). Other endothelium-derived vasodilators include prostacyclin and bradykinin. Prostacyclin acts synergistically with NO to inhibit platelet aggregation. Bradykinin stimulates release of NO, prostacyclin, and endothelium-derived hyperpolarizing factor, another vasodilator, which contributes to inhibition of platelet aggregation. Bradykinin also stimulates production of tissue plasminogen activator (t-PA), and thus may play an important role in fibrinolysis (Kojda, G . and Hambrech, R., 2005)

The endothelium also produces vasoconstrictor substances, such as endothelin (the most potent endogenous vasoconstrictor identified to date) and angiotensin II. Angiotensin II not only acts as a vasoconstrictor but is also pro-oxidant and stimulates

production of endothelin. Endothelin and angiotensin II promote proliferation of smooth muscle cells and thereby contribute to the formation of plaque. Activated macrophages and vascular smooth muscle cells, characteristic cellular components of atherosclerotic plaque, produce large amounts of endothelin (Madamanchi, N.R. and Runge, M.S., 2007).

Damage to the endothelium upsets the balance between vasoconstriction and vasodilation and initiates a number of events/processes that promote or exacerbate atherosclerosis; these include increased endothelial permeability, platelet aggregation, leukocyte adhesion, and generation of cytokines. Decreased production or activity of NO, manifested as impaired vasodilation, may be one of the earliest signs of atherosclerosis.

Table 2.2 Vasoregulatory substances synthesized by endothelium (Caterina, RD., Libbly P., Gimbrone M A., 2007).

Substance	Properties	Secretion/expression	Precursor compound
Nitric oxide (NO)	Vasorelaxing agent; inhibits leukocyte adhesion, exerts antiplatelet properties; inhibits SMC migration and proliferation.	Constitutive and inducible expression. Production is increased by thrombin, ADP, shear stress, cyclic strain, and cytokines	L-arginine
Prostacyclin (PGI ₂)	Antiplatelet and vaso relaxing agent	Constitutive and inducible expression at sites of vascular perturbation by pro-inflammatory agents	Arachidonic acid
Endothelium-derived hyperpolarizing factor(EDHF)	Vasorelaxing agent	Induced by acetylcholine, bradykinin, and shear stress	Arachidonic acid
Angiotensin-converting enzyme(ACE)	Catalyzes the conversion of Ang I into Ang II, which causes vasoconstriction.	Endothelial surface	Angiotensin I
Endothelin (ET-1)	Cause vasoconstriction and proliferation of smooth muscle cell	Induced by hypoxia, shear stress, and ischemia	Prepro endothelin-1

Nitric oxide (NO) was found to have major similarities to EDRF. NO is responsible for the vasodilator effect of nitrates, which also stimulate soluble guanylate cyclase. NO is formed enzymatically in the endothelial cell from a semi-essential amino acid: L-arginine. The enzyme involved has been called NO synthase, and is constitutive in normal endothelial cells. The transformation of L-arginine to L-citrulline in the presence of nicotinamide adenine dinucleotide phosphate (NADPH) derived electrons, a reaction catalyzed by NO synthase (NOS), which exists as three isoforms. NOS III

(endothelial NOS; eNOS) is a constitutive endothelial cell enzyme that continuously produces small amounts of NO. The high-capacity inducible form type II and the constitutive neural form type I comprise the two other forms of NOS. Exposure of macrophages, smooth muscle cell, and endothelial cell to cytokines such as interleukin(IL-1), and TNF- α can induce type II NOS, which produces large amounts of NO during inflammatory process. They all require a number of cofactors and prosthetic groups for their activity, including flavin adenine dinucleotide(FAD), flavin mononucleotide(FMN), heme, calmodulin(CaM), and tetrahydrobiopterin (BH₄). NO has half-life approximately 3-5 seconds when produced by endothelial cell. Endothelial cell release NO into the bloodstream where, before inactivation by oxyhemo-globin, NO can remain biologically active in close proximity to the endothelial surface, thus inhibiting leukocyte adhesion, augmenting fibrinolysis, and inhibiting platelet adhesion and activation synergistically with prostacyclin (Madamanchi, N.R. and Runge, M.S., 2007).

Prostacyclin, thromboxane, leukotrienes, and hydroxyl-eicosatetraenoic acids formed from polyunsaturated 20-carbon fatty acids, including the most abundant and the most biologically prominent precursor, arachidonic acid (AA). Prostaglandins H₂ (PGH₂) has half-life approximately 5 min in aqueous media, causes vasoconstriction, and undergoes further enzymatic conversion into several PGs such as PGD₂, PGE₂, PGF₂- α or PGI₂. Prostanoids signal through a series of seven-membrane spanning G-protein-coupled receptors. Through activation of the IP receptor present on smooth muscle cell and platelets, PGI₂ causes vasodilation and inhibits platelet aggregation (Newaz, M.A. et al., 2006).

Endothelium-derived hyperpolarizing factor (EDHF): In the early 1980s, several lines of evidence began to indicate that the release of either NO or PGI₂ did not fully explain endothelium-dependent relaxation. The observation that this process involves hyperpolarization of the target vascular SMC, causing relaxation without increased intracellular level of cyclic nucleotide, lead to the concept of "endothelium-derived hyperpolarizing factor"(EDHF). EDHF would transduce its cellular effects by either directly or indirectly opening K⁺ channels on vascular SMC, or through a

hyperpolarization of endothelial cell, facilitating the electrical coupling between EC and vascular SMC. The release of EDHF by endothelial cell is also controlled by the cytosolic calcium concentration, and is inhibited by calmodulin antagonist. The endothelial cell membrane receptor responsible for the acetylcholine-induced release of EDHF differs pharmacologically from that releasing EDRF-NO, given that the first belongs to the muscarinic M₁ subgroup, and the second to either the M₂ or M₃ subgroup (Newaz, M.A. et al., 2006).

Endothelins: Endothelins are well-characterized and potent vasoconstrictors. Endothelial cell release 75% of their endothelin abluminally, toward SMC, the remainder enters the vessel lumen, so that the plasma of normal healthy subjects has low levels of ET-1. Stimulation of SMC endothelin receptors induces vasoconstriction by two different mechanisms: increased intracellular calcium influx and activation of phospholipase C and A₂. Increased production and activity of ET may participate in several pathologic states related to dysfunctional endothelium, such as pulmonary and systemic hypertension, heart failure, and atherosclerosis (Donato DJ. et al., 2009).

3.2 Endothelial cell dysfunctions in the elderly

Increasing age is the major risk factor for the development of cardiovascular diseases due to the development of vascular endothelial dysfunction. The loss of endothelium-dependent NO-mediated vasodilation occurs early during endothelial dysfunction. Indeed, dysregulation of NO bioavailability as a result of oxidative is the key mechanism mediating reduces endothelium-dependent dilation with aging. Oxidative stress increases with age as a consequence of greater production of reactive oxygen species. This is result from up-regulation of the oxidant enzyme NADPH oxidase, uncoupling of NO producing enzyme, increased mitochondrial synthesis during oxidative phosphorylation. Increased bioactivity of the potent endothelial-derived constricting factor ET-1 (endothelin-1), reduced endothelial production of responsiveness to dilatory prostaglandins, the development of vascular inflammation, formation of

AGEs (advanced glycation end-products), an increased rate of endothelial apoptosis and reduced expression of estrogen receptor α (in postmenopausal females) also probably contribute to impaired EDD with aging (Caterina, RD., 2007). Mechanism involved in age-related endothelial dysfunction are as follows:

3.2.1 Increasing oxidative stress

NO is rapidly inactivated by ROS, mainly by superoxide radical. In the elderly, major cause of attenuated vasorelaxant response is due to the increased oxidative stress.

Under physiological conditions, the endogenous antioxidant defence mechanisms, such as the different isozymes superoxide dismutase (Cu/Zn-SOD, Mn-SOD and extracellular SOD, EC-SOD), the balance between the production of NO and O_2^- is preserved. Among the SOD isoenzymes, the EC-SOD is the more effective in the defence of the arteries facing to aging. The main systems proposed as responsible for the increase in the O_2^- anions production in aging, are the following: the xanthine oxidase and NADPH oxidase enzymes, and the mitochondrial respiratory chain. Accordingly, it has been shown an increased generation of endothelial NADPH oxidase-derived O_2^- anions in the carotid artery from old rats as well as higher levels of expression and activity of this enzyme in the aorta from old rats have been confirmed (Outdo, A. et al., 2006). In addition, this enzyme is upregulated by the tumor necrosis factor α (TNF- α) which is over expressed in aging. However, other authors noted that the oxidative stress associated with aging might not be dependent on NADPH oxidase, but related to the increased activity of the enzyme xanthine oxidase (Newaz, M.A. et al., 2006).

The mitochondria continually produces O_2^- anions, so that the mitochondrial DNA is continuously exposed to oxidative damage. The result is a reduction in the number of mitochondria, a lower expression of mitochondrial proteins, as well as an alteration of their activity. These facts altogether lead, firstly, to the malfunction of the respiratory chain and to an even greater increase in the O_2^- anions production, and secondly, to a depletion in energy supply to cells. Such resulting state is known as

mitochondrial dysfunction. The mitochondrial dysfunction is directly related to the onset of atherosclerosis, not only for its role in endothelial dysfunction, but also for its influence on other factors that promote such vascular disease: the destruction of pancreatic β -cells and an increased LDL oxidation. The injury provoked by the anion ONOO^- in age-related endothelial dysfunction not only leads to the inactivation of the Mn-SOD, but also can act on any susceptible protein to the nitrosylation of its tyrosine and cysteine residues (Madamanchi, N.R. and Runge, M.S., 2007)(Figure 2.3).

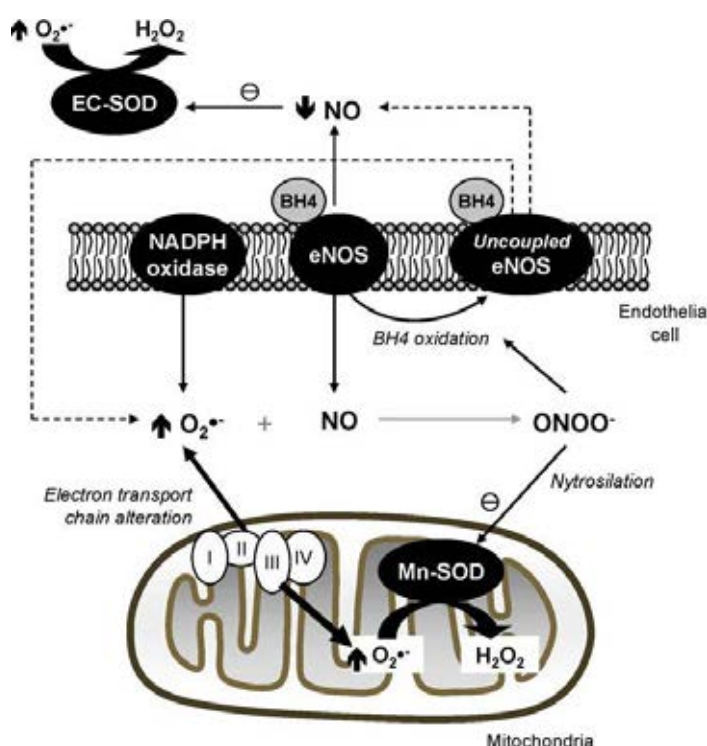

Figure 2.3 Increasing oxidative stress in endothelial dysfunction associated to the elderly(Herrera, MD. et al., 2010).

3.2.2 Increasing in the expression of pro-inflammatory cytokines

Inflammation is considered to be a critical initial step in the development of atherosclerosis during aging. Currently, the studies demonstrated that arterial aging, even in the absence of traditional risk factors for atherosclerosis, is associated with a pro-inflammatory shift in gene expression profile (Csiszar, A. et al., 2005). Pro-inflammatory changes in endothelial phenotype, known as “endothelial activation,” involve up regulation of cellular adhesion molecules, an increase in endothelial-

leukocyte interactions and permeability, as well as alterations in the secretion of autocrine /paracrine factors, which are pivotal to inflammatory responses. There is growing evidence that age-associated low-grade inflammation accelerates the incidence of chronic diseases, including atherosclerosis. In humans, plasma concentrations of several inflammatory markers (i.e. tumor necrosis factor-alpha, interleukin-6, s-VCAM-I, sE-selectin) are positively correlated with age. High level of cytokines contribute to a pro-inflammatory microenvironment that facilitates both the development of vascular dysfunction and promotes endothelial apoptosis in aging (Csiszar, A. et al., 2007).

In currently, the study demonstrates NF-kB associated endothelial dysfunction in the aging. It is responsible for regulating gene expression of factors that control cell adhesion, proliferation, inflammation, and specific enzymes. The endothelial dependent dilation was impaired in the elderly and was associated with increased nuclear translocation of NF-kB in their vascular endothelial cells. NFkB is an important role in mediating vascular endothelial dysfunction in the elderly by stimulating inflammation and oxidative stress (Figure 2.4) (Donato, DJ. et al., 2009).

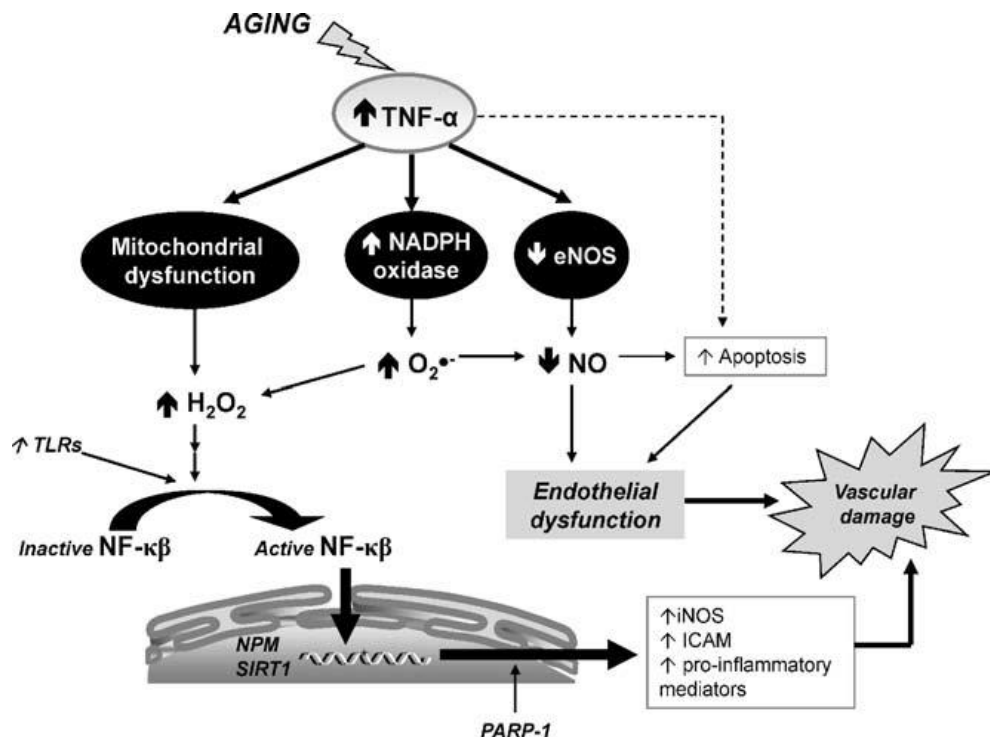

Figure 2.4 Mechanism contributing to endothelial dysfunction and activation of inflammatory pathways (Herrera, MD. et al., 2010).

3.2.3 Senescence and regeneration of endothelial cells

Cellular senescence is characterized by permanent exit from the cell cycle and the appearance of distinct morphological and functional changes associated with an impairment of cellular homeostasis. Many studies support the occurrence of vascular endothelial cell senescence *in vivo*, and the senescent phenotype of endothelial cells can be transformed from anti-atherosclerotic to pro-atherosclerotic, implicating a critical role of endothelial cell senescence in the initiation and progression of atherosclerosis. Thus, endothelial cell senescence promotes endothelial dysfunction and may contribute to the pathogenesis of age-associated vascular disorders (Erusalimsky, J.D. and Skene, C., 2009).

Cellular senescence occurring in vascular endothelial cells has been directly related to the onset of the age-related endothelial dysfunction since decrease levels of NO, eNOS activity, shear force induced NO production, PGI₂ release and an increased ROS, TXA₂ and ET-1 production have been found in the senescent endothelial cells (Haendeler et al., 2003). Although several molecular mechanisms may be proposed as

responsible for the cell senescence phenomenon, the shortening of the length of telomeres is one of the most accepted mechanisms that may lead to the endothelial senescence. Telomeres are the final region of chromosomes and their main function is to protect the rest of the chromosome from degradation and oxidation. In each round of cell division, telomeres narrow, and once a critical length is exceeded, this protective function is no longer exerted. Senescence is reached when the telomeres are shortened below a critical length. Indeed, telomere length is inversely correlated to age in endothelial cells in vivo. Accordingly, the length of telomeres in the endothelial cells of the abdominal aorta and the iliac artery is inversely proportional to the age of the patients. In addition, this shortening is more severe in those arteries from elderly patients with coronary disease and atherosclerosis (Minamino, T. and Komuro, I., 2007).

3.3 Depression and endothelial dysfunction

Several line of evidence has converged to establish a bidirectional relationship between vascular disease and depression. Depression linking to an increased risk for coronary artery disease is uncertain, although a number of abnormalities have been proposed, including abnormalities of hypothalamic pituitary axis, the sympathetic adrenal system, and cytokine activation.

Depression may contribute to the onset of a chronic inflammatory response to injuries of the vascular endothelium. It could accomplish this by promoting maladaptive health practices such as triggering dysregulation of the neurohormonal systems responsible for cortisol and catecholamine secretion. Currently study showed that depression maintains inflammatory response by diminishing the immune system's sensitivity to the glucocorticoid hormones and to extent that depression promotes cortisol hypersecretion (Carney, RM. et al., 2002).

Endothelial dysfunction is defined as the loss of capacity of nitric oxide to induce vasodilation, but the term is also used to describe the imbalance of relaxing and contracting endothelium-derived factors. Later on, the role of immunological factors in arterial lipid deposition as well as proliferation and migration of smooth muscle came to

light and inflammatory processes were seen as key determinants of coronary disease progression. Overall, depression is associated with activity of inflammatory response, including elevation of peripheral leucocyte, C-reactive protein, and pro-inflammatory cytokine production (IL-1 β , IL-2, IL-6, TNF- α). (Thomas, AJ. et al., 2005; O'Brien, SM. et al., 2007). There is evidence that IL-1 β , IL-6, TNF α , IL-12 increased in person with depressive symptoms (Apostolakis, S. et al., 2008). IL-6 contributes to atherosclerosis via atherosclerotic plaque formation and plaque destabilization. The inflammatory marker C-reactive protein (CRP) is one of the strongest independent predictors of future cardiovascular disease, and CRP affect to downregulate eNOS and destabilize eNOS mRNA, result in decreased NO release (Mellédo, JM. et al., 2004).

The other study showed that endothelial dysfunction is associated with hyperactivity the HPA (Hypothalamic-pituitary-adrenal) system, and more specifically increased cortisol concentration. And then HPA axis mechanism has been proposed for the increased risk of coronary artery disease in patients with depressive symptoms. Indeed, cortisol promotes the development of atherosclerosis and accelerates damage of endothelial cells, and effect to decrease endothelial NO production. It has been shown that cortisol induces a downregulation of eNOS in endothelial cells as well as a decrease in plasma NO level (Figure 2.5) (Paz-Filho, G. et al., 2010).

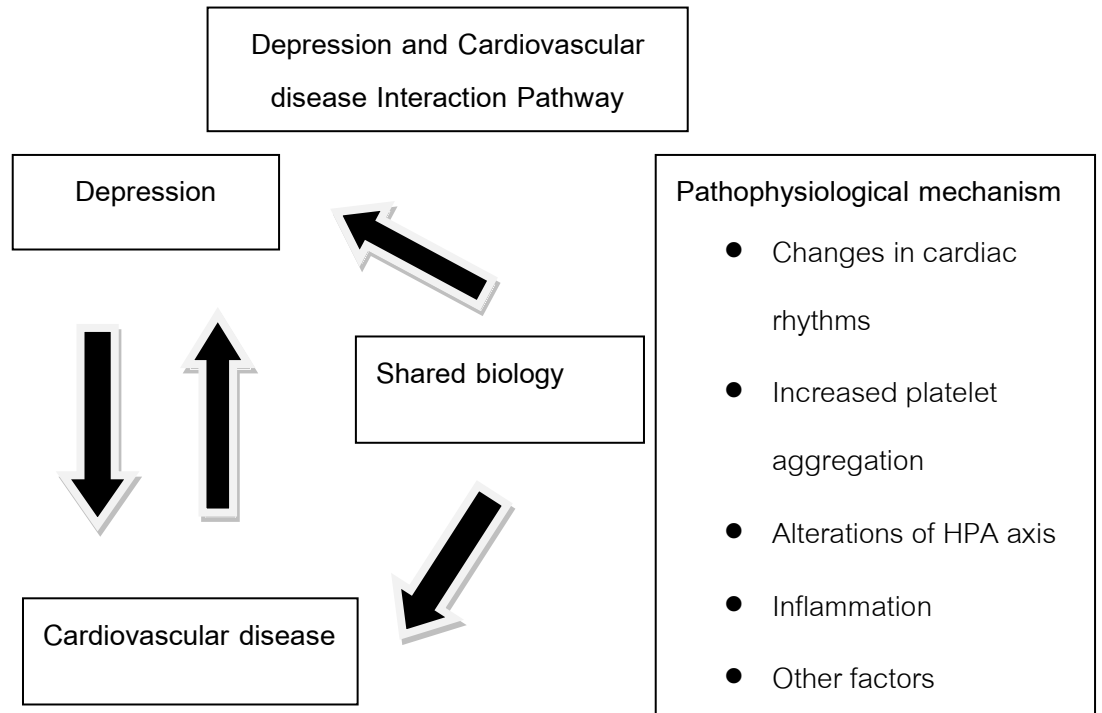

Figure 2.5 A proposed conceptual framework for the pathways connecting depression and cardiovascular disease (Paz-Filho, G. et al., 2010).

3.4 Clinical assessment of endothelial function

Endothelial function can be assessed invasively using acetylcholine, which induces endothelium-dependent dilation and smooth muscle-mediated constriction. In healthy coronary arteries, endothelium-dependent dilation predominates. In the presence of endothelial damage, vasoconstriction predominates. The coronary artery diameter is compared by quantitative angiography before and after infusion of acetylcholine. The functional status of the coronary microvasculature can also be assessed using intracoronary Doppler ultrasound to measure blood flow in resistance vessels for response to substances that produce either endothelial-dependent or endothelial-independent vasodilation. Venous occlusion plethysmography has been used to measure vasomotor responses of forearm resistance vessels during infusion of acetylcholine into the brachial artery (Celermajer, DS., 2008).

Another noninvasive method of detecting endothelial dysfunction uses high-resolution ultrasound to measure the brachial artery diameter in response to reactive

hyperemia. Reactive hyperemia induces increased blood flow and shear stress, stimulating NO release and flow-mediated dilation (FMD) that can be quantified as an index of vasomotor function. The systemic nature of atherosclerosis is reflected by the close correlation between endothelial dysfunction in the forearm and coronary endothelial dysfunction. These findings also suggest that noninvasive assessment of peripheral arteries may be useful for determining the effects of risk factors on endothelial function and for evaluating the effects of therapy (Corretti, MC. et al., 2002; Dhindsa, M et al., 2008).

4.Exercise in the elderly

Exercise, including aerobic exercise and resistance exercise, is an important for the elderly. This preventive recommendation specifies how the elderly, by engaging in each recommended mode of exercise, can reduce the risk of chronic disease, premature mortality, functional limitations, and disability.

Aerobic exercise. The elderly need moderate-intensity aerobic exercise for a minimum of 30 min on five days each week or vigorous intensity aerobic exercise for a minimum of 20 min on three days each week. Moderate-intensity aerobic exercise involves a moderate level of effort relative to an individual's aerobic fitness. On a 10-point scale, where sitting is 0 and all-out effort is 10, moderate-intensity exercise is a 5 or 6 and produces noticeable increases in heart rate and breathing. On the same scale, vigorous-intensity exercise is a 7 or 8 and produces large increases in heart rate and breathing. For example, given the heterogeneity of fitness levels in older adults, for some older adults a moderate-intensity walk is a slow walk, and for others it is a brisk walk. This recommended amount of aerobic exercise is in addition to routine activities of daily living of light-intensity (e.g., self care, cooking, casual walking or shopping) or moderate-intensity exercise lasting less than 10 min in duration (e.g., walking around home or office, walking from the parking lot). The elderly recommendation defines

aerobic intensity as relative to fitness, in the manner of an exercise prescription. For aerobic exercise, ACSM recommends a target intensity of 50–85% of oxygen uptake reserve—a range that includes both moderate and vigorous exercise (Francescomarino, SD. et al., 2009).

Resistance exercise. The elderly will benefit from performing activities that maintain or increase muscular strength and endurance for a minimum of two days each week. It is recommended that 8–10 exercises be performed on two or more nonconsecutive days per week using the major muscle groups. To maximize strength development, a resistance (weight) should be used that allows 10–15 repetitions for each exercise. The level of effort for muscle-strengthening activities should be moderate to high. On a 10-point scale, where no movement is 0, and maximal effort of a muscle group is 10, moderate-intensity effort is a 5 or 6 and high-intensity effort is a 7 or 8. Resistance exercise include a progressive-weight training program, weight bearing. The recommendation specifies the intensity of exercise that maintains and increase muscle strength. ACSM recommends performing at least one set of repetitions for 8–10 exercises that train the major muscle groups, and recommends exercise for each muscle group occur on two or three nonconsecutive days each week. Experts recommend 10 to 15 (as opposed to 8–12) repetitions per set for older adults (Francescomarino, SD. et al., 2009).

Flexibility and Balance. The elderly should perform activities that maintain or increase flexibility and balance exercise its can reduce risk of injury from falls. At least 10 min of flexibility activities is recommended based upon the time required for a general stretching routine involving major muscle and tendon groups with 10–30 s for a static stretch and 3–4 repetitions for each stretch. Preferably, flexibility activities are performed on all days that aerobic or resistance exercise is performed (ACSM, 2006).

4.1 Principle of exercise in the elderly (ACSM, 2006).

Mode

- The exercise modality should be one that does not impose excessive orthopedic stress.
- Walking is an excellent mode of exercise for many elderly people
- Aquatic exercise and stationary cycle exercise may be especially advantageous for those with reduced ability to tolerate weight-bearing activity.
- The activity should be accessible, convenient, and enjoyable to the participant, all factors directly related to exercise adherence.
- A group setting may provide important social reinforcement to adherence.
- The wide range of health and fitness level observed among older adults may require special consideration in terms of integrating intensity, frequency, and duration into an exercise plan.

Intensity

- The intensity guidelines and precautions established for adults for aerobic exercise training generally apply to elderly people.
- To minimize medical problems and promote long term compliance, exercise intensity for inactive elderly people should start low and individually progress according to tolerance and preference. Initiating a program at less than 40% VO_2R or HRR is not unusual.

- Many older persons suffer from a variety of medical condition; thus, a conservative approach to increasing exercise intensity may be warranted initially.
- Exercise need not be vigorous and continuous to be beneficial; a daily accumulation of 30 minutes of moderate-intensity physical activity can provide health benefits.
- Longer-duration or higher-aerobic intensity offers additional health and fit-ness benefits, although it can lead to greater risk of cardiovascular and musculoskeletal problems and lower compliance to long-term exercise plan.
- A measured peak heart rate is preferable to an age-predicted peak heart rate when prescribing aerobic exercise because of the variability in peak heart rate in persons more than 65 years of age and their greater risk of underlying coronary artery disease.
- Elderly persons are more likely than young persons to be taking medications that can influence heart rate.

Duration

- Exercise duration need not be continuous to produce benefits; thus, those who have difficulty sustaining exercise for 30 minutes or who prefer shorter bouts of exercise can be advised to exercise for 10-minute periods at different times throughout the day.
- To avoid injury and ensure safety, older individuals should initially increase exercise duration rather than intensity.

Frequency

- Physical activity performed at a moderate intensity should be performed most days of the week.
- If exercise is undertaken at a vigorous level, it should be performed at least 2 to 3 day/week, with exercise and no exercise or (low-to moderate-intensity) exercise days alternated.

4.2 Components of the training session (ACSM, 2006).

Warm up

Warm-up facilitates the transition from rest to exercise, stretches postural muscles, augments-blood flow, elevates body temperature, dissociates more oxygen, and increases the metabolic rate from the resting level to the aerobic requirements for endurance training.

The exercise session should begin with 5-10 minutes of low-intensity large muscle activity and should stretch the major muscle groups using static techniques. Stretching exercises performed as part of the warm-up may primarily have an acute effect, whereas flexibility performed during the cool-down.

Conditioning phase

The conditioning phase includes endurance, resistance, and flexibility programming. Depending on the individual's goals or outcomes; one, two, or all program areas can be included.

Cool-down

The cool down period provides a gradual recovery from the endurance phase and includes exercises of diminishing intensities. The cool-down is critical to attenuate the exercise-induced circulatory responses and return HR and BP to near resting values; maintain adequate venous return, thereby reducing the potential for post exercise hypotension and dizziness; facilitate the dissipation of body heat; promote

more rapid removal of lactic acid than stationary recovery; and combat the potential, deleterious effects of the post exercise rise in plasma catecholamines.

4.3 Benefits of exercise (Health care committee, 2004).

4.3.1 Improvement in cardiovascular and respiratory function.

- Increased maximal oxygen uptake resulting from both central and peripheral adaptations.
- Decreased minute ventilation at a given absolute submaximal intensity.
- Decreased myocardial oxygen cost for a given absolute submaximal intensity.
- Decreased heart rate and blood pressure at a given submaximal intensity.
- Increased capillary density in skeletal muscle.
- Increased exercise threshold for the accumulation of lactate in the blood.
- Increased exercise threshold for the onset of disease signs or symptoms.

4.3.2 Reduction in coronary artery disease risk factors.

- Reduced resting systolic/diastolic pressures
- Increased serum high-density lipoprotein cholesterol and decreased serum triglycerides.
- Reduced total body fat, reduced intra-abdominal fat.
- Reduced insulin needs, improved glucose tolerance.
- Reduced blood platelet adhesiveness and aggregation.

4.3.3 *Decreased morbidity and mortality.*

- Primary prevention; coronary artery disease, diabetes, stroke, osteoporotic fractures.
- Secondary prevention; reduced in rate of nonfatal re-infarction.

4.4 **Mind and body exercise**

Currently, mind and body exercise extend back to ancient times in Asia, and many of these forms, now referred to as mind-body therapies, recently are practiced throughout the world. Use of mind-body practice have increased in US. Around 20% of the population engage in some form of mind-body practice base on data from the 2007 National Health Interview Survey, with yoga, meditation, and deep breathing exercises being the most popular. Modalities of mind-body exercise such as yoga, tai chi, qigong, and meditation may represent adjuncts to the conventional care and management of metabolic syndrome. A recent comprehensive review found that yoga improved specific metabolic risk factors, including blood pressure, lipoprotein profiles, body mass index, and insulin sensitivity. Growing evidence suggest that tai chi and qigong improve indices of glycemic control. Later, there is evidence mind-body practices using for reducing depression, anxiety, stress and improving associated health outcomes, including promotion of adequate sleep (Anderson, JG. And Taylor, AG., 2011).

Yoga, a type of mind-body-spirit exercise, originated in India more than 2000 years ago. It has complex system of spiritual, moral, and physical directives, and the purpose of yoga practice is to attain “spiritual self-realization” (Chen, KM. et al., 2009).

Tai chi is mind-body exercise with origins in traditional Chinese martial and healing arts (Yeh, GY. et al, 2004).

Mind-body modalities are simple, economical, noninvasive therapies, easy to learn, and can be practiced easily by individuals who may experience potential

limitation in mobility. Moreover, mind-body exercise typically bring immediate positive benefits, including feeling of relaxation and tranquility (Chen, KM. et al., 2009).

5. Related research studies

5.1 National studies

In Thailand, there is a little evidence related in this study related research .

Kanungsukkasem and co-worker investigated the effects of jogging and jogging meditation upon the selected physical fitness components and the selected mental fitness component. The subjects were 50 volunteers male and female, age between 35-55 years old, who then were purposively random assigned into 2 groups: control group(jogging group) and experimental group (jogging meditation group). The subjects in each group were trained for 10 weeks, 3 days a week, with 30 minutes of duration per day. The selected mental fitness component and the selected physical fitness which had been tested by each subject before and after training were consisted of 23 items in which there were 20 items of physical fitness component and 3 items of mental fitness components. After 10 weeks of training program, the results of each test were then statistically treated to analyze the differences between mean by t-test and the analysis of covariance

The results were revealed that there were significant differences in 9 items of the physical fitness components in jogging group and there no any significant differences in the mental fitness components in jogging group. There were significant differences in 9 items of the physical fitness components in the jogging meditation group and there were significant differences in 2 items of the mental fitness components in the jogging meditation group. There were no any significant differences in physical and mental fitness component when compared between jogging group and jogging meditation group(Kanungsukkasem, V., Somprayon, S. Paichit, S.,1991).

Vorasetawut and co-worker investigated the effects of running meditation on physical fitness and the side effect of menstruation in women and premenstrual syndrome and dysmenorrhea, thirty subjects premenstrual syndrome and dysmenorrhea women were included in this study and were divided in to 2 groups. Running meditation group were trained 3 session/week for 12 weeks. Before and after experiment, physiological characteristic, health related physical fitness, and the severity of side effects of menstruation and dysmenorrhea were measured.

The results showed that there were no significant differences in health related physical fitness, and the severity of side effects of menstruation and dysmenorrhea in control group. However, flexibility, leg muscle strength, maximal oxygen consumption of the running meditation group were significantly increased as well as the side effects of menstruation and dysmenorrhea were significantly decreased when compared before and after experiment. Maximal oxygen consumption of the running meditation group was significantly increased than control group as well as the side effects of menstruation and dysmenorrhea were significantly decreased than control group. The study indicated that running meditation can improve cardiorespiratory fitness and decreased side effect of menstruation in women and premenstrual syndrome and dysmenorrhea (Vorasetawut, T. and Suksom, D., 2010).

Suksom and co-worker determined the effects of exercise with flexible stick training on physical fitness and endothelial function and compare it with Tai Chi training.

Thirty older women were recruited and were divided into EF group and TC group. Both training groups performed training assigned protocol that consisted of 70% of maximal heart rate, 40 minutes per day, four days per week for 12 weeks. Health related physical fitness and biochemical data were assessed in all participants. Post-Occlusive Reactive Hyperemia (PORH) was used to monitor endothelial function by using a Laser-Doppler fluxmeter.

The results showed that the health related physical fitness was significantly higher in the EF group ($p < 0.05$). Plasma malondialdehyde and von Willebrand factor,

an indicator of free radical damage and endothelial dysfunction, respectively as well as cholesterol level were significantly lower ($p < 0.05$) in the EF group. The peak Laser-Doppler flux (LDF)/baseline LDF, and recovery time were significantly improved after 12 weeks of EF training ($p < 0.05$). This was not observed after 12 weeks of TC training (Suksom, D., Siripatt, A., Lapo, P., Patumraj, S., 2011).

5.2 International studies

Pullen, PR. et al. (2008) investigated an 8-week regimen of yoga on exercise capacity, inflammatory markers, and quality of life (QoL) in patients with HF. A total of 19 patients were enrolled after the initial screening. Of the 19 patients, 9 were randomized to YT and 10 to MT. Measurements included a graded exercise test (GXT) to $\dot{V}O_2$ Peak and the following serum biomarkers: interleukin-6 (IL-6), high-sensitivity C-reactive protein (hsCRP), and extracellular superoxide dismutase (EC-SOD). The Minnesota Living with Heart Failure Questionnaire (MLHFQ) was administered to assess changes in QoL.

The results showed that GXT time and $\dot{V}O_2$ Peak were significantly improved in the YT versus MT groups (+18% in the YT and -7.5% in MT; $P = .03$ vs. control and +17 in YT and -7.1 in MT; $P = .02$, respectively). There were statistically significant reductions in serum levels of IL-6 and hsCRP and an increase in EC-SOD in the YT group (all $P < .005$ vs. MT). MLHFQ scores improved by 25.7% in the YT group and by 2.9% in the MT group. This study indicated that Yoga improved exercise tolerance and positively affected levels of inflammatory markers in patients with HF, and there was also a trend toward improvements in QoL.

Chen, KM. et al. (2009) determined the effects of 6 months of silver yoga exercises in promoting the mental health of older adults in senior activity centers, especially their sleep quality, depression, and self-perception of health status. 139 older adults ages 60 and over was recruited. Participants were randomly assigned into either

the experimental (n=62) or the control (n=66) group based on attendance at selected senior activity centers. A 70-min silver yoga exercise program was implemented three times per week for 6 months as the intervention for the participants in the experimental group.

The results showed that most of the mental health indicators of the participants in the experimental group had significantly improved after the silver yoga interventions, and many of the indicators improved after 3 months of intervention and were maintained throughout the 6 months study. The mental health indicators of the participants in the experimental group were all better than the participants in the control group (all $p < .05$).

Eyigor, S., Karapolat, H., Durmaz, B., Ibisoglu, U., Cakir, S. (2009) investigated the effects of group-based Turkish folkloric dances on physical performance, balance, depression and quality of life in 40 healthy elderly over the age of 65 years. Subjects were randomly allocated into group 1 (folkloric dance-based exercise) and group 2 (control). A 8 week dance-based exercise program was performed. 20- m walk test, 6 – min walk test, stair climbing and chair rise time, Berg balance scale (BBS), the Medical Outcomes Study (MOS), 36-item short form health survey(SF-36), and geriatric depression scale (GDS) questionnaires were measured.

The results showed that In group 1 statistically significant improvements were found in most of the physical performance tests, BBS and some SF-36 subscale after exercise. In group 2 there was no significant change in the variables. When compared between group, significant improvements in favor of group 1 emerged in most of the functional performance tests, in some of the SF-36 subscales and BBS score.

Lim, YM., Hong, GR. (2010) determined the effects of 16 weeks Kouk-Sun-Do (KSD) exercise on physical fitness, emotion state, and immunoglobulin A in community-dwelling elders in Korea. A total of 19 elders in the intervention group and 20 elders in control group were recruited in this study. The KSD exercise with low intensity exercise was performed over a 45 minute session, three times a week for a 16 week period.

The result revealed that the effectiveness of KSD exercise on the physical fitness, emotion state, and IgA, and KSD can be identified as a feasible type of low-intensity exercise for elders.

Chan, AS., Wong, QY., Sze, SL., Kwong, PP., Han, YM., Cheung, MC. (2012) demonstrated that the effect of a newly developed Chinese Chan-based Dejian Mind-Body Intervention (DMBI) with the Cognitive Behavioral Therapy (CBT) on improving depressive symptoms in patients with depression. Seventy-five participants diagnosed with major depressive disorder were randomly assigned to receive either 10-session CBT or DMBI, or placed on a waitlist. Pre-post measurements included record of antidepressants treatment, ratings by psychiatrists who were blinded to the experimental design and self-report on mood measures, and performance in a cognitive test tapping concentration ability.

The results showed that Both the CBT and DMBI groups significantly reduced overall depressive syndrome after intervention. Furthermore, the DMBI group ($p < 0.05$), but not the CBT or waitlist groups, demonstrated significant reduction in intake of antidepressants, and significant improvement in specific depression-related symptoms including difficulty in concentration ($p = 0.002$), and problems in gastrointestinal health ($p = 0.02$) and overall sleep quality ($p < 0.001$).

Hunter, SD. et al. (2012) investigated the effect of hatha yoga on arterial elasticity and endothelial function. A cross-sectional study was performed to determine whether yoga practitioners would demonstrate greater arterial compliance and endothelium-dependent vasodilation than their sedentary peers. An intervention study involving 13 sedentary middle-aged and older adults (51 ± 7 years) was performed to determine whether 12 weeks of hatha yoga would elicit increases in arterial compliance and endothelial function. In the cross-sectional study involving a total of 34 subjects, there were no group differences in body fatness, blood lipid and lipoprotein concentrations, carotid artery compliance or brachial artery flow-mediated dilation

(FMD). Hemoglobin A1c was lower in yoga practitioners than in sedentary adults ($P < 0.05$). Total cholesterol and hemoglobin A1c decreased after the intervention ($P < 0.05$) while carotid artery compliance and brachial artery FMD did not change. The results of both cross-sectional and interventional studies indicate that regular practice of hatha yoga is not associated with improvements in vascular functions.

6. Conceptual Framework

The conceptual framework in this study was shown in Figure 2.6.

It demonstrated that the elderly with depressive symptoms had decreased physical fitness and associated increasing pro-inflammatory markers i.e. interleukin 6, C-reactive protein. Whether or not the arm swing walking meditation exercise and traditional walking exercise could developed those parameters and investigated the effects on physical fitness, pro-inflammatory markers, nitric oxide, endothelial function, cortisol level and depression score. Moreover, we would like to compare with the traditional walking exercise.

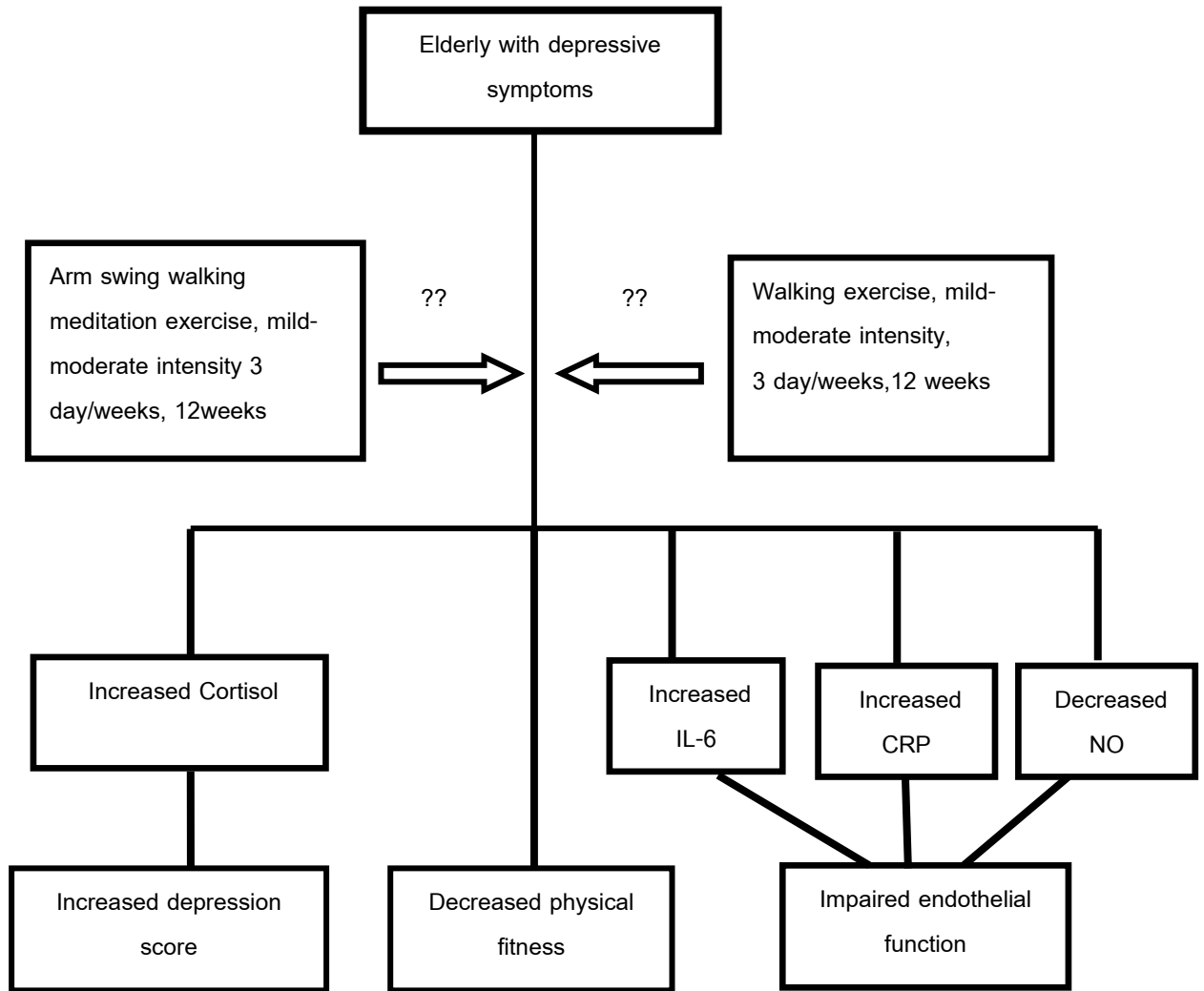

Figure 2.6 Conceptual framework

CHAPTER III

METHODOLOGY

The present study aimed to create the arm swing walking incorporate with Buddhist meditation exercise program appropriate for elderly with depression and to determine the effects of the program on endothelial dependent vasodilation, physical fitness and depression in elderly subjects with depressive symptoms. The study was divided into 2 parts. First, the arm swing walking incorporate with Buddhist meditation exercise training program was created and was evaluated suitability component of exercise for the elderly. Two, to investigate the effects of exercise training program on endothelial dependent vasodilation, physical fitness and depression. All protocols and procedures used in study were reviewed and approved by the Ethics Review Committee for Research Involving Human Research Subjects, Health Science Groups, Chulalongkorn University.

Participants

The elderly aged 60-90 years and had mild to moderate depressive symptoms as defined by Geriatric Depression Scale of 13-24 scores (Yasavage et al., 1982) and was translated into Thai language for Thai Geriatric Depression Scale (TGDS; Train the Brain Forum Committee, 1994). Participants were recruited from Banbangkae Social welfare Development centers for older persons in Bangkok, Thailand. A total of 45 females elderly was conducted in this study following Cohen table at power 0.8, effect size 0.5 (Cohen, 1988). The eligible subjects were randomly allocated into three groups; sedentary control group (CON; n=15), traditional walking exercise training (TW; n=15) and arm swing walking incorporating with Buddhist meditation exercise training (ASW; n=15).

Inclusion criteria

1. The elderly aged 60-90 years and had mild to moderate depressive symptoms as defined by Geriatric Depression Scale of 13-24 scores (Yasavage et al., 1986).
2. All participants were normally mobility and independent self-care.
3. All participants were free from severe hypertension, diabetes mellitus, severe cardiovascular and cerebrovascular disease.
4. All participants had good conscious and were able to communication.
5. All participants were free from history of psychiatric illness and on psychiatric medication.
6. All participants were free from other the study.
7. All participants were obtained an informed consent.

Exclusion criteria

1. The participants dropped out or completed less than 80% of the training schedule.
2. The participants were injured and sick in during the training.

Data collecting

The data were collected manually. The elderly volunteers were assessed depression by Geriatric Depression Scale. Depression diagnosis was confirmed by psychologist. The exercise training programs were conducted in elderly with depressive symptoms at Banbangkae Social welfare Development centers for older persons in Bangkok.

Instruments

Instruments were used in the selected participant.

1. Thai Geriatric Depression Screening Scale (TGDS)
2. The Physical Activity Readiness Questionnaire (PAR-Q)
3. The Informed Consent Form

Instruments were used in the assessment of exercise training program.

1. The assessment of exercise training program questionnaire
2. The satisfaction of exercise questionnaire

Instruments were used in exercise training program.

1. Heart rate monitor (Polar Team 2 Pro, USA)

Instruments were used in the assessment of physiological variables

1. Digital blood pressure (Omron, Japan)
2. Inner scan body composition (Tanita BC 533, USA)
3. Spirotouch (Spacelabs Burdick, USA)
4. Ultrasound equipment (CX50, Philips, USA)
5. Brachial analyzer program (Brachial Analyzer, Medical imaging applications, USA)

Instruments were used in the assessment of blood chemical variables

1. Allegar X-12R Centrifuge (Beckman coulter, Inc., USA)
2. Freezer-80°
3. Nitric Oxide assay kit (Colorimetric nitric oxide assay kit, PromoKine, Germany)

4. Interleukin-6 ELISA kits (eBioscience, Veinna, Austria)

Methods

The data were collected according to the purposes of this study. The study was divided into 2 parts as follow:

Part 1: Arm swing walking incorporate with Buddhist meditation exercise training program was created .

1. Literature reviewed involved exercise in the elderly, guidelines for the treatment of elderly with depression.
2. The suitability mode, intensity, frequency, duration, progression of exercise for improving endothelial function, physical fitness, depression in the elderly with depressive symptoms were analysed
3. A preliminary study found that endothelial function was improved by upper-lower aerobic exercise and depression was decreased by meditation therefore the training exercise program was created base on mind and body exercise that combined physical activities (by aerobic exercise) which help physical healthy and mental management (by meditation) which make mental health at the same time. "Arm swing walking incorporate with Buddhist meditation exercise" (ASW) concentrate on spiritual movements of the arm swing by praying Budd–Dha during walking.
4. ASW program were divided into two phases; phase 1 (weeks 1-6) and phase 2 (weeks 7-12). In phase 1, ASW programs were designed to achieve equal mild intensity (20-39%heart rate reserve) in 20 minutes, 3 times a week. In phase 2, the training was gradually increased to moderate intensity (40-50% heart rate reserve) in 30 minutes, 3 times a week (American College of Sport Medicine, 2006), and included 11 stretching in warm up and cool down

stage for 10 minutes. ASW program were performed walking in the 50 meters of oval shape indoor track.

5. ASW program was approved the content validity and reliability as follow :

5.1 The component of exercise training program questionnaire was created by the researcher. It was used assessment suitability of ASW program. The questionnaire was evaluated content validity by Assoc.Prof. Dr.Thanomwong Kritpet, Assist. Prof. Dr. Chalerm Chaiwatcharaporn, Assist. Prof. Dr. Wanchai Boonrod. The Item Objective Congruence (IOC) was considered and was accepted scored more than 0.5.

5.2 The suitability of ASW program was approved by Assoc. Prof. Dr. Suchitra Sukonthasab, Dr. Tossaporn Yimlamai, Assoc. Prof. Somnuke Gulsatitporn, Assist. Prof. Dr. Orntipa Songsiri and Assoc. Prof. Patsamon Khumtaveeporn. (2 sport science experts, 2 health science experts, 1 physiotherapist). The component of exercise training program questionnaire was used and it was calculated the mean of suitability the ASW program. The mean score was divide to 5 level including least (1.00-1.49 score),low(1.50-2.49 score), moderate (2.50-3.49 score), good (3.50-4.49 score), excellence (4.50-5.00 score). The mean of suitability the ASW program was excellence level (mean±SD = 4.50±0.64 score).

5.3 In pilot study, the ASW program was conducted in the elderly volunteers (n=10). Heart rate, intensity, duration in during training exercise were recorded. Test-retest reliability was considered. There was no difference in heart rate in during training exercise when test – retest in1 week.

Part 2 : *The effects of arm swing walking incorporate with Buddhist meditation exercise training program on endothelial dependent vasodilation, physical fitness and depression score.*

The experimental design was summarized in Figure 3.2. The detail are as follow :

1. The elderly with depressive symptom volunteers have been aware of the details to perform the data collection and signed in the Informed Consent Form.

2. The participants were randomly divided into 3 groups by using depression scores.

Group 1: Participants could perform normal daily activities and did not get any exercise (n=15).

Group 2: Participant received an aerobic exercise by walking at mild (20-39% heart rate reserve; HRR) to moderate (40-59% heart rate reserve; HRR) intensity (n=15). The target heart rate using formula:

$$\text{Target HR} = (\text{HR}_{\text{max}} - \text{HR}_{\text{rest}}) \times \% \text{intensity} + \text{HR}_{\text{rest}}$$

Group 3: Participant received mind-body exercise by arm swing walking incorporate with Buddhist meditation exercise at mild (20-39% heart rate reserve; HRR) to moderate (40-59% heart rate reserve; HRR) intensity (n=15).

Exercise Training program

The exercised participants underwent a 12-week training period, 3 days per week. Both Traditional walking exercise training (TW) program and arm swing walking incorporate with Buddhist meditation exercise training (ASW) program were divided into two phases; phase 1 (weeks 1-6) and phase 2 (weeks 7-12). In phase 1, TW and ASW training programs were designed to achieve equal mild intensity (20-39%heart rate reserve) in 20 minutes, 3 times a week. In phase 2, the training was gradually increased to moderate intensity (40-50% heart rate reserve) in 30 minutes, 3 times a week (American College of Sport Medicine, 2006). To achieve this, intensity of exercise was

periodically monitored using the heart rate monitor (Polar Team 2 Pro, USA) to control for heart rate reserve. The TW and ASW program included 11 stretching in warm up and cool down stage for 10 minutes. Both exercise groups were performed walking in the 50 meters of oval shape indoor track.

The traditional walking exercise program

The elderly were instructed continuously walking 50 meters oval shape as follow

Table 3.1

Table 3.1 Traditional walking exercise program

Period (wk)	Intensity (%HRR)	Traditional walking exercise program	Duration (min/time)	Frequency (time/wk)
1-6	20-40	walking 50 meters oval shape	20	3
7-12	40-50	walking 50 meters oval shape	30	3

Arm swing walking incorporating with Buddhist meditation exercise

ASW program was created based on upper and lower limb aerobic exercise movements incorporate meditation. The meditation was control by awareness with arm movement. The subjects in ASW group performed walking while rhythmically swinging both arms by voiced “Budd” with arm swing up and “Dha” with arm swing down. The training program was increased workload by holding water bottle weight 500 ml in each hand in phase two of training (Table 3.2, Figure 3.1).

Table 3.2 Arm swing walking incorporating with Buddhist meditation exercise program

Period (wk)	Intensity (%HRR)	Arm swing		Duration (min/time)	Frequency (time/wk)
		Frequency of arm swing(rep/min)	Workload		
1-6	20-40	108	Not increasing	20	3
7-12	40-50	108	Holding water bottle weight 500 ml in each hand	30	3



Figure 3.1 arm swing walking incorporate with Buddhist meditation exercise in phase 1 and phase 2

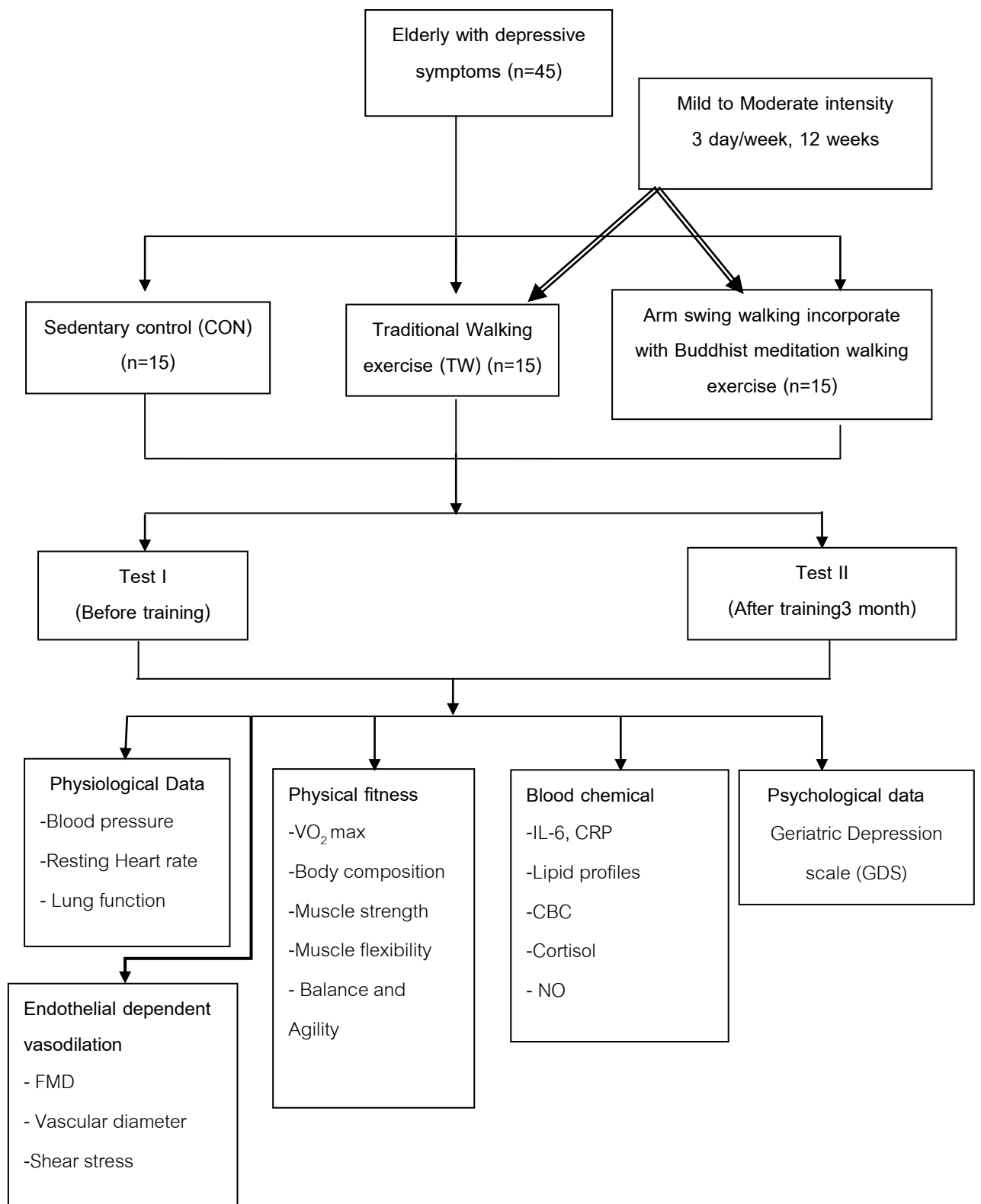

Figure 3.2 Procedure in part II

4. Parameter measurements are as follow:

4.1. Physiological characteristics measurement

Body composition measurement

Body mass and percent body fat was measured using by Inner scan Body Composition (Tanita BC 533, USA). Body mass index was calculated as body mass (kilograms) divide by height (meters) squared. Participants take off their shoe and socks before measured.

Resting heart rate measurement

Participants rested in sitting or supine position for 5 minutes .The resting heart rate was measured using by heart rate monitor (Polar, USA).

Resting blood pressure measurement

Participants rested in sitting or supine position for 5 minutes. The cuff was placed above antecubital. The resting blood pressure was measured using by digital blood pressure (Omron, Japan).

4.2 Endothelial dependent vasodilation measurement

Brachial artery characteristics were assessed with the ultrasound equipment (CX50, Philips, USA), using the occlusion technique on the right forearm. All subjects rested in the supine position for 20 min. The brachial artery was imaged above the antecubital fossa in the longitudinal plane (Figure 3.3, Figure 3.4). Baseline data was monitored for 1 min and then the cuff placed around the right forearm was inflated rapidly to 50 mmHg above systolic blood pressure for 5 min and deflated for 5 min of recovery (Corretti et al., 2002; Dhindsa et al., 2008). Mean blood velocity was collected by using the pulsed wave Doppler mode. Brachial analyzer program (Brachial Analyzer, Medical imaging applications, USA) was used for analyzing changes in vascular diameter. Shear rate was calculated by blood velocity/vascular diameter (Pyke et al.,

2008). FMD was calculated using the formula $FMD = (d2-d1) \times 100/d1$ when $d1$ is the averaged the brachial artery diameter at baseline, $d2$ is the averaged the maximal post occlusion brachial artery diameter (Naidu,OA. et al., 2011).

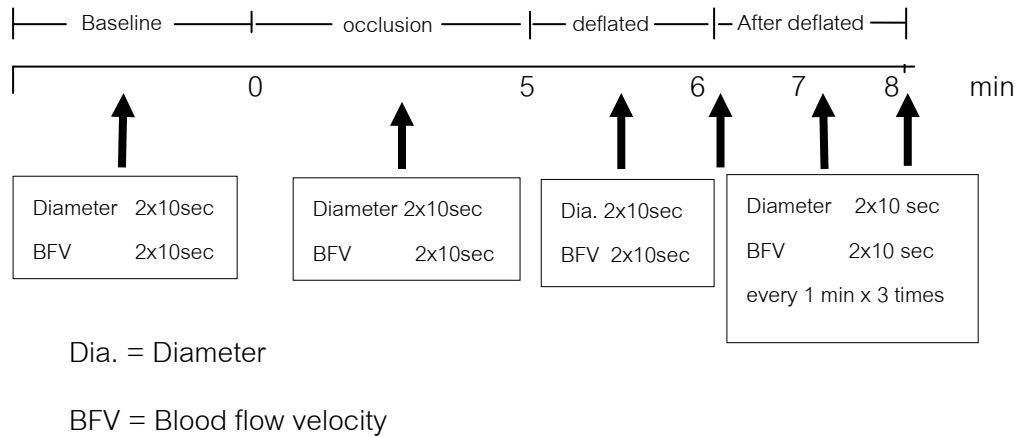

Figure 3.3 Protocol for ultrasound imaging

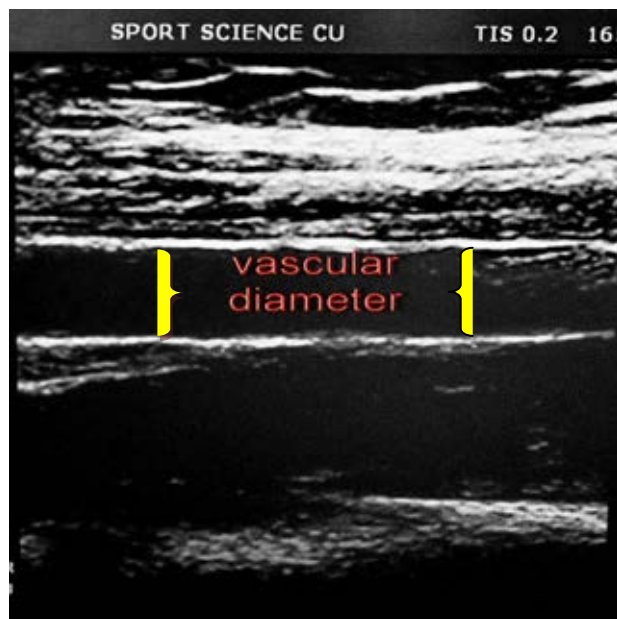

Figure 3.4 Imaging brachial artery diameters

4.3 Physical fitness measurement (Appendix G)

4.3.1 Arm curl test

Upper body strength and muscle strength of arms was measured with arm curl test (Jone, C.J. and Rikli, R.E., 2002; Kostic, R. et al., 2008). The elderly was instructed sat on the edge of a chair, flexed and extended elbows with dumbbell 5 pound weights

in supinated forearm within 30 seconds. The number of arm curl movement in 30 seconds was recorded. The elderly were repeated 2 times, and best the number of arm curl test was analyzed.

4.3.2 30 second chair stand test

Lower body strength and muscle strength of legs was measured with the 30 second chair stand test (Jone, C.J. and Rikli, R.E., 2002; Justine, M., Hamid, T. A., Mohan, V., Jagannathan, M., 2012). This was determined by the elderly sat as far back as possible in the chair and stood up from a seated position with arms folded across their chest within 30 seconds. The numbers of times their stood up and sat down within 30 seconds were recorded.

4.3.3 Back scratch test

Back scratch test was used to measures the upper limb flexibility (Jone, C.J. and Rikli, R.E., 2002). The elderly were seated on the side of the chair, one arm was flexed beyond the shoulder with elbow flexed to the maximum and then the other arm and internally rotated with both the finger attempting to touch each other than holding 2 seconds. The distance between the both middle fingers was measured that the elderly were short of reaching both middle fingers (minus score) or beyond the middle fingers (plus score). The test was repeated 2 times, and the best distance 2 times was analyzed.

4.3.4 Chair sit and reach test

Flexibility of the lower back and backs of the upper legs was measured by chair sit and reach test (Jone, C.J. and Rikli, R.E., 2002). Chair sit and reach test, the elderly sat on the chair, leg extended with the bottom of the feet and then stretched their arms forward as far as possible keeping the leg straight.

4.3.5 *The timed up-and-go test*

Agility and dynamic balance was measured by the time up and go test (Jone, C.J. and Rikli, R.E., 2002). The elderly were instructed to stand up from a chair then walked straight of distance 3 meters, turned around a cone and returned to chair. The time used to complete test was recorded.

4.3.6 *six-minute walk test*

Aerobic endurance was measured with six- minute walk test (Jone, Riki &Beam, 2002; Doutreleau, S. et al., 2009). The elderly were instructed to walk as fast as possible for six minute along 50 meters rectangular shape. The score was total distance walked in 6 minutes. The VO₂ max was calculated using by formula:

$$\text{VO}_2 \text{ max (mL/kg}\cdot\text{min)} = 70.161 + (0.023 \times 6 \text{ MWT (m)} - (0.276 \times \text{weight (kg)} - (6.79 \times \text{sex, where m = 0, f = 1}) - (0.193 \times \text{resting HR (beats per minute)}) - (0.191 \times \text{age (y)}) \text{ (Burr, JF., Bredin, SS., Faktor, MD., Warburton, DE., 2011).}$$

4.3.7 *Pulmonary function*

Pulmonary function (FVC, FEV1) were measured using by a calibrated computerized pneumotachograph spirometer (Spirotouch; Burdick, Inc., Deerfield, USA.) according to American Thoracic Society (ATS) recommendations (Mandell LA. et al., 2007)

4.4 *Blood chemical measurement*

4.4.1 *The cytokines measurement.*

Blood samples were collected and then centrifuged at 3,500 rpm for 10 min at 4 °C for separation of erythrocyte and plasma. Interleukin-6 (IL-6), alpha-tumor necrotic factor (TNF α) was measured in plasma samples with the ELISA kits (eBioscience, Veinna, Austria) (Appendix E).

4.4.2 Nitric oxide (NO) measurement.

Nitric oxide was measured in plasma samples with the commercial assay kit (Colorimetric nitric oxide assay kit, PromoKine, Germany) (Appendix II).

4.3.3 Cortisol, c-reactive protein, lipoprotein concentrations, complete blood count measurement.

Plasma cortisol, C-reactive protein (CRP) and lipoprotein concentrations were measured with standard procedures at the certified clinical laboratory (BRIA Lab, Bangkok, Thailand).

4.4 Depression measurement

The Geriatric Depression Scale developed by Yasavage (1982), was translated into Thai language for Thai Geriatric Depression Scale (TGDS; Train the Brain Forum Committee, 1994). The TGDS consists of 30 items with yes or no answers. The TGDS has a range 0 to 30 score, range score 0 to 12 indicate no depression, range score 13 to 18 indicate mild depression, range score 19 to 24 indicate moderate depression, and 25 or more indicate severe depression. In this study used range score 13 to 24 score.

Data analysis

The data were expressed as means \pm SEM. Statistical comparisons between pre and post tests were conducted using the paired student's t-test. One-way analysis of variance, followed by Bonferroni multiple comparisons were used to determine the significant differences among group means. $P < 0.05$ was considered a priority to be a statistically significant difference.

CHAPTER IV

RESULTS

The study purpose to create the arm swing walking incorporate with Buddhist meditation exercise program appropriate for elderly with depression and determined the effects of the program on endothelial dependent vasodilation, physical fitness and depression in elderly subjects with depressive symptoms. Forty participants completed the 3 –month study. A total of 5 participants, evenly distributed from each study site, withdrew by 2-weeks interval (ASW group=one participant), two participants in TW group at the 1-month interval and two participants in control group withdrew at the end of the 3-month interval. The reasons for withdrawal from ASW group included: physical discomfort (n=1). Participants withdrew from TW group for the following reason: exercise less than 80% of the total training time (n=1) and not interested (n=1). The reasons for withdrawal from CON group is not interested and lost to follow-up (n=2).The remaining were 13 subjects in the CON group, 13 subjects in the TW group, and 14 subjects in the ASW group (Figure 4.1).

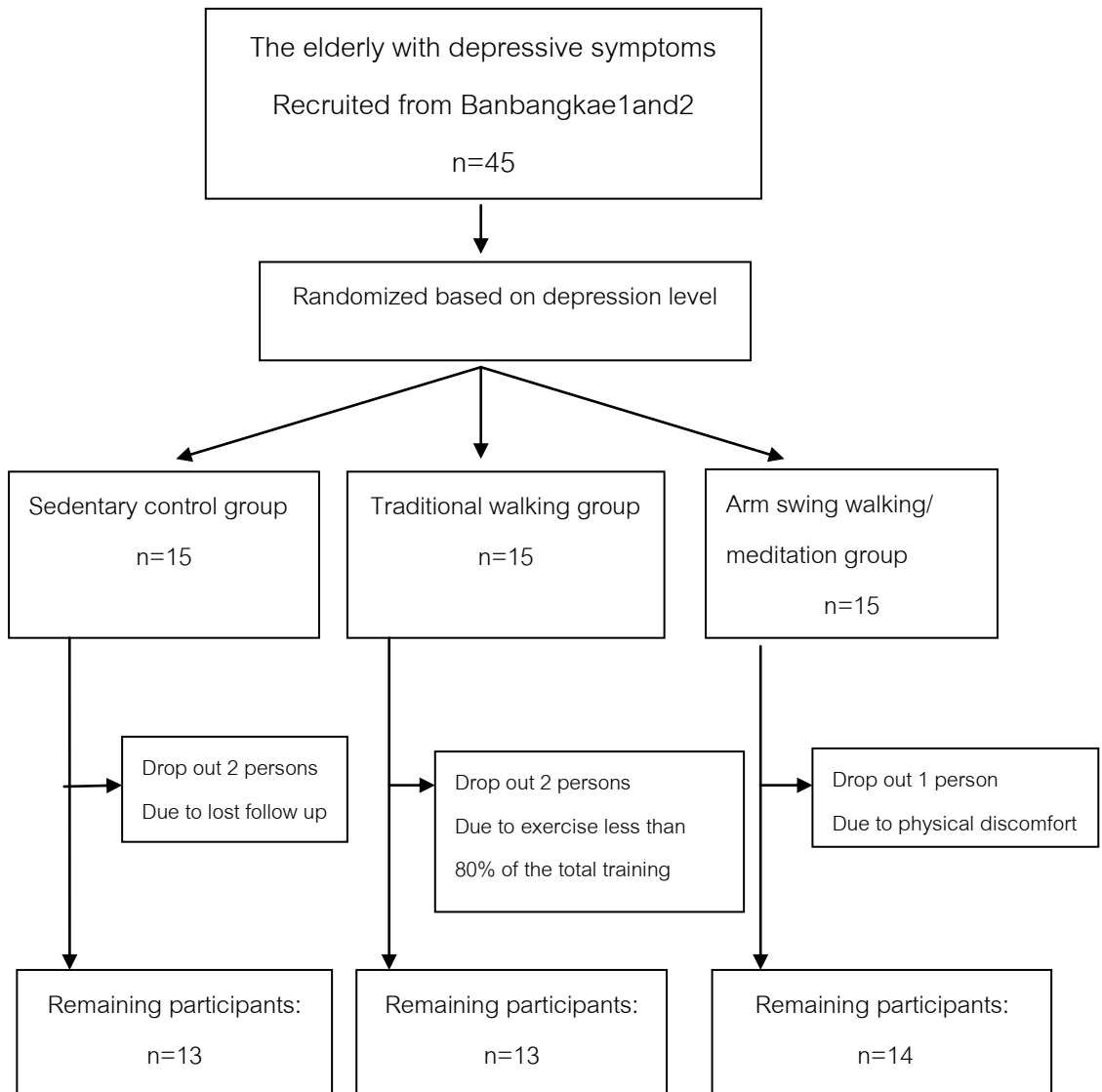

Figure 4.1 Flowchart of participants flow.

The results composed of six major parts which were served to examine the effect of arm swing walking incorporate with Buddhist meditation exercise program on endothelial dependent vasodilation, physical fitness and depression. These six major parts were listed in following :

Part 1: The physiological characteristics data baseline.

Part 2: Changes in selected subject characteristics during the interventions.

Part 3: Changes in physical fitness measures during the interventions.

Part 4: Changes in endothelial dependent vasodilation during the interventions.

Part 5: Changes in depression score and cortisol concentration.

Part 6: Changes in blood biochemistry data during the interventions.

Part 1: The comparison of physiological characteristics data baseline between the sedentary control group (CON), traditional walking exercise training group (TW) and arm swing walking incorporating Buddhist meditation exercise training group (ASW).

Table 4.1 The comparison of physiological characteristics variable between groups.

Variables	CON(n=13)	TW(n=13)	ASW(n=14)	F	P-value
Age (years)	81.0±1.66	74.77±1.7	74.0±1.86	4.75	0.06
Height (cm)	142.9±2.27	151.23±1.77	148.93±1.70	4.87	0.06
Body mass (kg)	49.25±2.79	59.78±5.11	56.55±2.82	2.08	0.14
BMI (kg/m ²)	24.02±1.09	25.99±2.04	25.48±1.15	0.47	0.63
Heart rate (bpm)	74.92±4.56	72.53±4.46	75.14±2.88	0.13	0.88
Systolic BP (mmHg)	128.38±5.91	126.46±6	124.21±5.58	0.13	0.88
Diastolic BP (mmHg)	67.38±3.41	69.38±3.22	63.57±2.80	0.90	0.41
Body fat (%)	34.64±1.96	36.5±3.44	37.97±2.00	0.44	0.65
VO ₂ max (ml/kg/min)	23.54±1.09	23.68±1.76	22.90±1.19	0.09	0.91
Depression (score)	17.92±0.55	17.30±1.20	16.79±0.92	1.23	0.23

Values are mean ± SEM.

BMI = body mass index, BP = blood pressure, VO₂max = maximal oxygen consumption

Physiological characteristics data baseline of the subjects are summarized in table 4.1. There were no significant differences in age, height, body mass, body mass index, body fat, heart rate, systolic blood pressure, diastolic blood pressure, maximal oxygen consumption (VO₂max), depression between the CON, TW, ASW group.

Part 2: The comparison of physiological characteristics variables between pre and post training exercise in three groups: sedentary control group (CON), traditional walking exercise training group (TW) and arm swing walking incorporating Buddhist meditation exercise training group (ASW).

Table 4.2 The comparison of resting heart rate (bpm) between pre and post training in three groups: sedentary control group (CON), traditional walking exercise training group (TW) and arm swing walking incorporating Buddhist meditation exercise training group (ASW).

Group	Resting heart rate(bpm)		t	P-value
	Pre-test	Post-test		
CON (n=13)	74.92±4.56	75.46±3.85	-0.16	0.88
TW (n=13)	72.53±4.46	77.77±3.20	-1.17	0.26
ASW (n=14)	75.14±2.88	72.21±2.88	0.83	0.42

Values are mean ± SEM.

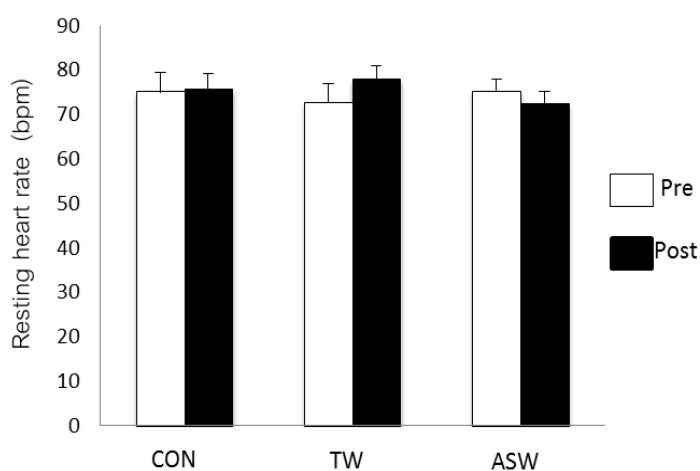

Figure 4.2 The comparison of resting heart rate (bpm) between pre and post training in three groups: CON, TW, ASW.

Data of resting heart rate after training were shown in table 4.2 and figure 4.2. There were no significant difference in resting heart rate between pre and post-test in all three groups; CON, TW, ASW groups.

Table 4.3 The comparison of systolic blood pressure (mmHg) between pre and post training in three groups: sedentary control group (CON), traditional walking exercise training group (TW) and arm swing walking incorporating Buddhist meditation exercise training group (ASW).

Group	Systolic blood pressure (mmHg)		t	P-value
	Pre-test	Post-test		
CON (n=13)	128.38±5.91	130.53±4.05	-0.66	0.52
TW (n=13)	126.46±6	117.92±4.41	3.38	0.00*
ASW (n=14)	124.21±5.58	114.78±4.72	3.87	0.00*

Values are mean ± SEM., * $p < 0.05$ significant different from pre-test.

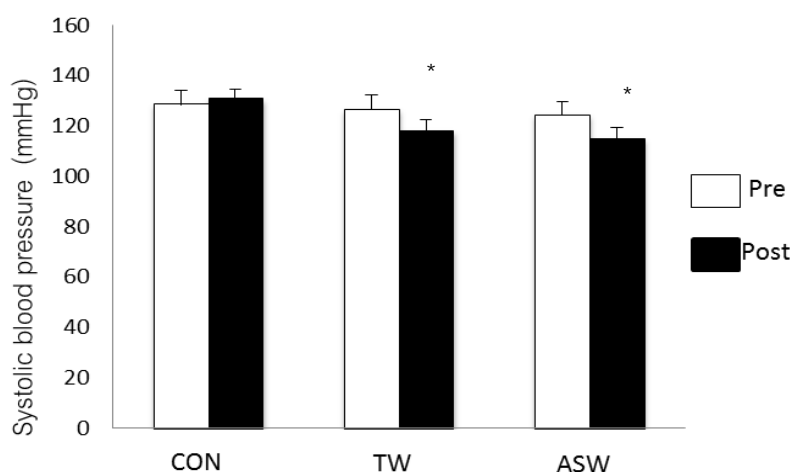

Figure 4.3 The comparison of systolic blood pressure (mmHg) between pre and post training in three groups: sedentary control group (CON), traditional walking exercise training group (TW) and arm swing walking incorporating Buddhist meditation exercise training group (ASW).

Data of systolic blood pressure after training were shown in table 4.3 and figure 4.3. The TW and ASW had a significantly lower ($p < 0.05$) systolic blood pressure when compared to pre-test. There was no significant difference in systolic blood pressure in CON.

Table 4.4 The comparison of diastolic blood pressure (mmHg) between pre and post training in three groups: sedentary control group (CON), traditional walking exercise training group (TW) and arm swing walking incorporating Buddhist meditation exercise training group (ASW).

Group	Diastolic blood pressure (mmHg)		t	P-value
	Pre-test	Post-test		
CON (n=13)	67.38±3.41	74.31±2.82	-1.76	0.10
TW (n=13)	69.38±3.22	65.92±2.52	2.84	0.01*
ASW (n=14)	63.57±2.80	58.86±2.41	5.21	0.00*

Values are mean ± SEM., * $p < 0.05$ significant different from pre-test.

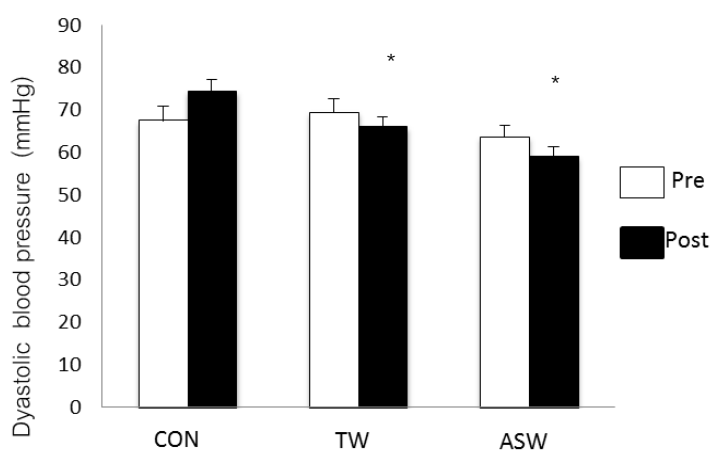

Figure 4.4 The comparison of diastolic blood pressure (mmHg) between pre and post training in three groups: sedentary control group (CON), traditional walking exercise training group (TW) and arm swing walking incorporating Buddhist meditation exercise training group (ASW).

Data of diastolic blood pressure after training were shown in table 4.4 and figure 4.4. The TW and ASW groups had a significantly lower ($p < 0.05$) diastolic blood pressure when compared to pre-test. There was no significant difference in CON group.

Table 4.5 The comparison of body mass (kg) between pre and post training in three groups : sedentary control group (CON), traditional walking exercise training group (TW) and arm swing walking incorporating Buddhist meditation exercise training group (ASW).

Group	Body mass (kg)		t	P-value
	Pre-test	Post-test		
CON (n=13)	49.25±2.79	50.02 ±2.78	-3.89	0.00*
TW (n=13)	59.78±5.11	58.52±5.1	4.33	0.00*
ASW (n=14)	56.55±2.82	55.03±2.88	2.83	0.01*

Values are mean ± SEM., * $p < 0.05$ significant different from pre-test.

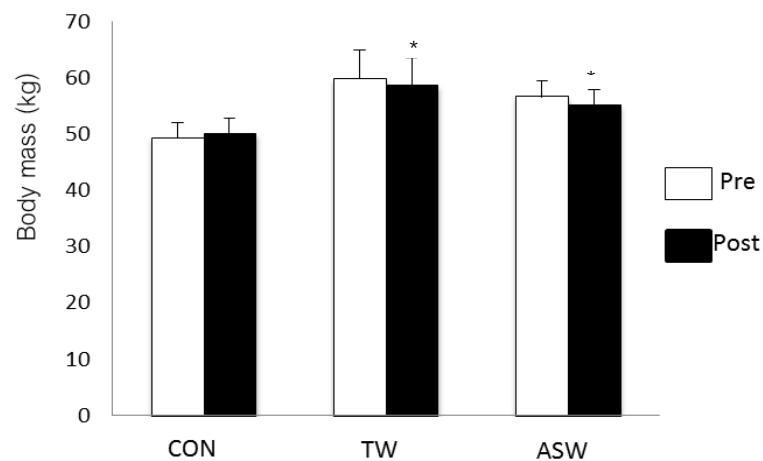

Figure 4.5 The comparison of body mass (kg) between pre and post training in three groups: sedentary control group (CON), traditional walking exercise training group (TW) and arm swing walking incorporating Buddhist meditation exercise training group (ASW).

Data of body mass after training were shown in table 4.5 and figure 4.4. The TW and ASW had a significantly lower ($p < 0.05$), but the CON had a significantly higher ($p < 0.05$) when compared to pre-test.

Table 4.6 The comparison of body mass index (kg/m^2) between pre and post training in three groups: sedentary control group (CON), traditional walking exercise training group (TW) and arm swing walking incorporating Buddhist meditation exercise training group (ASW).

Group	Body mass index (kg/m^2)		t	P-value
	Pre-test	Post-test		
CON(n=13)	24.02±1.09	24.39±1.08	-3.98	0.00*
TW (n=13)	25.99±2.04	25.44±2.04	4.48	0.00*
ASW (n=14)	25.48±1.15	24.79±1.15	2.59	0.02*

Values are mean \pm SEM., * $p < 0.05$ significant different from pre-test.

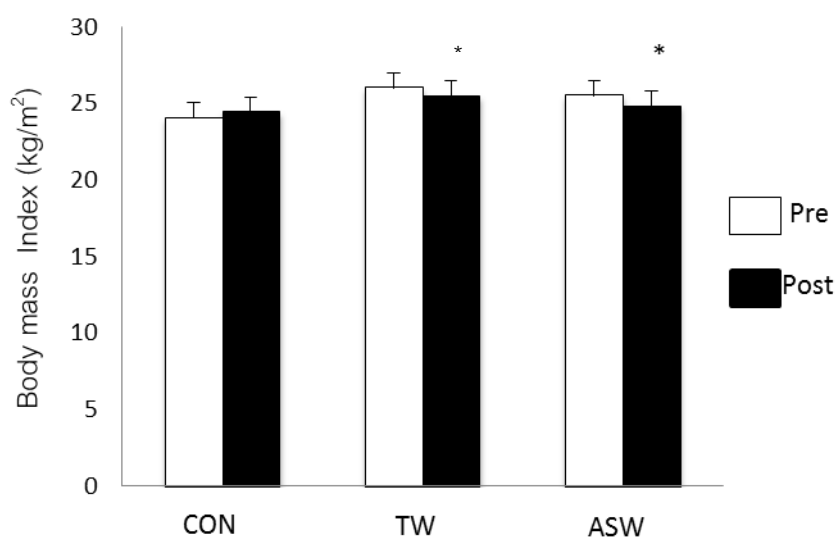

Figure 4.6 The comparison of body mass index (kg/m^2) between pre and post training in three groups: sedentary control group (CON), traditional walking exercise training group (TW) and arm swing walking incorporating Buddhist meditation exercise training group (ASW).

Data of body mass index after training were shown in table 4.6 and figure 4.6. TW and ASW groups had a significantly lower body mass index, but CON group had a significantly higher when compared to pre-test.

Table 4.7 The comparison of body fat (percentage) between pre and post training in three groups: sedentary control group (CON), traditional walking exercise training group (TW) and arm swing walking incorporating Buddhist meditation exercise training group(ASW).

Group	Body fat (%)		t	P-value
	Pre-test	Post-test		
CON (n=13)	34.64±1.96	35.63±1.69	-1.92	0.07
TW (n=13)	36.5±3.44	36.48±3.26	0.05	0.96
ASW (n=14)	37.97±2.00	33.37±1.55	2.77	0.02*

Values are mean ± SEM., * $p < 0.05$ significant different from pre-test.

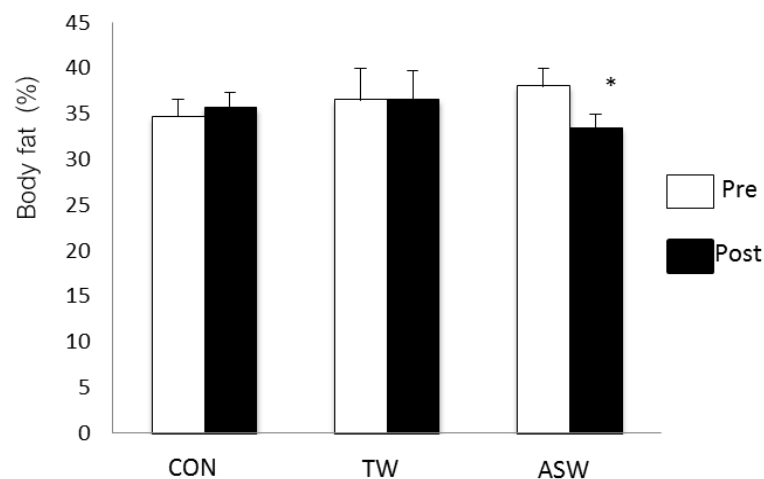

Figure 4.7 The comparison of body fat (percentage) between pre and post training in three groups: sedentary control group (CON), traditional walking exercise training group(TW) and arm swing walking incorporating Buddhist meditation exercise training group (ASW).

Data of body fat after training were shown in table 4.7 and figure 4.7. ASW had a significantly lower ($p < 0.05$) body fat when compared pre-test. There were no significant difference in TW and CON group.

Table 4.8 The comparison of maximum oxygen consumption ($VO_2\text{max}$; ml/kg/min) between pre and post training in three groups: sedentary control group (CON), traditional walking exercise training group (TW) and arm swing walking incorporating Buddhist meditation exercise training group (ASW).

Group	$VO_2\text{max}$ (ml/kg/min)		t	P-value
	Pre-test	Post-test		
CON (n=13)	23.54±1.09	23.34±1.04	1.22	0.24
TW (n=13)	23.68±1.76	25.13±1.78	-4.07	0.00*
ASW (n=14)	22.90±1.19	26.06±1.21	-9.52	0.00*

Values are mean ± SEM., * $p < 0.05$ significant different from pre-test.

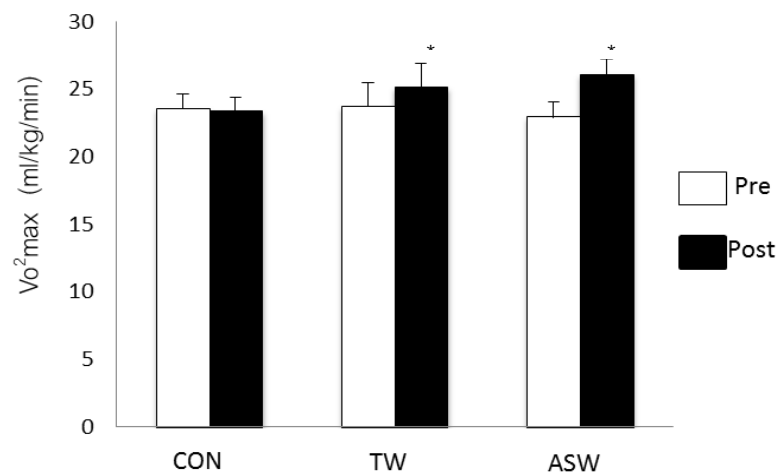

Figure 4.8 The comparison of maximum oxygen consumption ($VO_2\text{max}$; ml/kg/min) between pre and post training in three groups : sedentary control group (CON), traditional walking exercise training group (TW) and arm swing walking incorporating Buddhist meditation exercise training group (ASW).

Data of maximum oxygen consumption after training were shown in table 4.8 and figure 4.8. TW and ASW groups had a significantly higher ($p < 0.05$) maximum oxygen consumption when compared to pre-test. There was no significant difference in CON group.

Table 4.9 The comparison of forced vital capacity; FVC (liters) between pre and post training in three groups: sedentary control group (CON), traditional walking exercise training group (TW) and arm swing walking incorporating Buddhist meditation exercise training group (ASW).

Group	FVC (liters)		t	P-value
	Pre-test	Post-test		
CON (n=13)	1.34±0.15	1.17±0.12	1.04	0.31
TW (n=13)	1.51±0.15	1.64±0.16	-1.06	0.31
ASW (n=14)	1.2±0.08	1.61±0.12	-3.12	0.00*

Values are mean ± SEM., * $p < 0.05$ significant different from pre-test.

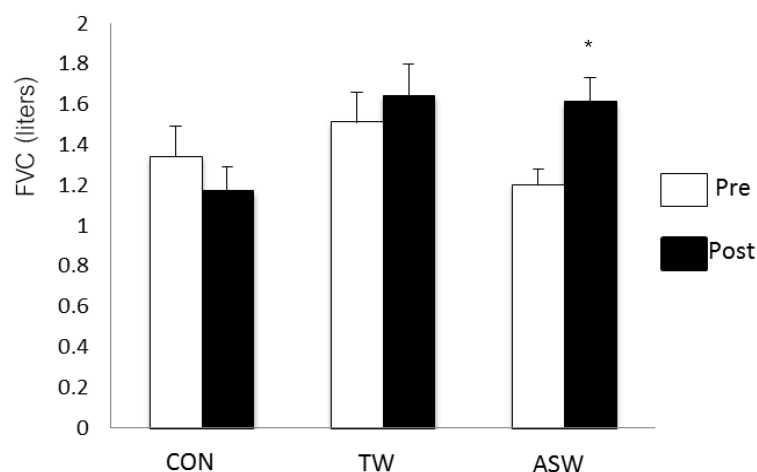

Figure 4.9 The comparison of forced vital capacity; FVC (liters) between pre and post training in three groups: sedentary control group (CON), traditional walking exercise training group (TW) and arm swing walking incorporating Buddhist meditation exercise training group (ASW).

Data of forced vital capacity after training were shown in table 4.9 and figure 4.9. ASW group had a significantly higher ($p < 0.05$) when compared pre-test. There were no significant difference in CON group.

Table 4.10 The comparison of forced expiratory volume at 1 second; FEV1 (liters) between pre and post training in three groups: sedentary control group (CON), traditional walking exercise training group (TW) and arm swing walking incorporating Buddhist meditation exercise training group (ASW).

Group	FEV1 (liters)		t	P-value
	Pre-test	Post-test		
CON (n=13)	0.66±0.08	0.68±0.08	-0.26	0.80
TW (n=13)	0.75±0.09	1.01±0.15	-1.85	0.09
ASW (n=14)	0.76±0.09	1.00±0.11	-1.64	0.13

Values are mean ± SEM.

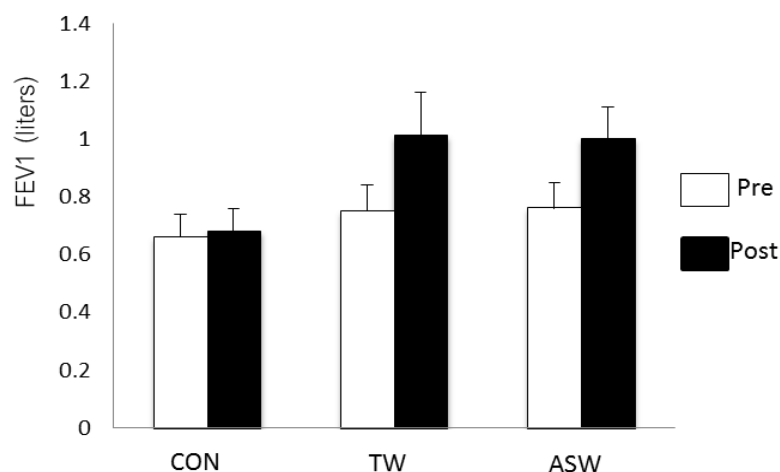

Figure 4.10 The comparison of forced expiratory volume at 1 second; FEV1 (liters) between pre and post training in three groups: sedentary control group (CON), traditional walking exercise training group (TW) and arm swing walking incorporating Buddhist meditation exercise training group (ASW).

Data of forced expiratory volume at 1 second after training were shown in table 4.10 and figure 4.10. There were no significant differences in forced expiratory volume at 1 second between pre and post- test in three groups; CON, TW, ASW.

Table 4.11 The comparison of physiological characteristics data among in sedentary control group (CON), traditional walking exercise training group (TW) and arm swing walking incorporating Buddhist meditation exercise training group (ASW) in pre-test.

Variables	CON(n=13)	TW(n=13)	ASW (n=14)	F	<i>p</i> -value
Body mass (kg)	49.25±2.79	59.78±5.11	56.55±2.82	2.08	0.14
BMI (kg/m ²)	24.02±1.09	25.99±2.04	25.48±1.15	0.47	0.63
Heart rate (bpm)	74.92±4.56	72.53±4.46	75.14±2.88	0.13	0.88
Systolic BP (mmHg)	128.38±5.91	126.46±6	124.21±5.58	0.13	0.88
Diastolic BP (mmHg)	67.38±3.41	69.38±3.22	63.57±2.80	0.90	0.41
Body fat (%)	34.64±1.96	36.5±3.44	37.97±2.00	0.44	0.65
VO ₂ max (ml/kg/min)	23.54±1.09	23.68±1.76	22.90±1.19	0.09	0.91
FVC(liter)	1.34±0.15	1.51±0.15	1.2±0.08	1.48	0.24
FEV1(liter)	0.66±0.08	0.75±0.09	0.76±0.09	0.43	0.65

Values are means±SEM.

BMI = body mass index, BP = blood pressure, VO₂max = maximal oxygen consumption, FVC = Forced vital capacity, FEV1 = Force expiratory volume in 1 second.

The difference of physiological characteristics data among in sedentary control group (CON), traditional walking exercise training group (TW) and arm swing walking incorporating Buddhist meditation exercise training group (ASW) in pre-test were shown in table 4.11. There were no significant difference in body mass, BMI, systolic blood pressure, diastolic blood pressure, heart rate, body fat, VO₂ max, FVC and FEV1 when compared among in CON group, TW group, ASW group.

Table 4.12 The comparison of physiological characteristics data among in sedentary control group (CON), traditional walking exercise training group (TW) and arm swing walking incorporating Buddhist meditation exercise training group (ASW) in post -test.

Variables	CON (n=13)	TW(n=13)	ASW(n=14)	F	P-value
Body mass (kg)	50.02 ±2.78	58.52±5.1*	55.03±2.88*	1.29	0.28
BMI (kg/m ²)	24.39±1.08	25.44±2.04*	24.79±1.15*	0.13	0.88
Heart rate (bpm)	75.46±3.85	77.77±3.20	72.21±2.88	0.72	0.49
Systolic BP (mmHg)	130.53±4.05	117.92±4.41*	114.78±4.72* [†]	3.54	0.04
Diastolic BP (mmHg)	74.31±2.82	65.92±2.52	58.86±2.41* [†]	8.94	0.00
Body fat (%)	35.63±1.69	36.48±3.26	33.37±1.55*	0.50	0.60
VO ₂ max (ml/kg/min)	23.34±1.04	25.13±1.78*	26.06±1.21*	1.01	0.37
FVC(liter)	1.17±0.12	1.64±0.16	1.61±0.12* [†]	3.86	0.03
FEV1(liter)	0.68±0.08	1.01±0.15	1.00±0.11	2.54	0.09

Values are means±SEM., * $p < 0.05$ significant among between pre - post training, [†] $p < 0.05$ vs.

Sedentary control BMI = body mass index, BP = blood pressure, VO₂max = maximal oxygen consumption, FVC = Forced vital capacity, FEV1 = Force expiratory volume in 1 second.

The difference of physiological characteristics data among in sedentary control group (CON), traditional walking exercise training group (TW) and arm swing walking incorporating Buddhist meditation exercise training group (ASW) in post-test were shown in table 4.12. ASW group had a significantly lower systolic blood pressure ($p < 0.05$), diastolic blood pressure ($p < 0.05$) than CON group, and had a significantly higher FVC than CON group ($p < 0.05$). However, there were no significant difference in body mass, BMI, HR, Body fat, VO₂ max and FEV1 when compared among in CON group, TW group, ASW group.

Part 3 The comparison of physical fitness data between pre and post- test training in three groups : sedentary control group (CON), traditional walking exercise training group (TW) and arm swing walking incorporating Buddhist meditation exercise training group (ASW).

Table 4.13 The comparison of arm curl test (rep) between pre and post training in three groups: sedentary control group (CON), traditional walking exercise training group (TW) and arm swing walking incorporating Buddhist meditation exercise training group (ASW).

Group	Arm curl test (rep)		t	p-value
	Pre-test	Post-test		
CON (n=13)	8.15±0.73	8.62±0.86	-0.66	0.52
TW (n=13)	11.31±0.76	12.85±0.87	-2.24	0.04*
ASW (n=14)	12.21±0.66	14.29±0.83	-3.70	0.00*

Values are mean ± SEM., * $p < 0.05$ significant among between pre - post training.

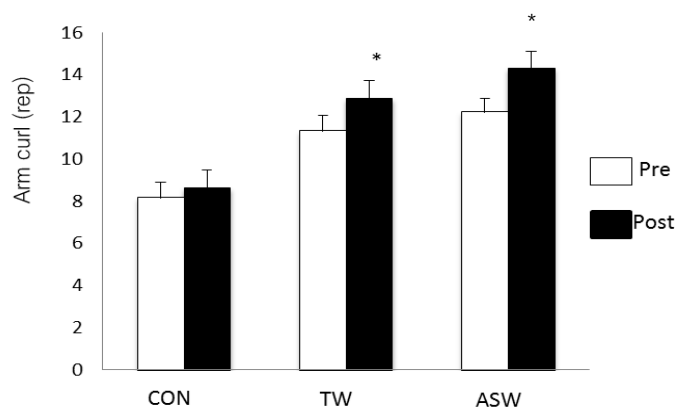

Figure 4.11 The comparison of arm curl test (rep) between pre and post training in three groups: sedentary control group (CON), traditional walking exercise training group (TW) and arm swing walking incorporating Buddhist meditation exercise training group (ASW).

Data of arm curl test after training were shown in table 4.13 and figure 4.11. TW and ASW group had a significantly higher ($p < 0.05$) arm curl test when compared to pre-test. There was no significant difference in CON group.

Table 4.14 The comparison of chair stand (rep/30 sec) between pre and post training in three groups: sedentary control group (CON), traditional walking exercise training group (TW) and arm swing walking incorporating Buddhist meditation exercise training group (ASW).

Group	Chair stand (rep/30 sec)		t	P-value
	Pre-test	Post-test		
CON (n=13)	5.61±0.69	5.92±0.70	-1.3	0.22
TW (n=13)	7.00±0.71	8.92±0.75	-4.81	0.00*
ASW (n=14)	9.0±0.78	10.50±0.91	-5.14	0.00*

Value are mean ± SEM., * $p < 0.05$ significant among between pre - post training

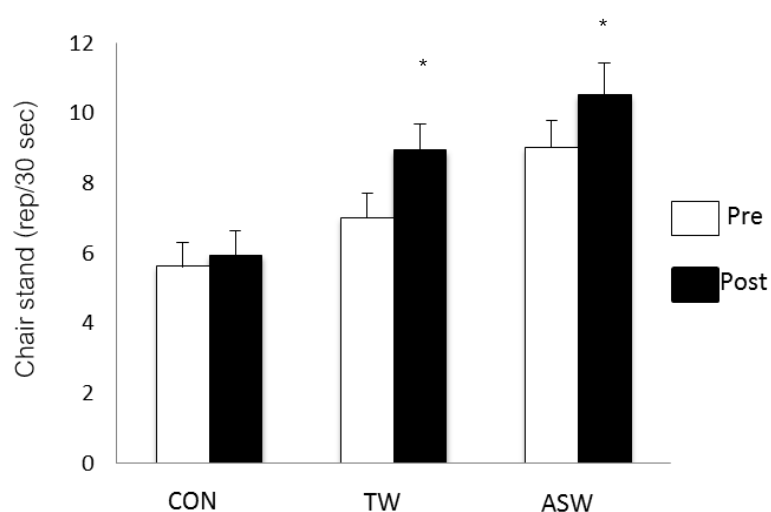

Figure 4.12 The comparison of chair stand (rep/30 sec) between pre and post training in three groups: sedentary control group (CON), traditional walking exercise training group (TW) and arm swing walking incorporating Buddhist meditation exercise training group (ASW).

Data of chair stand after training were shown in table 4.14 and figure 4.12. TW group and ASW group had a significantly higher ($p < 0.05$) chair stand when compared pre- test. There was no significant difference in CON group.

Table 4.15 The comparison of back scratch (cm) between pre and post training in three groups: sedentary control group (CON), traditional walking exercise training group (TW) and arm swing walking incorporating Buddhist meditation exercise training group (ASW).

Group	Back scratch (cm)		t	P-value
	Pre-test	Post-test		
CON (n=13)	-21.19±3.94	-29.89±5.44	2.12	0.06
TW (n=13)	-19.15±6.41	-11.33±5.14	-4.08	0.00*
ASW (n=14)	-10.34±2.47	-5.26±2.17	-6.75	0.00*

Values are mean ± SEM., * $p < 0.05$ significant among between pre - post training.

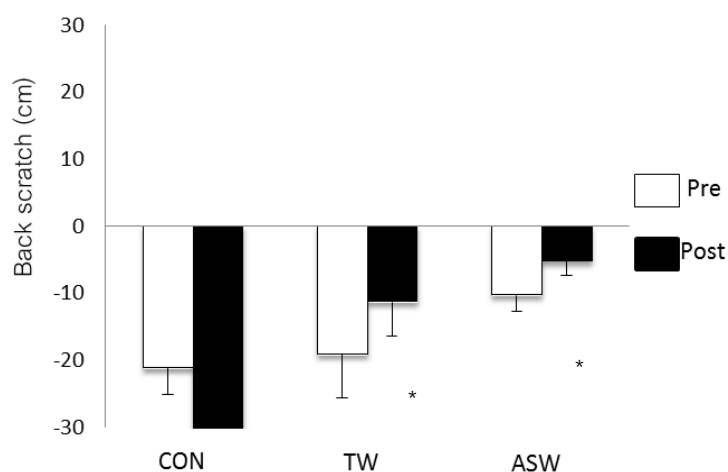

Figure 4.13 The comparison of back scratch (cm) between pre and post training in three groups: sedentary control group (CON), traditional walking exercise training group (TW) and arm swing walking incorporating Buddhist meditation exercise training group (ASW).

Data of back scratch were shown in table 4.15 and figure 4.13. TW and ASW groups had a significantly improved ($p < 0.01$) back scratch when compared pre-test. There was no significant difference in CON group.

Table 4.16 The comparison of chair sit and reach (cm) between pre and post training in three groups: sedentary control group (CON), traditional walking exercise training group (TW) and arm swing walking incorporating Buddhist meditation exercise training group (ASW).

Group	Chair sit and reach (cm)		t	P-value
	Pre-test	Post-test		
CON (n=13)	-4.20±2.0	-2.83±2.04	-1.00	0.34
TW (n=13)	-8.69±3.52	3.71±1.5	-3.87	0.00*
ASW (n=14)	-1.99±1.99	4.35±1.54	-2.84	0.01*

Values are mean ± SEM., * $p < 0.05$ significant among between pre - post training.

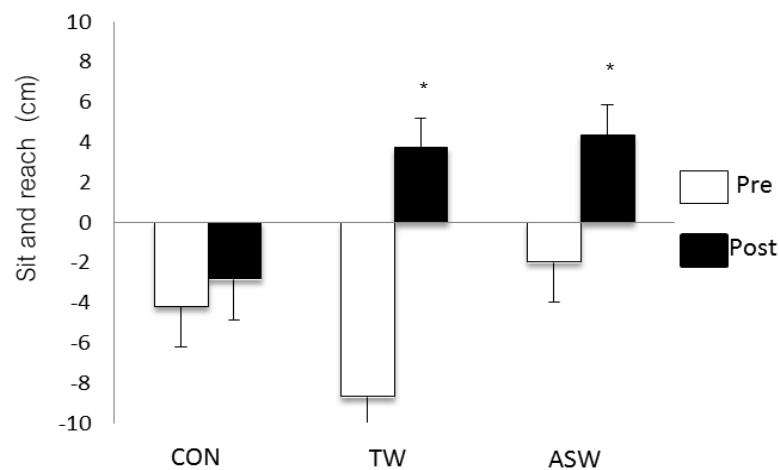

Figure 4.14 The comparison of chair sit and reach (cm) between pre and post training in three groups: sedentary control group (CON), traditional walking exercise training group (TW) and arm swing walking incorporating Buddhist meditation exercise training group (ASW).

Data of chair sit and reach after training were shown in table 4.16 and figure 4.14. TW and ASW groups had a significantly improved ($p < 0.05$) chair sit and reach when compared pre-test. There was no significant difference in CON group.

Table 4.17 The comparison of timed up-and-go (s) between pre and post training in three groups: sedentary control group (CON), traditional walking exercise training group (TW) and arm swing walking incorporating Buddhist meditation exercise training group (ASW).

Group	Timed up-and-go (s)		t	P-value
	Pre-test	Post-test		
CON (n=13)	14.85±1.5	18.96±2.68	-1.79	0.09
TW (n=13)	12.15±0.82	10.15±0.71	5.10	0.00*
ASW (n=14)	9.86±0.64	8.57±0.51	6.62	0.00*

Values are mean ± SEM., * $p < 0.05$ significant among between pre - post training.

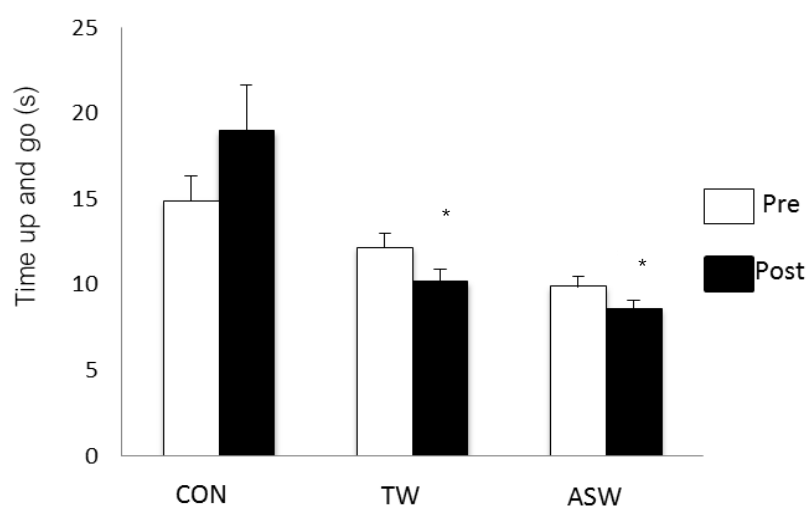

Figure 4.15 The comparison of timed up-and-go (s) between pre and post training in three groups: sedentary control group (CON), traditional walking exercise training group (TW) and arm swing walking incorporating Buddhist meditation exercise training group (ASW).

Data of timed up-and-go after training were shown in table 4.17 and figure 4.15. TW and ASW groups had a significantly improved ($p < 0.05$) time up-and-go when compared pre-test. There was no significant difference in CON group.

Table 4.18 The comparison of 6-minute walk test (m) between pre and post training in three groups: sedentary control group (CON), traditional walking exercise training group (TW) and arm swing walking incorporating Buddhist meditation exercise training group (ASW).

Group	6-minute walk test (m)		t	P-value
	Pre-test	Post-test		
CON (n=13)	149.31±23.76	139.38±20.03	1.44	0.18
TW (n=13)	221.38±12.78	284.46±16.97	-4.07	0.00*
ASW (n=14)	164.21±13	301.64±18.03	-9.53	0.00*

Values are mean ± SEM., * $p < 0.05$ significant among between pre - post training.

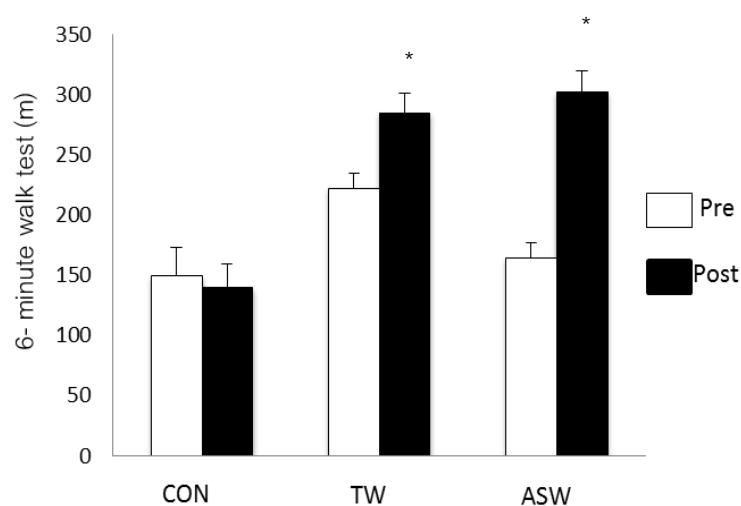

Figure 4.16 The comparison of 6-minute walk test (m) between pre and post training in three groups: sedentary control group (CON), traditional walking exercise training group (TW) and arm swing walking incorporating Buddhist meditation exercise training group (ASW).

Data of 6-minute walk test after training were shown in table 4.18 and figure 4.16. TW and ASW groups had a significantly higher ($p < 0.05$) 6-minute walk test when compared pre-test. There was no significant difference in CON group.

Table 4.19 The comparison of physical fitness data among in sedentary control group (CON), traditional walking exercise training group (TW) and arm swing walking incorporating Buddhist meditation exercise training group (ASW) in pre-test.

Variables	CON (n=13)	TW (n=13)	ASW (n=14)	F	P-value
Arm curl (rep)	8.15±0.73	11.31±0.76 [†]	12.21±0.66 [†]	8.84	0.00
Chair stand (rep/30 sec)	5.61±0.69	7.00±0.71	9.0±0.78 [†]	5.47	0.01
Back scratch (cm)	-21.19±3.94	-19.15±6.41	-10.34±2.47	1.68	0.20
Chair sit and reach (cm)	-4.20±2.0	-8.69±3.52	-1.99±1.99	1.76	0.19
Timed up-and- go (s)	14.85±1.5	12.15±0.82	9.86±0.64 [†]	5.85	0.01
Six-minute walk test (m)	149.31±23.76	221.38±12.78 [†]	164.21±13	4.85	0.01

Values are mean ± SEM., [†] $p < 0.05$ significant difference from sedentary control.

The difference physical fitness data among in sedentary control group (CON), traditional walking exercise training group (TW) and arm swing walking incorporating Buddhist meditation exercise training group (ASW) in pre-test were shown in table 4.19. ASW group had a significantly higher in arm curl, chair stand, time up and go test (all $p < 0.05$) than CON. TW group had a significantly higher in arm curl and 6 minute walk test ($p < 0.05$), Back scratch chair sit ($p < 0.05$) than CON group. There were no significant difference in arm curl, chair stand, back scratch, chair sit and reach, time up and go and six minute walk test in CON group.

Table 4.20 The comparison of physical fitness data among in sedentary control group (CON), traditional walking exercise training group (TW) and arm swing walking incorporating Buddhist meditation exercise training group (ASW) in post-test

Variables	CON (n=13)	TW (n=13)	ASW (n=14)	F	P-value
Arm curl (rep)	8.62±0.86	12.85±0.87 [*]	14.29±0.83 ^{*†}	8.84	0.00
Chair stand (rep/30 sec)	5.92±0.70	8.92±0.75 [*]	10.50±0.91 ^{*†}	8.49	0.00
Back scratch (cm)	-29.89±5.44	-11.33±5.14 ^{*†}	-5.26±2.17 ^{*†}	8.44	0.00
Chair sit and reach (cm)	-2.83±2.04	3.71±1.5 ^{*†}	4.35±1.54 ^{*†}	5.39	0.00
Timed up-and- go (s)	18.96±2.68	10.15±0.71 ^{*†}	8.57±0.51 ^{*†}	12.30	0.00
6-minute walk test (m)	139.38±20.03	284.46±16.97 ^{*†}	301.64±18.03 ^{*†}	23.31	0.00

Values are mean ± SEM., * $p < 0.05$ significant among between pre - post training

, † $p < 0.05$ significant difference from sedentary control.

The difference physical fitness data among in sedentary control group (CON), traditional walking exercise training group (TW) and arm swing walking incorporating Buddhist meditation exercise training group (ASW) in post-test were shown in table 4.20. ASW group had a significantly higher in arm curl, chair stand, back scratch, 6 minute walk test (all $p < 0.05$), chair sit and reach ($p < 0.05$) than CON. TW group had a significantly higher in timed-up-and go, 6 minute walk test ($p < 0.05$), Back scratch chair sit ($p < 0.05$) than CON group.

Part 4: The comparison of endothelial-dependent vasodilation between pre and post-test training in three groups: sedentary control group (CON), traditional walking exercise training group (TW) and arm swing walking incorporating Buddhist meditation exercise training group (ASW).

Table 4.21 The comparison of resting diameter (mm) between pre and post training in three groups: sedentary control group (CON), traditional walking exercise training group (TW) and arm swing walking incorporating Buddhist meditation exercise training group (ASW).

Group	Resting diameter (mm)		t	P-value
	Pre-test	Post-test		
CON (n=13)	3.93±0.10	3.80±0.11	2.02	0.67
TW (n=13)	3.89±0.13	4.02±0.05	-0.93	0.37
ASW (n=14)	3.86±0.12	4.37±0.1	-5.22	0.00*

Values are mean ± SEM., * $p < 0.05$ significant different from pre-test.

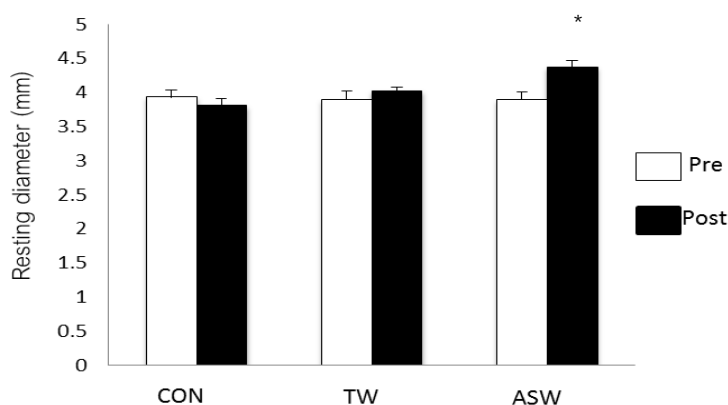

Figure 4.17 The comparison of resting diameter (mm) between pre and post training in three groups: sedentary control group (CON), traditional walking exercise training group (TW) and arm swing walking incorporating Buddhist meditation exercise training group (ASW).

Data of resting diameter after training were shown in table 4.21 and figure 4.17. ASW groups had a significantly higher ($p < 0.05$) resting diameter when compared pre-test. There was no significant difference in TW and CON group.

Table 4.22 The comparison of peak diameter (mm) between pre and post training in three groups: sedentary control group (CON), traditional walking exercise training group (TW) and arm swing walking incorporating Buddhist meditation exercise training group (ASW).

Group	Peak diameter (mm)		t	P-value
	Pre-test	Post-test		
CON (n=13)	4.17±0.12	4.02±0.1	2.64	0.02*
TW (n=13)	4.08±0.11	4.38±0.04	-2.69	0.02*
ASW (n=14)	4.10±0.11	4.89±0.1	-7.07	0.00*

Values are mean ± SEM., * $p < 0.05$ significant different from pre-test.

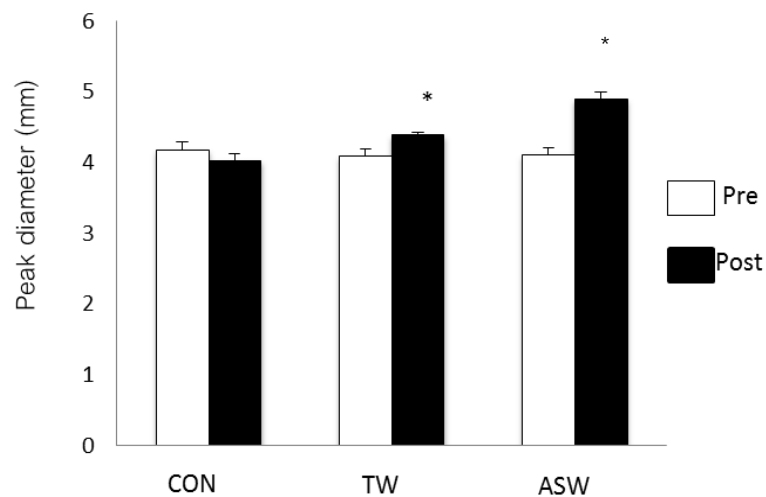

Figure 4.18 The comparison of peak diameter (mm) between pre and post training in three groups: sedentary control group (CON), traditional walking exercise training group (TW) and arm swing walking incorporating Buddhist meditation exercise training group (ASW).

Data of peak diameter after training were shown in table 4.22 and figure 4.18. TW and ASW had a significantly higher ($p < 0.05$), but CON had a significantly lower peak diameter when compared pre-test.

Table 4.23 The comparison of flow-mediated dilatation (%) between pre and post training in three groups: sedentary control group (CON), traditional walking exercise training group (TW) and arm swing walking incorporating Buddhist meditation exercise training group (ASW).

Group	Flow-mediated dilatation (%)		t	P-value
	Pre-test	Post-test		
CON (n=13)	6.20±0.73	5.87±1.61	0.18	0.86
TW (n=13)	5.31±1.2	9.14±1.29	-2.2	0.04*
ASW (n=14)	6.51±1.01	12.22±1.36	-4.65	0.00*

Values are mean ± SEM. * $p < 0.05$ significant different from pre-test.

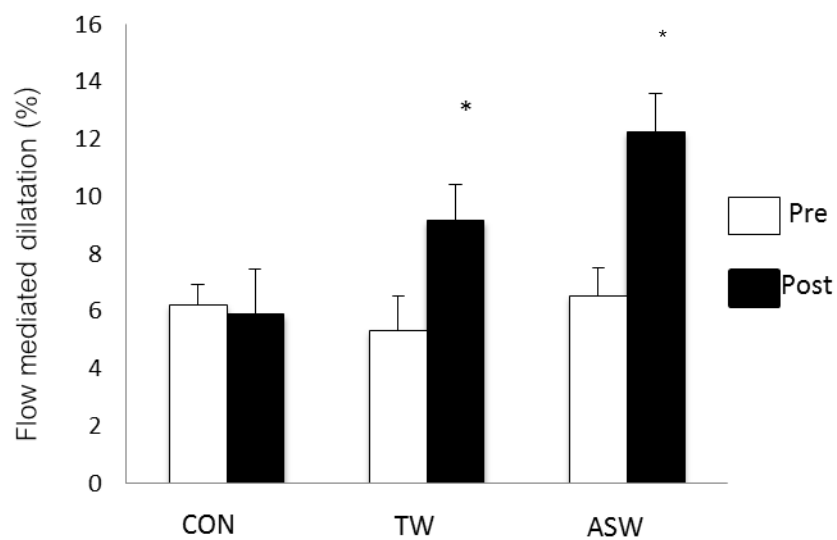

Figure 4.19 The comparison of flow-mediated dilatation (%) between pre and post training in three groups: sedentary control group (CON), traditional walking exercise training group (TW) and arm swing walking incorporating Buddhist meditation exercise training group (ASW).

Data of flow-mediated dilatation after training were shown in Table 4.23 and Figure 4.19. TW and ASW had a significantly higher ($p < 0.05$) when compared pre-test. There was no significant difference in CON group.

Table 4.24 The comparison of time to peak diameter (s) between pre and post training in three groups: sedentary control group (CON), traditional walking exercise training group (TW) and arm swing walking incorporating Buddhist meditation exercise training group (ASW).

Group	Time to peak diameter (s)		t	P-value
	Pre-test	Post-test		
CON (n=13)	70.15±3.94	66.92±5.02	0.60	0.56
TW (n=13)	85.69±5.56	59.07±4.14	3.93	0.00*
ASW (n=14)	75.64±3.7	54±2.74	4.35	0.00*

Value are mean ± SEM., * $p < 0.05$, significant different from pre-test.

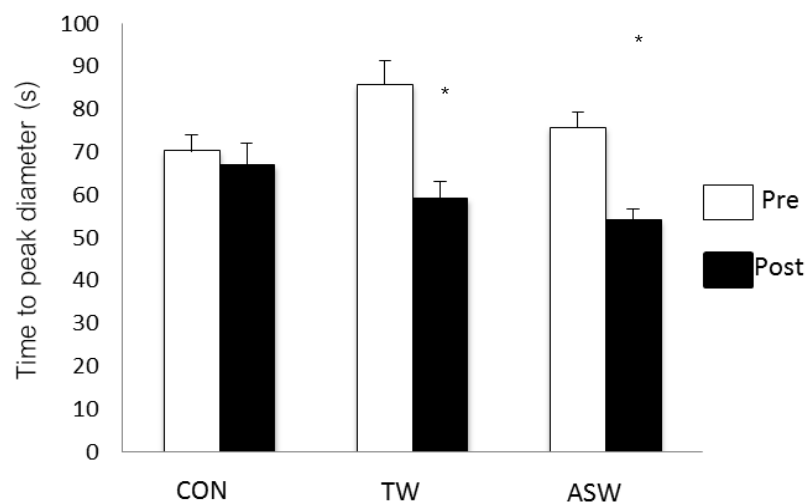

Figure 4.20 The comparison of time to peak diameter (s) between pre and post training in three groups: sedentary control group (CON), traditional walking exercise training group (TW) and arm swing walking incorporating Buddhist meditation exercise training group (ASW).

Data of time to peak diameter after training were shown in table 4.24 and figure 4.20. TW and ASW had a significantly improved ($p < 0.05$) time to peak diameter when compared pre-test. There was no significant difference in CON group.

Table 4.25 The comparison of shear rate at rest (s^{-1}) between pre and post training in three groups: sedentary control group (CON), traditional walking exercise training group (TW) and arm swing walking incorporating Buddhist meditation exercise training group (ASW).

Group	Shear rate at rest (s^{-1})		t	P-value
	Pre-test	Post-test		
CON (n=13)	59.78±8.19	61.74±8.16	-0.21	0.84
TW (n=13)	61.50±3.27	58.57±5.02	0.58	0.57
ASW (n=14)	46.85±1.14	94.80±6.78	-7.5	0.00*

Values are mean ± SEM., * $p < 0.05$, significant different from pre-test.

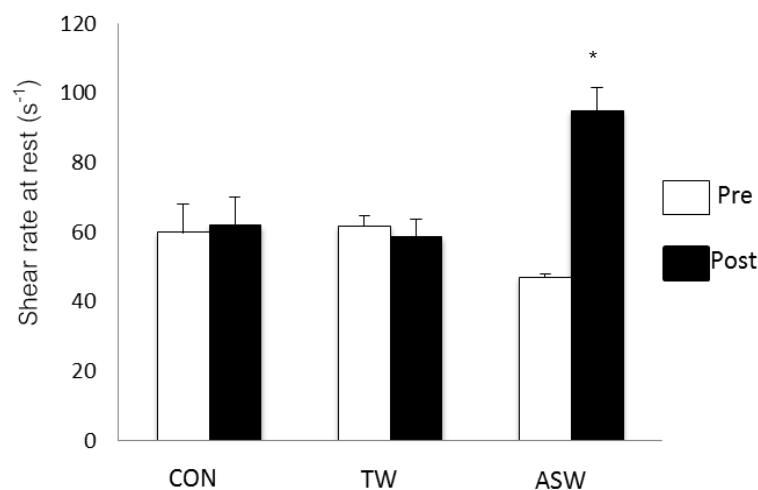

Figure 4.21 The comparison of shear rate at rest (s^{-1}) between pre and post training in three groups: sedentary control group (CON), traditional walking exercise training group (TW) and arm swing walking incorporating Buddhist meditation exercise training group (ASW).

Data of shear rate at rest after training were shown in table 4.25 and figure 4.21. ASW had a significantly higher ($p < 0.05$) shear rate at rest when compared pre-test. There were no significant difference in TW and CON group.

Table 4.26 The comparison of peak shear rate (s^{-1}) between pre and post training in three groups: sedentary control group (CON), traditional walking exercise training group (TW) and arm swing walking incorporating Buddhist meditation exercise training group (ASW).

Group	Peak shear rate (s^{-1})		t	P-value
	Pre-test	Post-test		
CON (n=13)	95.81±11.68	89.51±7.17	0.57	0.58
TW (n=13)	97.48±2.05	126.44±8.52	-3.20	0.00*
ASW (n=14)	74.18±4.61	139±8.09	-7.22	0.00*

Values are mean ± SEM., * $p < 0.05$, significant different from pre-test.

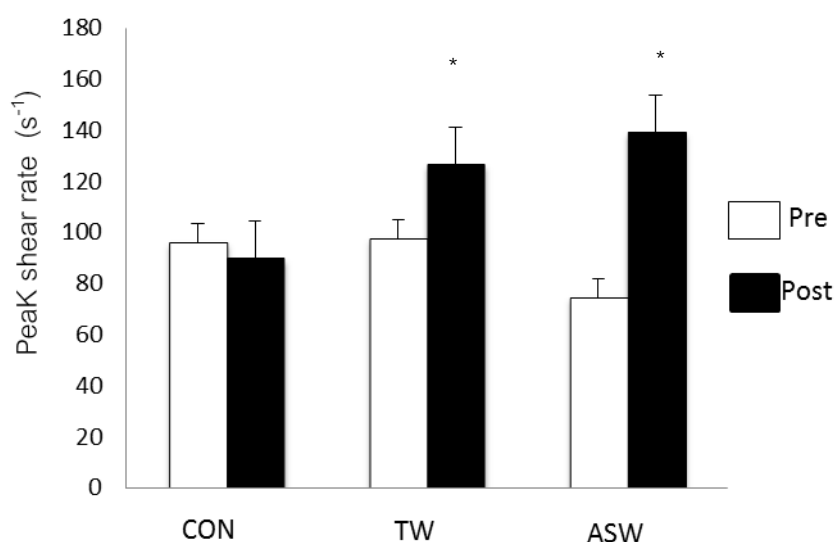

Figure 4.22 The comparison of peak shear rate (s^{-1}) between pre and post training in three groups: sedentary control group (CON), traditional walking exercise training group (TW) and arm swing walking incorporating Buddhist meditation exercise training group (ASW).

Data of peak shear rate after training were shown in table 4.26 and figure 4.22. TW and ASW groups had a significantly higher ($p < 0.05$) peak shear rate when compared pre-test. There was no significant difference in CON group.

Table 4.27 The comparison of endothelial- dependent vasodilation variables among in sedentary control group (CON), traditional walking exercise training group (TW) and arm swing walking incorporating Buddhist meditation exercise training group (ASW) in pre-test.

Variables	CON (n=13)	TW (n=13)	ASW (n=14)	F	P-value
Resting diameter (mm)	3.93±0.10	3.89±0.13	3.86±0.12	0.08	0.92
Peak diameter (mm)	4.17±0.12	4.08±0.11	4.10±0.11	0.17	0.84
Flow-mediate dilatation (%)	6.20±0.73	5.31±1.2	6.51±1.01	0.35	0.70
Time to peak diameter (s)	70.15±3.94	85.69±5.56	75.64±3.7	3.07	0.06
Shear rate at rest (s ⁻¹)	59.78±8.19	61.50±3.27	46.85±1.14	2.62	0.09
Peak shear rate (s ⁻¹)	95.81±11.68	97.48±2.05	74.18±4.61	3.30	0.06

Values are mean ± SEM.

The difference of endothelial-dependent vasodilation variables among in sedentary control group (CON), traditional walking exercise training group (TW) and arm swing walking incorporating Buddhist meditation exercise training group (ASW) in pre-test were shown in table 4.27.

There were no significant difference in resting diameter, peak diameter, flow-mediate dilatation, time to peak diameter, shear rate at rest, peak shear rate when compared among CON, TW, ASW group.

Table 4.28 The comparison of endothelial- dependent vasodilation variables among in sedentary control group (CON), traditional walking exercise training group (TW) and arm swing walking incorporating Buddhist meditation exercise training group (ASW) in post-test.

Variables	CON (n=13)	TW (n=13)	ASW (n=14)	F	P-value
Resting diameter (mm)	3.80±0.11	4.02±0.05	4.37±0.1 ^{*†#}	9.66	0.00
Peak diameter (mm)	4.02±0.1	4.38±0.04 ^{*†}	4.89±0.1 ^{*†#}	26.7	0.00
Flow-mediate dilatation (%)	5.87±1.61	9.14±1.29 [*]	12.22±1.36 ^{*†}	5.01	0.01
Time to peak diameter (s)	66.92±5.02	59.07±4.14 [*]	54±2.74 [*]	2.63	0.08
Shear rate at rest (s ⁻¹)	61.74±8.16	58.57±5.02	94.80±6.78 ^{*†}	8.94	0.00
Peak shear rate (s ⁻¹)	89.51±7.17	126.44±8.52 ^{*†}	139±8.09 ^{*†}	10.43	0.00

^{*} $p < 0.05$ significant difference from pre- test in group, [†] $p < 0.05$ significant difference from sedentary control.

The difference of endothelial-dependent vasodilation variables among in sedentary control group (CON), traditional walking exercise training group (TW) and arm swing walking incorporating Buddhist meditation exercise training group (ASW) in post-test were shown in table 4.28.

ASW group had a significantly higher in resting diameter, peak diameter, flow mediated dilatation, shear rate at rest, peak shear rate (all $p < 0.05$) than CON group, whereas TW group had a significantly improved peak diameter ($p < 0.05$) and peak shear rate ($p < 0.05$). Then, ASW group had significantly higher resting diameter and peak diameter than TW group ($p < 0.05$).

Part 5: The comparison of depression score and cortisol concentration between pre and post- test training in three groups: sedentary control group (CON), traditional walking exercise training group (TW) and arm swing walking incorporating Buddhist meditation exercise training group (ASW).

Table 4.29 The comparison of depression (score) between pre and post training in three groups: sedentary control group (CON), traditional walking exercise training group (TW) and arm swing walking incorporating Buddhist meditation exercise training group (ASW).

Group	Depression (score)		t	P-value
	Pre-test	Post-test		
CON (n=13)	17.92±0.70	18.61±0.60	-1.39	0.19
TW (n=13)	17.30±1.00	15.46±0.9	2.06	0.06
ASW (n=14)	16.78±0.92	8.64±0.61	10.89	0.00 [*]

Values are mean ± SEM., ^{*} $p < 0.05$, significant different from pre-test.

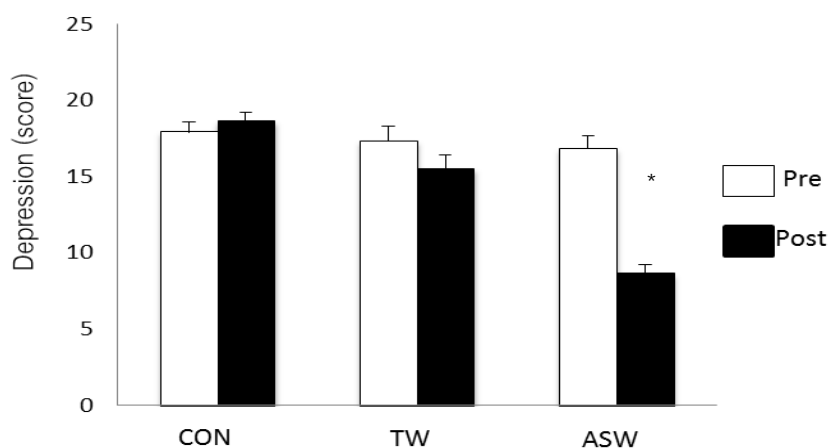

Figure 4.22 The comparison of depression (score) between pre and post training in three groups: sedentary control group (CON), traditional walking exercise training group (TW) and arm swing walking incorporating Buddhist meditation exercise training group (ASW).

Data of depression after training were shown in table 4.29 and figure 4.22. ASW groups had a significantly decreased ($p < 0.05$) depression score when compared pre-test. There were no significant difference in TW and CON group.

Table 4.30 The comparison of cortisol concentration (ug%) between pre and post training in three groups: sedentary control group (CON), traditional walking exercise training group (TW) and arm swing walking incorporating Buddhist meditation exercise training group (ASW).

Group	Cortisol concentration (ug%)		t	P-value
	Pre-test	Post-test		
CON (n=13)	12.49±0.64	13.72±2.60	-3.61	0.00*
TW (n=13)	13.33±1.04	12.26±0.9	1.89	0.83
ASW (n=14)	11.89±0.88	10.34±0.83	6.73	0.00*

Values are mean ± SEM., * $p < 0.05$, significant different from pre-test.

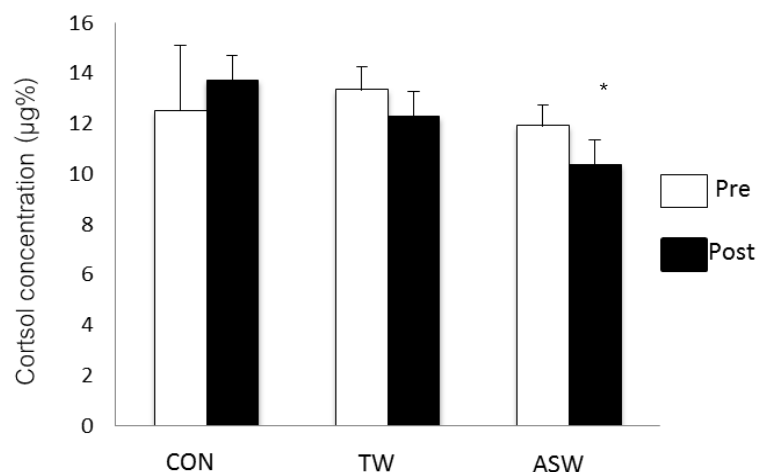

Figure 4.23 The comparison of cortisol concentration (ug%) between pre and post training in three groups: sedentary control group (CON), traditional walking exercise training group (TW) and arm swing walking incorporating Buddhist meditation exercise training group (ASW).

Data of cortisol concentration after training were shown in table 4.30 and figure 4.23. ASW groups had a significantly decreased ($p < 0.05$) cortisol concentration when compared pre-test, but CON group had a significantly increased ($p < 0.05$) cortisol concentration. There was no significant difference in TW group.

Table 4.31 The comparison of depression score and cortisol concentration among in sedentary control group (CON), traditional walking exercise training group (TW) and arm swing walking incorporating Buddhist meditation exercise training group (ASW) in pre-test.

Variables	CON (n=13)	TW(n=13)	ASW(n=14)	F	<i>P</i> -value
Depression (score)	17.92±0.70	17.30±1.0	16.78±0.92	0.38	0.69
Cortisol (ug%)	12.49±0.64	13.33±1.04	11.89±0.88	0.69	0.51

Values are mean ± SEM.

The difference of depression and cortisol concentration among in sedentary control group (CON), traditional walking exercise training group (TW) and arm swing walking incorporating Buddhist meditation exercise training group (ASW) in pre-test were shown in table 4.31.

There were no significant difference in depression score and cortisol concentration when compared among in CON group, TW group and ASW group.

Table 4.32 The comparison of depression score and cortisol concentration among in sedentary control group (CON), traditional walking exercise training group (TW) and arm swing walking incorporating Buddhist meditation exercise training group (ASW) in post-test.

Variables	CON (n=13)	TW(n=13)	ASW(n=14)	F	P-value
Depression (score)	18.61±0.6	15.46±0.09	8.64±0.61 ^{*†#}	46.40	0.00
Cortisol (ug%)	13.72±2.60 [*]	12.26±0.9	10.34±0.83 ^{*†}	4.31	0.02

Values are mean ± SEM., ^{*} $p < 0.05$, significant difference from pre- test in group, [†] $p < 0.05$, significant difference from sedentary control.

The difference of depression and cortisol concentration among in sedentary control group (CON), traditional walking exercise training group (TW) and arm swing walking incorporating Buddhist meditation exercise training group (ASW) in post-test were shown in table 4.32.

Depression score and cortisol concentration decreased ($p < 0.05$) only in the ASW group when compare in CON, TW, ASW group.

Part 6: The comparison of blood chemical data between pre and post- test training in three groups: sedentary control group (CON), traditional walking exercise training group (TW) and arm swing walking incorporating Buddhist meditation exercise training group (ASW).

Table 4.33 The comparison of cholesterol (mg/dl) between pre and post training in three groups: sedentary control group (CON), traditional walking exercise training group (TW) and arm swing walking incorporating Buddhist meditation exercise training group (ASW).

Group	Cholesterol (mg/dl)		t	P-value
	Pre-test	Post-test		
CON (n=13)	216.15±15.16	226.77±11.95	-1.66	0.12
TW (n=13)	205.92±12.03	181.61±11.47	3.36	0.00*
ASW (n=14)	199.36±11.40	180.57±9.48	4.36	0.00*

Values are mean ± SEM., * $p < 0.05$, significant different from pre-test.

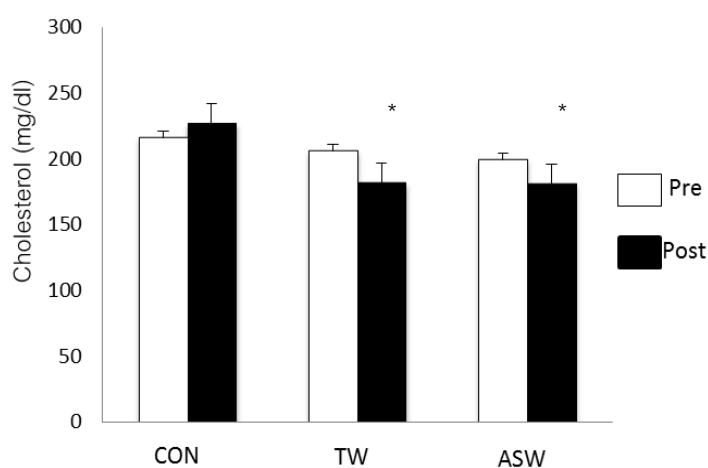

Figure 4.25 The comparison of cholesterol (mg/dl) between pre and post training in three groups: sedentary control group (CON), traditional walking exercise training group (TW) and arm swing walking incorporating Buddhist meditation exercise training group (ASW).

Data of cholesterol after training were shown in table 4.33 and figure 4.24. TW and ASW groups had a significantly lower ($p < 0.05$) cholesterol when compared pre-test. There was no significant difference in CON group.

Table 4.34 The comparison of triglyceride (mg/dl) between pre and post training in three groups: sedentary control group (CON), traditional walking exercise training group (TW) and arm swing walking incorporating Buddhist meditation exercise training group (ASW).

Group	Triglyceride (mg/dl)		t	P- value
	Pre-test	Post-test		
CON (n=13)	134.31±9.75	145.15±12.40	-1.28	0.22
TW (n=13)	164.61±22.42	130.23±16.49	4.54	0.00 [*]
ASW (n=14)	180.78±20.91	131.50±18.38	3.71	0.00 [*]

Values are mean ± SEM., ^{*} $p < 0.05$, significant different from pre-test.

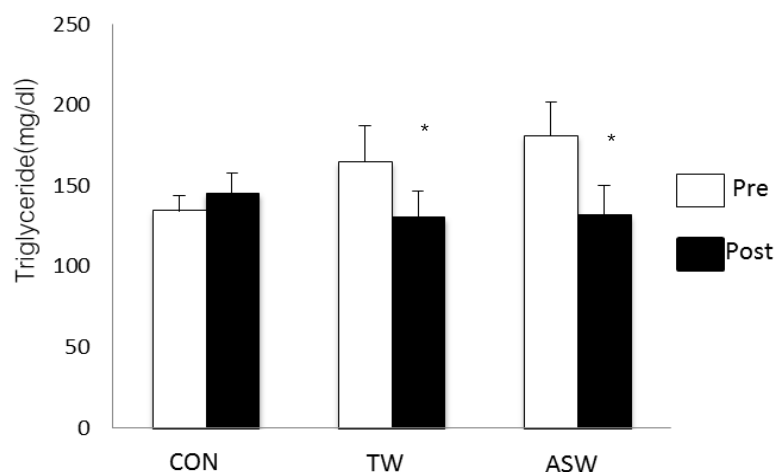

Figure 4.26 The comparison of triglyceride (mg/dl) between pre and post training in three groups: sedentary control group (CON), traditional walking exercise training group (TW) and arm swing walking incorporating Buddhist meditation exercise training group (ASW).

Data of triglyceride after training were shown in table 4.34 and figure 4.26. TW and ASW groups had a significantly lower ($P < 0.05$) cholesterol when compared pre-test. There was no significant difference in CON group.

Table 4.35 The comparison of low density lipoprotein cholesterol (mg/dl) between pre and post training in three groups: sedentary control group (CON), traditional walking exercise training group (TW) and arm swing walking incorporating Buddhist meditation exercise training group (ASW).

Group	Low density lipoprotein Cholesterol (mg/dl)		t	P-value
	Pre-test	Post-test		
CON (n=13)	135.38±13.03	129.69±10.98	0.68	0.50
TW (n=13)	113.69±10.10	107±10.33	0.76	0.46
ASW (n=14)	115.07±9.34	101.14±8.00	2.73	0.01*

Values are mean ± SEM., * $p < 0.05$, significant different from pre-test.

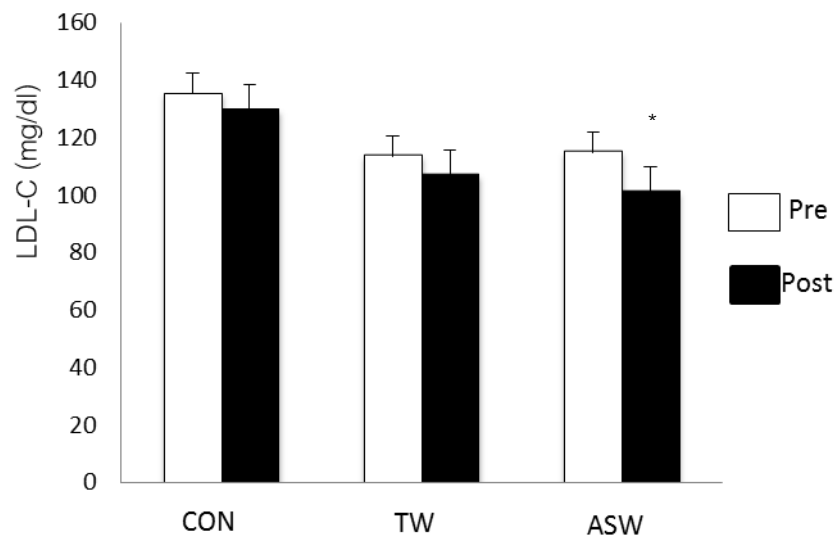

Figure 4.27 The comparison of low density lipoprotein cholesterol (mg/dl) between pre and post training in three groups: sedentary control group (CON), traditional walking exercise training group (TW) and arm swing walking incorporating Buddhist meditation exercise training group (ASW).

Data of low density lipoprotein cholesterol after training were shown in table 4.35 and figure 4.27. ASW groups had a significantly lower ($p < 0.05$) low density lipoprotein cholesterol when compared pre-test. There were no significant difference in CON and TW group.

Table 4.36 The comparison of high density lipoprotein cholesterol (mg/dl) between pre and post training in three groups: sedentary control group (CON), traditional walking exercise training group (TW) and arm swing walking incorporating Buddhist meditation exercise training group (ASW).

Group	High density lipoprotein Cholesterol (mg/dl)		t	P-value
	Pre-test	Post-test		
CON (n=13)	53.08±4.16	51.38±2.97	0.85	0.41
TW (n=13)	48.15±3.46	48.85±3.92	-1.07	0.30
ASW (n=14)	45.86±3.13	46.28±2.96	-0.84	0.42

Values are mean ± SEM.

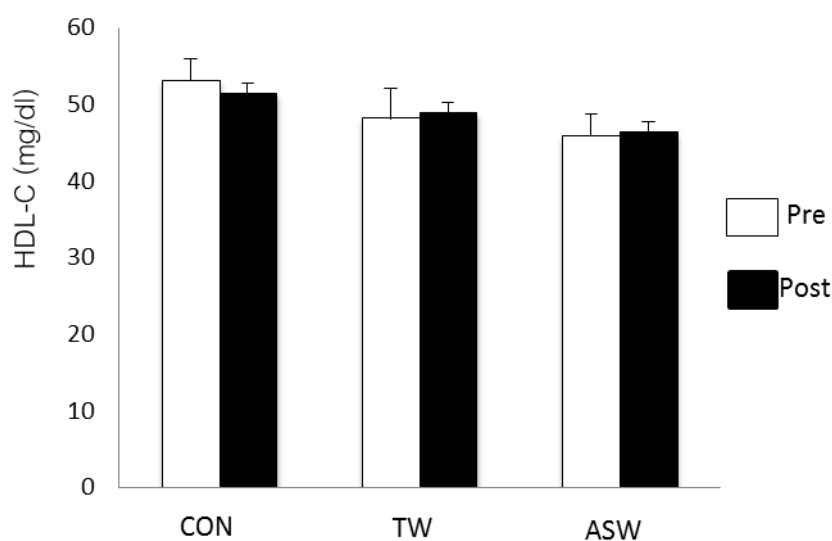

Figure 4.28 The comparison of high density lipoprotein cholesterol (mg/dl) between pre and post training in three groups: sedentary control group (CON), traditional walking exercise training group (TW) and arm swing walking incorporating Buddhist meditation exercise training group (ASW).

Data of high density lipoprotein cholesterol after training were shown in table 4.36 and figure 4.28. There were no significant difference in high density lipoprotein cholesterol of all groups when compared pre-test.

Table 4.37 The comparison of C-reactive protein (mg/l) between pre and post training in three groups: sedentary control group (CON), traditional walking exercise training group (TW) and arm swing walking incorporating Buddhist meditation exercise training group (ASW).

Group	C-reactive protein (mg/l)		t	P-value
	Pre-test	Post-test		
CON (n=13)	3.82±1.85	4.23±1.88	-2.54	0.03*
TW (n=13)	8.07±2.44	6.18±2.19	3.50	0.00*
ASW (n=14)	6.34±1.77	4.68±1.46	3.07	0.00*

Values are mean ± SEM., * $p < 0.05$ significant different from pre-test.

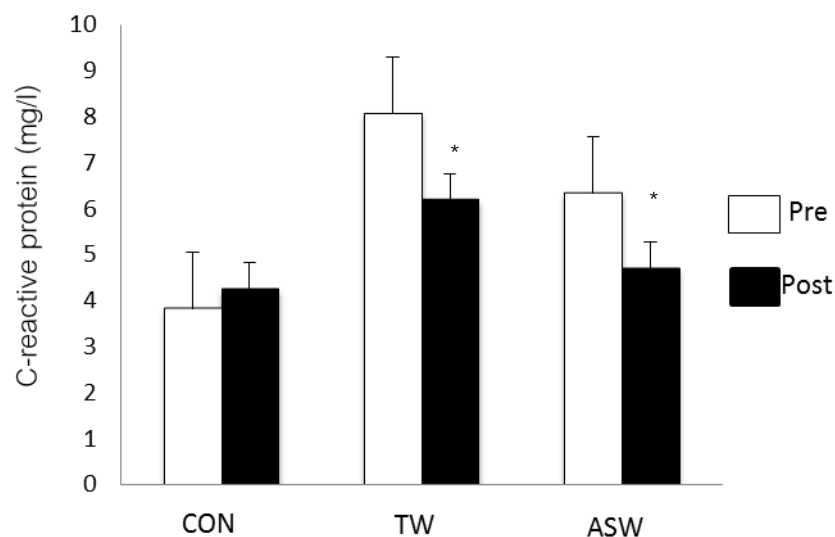

Figure 4.29 The comparison of C-reactive protein (mg/l) between pre and post training in three groups: sedentary control group (CON), traditional walking exercise training group (TW) and arm swing walking incorporating Buddhist meditation exercise training group (ASW).

Data of C-reactive protein after training were shown in table 4.37 and figure 4.29. TW and ASW groups had a significantly lower ($p < 0.05$) C-reactive protein when compared pre-test, but CON group had a significantly higher ($p < 0.05$) C-reactive protein.

Table 4.38 The comparison of nitric oxide (nmol/ml) between pre and post training in three groups: sedentary control group (CON), traditional walking exercise training group (TW) and arm swing walking incorporating Buddhist meditation exercise training group (ASW).

Group	Nitric oxide (nmol/ml)		t	P-value
	Pre-test	Post-test		
CON (n=13)	0.93±0.24	0.83±0.25	1.74	0.11
TW (n=13)	0.98±0.26	2.49±0.45	-4.03	0.00*
ASW (n=14)	0.84±0.28	2.58±0.37	-5.86	0.00*

Values are mean ± SEM., * $p < 0.05$, significant different from pre-test.

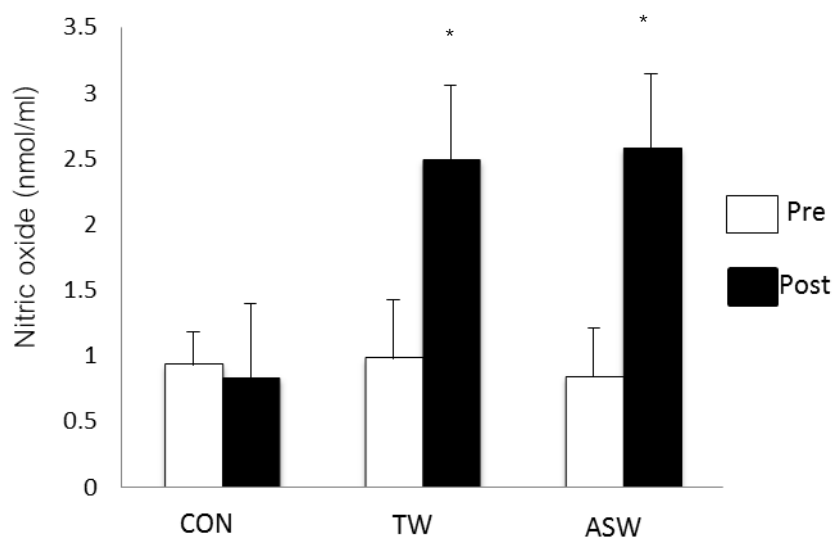

Figure 4.30 The comparison of nitric oxide (nmol/ml) between pre and post training in three groups: sedentary control group (CON), traditional walking exercise training group (TW) and arm swing walking incorporating Buddhist meditation exercise training group (ASW).

Data of nitric oxide after training were shown in table 4.38 and figure 4.30. TW and ASW groups had a significantly higher ($p < 0.05$) nitric oxide when compared pre-test. There was no significant difference in CON group.

Table 4.39 The comparison of interleukin-6 (pg/ml) between pre and post training in three groups: sedentary control group (CON), traditional walking exercise training group (TW) and arm swing walking incorporating Buddhist meditation exercise training group (ASW).

Group	Interleukin-6 (pg/ml)		t	P-value
	Pre-test	Post-test		
CON (n=13)	0.70±0.17	1.26±0.37	-1.49	0.16
TW (n=13)	0.70±0.13	1.10±0.46	-0.86	0.40
ASW (n=14)	0.92±0.21	0.73±0.21	2.48	0.03 [*]

Values are mean ± SEM., ^{*}*p*<0.05, significant different from pre-test.

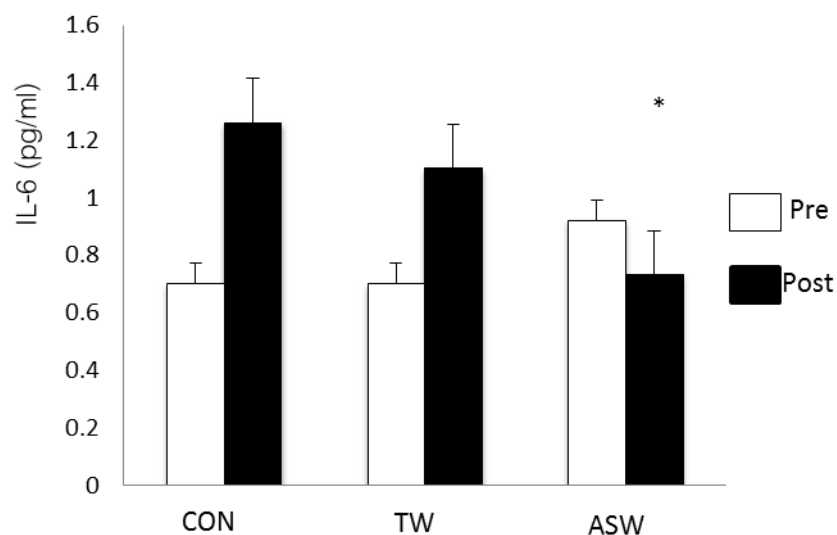

Figure 4.31 The comparison of interleukin-6 (pg/ml) between pre and post training in three groups: sedentary control group (CON), traditional walking exercise training group (TW) and arm swing walking incorporating Buddhist meditation exercise training group (ASW).

Data of interleukin-6 after training were shown in table 4.39 and figure 4.31.

ASW groups had a significantly lower (*p*<0.05) interleukin-6 when compared pre-test.

There were no significant difference in CON and TW group.

Table 4.40 The comparison of white blood cell (cells/mm³) between pre and post training in three groups: sedentary control group(CON), traditional walking exercise training group(TW) and arm swing walking incorporating Buddhist meditation exercise training group (ASW).

Group	White blood cell (cells/mm ³)		t	P-value
	Pre-test	Post-test		
CON (n=13)	6774.61±366.94	7033.85±266.31	-0.67	0.51
TW (n=13)	6400.77±321.12	6687.69±402.31	-0.92	0.37
ASW (n=14)	7361.43±495.67	7648.57±509.51	-0.56	0.58

Values are mean ± SEM.

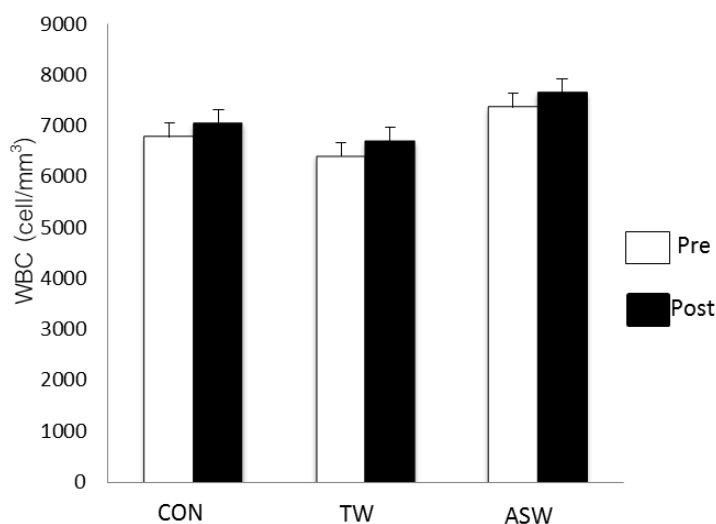

Figure 4.32 The comparison of white blood cell (cells/mm³) between pre and post training in three groups: sedentary control group (CON), traditional walking exercise training group (TW) and arm swing walking incorporating Buddhist meditation exercise training group (ASW).

Data of white blood cell after training were shown in table 4.40 and figure 4.32. There were no significant difference in white blood cell between pre and post- test in all three groups; CON group, TW group, ASW group.

Table 4.41 The comparison of red blood cell (Mcell/mm³) between pre and post training in three groups: sedentary control group (CON), traditional walking exercise training group (TW) and arm swing walking incorporating Buddhist meditation exercise training group (ASW).

Group	Red blood cell (Mcell/mm ³)		t	P-value
	Pre-test	Post-test		
CON (n=13)	4.22±0.11	4.21±0.08	0.10	0.92
TW (n=13)	4.30±0.18	4.35±0.14	-0.85	0.41
ASW (n=14)	4.37±0.16	4.33±0.16	0.79	0.44

Values are mean ± SEM.

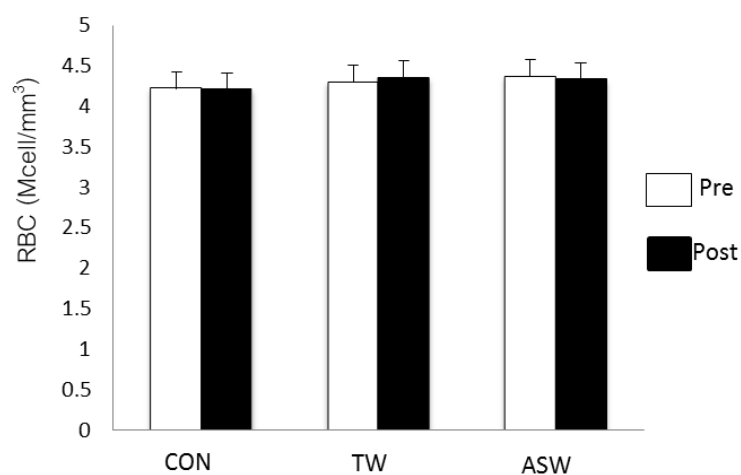

Figure 4.33 The comparison of red blood cell (Mcell/mm³) between pre and post training in three groups: sedentary control group (CON), traditional walking exercise training group (TW) and arm swing walking incorporating Buddhist meditation exercise training group (ASW).

Data of red blood cell after training were shown in table 4.41 and figure 4.33. There were no significant difference in red blood cell between pre and post- test in all three groups; CON group, TW group, ASW group.

Table 4.42 The comparison of hemoglobin (g/dl) between pre and post training in three groups: sedentary control group (CON), traditional walking exercise training group (TW) and arm swing walking incorporating Buddhist meditation exercise training group (ASW).

Group	Hemoglobin(g/dl)		t	P-value
	Pre-test	Post-test		
CON (n=13)	12.29±0.34	12.15±0.35	0.97	0.35
TW (n=13)	12.15±0.37	12.13±0.35	0.09	0.93
ASW (n=14)	12.36±0.54	13.01±0.64	3.04	0.00*

Values are mean ± SEM., * $p < 0.05$, significant different from pre-test.

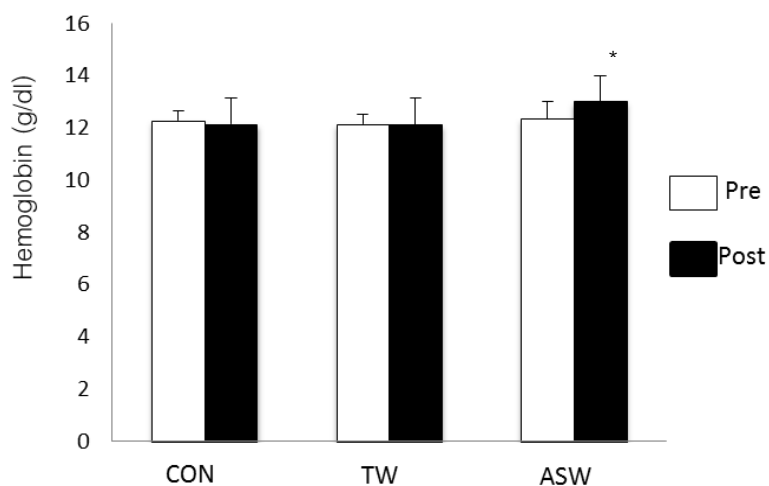

Figure 4.34 The comparison of hemoglobin (g/dl) between pre and post training in three groups: sedentary control group (CON), traditional walking exercise training group (TW) and arm swing walking incorporating Buddhist meditation exercise training group (ASW).

Data of hemoglobin after training were shown in table 4.42 and figure 4.34. ASW groups had a significantly higher ($p < 0.05$) hemoglobin when compared pre-test. There were no significant difference in CON and TW group.

Table 4.43 The comparison of hematocrit (%) between pre and post training in three groups: sedentary control group (CON), traditional walking exercise training group (TW) and arm swing walking incorporating Buddhist meditation exercise training group (ASW).

Group	Hematocrit(%)		t	P-value
	Pre-test	Post-test		
CON (n=13)	37.69±1.02	36.46±1.05	2.55	0.02*
TW (n=13)	38.15±1.17	36.84±1.03	2.56	0.02*
ASW (n=14)	37.21±1.56	38.00±1.38	-2.24	0.04*

Values are mean ± SEM., * $p < 0.05$, significant different from pre-test.

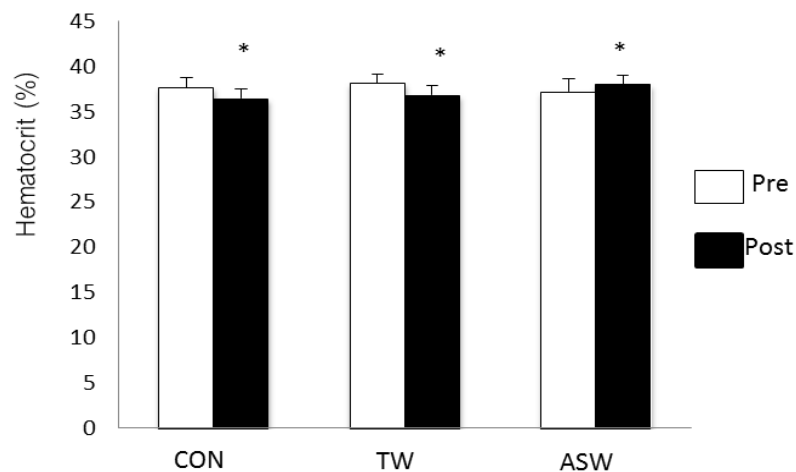

Figure 4.35 The comparison of hematocrit (%) between pre and post training in three groups: sedentary control group (CON), traditional walking exercise training group (TW) and arm swing walking incorporating Buddhist meditation exercise training group (ASW).

Data of hematocrit after training were shown in table 4.43 and figure 4.35. ASW groups had a significantly higher ($P < 0.05$) hematocrit when compared pre-test, but TW and CON groups had a significantly lower when compared pre-test.

Table 4.44 The comparison of blood chemical data in sedentary control group (CON), traditional walking exercise training group (TW) and arm swing walking incorporating Buddhist meditation exercise training group (ASW) in pre-test.

Variables	CON (n=13)	TW (n=13)	ASW (n=14)	F	P-value
Total C (mg/dl)	216.15±15.16	205.92±12.03	199.36±11.40	0.43	0.65
Triglyceride (mg/dl)	134.31±9.75	164.61±22.42	180.78±20.91	1.59	0.22
LDL-C (mg/dl)	135.38±13.03	113.69±10.10	115.07±9.34	1.23	0.30
HDL-C (mg/dl)	53.08±4.16	48.15±3.46	45.86±3.13	1.06	0.35
CRP (mg/l)	3.82±1.85	8.07±2.44	6.34±1.77	1.08	0.35
Nitric oxide(nmol/ml)	0.93±0.24	0.98±0.26	0.84±0.28	0.07	0.93
Interleukin-6 (pg/ml)	0.70±0.17	0.70±0.13	0.92±0.21	0.52	0.60
RBC(Mcell/mm ³)	4.22±0.11	4.30±0.18	4.37±0.16	0.26	0.77
Hemoglobin(g/d)	12.29±0.34	12.15±0.37	12.36±0.54	0.06	0.94
Hematocrit(%)	37.69±1.02	38.15±1.17	37.21±1.56	0.13	0.88
WBC(cell/mm ³)	6774.61±366.94	6400.77±321.12	7361.43±495.67	1.44	0.25

Values are mean ± SEM., C = cholesterol, CRP = C-reactive protein, HDL-C = High density lipoprotein Cholesterol, LDL-C = Low density lipoprotein Cholesterol

The difference of blood chemical variables among in sedentary control group (CON), traditional walking exercise training group (TW) and arm swing walking incorporating Buddhist meditation exercise training group (ASW) in pre-test were shown in table 4.44.

There were no significant difference in cholesterol, triglyceride, LDL-C, HDL-C, CRP, IL-6, hemoglobin, hematocrit, RBC, WBC and nitric oxide when compared among in CON group, TW group, ASW group.

Table 4.45 The comparison of blood chemical data in sedentary control group (CON), traditional walking exercise training group (TW) and arm swing walking incorporating Buddhist meditation exercise training group (ASW) in post-test.

Variables	CON (n=13)	TW (n=13)	ASW (n=14)	F	P-value
Total C (mg/dl)	226.77±11.95 [*]	181.61±11.47 ^{††}	180.57±9.48 ^{††}	5.73	0.00
Triglyceride (mg/dl)	145.15±12.40	130.23±16.49 [*]	131.50±18.38 [*]	0.26	0.77
LDL-C (mg/dl)	129.69±10.98	107±10.33	101.14±8.00 [*]	2.30	0.10
HDL-C (mg/dl)	51.38±2.97	48.85±3.92	46.28±2.96	0.61	0.55
CRP (mg/l)	4.23±1.88	6.18±2.19 [*]	4.68±1.46 [*]	0.29	0.74
Nitric oxide (nmol/ml)	0.83±0.25	2.49±0.45 ^{††}	2.58±0.37 ^{††}	7.10	0.00
Interleukin-6 (pg/ml)	1.26±0.37	1.10±0.46	0.73±0.21 [*]	0.61	0.55
RBC(Mcell/mm ³)	4.21±0.08	4.35±0.14	4.33±0.16	0.33	0.72
Hemoglobin(g/dl)	12.15±0.35	12.13±0.35	13.01±0.64 ^{**}	1.15	0.33
Hematocrit(%)	36.46±1.05	36.84±1.03	38.00±1.38 [*]	0.47	0.63
WBC(cell/mm ³)	7033.85±266.31	6687.69±402.31	7648.57±509.51	1.18	0.32

Values are mean ± SEM, ^{*}p<0.05 vs. Pre, [†]p<0.05 vs. Sedentary control.

C = cholesterol, CRP = C-reactive protein, HDL-C = High density lipoprotein Cholesterol, LDL-C = Low density lipoprotein Cholesterol

The difference of blood chemical variables among in sedentary control group (CON), traditional walking exercise training group (TW) and arm swing walking incorporating Buddhist meditation exercise training group (ASW) in post-test were shown in table 4.45.

TW and ASW group had a significantly lower in plasma concentration of total cholesterol and nitric oxide (all p<0.05) than CON group, and significant reductions in

LDL-cholesterol and interleukin-6 concentrations were only observed in the ASW group, but there were no significant difference in triglyceride, LDL-C, HDL-C, CRP, IL-6, hemoglobin, hematocrit, RBC, WBC when compared among in CON group, TW group, ASW group.

CHAPTER V

DISCUSSION AND CONCLUSION

The present study was carried out to determine the effects of the novel Buddhism-based walking meditation (ASW) program on physical fitness, endothelial-dependent vasodilation and depression scores. Physiological characteristics were compared pre and post exercise. The results showed that body mass, body mass index and body fat decrease slightly but significantly ($p < 0.05$), systolic blood pressure and diastolic blood pressure significantly decreased ($p < 0.05$) and maximal oxygen consumption increased ($p < 0.05$) from 22.9 to 26.1 ml/kg/min, forced vital capacity significantly increased in the ASW group, whereas in TW group there were significant decrease in systolic blood pressure ($p < 0.05$) and diastolic blood pressure ($p < 0.05$), body mass, body mass index ($p < 0.05$) but were not statistically significant in body fat and forced vital capacity. The maximal oxygen consumption significantly increased in TW group ($p < 0.05$). Body mass and body mass index significant increased in CON group ($p < 0.05$). For compared the control group, systolic blood pressure significantly decreased in ASW group ($p < 0.05$) as well as TW group ($p < 0.05$) but significantly decreased diastolic blood pressure ($p < 0.05$) and significantly increased forced vital capacity ($p < 0.05$) more than TW group. Physical fitness (arm curl, 30 second chair stand, back scratch, chair sit and reach, timed up-and-go and six-minute walk test) increased significantly in both groups. For compared CON group as a whole, the physical fitness significantly increased in arm curl, 30 second chair stand, back scratch, chair sit and reach, timed up-and-go and six-minute walk test in ASW group, whereas TW group significantly increased in back scratch, chair sit and reach, timed up-and-go and 6-minute walk test. Depression and cortisol decrease significantly in ASW group ($p < 0.05$) and decreased significantly than the TW and CON groups whereas

no change was observed in the TW group. The cortisol concentration was significantly higher in CON group ($p < 0.05$). Endothelial dependent vasodilation (resting diameter, peak diameter, flow-mediated dilatation, time to peak diameter, shear rate at resting diameter, peak shear rate) mostly improve significantly ($p < 0.05$) in ASW group whereas TW group specially increase significantly peak diameter, flow-mediated dilatation, time to peak diameter, peak shear rate ($p < 0.05$) while no change was observed in the CON group. When compare CON group, resting diameter, peak diameter, flow-mediated dilatation, shear rate at resting diameter, peak shear rate in the ASW group were significantly higher than CON group whereas peak diameter, peak shear rate significantly improved in TW group. There were significantly decreased in cholesterol, triglyceride, LDL-cholesterol, C-reactive protein, interleukin-6 and significant increased nitric oxide ($P < 0.05$) in ASW group whereas in decreased in cholesterol, triglyceride, C-reactive protein and significantly increased nitric oxide the TW group excepted LDL-cholesterol did not significantly. For compared the CON group, cholesterol significantly decreased and nitric oxide significantly increased in ASW group as well as TW group.

The salient findings of the present study is that Buddhism-based walking meditation produced improvements in physical fitness and vascular function that are similar to those induced by traditional walking exercise. More notably, the walking meditation incorporating arm swings produced a greater improvement in vascular function as well as a reduction in depression scores and plasma concentrations in cortisol and IL-6 that were not observed with the traditional walking exercise. The present results indicate that religion-based physical exercise that incorporate the mind and body interactions are effective in reducing depression and cardiovascular disease risk factors and in improving physical fitness and vascular function in elderly with depressive symptoms.

There has been a growing attention and interest in spiritual or religious matters in the management of overall health and quality of life. In the same vein, regular physical activity is a relatively well-established strategy for maintaining and enhancing health and quality of life. In the present study, Buddhism-based walking meditation was incorporated into the arm swing exercises. This particular form of mind and body exercises produced similar benefits to the traditional walking exercises. The current study is consistent with previous studies that reported beneficial effects of other mind and body exercises, including Tai chi, Korean traditional exercise (Kouk-Sun-Do), Yoga (Yeh, GY. et al., 2004; Chen, KM. et al., 2009; Lim, YM. & Hong, GRS., 2010), and Turkish folklore dance (Eyigor, S. et al., 2009). More importantly, an improvement in vascular function was greater and the decrease in depression was only observed in the spiritual exercise group. It remains to be seen if the spirituality and/or culture based exercise interventions would lead to greater compliance and adherence to the program in the long-term. Discussion is expressed in relation to the results as mentioned earlier are as followed:

The effects of arm swing walking incorporating Buddhist meditation exercise training on physiological characteristics in the elderly with depressive symptoms.

This study found that body mass and BMI decreased ($p < 0.05$) in the TW and the ASW groups. A significant decrease in body fat percentage and a significant increase forced vital capacity were only observed in the ASW group. Systolic and diastolic blood pressure decreased and maximal oxygen consumption increased in both exercise training groups (all $p < 0.05$). No significant changes were observed in the sedentary control group except that there were small but significant increases in body mass and BMI.

The regular exercise increases the ability to cope with variety of stressors. Aging is associated with significant decreases in physical activity, which in turn facilitate the

aging process. Aging is a very complex process, which affects each organ, and even each cell differently. The moderate exercise training has been proposed due to the health benefit, including an increase of physical fitness and decreased risk of obesity, cardiovascular disease and metabolic syndrome (Sato, Y. et al., 2007). In present study, exercise training program consist of gradually walking at mild (20-39%HRR) to moderate intensity (40-50 %HRR) 30-40 minutes/session, 3 times/week for 12 weeks. The training program is minimum recommended quantity and quality of exercise for improving and maintaining cardiorespiratory fitness (ACSM, 2006). It is adequate to induce physical adaptation as with increased maximum oxygen consumption ($VO_2\max$). It is well established that aerobic exercise training leads to cardiovascular, skeletal muscle, and metabolic adaptations. Cardiovascular adaptations include increased stroke volume and cardiac output, which contributes greatly to increased maximal oxygen consumption ($VO_2\max$) (Stegall, FL. et al., 2011). The greater improvement in $VO_2\max$ observed in our study may have been due to an increased stroke volume include a training induced enlargement of left ventricular chamber size, cardiac muscle hypertrophy with enhance contractility during systole and (a-v) O_2 difference improvement (Trilk, JL. et al.,2011). $VO_2\max$ are an increased ability of the cardiovascular system to transport oxygen to the working skeletal muscle, and the improved ability of the muscle to utilize the delivered oxygen. The former is a result of increased stroke volume, which improves cardiac output; the latter is determined by the increases in oxidative enzymes and mitochondrial content (Saltin, B. et al.1968). The exercise training may modulate central arterial compliance in healthy older individuals. More importantly, regular physical activity has been shown to attenuate the age-related decline in arterial compliance in healthy older men and women (McGavock, J. et al., 2004). Similarly in this study , the blood pressure is reduced by exercise training due to aerobic exercise may be responsible for reduction of total peripheral resistance. It is reduced by attenuation of sympathetic activity and an increased vagal tone. The reduction of total peripheral resistance after exercise was significantly correlated to changes in stroke volume and LV end diastolic diameter, suggesting that an afterload reduction (Hambrecht, R. et al., 2000). Several studies found that the exercise improved

specific metabolic risk factors, including body mass and body mass index and body fat (Innes KE. et al., 2005; Labbrador PM. et al., 2006; Pitsavos C. et al., 2009; Saritas N., 2012). The current study results are consistent with previous studies showed that the ASW and TW exercise can reduced, body mass, body mass index and body fat whereas the CON gained weight due to the both groups associated imbalance in caloric intake over energy expenditure according to Slentz, CA. et al. (2004) demonstrated a modest amount of exercise can prevent weight gain with no changes in diet, and more exercise may lead to important weight loss in initially overweight individuals. Then, the recommendation of U.S. Surgeon General indicated that an energy expenditure increase of 2 kcal/kg/day for changing sedentary elderly to the moderately active (Fujita, K., 2003).

The effects of arm swing walking incorporating Buddhist meditation exercise training on physical fitness in the elderly with depressive symptoms

In the present study, the result showed that muscle strength as measured by arm curl and chair stand, flexibility as assessed by back scratch and chair sit-and-reach, agility and dynamic balance on timed up-and-go, six-minute walk test all increased ($p < 0.05$) in both exercise groups. No such changes were observed in the sedentary control group. For compared CON group as a whole, the physical fitness significantly increased in arm curl, 30 second chair stand, back scratch, chair sit and reach, timed up-and-go and 6-minute walk test in ASW group, whereas TW group significantly increased in back scratch, chair sit and reach, timed up-and-go and 6-minute walk test.

An aerobic exercise combine resistance exercise, an aerobic exercise alone was greater improvement the physical fitness in the elderly (Larose, J. et al., 2010). According to this study found that aerobic combine resistance exercise in ASW exercise greater improved the muscle strength, flexibility, agility and balance in the elderly as

well as TW exercise that is an aerobic exercise. In addition to, the meditation component, ASW was different from TW in that the subjects held weights in each hand to increase upper limb workloads. Previous study demonstrated that exercise training using a flexible stick, the exercise program that simultaneously combines aerobic and resistance exercise components, showed superior improvements in health-related physical fitness and cutaneous microcirculatory responsiveness compared with Tai Chi in older women (Suksom D. et al., 2011). Consistent with this, Chen KM. et al. (2008) demonstrated that mind- body exercise improved flexibility and muscular strength. The simplified Tai-Chi Exercise Program (STEP) improved flexibility, muscular strength after practicing 6 months. According to Chen KM. et al. (2010) the silver yoga exercise program is specifically designed to accommodate the reduced body flexibility experienced by many older adults, through the progression of a sequence of static physical postures, and it used stretching to improve physical fitness.

As mentioned above, the exercise training program can improved physical fitness due to adaptations of skeletal muscle fibers were occurred in exercise training, for example, by the expression of specific contractile proteins (myosin heavy chain [MHC] isoforms) and by an increase in the activity and content of mitochondria. There is strong evidence in running mice for 6 weeks, the result indicated that six weeks of voluntary wheel running induced a significant ($p < 0.05$) fiber type IIb to IIa/x shift in triceps muscle of wild-type mice. AMP-activated protein kinase (AMPK) plays a critical role in training adaptations of skeletal muscle (Rockl, K. et. al., 2007).

The effects of arm swing walking incorporating Buddhist meditation exercise training on Endothelium-dependent vasodilation in the elderly with depressive symptoms.

The current study found that resting diameter, peak diameter, flow mediated dilatation, time to peak diameter, peak shear rate improved ($p < 0.05$) in both the ASW and TW groups. ASW group had a significantly higher in resting diameter, peak

diameter, flow mediated dilatation, shear rate at rest, peak shear rate (all $p < 0.05$) than CON group, whereas TW group had a significantly improved peak diameter ($p < 0.05$) and peak shear rate ($p < 0.05$). Then, ASW group had significantly higher resting diameter and peak diameter than TW group ($p < 0.05$).

Endothelium-dependent vasodilation as assessed by flow-mediated dilation improved ($p < 0.05$) in both the ASW and TW groups. We also found that FMD was increased by 88% in the ASW group while the TW group increased it by 72%, indicating that ASW had superior improvements in endothelial-dependent vasodilatation compared with TW.

Exercise training induces marked vascular remodeling by increasing angiogenesis and arteriogenesis. These changes associated with functional changes, physical forces such as shear stress and improved organ blood flow (Kojda, G., Hambrecht, R., 2005). The functional measure of endothelium-dependent vasodilation was associated with the increase in the biochemical measure of plasma nitric oxide level (Westhoff, TH. et al., 2008; Francescomarino, SD. et al., 2009). The potential explanation for this finding is that our exercises have beneficial effects on endothelial function via increased shear stress and blood flow results in increased NO production and the consequent vasodilation. Similarly, hatha yoga consisted various components that could potentially and beneficially influence vascular function (Cortez-Cooper M. et al., 2008). Yoga consisted of the isometric contractions in the postures and the isometric contraction has been reported to enhance endothelial function. In addition to, meditation could improve vascular function via reductions in sympathetic vasoconstrictor tone (Cooper DC. et al., 2011). On the other hand, Hunter, SD. et al. (2012) indicated hatha yoga training for 12 weeks in middle-aged and older adults is not associated with improvements in vascular functions. It is unclear for mind-body exercise effectiveness on the endothelial function. The intensity, duration of exercise is powerful factors to

endothelial function changes. According to the results of this study showed that mind-body exercise at moderate intensity for 12 weeks improved endothelial function.

Moreover, an aerobic exercise could induce shear stress. It is a potent stimulus on endothelial cells for an increase in nitric oxide production, leading to improved endothelial function and reduced vascular resistance. Then, vascular laminar shear stress increases during exercise and is associated with a rapid up regulation of endothelial nitric oxide synthase (eNOS), messenger ribonucleic acid (mRNA) and protein expression level, result in increased NO production. Moreover, different mode of exercise seem to variably affect endothelial NO production and bioactivity, 'whole body' exercise training have observed improvements in NO-mediated vasodilator capacity can be more than localized body exercise (Francescomarino, SD. et al., 2009). In present study, we demonstrated TW and ASW exercise could improve endothelial dependent vasodilation but ASW exercise is greater more than TW exercise due to ASW exercise combines aerobic exercise with meditation. Meditation component may lead to an improvement in baroreflex sensitivity and a reduction in activation and reactivity of the sympathoadrenal system and the hypothalamic pituitary adrenal axis, meditation may alleviate the effect of vascular function. (Pullen, PR. et al., 2008).

The effects of arm swing walking incorporating Buddhist meditation exercise training on depression and cortisol concentration in the elderly with depressive symptoms.

The present study indicated that depression and cortisol concentration decreased ($p < 0.05$) only in the ASW group. There were no significant difference depression scores, cortisol concentration in the TW group and CON .

Consistent with concept hypersecretion of corticotropin-releasing factor (CRF) has been previously implicated to play a role in the pathophysiology of depression ,hypothalamic-pituitary-adrenal (HPA) axis activation consequently hypercortisolaemia is a common abnormality reported in a large proportion of depressed patients (Beluche, I. et al., 2009). These can be harmful, ultimately leading to disease and other negative

health consequences such as hypertension, diabetes, cardiovascular disease, tissue damage (Otte, C. et al., 2004).

The regular exercise that can make to decrease the negative effect of depression. It is unclear for the mode of exercise affected on depression. There are many studies indicated that potential of mind-body exercise greater improved depression (Lim, YM. And Hong Son, GR., 2010). inversely, there is the study demonstrated that an aerobic exercise did not appear to be involved with depression (Kohut, ML. et al., 2006). Our the results indicated only the ASW exercise significant decreased overall depressive symptoms and decreased cortisol concentration. These results are notable for fact that mind-body exercise based on Buddhism meditation component that is focusing on awareness of sensations, thoughts, and feeling in the present moment. As note above, the depressed elderly may have specific cognitive vulnerability, including dysfunctional attitudes, meditation may have identification destructive contents and habitual patterns of the mind at an early stage, and affect to improving depressive symptoms (Chan, AS., 2012). Therefore, meditation reduced in activation and reactivity of the sympathoadrenal system, the hypothalamic pituitary adrenal axis and affecting on reduction of cortisol concentration in bloodstream (Anderson, GJ. and Taylor, AG., 2011).

In a similar study, the exercise combine with meditation had benefit on positive psychological effects such as yoga is also effective decreased depression (Lim, YM. and Hong, GR., 2010) and related to decreased cortisol concentration (Field T., 2008). Moreover, Buddhist meditation produces biochemical and physiological changes and reduces serum cortisol concentration (Sudsuang, R., Chentanez, V., Veluvan, K.,1991). Similarly, many interventions as are evidence by reduced cortisol concentration following, transcendental meditation and other Buddhist meditation practices, tai chi, progressive relaxation training and qi-training (Taylor, AG. et al., 2010).

The effects of arm swing walking incorporating Buddhist meditation exercise training on blood chemical data in the elderly with depressive symptoms.

In present study, the results showed that after training plasma concentrations of total cholesterol, triglyceride, and C-reactive protein decreased in both TW and ASW groups. Significant reductions in LDL-cholesterol, interleukin-6 concentrations were only observed in the ASW group. Nitric oxide improved significantly in both the ASW and TW groups. There were no significant difference in triglyceride, LDL-C, HDL-C, CRP, IL-6 when compared among in CON group, TW group, ASW group.

The higher total cholesterol, triglyceride and LDL-cholesterol are considered a risk factor for cardiovascular diseases. These have also been shown to be associated with impaired endothelium-dependent vasodilation. Lipoprotein is independent risk factor for coronary heart disease (CHD), stroke, and peripheral atherosclerosis (Davignon, J. and Peter Ganz, P., 2004). In previous study, small artery compliance was inversely correlated with lipoprotein levels and cause endothelial dysfunction in patients with atherosclerosis (Schillinger, M. et al., 2002).

Previous study demonstrated that exercise greatly improved lipid profile (Vinagre, CG. et al., 2007). Tai chi chuan training program significantly improves CHD risk factors; reduction total cholesterol, low density lipoprotein cholesterol in patients with dyslipidemia (Lan, C. et al., 2008). Low-moderate intensity exercise effects on up-regulated expression of LDL-receptors, increased cholesterol-transfer to HDL particles (Butcher, LR. et al., 2008) and use of cholesterol for cellular metabolism and repair due to muscle damage immediately after intense exercise (Ferguson, MA. et al., 1998). Similarly in present study, a remarkable steady drop in low density lipoprotein cholesterol and total cholesterol after 12 weeks of ASW exercise.

Nitric oxide is a pivotal endothelium-derived substance. The hallmark of endothelial dysfunction is impaired endothelium-dependent vasodilation, which is

mediated by NO. Nitric oxide is formed in endothelial cells from its precursor L-arginine via the enzymatic action of endothelial NO synthase (eNOS), which is located in caveolae (invaginations in cell membranes). The protein caveolin-1 binds to calmodulin to inhibit activity of eNOS; the binding of calcium to calmodulin displaces caveolin-1, activating eNOS and leading to production of NO. Cofactors such as tetrahydrobiopterin and nicotinamide adenine dinucleotide phosphate (NADPH) are also involved in NO production (Davignon, J. and Peter Ganz, P.,2004).

The exercise training increases endothelium-dependent vasodilation, increased vascular expression of endothelial cell (eNOS) (Kojda,G., Hambrecht, R., 2005). Our the results suggested that mind-body exercise are associated with improving endothelial function by allowing for a greater availability of NO.

As mentioned previously, depression is associated with activation of HPA. It is well established that the HPA axis activation is elicited by cytokine (IL-1,IL-6, TNF). Therefore, the hypercortisolemia observed in depressed person may have resulted from a hypersecretion of corticotropin-releasing factor (CRF) induced by pro-inflammatory cytokines such as IL-6 (Leonard, BE., 2005). C- reactive protein (CRP) is reliable marker of endothelial dysfunction and inflammation and can be used to predict the risk of future cardiovascular events. It is activated by depression (Carney, RM., Freedland, KE., Miller, GE., Jaffe, AS., 2002; O'brien et al., 2007).

Recently, aerobic exercise training has been associated with a chronic anti-inflammatory effect (Francescomarino, SD. et al., 2009). Moreover, accumulating evidence also exists that during regular, aerobic exercise, skeletal muscle fibres inhibit the production of the pro-inflammatory cytokines and produce several anti-inflammatory that may be involved in mediating the health beneficial effects of exercise. With regard to this, it has been shown that the exercise training significantly reduced IL-6 , CRP in serum of the older adults (Kohut, ML., 2006). Whereas, this study the result showed that aerobic exercise reduce CRP but no change IL-6 and depression.

Moreover, mind-body practices could enhance parasympathetic output and there by shift the autonomic nervous system balances from primarily sympathetic to parasympathetic, leading to positive changes in cardiac-vagal function, mood, energy state, and related neuroendocrine, metabolic, and inflammatory response (Taylor AG. et al., 2010). The study showed that mind-body exercise were associated with lower levels of IL-6 and other pro-inflammatory cytokines (Kiecolt-Glaser, J.K. et al., 2010). ASW exercise decreased level of marker of inflammation such as IL-6 and CRP, this result point to potential mechanism by which ASW exercise could improve endothelial function, via decreasing depressive symptoms and improving inflammation marker. Interestingly, the IL-6, CRP which markers of inflammation change significantly with 12 weeks after ASW exercise. The results of this study are notable for fact that CRP decreasing (6.34 ± 1.77 vs. 4.68 ± 1.46 mg/l) and IL-6 decreasing (0.92 ± 0.21 vs. 0.73 ± 0.21 pg/ml) were obtained in ASW group. No significant changes CRP (3.82 ± 1.85 vs. 4.23 ± 1.88 mg/l) and IL-6 (0.70 ± 0.17 vs. 1.26 ± 0.37 pg/ml) were observed in the sedentary control group.

The results suggested that traditional walking exercise and arm swing walking incorporating Buddhist meditation exercise improved physical fitness, endothelium dependent vasodilation through increasing the production of nitric oxide and decreasing C-reactive protein. However, interleukin-6, depression score and cortisol concentration in blood circulation were decreased only in arm swing walking incorporating Buddhist meditation exercise group (Figure 5.1) .

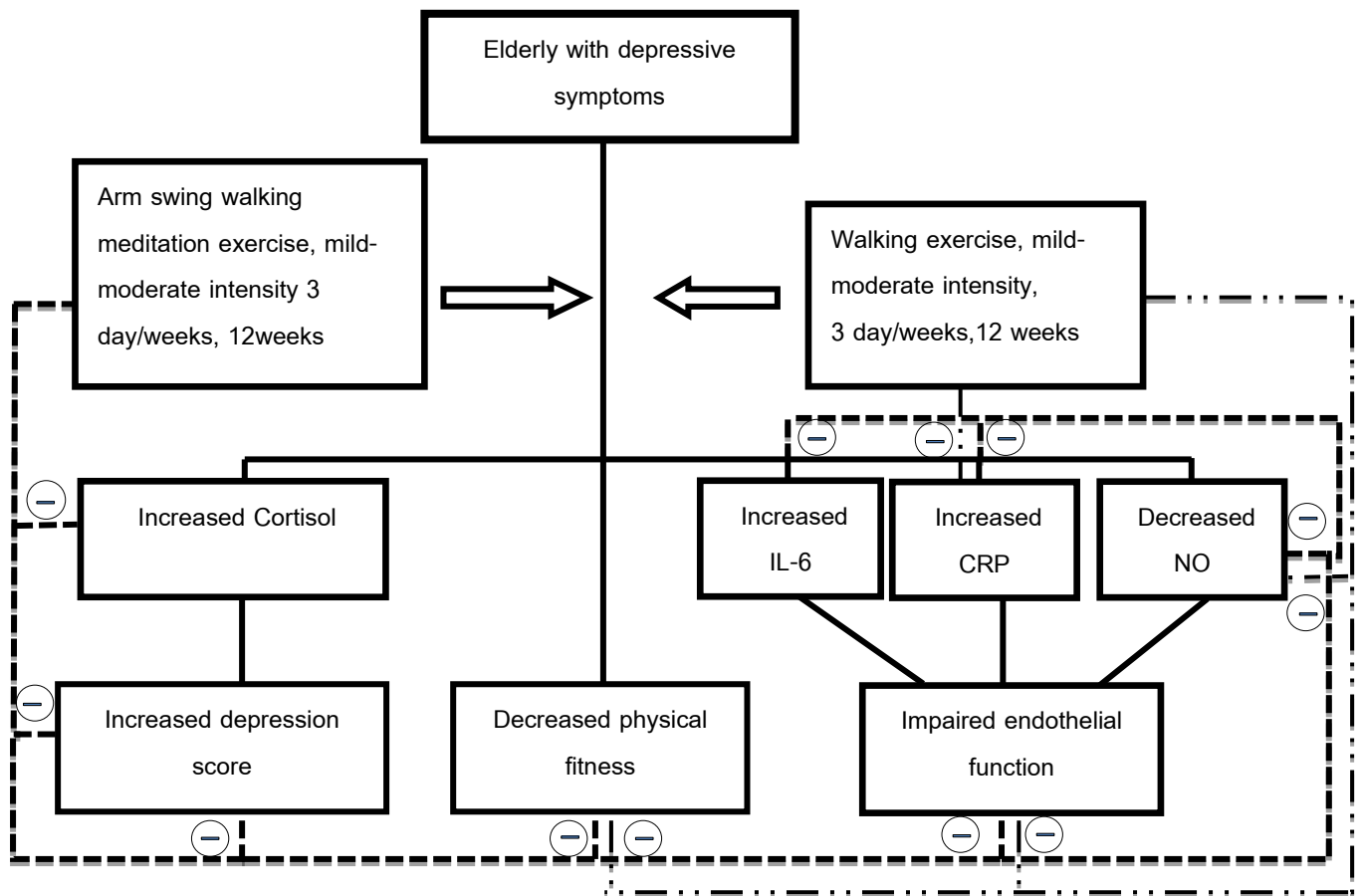

Figure 5.1 Mechanism of the effects of arm swing walking incorporating Buddhist meditation exercise and traditional walking exercise

Limitation and recommendation

One of limitations of this study was that participants were recruited from two welfare centers dwelling elderly in Thailand and were therefore not representative of all the elderly with non-severe depression. Although there are limitation on generalizing the findings, the results show the effectiveness of ASW exercise on the physical fitness, endothelial dependent vasodilation and depression of these the elderly. Another limitation was that we did not have controlling daily activity, eating pattern, social factor of elderly. Therefore, the restrictive factor might be affect to results of body composition or biochemical data in this study. However, the effectiveness of arm swing walking

incorporating meditation exercise is clearly and reliable to apply for health promotion in the elderly in community-dwelling.

Further research is also needed to determine effectiveness of ASW for other patients with physical diseases and specific settings.

Conclusion

Similar to the traditional walking exercises, the Buddhism-based walking meditation intervention that incorporated arm swing exercises was effective in improving physical fitness and vascular function. The ASW exercise was also able to decrease depression, plasma concentrations of cortisol and inflammatory markers but the traditional walking exercise failed to improve these parameters. Collectively, these results indicate that the spiritually-oriented walking meditation exercise may be the novel therapeutic modality that is suitable for improving physical and psychological functions in elderly with mild and moderate depression symptoms.

REFERENCES

- Anderson, JG. And Taylor, AG. The metabolic syndrome and mind-body therapies : A systematic review. Journal of nutrition and metabolism. 2011. 2011 (1) : 1-8.
- Andrade, L. and Carraveo, A. Epidemiology of major depressive episodes : results from the international consortium of psychiatric epidemiology(ICPE) surveys. International journal of methods in psychiatric research. 2003. 12(1) : 3-21.
- Andrel, AM., Fraguas, R., Telles, RM., Alves, T.C., Strunz, CM. et al. Major depressive disorder and inflammatory markers in elderly patients with heart failure. Psychosomatics. 2007. 48(4) : 319-324.
- Apostolakis, S., Vogiatzi K., Krambovitis E., Spandidos DA. IL-1 cytokines in cardiovascular disease: diagnostic, prognostic and therapeutic implications. Cardiovascular and hematological agents in medicinal chemistry. 2008. 6(2) : 150–158.
- Aronow, WS., Heart disease and aging. Medical clinics of north America. 2006. 90(5) : 849-862.
- Barua, A., Ghosh, M.K., Kar, N.& Basilio, M.A. Prevalence of depressive disorders in the elderly. Annals Saudi Medicine. 2011. 31(6) :1-10.
- Baune ,BT., Smith, E., Reppermund, S., Air, T., Samaras, K., Lux, O., Brodaty, H., Sachdev, P., Trollor, JN. Inflammatory biomarkers predict depressive, but not anxiety symptoms during aging: the prospective Sydney Memory and Aging Study. Psychoneuroendocrinology. 2012. 37(9) : 1521-1530.
- Beluche, I., Chaudieu, I., Norton , J., Carrire , I., Boulenger, JP., Ritchie, K., Ancelin, ML. Persistence of abnormal cortisol levels in elderly persons after recovery from major depression. Journal of Psychiatric Research. 2009. 43 : 777-783.

- Berry, K., Barrowclough, C., Wearden, A. Attachment theory: A framework for understanding symptoms and interpersonal relationships in psychosis. Behaviour research and therapy. 2008. 46 : 1275-1282.
- Brink, TL., Yesavage, JA., Lum, O. et al. Screening tests for geriatric depression. Clinical Gerontologist. 1982. 1 : 37-44.
- Burke, WJ., Roccaforte, WH., Wengel, SP. et al. The reliability and validity of the Geriatric Depression Rating Scale administered by telephone. Journal of the American geriatrics society. 1995. 43 : 674-679.
- Burr, JF., Bredin, SS., Faktor, MD., Warburton, DE. The 6-minute walk test as a predictor of objectively measured aerobic fitness in healthy working-aged adults. Physician sportsmedicine. 2011. 39(2) : 133-139.
- Butcher, LR., Thomas, A., Back, K. Low-intensity exercise exerts beneficial effects on plasma lipids via PPARgamma. Medicine & science in sports & exercise. 2008. 40 : 1263-1270.
- Ferguson, MA. Alderson, NL., Trost , SG. Effects of four different single exercise sessions on lipids, lipoproteins, and lipoprotein lipase. Journal of applied physiology. 1998. 85 :1169-1174.
- Carney, RM., Freedland, KE, Miller, GE., Jaffe, AS. Depression as a risk factor for cardiac mortality and morbidity: A review of potential mechanisms. Journal of psychosomatic research. 2002. 53 : 897-902.
- Carroll, BJ., Fielding, JM., Blashk, TG. Depression rating scales: a critical review. Archives of general psychiatry. 1973. 28 : 361-366.
- Caterina, R.D., Libby, P., Gimbrone, M.A. Endothelial Dysfunctions and Vascular Disease. Australia : Blackwell Publishing. 2007.
- Celermajer, DS. Reliable Endothelial Function Testing. Circulation. 2008. 117: 2428-2430.

- Chahal, HS. and Drake, WM. The endocrine system and ageing. Journal of Pathology. 2007. 211 : 173-180.
- Chan, AS., Wong, QY., Sze, SL., Kwong, PP., Han, YM., Cheung, MC. A Chinese Chan-base mind-body intervention for patient with depression. Journal of affective disorders. 2012. 142 : 283-289.
- Chen, KM., Chen, MH., Chao, HC., Hung, HM., Lin, HS., Li, CH. Sleep quality, depression state, and health status of older adults after silver yoga exercise: cluster randomized trial. International journal of nursing studies. 2009. 46 : 154-163.
- Chen, KM., Fan, JT., Wang, HH., Wu, SJ., Li, CH., Lin, HS. Silver yoga exercises Improved physical fitness of transitional frail elders. Nursing Research. 2010. 59(5) : 364-570.
- Chen, KM., Lin, JN., Lin, HS., Wu, HC., Chen, WT., Li, CH., Kai, Lo S. The effects of a Simplified Tai-Chi Exercise Program (STEP) on the physical health of older adults living in long-term care facilities: a single group design with multiple time points. International journal of nursing studies. 2008. 45(4) : 501-507.
- Chen, H., Yiu, KH., Tse ,HF. Relationships between vascular dysfunction, circulating endothelial progenitor cells, and psychological status in healthy subjects. Depress anxiety. 2011. 28(8) : 719-727.
- Clayton, AH., Holroyd, S., Sheldon-Keller, A. Geriatric Depression Scale vs Hamilton Rating Scale for Depression in a sample of anxiety patients. Clinical gerontologist . 1997. 17 : 3-13.
- Cohen, J. Statistical power analysis for the behavioral sciences, pp. 16-18. New York : Lawrence Erlbaum associates publishers. 1988.

- Cooper, DC., Tomfohr, LM., Milic, MS., Natarajan, L., Bardwell, WA., Ziegler, MG., Dimsdale, JE. Depressed mood and flow-mediated dilation: a systematic review and meta-analysis. Psychosomatic medicine. 2011. 73(5) : 360-369.
- Cortez-Cooper, M., Anton M., Devan A., Neidre D., Cook J., Tanaka H. The effect of strength training on central arterial compliance in middle-aged and older adults. European journal of cardiovascular prevention & rehabilitation. 2008. 15 : 149-155.
- Corretti, MC., Anderson, TJ., Benjamin, EJ., Celermajer, D., Creage, MA., Deanfield, J, Drexler, H., Herman, MG., Herrington, D., Vallance, P., Vita, J., Vogel, R. Guidelines for the ultrasound assessment of endothelial-dependent flow-mediated vasodilation of the brachial artery: A report of the International Brachial Artery Reactivity Task Force. Journal of the American college of cardiology. 2002. 39(2) : 257-265.
- Csiszar, A., Pacher, P., Kaley, G., Ungvari, Z. Role of oxidative and nitrosative stress, longevity genes and poly(ADP-ribose) polymerase in cardiovascular dysfunction associated with aging. Current vascular pharmacology. 2005.3 : 285–291.
- Csiszar, A., Toth, J., Peti-Peterdi, J., Ungvari, Z. The aging kidney: role of endothelial oxidative stress and inflammation. Acta physiologica hungarica. 2007. 94 :107–115.
- Davignon, J. and Peter Ganz, P. Atherosclerosis: Evolving Vascular Biology and Clinical Implications. Circulation. 2004. 109 : 27-32.
- Department of Mental Health. Disaster of depression : Aback news of Thais suicide – a person an hour. Bangkok. Department of Mental Health , 2006. (Mimeographed)
- Dhindsa, M., Sommelad, SM., DeVan, AE., Barnes, JN., Sugawara, J., Ley, O., Tanaka H. Interrelationships among noninvasive measures of postischemic macro- and microvascular reactivity. Journal of applied physiology. 2008. 105(2) : 427-438.

- Djernes, JK. Prevalence and predictors of depression in populations of elderly: a review. Acta psychiatrica scandinavica. 2006. 113(5) : 372-387.
- Dobrosielski, D. A., Greenway, F. L., Welsh, D. A., Jazwinski, S. M., Welsch , M.A. Modification of Vascular Function after Handgrip Exercise Training in 73- to 90-yr-Old Men. Medicine & science in sports & exercise. 2009. 41(7) : 1429-1435.
- Donato, A. J., Pierce, G. L., Lesniewski, L.A., Seals, D.R., Herrera, M. D. Role of NF κ B in age-related vascular endothelial dysfunction in humans. AGING. 2009. 1(8) : 678-680.
- Doutreleau, S., Marco, PD., Talha, S., Charloux, A. Can the six-minute walk test predict peak oxygen uptake in men with heart transplant?. Archives of physical medicine and rehabilitation. 2009. 90 : 51-57.
- Erusalimsky, J.D., Skene, C. Mechanisms of endothelial senescence. Experimental physiology. 2009. 94 : 299–304.
- Eyigor, S., Karapolat, H., Durmaz , B., Ibissoglu, U., Cakir, S. A randomized controlled trial of Turkish folklore dance on the physical performance, balance, depression and quality of life in older women. Archives of gerontology and geriatrics. 2009. 49:84-88.
- Field, T. Yoga clinical research review. Complementary therapies in clinical practice. 2008. 17 : 1-8.
- Francescomarino, SD., Sciatilli, A., Valerio, VD., Baldassarre, AD., Gallina, S. The effect of physical exercise on endothelial function. Sports Medicine. 2009. 39(10) : 797-812.

- Fujita, K., Nagatomi, R., Hozawa, A., Ohkubo, T., Sato, K., Anzai, Y., Sauvaget, C., Watanabe, Y., Tamagawa, A., Tsuji, I. Effects of exercise training on physical activity in older people: a randomized controlled trial. Journal of epidemiology. 2003. 13(2) : 120-126.
- Gordon, NF., Gulanick, M., Costa, F., Fletcher, G., Franklin, BA., Roth, EJ., Shephard, T. Physical activity and exercise recommendations for stroke survivors: an American Heart Association scientific statement From the Council on Clinical Cardiology Subcommittee on Exercise, Cardiac Rehabilitation, and Metabolism; and the Stroke Council. Circulation. 2004.109 : 2031-2041.
- Hambrecht, R., Gielen, S Linke, A., Fiehn, E., Yu, J., Walther, C., Schoene, N., Schuler, G. Effects of exercise training on left ventricular function and peripheral resistance in patients with chronic heart failure : A Randomized Trial. Journal of the American medical association. 2000. 283(23) : 3095-3101.
- Haendeler, J., Hoffmann, J., Brandes, R.P., Zeiher, A.M., Dimmeler, S., Hydrogen peroxide triggers nuclear export of telomerase reverse transcriptase via Src kinase family-dependent phosphorylation of tyrosine. Molecular and cellular biology. 2003. 23 : 4598–4610.
- Hamilton, M. A rating scale for depression. Journal of Neurology, neurosurgery and psychiatry. 1960. 23 : 56-62.
- Health care committee. Exercise and older person : series on clinical management. Australia : Common wealth. 2004.
- Holroyd, S. and Clayton, AH. Measuring Depression in the Elderly: Which Scale is Best?. Medscape general medicine. 2000. 2(4) :1-4.
- Innes, KE., Bourguignon, C., Taylor, AG. Risk indices associated with the insulin resistance syndrome, cardiovascular disease, and possible protection with yoga: a systematic review. Journal of the American board of family Practice. 2005. 18(6) : 491-519.

- Javnbakh, M., Kenari, R.H., Ghasemi, M. Effects of yoga on depression and anxiety of women. Complementary therapies in clinical practice. 2009. 15 : 102–104.
- Jone, C.J. and Rikli, R.E. Measuring functional fitness of older adults. The journal active aging. 2002. March April : 24-30.
- Joseph, L. & Izzo, Jr. Aging and systolic hypertension : cluster patterns and problem-solving strategies to answer the genetic riddle. Hypertension. 2001. 37 : 1067-1068.
- Justine, M., Hamid, T. A., Mohan, V., Jagannathan , M. Effects of multicomponent exercise training on physical functioning among institutionalized elderly. International scholarly research network . 2012. 1-7.
- Jylha, P., Melartin,T., Isometsa, E. Relationships of neuroticism and extraversion with axis I and II comorbidity among patients with DSM-IV major depressive disorder. Journal of affective disorders. 2009.114 : 110-121.
- Kanungsukkasem, V., Somprayon, S., Sutthiwan, P. A comparative of jogging meditation concerning physical fitness and mental health. Research, Chulalongkorn university, 1991.
- Kessler, R.C., Berglund, P., Demler, O. The epidemiology of major depressive disorder: results from the national comorbidity survey replication (NCS-R). Journal of the American medical association. 2003. 289 (203) : 3095–3105.
- Kiecolt-Glaser, JK., Christian, L., Preston, H., Houts, C., Malarkey, WC., Emery, CF., and Glaser, R. Stress, inflammation, and yoga Practice. Psychosomatic medicine. 2010. 72(2) : 113-123.
- Knodel, J. and Chayowan, N. Population ageing and the well being of older persons in Thailand : Past trends, current situation and future challenges. Bangkok : UNEPA. 2008.

- Kojda, G., Hambrecht, R. Molecular mechanisms of vascular adaptations to exercise. Physical activity as an effective antioxidant therapy?. Cardiovascular research. 2005. 67: 187-197.
- Kohut, ML., McCann, DA., Russell, DW., Konopka, DN., Cunnick, JE, Franke, WD., Castillo, MC, Reighard, AE., Vanderah, E. Aerobic exercise, but not flexibility/resistance exercise, reduces serum IL-18, CRP, and IL-6 independent of β -blockers, BMI, and psychosocial factors in older adults. Brain, behavior, and immunity. 2006. 20 : 201-209.
- Kostic, R., Uzunovic, S., Pantelic, S., Duraškovic, R. A comparative analysis of indicators of the functional fitness of the elderly. Physical education and sport. 2008. 9(2) : 161-171.
- Krishnamurti, J. Freedom from the know, pp. 24-30. New York : Harper Collins Publishers. 1969.
- Kurosu, H., Yamamoto, M., Clark, J.D., Pastor, J.V. , Nandi, A., Guamani, P., Mcguinness, O.P., Chikuda, H., Yamaguchi, M., Kawaguchi, H., Shimomura, L., Takayama, Y., Herz, J., Kahn, C.R., Rosenblatt, K.P., Kuro-o, M. Suppression of aging in mice by the hormone Klotho. Science, 2005. 309 : 1829 -1833.
- Labrador, MP., Polk, D., Dwyer, JH et al. Effect of a randomized controlled trial of transcendental meditation on components of the metabolic syndrome in subjects with coronary heart disease. Archives of internal medicine. 2006. 166(11) : 1218-1224.
- Lan, C., Su, TC., Chen, SY., Lai JS. Effect of T'ai chi chuan training on cardiovascular risk factors in dyslipidemic patients. Journal of alternative and complementary medicine. 2008. 14(7) : 813-819.

- Larose, J., Sigal, R.J., Boulé, N.G., Wells, G.A., Prud'homme, D., Fortier, M.S., Reid, R.D., Tulloch, H., Coyle, D., Phillips, P., Jennings, A., Khandwala, F., Kenny, G.P. Effect of exercise training on physical fitness in type II diabetes mellitus. Medicine & science in sports & exercise. 2010. 42(8) : 1439-1447.
- Lata, H. & Alia, L.W. Ageing: physiological aspects. JK science. 2007 . 9(3) : 111-115.
- Leonard, B.E. The HPA and immune axes in stress: the involvement of the serotonergic system. European psychiatry. 2005. 20 : 302-306.
- Lim, Y.M., Hong, G.R.S. Effect of 16-week Kouk-Sun-Do exercise on physical fitness, emotional state, and immunoglobulin A in community-dwelling elders in Korea. Applied nursing research. 2010(21) : 91-100.
- Lobo, A., Saz, P., Marcos, G., DÍa, J.L., De-la-Cámara, C. The prevalence of dementia and depression in the elderly community in a southern European population: The Zaragoza study. Archives of general psychiatry. 1995. 52(6) : 497-506.
- Logsdon, R.G., Teri L. Depression in Alzheimer's disease patients: Caregivers as surrogate reporters. Journal of the American geriatrics society. 1995. 43:150-155.
- Luangpor Teen. To one that feels. Bangkok : Supa printing Co., 2005.
- Maes, M. Depression is an inflammatory disease, but cell-mediated immune activation is the key component of depression. Neuro-psychopharmacology & biological psychiatry. 2010. DOI:10.1016/j.pnpbp.2010.06.014.
- Mae, M., Ruckoanich, P., Chang, Y.S., Mahanonda, N, Berk, M. Multiple aberrant in shared inflammatory and oxidative & nitrosative stress (IO&NS) pathways explain the co-association of depression and cardiovascular disorder (CVD) and increased risk for CVD and due mortality in depressed patients. Progress neuro-psychopharmacol biological psychiatry. 2010. 35 : 769-783.

- Mandell, L A., Wunderink, RG., Anzueto, A., Bartlett, GJ., Campbell, GD., Dean, NC., Dowell, SF., File TM., Musher DM, Niederman MS., Torres A., . Whitney CG. (2007). Infectious diseases society of America/American thoracic society consensus guidelines on the management of community-acquired pneumonia in adults. Clinical infectious disease. 44 (Suppl 2) : S27-S72 .
- Madamanchi, N.R., Runge, M.S. Mitochondrial dysfunction in atherosclerosis. Circulation research. 2007.100 : 460–473.
- Marchand, W.R. Mindfulness-based stress reduction, mindfulness-based cognitive therapy, and Zen meditation for depression, anxiety, pain, and psychological distress. Journal of psychiatric practice. 2012. 18(4) : 233-252.
- Matousek, RH., Dobkin, P.L., Pruessner, J. Cortisol as a marker for improvement in mindfulness-based stress reduction. Complementary therapies in clinical practice. 2010. 16 : 13-19.
- Mauritz, M. and Meijel, B.V. Loss and grief in patients with schizophrenia: On living in another world. Archives of psychiatric nursing. 2009.17 : 1-10.
- McGavock, J., Mandic, S., Lewanczuk, R., Koller, M., Muhll, IV., Quinney, A.Taylor, D.,Welsh, R. and Haykowsky, M. Cardiovascular adaptations to exercise training in postmenopausal women with type 2 diabetes mellitus. Cardiovascular diabetology. 2004. 3 : 1-7.
- Mellédo, JM., Mahil, N., Baker, GB. Nitric oxide: A key player in the relation between cardiovascular disease and major depressive disorder?. Journal of psychiatry and neuroscience. 2004. 29(6) : 414-416.
- Metkus, TS, Kenneth, Jr, Baughman, L, Thompson, PD. Exercise prescription and primary prevention of cardiovascular disease. Circulation. 2010 :121:2601-2604.
- Minamino, T., Komuro, I. Vascular cell senescence: contribution to atherosclerosis. Circulation research. 2007. 100 :15–26.

Ministry of public health and ministry of social development and human security.

The 5th ASEAN & Japan high Level officials meeting on caring Society: collaboration of social welfare and health services, and development of human resources and community - community services for the elderly. 2007. Country report Thailand.

Mondimore, F.M. Depression :The mood disease. USA : Johns hopkins University press. 2006.

Montgomery, SA, Asberg, M. A new depression scale designed to be sensitive to change. British journal of psychiatry. 1979. 134 : 382-389.

Naidu, OA. Rajasekhar, D, Latheef, SAA. Assessment of endothelial function by brachial artery flow mediated dilatation in microvascular disease. Cardiovascular ultrasound. 2011. 40(9) : 3-5.

National Institute for Health and Clinical Excellence. *Depression (amended):* Management of depression in primary and secondary care. London: MidCity Place. 2007.

Newaz, M.A., Yousefipour, Z., Oyekan, A. Oxidative stress-associated vascular aging is xanthine oxidase-dependent but not NAD(P)H oxidase-dependent. Journal of cardiovascular pharmacology. 2006. 48 : 88–94.

O'Brien, SM., Scully, P., Fitzgerald, P., Scott, LV., Dinan, TG. Plasma cytokine profiles in depressed patients who fail to respond to selective serotonin reuptake inhibitor therapy. Journal of psychiatric research. 2007. 41 : 326-331.

Orapun Thongtang. Research on development of the manual for self detection of depression in the Thai elderly. Journal of the medical association of Thailand. 2002. 85(5) : 540-544.

Orimo, H., Kamiya, N. Redefining the concept of elderly for successful aging society. Nihon Rinsho. 2008. 66(8):1605-1614.

Otte, C., Marmar, CR., Pipkin, SS, Moos, R, Browner, WS, Whooley, MA.

Depression and 24-hour urinary cortisol in medical outpatients with coronary heart disease: The Heart and Soul Study. Biological psychiatry. 2004. 56 : 241-247.

Outdo, A., Martin, C., Busseuil, D., Vergely, C., Demaison, L., Rochette, L. NADPH oxidases are in part responsible for increased cardiovascular superoxide production during aging. Free radical biology and medicine. 2006. 40 : 2214–2222.

Park, K.E., Pepine, C.J. Pathophysiologic mechanisms linking impaired cardiovascular health and neurologic dysfunction:the year in review. Cleveland clinic journal of medicine. 2010. 77(3) : S40-S45.

Parker, G, Hyett, M., Walsh, W., Owen, C., Brotchie, H., and Hadzi-Pavlovic, D. Specificity of depression following an acute coronary syndrome to an adverse outcome extends over five years. Psychiatry Research. 2011. 185 : 347-352.

Paz-Filho, G., Licinio, J., Wong, ML. Pathophysiological basis of cardiovascular disease And depression: a chicken-and-egg dilemma. Revista Brasileira de Psiquiatria. 2010. 32(2) :181-191.

Pedersen, D.D. Psych Note, pp. 10-15. Pennsylvania : Davis company. 2005.

Pitsavos, C., Pannagiotakos, D.B., Tambalis, K.D. , Chrysohoou, C., Sidossos, L.S., Skoumas, J., Stefanadis, C. Resistance exercise plus to aerobic activities is associated with better lipids' profile among healthy individuals: the ATTICA study. Quarterly journal of medicine. 2009.102 : 609–616.

Pyke, K.E., Hartnett, J.A., Tschakovsky, M.E. Are the dynamic response characteristics of brachial artery flow-mediated dilation sensitive to the magnitude of increase in shear stimulus?. Journal of applied physiology. 2008.105 : 282-292.

- Raft, D., Spencer, RF., Toomey, T. et al. Depression in medical outpatients: use of the Zung scale. Diseases of the nervous system (United States).1977. 38 : 999-1004.
- Reddi, A.H. Aging, osteoarthritis and transforming growth factor- β signaling in Cartilage. Arthritis research & therapy. 2006. 8(1) :101-110.
- Rockl, K., Hirshman, M., Brandauer, J., Fujii, N.,Witters, L.A. , Goodyear, L.J. Skeletal muscle adaptation to exercise training AMP-Activated Protein Kinase Mediates Muscle Fiber Type Shift. Diabetes. 2007. 56 (8) : 2062-2069.
- Roshanaei-Moghaddam, B., Katon, WJ., and Russo, J. The longitudinal effects of depression on physical activity. General hospital psychiatry. 2009. 31(4) : 306-315.
- Saltin, B., Blomqvist, G., Mitchell, J. H., Johnson R., Wildenthal, K. and Chapman, C. A longitudinal study of adaptive changes in oxygen transport and body composition. Circulation. 1968. 38 (7) : 1–78.
- Saritas, N.Effect of endurance exercise training on blood lipids in young Men. African journal of pharmacy and pharmacology. 2012. 6(3) : 216-220.
- Sato, Y., Nagasaki, M., Kubota, M., Uno, T., Nakai, N. Clinical aspects of physical exercise for diabetes/metabolic syndrome. Diabetes research and clinical practice. 2007. 77(1) : 87-91.
- Schillinger, M., Mlekusch, W., Haumer, M., et al. Relation of small artery compliance and lipoprotein(a) in patients with atherosclerosis. American journal of hypertension. 2002. 15: 980–985.
- Sharma, G. & Goodwin, J. Effect of aging on respiratory system physiology and immunology. Clinical interventions in aging. 2006. 1(3) : 253-260.
- Sherwood, A., Hinderliter, AL., Watkins, LL., Waugh, RA., Blumental GA. Impaired endothelial function in coronary heart disease patients with depressive symptomatology. Journal of the American college of cardiology. 2005. 46(4) : 656-659.

- Sivasankaran, S., Quintner, S.P., Sachdeva, R., Pugeda, J., Hoq, S.M., Zarich, S.W. (2006). The Effect of a Six-Week Program of Yoga and Meditation on Brachial Artery Reactivity: Do Psychosocial Interventions Affect Vascular Tone? Clinical cardiology. 29, 393–398.
- Skala, J.A., Freedland, K.E., Carney, R.M. Coronary heart disease and depression: a review of recent mechanistic research. Canadian journal of psychiatry. 2006. 51(12) : 738-745.
- Slentz, C.A., Duscha, B.D., Johnson, J.L., Ketchum, K., Aiken, L.B., Samsa, G.P., Houmard, J.A., Connie, W., Kraus, W.E. Effects of the amount of exercise on body weight, body composition, and measures of central obesity STRRIDE—A Randomized Controlled Study. Archives of internal medicine. 2004. 164(1) : 31-39.
- Stegall, L.F., Cleave, E.M., Ding, Z., Phillip, G., Doerner, P.G., Liu, Y., Wang, B., Healy, M., Kleinert, M., Dessard, B., Lassiter, D.G., Kammer, L., Ivy, J.L. Aerobic exercise training adaptations are increased by postexercise carbohydrate-protein supplementation. Journal of nutrition and metabolism. 2011. 2011 : 1-11.
- Sudsuang, R., Chentanez, V., Veluvan, K. Effect of Buddhist meditation on serum Cortisol and total protein levels, blood pressure, pulse rate, lung volume and reaction time. Physiology & Behavior. 1991. 50(3) : 543-548.
- Suksom, D., Siripatt, A., Lapo, P., Patumraj, S. Effects of two modes of exercise on physical fitness and endothelial Function in the Elderly: Exercise with a flexible stick versus tai chi. Journal of the medical association of Thailand. 2011. 94 : 123-132.
- Sutichai Jitapunkul and Suvinee Wivatvanit. National policies and programs for the aging population in Thailand. Ageing international. 2009. 33 : 62–74.
- Symond, S. and Anderson, I. Unipolar depression and dysthymia. Psychiatric disorders . 2012. 40(11) : 591-595.

- Taylor, AG., Goehler, LE., Galper, DI., Innes, KE., Bourguignon, C. Top-down and bottom-up mechanism in mind-body medicine: development of an integrative framework for psychophysiological research. Explore. 2010. 6(1) : 29-41.
- Tekur, P., Nagarathna, R., Chametcha, S., Hankey, A., Nagendra, HR. A comprehensive yoga programs improves pain, anxiety and depression in chronic low back pain patients more than exercise: an RCT. Complement Therapies Medicine. 2012. 20(3) :107-118.
- Thomas , AJ., Davis , S., Morris, C., Jackson, E., Harrson, R., O'Brien, JT. Increase in interleukin-I beta in late life depression. American journal of psychiatry. 2005.162 : 175-177.
- Train The Brain Forum Committee. Thai Geriatric Depression Scale; TGDS. Siriraj Hospital Gaz. 1994. 46:1-9.
- United Nations Population Found. Population ageing in Thailand :prognosis and policy response, pp. 1-15. Bangkok: UNEP. 2006.
- Vinagre, CG., Ficker, ES., Finazzo, C. Enhanced removal from the plasma of LDL-like nanoemulsion cholesteryl ester in trained men compared with sedentary healthy men. Journal of applied physiology. 2007. 103 :1166-1171.
- Vink, D., Aartsen, M and Schoevers, RA. Risk factors for anxiety and depression in the elderly: A review. Journal of affective disorders. 2008. 106 : 29-44.
- Vorasetawut, T. and Suksom, D. The effect of running meditation training on health related physical fitness and the side effects of menstruation in women with premenstrual syndrome and dysmenorrhea. Journal of exercise & sport science. 2010. 6 (1) : 1-10.

- Vreeburg, SA., Hoogendijk, WJ., Van Pelt J., Derijk, RH, Verhagen, JC, Dyck, R., Smit, JH., Zitman, FG., Penninx, BW. Major depressive disorder and hypothalamic-pituitary-adrenal axis activity: results from a large cohort study. Archives of general psychiatry. 2009. 66(6):617-626.
- Waltis, JP., Davies, KN., Bunn, WK. Correlation between Hospital Anxiety Depression (HAD) scale and other measures of anxiety and depression in geriatric inpatients. International journal of geriatric psychiatry. 1993. 9 : 61-63.
- Weinstein, AA., Deuster, PA, Francis, JL, Bonsall, RW, Tracy, RP., Kop, RP. Neurohormonal and inflammatory hyper-responsiveness to acute mental stress in depression. Biological psychology. 2010. 84(2) : 228-234.
- Westhoff, TH., Schmidt, S., Gross, V., Joppke, M., Zidek, W., Vander, M., Dimeo, F. The cardiovascular effects of upper-limb aerobic exercise in hypertensive patients. Journal hypertension. 2008. 26(7) : 1-8.
- Wickremaratchi, M. & Llewelyn, JG. Effects of ageing on touch. Postgraduate Medical Journal, 2006. 82(967) : 301-304.
- Yeh, GY., Wood, MJ., Lorell, BH., Stevenson, LW., Eisenberg, DM., Wayne, PM., Goldberger, AL., Davis, RB., Phillips, RS. Effects of Tai chi Mind-body movement therapy on functional status and exercise capacity in patients with chronic heart failure: a randomized controlled trial. American journal of medicine. 2004. 117 : 541-548.
- Yesavage, JA., Brink, TL., Rose, TL., Lum, O., Huang, V., Adey, MB, and Leirer, VO. Development and validation of a geriatric depression screening scale: A preliminary report. Journal of psychiatric research. 1983. 17 : 37-49.

Yeung, A., Lepoutre, V., Wayne, P., Yeh, G., Slipp, LE., Fava, M., Denninger, JW, Benson, H., Fricchione, GL. Tai chi treatment for depression in Chinese Americans: a pilot study. American journal of physical medicine & rehabilitation. 2012. 91(10) : 863-870.

Yulug, B., Ozan, E.,Gonul, A.S., Kilic, E. Brain-derived neurotrophic factor, stress and depression: A minireview. Brain research bulletin. 2009. 78 : 267-269.

Zung, WW. A self-rating depression scale. Archives of general psychiatry. 1965. 12 : 63-70.

Zung, WWK. The Measurement of depression, pp. 12-18. Columbus : Ohio Merrill.1975.

APPENDICES

APPENDIX A

Certificate approved by the Ethical Review Committee for Research Involving
Human Research Subjects at Chulalongkorn University

APPENDIX A

Certificate approved by the Ethical Review Committee for Research Involving
Human Research Subjects at Chulalongkorn University

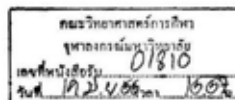

บันทึกข้อความ

ส่วนงาน คณะกรรมการพิจารณาจริยธรรมการวิจัยในคน กลุ่มสหสถาบัน ชุดที่ 1 โทร.0-2218-8147

ที่ จว>61/55

วันที่ 14 มิถุนายน 2555

เรื่อง แจ้งผลการพิจารณาจริยธรรมการวิจัย

เรียน คณะบดีคณะวิทยาศาสตร์การกีฬา

- สิ่งที่ส่งมาด้วย
1. ใบรับรองผลการพิจารณา
 2. เอกสารข้อมูลสำหรับผู้มีส่วนร่วมในการวิจัย
 3. ใบยินยอม
 4. แบบสอบถาม

ตามที่ นางสุชาวี ประคินกิจ นิสิตระดับคุณวุฒิปริญญาตรี คณะวิทยาศาสตร์การกีฬา จุฬาลงกรณ์มหาวิทยาลัย ได้เสนอโครงการวิจัยที่ 047.1/55 เรื่อง ผลของโปรแกรมการออกกำลังกายกลางแจ้งแบบวงแขนสมาธิตามวิถีพุทธต่อการขยายหลอดเลือดค่านการทำงานของเซลล์เยื่อผนังหลอดเลือดและสมรรถภาพทางกายในผู้สูงอายุที่มีภาวะซึมเศร้า (EFFECTS OF ARM SWING WALKING INCORPORATE WITH BUDDHIST MEDITATION EXERCISE PROGRAM ON ENDOTHELIAL DEPENDENT VASODILATION AND PHYSICAL FITNESS IN ELDERLY WITH DEPRESSION) เพื่อให้กรรมการผู้ทบทวนหลักพิจารณาจริยธรรมการวิจัยความละเอียดแจ้งแล้วนั้น

การนี้ กรรมการผู้ทบทวนหลัก ได้เห็นสมควรให้ผ่านการพิจารณาจริยธรรมการวิจัยได้
รับรองวันที่ 12 มิถุนายน 2555

จึงเรียนมาเพื่อโปรดทราบ

(ผู้ช่วยศาสตราจารย์ ดร.นันทรี ชัยชนะวงศาโรจน์)

กรรมการและเลขานุการ

คณะกรรมการพิจารณาจริยธรรมการวิจัยในคน
กลุ่มสหสถาบัน ชุดที่ 1 จุฬาลงกรณ์มหาวิทยาลัย

อนุมัติ (บันทึกข้อความ) (ประธานคณะกรรมการ)

เพื่อโปรด

ทราบและดำเนินการต่อไป

ติดตามผล

ออกรายงาน

อื่นๆ

ลงชื่อ

19/6/55

19/6/55
นันทรี ชัยชนะวงศาโรจน์
อ. นันทรี ชัยชนะวงศาโรจน์ & นันทรี ชัยชนะวงศาโรจน์

19/6/55

19/6/55



คณะกรรมการพิจารณาจริยธรรมการวิจัยในคน กลุ่มสหสถาบัน ชุดที่ 1 จุฬาลงกรณ์มหาวิทยาลัย
อาคารตึก 2 ชั้น 4 ซอยจุฬาลงกรณ์ 62 ถนนพญาไท เขตปทุมวัน กรุงเทพฯ 10330
โทรศัพท์: 0-2218-8147 โทรสาร: 0-2218-8147 E-mail: eccu@chula.ac.th

COA No. 092/2555

ใบรับรองโครงการวิจัย

โครงการวิจัยที่ 047.1/55 : ผลของโปรแกรมการออกกำลังกายกลางแจ้งบนแกนสมมติตามวิธีพุทธต่อการ
ขยายหลอดเลือดผ่านการทำงานของเซลล์เยื่อผนังหลอดเลือดและ
สมรรถภาพทางกายในผู้สูงอายุที่มีภาวะซึมเศร้า

ผู้วิจัยหลัก : นางสุสารี ประคินกิจ

หน่วยงาน : คณะวิทยาศาสตร์การกีฬา จุฬาลงกรณ์มหาวิทยาลัย

คณะกรรมการพิจารณาจริยธรรมการวิจัยในคน กลุ่มสหสถาบัน ชุดที่ 1 จุฬาลงกรณ์มหาวิทยาลัย
ได้พิจารณา โดยใช้หลัก ของ The International Conference on Harmonization – Good Clinical Practice
(ICH-GCP) อนุมัติให้ดำเนินการศึกษาวิจัยเรื่องดังกล่าวได้

ลงนาม.....*[Signature]*
(รองศาสตราจารย์ นายแพทย์ปริศา ทักนประคินิจ)

ประธาน

ลงนาม.....*[Signature]*
(ผู้ช่วยศาสตราจารย์ ดร.นันทรี ชัยชนะวงศาโรจน์)

กรรมการและเลขานุการ

วันที่รับรอง : 12 มิถุนายน 2555

วันหมดอายุ : 11 มิถุนายน 2556

เอกสารที่คณะกรรมการรับรอง

- 1) โครงการวิจัย
- 2) ข้อมูลสำหรับกลุ่มประชากรหรือผู้มีส่วนร่วม ในการวิจัยและ ใบยินยอมของกลุ่มประชากรหรือผู้มีส่วนร่วมในการวิจัย
- 3) ผู้วิจัย
- 4) แบบสอบถาม



เลขที่โครงการวิจัย 047.1/55
วันที่รับรอง 12 มิ.ย. 2555
วันหมดอายุ 11 มิ.ย. 2556

เงื่อนไข

1. ข้าพเจ้ารับทราบว่าเป็นการพิจารณาจริยธรรม หากดำเนินการเก็บข้อมูลการวิจัยก่อนได้รับการอนุมัติจากคณะกรรมการพิจารณาจริยธรรมการวิจัยฯ
2. หากใบรับรองโครงการวิจัยหมดอายุ การดำเนินการวิจัยต้องยุติ เมื่อต้องการต่ออายุต้องขออนุมัติใหม่ล่วงหน้าไม่ต่ำกว่า 1 เดือน หรือส่งรายงานความก้าวหน้าการวิจัย
3. ต้องดำเนินการวิจัยตามที่ระบุไว้ในโครงการวิจัยอย่างเคร่งครัด
4. ให้เอกสารข้อมูลสำหรับกลุ่มประชากรหรือผู้มีส่วนร่วมในการวิจัย ใบยินยอมของกลุ่มประชากรหรือผู้มีส่วนร่วมในการวิจัย และเอกสารเชิญเข้าร่วมวิจัย (ถ้ามี) เฉพาะที่ประทับตราคณะกรรมการเท่านั้น
5. หากเกิดเหตุการณ์ไม่พึงประสงค์ร้ายแรงในสถานที่เก็บข้อมูลหรือข้อมูลจากคณะกรรมการ ต้องรายงานคณะกรรมการภายใน 5 วันทำการ
6. หากมีการเปลี่ยนแปลงการดำเนินการวิจัย ให้ส่งคณะกรรมการพิจารณาจริยธรรมรับรองก่อนดำเนินการ
7. โครงการวิจัยไม่เกิน 1 ปี ส่งแบบรายงานสิ้นสุดโครงการวิจัย (AF 03-12) และบทคัดย่อผลการวิจัยภายใน 30 วัน เมื่อโครงการวิจัยเสร็จสิ้น สำหรับโครงการวิจัยที่เป็นวิทยานิพนธ์ให้ส่งบทคัดย่อผลการวิจัย ภายใน 30 วัน เมื่อโครงการวิจัยเสร็จสิ้น

APPENDIX B

Information sheet for research participant

Information sheet for research participant

AF 04-07

ข้อมูลสำหรับกลุ่มประชากรหรือผู้มีส่วนร่วมในการวิจัย

ชื่อโครงการวิจัย ผลของโปรแกรมการออกกำลังกายกลางแจ้งบนสมรรถภาพทางกายของผู้สูงอายุ

เลือกผ่านการทำงานของเซลล์เยื่อหุ้มเซลล์และสมรรถภาพทางกายในผู้สูงอายุที่มีภาวะซึมเศร้า

ชื่อผู้วิจัย นาง สุตารี ประคินกิจ ตำแหน่ง นิสิตหลักสูตรวิทยาศาสตรบัณฑิต

สถานที่ติดต่อผู้วิจัย (ที่ทำงาน) คณะพยาบาลศาสตร์ มหาวิทยาลัยสยาม 235 ถนนเพชรเกษม

แขวงบางหว้า เขตภาษีเจริญ กรุงเทพฯ 10160

(ที่บ้าน) 29 อ.ราชพฤกษ์ แขวงบุคคโล เขตธนบุรี กทม. 10600

โทรศัพท์ (ที่ทำงาน) 02-4570068 ต่อ 5216,5203

โทรศัพท์มือถือ 085-8219229 E-mail : tik.susaree@gmail.com



044.1/55
72 ส.ย. 2555
11 ส.ย. 2556

1. **ขอเรียนเชิญ** ท่านเข้าร่วมในการวิจัยก่อนที่ท่านจะตัดสินใจเข้าร่วมในการวิจัย มีความจำเป็นที่ท่านควรทำความเข้าใจว่างานวิจัยนี้ทำเพราะเหตุใด และเกี่ยวข้องกับอะไร กรุณาใช้เวลาในการอ่านข้อมูลต่อไปนี้อย่างละเอียดรอบคอบ และสอบถามข้อมูลเพิ่มเติมหรือข้อมูลที่ ไม่ชัดเจน ได้ตลอดเวลา

2. โครงการนี้เกี่ยวข้องกับงานวิจัยด้านการสร้างเสริมสุขภาพในผู้สูงอายุที่มีภาวะซึมเศร้าโดยมุ่งสร้างโปรแกรมการออกกำลังกายกลางแจ้งบนสมรรถภาพทางกายของผู้สูงอายุที่มีผลต่อการทำงานของเซลล์เยื่อหุ้มเซลล์และสมรรถภาพทางกาย และภาวะซึมเศร้า

3. วัตถุประสงค์ของการวิจัย

เพื่อสร้างโปรแกรมการออกกำลังกายกลางแจ้งบนสมรรถภาพทางกายและศึกษาผลที่มีต่อการทำงานของเซลล์เยื่อหุ้มเซลล์ ระดับไซโตไคน์ สมรรถภาพทางกาย และภาวะซึมเศร้าในผู้สูงอายุที่มีภาวะซึมเศร้า

4. รายละเอียดของกลุ่มประชากรหรือผู้มีส่วนร่วมในการวิจัย

ผู้สูงอายุที่มีอายุ 60-75 ปี อาศัยอยู่ที่ศูนย์พัฒนาจิตสวดิการสังคมผู้สูงอายุ บ้านบางแค ที่มีภาวะซึมเศร้าในระดับเล็กน้อยถึงปานกลาง โดยคัดกรองเบื้องต้นจากการประเมินด้วยแบบประเมินภาวะซึมเศร้า ซึ่งเป็นแบบประเมินมาตรฐานสำหรับประเมินภาวะซึมเศร้าในผู้สูงอายุและได้รับการตรวจสอบจากผู้ทรงคุณวุฒิในประเทศไทย มีความเชื่อมั่นในระดับสูง

เกณฑ์ในการคัดเลือก (Inclusion criteria)

1. ผู้สูงอายุที่มีอายุ 60-75 ปี มีภาวะซึมเศร้าในระดับเล็กน้อยถึงปานกลาง
2. สามารถเคลื่อนไหวร่างกายได้ตามปกติและปฏิบัติตามกิจวัตรประจำวัน ได้ด้วยตนเอง
3. ระดับความดันโลหิต ไม่เกิน 140 / 90 mmHg และ ไม่มีประวัติการเจ็บป่วยด้วย โรคความดันโลหิตสูงวิกฤติ

เกณฑ์ในการคัดเลือก (Exclusion criteria)

4. ไม่มีประวัติการเจ็บป่วยเป็นโรคทางจิตเวช และไม่เคยได้รับการรักษาทางจิตเวชมาก่อน
5. มีสติสัมปชัญญะ สามารถพูดคุย สื่อสารได้เข้าใจ
6. ไม่อยู่ในระหว่างการเข้าร่วมวิจัยอื่น
7. สนใจในการเข้าร่วมวิจัย และยินดียินยอมในใบยินยอมเข้าร่วมการวิจัย

เกณฑ์ในการคัดออก (Exclusion criteria)

1. ไม่สมัครใจในการเข้าร่วมการวิจัยต่อ
2. ขาดการออกกำลังกายมากกว่า 7 ครั้งจากการออกกำลังกายทั้งหมด 36 ครั้ง
3. เกิดเหตุสุดวิสัยที่ทำให้ไม่สามารถเข้าร่วมการวิจัยต่อไปได้ เช่น เกิดการบาดเจ็บจากอุบัติเหตุ มีอาการเจ็บป่วย เป็นต้น

เมื่อได้ผู้เข้าร่วมวิจัยครบจำนวน 54 คน ใช้ระดับคะแนนภาวะซึมเศร้าแบ่งกลุ่มเป็นกลุ่มที่มีภาวะซึมเศร้าระดับเล็กน้อย กลุ่มที่มีภาวะซึมเศร้าระดับปานกลางและทำการสุ่มตัวอย่างแบบง่าย จากกลุ่มประชากรโดยวิธีการจับสลาก แบ่งกลุ่มตัวอย่างออกเป็น 3 กลุ่ม กลุ่มละ 18 คน ในแต่ละกลุ่มจะมีกิจกรรมการออกกำลังกายดังนี้

กลุ่มที่ 1 คำนึงชีวิตประจำวันตามปกติ

กลุ่มที่ 2 ออกกำลังกายแบบแอโรบิกโดยการเดิน ในช่วงระยะเวลา 1-6 สัปดาห์

กำหนดความหนักที่ระดับเบา ทำการฝึกเป็นเวลา 20 นาที จะเพิ่มความหนักการออกกำลังกายเป็นระดับปานกลางในสัปดาห์ที่ 7-12 โดยเพิ่มระยะเวลาเป็น 30 นาทีในระยะทาง 30 เมตรนับจำนวนรอบที่กลุ่มตัวอย่างเดินได้ในระยะเวลาที่กำหนด คำนวณหาอัตราเร็วในการเดิน ขณะทำการฝึกให้กลุ่มตัวอย่างคิดเครื่องแสดงอัตราการเดินของหัวใจ ทำการอบอุ่นร่างกาย และยืดเหยียดกล้ามเนื้อ ประมาณ 10 นาที ทำการผ่อนคลาย เป็นเวลา 10 นาที ทำการฝึก 3 ครั้งต่อสัปดาห์ เป็นระยะเวลา 3 เดือน ที่ศูนย์พัฒนาจิตสวัสดิการสังคมผู้สูงอายุบ้านบางแค โดยมีผู้วิจัย ผู้ช่วยวิจัย และเจ้าหน้าที่คอยให้การดูแลอย่างใกล้ชิด

กลุ่มที่ 3 ออกกำลังกายเดินแกว่งแขนสมาธิ ในช่วงระยะเวลา 1-6 สัปดาห์ จะกำหนดความหนักที่ระดับเบา ทำการฝึกเป็นเวลา 20 นาที และปรับเพิ่มขึ้นจนถึงปานกลางในสัปดาห์ที่ 7-12 โดยการเพิ่มงานขณะแกว่งแขน ให้ถือของที่มีน้ำหนักข้างละ 500 กรัม และระยะเวลาเป็น 30 นาที ขณะทำการฝึกให้กลุ่มตัวอย่างคิดเครื่องแสดงอัตราการเดินของหัวใจ ทำการอบอุ่นร่างกาย และยืดเหยียดกล้ามเนื้อ ประมาณ 10 นาที และให้เดินด้วยความเร็วในการเดิน 2-3 กิโลเมตรต่อชั่วโมง แกว่งแขนที่อัตราเร็ว 108 ครั้งต่อนาที ควบคุมความเร็วการแกว่งแขนด้วยเครื่องควบคุมจังหวะ กำหนดจุดให้ผู้ที่การแกว่งแขนแปลงเสียงขณะแกว่งแขนขึ้น "พุทธ" แปลงเสียง "โธ" ขณะแกว่งแขนลงและหลักแขนไปข้างหลัง เดินเป็นวงรีเพื่อความต่อเนื่องของสมาธิ หลังจากนั้นทำการผ่อนคลาย เป็นเวลา 10 นาที ทำการฝึก 3 ครั้งต่อสัปดาห์ เป็นระยะเวลา 3 เดือน ที่ศูนย์พัฒนาจิตสวัสดิการสังคมผู้สูงอายุบ้านบางแค โดยมีผู้วิจัย ผู้ช่วยวิจัย และเจ้าหน้าที่คอยให้การดูแลอย่างใกล้ชิด

เหตุผลที่ได้รับเชิญเข้าร่วมโครงการวิจัย เนื่องจากผู้สูงอายุเป็นบุคคลที่ควรได้รับการสร้างเสริมสุขภาพกายและจิตให้แข็งแรงอย่างต่อเนื่อง เพื่อป้องกันการเกิดโรคทางกายและทางจิต อีกทั้งยังทำให้คุณภาพชีวิตดีขึ้น

5. กระบวนการวิจัยที่กระทำต่อกลุ่มประชากรหรือผู้มีส่วนร่วมในการวิจัย

ผู้วิจัยทำการประเมินความพร้อมก่อนการออกกำลังกาย ประวัติสุขภาพทั่วไป วัดความดันโลหิต การเดินของหัวใจขณะพัก ทดสอบสมรรถภาพทางกาย โดยการวัดองค์ประกอบของร่างกาย วัดความแข็งแรงของกล้ามเนื้อแขน และถ้าตัวส่วนบน ทดสอบการงอข้อศอก โดยให้ผู้เข้าร่วมวิจัยนั่งบนเก้าอี้ที่เลื่อนน้ำหนักปล่อยข้างลำตัว ทำการงอข้อศอกในลักษณะหงายมือขึ้น ผู้ชายให้ถือน้ำหนัก 8 ปอนด์ (3.63



วันที่โครงการวิจัย 047.1/55 2/3
วันที่รับผล 12 มิ.ย. 2555
วันที่พิมพ์ 11 มิ.ย. 2556

กิโลกรัม) ผู้หญิงน้ำหนัก 5 ปอนด์(2.27 กิโลกรัม) โดยให้ทำมากที่สุดเท่าที่ทำได้ ผู้วิจัยจะนับจำนวนครั้งใน 30 วินาที วัดความแข็งแรงของกล้ามเนื้อขา โดยผู้เข้าร่วมวิจัยนั่งเก้าอี้แขนขาไขว้กับตรงกลางหน้าอก เมื่อเริ่มให้ผู้สูงอายุลุกขึ้นยืนและกลับมานั่งลง ภายในเวลา 30 วินาที นับจำนวนครั้งที่ทำได้ วัดความอ่อนตัวของร่างกายส่วนบน โดยให้ผู้เข้าร่วมวิจัยยืนให้วางมือที่ถนัดอยู่ด้านบนศีรษะฝ่ามืออยู่บริเวณกลางหลัง หลังจากนั้นให้วางมืออีกข้างอ้อมมาทางด้านหลังพร้อมทั้งหงายฝ่ามือขึ้น เอื้อมมือขึ้นมาตรงบริเวณกลางหลังเพื่อมาแตะกัน วัดระยะห่างระหว่างมือทั้งสองข้าง วัดความอ่อนตัวของร่างกายส่วนล่าง โดยให้ผู้เข้าร่วมวิจัยนั่งบริเวณขอบเก้าอี้ขาข้างหนึ่งงอเท้าวางราบกับพื้น ขาอีกข้างหนึ่งเหยียดออกให้มากที่สุดวางส้นเท้าติดกับพื้นปลายเท้ากระดกขึ้น 90 องศา ให้เอื้อมมือไปแตะที่ปลายเท้าโดยใช้นิ้วกลางเอื้อมไปแตะ ให้ค้างการเอื้อมแตะไว้ 2 วินาที วัดระยะทางจากปลายนิ้วกลางถึงปลายนิ้วเท้า วัดการทรงตัวและความคล่องแคล่วขณะเคลื่อนไหว โดยให้ผู้เข้าร่วมวิจัยนั่งเก้าอี้หลังตรงเท้าวางราบ วางกรวยห่างจากเก้าอี้ 3 เมตร ให้สัญญาณให้ผู้เข้าร่วมวิจัยลุกขึ้นจากเก้าอี้ แล้วยืนไปอ้อมกรวยด้วยความเร็วที่มากที่สุดเท่าที่ทำได้ และกลับมานั่งที่เก้าอี้ จับเวลาตั้งแต่ลุกขึ้นจากเก้าอี้จนถึงกลับมานั่งที่เก้าอี้ วัดสมรรถภาพการใช้ออกซิเจนสูงสุด ด้วยวิธี การเดิน 6 นาที กำหนดระยะทางที่ใช้ทดสอบ 50 เมตร ทำทางเดินเป็นรูปสี่เหลี่ยมผืนผ้า ทำเครื่องหมายแบ่งระยะทางทุก 5 เมตร จับเวลา ภายใน 6 นาที วัดระยะทางที่เดินได้ และผู้วิจัยจะนำมาคำนวณสมรรถภาพการใช้ออกซิเจนสูงสุด ปอด (Lung function) ทดสอบโดยการวัดความจุปอด ปริมาตรลมหายใจออก โดยใช้ สปไปโรมิเตอร์ มีหน่วยเป็นลูกบาศก์เซนติเมตร ซึ่งในการทดสอบสมรรถภาพทางกายของผู้วิจัยและผู้ช่วยวิจัยจะเป็นผู้ทำการทดสอบ

การทำงานของเซลล์เยื่อปมถุงหลอดเลือด วัดโดยให้ผู้เข้าร่วมวิจัยนอนหงาย พันผ้าสำลีรอบแขนก่อนใช้แถบผ้ายึดของเครื่องวัดความดันโลหิตบริเวณแขนท่อนล่างเพื่อป้องกันการปวดแขนขณะบีบแรงดัน บีบแรงดันในเครื่องวัดความดันโลหิตเท่ากับความดันซิสโตลิก เพิ่มอีก 50 mmHg ค้างไว้ 5 นาที ทำจุดรั่วระดับหลอดเลือดแดงตรงตำแหน่งแขน วัดขนาดเส้นผ่าศูนย์กลางของหลอดเลือดในนาทีที่ 1 หลังปล่อยแรงดัน และนาทีที่ 15 ในการทดสอบการทำงานของเซลล์เยื่อปมถุงหลอดเลือดผู้วิจัยจะเป็นผู้ทำการทดสอบเอง ภายใต้การดูแลของอาจารย์ที่ปรึกษาที่ได้ผ่านการอบรมเป็นผู้เชี่ยวชาญด้านการทำจุดรั่วระดับ

วิเคราะห์หาระดับไขมันในเลือด ไชโคไลน์ คอรัลซอล และไนตริกออกไซด์ โดยผู้วิจัยซึ่งเป็นพยาบาลวิชาชีพ จะเป็นผู้เจาะเลือด ของผู้เข้าร่วมวิจัย ปริมาณ 2 ซ้อมา ส่งศูนย์ตรวจวิเคราะห์

เมื่อการตรวจเสร็จสิ้น จะดำเนินการใส่โปรแกรมการออกกำลังกายตามกลุ่ม โดยผู้วิจัยจะขึ้นแจ้งรายละเอียดขั้นตอนการออกกำลังกาย และทำการฝึกออกกำลังกายเป็นระยะเวลา 3 วัน เมื่อผู้เข้าร่วมวิจัยเข้าใจถึงขั้นตอนการออกกำลังกายและสามารถปฏิบัติได้ จะดำเนินการออกกำลังกายสัปดาห์ละ 3 วัน ละ 40-50 นาที เป็นระยะเวลา 12 สัปดาห์ ภายหลังจากออกกำลังกายครบตามโปรแกรม จะทำการประเมินสมรรถภาพทางกาย การทำงานของเซลล์เยื่อปมถุงหลอดเลือด วิเคราะห์หาระดับไขมันในเลือด ไชโคไลน์ คอรัลซอล ไนตริกออกไซด์ และประเมินภาวะซึมเศร้าอีกครั้ง

ระยะเวลาตลอดโครงการ แบ่งเป็นช่วงเวลาก่อนการทดสอบก่อนใส่โปรแกรม 2 วัน หลังใส่

โปรแกรม 2 วัน ระยะเวลาการออกกำลังกาย สัปดาห์ละ 3 ครั้ง เป็นระยะเวลา 3 เดือน ครั้งละ 40 นาที

เมื่อเสร็จสิ้นการวิจัยแล้วข้อมูลที่เกี่ยวข้องกับผู้เข้าร่วมการวิจัยจะถูกทำลาย เลือกจะถูกทำลาย



ศูนย์วิจัย
วันที่รับเรื่อง 047-1/55 3/3
12 ธ.ค. 2555
11 ธ.ค. 2556
วันที่ส่งเรื่อง

โดยผู้เชี่ยวชาญทางเทคนิคการแพทย์

6. กระบวนการให้ข้อมูลแก่กลุ่มประชากรหรือผู้มีส่วนร่วมในการวิจัย

ผู้วิจัยจะเป็นผู้อธิบายให้ผู้เข้าร่วมการวิจัยทราบถึงวัตถุประสงค์ ขั้นตอนที่เกี่ยวข้องกับผู้เข้าร่วมวิจัย รวมทั้งเหตุผลที่ได้เชิญเข้าร่วมวิจัยครั้งนี้ และเปิดโอกาสให้ซักถามข้อสงสัยได้ภายหลังจากอธิบายรายละเอียด ในกรณีที่ผู้เข้าร่วมวิจัยไม่สามารถอ่านข้อมูลรายละเอียดเกี่ยวกับการวิจัยได้ ผู้วิจัยจะเป็นผู้อ่านรายละเอียดทั้งหมดให้ผู้เข้าร่วมวิจัยรับฟังก่อนลงนามยินยอมการเข้าร่วมการวิจัย หากไม่สามารถเขียนได้ ให้ผู้เข้าร่วมการวิจัยพิมพ์ลายนิ้วมือ นิ้วใดนิ้วหนึ่ง ข้างใดข้างหนึ่ง (ผู้วิจัยระบุไว้ว่าเป็นนิ้วใด มือข้างใด หลังพิมพ์ลายนิ้วมือเสร็จสิ้น) ต่อหน้าพยานอีก 2 คน

7. ในการคัดกรองผู้มีส่วนร่วมในการวิจัยด้วยวิธีใดๆ ก็ตาม หากพบว่าผู้ใดไม่อยู่ในเกณฑ์คัดเข้าได้แก่ ผู้สูงอายุที่มีภาวะซึมเศร้าในระดับที่รุนแรง และผู้สูงอายุที่มีภาวะซึมเศร้าระดับเล็กน้อยถึงปานกลางที่ไม่สมัครใจเข้าร่วมการวิจัย ผู้วิจัยจะรายงานแก่พยาบาล เจ้าหน้าที่ในศูนย์พัฒนาจิตสวัสดิการ สังคมผู้สูงอายุ บ้านบางแค เพื่อให้การดูแลช่วยเหลือ และส่งต่อแก่จิตแพทย์ต่อไป

8. อันตรายหรือความเสี่ยงที่อาจเกิดขึ้นแก่กลุ่มประชากรหรือผู้มีส่วนร่วมในการวิจัย

การวิจัยครั้งนี้ ไม่ก่อให้เกิดความแปรปรวนทางจิตที่รุนแรงขึ้น เพราะมีเจ้าหน้าที่ในศูนย์พัฒนาจิตสวัสดิการสังคมผู้สูงอายุ บ้านบางแค คอยดูแลอย่างใกล้ชิด ในเรื่องความปลอดภัยทั้งในขณะออกกำลังกายและไม่ได้ออกกำลังกาย ในช่วงแรกอาจทำให้เกิดอาการปวดเมื่อยกล้ามเนื้อ ได้ ซึ่งเป็นอาการปกติของผู้ที่เริ่มออกกำลังกาย ผู้เข้าร่วมวิจัยจึงควรเข้าร่วม โปรแกรมการออกกำลังกายอย่างสม่ำเสมอ และไม่ควรกังวลกับอาการดังกล่าวที่เกิดขึ้น หากพบว่ามีอาการบาดเจ็บเกิดขึ้นทั้งในขณะทดสอบและขณะออกกำลังกาย กลุ่มตัวอย่างจะต้องรีบแจ้งผู้วิจัยทราบทันที ผู้วิจัยจะรับผิดชอบในการส่งต่อ ณ สถานพยาบาลและค่าใช้จ่ายที่เกิดขึ้นจากการดูแลรักษา และหากผู้เข้าร่วมการวิจัยได้รับความผิดปกติเนื่องจากการเข้าร่วมการวิจัย และแพทย์ผู้เชี่ยวชาญพิสูจน์ได้ว่าเป็นผลจากการเข้าร่วมวิจัย ผู้เข้าร่วมการวิจัยจะได้รับการคุ้มครองตามกฎหมาย และรับการรักษานอกกว่าจะหาย ผู้วิจัยจะแจ้งต่อคณะกรรมการวิจัยและเพื่อความปลอดภัยของผู้เข้าร่วมการวิจัย

9. ประโยชน์ในการเข้าร่วมวิจัย ผู้เข้าร่วมการวิจัยจะได้รับประโยชน์จากการเข้าร่วมวิจัย ดังนี้ ได้รับการคัดกรองภาวะสุขภาพทั้งสุขภาพกายและสุขภาพจิตเบื้องต้น อีกทั้งยังได้รับ โปรแกรมการออกกำลังกายที่มีความเหมาะสมกับผู้เข้าร่วมวิจัย ตลอดจนนำสู่การเสริมสุขภาพกายและจิตใจให้แข็งแรง เกิดองค์ความรู้ใหม่ได้โปรแกรมการออกกำลังกายที่เหมาะสมและนำไปใช้ได้จริงในศูนย์พัฒนาจิตสวัสดิการสังคมผู้สูงอายุ บ้านบางแค โดยผู้วิจัยจะนำผลที่ได้จากการศึกษาเสนอต่อผู้อำนวยการศูนย์พัฒนาจิตสวัสดิการสังคมผู้สูงอายุ บ้านบางแค ระบุเป็นกิจกรรมในศูนย์พัฒนาจิตสวัสดิการ สังคมผู้สูงอายุ บ้านบางแค และขยายผลต่อสังคมผู้สูงอายุอื่นต่อไป สำหรับกลุ่มควบคุมที่ไม่ได้ออกกำลังกายตามโปรแกรม หากโปรแกรมได้ผลดี ผู้วิจัยจะจัดเวลาให้ความรู้ คำนะนำ ตลอดจนฝึกปฏิบัติให้สามารถเข้าใจและนำไปใช้ได้เกิดประโยชน์ได้จริง

10. การเข้าร่วมในการวิจัยของท่านเป็นโดยสมัครใจ และสามารถปฏิเสธที่จะเข้าร่วมหรือถอนตัวจากการวิจัยได้ทุกขณะ โดยไม่ต้องให้เหตุผลและไม่สูญเสียประโยชน์ที่พึงได้รับ กล่าวคือ ยังคงได้รับการดูแลเอาใจใส่ ขณะพักอาศัยในศูนย์พัฒนาจิตสวัสดิการ สังคมผู้สูงอายุ บ้านบางแค ดังเดิม

4/3
เลขที่โครงการวิจัย 097-1/55
วันที่รับรอง 12 ธ.ค. 2555
วันที่ลงนาม 11 ธ.ค. 2556



11. หากท่านมีข้อสงสัยให้สอบถามเพิ่มเติมได้โดยสามารถติดต่อผู้วิจัยได้ตลอดเวลา และหากผู้วิจัยมีข้อมูลเพิ่มเติมที่เป็นประโยชน์หรือโทษเกี่ยวกับการวิจัย ผู้วิจัยจะแจ้งให้ท่านทราบอย่างรวดเร็ว

12. ข้อมูลที่เกี่ยวข้องกับท่านจะเก็บเป็นความลับ หากมีการเสนอผลการวิจัยจะเสนอเป็นภาพรวม ข้อมูลใดที่สามารถระบุถึงตัวท่านได้จะไม่ปรากฏในรายงาน

13. ภายหลังการเข้าร่วมการออกกำลังกายแต่ละครั้ง ท่านจะได้รับค่าชดเชยการเสียเวลาเป็นเงินจำนวน 50 บาทต่อคนต่อครั้ง ซึ่งมีทั้งหมด 36 ครั้ง รวมทั้งกลุ่มควบคุมซึ่งจะได้รับค่าชดเชยการเข้าร่วมการวิจัยวันเดียวกับกลุ่มที่มีการออกกำลังกาย รวมจำนวนทั้งสิ้น 54 คน ในระหว่างการดำเนินการวิจัย ช่วงการออกกำลังกายท่านจะได้รับอาหารว่างทุกครั้งภายหลังออกกำลังกายเสร็จ

14. หากท่านไม่ได้รับการปฏิบัติตามข้อมูลดังกล่าวสามารถร้องเรียนได้ที่ คณะกรรมการพิจารณาจริยธรรมการวิจัยในคน กลุ่มสหสถาบัน ชุดที่ 1 จุฬาลงกรณ์มหาวิทยาลัย ชั้น 4 อาคารสถาบัน 2 ซอยจุฬาลงกรณ์ 62 ถนนพญาไท เขตปทุมวัน กรุงเทพฯ 10330 โทรศัพท์ 0-2218-8147 หรือ 0-2218-8141 โทรสาร 0-2218-8147 E-mail: eccu@chula.ac.th

เลขที่โครงการวิจัย 047-1/55
วันที่รับของ 12 ธ.ค. 2555
รับหนวดอายุ 11 ธ.ค. 2556



APPENDIX C

Informed consent form

APPENDIX C

Informed consent form

AF 05-07

หนังสือแสดงความยินยอมเข้าร่วมการวิจัย

ทำที่.....

วันที่.....เดือน.....พ.ศ.

เลขที่ ประชากรตัวอย่างหรือผู้มีส่วนร่วมในการวิจัย.....

ข้าพเจ้า ซึ่งได้ลงนามท้ายหนังสือนี้ ขอแสดงความยินยอมเข้าร่วมโครงการวิจัย

ชื่อโครงการวิจัย ผลของโปรแกรมการออกกำลังกายกลางแจ้งแบบสมรรถภาพวิพทูรศต่อการขยาย
หลอดเลือดผ่านการทำงานของเซลล์เยื่อหุ้มหลอดเลือดและสมรรถภาพทาง
กายในผู้สูงอายุที่มีภาวะซึมเศร้า

ชื่อผู้วิจัย นางสุสารี ประคินกิจ

อาจารย์ที่ปรึกษา รองศาสตราจารย์ ดร. ศุภวรรณ สุขุม

อาจารย์ที่ปรึกษาร่วม รองศาสตราจารย์ พญ. ศิริลักษณ์ ทุภักดิ์

สถานที่ติดต่อผู้วิจัย คณะวิทยาศาสตร์การกีฬา จุฬาลงกรณ์มหาวิทยาลัย

โทรศัพท์เคลื่อนที่ 085-821-9229 E-mail: tik.susaree@gmail.com



วันที่โครงการวิจัย 047-1/55
วันที่รับรอง 12 มิ.ย. 2555
วันที่ลงนาม 11 มิ.ย. 2556

ข้าพเจ้า ได้รับทราบรายละเอียดเกี่ยวกับที่มาและวัตถุประสงค์ในการทำวิจัย รายละเอียดขั้นตอน
ต่างๆ ที่จะต้องปฏิบัติหรือได้รับการปฏิบัติ ความเสี่ยง/อันตราย และประโยชน์ซึ่งจะเกิดขึ้นจากการวิจัย
เรื่องนี้ โดยได้อ่านรายละเอียดในเอกสารชี้แจงผู้เข้าร่วมการวิจัย โดยตลอด และได้รับคำอธิบายจากผู้วิจัย
จนเข้าใจเป็นอย่างดีแล้ว

ข้าพเจ้าจึงสมัครใจเข้าร่วมในโครงการวิจัยนี้ ตามที่ระบุไว้ในเอกสารชี้แจงผู้เข้าร่วมการวิจัย โดย
ข้าพเจ้ายินยอมปฏิบัติตามกิจกรรมที่กำหนดในโครงการวิจัย ซึ่งประกอบด้วย การทดสอบสมรรถภาพทาง
กาย การตรวจอุลตราซาวด์หลอดเลือดบริเวณแขน การเจาะเลือดเพื่อวิเคราะห์ระดับไขมันในเลือด
ไนตริกออกไซด์ ไซโตไคน์ คอร์ติซอล 2 ครั้ง ครั้งละ 2 ซ้อนชา ซึ่งจะมีการทำหลายเลือดโดยผู้เชี่ยวชาญ
ด้านเทคนิคการแพทย์เมื่อสิ้นสุดการวิจัย รวมทั้งการออกกำลังกายตามกลุ่ม รวมระยะเวลาในการเข้าร่วม
วิจัยทั้งสิ้น 3 เดือน และข้าพเจ้ามีสิทธิถอนตัวออกจากการวิจัยเมื่อใดก็ได้ตามความประสงค์ โดยไม่ต้อง
แจ้งเหตุผล ซึ่งการถอนตัวออกจากการวิจัยนั้น จะไม่มีผลกระทบในทางใดๆ ต่อข้าพเจ้าทั้งสิ้น

ข้าพเจ้าได้รับคำรับรองว่า ผู้วิจัยจะปฏิบัติต่อข้าพเจ้าตามข้อมูลที่ระบุไว้ในเอกสารชี้แจงผู้เข้าร่วม
การวิจัย และข้อมูลใดๆ ที่เกี่ยวข้องกับข้าพเจ้า ผู้วิจัยจะเก็บรักษาเป็นความลับ โดยจะนำเสนอข้อมูลการ
วิจัยเป็นภาพรวมเท่านั้น ไม่มีข้อมูลใดในการรายงานที่จะนำไปสู่การระบุตัวข้าพเจ้า

หากข้าพเจ้าไม่ได้รับการปฏิบัติตรงตามที่ได้ระบุไว้ในเอกสารชี้แจงผู้เข้าร่วมการวิจัย ข้าพเจ้า
สามารถร้องเรียนได้ที่คณะกรรมการพิจารณาจริยธรรมการวิจัยในคน กลุ่มสหสถาบัน ชุดที่ 1
จุฬาลงกรณ์มหาวิทยาลัย ชั้น 4 อาคารสถาบัน 2 ซอยจุฬาลงกรณ์ 62 ถนนพญาไท เขตปทุมวัน
กรุงเทพฯ 10330 โทรศัพท์ 0-2218-8147 โทรสาร 0-2218-8147 E-mail: eccu@chula.ac.th

APENDIX D

Thai Geriatric Depression Scale

APENDIX D

Thai Geriatric Depression Scale

31

แบบประเมินภาวะซึมเศร้า Thai Geriatric Depression Scale (TGDS)

โปรดอ่านข้อความในแต่ละข้อ และประเมินความรู้สึกของท่านในช่วงเวลาหนึ่งสัปดาห์ที่ผ่านมา
ทำเครื่องหมาย ✓ ลงในช่องที่ตรงกับ "ใช่" ถ้าข้อความนั้น ตรงกับความรู้สึกท่าน
ทำเครื่องหมาย √ ลงในช่องที่ตรงกับ "ไม่ใช่" ถ้าข้อความนั้น ไม่ตรง กับความรู้สึกท่าน

ข้อคำถาม	ใช่	ไม่ใช่	คะแนน
1. ท่านพอใจกับชีวิตความเป็นอยู่ขณะนี้			
2. ท่านไม่ชอบทำในสิ่งที่เคยสนใจหรือเคยทำเป็นประจำ			
3. ท่านรู้สึกชีวิตของท่านช่วงนี้ว่างเปล่าไม่รู้จะทำอะไร			
4. ท่านรู้สึกเบื่อหน่ายบ่อยๆ			
5. ท่านหวังว่าจะมีสิ่งที่ดีเกิดขึ้นในวันหน้า			
6. ท่านมีเรื่องกังวลตลอดเวลา และเลิกคิดไม่ได้			
7. ส่วนใหญ่แล้วท่านรู้สึกอารมณ์ดี			
8. ท่านรู้สึกกลัวว่าจะมีเรื่องไม่ดีเกิดขึ้นกับท่าน			
9. ส่วนใหญ่ท่านรู้สึกมีความสุข			
10. บ่อยครั้งที่ท่านรู้สึก ไม่มีที่พึ่ง			
11. ท่านรู้สึกกระวนกระวาย กระสับการส่ายบ่อยๆ			
12. ท่านชอบอยู่ที่บ้านบางแควมากกว่าที่จะออกไปทำกิจกรรมนอกบ้าน			
13. บ่อยครั้งที่ท่านรู้สึกวิตกกังวลเกี่ยวกับชีวิตข้างหน้า			
14. ท่านคิดว่าความจำท่าน ไม่ดีเท่ากับคนอื่น			
15. การที่มีชีวิตอยู่ถึงปัจจุบันนี้เป็นเรื่องที่น่ายินดีหรือไม่			
16. ท่านรู้สึกหมดกำลังใจหรือเศร้าใจบ่อยๆ			
17. ท่านรู้สึกว่าชีวิตท่านค่อนข้าง ไม่มีคุณค่า			
18. ท่านรู้สึกกังวลมากกับชีวิตที่ผ่านมา			
19. ท่านรู้สึกว่าชีวิตนี้มีเรื่องน่าสนุกอีกมาก			
20. ท่านรู้สึกลำบากที่จะเริ่มต้นทำอะไรใหม่			
21. ท่านรู้สึกกระตือรือร้น			
22. ท่านรู้สึกสิ้นหวัง			



เลขที่โครงการวิจัย 0471/55
 วันที่รับแจ้ง 12 มิ.ย. 2555
 วันที่หมดอายุ 11 มิ.ย. 2556

แบบประเมินภาวะซึมเศร้า Thai Geriatric Depression Scale (TGDS)

โปรดอ่านข้อความในแต่ละข้อ และประเมินความรู้สึกของท่านในช่วงเวลาหนึ่งสัปดาห์ที่ผ่านมา
ทำเครื่องหมาย ✓ ลงในช่องที่ตรงกับ "ใช่" ถ้าข้อความนั้น ตรงกับความรู้สึกท่าน
ทำเครื่องหมาย √ ลงในช่องที่ตรงกับ "ไม่ใช่" ถ้าข้อความนั้น ไม่ตรง กับความรู้สึกท่าน

ข้อคำถาม	ใช่	ไม่ใช่	คะแนน
1. ท่านพอใจกับชีวิตความเป็นอยู่ตอนนี้			
2. ท่านไม่ชอบทำอะไรในสิ่งที่เคยสนใจหรือเคยทำเป็นประจำ			
3. ท่านรู้สึกชีวิตของท่านช่วงนี้ว่างเปล่าไม่รู้จะทำอะไร			
4. ท่านรู้สึกเบื่อหน่ายบ่อยๆ			
5. ท่านหวังว่าจะมีสิ่งที่ดีเกิดขึ้นในวันหน้า			
6. ท่านมีเรื่องกังวลตลอดเวลา และเลิกคิดไม่ได้			
7. ส่วนใหญ่แล้วท่านรู้สึกอารมณ์ดี			
8. ท่านรู้สึกกลัวว่าจะมีเรื่อง ไม่ดีเกิดขึ้นกับท่าน			
9. ส่วนใหญ่ท่านรู้สึกมีความสุข			
10. บ่อยครั้งที่ท่านรู้สึก ไม่มีที่พึ่ง			
11. ท่านรู้สึกกระวนกระวาย กระสับการถ่ายบ่อยๆ			
12. ท่านชอบอยู่กับบ้านบางแค่มากกว่าที่จะออกไปทำกิจกรรมนอกบ้าน			
13. บ่อยครั้งที่ท่านรู้สึกวิตกกังวลเกี่ยวกับชีวิตข้างหน้า			
14. ท่านคิดว่าความจำท่าน ไม่ดีเท่ากับคนอื่น			
15. การที่มีชีวิตอยู่ถึงปัจจุบันนี้เป็นเรื่องที่น่ายินดีหรือไม่			
16. ท่านรู้สึกหมดกำลังใจหรือเศร้าใจบ่อยๆ			
17. ท่านรู้สึกว่าชีวิตท่านค่อนข้าง ไม่มีคุณค่า			
18. ท่านรู้สึกกังวลมากกับชีวิตที่ผ่านมา			
19. ท่านรู้สึกว่าชีวิตนี้มีเรื่องน่าสนุกอีกมาก			
20. ท่านรู้สึกลำบากที่จะเริ่มต้นทำอะไรใหม่			
21. ท่านรู้สึกกระตือรือร้น			
22. ท่านรู้สึกสิ้นหวัง			



ศูนย์โครงการวิจัย 047.1/55
วันที่รับแจ้ง 12 มิ.ย. 2555
วันที่ตรวจ 11 มิ.ย. 2556

ข้อคำถาม	ใช่	ไม่ใช่	คะแนน
23. ท่านคิดว่าคนอื่นดีกว่าท่าน			
24. ท่านอารมณ์เสียบ่อยกับเรื่องเล็กน้อยๆ อยู่เสมอ			
25. ท่านรู้สึกอยากร้องไห้บ่อยๆ			
26. ท่านมีความตั้งใจทำอะไรสักอย่างหนึ่งได้ไม่นาน			
27. ท่านรู้สึกสดชื่นในเวลาตื่นนอนตอนเช้า			
28. ท่านไม่ชอบพบปะพูดคุยกับคนอื่น			
29. ท่านตัดสินใจอะไรได้เร็ว			
30. ท่านมีจิตใจสบายแจ่มใสเหมือนก่อน			
รวม			



047-1/55
 12 มิ.ย. 2555
 11 มิ.ย. 2556

APPENDIX E

Interleukin 6 (IL-6) measurement

Interleukin 6 (IL-6) measurement

Principles of test

An anti-human IL-6 coating antibody is adsorbed onto microwells. Human IL-6 present in the sample or standard binds to antibodies adsorbed to the microwells. Biotin-conjugated anti-human IL-6 antibody is added and binds to human IL-6 captured by the first antibody. Following incubation unbound biotin-conjugated anti-human IL-6 antibody is removed during a wash step. Streptavidin-HRP is added and binds to the biotin-conjugated anti-human IL-6 antibody. Following incubation unbound Streptavidin-HRP is removed during a wash step, and amplification reagent I (Biotinyl-Tyramide) is added to the wells. Following incubation unbound amplification reagent I is removed during a wash step and amplification reagent II (Streptavidin-HRP) is added. Following incubation unbound amplification reagent II is removed during a wash step and substrate solution reactive with HRP is added. A coloured product is formed in proportion to the amount of human IL-6 present in the sample or standard. The reaction is terminated by addition of acid and absorbance is measured at 450 nm.

Reagents provided

1. Aluminium punch with a microwell plate coated with monoclonal antibody to human IL-6
2. 100 µl Biotin-conjugate anti-human IL-6 monoclonal antibody

Make a 1:100 dilution of concentrated biotin conjugate solution with sample diluent in clean plastic tube as needed according to the follow table:

Number of strips	Biotin-conjugate(ml)	Sample diluent(ml)
1-6	0.03	2.97
1-12	0.06	5.94

3. Streptavidin-HRP 150 μ l

Make 1:200 dilution of the concentrated streptavidin-HRP solution with assay buffer(1x) in a clean plastic tube as needed according to the following table

Number of strips	Streptavidin-HRP(ml)	Assay buffer(1x)
1-6	0.03	5.97
1-12	0.06	11.94

4. Human IL-6 standard lyophilized, 200 pg/ml upon reconstitution

The concentrated human IL-6 standard diluted 1:20 with sample diluent just prior to use in clean plastic test tube according to the following dilution scheme: 50 μ l concentrated human IL-6 standard +950 μ l sample diluent (concentration of standard =10 pg/ml)

5. Control lyophilized

Control 1:20 in sample diluent : 50 μ l control +950 μ l sample diluent.

6. Assay buffer concentrate (20x) 5ml (PBS with 1%Tween 20 and 10%BSA)

Assay buffer concentrate(1x) prepared by assay buffer concentrate (20x) 5ml was diluted with distilled water 95 ml.

7. Sample diluent 25 ml.

8. Amplification diluent concentrate(2x)

Preparation of amplification diluent concentrate(1x) by make a 1:2 dilution of the concentrated amplification diluent(2x) as needed according to the following table:

Number of strips	Amplification diluent(2x)(ml)	Distilled water(ml)
1-6	3	3
1-12	6	6

9. Amplification solution I

Make a 1:500 dilution of amplification reagent I in amplification diluent(1x) as needed according to the following table :

Number of strips	Amplification Reagent I (ml)	Amplification Diluent (1x)(ml)
1-6	0.012	5.988
1-12	0.024	11.976

10. Amplification solution II

Make a 1:500 dilution of amplification reagent II in assay buffer (1x) as needed according to the following scheme:

Number of strips	Amplification reagent II(ml)	Assay buffer (1x)(ml)
1-6	0.012	5.988
1-12	0.024	11.976

11. Wash buffer concentrate (1x) (PBS with 1%Tween 20)

Wash buffer concentrate (1x) prepare by wash buffer concentrate (20x) 50 ml was diluted with distilled water 950 ml.

12. Substrate solution 15 ml (tetramethyl-benzidine)

13. Stop solution 15 ml

Procedure

1. Determine the number of microwell strips required
2. Wash microwell strips twice with wash buffer.
3. Standard dilution on the microwell plate: Add 100 µl Sample diluent, in duplicate,

to all standard wells. Pipette 100 μ l prepared standard into the first wells and create standard dilutions by standard into the first wells and create standard dilution by transferring 100 μ l from well to well. Discard 100 μ l from the last wells. Alternatively external standard dilution in tube. Pipette 100 μ l of these standard dilutions in the microwell strips.

4. Add 100 μ l sample diluent in duplicate, to the blank wells.
5. Add 50 μ l sample diluent to sample wells.
6. Add 50 μ l sample in duplicate, to designated sample wells.
7. Prepare biotin-conjugate.
8. Add 50 μ l biotin-conjugate to all wells.
9. Cover microwell strips and incubate 2 hours at room temperature (18° to 25°C).(Shaking is absolutely necessary for an optimal test performance).
10. Prepare streptavidin-HRP.
11. Empty and wash microwell strips 6 times with wash buffer.
12. Add 100 μ l diluted streptavidin-HRP to all wells.
13. Cover microwell strips and incubate 1 hour at room temperature(18° to 25°C).
14. Prepare amplification solution I diluted in amplification diluent(1x)on the plate
15. Empty and wash microwell strip 6 times with wash buffer.
16. Add 100 μ l amplification solution I to all wells.
17. Cover microwell strips and incubate for exactly 15 minutes at room temperature
18. Prepare amplification solution II dilute in assay buffer on plate.
19. Empty and wash microwell strips 6 times with wash buffer.
20. Add 100 μ l amplification solution II to all wells.
21. Cover microwell strips and incubate for exactly 30 minutes at room temperature.
22. Empty and wash microwell strips 6 times with wash buffer.

23. Add 100 μ l of TMB substrate solution to all wells
24. Incubate the microwell strips for about 10-20 minutes at room temperature.
25. Add 100 μ l stop solution to all wells.
26. Blank microwell reader and measure colour intensity at 450 nm

Calculation of results

- Calculate the average absorbance values for each set of duplicate standard and samples. Duplicates should be within 20 percent of mean value.
- Create a standard curve by plotting the mean absorbance for each standard concentration on the ordinate against the human IL-6 concentration on the abscissa.
- To determine the concentration of circulating human IL-6 for each sample, first find the mean absorbance value on the ordinate and extend a horizontal line to the standard curve at the point of intersection, extend a vertical line to the abscissa and read the corresponding human IL-6 concentration.
- Calculation of samples with a concentration exceeding standard 1 may result in incorrect, low human IL-6 levels. Such samples require further external predilution according to expected human IL-6 values with sample diluent in order to precisely quantitate the actual human IL-6 level.

APPENDIX F

Nitric oxide (NO) measurement

APPENDIX F

Nitric oxide (NO) measurement

Principles of test

Nitric oxide (NO) plays an important role in neurotransmission, vascular regulation, immuneresponses and apoptosis. Since most of the NO is oxidized to nitrite (NO₂⁻) and nitrate (NO₃⁻), the concentrations of these anions have been used as a quantitative measure of NO production. PromoKine's Colorimetric Nitric Oxide Assay Kit provides an accurate and convenient measurement of total nitrate/nitrite concentration in a simple two-step process. The first step is to convert nitrate to nitrite utilizing nitrate reductase. The second step involves addition of the Griess Reagents which converts nitrite into a deep purple azo compound. Measurement of the absorbance of the azo chromophore accurately reflects nitric oxide amount in samples. The detection limit of the assay is approximately 0.1 nmole nitrite/well, or 1 μ m.

Reagents provided

1. Enzyme cofactor: Reconstitute with 1.1 ml of Assay Buffer. Aliquot desired amount and store at -20°C. Keep on ice during use. Store at -20°C.
2. Enhancer: Reconstitute with 1.1 ml distilled water. Store at +4°C.
3. Nitrate Reductase: Reconstitute to 1.1 ml with Assay Buffer. This dissolves slowly, so gently vortex 2-3 times over 15 minutes. Keep on ice during use. Store at +4°C.
4. Nitrate and Nitrite Standards: Reconstitute with 100 μ l of Assay Buffer. Vortex and mix well to generate 100 mM standard. Store at +4°C when not in use (do not freeze!). The reconstituted standard is stable for 4 months when stored at +4°C.

5. Griess Reagents R1 and R2: Ready to use. Store at +4°C.

Measurement of Nitrate + Nitrite:

1. Nitrate standard curve: Mix 5 μl of the 100 mM reconstituted standard with 495 μl of Assay Buffer to generate 1 mM standard working solution. Add 0, 2, 4, 6, 8, 10 μl of standard into a series of wells. Adjust volume to 85 μl with Assay Buffer to generate 0, 2, 4, 6, 8, 10 nmol/well of Nitrite or Nitrate Standard. Add 0, 2, 4, 6, 8, 10 μl of standard into a series of wells. Adjust volume to 85 μl with Assay Buffer to generate 0, 2, 4, 6, 8, 10 nmol/well of Nitrite or Nitrate Standard.

Note: The reagents react with nitrite, not nitrate. For routine total nitrite/nitrate assay, you may prepare a nitrate standard curve only. However, if you desire to measure nitrite, nitrate concentration separately, you may prepare a nitrite standard curve in the absence of Nitrate Reductase in the standard and assay samples. Nitrate = Total – Nitrite.

2. Preparation of samples: Up to 85 μl of sample can be added per assay and should be done in duplicate. When using less than 85 μl of sample, adjust volume to 85 μl with Assay Buffer. Include a sample blank for each sample. If the approximate nitrate/nitrite concentration is completely unknown, we recommend that several dilutions are made. Urine can have a high nitrate content and a 10 fold dilution should be used. Serum proteins will have a slight (~10%) effect on apparent nitrite levels. For best results serum filtrate from a 10Kd cutoff filter should be used. Typical urine levels are 0.2-2 mM and 1-20 μM respectively. Typical normal serum levels are ~20 μM and ~2 μM for nitrate and nitrite respectively with various disease states elevating these levels significantly. The absorbance of samples should be in the linear range of the standard curve

(0-10 nmol/well). If they fall outside this range, they should be rediluted and rerun.

Procedure

- 1) To each sample blank (85 μ l adjusted volume) add 115 μ l Assay Buffer as blank well. (Note: sample blanks do not contain any of the following additions).
- 2) Add 5 μ l of the Nitrate Reductase mixture to each well (standards and unknowns).
- 3) Add 5 μ l of the enzyme cofactor to each well (standards and unknowns).
- 4) Cover the plate and incubate at room temperature for 1 hr. to convert nitrate to nitrite.
- 5) Add 5 μ l of the enhancer to each well and incubate 10 minutes (standards and unknowns).
- 6) Add 50 μ l of Griess Reagent R1 to each well (standards and unknowns).
- 7) Add 50 μ l of Griess Reagent R2 to each well (standards and unknowns).
- 8) Develop the color for 10 minutes at room temperature. The color is stable for about an hour.
- 9) Read the absorbance at 540 nm using a plate reader.

Calculation of results

- 1) Plot standard curve: Plot absorbance at 540 nm as a function of nitrate and/or nitrite concentration. It is possible to use plate readers with filters rather far from 540nm (i.e., 570nm). The sensitivity of the assay will be reduced approximately 35% in this case.

2) Determine sample nitrate and nitrite concentrations:

Nitrate/nitrite concentration = (sample [abs.] – blank [abs.] / slope of std curve) /

μl of sample

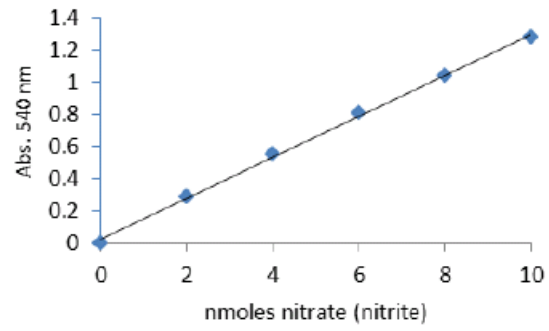

Code plate

Plate 1

	1	2	3	4	5	6	7	8	9	10	11	12
A		1pre	5pre	9pre	13pre	17pre	21pre	2pre3	2pre7	2pre11	2pre15	2pre19
B		1pre	5pre	9pre	13pre	17pre	21pre	2pre3	2pre7	2pre11	2pre15	2pre19
C		2pre	6pre	10pre	14pre	18pre	22pre	2pre4	2pre8	2pre12	2pre16	2pre20
D		2pre	6pre	10pre	14pre	18pre	22pre	2pre4	2pre8	2pre12	2pre16	2pre20
E		3pre	7pre	11pre	15pre	19pre	2pre1	2pre5	2pre9	2pre13	2pre17	2pre21
F		3pre	7pre	11pre	15pre	19pre	2pre1	2pre5	2pre9	2pre13	2pre17	2pre21
G		4pre	8pre	12pre	16pre	20pre	2pre2	2pre6	2pre10	2pre14	2pre18	2pre22
H		4pre	8pre	12pre	16pre	20pre	2pre2	2pre6	2pre10	2pre14	2pre18	2pre22

Plate 2

	1	2	3	4	5	6	7	8	9	10	11	12
A		2pre23	3post	9post	13post	17post	21post	2post3	2post7	2post12	2post16	2post22
B		2pre23	3post	9post	13post	17post	21post	2post3	2post7	2post12	2post16	2post22
C		2pre24	4post	10post	14post	18post	22post	2post4	2post8	2post13	2post17	2post23
D		2pre24	4post	10post	14post	18post	22post	2post4	2post8	2post13	2post17	2post23
E		1post	7post	11post	15post	19post	2post1	2post5	2post9	2post14	2post19	2post24
F		1post	7post	11post	15post	19post	2post1	2post5	2post9	2post14	2post19	2post24
G		2post	8post	12post	16post	20post	2post2	2post6	2post11	2post15	2post21	
H		2post	8post	12post	16post	20post	2post2	2post6	2post11	2post15	2post21	

APPENDIX G

Physical fitness measurement

APPENDIX G

Physical fitness measurement (Jone, C.J. and Rikli, R.E., 2002)

1. Arm curl test



Purpose

To assess upper body strength, needed for performing household and other activities involving lifting and carrying things such as groceries, suitcases and grandchildren.

Description

Number of bicep curls that can be completed in 30 seconds holding a hand weight of 5 lbs (2.27 kg) for women; 8 lbs (3.63 kg) for men.

Risk zone

Less than 11 curls using correct form for men and women.

2. 30-Second Chair Stand

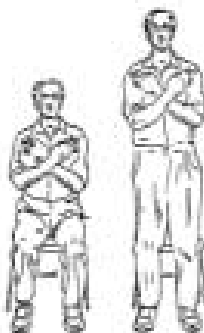

Purpose

To assess lower body strength, needed for numerous tasks such as climbing stairs, walking and getting out of a chair, tub or car. Also reduces the chance of falling.

Description

Number of full stands that can be completed in 30 seconds with arms folded across chest.

Risk zone

Less than 8 unassisted stands for men and women.

3. Back Scratch**Purpose**

To assess upper body (shoulder) flexibility, which is important in tasks such as combing one's hair, putting on overhead garments and reaching for a seat belt.

Description

With one hand reaching over the shoulder and one up the middle of the back, the number of inches (cm) between extended middle fingers (+ or -).

Risk zone

Men: Minus (-) 4 inches or more

Women: Minus (-) 2 inches or more

4. Chair Sit-and-Reach



Purpose

To assess lower body flexibility, which is important for good posture, for normal gait patterns and for various mobility tasks, such as getting in and out of a bathtub or car.

Description

From a sitting position at front of chair, with leg extended and hands reaching toward toes, the number of inches (cm) (+ or -) between extended fingers and tip of toe.

Risk zone

Men: Minus (-) 4 inches or more

Women: Minus (-) 2 inches or more

5. Time up and go test



Purpose

To assess agility/dynamic balance, which is important in tasks that require quick maneuvering, such as getting off a bus in time or getting up to attend to

something in the kitchen, to go to the bathroom or to answer the phone

Description

Number of seconds required to get up from a seated position, walk 8 feet (2.44 m), turn, and return to seated position.

Risk zone

More than 9 seconds.

6. 6-Minute Walk

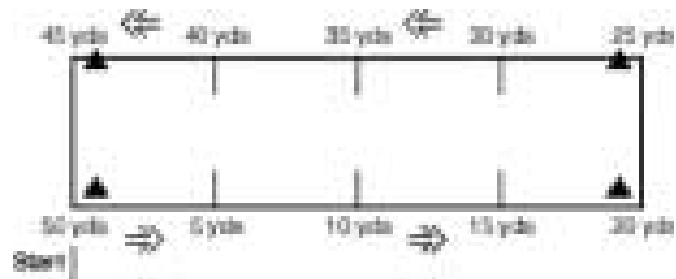

Purpose

To assess aerobic endurance, which is important for walking distances, stair climbing, shopping, sightseeing while on vacation, etc.

Description

Number of yards/meters that can be walked in 6 minutes around a 50-yard (45.7 meter) course. (5 yds = 4.57 meters)

Risk zone

Less than 350 yards for men and women.

BIOGRAPHY

NAME	MRS. Susaree Prakhinkit
DATE OF BIRTHDAY	January, 25, 1975
PLACE OF BIRTH	Phatthalung, Thailand
INSTITUTIONS ATTENDED	Mahidol University, 1992-1996 : Bachelor of nursing Chulalongkorn University, 2000-2003 : Master of art program in developmental psychology, Chulalongkorn University, 2011-2013: Ph.D. candidate (Sports science)
POSITION&OFFICE	1996-2003 Registered Nurse Cardiology Intermediate Cardiac Care Unit, Siriraj Hospital 2004-present Lecturer Faculty of Nursing , Siam University